



OWNER'S MANUAL

# Portable CD Cassette Recorder

Please read this manual carefully before operating  
your set and retain it for future reference.

MODEL  
LPC14 (LPC14)

P/NO : MFL61543970

ENGLISH

## Safety Precaution



**CAUTION:** TO REDUCE THE RISK OF ELECTRIC SHOCK DO NOT REMOVE COVER (OR BACK) NO USER-SERVICEABLE PARTS INSIDE REFER SERVICING TO QUALIFIED SERVICE PERSONNEL.



This lightning flash with arrowhead symbol within an equilateral triangle is intended to alert the user to the presence of uninsulated dangerous voltage within the product's enclosure that may be of sufficient magnitude to constitute a risk of electric shock to persons.



The exclamation point within an equilateral triangle is intended to alert the user to the presence of important operating and maintenance (servicing) instructions in the literature accompanying the product.

**WARNING:** TO PREVENT FIRE OR ELECTRIC SHOCK HAZARD, DO NOT EXPOSE THIS PRODUCT TO RAIN OR MOISTURE.

**WARNING:** Do not install this equipment in a confined space such as a book case or similar unit.

**CAUTION:** Do not block any ventilation openings. Install in accordance with the manufacturer's instructions.

Slots and openings in the cabinet are provided for ventilation and to ensure reliable operation of the product and to protect it from over heating. The openings be never be blocked by placing the product on a bed, sofa, rug or other similar surface. This product not be placed in a built-in installation such as a bookcase or rack unless proper ventilation is provided or the manufacturer's instruction has been adhered to.

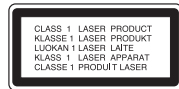

**CAUTION:** This product employs a Laser System.

To ensure proper use of this product, please read this owner's manual carefully and retain it for future reference. Shall the unit require maintenance, contact an authorized service center. Use of controls, adjustments or the performance of procedures other than those specified herein may result in hazardous radiation exposure.

To prevent direct exposure to laser beam, do not try to open the enclosure. Visible laser radiation when open. **DO NOT STARE INTO BEAM.**

**CAUTION:** The apparatus shall not be exposed to water (dripping or splashing) and no objects filled with liquids, such as vases, shall be placed on the apparatus.

### **CAUTION concerning the Power Cord**

**Most appliances recommend they be placed upon a dedicated circuit;**

That is, a single outlet circuit which powers only that appliance and has no additional outlets or branch circuits. Check the specification page of this owner's manual to be certain.

Do not overload wall outlets. Overloaded wall outlets, loose or damaged wall outlets, extension cords, frayed power cords, or damaged or cracked wire insulation are dangerous. Any of these conditions could result in electric shock or fire.

Periodically examine the cord of your appliance, and if its appearance indicates damage or deterioration, unplug it, discontinue use of the appliance, and have the cord replaced with an exact replacement part by an authorized service.

Protect the power cord from physical or mechanical abuse, such as being twisted, kinked, pinched, closed in a door, or walked upon. Pay particular attention to plugs, wall outlets, and the point where the cord exits the appliance.

To disconnect power from the mains, pull out the mains cord plug. When installing the product, ensure that the plug is easily accessible.

The marking of the apparatus Refer to the bottom panel of the unit.

This device is equipped with a portable battery or accumulator.

### **Safe way to remove the battery or the battery from the equipment:**

Remove the old battery or battery pack, follow the steps in reverse order than the assembly. To prevent contamination of the environment and bring on possible threat to human and animal health, the old battery or the battery put it in the appropriate container at designated collection points. Do not dispose of batteries or battery together with other waste. It is recommended that you use local, free reimbursement systems batteries and accumulators.

The battery shall not be exposed to excessive heat such as sunshine, fire or the like.



### **Disposal of your old appliance**

1. When this crossed-out wheeled bin symbol is attached to a product it means the product is covered by the European Directive 2002/96/EC.
2. All electrical and electronic products should be disposed of separately from the municipal waste stream via designated collection facilities appointed by the government or the local authorities.
3. The correct disposal of your old appliance will help prevent potential negative consequences for the environment and human health.
4. For more detailed information about disposal of your old appliance, please contact your city office, waste disposal service or the shop where you purchased the product.

## Power Source

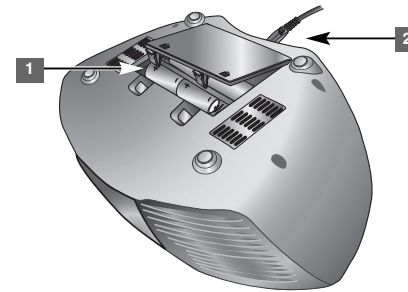

### 1 Battery Installation

1. Press and open the battery cover.
2. Put six "C" (R14) batteries (not supplied) into the compartment making sure the ⊕ and ⊖ should be correctly positioned.
3. Replace the battery cover.

### 2 AC Power Cord Connection

1. Connect one end of the AC power cord (included) to the AC IN socket located at the backside of your unit.
2. Plug the other end into the wall outlet.

**Note:**

- Unplug the AC power cord from the wall outlet if you do not use for an extended period of time.
- To avoid damage from possible battery leakage, remove the batteries if you do not plan to use the unit for an extended period of time.
- When the batteries are weak, replace all the batteries with new ones.
- While the AC power cord connect to the wall outlet, the batteries are not worn out.
- Batteries (battery pack or batteries installed) shall not be exposed to excessive heat such as sunshine, fire or the like.

## CONTENTS

	PAGE
Power Source	3
Main Unit	4
Listening to the Radio	4
Listening to CDs	5
Using a USB device	6
Listening to music from your portable player	6
Listening to cassette tapes	7
Recording to TAPE	7
Troubleshooting	8
Specifications	8

## Main Unit

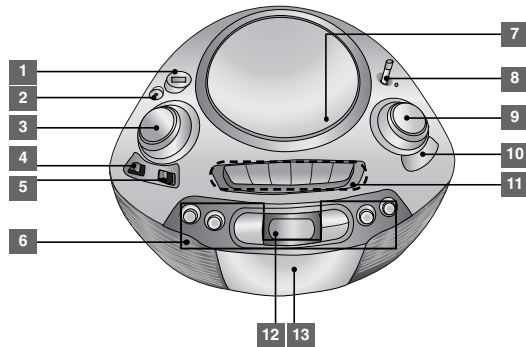

- 1** **USB** connector
- 2** **PORT.IN** connector
- 3** **VOLUME** Control
- 4** **FM AM BAND** switch  
You can choose AM or FM
- 5** **FUNCTION** switch  
[CD - USB, TUNER, PORT. IN, TAPE]
- 6** **CD-USB FUNCTION** buttons
  - + 10
  - ■ STOP
  - ►|| PLAY/PAUSE
  - ◀◀ BACKWARD SKIP/ SEARCH
  - ▶▶ FORWARD SKIP/ SEARCH
  - **PROG.**
  - **REPEAT**

- 7** ▲ **PUSH OPEN**  
You can use it when inserting or removing CDs.
- 8** ANTENNA
- 9** **TUNING DIAL**
- 10** FREQUENCY indicator
- 11** TAPE FUNCTION buttons
  - || Pausing
  - ■/▲ Stop/ Eject
  - ◀◀/▶▶ Searching
  - ◀ Playing
  - ● Recording
- 12** DISPLAY WINDOW
- 13** TAPE DOOR

## Listening to the Radio

	ON UNIT
1. Select the radio function	<b>FUNCTION</b> switch
2. Select either FM or AM	<b>(FM or AM) BAND</b> switch
3. Select the radio station	<b>TUNING</b> dial

## Listening to the radio - More you can do

### To turn off the radio

Set **FUNCTION** switch to TAPE or CD - USB (OFF), PORT. IN to turn off your unit.

## Listening to CDs

Audio CD and MP3/ WMA CD can be played back in this unit.

	ON UNIT
1. Select the CD function	FUNCTION switch
2. Open the CD door	▲ PUSH OPEN
3. Insert the CD : Label facing up.	-
4. Close the CD door	-
5. Start the CD playing	▶
6. Stop a CD playing	■

## Listening to CDs - More you can do

### Pausing or restarting a CD

- 1 Press ▶ || on the unit during playback.
- 2 Press this button again to resume play.

### Searching for a section within a track

Press and Hold ◀◀/▶▶ during playback and release it at the point you want to listen to. (This function is only available for Audio CD's.)

### Skipping to another track (file)

- Press ▶▶1 to go to the next track (file).
- When the ◀◀ is pressed once midway through a track (file), the player returns to the beginning of that track (file). When it is pressed again, a track is skipped each time the button is pressed.
- When you press +10, next 10 tracks (files) are skipped in a jump and the next 10 th track (file) is played back.

### Listening to your tracks (files) repeatedly or randomly

- 1 Press REPEAT repeatedly.  
Tracks will be played back repeatedly or randomly.
- 2 To return to normal playback, press REPEAT repeatedly to select.

### Note:

Depending on the conditions of the recording equipment or the CD-R/RW disc itself, some MULTI SESSION, Mixed disc cannot be played on the unit.

### Creating your own playlist

You can play up to 40 tracks on a CD in order.

- 1 Insert a CD and wait for it to be read.
- 2 Press PROG. in stop status.
- 3 Press ◀◀/▶▶1 to select a track.
- 4 Press PROG. again to save and select a next track.  
Repeat the step 3 - 4.
- 5 Press ▶|| to play the programmed music files.
- 6 To clear your selection, press ■ twice.

### About MP3/ WMA

**MP3/ WMA Disc compatibility with this unit is limited as follows:**

- Sampling Frequency : 32 to 48 kHz (MP3), 32 to 48 kHz (WMA)
- Bit rate: 32 to 320 kbps (MP3), 40 to 320 kbps (WMA)
- CD-R physical format should be "ISO 9660/ JOLIET"
- If you record MP3/WMA files using the software which cannot create a FILE SYSTEM, for example "Direct-CD" etc., it is impossible to playback MP3 files.  
We recommend that you use "Easy-CD Creator", which creates an ISO 9660 file system.
- Do not use special letters such as "/ : \* ? " < >" etc.
- On CD or USB, 99 folders and 999 track, function are support

### Using a USB device

You can enjoy media files saved on a USB device by connecting the USB device to the USB port of the unit. If you want to operate other function, see the "Listening to CDs" section.

	ON UNIT
1. Connect the USB device to the USB port of the unit.	-
2. Select the CD -USB function.	FUNCTION switch
3. Select a file you want to play.	◀◀ / ▶▶
4. Start your media playing.	▶▶
5. Stop a media playing	■
6. Before disconnecting the portable USB device, change to any other function.	FUNCTION switch

#### Compatible USB Devices

- MP3 Player : Flash type MP3 player.
- USB Flash Drive : Devices that support USB 2.0 or USB 1.1.
- The USB function may not be available depending on devices.
- Devices which require additional program installation when you have connected it to a computer, are not supported.

#### Look out for the following

- Do not extract the USB device while in operation.
- For a large capacity USB, it may take longer than a few minute to be searched.
- To prevent data loss, back up all data.
- If you use a USB extension cable or USB hub, the USB device is not recognized.
- Using NTFS file system is not supported. (Only FAT(16/32) file system is supported.)
- This unit is not supported when the total number of files is 1000 or more.
- External HDD, Locked devices or hard type USB devices are not supported.
- USB port of the unit can not be connected to PC. This unit can not be used as a storage device.

### Listening to music from your portable player

The unit can be used to play the music from many types of portable player.

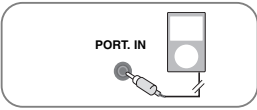
	ON UNIT
1. Connect the portable player to the <b>PORT. IN</b> connector of the unit.	-
	
2. Turn the power on.	FUNCTION switch
3. Select the <b>PORTABLE</b> function.	FUNCTION switch
4. Turn on the portable player and start it playing.	-

### Listening to cassette tapes

	ON UNIT
<b>1. Select the TAPE function</b>	FUNCTION switch
<b>2. Open the tape door</b>	■/▲
<b>3. Insert the tape</b>	-
<b>4. Close the tape door</b>	-
<b>5. Start the tape playing</b>	◀
<b>6. Stop a tape playing</b> Cassette deck will automatically stop at the end of the tape	■/▲

### Listening to the cassette tapes - More you can do

#### Playing Fast backward or Forward

Press ◀◀/▶▶ on the unit during playback, or stop, press ◀ (or ■ / ▲) at a point you want.

#### Pausing or restart a tape

Press || on the unit during playback. Press this button again to resume play.

### Recording to TAPE

You can record a various sound sources to TAPE.

	ON UNIT
<b>1. Open the tape door</b>	■/▲
<b>2. Insert a blank tape</b>	-
<b>3. Close the tape door</b>	-
<b>4. Select a mode in which you want to record</b>	FUNCTION switch
<b>5. Start the Recording</b>	◀ ●
<b>6. Stop a Recording</b>	■/▲

### Synchronized Recording from CD to Tape

	ON UNIT
<b>1. Open the tape door.</b>	■/▲
<b>2. Insert a blank tape and close the door.</b>	-
<b>3. Select the CD function (Audio CD only)</b>	FUNCTION switch
<b>4. Start the Recording:</b> The synchronized recording is started automatically after about 7 seconds.	◀ ●
<b>5. To stop recording, press</b>	■/▲

**Note:**

On recording, press || to pause.

## Troubleshooting

Symptom	Cause	Correction
<b>POWER</b>		
No power	The power cord is not plugged in.	Plug in the power cord.
	The batteries are not remaining.	Change the batteries with a new one.
<b>RADIO</b>		
No sound	The function switch is not set to the Radio mode.	Set the switch to the Radio mode.
Some noise occurs.	There are electronic devices near the player.	Set the player far from the devices.
<b>CD</b>		
The unit does not start playback	An unplayable disc is inserted.	Insert a playable disc.
	The disc is placed upside down.	Place the disc with the playback side down.
	The disc is not placed within the guide.	Place the disc on the disc tray correctly inside the guide.
	The disc is dirty.	Clean the disc.
<b>TAPE</b>		
Unable to record	Record protect tabs are removed.	Cover holes on back edge of tape with tap.

## Specifications

### General

Power supply	Refer to the main label
Power consumption	Refer to the main label
Net Weight	2.1 kg
External dimensions (W x H x D)	(333 x 178 x 259) mm
Operating temperature	5 °C to 35 °C
Operating humidity	5 % to 85 %

### Tuner

FM Tuning Range	88 to 108 MHz or 65 to 108 MHz
AM Tuning Range	520 to 1610 kHz or 520 to 1710 kHz

### CD

Frequency response	100 Hz to 18 kHz
Signal-to-noise ratio	55 dB
Dynamic range	55 dB

### Amplifier

Output Power	0.5 W x 2 ch
T.H.D	10 %
Frequency Response	120 Hz to 18 kHz
Signal-to-noise ratio	50 dB

### Speakers

Type	2 Way 2 Speaker
Impedance	8 Ω
Rated Input Power	0.5 W
Max. Input Power	1.0 W

### USB

Version	1.1
Bus Power supply	DC 5 V $\pm$ 500 mA

Notice (the date of the production of goods).  
 First figure ( of the left ) of series number means Year,  
 next 2 figures - Month of the production of this goods.

Designs and specifications are subject to change without notice.



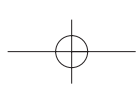
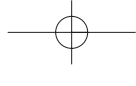

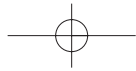
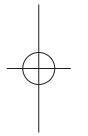
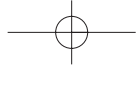

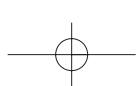
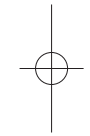
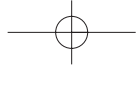



Импортер LG Electronics RUS  
Адрес импортера 143160 Российская Федерация, Московская область,  
Рузский район, сельское поселение Дороховское, 86 км. Минского шоссе, д.9  
Адрес производителя : Юсан Технолджи (Шэньчжэнь) Лтд.  
Гуандун, Китайская Народная республика, Хаои  
Технолджи парк, Нан Хуан Род, Шаяинг Вест, Баоан

	Телефон	Режим работы	Интернет
<b>Россия</b>	8-800-200-7676	Круглосуточно	<a href="http://www.lg.com">http://www.lg.com</a>
<b>Беларусь</b>	8-820-0071-1111		
<b>Латвия</b>	8-0003-271		
<b>Литва</b>	8-800-30-800		
<b>Эстония</b>	800-9990		
<b>Украина</b>	0-800-303-000	8:00 - 21:00 (Пн.-Пят.) 9:00 - 18:00 (Суб., Вс.)	
<b>Казахстан</b>	8-8000-805-805 2255 (для мобильных телефонов)	9:00 - 18:00 (Пн.-Пят.) 9:00 - 18:00 (Суб.)	
<b>Кыргызстан</b>	8-0000-710-005	Круглосуточно	
<b>Узбекистан</b>			



Сделано в Китае