



LG

Life's Good

OWNER'S MANUAL LCD TV

Please read this manual carefully before operating your set and retain it for future reference.



HDMI, the HDMI logo and High-Definition Multimedia Interface are trademarks or registered trademarks of HDMI Licensing LLC.

ACCESSORIES

Ensure that the following accessories are included with your TV.

If an accessory is missing, please contact the dealer where you purchased the TV.

- Here shown may be somewhat different from your TV.

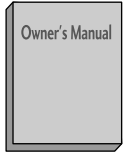

Owner's Manual

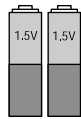

Batteries

This item is not included for all models.



Polishing Cloth
Polishing cloth for use on the screen.

* Lightly wipe any stains or fingerprints on the surface of the TV with the polishing cloth.

Do not use excessive force. This may cause scratching or discolouration.



Power Cord



Remote Control

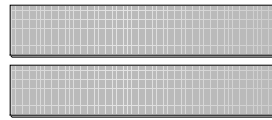

Dual Lock™
(This item is not included for all models.)
(Refer to P.7)

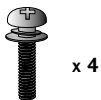

x 4

Bolts for stand assembly
(Refer to p.6)

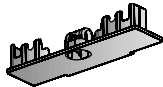

Protection cover
(Refer to p.7)



1-screw for stand fixing
(Refer to p.6)

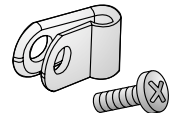

Protective Bracket and Bolt for Power Cord
(Refer to p.6)

Wall Mounting Bracket (Separate purchase)

RW230

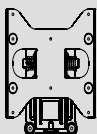

(26/32LH2***)

AW-47LG30M

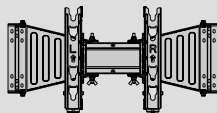

(32/37/42LH2***)

CONTENTS

ACCESSORIES 1

PREPARATION

Front Panel Controls.....	4
Back Panel Information	5
Stand Installation.....	6
Not Using the desk-type stand.....	6
Attaching the TV to a desk.....	6
How to secure the power cable.....	6
Back Cover for Wire Arrangement	7
Swivel Stand	7
How to use Dual Lock™.....	7
Careful Installation Advice.....	8
Desktop Pedestal Installation	8
Wall Mount: Horizontal Installation	9
Kensington Security System	9
Antenna Connection.....	10

EXTERNAL EQUIPMENT SETUP

HD Receiver Setup	11
DVD Setup.....	14
VCR Setup.....	16
Other A/V Source Setup.....	18
USB In Setup	19
Speaker Output Setup.....	19
PC Setup.....	20
- Screen Setup for PC Mode	22

WATCHING TV / PROGRAMME CONTROL

Remote Control Key Functions	26
Turning on the TV.....	28
Programme Selection	28
Volume Adjustment	28
Quick Menu	29
On-Screen Menus Selection and Adjustment.....	30
Auto Programme Tuning.....	31
Manual Programme Tuning	32
Programme Edit	34

Selecting the Programme List.....	36
Favourite Programme Setup.....	37
Input List.....	38
Input Label.....	39
	40
Key Lock.....	43
Initializing(Reset to original factory settings)	44
AV Mode.....	45

TO USB A USB DEVICE

When connecting the USB device.....	46
Photo List	48
Music List.....	52
Movie List	55
Divx Registration Code.....	58
Deactivation.....	59

PICTURE CONTROL

Picture Size (Aspect Ratio) Control	60
Energy Saving	62
Preset Picture Settings	
- Picture Mode-Preset.....	63
Manual Picture Adjustment	
- Picture Mode-User option.....	64
Picture Improvement Technology.....	65
Expert Picture Control	66
Picture Reset.....	69
Power Indicator	69
Demo Mode.....	70

SOUND & LANGUAGE CONTROL

Auto Volume Leveler.....	71
Preset Sound Settings - Sound Mode.....	72
Sound Setting Adjustment - User Mode.....	73
Clear Voice II.....	74
Balance.....	75
Audio Reset.....	76

I/II	
- Stereo/Dual Reception	77
- NICAM Reception	78
- Speaker Sound Output Selection	78
On-Screen Menu Language Selection	79

TIME SETTING

Clock Setup	80
Auto On/ Off Timer Setting	81
Sleep Timer Setting	82

TELETEXT

Switch on/off	83
SIMPLE Text	83
TOP Text	83
FASTEXT	84
Special Teletext Functions	84

APPENDIX

Troubleshooting	85
Maintenance	87
Product Specifications	88
IR Codes	89
External Control Device Setup	90

PREPARATION

FRONT PANEL CONTROLS

This is a simplified representation of the front panel.

- Here shown may be somewhat different from your TV.

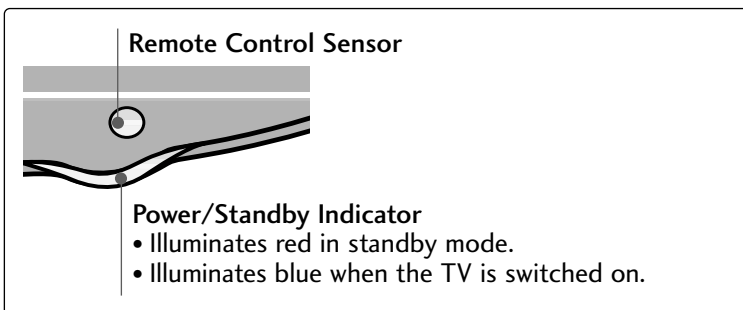
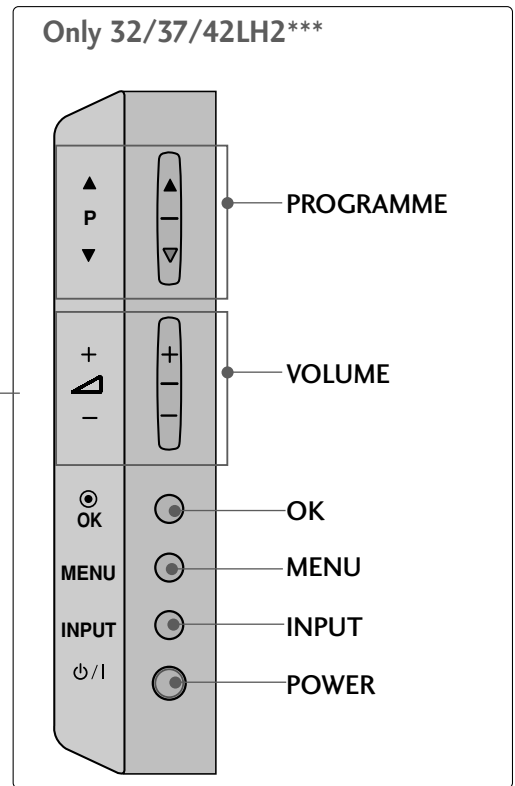
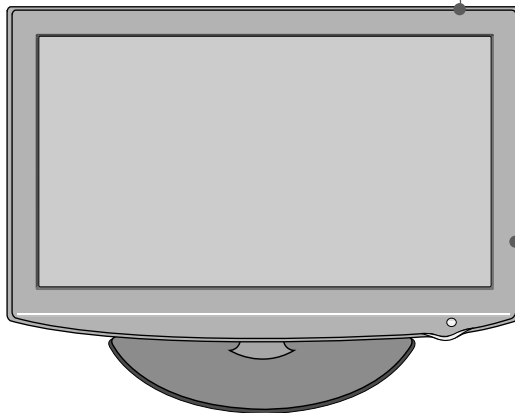
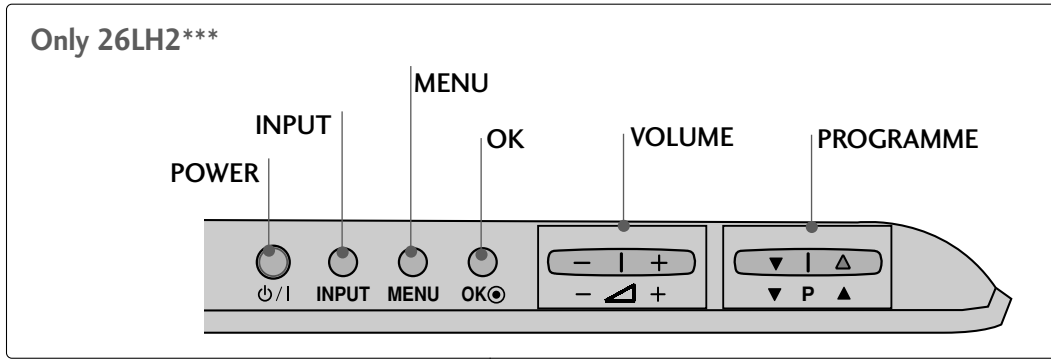

BACK PANEL INFORMATION

■ Here shown may be somewhat different from your TV.

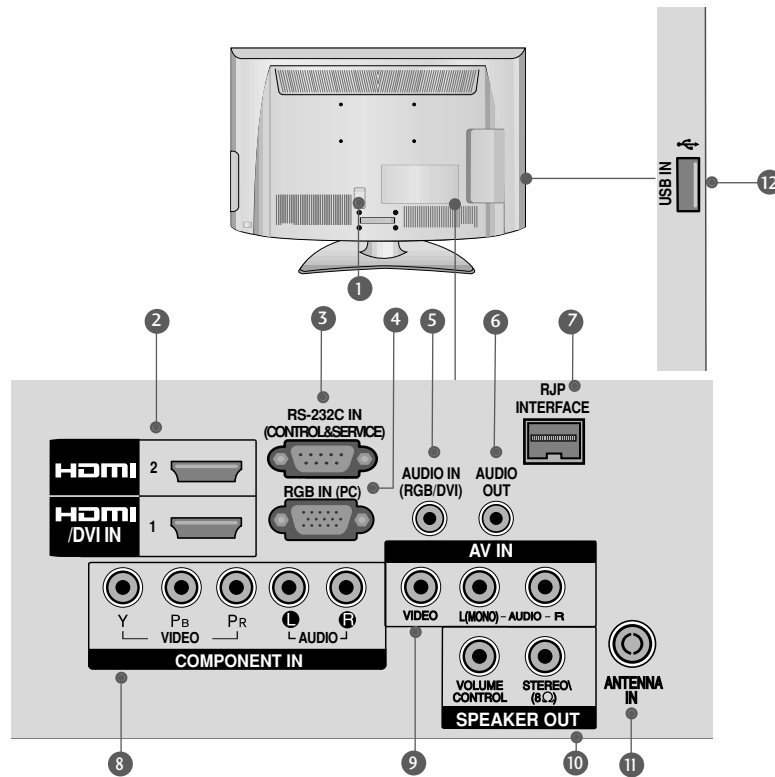

1 Power Cord Socket

This TV operates on an AC power. The voltage is indicated on the Specifications page. Never attempt to operate the TV on DC power.

2 HDMI Input

Connect a HDMI signal to HDMI IN. Or DVI(VIDEO)signal to HDMI/DVI port with DVI to HDMI cable.

3 RS-232C IN PORT

Connect to the RS-232C port on a PC. This port is used for Service or Hotel mode.

4 RGB Input

Connect the output from a PC.

5 RGB/DVI Audio Input

Connect the audio from a PC.

6 Audio Output

Connect to the Home Theater.(or amp)

7 RJP INTERFACE

Connect control line (RJ45) for RJP(Remote Jack pack)

8 Component Input

Connect a component video/audio device to these jacks.

9 Audio/Video Input

Connect audio/video output from an external device to these jacks.

10 SPEAKER OUTPUT(STEREO)

The phone socket for external speaker is on this jack

11 Antenna Input

Connect RF antenna to this jack.

12 USB IN Input

Connect USB storage device to this jack.

PREPARATION

STAND INSTALLATION

■ Here shown may be somewhat different from your TV. When assembling the desk type stand, check whether the bolt is fully tightened. (If not tightened fully, the product can tilt forward after the product installation.) If you tighten the bolt with excessive force, the bolt can deviate from abrasion of the tightening part of the bolt.

- 1 Carefully place the TV screen side down on a cushioned surface to protect the screen from damage.

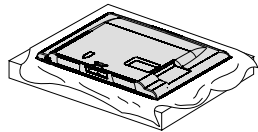

- 2 Assemble the TV as shown.

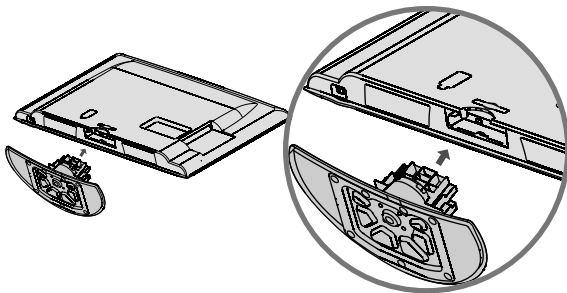

- 3 Fix the 4 bolts securely using the holes in the back of the TV.

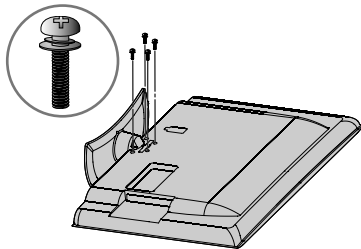

NOT USING THE DESK-TYPE STAND

■ Here shown may be somewhat different from your TV. When installing the wall-mounted unit, use the protection cover.

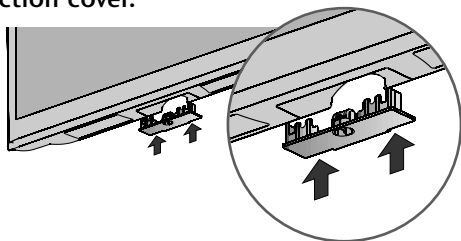

Insert the **PROTECTION COVER** into the TV until clicking sound.

ATTACHING THE TV TO A DESK

■ Here shown may be somewhat different from your TV. The TV must be attached to desk so it cannot be pulled in a forward/backward direction, potentially causing injury or damaging the product. Use only an attached screw.

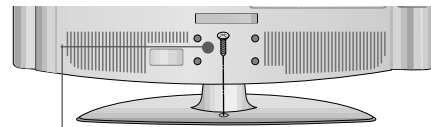

1-Screw (provided as parts of the product)

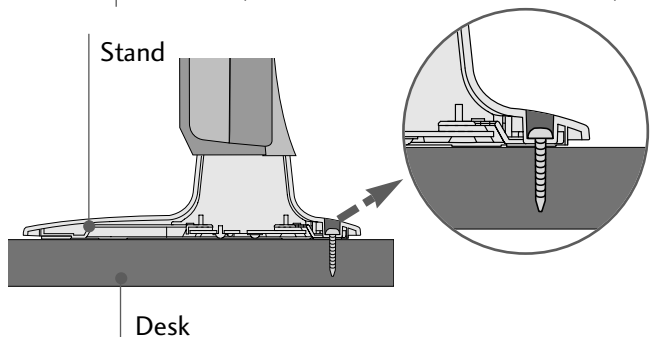

! WARNING

► To prevent TV from falling over, the TV should be securely attached to the floor/wall per installation instructions. Tipping, shaking, or rocking the machine may cause injury.

HOW TO SECURE THE POWER CABLE

Secure the power cable with the **PROTECTIVE BRACKET** and the bolt as shown. It will help prevent the power cable from being removed by accident.

Bolt

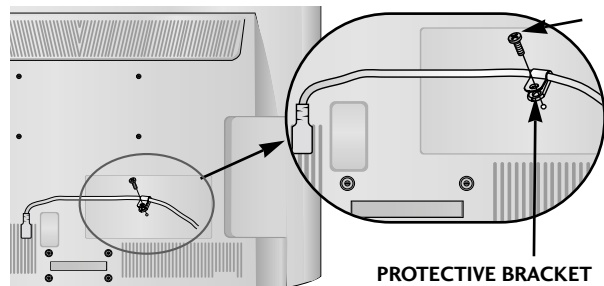

PROTECTIVE BRACKET

BACK COVER FOR WIRE ARRANGEMENT

▪ Here shown may be somewhat different from your TV.

- 1 Connect the cables as necessary. To connect additional equipment, see the **External Equipment Setup** section of the manual.

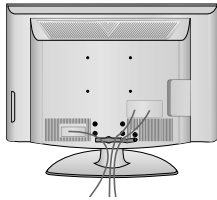

- 2 Open the **CABLE MANAGEMENT CLIP** as shown and manage the cables.

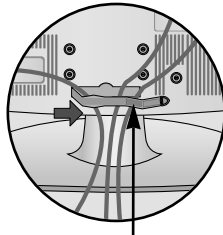
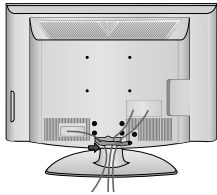

CABLE MANAGEMENT CLIP

- 3 Fit the **CABLE MANAGEMENT CLIP** as shown.

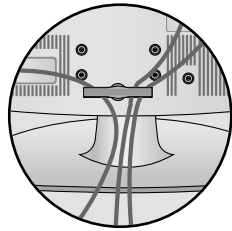
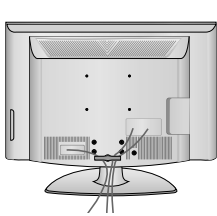

! NOTE

- ▶ Do not hold the **CABLE MANAGEMENT CLIP** when moving the TV.
- If the TV is dropped, you may be injured or the TV may be damaged.

SWIVEL STAND

- This feature is not available for all models.
- After installing the TV, you can adjust the TV manually to the left or right direction by 20 degrees to suit your viewing position.

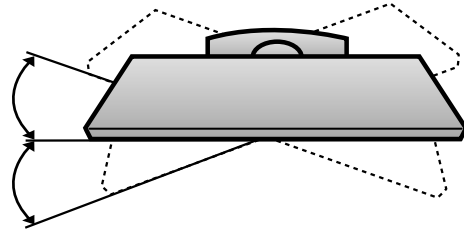

HOW TO USE DUAL LOCK™ (This feature is not available for all models.)

Fix the set-top box to the TV and use it when you want to.

- 1 After removing the protection paper from the Dual Lock, stick it to the TV and the set-top box as shown.

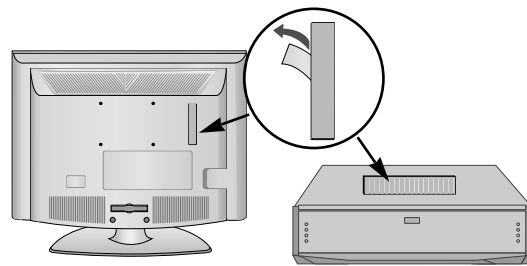

- 2 Attach the set-top box to the TV by pressing the Velcro strips together.

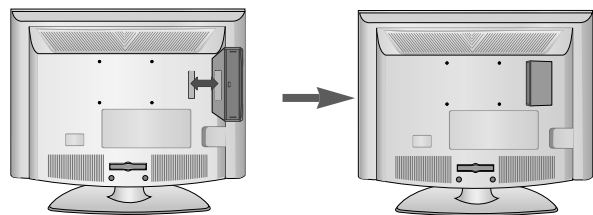

PREPARATION

CAREFUL INSTALLATION ADVICE

- You should purchase necessary components to fix the TV safely and secure to the wall on the market.
- Position the TV close to the wall to avoid the possibility of it falling forwards when pushed.
- The instructions shown below are a safer way to set up the TV, by fixing it to the wall, avoiding the possibility of it falling forwards if pulled. This will prevent the TV from falling forward and causing injury. This will also prevent the TV from damage. Ensure that children do not climb or hang from the TV.

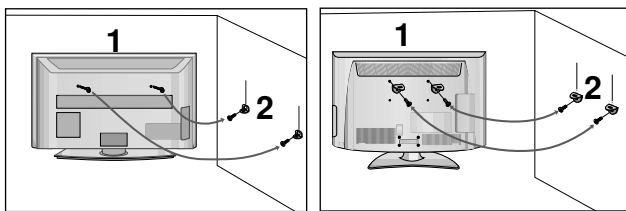

- 1 Use the eye-bolts or TV brackets/bolts to fix the product to the wall as shown in the picture. (If your TV has bolts in the eyebolts, loosen them bolts.)
* Insert the eye-bolts or TV brackets/bolts and tighten them securely in the upper holes.

- 2 Secure the wall brackets with the bolts on the wall. Match the height of the bracket that is mounted on the wall.

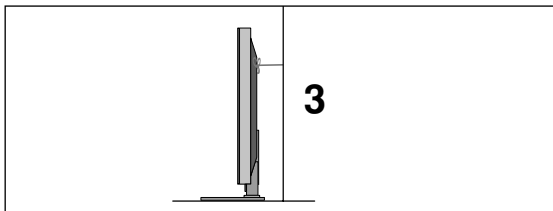

- 3 Use a sturdy rope to tie the product for alignment. It is safer to tie the rope so it becomes horizontal between the wall and the product.

! NOTE

- ▶ When moving the TV undo the cords first.
- ▶ Use a platform or cabinet strong and large enough to support the size and weight of the TV.
- ▶ To use the TV safely make sure that the height of the bracket on the wall and on the TV is the same.

- The TV can be installed in various ways such as on a wall, or on a desktop etc.
- The TV is designed to be mounted horizontally.

EARTHING

Ensure that you connect the earth wire to prevent possible electric shock. If grounding methods are not possible, have a qualified electrician install a separate circuit breaker.

Do not try to earth the TV by connecting it to telephone wires, lightning rods or gas pipes.

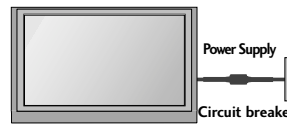

DESKTOP PEDESTAL INSTALLATION

For adequate ventilation allow a clearance of 10cm all around the TV.

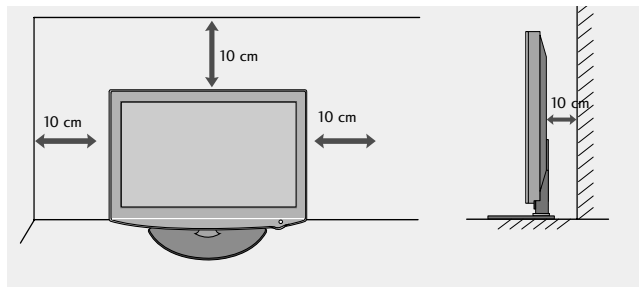

WALL MOUNT: HORIZONTAL INSTALLATION

- We recommend the use of a LG Brand wall mounting bracket when mounting the TV to a wall.
- We recommend that you purchase a wall mounting bracket which supports VESA standard.
- LG recommends that wall mounting be performed by a qualified professional installer.

! NOTE

- ▶ Should Install wall mount on a solid wall perpendicular to the floor.
- ▶ Should use a special wall mount, if you want to install it to ceiling or slanted wall.
- ▶ The surface that wall mount is to be mounted on should be of sufficient strength to support the weight of TV set; e.g. concrete, natural rock, brick and hollow block.
- ▶ Installing screw type and length depends on the wall mount used. Further information, refer to the instructions included with the mount.
- ▶ LG is not liable for any accidents or damage to property or TV due to incorrect installation:
 - Where a non-compliant VESA wall mount is used.
 - Incorrect fastening of screws to surface which may cause TV to fall and cause personal injury.
 - Not following the recommended Installation method.

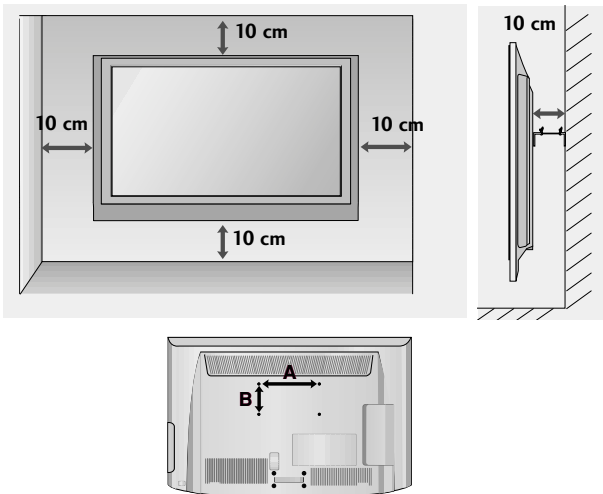

Model	VESA (A * B)	Standard Screw	Quantity
42LH2***	200 * 200	M6	4
37LH2***	200 * 200	M6	4
32LH2***	200 * 100	M4	4
26LH2***	200 * 100	M4	4

KENSINGTON SECURITY SYSTEM

- This feature is not available for all models.
- Here shown may be somewhat different from your TV.

The TV is equipped with a Kensington Security System connector on the back panel. Connect the Kensington Security System cable as shown below.

For the detailed installation and use of the Kensington Security System, refer to the user's guide provided with the Kensington Security System.

For further information, contact <http://www.kensington.com>, the internet homepage of the Kensington company. Kensington sells security systems for expensive electronic equipment such as notebook PCs and LCD projectors.

NOTE

- The Kensington Security System is an optional accessory.

NOTES

- a. If the TV feels cold to the touch, there may be a small "flicker" when when it is turned on. This is normal, there is nothing wrong with TV.
- b. Some minute dot defects may be visible on the screen, appearing as tiny red, green, or blue spots. However, they have no adverse effect on the monitor's performance.
- c. Avoid touching the LCD screen or holding your finger(s) against it for long periods of time. Doing so may produce some temporary distortion effects on the screen.

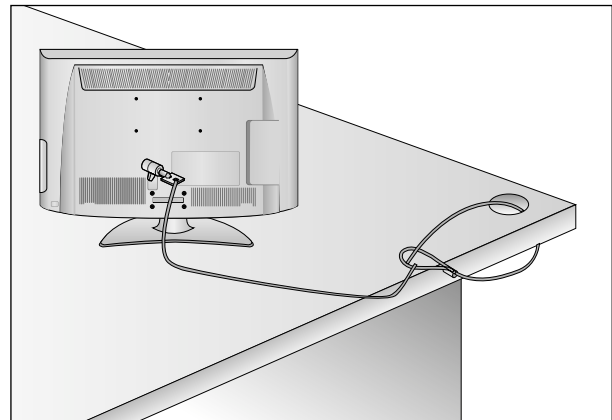

PREPARATION

- To prevent damage do not connect to the mains outlet until all connections are made between the devices.

ANTENNA CONNECTION

- For optimum picture quality, adjust antenna direction.
- An antenna cable and converter are not supplied.

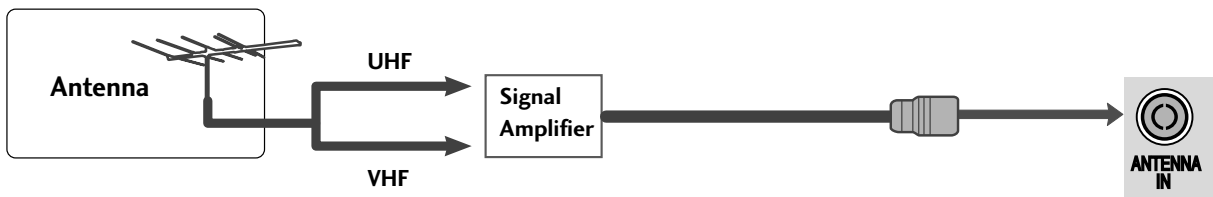
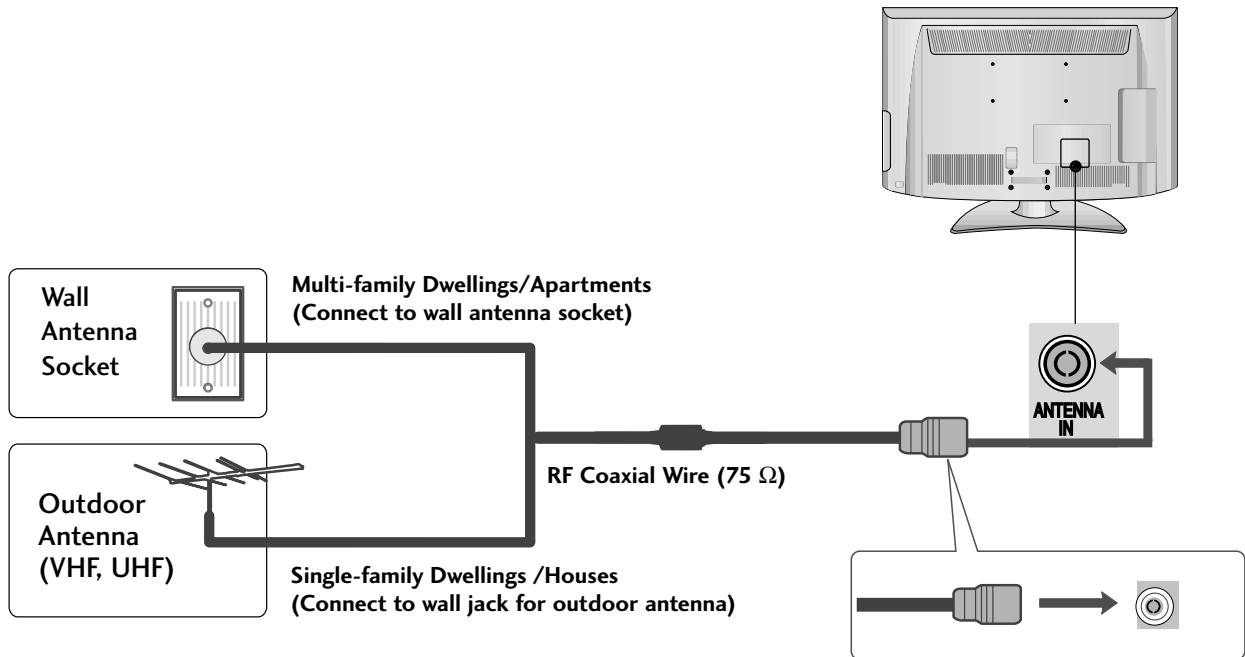

- In poor signal areas, to achieve better picture quality it may be necessary to install a signal amplifier to the antenna as shown above.
- If signal needs to be split for two TVs, use an antenna signal splitter for connection.

EXTERNAL EQUIPMENT SETUP

- To avoid damaging any equipment, never plug in any power cords until you have finished connecting all equipment.
- Here shown may be somewhat different from your TV.

HD RECEIVER SETUP

Connecting with a component cable

- 1 Connect the video outputs (Y, PB, PR) of the digital set top box to the **COMPONENT IN VIDEO** jacks on the TV.
- 2 Connect the audio output of the digital set-top box to the **COMPONENT IN AUDIO** jacks on the TV.
- 3 Turn on the digital set-top box.
(Refer to the owner's manual for the digital set-top box.)
- 4 Select **Component** input source using the **INPUT** button on the remote control.

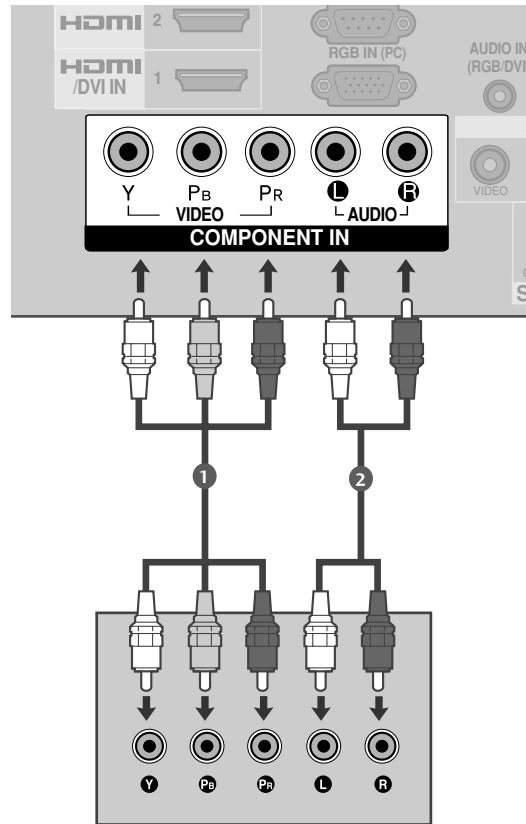

Signal	Component	HDMI
480i/576i	○	X
480p/576p	○	○
720p/1080i	○	○
1080p	○ (50 / 60 Hz only)	○ (24 Hz / 30 Hz / 50 Hz / 60 Hz)

EXTERNAL EQUIPMENT SETUP

Connecting a set-top box with an HDMI cable

- 1 Connect the digital set-top box to **HDMI/DVI IN 1** or **HDMI2** jack on the TV.
- 2 Turn on the digital set-top box.
(Refer to the owner's manual for the digital set-top box.)
- 3 Select **HDMI1** or **HDMI2** input source using the **INPUT** button on the remote control.

! NOTE

- ▶ Check that your HDMI cable is High Speed HDMI cable. If the HDMI cables are not High Speed HDMI cable, flickering or no screen display can result. Please use the High Speed HDMI cable.
- ▶ We recommend less than 10m for HDMI cable, and recommend to use amplifier or repeater for more than that.

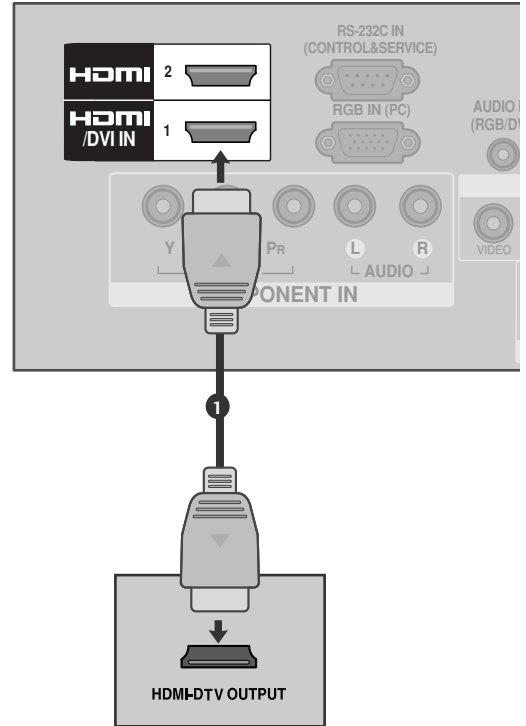

Connecting with an HDMI to DVI cable

- 1 Connect the digital set-top box to **HDMI/DVI IN 1** jack on the TV.
- 2 Connect the audio output of the digital set-top box to the **AUDIO IN (RGB/DVI)** jack on the TV.
- 3 Turn on the digital set-top box. (Refer to the owner's manual for the digital set-top box.)
- 4 Select **HDMI1** input source using the **INPUT** button on the remote control.

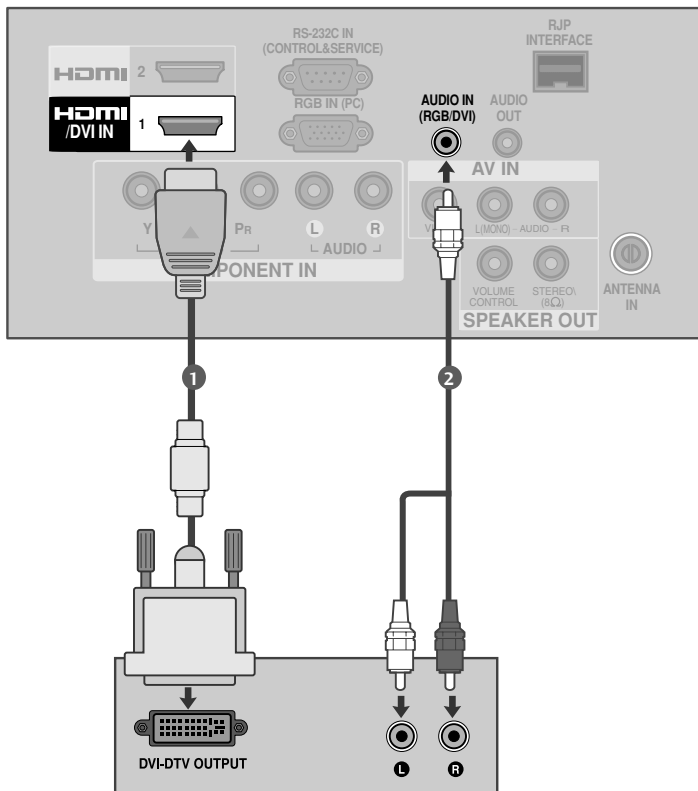

EXTERNAL EQUIPMENT SETUP

DVD SETUP

Connecting with a component cable

- 1 Connect the video outputs (Y, PB, PR) of the DVD to the **COMPONENT IN VIDEO** jacks on the TV.
- 2 Connect the audio outputs of the DVD to the **COMPONENT IN AUDIO** jacks on the TV.
- 3 Turn on the DVD player, insert a DVD.
- 4 Select **Component** input source using the **INPUT** button on the remote control.
- 5 Refer to the DVD player's manual for operating instructions.

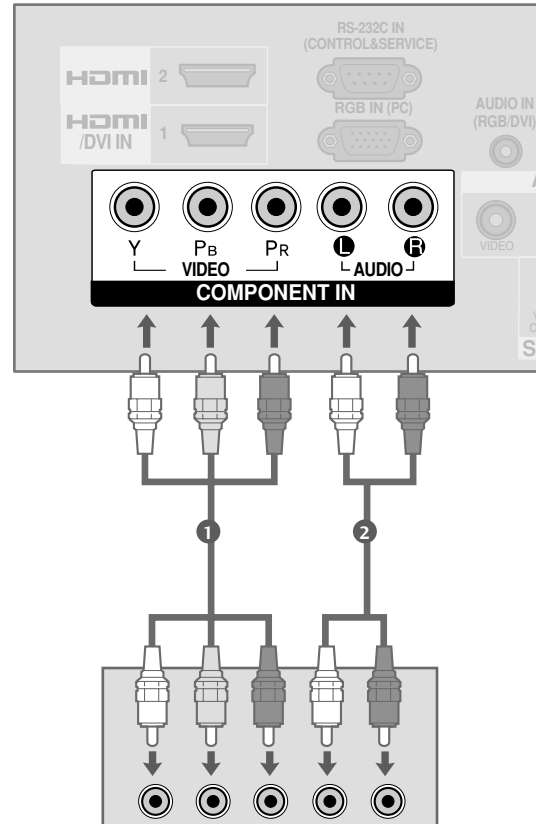

Component Input ports

To achieve better picture quality, connect a DVD player to the component input ports as shown below.

Component ports on the TV	Y	P _B	P _R
Video output ports on DVD player	Y	P _B	P _R
	Y	B-Y	R-Y
	Y	C _b	C _r
	Y	P _b	P _r

Connecting the HDMI cable

- 1 Connect the HDMI output of the DVD to the **HDMI/DVI IN 1** or **HDMI2** jack on the TV.
- 2 Select **HDMI1** or **HDMI2** input source using the **INPUT** button on the remote control.
- 3 Refer to the DVD player's manual for operating instructions.

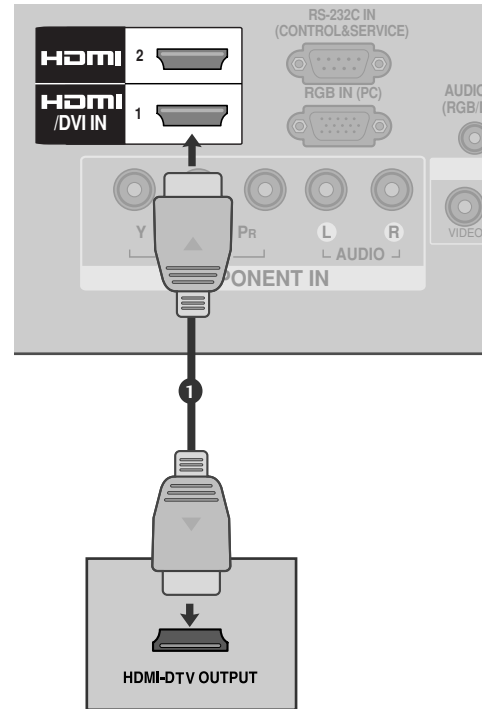

! NOTE

- ▶ The TV can receive video and audio signals simultaneously when using a HDMI cable.
- ▶ If the DVD does not support Auto HDMI, you must set the output resolution appropriately.
- ▶ Check that your HDMI cable is High Speed HDMI Cable. If the HDMI cables are not High Speed HDMI cable, flickering or no screen display can result. Please use the High Speed HDMI cable.
- ▶ We recommend less than 10m for HDMI cable, and recommend to use amplifier or repeater for more than that.

EXTERNAL EQUIPMENT SETUP

VCR SETUP

- To avoid picture noise (interference), allow adequate distance between the VCR and TV.

Connecting with a RF Cable

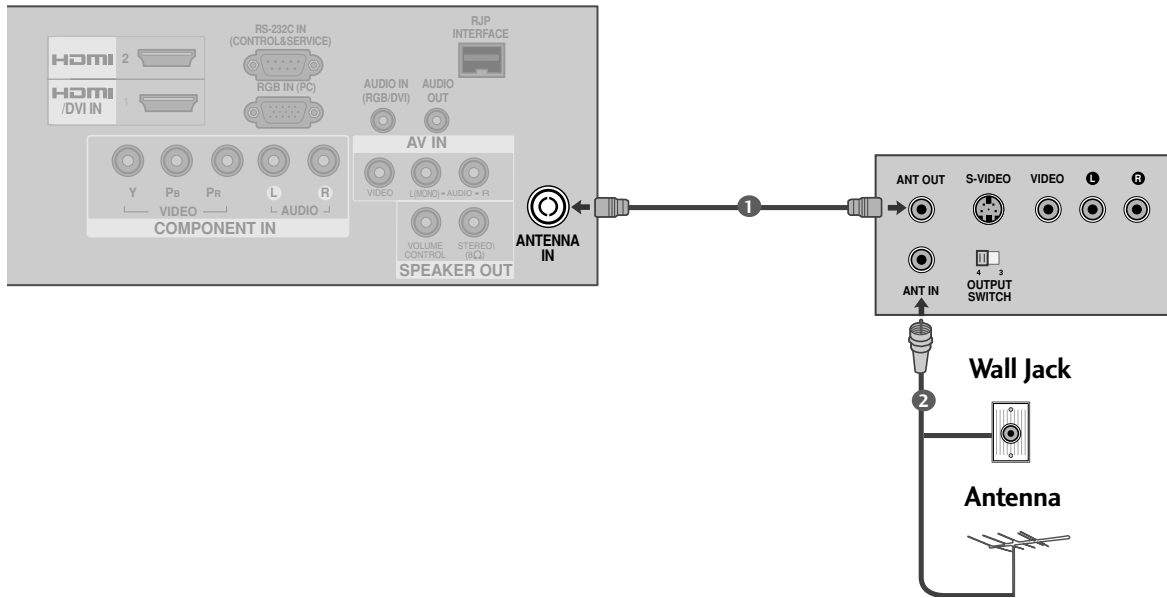

- 1 Connect the **ANT OUT** socket of the VCR to the **ANTENNA IN** socket on the TV.
.....
- 2 Connect the antenna cable to the **ANT IN** socket of the VCR.
.....
- 3 Press the **PLAY** button on the VCR and match the appropriate channel between the TV and VCR for viewing.
.....

Connecting with a RCA cable

- 1 Connect the **AUDIO/VIDEO** jacks between TV and VCR. Match the jack colours (Video = yellow, Audio Left = white, and Audio Right = red)
- 2 Insert a video tape into the VCR and press **PLAY** on the VCR. (Refer to the VCR owner's manual.)
- 3 Select **AV** input source using the **INPUT** button on the remote control.

! NOTE

- ▶ If you have a mono VCR, connect the audio cable from the VCR to the **AUDIO L/MONO** jack of the TV.

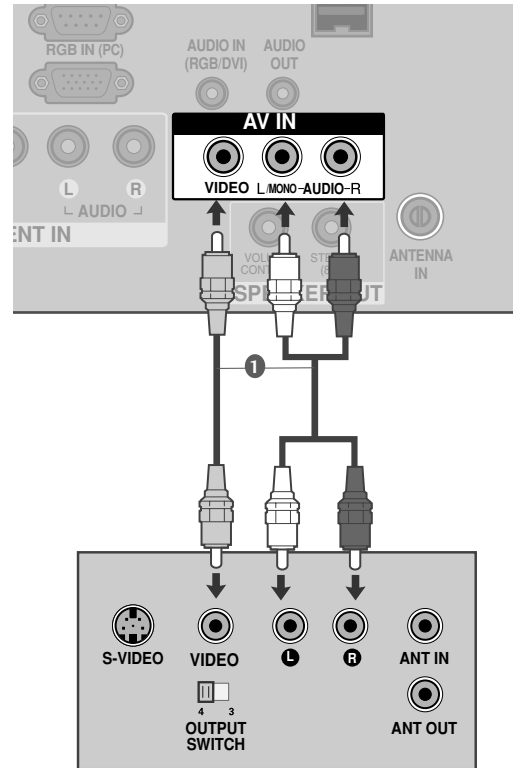

EXTERNAL EQUIPMENT SETUP

OTHER A/V SOURCE SETUP

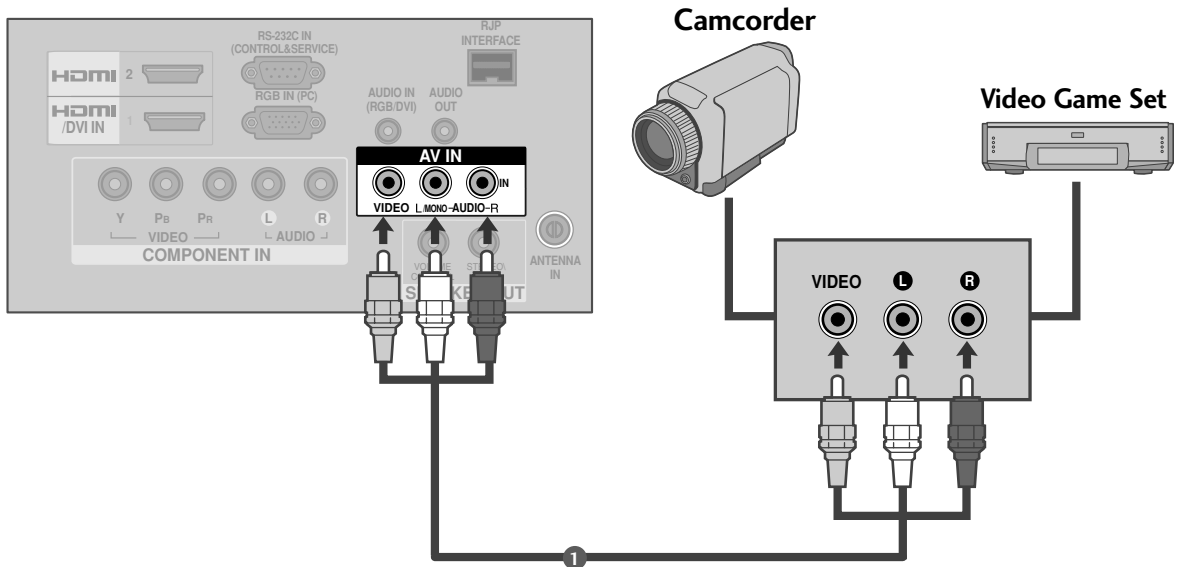

- 1 Connect the **AUDIO/VIDEO** jacks between TV and external equipment. Match the jack colours .
(Video = yellow, Audio Left = white, and Audio Right = red)
- 2 Select **AV** input source with using the **INPUT** button on the remote control.
- 3 Operate the corresponding external equipment.
Refer to external equipment operating guide.

USB IN SETUP

- Here shown may differ from your TV.

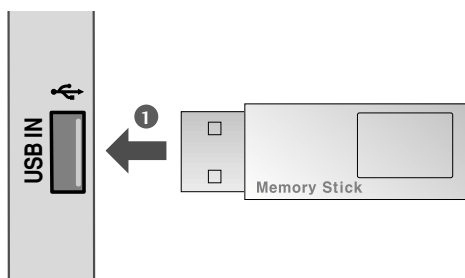

- 1 Connect the USB device to the **USB IN** jack on the TV.
- 2 After connecting the **USB IN** jacks, you use the **USB** function. (▶ p.46)

SPEAKER OUTPUT SETUP

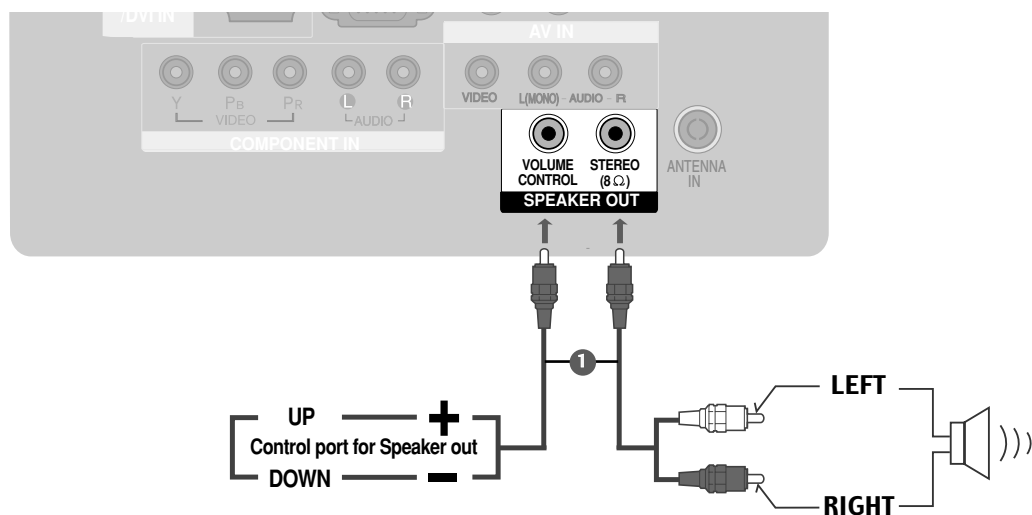

- 1 Connect the external speaker to the **SPEAKER OUTPUT(STEREO)** jack on the TV.

EXTERNAL EQUIPMENT SETUP

PC SETUP

This TV provides Plug and Play capability, meaning that the PC adjusts automatically to the TV's settings.

Connecting with a D-sub 15 pin cable

- 1 Connect the RGB output of the PC to the **RGB IN (PC)** jack on the TV.
- 2 Connect the PC audio output to the **AUDIO IN (RGB/DVI)** jack on the TV.
- 3 Turn on the TV and the PC.
- 4 Select **RGB** input source using the **INPUT** button on the remote control.

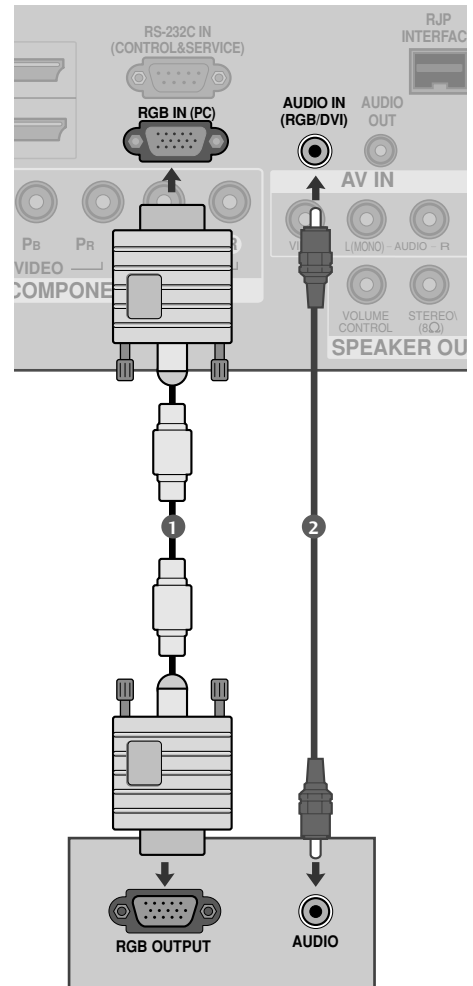

Supported Display Resolution

RGB-PC mode

Resolution	Horizontal Frequency(kHz)	Vertical Frequency(Hz)
640x350	31.468	70.09
720x400	31.469	70.09
640x480	31.469	59.94
800x600	37.879	60.317
1024x768	48.363	60.004
1280x768	47.776	59.87
1360x768	47.720	59.799
1280x1024	63.668	59.895
1920x1080	66.587	59.934



Only 32/37LH220H, 42LH2***

HDMI-DTV mode

Resolution	Horizontal Frequency(kHz)	Vertical Frequency(Hz)
720x480	31.47	59.94
	31.50	60.00
720x576	31.25	50.00
1280x720	44.96	59.94
	45.00	60.00
	37.50	50.00
1920x1080i	33.75	60.00
	33.72	59.94
	28.125	50.00
1920x1080p	67.432	59.94
	67.5	60
	56.250	50
	27	24
	33.75	30

! NOTE

- ▶ Avoid keeping a fixed image on the TV's screen for prolonged periods of time. The fixed image may become permanently imprinted on the screen; use a screen saver when possible.
- ▶ There may be interference relating to resolution, vertical pattern, contrast or brightness in PC mode. Change the PC mode to another resolution or change the refresh rate to another rate or adjust the brightness and contrast on the menu until the picture is clear. If the refresh rate of the PC graphic card can not be changed, change the PC graphic card or consult the manufacturer of the PC graphic card.
- ▶ The synchronization input waveform for Horizontal and Vertical frequencies are separate.
- ▶ If the resolution of PC is over SXGA, there will be no picture on the TV. (only HD Models)
- ▶ Connect the audio cable from the PC to the Audio input on the TV. (Audio cables are not included with the TV).
- ▶ If you use too long an RGB-PC cable, there may be interference on the screen. We recommend using under 5m of the cable. This provides the best picture quality.
- ▶ We recommend using 1360x768, 60Hz (Only 32/37LH220H, 42LH2*** : 1920X1080) for the PC mode, these should provide the best picture quality.
- ▶ HDMI mode supports PCM audio format only.
- ▶ If the Audio setting is set to Dolby/DTS/Bitstream in some DVDP/STB, make sure to change the setting to PCM.

EXTERNAL EQUIPMENT SETUP

Screen Setup for PC mode

Auto Configure (RGB [PC] mode only)

Automatically adjusts the picture position and minimizes image instability. After adjustment, if the image is still not correct, your TV is functioning properly but needs further adjustment.

Auto configure

This function is for automatic adjustment of the screen position, size, and phase.

The displayed image will be unstable for a few seconds while the auto configuration is in progress.

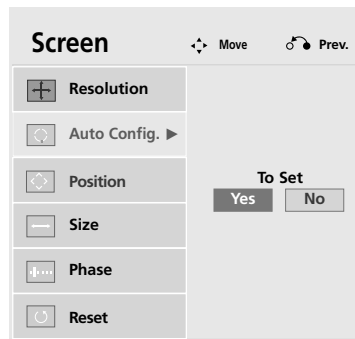
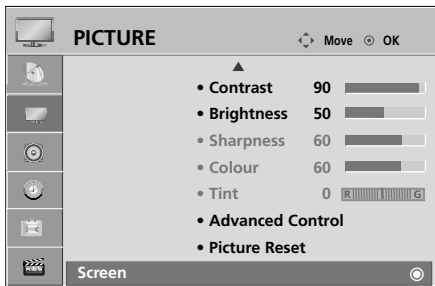

- If the position of the image is still not correct, try Auto adjustment again.
- If picture needs to be adjusted again after Auto adjustment in RGB(PC), you can adjust the **Position, Size** or **Phase**.







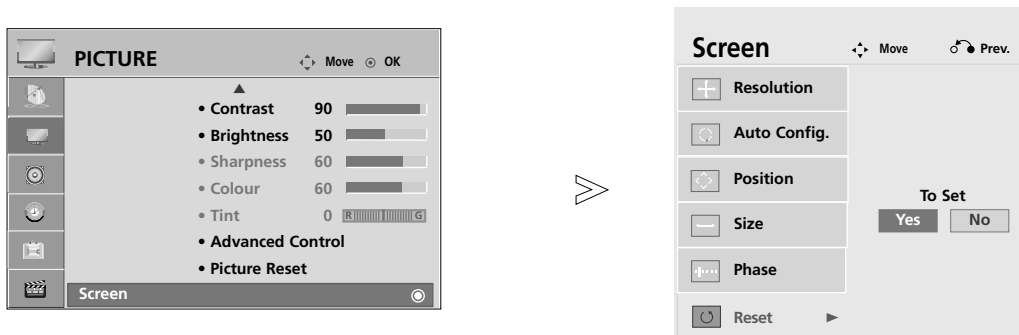

- Press the **MENU** button to return to normal TV viewing.
- Press the **RETURN** button to move to the previous menu screen.

Screen Reset

Returns Position, Size and Phase to the factory default settings.

This function works in the following mode : RGB[PC], Component(except 480i, 576i).



- 1   Select **PICTURE**.
- 2   Select **Screen**.
- 3   Select **Reset**.
- 4   Select **Yes**.
- 5  Run **Reset**.

- Press the **MENU** button to return to normal TV viewing.
- Press the **RETURN** button to move to the previous menu screen.







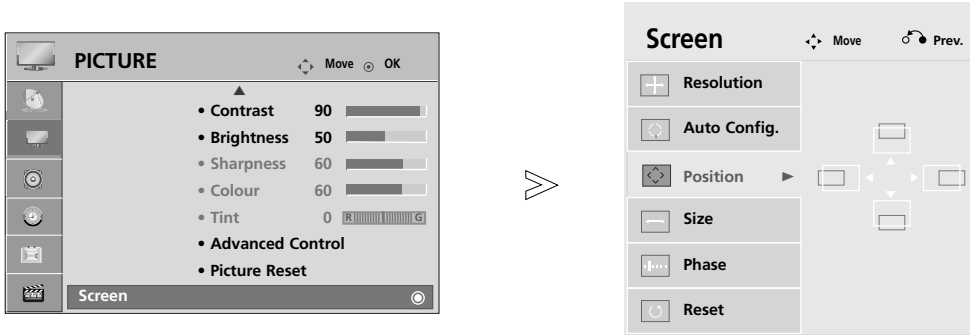

EXTERNAL EQUIPMENT SETUP

Adjustment for screen Position, Size, Phase

If the picture is not clear after auto adjustment and especially if characters are still trembling, adjust the picture phase manually.

Position operates in Component(except 480i, 576i), RGB mode.
Size, Phase operate only in RGB mode.



- 1   Select **PICTURE**.
- 2   Select **Screen**.
- 3   Select **Position, Size** or **Phase**.
- 4    Make appropriate adjustments.







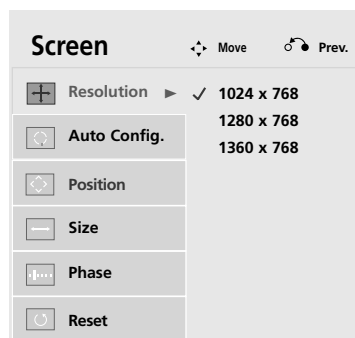
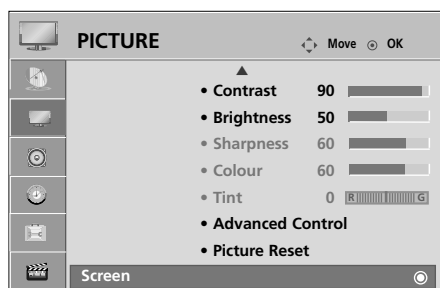

- Press the **MENU** button to return to normal TV viewing.
- Press the **RETURN** button to move to the previous menu screen.

Selecting Resolution

To view a normal picture, match the resolution of RGB mode and selection of PC mode.

This function works in the following mode: RGB[PC]



- 1   Select **PICTURE**.
- 2   Select **Screen**.
- 3   Select **Resolution**.
- 4   Select the desired resolution.

- Press the **MENU** button to return to normal TV viewing.
- Press the **RETURN** button to move to the previous menu screen.

WATCHING TV / PROGRAMME CONTROL

REMOTE CONTROL KEY FUNCTIONS

When using the remote control, aim it at the remote control sensor on the TV.



RATIO Selects your desired picture format.

AV MODE It helps you select and set images and sounds when connecting AV devices. (► p.45)

POWER Switches the TV on from standby or off to standby.

INPUT External input mode rotate in regular sequence.

ENERGY SAVING Adjust the energy saving mode of the TV.

0 to 9 number button Selects a programme.
Selects numbered items in a menu.

Q.VIEW Returns to the previously viewed programme.

LIST Displays the programme table.

THUMBSTICK (Up/Down/Left/Right) Allows you to navigate the on-screen menus and adjust the system settings to your preference.

OK Accepts your selection or displays the current mode.

MENU Selects a menu.
Clears all on-screen displays and returns to TV viewing from any menu.

RETURN Allows the user to move return one step in an interactive application or other user interaction function.

Coloured buttons These buttons are used for teletext (on **TELETEXT** models only) , **Programme edit**.

1 TELETEXT BUTTONS These buttons are used for teletext. For further details, see the 'Teletext' section. (► p.83)

MARK/FAV Displays the selected favourite programme.



VOLUME UP /DOWN Adjusts the volume.

MUTE Switches the sound on or off.

Programme UP/DOWN Selects a programme.

PAGE UP/DOWN Move from one full set of screen information to the next one.

SIMPLINK Menu control buttons Controls SIMPLINK menu.

SIMPLINK See a list of AV devices connected to TV. When you toggle this button, the Simplink menu appears at the screen. (▶ p.40)

Q. MENU Select the desired quick menu source. (Aspect Ratio, Clear Voice II, Picture Mode, Sound Mode, AUDIO, Sleep Timer, Favourite, USB Device) (▶ p.29)

Installing Batteries

- Loose the bolt on battery compartment cover.
- Open the battery compartment cover on the back and install the batteries matching correct polarity (+with +,-with -).
- Install two 1.5V AAA batteries. Do not mix old or used batteries with new ones.
- Close cover.

WATCHING TV / PROGRAMME CONTROL

TURNING ON THE TV

- When your TV is turned on, you will be able to use its features.

- 1 Firstly, connect the power cord correctly and check the main power on the TV.
At this stage, the TV switches to standby mode.
- 2 In standby mode to turn TV on, press the  / **I**, **INPUT** or **P ▲ ▼** button on the TV or press the **POWER**, **INPUT**, **P ^ v** or **NUMBER** button on the remote control and the TV will switch on.

Initializing setup

If the OSD (On Screen Display) is displayed on the screen after turning on the TV, you can adjust the **Language**, **Auto Tuning**.

Note:

- a. If you close without completing the initial setting, the Initial Setting menu can be displayed again.

PROGRAMME SELECTION

- 1 Press the **P ^ v** or **NUMBER** buttons to select a programme number.

VOLUME ADJUSTMENT

- 1 Press the  **+** or **-** button to adjust the volume.

If you wish to switch the sound off, press the **MUTE** button.

You can cancel this function by pressing the **MUTE**,  **+** or **-**, **AV Mode** button.





QUICK MENU

Your TV's OSD (On Screen Display) may differ slightly from that shown in this manual.

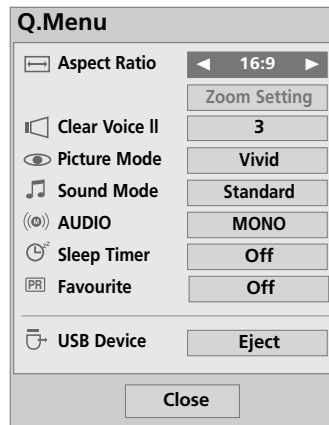
Q.Menu (Quick Menu) is a menu of features which users might use frequently.

- **Aspect Ratio**: Selects your desired picture format. For Zoom Setting, select 16:9, Original, 4:3, 14:9, Zoom and Cinema Zoom in Ratio Menu. After completing Zoom Setting, the display goes back to Q.Menu.
- **Clear Voice II**: By differentiating the human sound range from others, it helps users listen to human voices better.
- **Picture Mode**: Selects your desired Picture Mode.
- **Sound Mode**: It is a feature to automatically set the sound combination which it deems the best for the images being watched. Selects your desired Sound Mode.
- **AUDIO**: Selects the sound output.
- **Sleep Timer**: Sets the sleep timer.
- **Favourite**: Selects the favourite On or Off.
- **USB Device**: Selects "Eject" in order to eject USB device.



1.   Display each menu.
2.  Select your desired Source.
3. 

- Press the **Q.MENU** button to return to normal TV viewing.



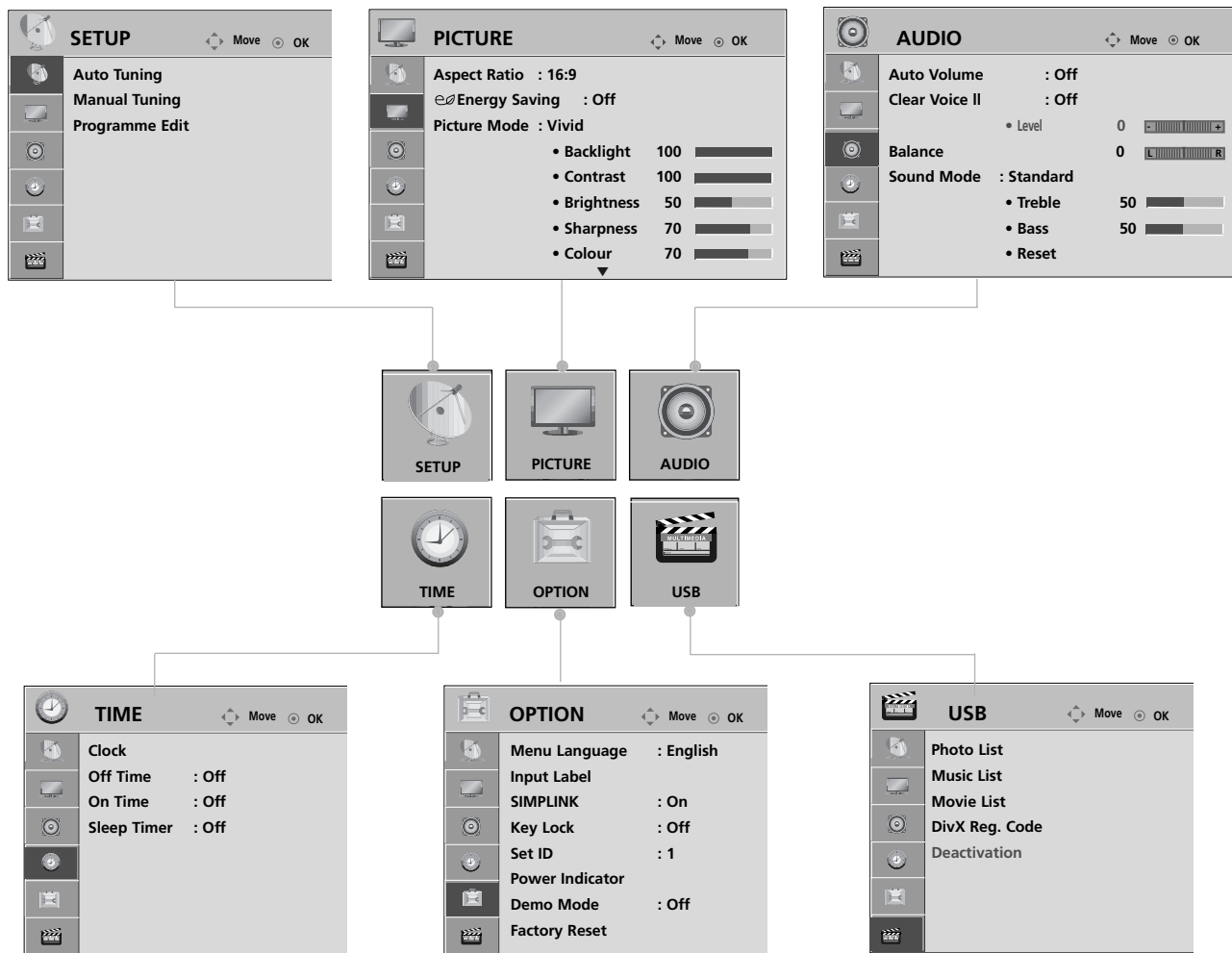

WATCHING TV / PROGRAMME CONTROL

ON SCREEN MENUS SELECTION AND ADJUSTMENT

■ Here shown may be somewhat different from your TV.
Your TV's OSD (On Screen Display) may differ slightly from that shown in this manual.

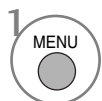

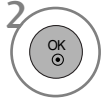
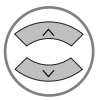
WATCHING TV / PROGRAMME CONTROL

- 1   Display each menu.
- 2   Select a menu item.
- 3  Move to the pop up menu.







- Press the **MENU** button to return to normal TV viewing.
- Press the **RETURN** button to move to the previous menu screen.

AUTO PROGRAMME TUNING

Use this to automatically find and store all available programmes.

When you start auto programming, all previously stored service information will be deleted.



- 1   Select **SETUP**.
- 2   Select **Auto Tuning**.
- 3   Select **Yes**.
- 4  Run **Auto Tuning**.

• If you wish to keep on auto tuning select **Yes** using the < > button. Then, press the OK button. Otherwise select **No**.

- Press the **MENU** button to return to normal TV viewing.
- Press the **RETURN** button to move to the previous menu screen.

WATCHING TV / PROGRAMME CONTROL

MANUAL PROGRAMME TUNING

Manual Tuning lets you manually tune and arrange the stations in whatever order you desire.

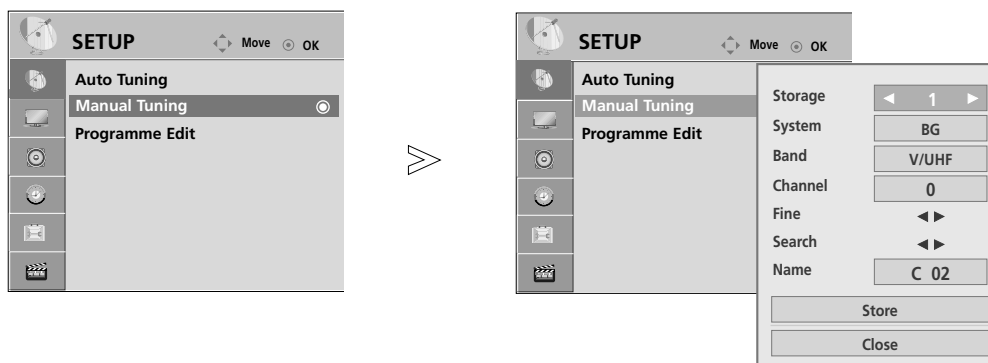

- 1 Select **SETUP**.
- 2 Select **Manual Tuning**.
- 3 or Select the desired programme number on.
- 4 Select a TV system.
- 5 Select **V/UHF** or **Cable**.
- 6 or Select the desired channel number.
- 7 Commence searching.
- 8 Select **Store**.
- 9

- Press the **MENU** button to return to normal TV viewing.
- Press the **RETURN** button to move to the previous menu screen.

- **BG** : PAL B/G, SECAM B/G (Asia / New Zealand / M.East / Africa)
- **I** : PAL I/II (Hong Kong / South Africa)
- **DK** : PAL D/K, SECAM D/K (China / Africa)
- **M** : Philippines
- To store another channel, repeat steps 3 to 9.

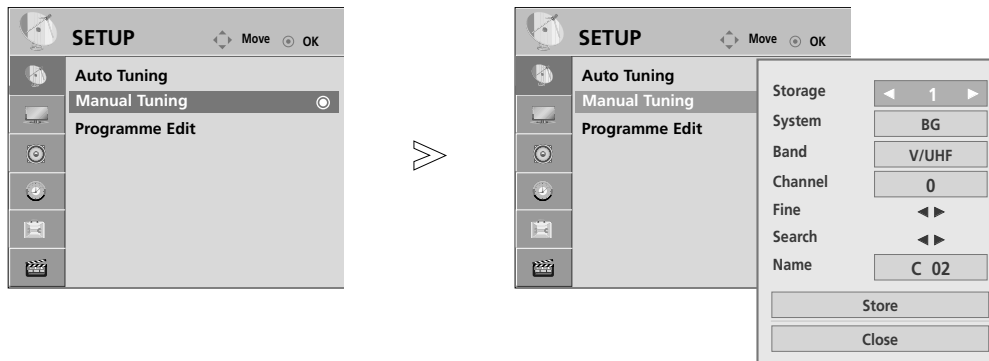

■ Assigning a station name

You can assign a station name with five characters to each programme number.

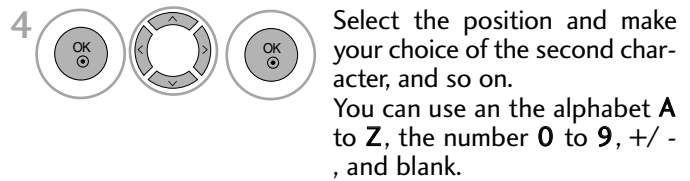

■ Fine Tuning

Normally fine tuning is only necessary if reception is poor.

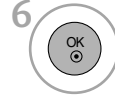
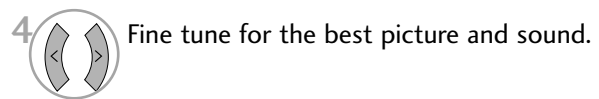

- Press the **MENU** button to return to normal TV viewing.
- Press the **RETURN** button to move to the previous menu screen.

WATCHING TV / PROGRAMME CONTROL



PROGRAMME EDIT

When a programme number is skipped, it means that you will be unable to select it using **P** ^ v button during TV viewing.

If you wish to select the skipped programme, directly enter the programme number with the **NUMBER** buttons or select it in the Programme edit menu.

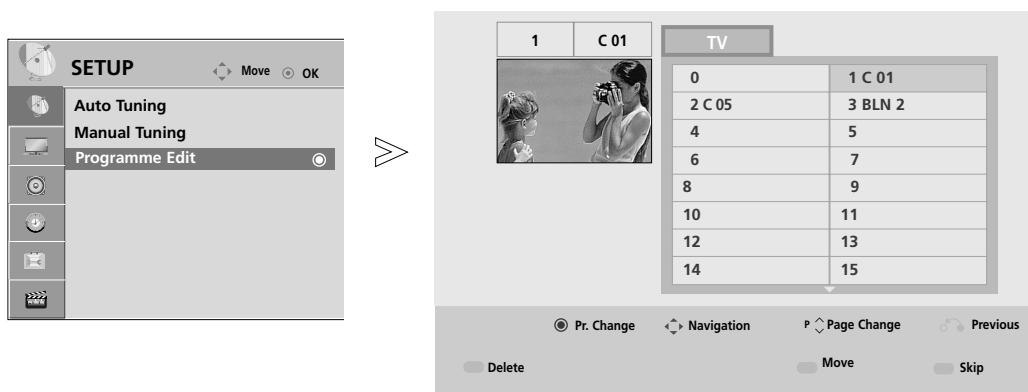
This function enables you to skip the stored programmes.

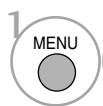

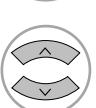
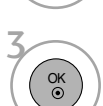
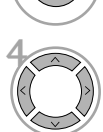

-   Select **SETUP**.
-   Select **Programme Edit**.
-  Enter the **Programme Edit**.
-  Select a programme to be stored or skipped.

- Press the **MENU** button to return to normal TV viewing.
- Press the **RETURN** button to move to the previous menu screen.

This function enables you to delete or skip the stored programmes.
You can also move some channels and use other programme numbers.

■ Deleting a programme

1  Select a programme number to be deleted.



2  Turn the deleted programme number to RED.

3  Release the deleted programme.

- The selected programme is deleted, all the following programmes are shifted up one position.

■ Moving a programme

1  Select a programme number to be moved.

2   Turn the moved programme number to YELLOW.

3  Release the moved programme.

■ Skipping a programme number

1  Select a programme number to be skipped.

2  Turn the skipped programme number to BLUE.

3 Release the skipped programme.

- When a programme number is skipped it means that you will be unable to select it using the P ^ v button during normal TV viewing.
- If you wish to select a skipped programme, directly enter the programme number with the NUMBER buttons or select it in the programme edit.

WATCHING TV / PROGRAMME CONTROL

SELECTING THE PROGRAMME LIST

You can check which programmes are stored in the memory by displaying the programme list.





■ Displaying programme list

- 1  Display the Programme List.

- You may find some blue programmes. These have been set up to be skipped by auto programming or in the programme edit mode.
- Some programmes with the channel number shown in the programme LIST indicate there is no station name assigned.

■ Selecting a programme in the programme list

- 1  Select a programme.
- 2  Switch to the chosen programme number.

■ Paging through a programme list

- 1  Turn the pages.
- 2  Return to normal TV viewing.







FAVOURITE PROGRAMME SETUP

■ Selecting favourite programme

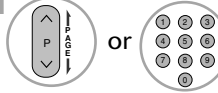
Favorite programmes is a convenient feature that lets you quickly scan up to programmes of your choice without having to wait for the TV to scan through all the in-between programmes.

To tune to a favorite programme, press the **FAV**(Favorite)button repeatedly.



- 1  or  Select your desired programme.
- 2   Select **Favourite**.
- 3  Select **Favourite**.
- 4  Return to TV viewing.

- This will automatically include the selected programme into your favourite programme list.

■ Displaying the favourite programme list



- 1  Display the Favourite Programme List.

WATCHING TV / PROGRAMME CONTROL

INPUT LIST

- Here shown may be somewhat different from your TV.

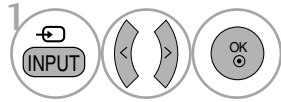

Select the input source.

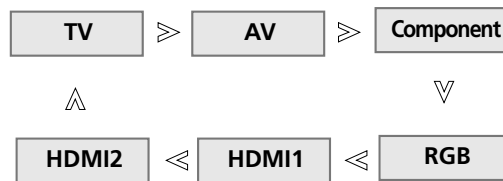





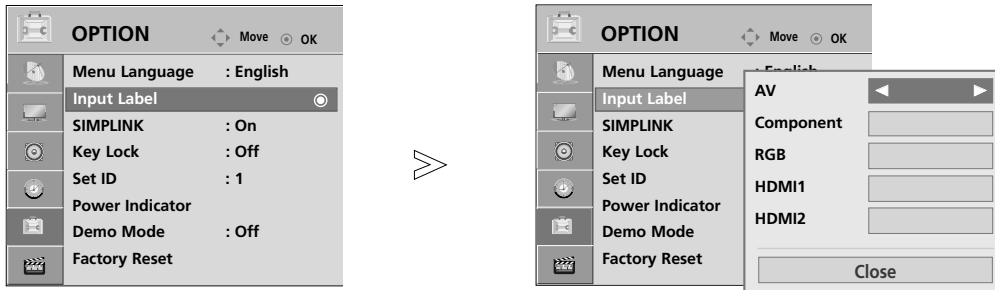

- **TV** : Select it when watching the TV.
- **AV** : Select it when watching the VCR or external equipment.
- **Component** : Select it when using DVD or Digital set-top box depends on connector.
- **RGB** : Select it when using PC depends on connector.
- **HDMI** : Select it when using DVD or Digital set-top box depend on connector.

INPUT LABEL

Selects a label for each input source.



- 1   Select **OPTION**.
- 2   Select **Input Label**.
- 3   Select the source.
- 4  Select the label.

- Press the **MENU** button to return to normal TV viewing.
- Press the **RETURN** button to move to the previous menu screen.

WATCHING TV / PROGRAMME CONTROL



This function operates only with devices with the SIMPLINK logo.
Please check the SIMPLINK logo.

This TV might not function properly when using it with other products with HDMI-CEC function.
This allows you to control and play other AV devices connected to the display through HDMI cable without additional cables and settings.

If you do not want SIMPLINK menu, select "Off".

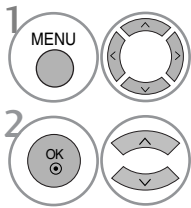
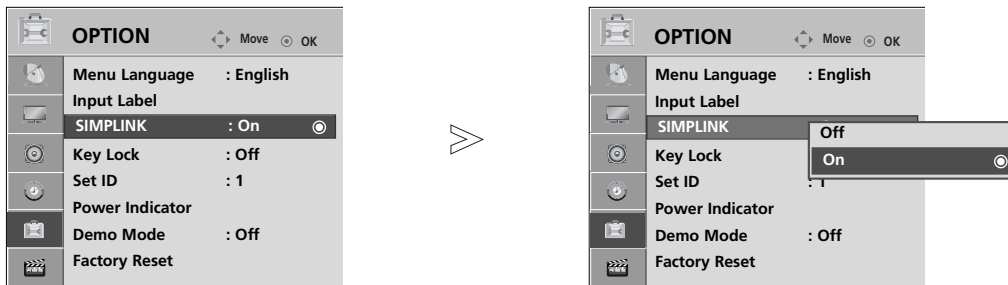

Select **OPTION**.

Select **SIMPLINK**.

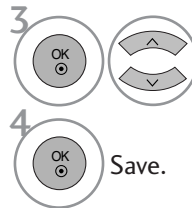

Select **On** or **Off**.

Save.

- Press the **MENU** button to return to normal TV viewing.
- Press the **RETURN** button to move to the previous menu screen.

SIMPLINK Functions

Disc playback

Control connected AV devices by pressing the \wedge \vee \lt \gt , OK, \blacktriangleright , \blacksquare , \parallel , \ll and \gg buttons.

Direct Play

After connecting AV devices to the TV, you can directly control the devices and play media without additional settings.

Select AV device

Enables you to select one of the AV devices connected to the TV and operate it.

Power off all devices

When you switch off the TV, all connected devices are turned off.

Switch audio-out

Offers an easy way to switch audio-out.

Sync Power on

When the equipment with Simlink function connected HDMI terminal starts to play, The TV will change automatically to turn on mode.

* A device, which is connected to the TV through a HDMI cable but does not support SIMPLINK, does not provide this function.

Note: To operate SIMPLINK, an High Speed HDMI cable with *CEC function should be used. (*CEC: Consumer Electronics Control).

Connecting to Home Theater with the SIMPLINK logo.

- 1 Connect the **HDMI/DVI IN 1** or **HDMI IN 2** terminal on the back of the TV and the HDMI output terminal of the Home Theater using HDMI cables.
- 2 Connect the Audio output terminal on the back of the TV and the Audio input terminal of the Home Theater using RCA cables.
- 3 Select Home Theater in the Speaker menu by pushing the **SIMPLINK** button.

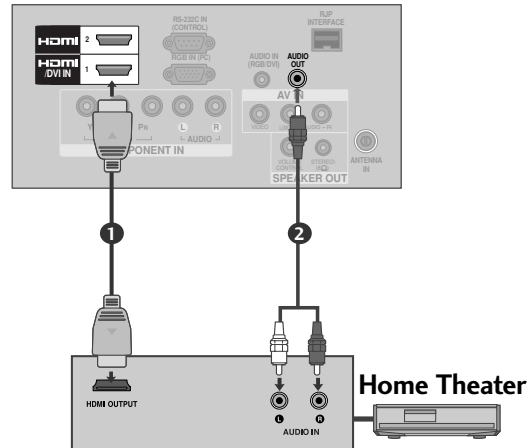

- ▶ When you select or operate a media device with home theater function, the speaker automatically switches to home theater speaker (HT speaker).

! NOTE

- ▶ Connect the HDMI/DVI IN or HDMI IN terminal of the TV to the rear terminal and Side terminal (HDMI terminal) of the SIMPLINK device with the HDMI cable.
- ▶ When you switch the Input source using the INPUT button on the remote control, you can stop the operation of a device controlled by SIMPLINK.
- ▶ When the unit is connected to SIMPLINK Home Theater, set to Variable Out and turn off the TV Speaker to operate the Home Theater Speaker. At this time, the maximum volume of the Home Theater Speaker is set to the TV volume.

WATCHING TV / PROGRAMME CONTROL

SIMPLINK Menu

Press the \wedge \vee \lt \gt button and then **OK** button to select the desired SIMPLINK source.

- 1 **TV viewing** : Switch to the previous TV programme regardless of the current mode.
- 2 **DISC playback** : Select and play connected discs. When multiple discs are available, the titles of discs are conveniently displayed at the bottom of the screen.
- 3 **VCR playback** : Play and control the connected VCR.
- 4 **HDD Recordings playback** : Play and control recordings stored in HDD.
- 5 **Audio Out to Home theater/Audio Out to TV:** Select Home theater or TV speaker for Audio Out.

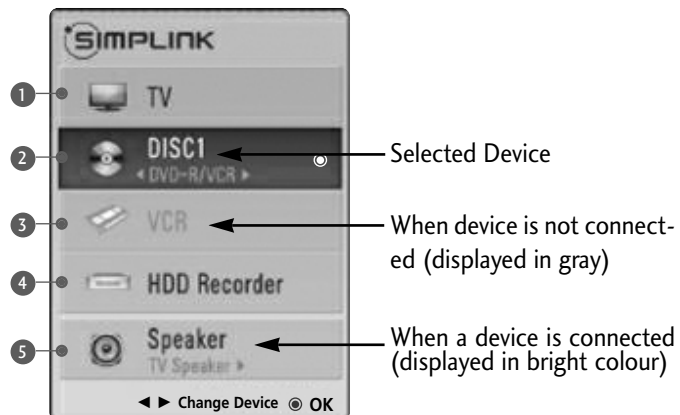







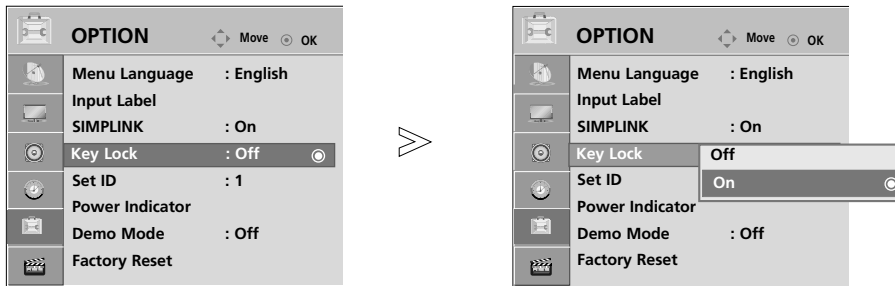

KEY LOCK

The TV can be set so that the remote control is required to control it. This feature can be used to prevent unauthorized viewing.

This TV is programmed to remember which option it was last set to even if you turn the TV off.



- 1   Select **OPTION**.
- 2   Select **Key Lock**.
- 3   Select **On** or **Off**.
- 4  Save.

- In **Key Lock 'On'**, if the TV is turned off, press the **⏻ / I**, **INPUT, P ▲** or **▼** button on the TV or **POWER, INPUT, P ▲ ▼** or **NUMBER** buttons on the remote control then the set will be turned on.
- With the **Key Lock On**, the display ' **Key Lock On**' appears on the screen if any button on the front panel is pressed while viewing the TV.

- Press the **MENU** button to return to normal TV viewing.
- Press the **RETURN** button to move to the previous menu screen.





WATCHING TV / PROGRAMME CONTROL

INITIALIZING (RESET TO ORIGINAL FACTORY SETTINGS)

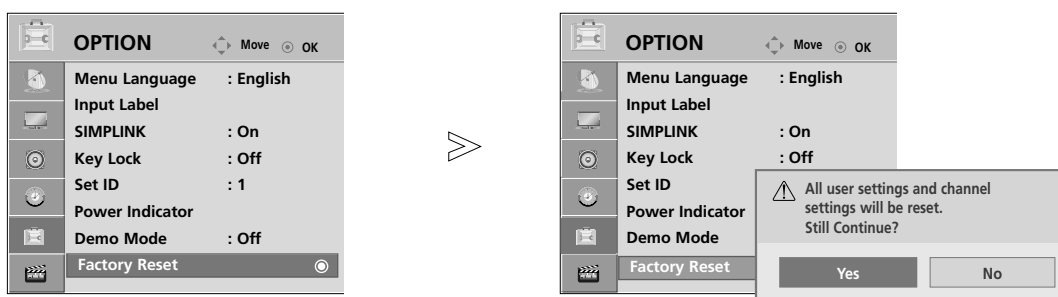
Use to quickly reset all the menu options to their original factory preset values.
This function deletes all TV programmes.

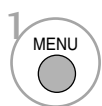
When the **Factory Reset** is completed, you must restart the Initializing setup.

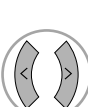
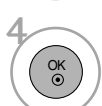

- 1   Select **OPTION**.
- 2   Select **Factory Reset**.
- 3   Select **Yes**.
- 4  Start **Factory Reset**.

- Press the **MENU** button to return to normal TV viewing.
- Press the **RETURN** button to move to the previous menu screen.

AV MODE

You can select the optimal images and sounds when connecting AV devices to external input.

- Off** Disables the AV MODE.
- Cinema** Optimizes video and audio for watching movies.
- Sport** Optimizes video and audio for watching sports events.
- Game** Optimizes video and audio for playing games.

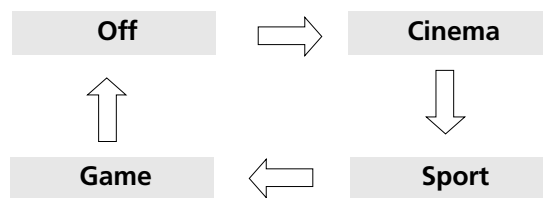

1  Press the **AV MODE** button repeatedly to select the desired source.

2 

- If you select **Cinema** in AV mode, **Cinema** will be selected both for **Picture Mode** and **Sound Mode** in **PICTURE** menu and **AUDIO** menu respectively.
- If you select “**Off**” in **AV mode**, the picture and image which you initially set will be selected.

- Press the **RETURN** button to return to normal TV viewing.

TO USE A USB DEVICE

WHEN CONNECTING THE USB DEVICE

When you connect a USB device, this pop up menu is displayed, automatically.
In USB device, you can not add a new folder or delete the existing folder.

- Here shown may be somewhat different from your TV.

1 Connect the USB device to the **USB IN** jack on the TV.

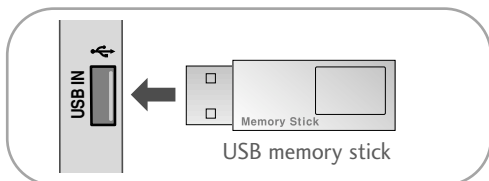

• This TV Supports on JPEG, MP3 and SD Divx.

2 Select **PHOTO LIST**, **MUSIC LIST** or **MOVIE LIST**.

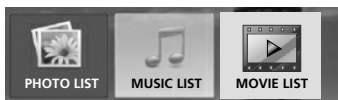

When removing the USB device

Select the USB device menu before removing the USB device.

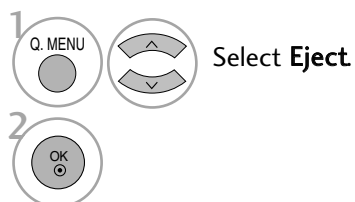

Precautions when using the USB device

- ▶ Only a USB storage device is recognizable.
- ▶ If the USB storage device is connected through a USB hub, the device is not recognizable.
- ▶ A USB storage device using an automatic recognition programme may not be recognized.
- ▶ A USB storage device which uses its own driver may not be recognized.
- ▶ The recognition speed of a USB storage device may depend on each device.
- ▶ Please do not turn off the TV or unplug the USB device when the connected USB storage device is working. When such device is suddenly separated or unplugged, the stored files or the USB storage device may be damaged.
- ▶ Please do not connect the USB storage device which was artificially maneuvered on the PC. The device may cause the product to malfunction or fail to be played. Never forget to use only a USB storage device which has normal music files, image files or movie files.
- ▶ Please use only a USB storage device which was formatted as a FAT16, FAT32, NTFS file system provided with the Windows operating system. In case of a storage device formatted as a different utility programme which is not supported by Windows, it may not be recognized.
Data in a USB storage device cannot be deleted in the NTFS file system.
- ▶ Please connect power to a USB storage device which requires an external power supply. If not, the device may not be recognized.
- ▶ Please connect a USB storage device with cable is offered by USB maker. If connected with cable is not offered by USB maker or an excessively long cable, the device may not be recognized.
- ▶ Some USB storage devices may not be supported or operated smoothly.
- ▶ Please back up the important file because a data of USB device may be damaged. Data management is consumer's responsibility and in consequence the manufactures does not cover the product bearing data damage.
- ▶ Maximum of 999 files and folders can be recognized.
- ▶ Data in a USB storage device cannot be aligned.
- ▶ Up to 128 English characters can be recognized as a file name.
- ▶ If the USB is connected in Standby Mode, specific hard disk will automatically be loaded when the TV is turned on.
- ▶ The recommended capacity is 1TB or less for a USB external hard disk and 32GB or less for USB memory.
- ▶ TV need more time to detect if the storage size is bigger.
- ▶ If the USB memory is connected in Standby Mode, power on time would be longer than without memory.
- ▶ Any device with more than the recommended capacity may not work properly.
- ▶ If a USB external hard disk with a "Energy Saving" function does not work, turn the hard disk off and on again to make it work properly.
- ▶ When using a USB HDD via the USB extension cable, connect a support electric power source.

TO USE A USB DEVICE

PHOTO LIST

The On Screen Display may be different from your TV. Images are an example to assist with the TV operation.

PHOTO(*.JPEG) supporting file

Baseline: Min : 64 x 64

MAX : 15360 x 8640

- Not support to progressive Jpeg
- You can play JPEG files only.
- Only baseline scan is supported among JPEG (SOF0, SOF1 only).
- Non-supported files are displayed in the form of bitmap.

Screen Components

1 MENU Select **USB**.

2 Select **PHOTO LIST**.

1 Moves to upper level folder
2 Current page/Total pages
3 Total number of marked photos
4 Corresponding buttons on the remote control

The screenshot shows a 'PHOTO LIST' interface. On the left, a preview of a photo 'JMJ001' is shown with its dimensions '1366x768, 125KB'. Below it is an 'Up Folder' button. On the right, a table lists folders and files:



Folder/File Name	Date
Up Folder	
KY101	12/10/2009
KY102	12/10/2009
JMJ001	12/10/2009
JMJ002	12/10/2009
JMJ003	12/10/2009
JMJ004	12/10/2009
KY103	12/10/2009
KY104	12/10/2009
KY105	12/10/2009
JMJ005	12/10/2009
JMJ006	12/10/2009
JMJ007	12/10/2009
JMJ008	12/10/2009

At the bottom, a navigation bar includes buttons for 'Navigation', 'OPTION', 'Page Change', 'Mark', and 'Exit'.

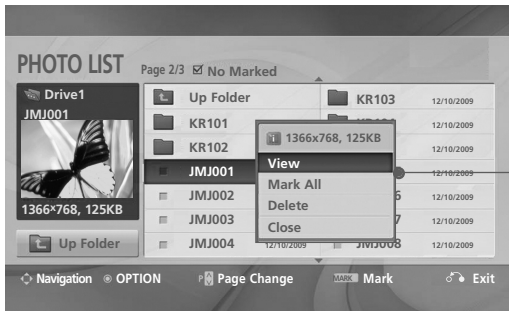
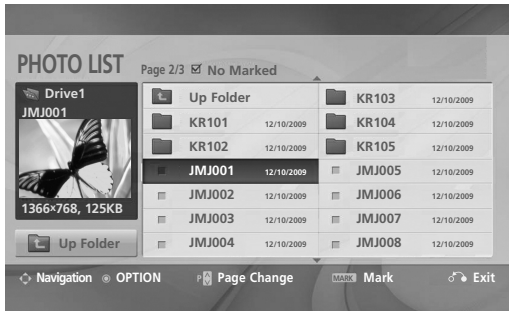
Photo Selection and PopUp Menu

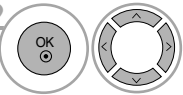

- ▶ **View** : Display the selected item.
- ▶ **Mark All** : Mark all photos on the screen.
- ▶ **Unmark All** : Deselect all marked photos.
- ▶ **Delete** : Delete the selected photo item.
- ▶ **Close** : Close the pop-up menu.

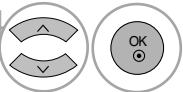
- 1  Select the target folder or drive.
- 2  Select the desired photos.
- 3  Show the PopUp menu.
- 4  Select the desired PopUp menu.

- Use the **P** ^ v button to navigation in the photo page.
- Use the **MARK** button to mark or unmark a photo. When one or more photos are marked, you can view individual photos or a slide show of the marked photos. If no photos are marked, you can view all photos individually or all photos in the folder in a slide show.

TO USE A USB DEVICE





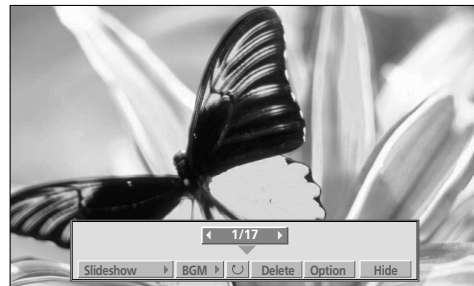
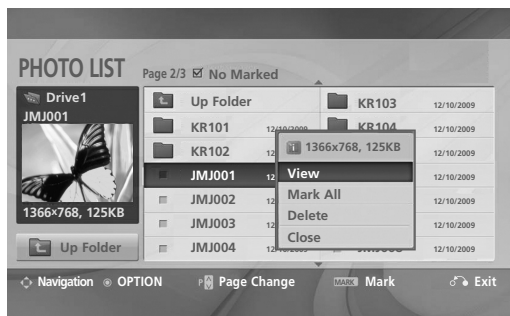
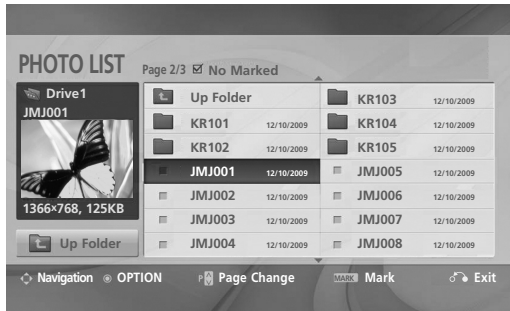

Set up the menu in Full-Sized Screen

You can change the settings to display photos stored on a USB device, on a full-sized screen. Detailed operations are available on full-sized photo view screen.



The aspect ratio of a photo may change the size of the photo displayed on the screen in full size. Press the **RETURN** button to move to the previous menu screen.

TO USE A USB DEVICE

-  Select the target folder or drive.
-   Select the desired photos.
-  Show the PopUp menu.
-  Select **View**.
-  The selected photo is displayed in full size.

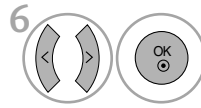

Select the **Slideshow**, **BGM**,  (**Rotate**), **Delete**, **Option** or **Hide**.

- Use < > button to select the previous or next photo.
- Use < > button to select and control the menu on the full-sized screen.

- ▶ **Slideshow** : When no picture is selected, all photos in the current folder are displayed during slide show. When selected, the selected photos are displayed during slide show.
 - Set the time interval of the slide show in **Option**.
- ▶ **BGM** : Listen to music while viewing photos in full size.
 - Set the BGM device and album in **Option**.
- ▶  (**Rotate**) : Rotate photos.
 - Rotates the photo 90°, 180°, 270°, 360° clockwise.
- ▶ **Delete** : Delete photos.
- ▶ **Option** : Set values for **Slide Speed** and **Music Folder**.
 - Use ^ v < > button and **OK** button to set values. Then go to **OK** and press **OK** to save the settings.
 - You cannot change **Music Folder** while BGM is playing.
- ▶ **Hide** : Hide the menu on the full-sized screen.
 - To see the menu again on the full-sized screen, press **OK** button to display.

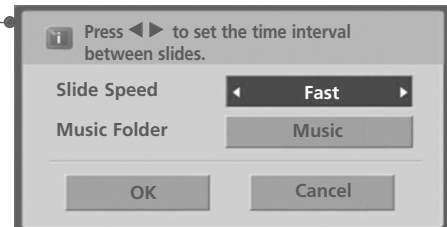

TO USE A USB DEVICE

MUSIC LIST

Purchased music files(*.MP3) may contain copyright restrictions. Playback of these files may not be supported by this model.

Music file on your USB device can be played by this unit.

The On Screen Display may be different from your TV. Images are an example to assist with the TV operation.

MUSIC (*.MP3) supporting file
Bit rate : 32k to 320kbps
Sampling rate MPEG1 layer 3: 32k to 48kHz

Screen Components



- 1 Moves to upper level folder
- 2 Current page/Total pages
- 3 Total number of marked music title
- 4 Corresponding buttons on the remote control



Music Selection and PopUp Menu

As shown, up to 6 music titles are listed per page.

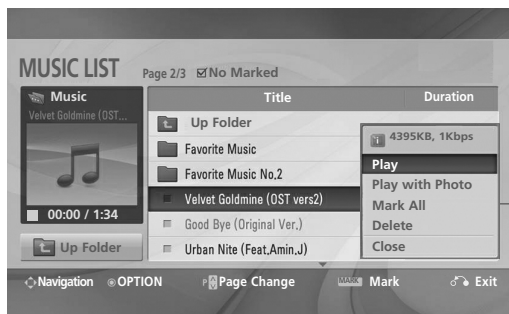
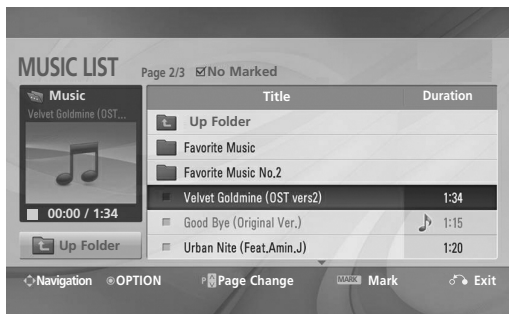

- ▶ **Play (During stop)** : Play the selected music titles.
Once a music finished playing, the next selected one will be played. When there are no selected music titles to play, the next one in the current folder will be played.
- ▶ **Play Marked** : Play the selected music titles.
Once a music finishes playing, the next selected one will be played automatically.
- ▶ **Stop Play (During playback)** : Stop the playing music titles.
- ▶ **Play with Photo** : Start playing the selected music titles and then move to the Photo List.
- ▶ **Mark All** : Mark all music titles in the folder.
- ▶ **Unmark All** : Deselect all marked music titles.
- ▶ **Delete** : Delete the selected music titles.
- ▶ **Close** : Close the pop-up menu.



1 Select the target folder or drive.

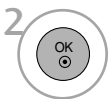

2 Select the desired music title.

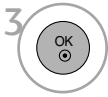

3 Show the PopUp menu.



4 Select the desired PopUp menu.

- Use the **P** ^ v button to navigation in the music page.
- Use **MARK** button to mark or unmark a music. When one or more music files are marked, the marked music title will be played in sequence. For example, if you want to listen to only one music repeatedly, just mark the music only and play it. If no music is marked, all the music in the folder will be played in sequence.

TO USE A USB DEVICE

- If you don't press any button for a while during the playing, the play information box (as shown in the below) will float as a screen saver.
- The 'Screen Saver'?
Screen saver is to prevent screen pixel damage due to an fixed image remaining on the screen for a extended period of time.

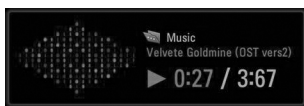

! NOTE

- ▶ When music is playing,  is displayed in back of the music title.
- ▶ A damaged or corrupted music does not play but displays 00:00 in playtime.
- ▶ A music downloaded from a paid service with copyright protection does not start but displays inappropriate information in playtime.
- ▶ If you press **OK**, **■** buttons, screen saver is stopped.
- ▶ This TV can not play music files less than 32 Kbytes.
- ▶ The **PLAY(▶)**, **Pause(II)**, **■**, **▶▶**, **◀◀** buttons on the remote control are also available in this mode.
- ▶ You can use the **▶▶** button to select the next music and the **◀◀** button to select the previous music.

MOVIE LIST

The movie list is activated once USB is detected. It is used when playing movie files on TV.

Displays the movies in the USB folder and supports Play.

Allows playback of all movies in the folder and user desired files.

Editing such as delete and add is not allowed.

It is a movie list that displays folder information and Divx file.

Supports up to four drives.

MOVIE(*.avi/*.Divx) supporting file

Video format : MPEG1 , MPEG2, MPEG4(Doesn't support Microsoft MPEG4-V2, V3), DivX 3.xx , DivX 4.xx, DivX 5.xx , DivX VOD (DRM), XviD, Divx 6.xx(Playback)

Audio format : Mpeg, Mp3, PCM, Dolby Digital, AC3

Sampling frequency : 32k to 48kHz

Bit rate : 32k to 320kbps

Subtitle format : *.smi/ *.srt/ *.sub(MicroDVD, SubViewer 2.0)/ *.ass/ *.ssa/*.txt(DVD Subtitle System)

- DivX may not be played depending on its types or recording methods.
- If the video and audio structure of recorded file is not interleaved, either video or audio is outputted.
- **Max bitrate of playable DivX file is 6Mbps.**
- Maximum FPS (Frame Per Second) can be reached only at SD level. FPS is 25 FPS (720*576) or 30 FPS (720*480) depending on Resolution.
- Time information in an external subtitle file should be arranged in ascending order to be played.
- Files of 25 FPS or 30 FPS of higher may not be played properly.
- If the file is recorded with GMC, the unit supports only 1 point of recorded level.
(GMC is the acronym for Global Motion Compensation, a technique used to compensate MPEG Video files.)
- A video file name and its subtitle file name must be identical for it to be displayed.
- A DivX movie file and its subtitle file must be located in the same folder.
- Use the left/right (< / >) keys to move to a specific frame forward or backward while playing a movie.
(The left/right (< / >) keys may not work properly for some files while playing a movie.)
- Playing a video via a USB connection that does not support high speed may not work properly.
- USB storage devices below USB 2.0 are supported as well. But they may not work properly in the movie list.

File Extension name	Video Decodex	Audio Codec	Resolution
mpg, mpeg, mpe, vob, dat	MPEG1, MPEG2	AC3,MPEG,MP3,PCM	
Avi, divx, m4v	MPEG 4-SP, MPEG4-ASP, Divx 3.xx,Divx 4.xx, Divx 5.xx, Divx 6.xx(Playback), Xvid	AC3,MPEG,MP3,PCM	720x576@25p 720x480@30p

TO USE A USB DEVICE

Screen Components

1 MENU Select USB.

2 OK Select MOVIE LIST.

3 OK

4 Navigation

1 Moves to upper level folder

2 Current page/Total pages

3 Total number of marked movies

4 Corresponding buttons on the remote control

Title	Duration
Up Folder	
KR1	
KR2	
SJS001	00:00:00
SJS002	00:00:00
SJS003	00:00:00

Movie Selection and PopUp Menu

As shown, up to 6 movie titles are listed per page.

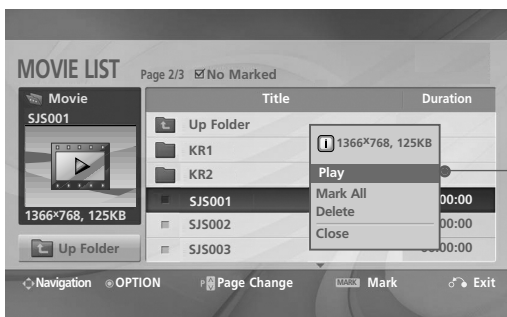
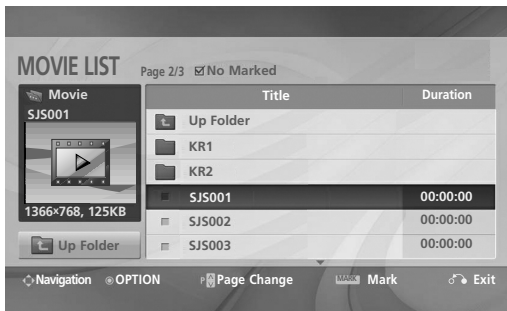

- ▶ **Play** : Play the selected movie titles. Divx Play is executed while screen changes.
- ▶ **Play Marked** : Play the selected movie titles. Once a music finishes playing, the next selected one will be played automatically.
- ▶ **Stop Play (During playback)** : Stop the playing movie titles.
- ▶ **Mark All** : Mark all movie titles in the folder.
- ▶ **Unmark All** : Deselect all marked movie titles.
- ▶ **Delete** : Delete the selected movie titles.
- ▶ **Close** : Close the pop-up menu.

1 Select the target folder or drive.

2 Select the desired movie.

3 Show the PopUp menu.

4 Select the desired PopUp menu.

• In the case of files not supported, a message regarding non-supported file is displayed.

DivX Audio Language & Subtitle Language

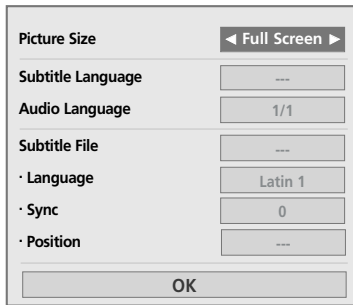

language	Latin1	French, Spanish, Catalan Basque, portuguese, Italian, Albanian, Rhaeto-Romanic, Dutch, German, Danish, Swedish, Norwegian, Finnish, Faroese, Icelandic, Irish, Scottish, English
	Latin2	Czech, Hungarian, Ploish, Romanian, Croatian, Slovak, Slovenian, Sorvian
	Latin4	Estonian, the Baltic languages Latvian(Lettish) and Lithuanian, Greenlandic and Lappish
	Latin5	English, Trukish
	Cyrillic	Bulgarian, Byelorussian, Macedonian, Russian, Serbian and pre-1990 (no ghe with upturn) Ukrainian
	Greek	English, modern Greek
	Hebrew	English, modern Hebrew
	Chinese	Chinese
	Thai	Thai
	Arabic	English, Arabic



Select the desired option.

- When DivX is playing, if you press the **RED** button, this message is displayed.

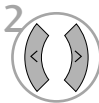

Select **Picture Size**, **Subtitle Language**, **Audio Language**, **Subtitle File**, **Language**, **Sync** or **Position**.

- Press the **MENU** button to return to normal TV viewing.
- Press the **RETURN** button to move to the previous menu screen.

Using the remote control

◀◀ / ▶▶	<p>When playing, repeatedly, press the REW(◀◀) button to speed up ◀◀ -> ◀◀◀◀ -> ◀◀◀◀◀◀ -> ◀◀◀◀◀◀◀◀ -> ◀◀◀◀◀◀◀◀◀◀◀◀.</p> <p>repeatedly, press the FF(▶▶) button to speed up ▶▶->▶▶▶▶ ->▶▶▶▶▶▶ ->▶▶▶▶▶▶▶▶ ->▶▶▶▶▶▶▶▶▶▶.</p> <ul style="list-style-type: none"> ▪ Pressing these buttons repeatedly increases the fast forward/reverse speed.
II	<p>During playback, press the Pause(II) button.</p> <ul style="list-style-type: none"> ▪ Still screen is displayed.
< >	<ul style="list-style-type: none"> ▪ When using the < or > button during playback a cursor indicating the position can be viewed on the screen.
PLAY(▶)	<p>Press the PLAY(▶) button to return to normal playback.</p>

TO USE A USB DEVICE

DIVX REGISTRATION CODE

Confirm the DivX registration code number of the TV. Using the registration number, movies can be rented or purchased at www.divx.com/vod.

With a DivX registration code from other TV, playback of rented or purchased DivX file is not allowed. (Only DivX files matched with the registration code of the purchased TV are playable.)

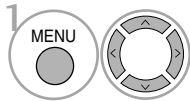
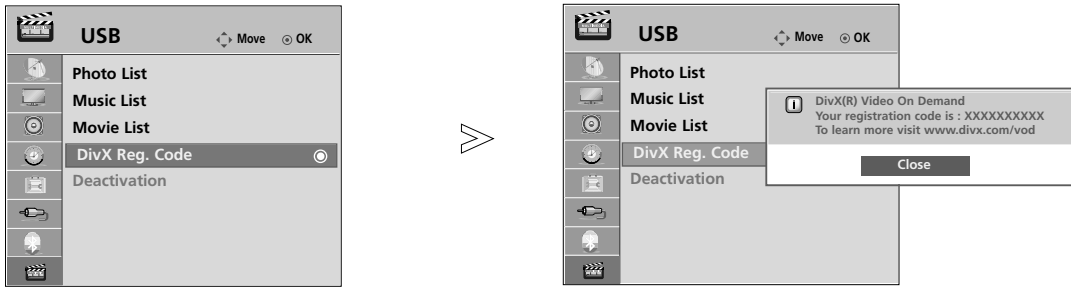

Select **USB**.

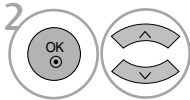

Select **DivX Reg. Code**.



Display **DivX Reg. Code**.

- Press the **MENU** button to return to normal TV viewing.
- Press the **RETURN** button to move to the previous menu screen.



Manufactured under license from Dolby Laboratories. "Dolby" and the double-D symbol are trademarks of Dolby Laboratories.



"DivX Certified to play DivX video, including premium content"

ABOUT DIVX VIDEO : DivX® is a digital video format created by DivX, Inc. This is an official DivX Certified device that plays DivX video. Visit www.divx.com for more information and software tools to convert your files into DivX video.

ABOUT DIVX VIDEO-ON-DEMAND : This DivX Certified® device must be registered in order to play DivX Video-on-Demand[VOD] content. To generate the registration code, locate the DivX VOD section in the device setup menu. Go to vod.divx.com with this code to complete the registration process and learn more about DivX VOD.

NOTE

Supported movie file

Resolution : under 720x480(720x576) WxH pixels.







Frame rate : under 30 frames/sec

- ▶ Video Codec : MPEG1, MPEG2, MPEG4(Doesn't support Microsoft MPEG4-V2, V3), DivX3.xx, DivX4.xx, DivX5.xx, DivX VOD(DRM), XviD.
- ▶ When loading, some buttons may not work.
- ▶ If you use the DivX registration code of another device, the rented or purchased DivX file cannot be played. Therefore always use the DivX registration code assigned to this product.

DEACTIVATION

Delete the existing authentication information to receive a new DivX user authentication for TV.
Once this function is executed, a DivX user authentication is required again to see DivX DRM files.



-   Select **USB**.
-   Select **Deactivation**.
-   Select **Yes**.
- 

PICTURE CONTROL

PICTURE SIZE (ASPECT RATIO) CONTROL

You can watch the screen in various picture formats; **16:9**, **Just Scan**, **Original**, **4:3**, **14:9**, **Zoom** and **Cinema Zoom**.

If a fixed image is displayed on the screen for a long time, that fixed image may become imprinted on the screen and remain visible.

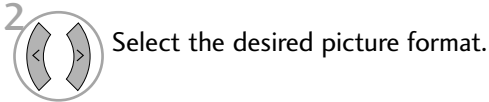

- You can also adjust **Aspect Ratio** in the **PICTURE** menu.
- For Zoom Setting, select **14:9**, **Zoom** and **Cinema Zoom** in Q.Menu or select **Cinema Zoom** in PICTURE menu.

• 16:9

The following selection will allow you to adjust the picture horizontally, in linear proportion, to fill the entire screen (useful for viewing 4:3 formatted DVDs).



• Original

When your TV receives a wide screen signal it will automatically change to the picture format broadcast.

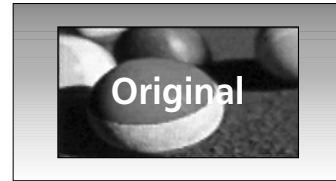

• Just Scan

Following Selection will lead to you view the picture of best quality without loss of original picture in high resolution image.

Note : If there is noise in original Picture, You can see the noise at the edge.



• 4:3

The following selection will allow you to view a picture with an original 4:3 aspect ration, black bars will appear on both the left and right of the screen.



- **14:9**

You can view a picture format of 14:9 or a general TV programme in the 14:9 mode. The 14:9 screen is viewed in the same way as in 4:3, but is magnified to the left and right.



- **Zoom**

The following selection will allow you to view the picture without any alteration, while filling the entire screen. However, the top and bottom of the picture will be cropped.



- **Cinema Zoom**

Choose Cinema Zoom when you wish the picture to be altered, both horizontally extended and vertically cropped. The picture adopting a compromise between alteration and screen coverage.

The adjustment range is 1-16.



! NOTE

- ▶ You can only select **4:3**, **16:9 (Wide)**, **14:9**, **Zoom**, **Cinema Zoom** in Component, HDMI mode.
- ▶ You can only select **4:3**, **16:9 (Wide)** in RGB mode only.
- ▶ In HDMI/Component (over 720p) mode, **Just Scan** is available.

PICTURE CONTROL





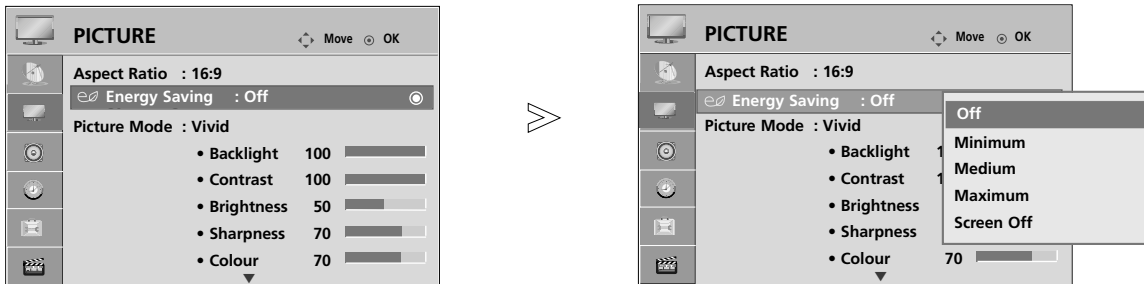

e ENERGY SAVING

It reduces the TV's power consumption by adjusting backlight level.

The default factory setting complies with the Energy Star requirements and is adjusted to the comfortable level to be viewed at home.

You can increase the brightness of your screen by adjusting the Energy Saving level or by setting the Picture Mode.



- 1   Select **PICTURE**.
- 2   Select **e Energy Saving**.
- 3   Select **Off, Minimum, Medium, Maximum or Screen Off**.
- 4  Save.

- Press the **MENU** button to return to normal TV viewing.
- Press the **RETURN** button to move to the previous menu screen.





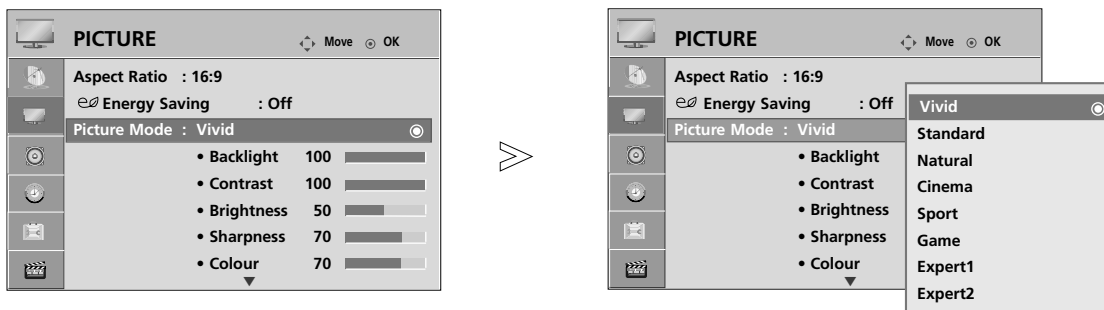

- When selecting Screen Off, the screen will be turned off after 3 seconds. In this case, if you want turn the screen on, press any key on the set or the remote control.
- If you adjust “**Energy Saving-Minimum, Medium, Maximum**”, **Backlight** feature will not work.
- You can also adjust **Energy Saving** button.

PRESET PICTURE SETTINGS

Picture Mode-Preset

- Vivid** Strengthen the contrast, brightness, colour and sharpness for vivid picture.
- Standard** The most general and natural screen display status.
- Natural** The most natural screen display status.
- Cinema** Optimizes video for watching movies.
- Sport** Optimizes video for watching sports events.
- Game** Optimizes video for playing games.



- 1   Select **PICTURE**.
- 2   Select **Picture Mode**.
- 3   Select **Vivid, Standard, Natural, Cinema, Sport or Game**.

- **Picture Mode** adjusts the TV for the best picture appearance. Select the preset value in the **Picture Mode** menu based on the programme category.
- You can also adjust **Picture Mode** in the **Q. Menu**.

- Press the **MENU** button to return to normal TV viewing.
- Press the **RETURN** button to move to the previous menu screen.

PICTURE CONTROL

MANUAL PICTURE ADJUSTMENT

Picture Mode-User option

- **Backlight**

To control the brightness of the screen, adjust the brightness of LCD panel.

Adjusting the backlight when setting the brightness of the set is recommended.

- **Contrast**

Adjusts the difference between light and dark levels in the picture. You may use Contrast when the bright part of the picture is saturated.

- **Brightness**

Increases or decreases the amount of white in the picture.

- **Sharpness**

Adjusts the level of crispness in the edges between the light and dark areas of the picture.

The lower the level, the softer the image.

- **Colour**

Adjusts intensity of all colours.

- **Tint**

Adjusts the balance between red and green levels.

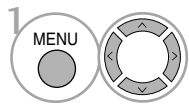
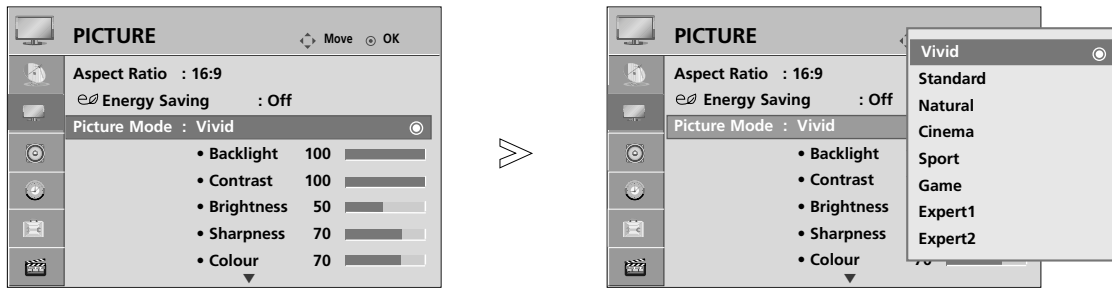

Select **PICTURE**.

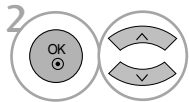

Select **Picture Mode**.

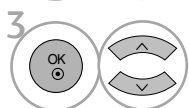

Select **Vivid, Standard, Natural, Cinema, Sport or Game**.

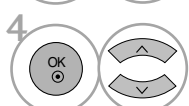

Select **Backlight, Contrast, Brightness, Sharpness, Colour or Tint**.



Make appropriate adjustments.

- **Benefits of using Backlight**

- The electricity consumption is reduced by up to 60%.
- The black brightness is reduced. (As the black has greater depth, you can enjoy a better quality definition.)
- You can adjust brightness with maintaining original signal resolution.

- Press the **MENU** button to return to normal TV viewing.

- Press the **RETURN** button to move to the previous menu screen.

NOTE

▶ You cannot adjust colour, sharpness and tint in the RGB-PC mode.





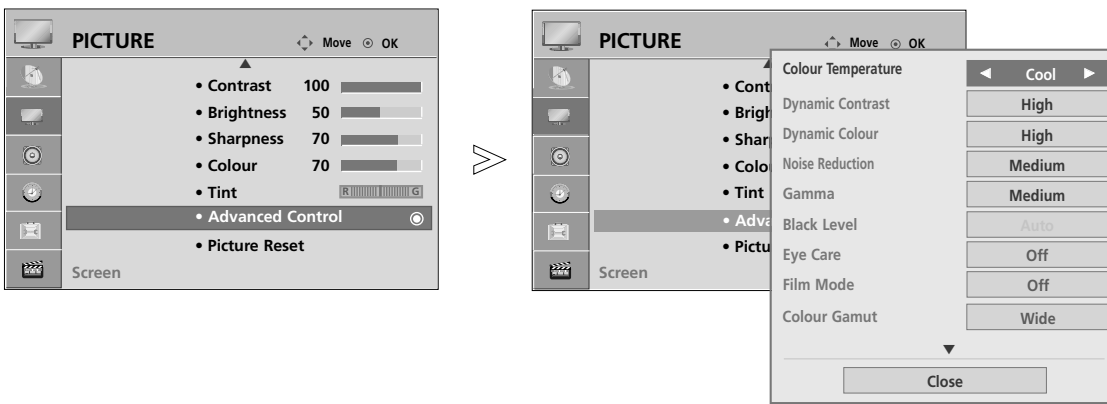

PICTURE IMPROVEMENT TECHNOLOGY

You can calibrate the screen for each Picture Mode or set the video value according to the special video screen. you can set the video value differently for each input.

To reset to the factory default screen after making adjustment to each video mode, execute the “Reset” function for each Picture Mode.

■ Here shown may be somewhat different from your TV.



- 1   Select **PICTURE**.
- 2   Select **Advanced Control**.
- 3   Select **Colour Temperature, Dynamic Contrast, Dynamic Colour, Noise Reduction, Gamma, Black Level, Eye Care, Film Mode, Colour Gamut or Edge Enhancer. (Refer to p.67 to 68)**
- 4  Select your desired Source.

- Press the **MENU** button to return to normal TV viewing.
- Press the **RETURN** button to move to the previous menu screen.





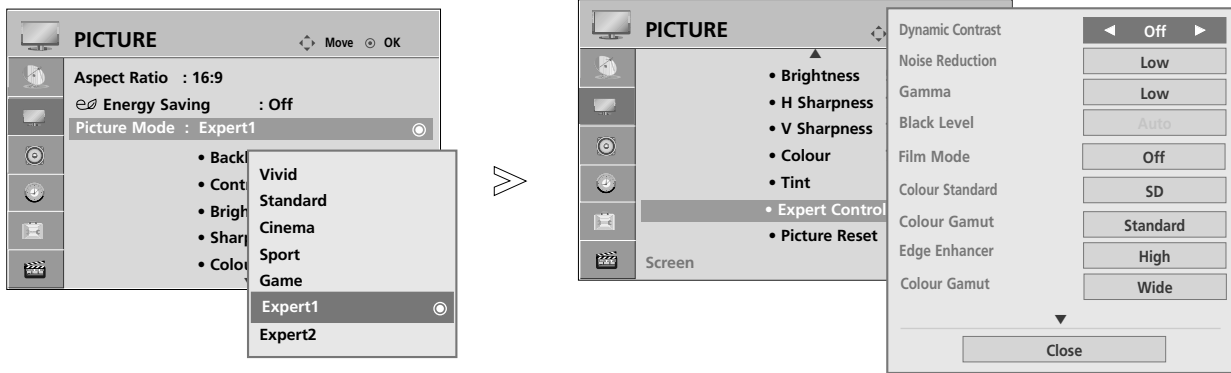

PICTURE CONTROL

EXPERT PICTURE CONTROL

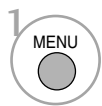
By segmenting categories, Expert1 and Expert2 provide more categories which users can set as they see fit, offering the optimal picture quality for users.

As the detail item for video quality experts to adjust the video precisely using specific videos, this may not be effective for general videos.

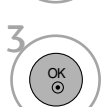
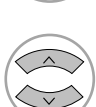
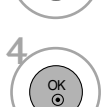
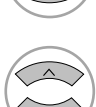
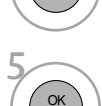
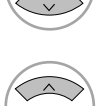

-   Select **PICTURE**.
-   Select **Picture Mode**.
-   Select **Expert1** or **Expert2**.
-   Select **Expert Control**.
-   Select your desired Source.
-  Make appropriate adjustments.

- Press the **MENU** button to return to normal TV viewing.
- Press the **RETURN** button to move to the previous menu screen.

*This feature is not available for all models.

Colour Temperature (Warm/Medium/Cool)	<ul style="list-style-type: none"> ■ Choose one of three automatic colour adjustments. Set to warm to enhance hotter colours such as red, or set to cool to make picture bluish.
Dynamic Contrast (Off/Low/Medium/High)	<ul style="list-style-type: none"> ■ Adjusts the contrast to keep it at the best level according to the brightness of the screen. The picture is improved by making bright parts brighter and dark parts darker.
Dynamic Colour (Off/Low/High)	<ul style="list-style-type: none"> ■ Adjusts screen colours so that they look livelier, richer and clearer. This feature enhances hue, saturation and luminance so that red, blue, green and white look more vivid.
Noise Reduction (Off/Low/Medium/High)	<ul style="list-style-type: none"> ■ Reduces screen noise without compromising video quality.
Gamma (Low/Medium/High)	<ul style="list-style-type: none"> ■ You can adjust brightness of dark area and middle gray level area of the picture. <ul style="list-style-type: none"> • Low : Make dark and middle gray level area of the picture brighter. • Medium: Express original picture levels. • High: Make dark and middle gray level area of the picture darker.
Black Level (Low/High)	<ul style="list-style-type: none"> • Low : The picture of the screen gets darker. • High : The picture of the screen gets brighter. • Auto : Realizing the black level of the screen and set it to High or Low automatically. ■ Set black level of the screen to proper level. ■ This function enables to select 'Low' or 'High' in the following mode: AV(NTSC-M), HDMI or Component. Otherwise, 'Black level' is set to 'Auto'.
Eye Care (On/Off)	<p>*This feature is not available for all models.</p> <ul style="list-style-type: none"> ■ Adjust the brightness of the screen to prevent the screen from being too bright. Dims extremely bright pictures. ■ This feature is disable in "Picture Mode-Vivid, Cinema".
Film Mode (On/Off)	<ul style="list-style-type: none"> ■ You can watch a cinema-like video by eliminating judder effect. ■ Use this function when you watch movies. ■ This function can work when TruMotion is off.

PICTURE CONTROL

<p>Colour Gamut (Wide/Standard)</p>	<ul style="list-style-type: none"> • Standard : Mode to reproduce original colour according to the standard of input signal independent of the display characteristics. • Wide: Mode to use and set the rich colour area of the display. <ul style="list-style-type: none"> ■ Maximize the utilization for colour area that can be expressed.
<p>Edge Enhancer (Off/Low/High)</p>	<ul style="list-style-type: none"> ■ Shows clearer and distinctive yet natural corners of the video.
<p>Colour Standard (SD/HD)</p>	<ul style="list-style-type: none"> ■ Converts the colour of a different video to HD colour. This function is set for SD video (BT-601) and HD video (BT-709) colour format. ■ This feature is enabled in "Picture Mode - Expert1/2".
<p>Colour Filter (Off/Red/Green/Blue)</p>	<ul style="list-style-type: none"> ■ This is the function to filter the specific colours of the video. You can use the RGB filter to set colour saturation and hue accurately. ■ This feature is enabled in "Picture Mode - Expert1/2".
<p>White Balance (Medium/Warm/Cool)</p>	<ul style="list-style-type: none"> ■ This is the function to adjust the overall colour of the screen to the feeling you want. <ul style="list-style-type: none"> • Red/Green/Blue Contrast, Red/Green/Blue Brightness: The adjustment range is -50 to +50. ■ This feature is enabled in "Picture Mode - Expert1/2".
<p>Colour Management System</p>	<ul style="list-style-type: none"> ■ As the tool used by the experts to make adjustments by using the test patterns, this does not affect other colours but can be used to selectively adjust the 6 colour areas (Red/Green/Blue/Cyan/Magenta/Yellow). Colour difference may not be distinctive even when you make the adjustments for the general video. ■ Adjusts Red/Green/Blue/Yellow/Cyan/Magenta. • Red/Green/Blue/Yellow/Cyan, Magenta Colour : The adjustment range is -30 to +30. • Red/Green/Blue/Yellow/Cyan/Magenta Tint : The adjustment range is -30 to +30. ■ This feature is disable in RGB-PC mode. ■ This feature is enabled in "Picture Mode - Expert1/2".

PICTURE RESET

Settings of the selected picture modes return to the default factory settings.

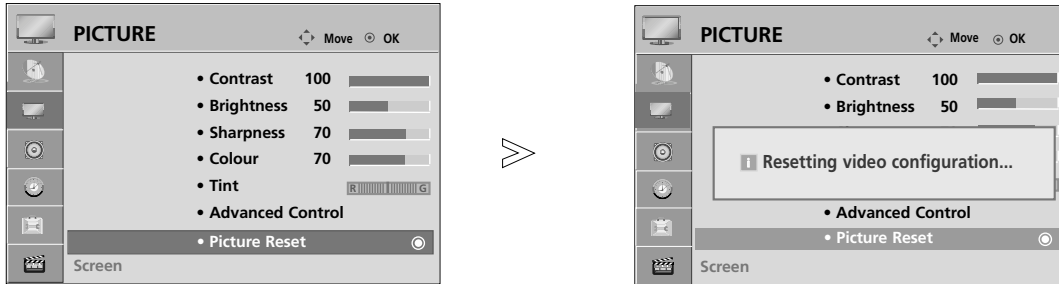

1 Select **PICTURE**.

2 Select **Picture Reset**.

3 Initialize the adjusted value.

- Press the **MENU** button to return to normal TV viewing.
- Press the **RETURN** button to move to the previous menu screen.

POWER INDICATOR

It helps you adjust the brightness of moving LED and sound when power is turned on.

Standby Light

Determines whether to set the indicator light on the front of the TV to **On** or **Off** in standby mode.

Power Light

Determines whether to set the indicator light on the front of the TV to **On** or **Off** when the power turns on.

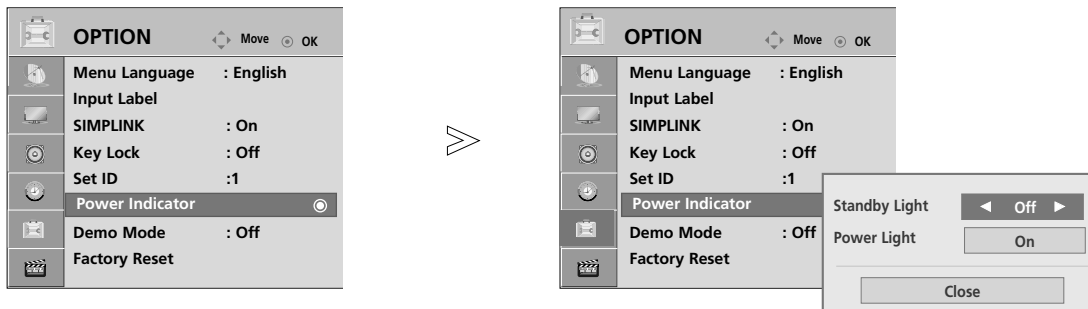

1 Select **OPTION**.

2 Select **Power Indicator**.

3 Select **Standby Light** or **Power Light**.

4 Select your desired Source.







- Press the **MENU** button to return to normal TV viewing.
- Press the **RETURN** button to move to the previous menu screen.

PICTURE CONTROL

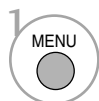
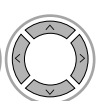
DEMO MODE

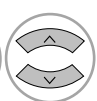
Display the slide show to explain the various logo of this TV.
The screen is reset automatically after 5 minutes in Demo Mode.

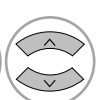
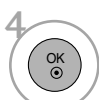

-   Select **OPTION**.
-   Select **Demo Mode**.
-   Select **On** to show the various logo of TV.
-  Return to TV viewing.
If you want to stop the demo, press any button.
(except MUTE,  + , - button)

- Press the **MENU** button to return to normal TV viewing.
- Press the **RETURN** button to move to the previous menu screen.





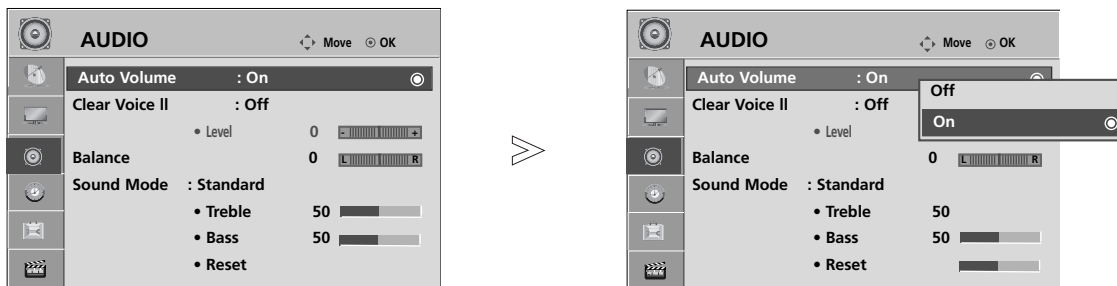

SOUND & LANGUAGE CONTROL

AUTO VOLUME LEVELER

Auto volume automatically remains on the same level of volume if you change programmes.

Because each broadcasting station has its own signal conditions, volume adjustment may be needed every time the channel is changed. This feature allows users to enjoy stable volume levels by making automatic adjustments for each programme.



- 1   Select **AUDIO**.
- 2   Select **Auto Volume**.
- 3   Select **On** or **Off**.

- Press the **MENU** button to return to normal TV viewing.
- Press the **RETURN** button to move to the previous menu screen.

SOUND & LANGUAGE CONTROL

PRESET SOUND SETTINGS-SOUND MODE





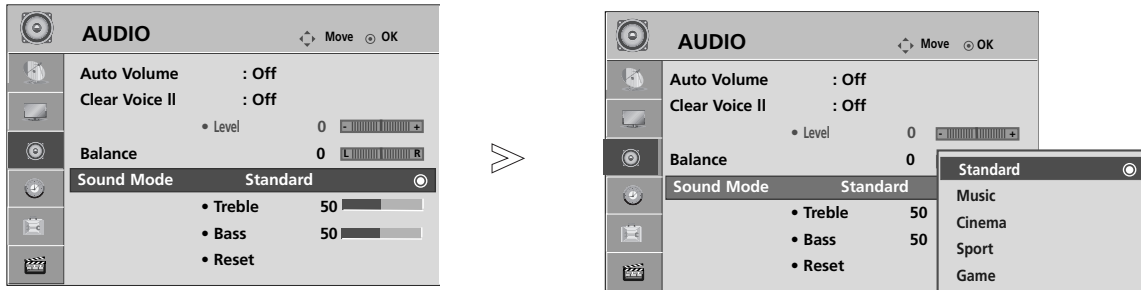

You can select your preferred sound setting; Standard, Music, Cinema, Sport or Game and you can also adjust the frequency of the equalizer.

Sound Mode lets you enjoy the best sound without any Special adjustment as the TV sets the appropriate sound options based on the programme content.

Standard, Music, Cinema, Sport and Game are preset for optimum sound quality at the factory.

- Standard** Offers standard-quality sound.
- Music** Optimizes sound for listening to music.
- Cinema** Optimizes sound for watching movies.
- Sport** Optimizes sound for watching sports events.
- Game** Optimizes sound for playing games.

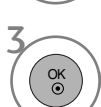

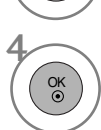





- 1   Select **AUDIO**.
- 2   Select **Sound Mode**.
- 3   Select **Standard, Music, Cinema, Sport** or **Game**.
- 4 

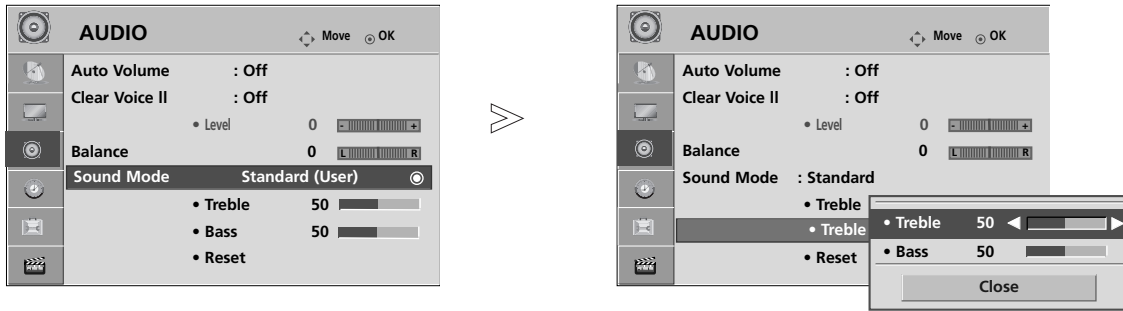



• You can also adjust **Sound Mode** in the **Q. Menu**.

- Press the **MENU** button to return to normal TV viewing.
- Press the **RETURN** button to move to the previous menu screen.

SOUND SETTING ADJUSTMENT -USER MODE



- 1   Select **AUDIO**.
- 2   Select **Sound Mode**.
- 3   Select **Standard, Music, Cinema, Sport or Game**.

- 4   Select **Treble, Bass**.
- 5   Make appropriate adjustments.
- 6 





- Press the **MENU** button to return to normal TV viewing.
- Press the **RETURN** button to move to the previous menu screen.

SOUND & LANGUAGE CONTROL

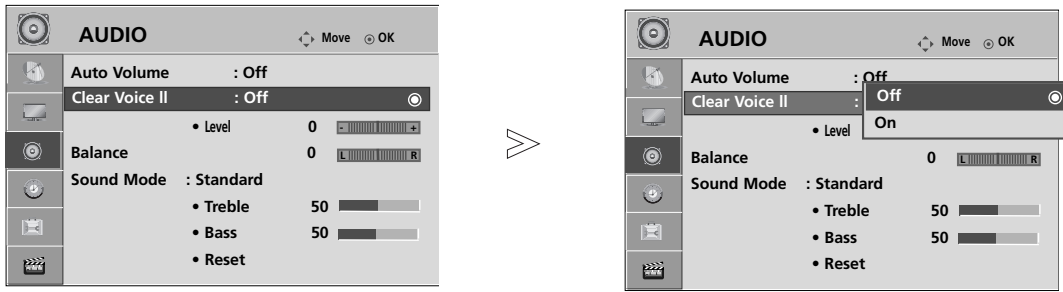

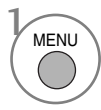
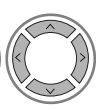
CLEAR VOICE II

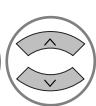
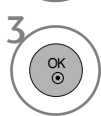
By differentiating the human sound range from others, it helps users listen to human voices better.

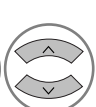

- 1   Select **AUDIO**.
- 2   Select **Clear Voice II**.
- 3   Select **On** or **Off**.

Adjustment for Clear Voice Level With selecting On

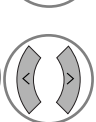
- 4   Select **Level**.
- 5   Make appropriate adjustments.

• Select levels from '-6' to '+6'.

- Press the **MENU** button to return to normal TV viewing.
- Press the **RETURN** button to move to the previous menu screen.

BALANCE

You can adjust the sound balance of the speakers to preferred levels.

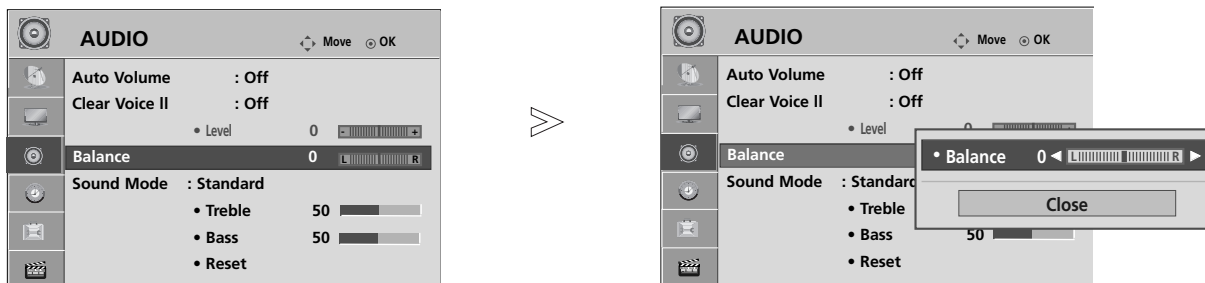

- 1   Select **AUDIO**.
- 2   Select **Balance**.
- 3   Make desired adjustment.





- Press the **MENU** button to return to normal TV viewing.
- Press the **RETURN** button to move to the previous menu screen.

SOUND & LANGUAGE CONTROL

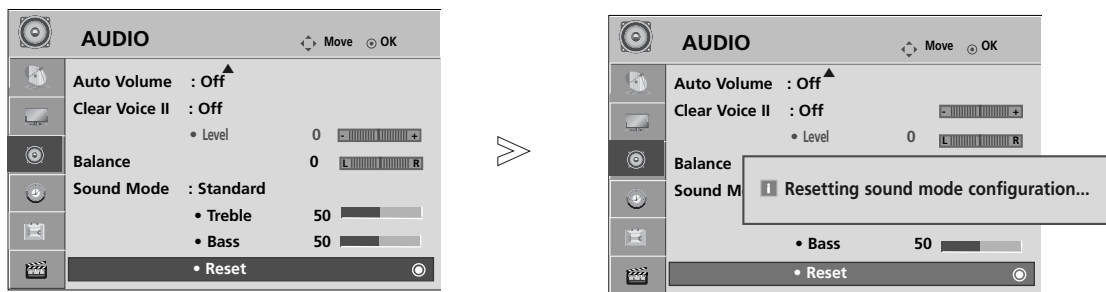
AUDIO RESET

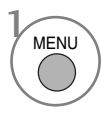
Settings of the selected Sound Mode return to the default factory settings.

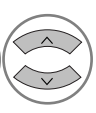

- 1   Select **AUDIO**.
- 2   Select **Reset**.
- 3  Initialize the adjusted value.

- Press the **MENU** button to return to normal TV viewing.
- Press the **RETURN** button to move to the previous menu screen.

Stereo/Dual Reception

When a programme is selected, the sound information for the station appears with the programme number and station name.

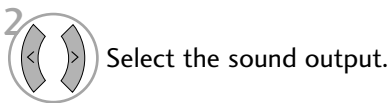

Broadcast	On Screen Display
Mono	MONO
Stereo	STEREO
Dual	DUAL I, DUAL II, DUAL I+II

■ Mono sound selection

If the stereo signal is weak in stereo reception, you can switch to mono. In mono reception, the clarity of sound is improved.

■ Language selection for dual language broadcast

If a programme can be received in two languages (dual language), you can switch to DUAL I, DUAL II or DUAL I+II.

- DUAL I Sends the primary broadcast language to the loudspeakers.
- DUAL II Sends the secondary broadcast language to the loudspeakers.
- DUAL I+II Sends a separate language to each loudspeaker.

SOUND & LANGUAGE CONTROL

NICAM Reception

If the TV is equipped with a receiver for NICAM reception, high quality NICAM (Near Instantaneous Companding Audio Multiplex) digital sound can be received.

Sound output can be selected according to the type of broadcast received.

-
- 1 When **NICAM mono** is received, you can select **NICAM MONO** or **FM MONO**.
 - 2 When **NICAM stereo** is received, you can select **NICAM STEREO** or **FM MONO**.
If the stereo signal is weak, switch to **FM MONO**.
 - 3 When **NICAM dual** is received, you can select **NICAM DUAL I**, **NICAM DUAL II** or **NICAM DUAL I+II** or **FM MONO**.
-

Speaker Sound Output Selection

In AV, Component, RGB and HDMI mode, you can select output sound for the left and right loudspeakers.

Select the sound output.

L+R: Audio signal from audio L input is sent to the left loudspeaker and audio signal from audio R input is sent to the right loudspeaker.

L+L: Audio signal from audio L input is sent to left and right loudspeakers.

R+R: Audio signal from audio R input is sent to left and right loudspeakers.

ON-SCREEN MENU LANGUAGE SELECTION

The installation setup menu appears on the TV screen when it is switched on for the first time.



* If you want to change Language selection

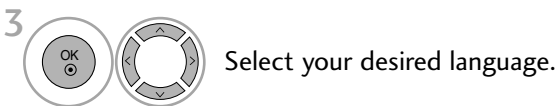

- Press the **MENU** button to return to normal TV viewing.
- Press the **RETURN** button to move to the previous menu screen.

! NOTE





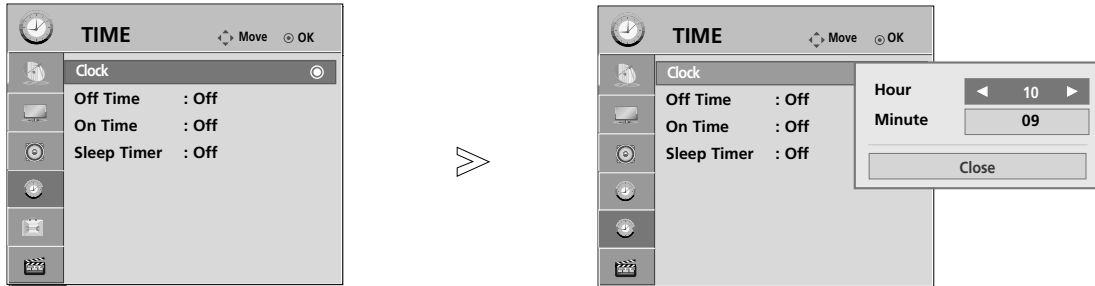

- ▶ If you do not finish the set-up **Installation Setup** by pressing **RETURN** or if you time out on the OSD (On Screen Display) the installation menu will continuously appear until the set up is completed whenever the TV is switched on.

TIME SETTING

CLOCK SETUP

You must set the time correctly before using on/off timer function.
If current time setting is erased by a power failure or the TV is unplugged, reset the clock.



-   Select **TIME**.
-   Select **Clock**.
-   Select either the Hour or Minute option.
-  Set the Hour or Minute options.

- Press the **MENU** button to return to normal TV viewing.
- Press the **RETURN** button to move to the previous menu screen.

AUTO ON/OFF TIMER SETTING

The Off time function automatically switches the TV to standby at a preset time.

Two hours after the TV is switched on by the on time function it will automatically switch back to standby mode unless a button has been pressed.

The Off time function overrides the On time function if both are set to the same time.

The TV must be in standby mode for the On time to work.

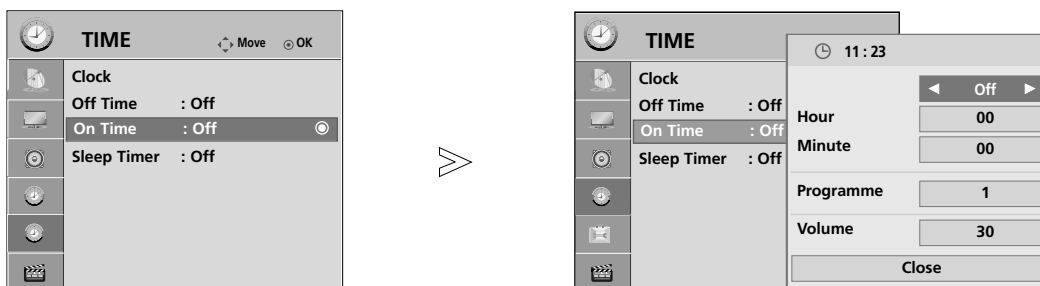

1   Select **TIME**.

2   Select **Off Time** or **On Time**.

When the **On Time** is selected,

3   Select **Hour**, **Minute**, **Programme** or **Volume**.

4  Set the Hour, Minute, Programme, Volume.

- Press the **MENU** button to return to normal TV viewing.
- Press the **RETURN** button to move to the previous menu screen.

TIME SETTING

SLEEP TIMER SETTING

You do not have to remember to switch the TV off before you go to sleep.
The sleep timer automatically switches the TV to standby after the preset time has elapsed.

1   Select **Sleep Timer**.

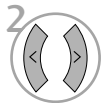
2  Select **Off, 10, 20, 30, 60, 90, 120, 180 or 240 Min.**

- When you switch the TV off, the preset sleep timer is cancelled.
- You can also adjust **Sleep Timer** in the **TIME** menu.

TELETEXT

This feature is not available in all countries.

Teletext is a free service broadcast by most TV stations which gives up-to-the-minute information on news, weather, television programmes, share prices and many other topics.

The teletext decoder of this TV can support the SIMPLE, TOP and FASTEXT systems. SIMPLE (standard teletext) consists of a number of pages which are selected by directly entering the corresponding page number. TOP and FASTEXT are more modern methods allowing quick and easy selection of teletext information.

SWITCH ON/OFF

Press the **TEXT** button to switch to teletext. The initial page or last page viewed appears on the screen.

Two page numbers, TV station name, date and time are displayed on the screen headline. The first page number indicates your selection, while the second shows the current page displayed.

Press the **TEXT** button to switch off teletext. The previous mode reappears.



SIMPLE TEXT

■ Page selection

- 1 Enter the desired page number as a three digit number with the NUMBER buttons. If during selection you press a wrong number, you must complete the three digit number and then re-enter the correct page number.
- 2 The P ^ v button can be used to select the preceding or following page.

TOP TEXT

The user guide displays four fields-red, green, yellow and blue at the bottom of the screen. The yellow field denotes the next group and the blue field indicates the next block.

■ Block / group / page selection

- 1 With the blue button you can progress from block to block.
- 2 Use the yellow button to proceed to the next group with automatic overflow to the next block.
- 3 With the green button you can proceed to the next existing page with automatic overflow to the next group. Alternatively the P ^ button can be used.
- 4 The red button returns to the previous selection. Alternatively the P v button can be used.

■ Direct page selection

As with SIMPLE teletext mode, you can select a page by entering it as a three digit number using the NUMBER buttons in TOP mode.

TELETEXT

FASTEXT

The teletext pages are colour coded along the bottom of the screen and are selected by pressing the corresponding coloured button.

■ Page selection

- 1 Press the **T.OPT** button and then use $\wedge \vee$ button to select  menu. Display the index page.
- 2 You can select the pages which are colour coded along the bottom line with corresponding coloured buttons.
- 3 AS with SIMPLE teletext mode, you can select a page by entering its three digit page number with the NUMBER buttons in FASTEXT mode.
- 4 The **P** $\wedge \vee$ button can be used to select the preceding or following page.

SPECIAL TELETEXT FUNCTIONS

- Press the **T. OPT** button and then use $\wedge \vee$ button to select the **Text Option** menu.



■ Index

Select the each index page.



■ Time

When viewing a TV programme, press this button to display the time at the top right hand corner of the screen. Press this button again to remove the display. In the teletext mode, press this button to select a sub page number. The sub page number is displayed at the bottom of the screen. To hold or change the sub page, press the RED/GREEN, **P** \wedge / \vee or NUMBER buttons.

Press again to exit this function.



■ Hold

Stops the automatic page change which will occur if a teletext page consists of 2 or more sub pages. The number of sub pages and the sub page displayed is, usually, shown on the screen below the time. When this button is pressed the stop symbol is displayed at the top left-hand corner of the screen and the automatic page change is inactive. To continue press this button again.



■ Reveal

Press this button to display concealed information, such as solutions to riddles or puzzles.

Press this button again to remove the information from the display.



■ Update

Displays the TV picture on the screen while waiting for a new teletext page. The display will appear at the top left hand corner of the screen. When the updated page is available then display will change to the page number. Press this button again to view the updated teletext page.

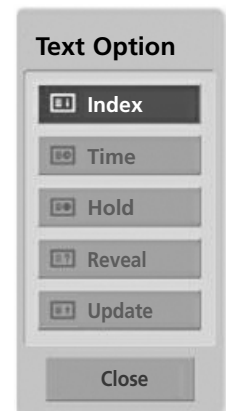

APPENDIX

TROUBLESHOOTING

The TV does not operate properly.

The remote control does not work

- Check to see if there is any object between the TV and the remote control causing an obstruction. Ensure you are pointing the remote control directly at the TV.
- Ensure that the batteries are installed with correct polarity (+ to +, - to -).
- Install new batteries.

Power is suddenly turned off

- Is the sleep timer set?
- Check the power control settings. Has the Power supply been interrupted.
- The TV goes into Standby mode automatically if no signal is received or no operation is performed for 15 minutes.

The video function does not work.

No picture & No sound

- Check whether the TV is switched on.
- Try another channel. The problem may be with the broadcast.
- Is the power cord inserted correctly into the mains?
- Check your antenna direction and/or location.
- Test the mains outlet by plugging another TV into the same outlet.

Picture appears slowly after switching on

- This is normal, the image is muted during the TV startup process. Please contact your service centre, if the picture has not appeared after five minutes.

No or poor colour or poor picture

- Adjust Colour in menu option.
- Allow a sufficient distance between the TV and the VCR.
- Try another channel. The problem may be with the broadcast.
- Are the video cables installed properly?
- Activate any function to restore the brightness of the picture.

Horizontal/vertical bars or picture shaking

- Check for local interference such as an electrical appliance or power tool.

Poor reception on some channels

- Station or cable channel experiencing problems, tune to another station.
- Station signal is weak, reposition the antenna to receive weaker stations.
- Check for sources of possible interference.

Lines or streaks in pictures

- Check antenna (Change the position of the antenna).

No picture when connecting HDMI

- Check that your HDMI cable is High Speed HDMI cable. If the HDMI cables are not High Speed HDMI cable, flickering or no screen display can result. Please use the High Speed HDMI cable.

APPENDIX

The audio function does not work.

Picture OK & No sound

- Press the  + or - button.
- Sound muted? Press **MUTE** button.
- Try another channel. The problem may be with the broadcast.
- Are the audio cables installed properly?

No output from one of the speakers

- Adjust **Balance** in menu option.

Unusual sound from inside the TV

- A change in ambient humidity or temperature may result in an unusual noise when the TV is switched on or off and does not indicate a fault with the TV.

No sound when connecting HDMI

- Check HDMI cable is High Speed HDMI cable.

*This feature is not available for all models.

There is a problem in PC mode. (Only PC mode applied)

The signal is out of range (Invalid format)

- Adjust resolution, horizontal frequency, or vertical frequency.
- Check the input source.

Vertical bar or stripe on background & Horizontal Noise & Incorrect position

- Use Auto configure or adjust clock, phase, or H/V position. (Option)

Screen colour is unstable or single colour

- Check the signal cable.
- Reinstall the PC video card.

MAINTENANCE

Early malfunctions can be prevented. Careful and regular cleaning can prolong the life of your new TV.

Caution: Be sure to switch the power off and unplug the power cord before you begin any cleaning.

Cleaning the Screen

- 1 A good way to keep the dust off your screen for a while is to wet a soft cloth in a mixture of lukewarm water and a little fabric softener or dish washing detergent. Wring the cloth until it is almost dry, and then use it to wipe the screen.
- 2 Ensure there is no excess water on the screen. Allow any water or dampness to evaporate before switching on.

Cleaning the Cabinet

- To remove dirt or dust, wipe the cabinet with a soft, dry, lint-free cloth.
- Do not use a wet cloth.

Extended Absence

CAUTION

- ▶ If you expect to leave your TV dormant for prolonged periods (such as a holiday), unplug the power cord to protect against possible damage from lightning or power surges.

APPENDIX

PRODUCT SPECIFICATIONS

MODELS		26LH2***	32LH2***	37LH2***	42LH2***
		26LH200C - TA 26LH210C - TA 26LH220C - TA	32LH200C - TA 32LH210C - TA 32LH220C - TA 32LH220H - TA	37LH200C - TA 37LH210C - TA 37LH220C - TA 37LH220H - TA	42LH200C - TA 42LH210C - TA 42LH220C - TA 42LH220H - TA
Dimensions (Width x Height x Depth)	with stand	6670 mm x 504.0 mm x 224.0 mm	805.0 mm x 583.0 mm x 224.0 mm	922.0 mm x 659.0 mm x 297.0 mm	1028.0 mm x 715.4 mm x 297.0 mm
	without stand	6670 mm x 446.2 mm x 80.0 mm	805.0 mm x 528.0 mm x 79.9 mm	922.0 mm x 595 mm x 88.0 mm	1028.0 mm x 655.0 mm x 88.7 mm
Weight	with stand	8.9 kg	11.5 kg	14.8 kg	18.0 kg
	without stand	7.8 kg	10.3 kg	13.0 kg	16.2 kg
Power requirement		AC 100-240 V~ 50 / 60 Hz	AC 100-240 V~ 50 / 60 Hz	AC 100-240 V~ 50 / 60 Hz	AC 100-240 V~ 50 / 60 Hz
Television System		PAL/SECAM B/G/D/K, PAL I/II, NTSC-M			
Program Coverage		VHF: NZ1 to E21, UHF: E21 to E69, CATV: S1 to S20, HYPER: S21 to S47			
External Antenna Impedance		75 Ω			
Environment condition	Operating Temperature	0 to 40 °C			
	Operating Humidity	Less than 80%			
	Storage Temperature	-20 to 60 °C			
	Storage Humidity	Less than 85%			
Supported movie files		Refer to p. 55			

- The specifications shown above may be changed without prior notice for quality improvement.

IR CODES

Code (Hexa)	Function	Note
08	POWER	R/C BUTTON (POWER ON/OFF)
0B	INPUT	R/C BUTTON
79	RATIO	R/C BUTTON
45	Q.MENU	R/C BUTTON
43	MENU	R/C BUTTON
1E	MARK/FAV	R/C BUTTON
07	Left (<)	R/C BUTTON
06	Right (>)	R/C BUTTON
40	Up (^)	R/C BUTTON
41	Down (v)	R/C BUTTON
44	OK(●)	R/C BUTTON
28	RETURN	R/C BUTTON
95	Energy Saving	R/C BUTTON
30	AV MODE	R/C BUTTON
02	↖ +	R/C BUTTON
03	↖ -	R/C BUTTON
00	P ^ /PAGE ^	R/C BUTTON
01	P v /PAGE v	R/C BUTTON
09	MUTE	R/C BUTTON
10 to19	Number Key 0 to 9	R/C BUTTON
53	LIST	R/C BUTTON
1A	Q.VIEW	R/C BUTTON
72	RED Key	R/C BUTTON
71	GREEN Key	R/C BUTTON
63	YELLOW Key	R/C BUTTON
61	BLUE Key	R/C BUTTON
20	TEXT	R/C BUTTON
21	T.Option	R/C BUTTON
7E	SIMPLINK	R/C BUTTON
71	■ Stop	R/C BUTTON
63	▶ Play	R/C BUTTON
61	Pause	R/C BUTTON
21	◀◀ Rew	R/C BUTTON
8E	▶▶ FF	R/C BUTTON

APPENDIX

EXTERNAL CONTROL DEVICE SETUP

RS-232C Setup

Connect the RS-232C (serial port) input jack to an external control device (such as a computer or an A/V control system) to control the product's functions externally.

Connect the serial port of the control device to the RS-232C jack on the product back panel.

Note

- RS-232C connection cables are not supplied with the product.
- In USB mode, it doesn't support RS-232C function.

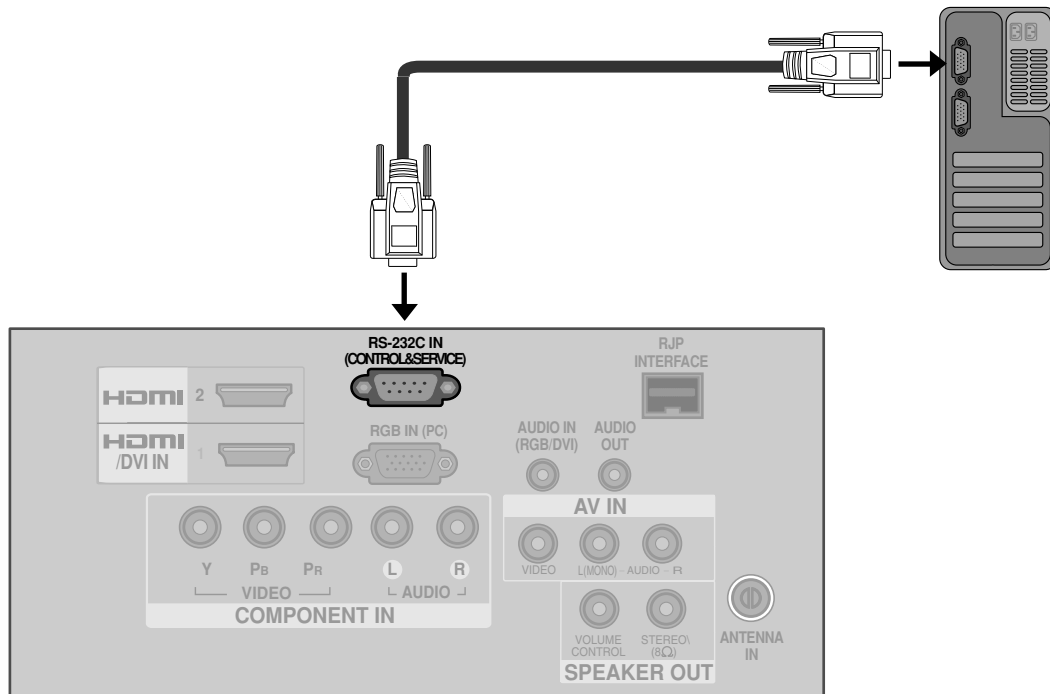

Type of Connector: D-Sub 9-Pin Male

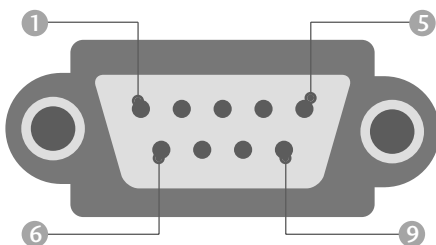







No.	Signal	Signal requirements
1	VCC	
2	RX RS232	Standard RS232 specification
3	TX RS232	Standard RS232 specification
4	IR from TV	
5	GND	Power ground
6, 8	Not connected	
7	+5V	1A 5VDC 10%, max 100mV ripple
9	+12V	1A 12VDC 10%, max 100mV ripple

Set ID

Use this function to specify a set ID number.
Refer to 'Real Data Mapping'. ▶ p.95



-   Select **OPTION**.
-   Select **Set ID**.
-   Adjust **Set ID** to choose the desired TV ID number.
The adjustment range of SET ID is 1 to 99.

- Press **RETURN** to move to the previous menu screen.

APPENDIX

Communication Parameters

- Baud rate : 9600 bps (UART)
- Data length : 8 bits
- Parity : None
- Stop bit : 1 bit
- Communication code : ASCII code
- Use a crossed (reverse) cable.

Command Reference List

	COMMAND1	COMMAND2	DATA (Hexadecimal)		COMMAND1	COMMAND2	DATA (Hexadecimal)
01. Power	k	a	00 to 01	13. Balance	k	t	00 to 64
02. Aspect Ratio	k	c	Refer to p.93	14. Colour Temperature	k	u	00 to 02
03. Screen Mute	k	d	Refer to p.93	15. Abnormal Status	k	z	FF
04. Volume Mute	k	e	00 to 01	16. Auto Configure	j	u	01
05. Volume Control	k	f	00 to 64	17. Channel Add/Del	m	b	00 to 01
06. Contrast	k	g	00 to 64	18. Key	m	c	Key Code
07. Brightness	k	h	00 to 64	19. Input select (Main)	x	b	Refer to p.95
08. Colour	k	i	00 to 64	20. Control Back Light	m	g	00 to 64
09. Tint	k	j	00 to 64	21. Energy Saving	j	q	Refer to p.95
10. Sharpness	k	k	00 to 64	22. Tune Command	m	a	Refer to p.96
11. OSD Select	k	l	00 to 01	23. Treble	k	r	00 to 64
12. Remote Control Lock /Key Lock Mode	k	m	00 to 01	24. Bass	k	s	00 to 64

Transmission / Receiving Protocol

Transmission

[Command1][Command2][][Set ID][][Data][Cr]

[Command 1] : First command to control the set.(j,k,m or x)

[Command 2] : Second command to control the set.

[Set ID] : You can adjust the set ID to choose desired TV ID number in Setup menu. Adjustment range is 1 to 99. When selecting Set ID '0', every connected TV is controlled. Set ID is indicated as decimal (1 to 99) on menu and as Hexa decimal (0x0 to 0x63) on transmission/receiving protocol.

[DATA] : To transmit command data.

Transmit 'FF' data to read status of command.

[Cr] : Carriage Return

ASCII code '0x0D'

[] : ASCII code 'space (0x20)'

OK Acknowledgement

[Command2][][Set ID][][OK][Data][x]

The TV transmits ACK (acknowledgement) based on this format when receiving normal data. At this time, if the data is data read mode, it indicates present status data. If the data is data write mode, it returns the data of the PC computer.

Error Acknowledgement

[Command2][][Set ID][][NG][Data][x]

TV transmits ACK(acknowledgement) based on this format when receiving abnormal data form non-viable functions or communication errors.

[Command 2] : use as command.

[Set ID]: use the small character, if set ID is 10, TV will send the '0', 'a'

[Data]: use the small character, if data is 0xab, TV will send the 'a', 'b'.

[NG]: use the large character.

01. Power (Command: k a)

To control Power On/Off of the TV.

Transmission [k][a][][Set ID][][Data][Cr]

Data 00 : Power Off Data 01 : Power On

Acknowledgement [a][][Set ID][][OK/NG][Data][x]

To show Power On/Off.

Transmission [k][a][][Set ID][][FF][Cr]

Acknowledgement [a][][Set ID][][OK/NG][Data][x]

* If there is the time delay between command and ack message during power on sequence, It should be described like "Note: In this model, TV will send the Acknowledge after power on processing completion. There might be a time delay between command and acknowledge."

02. Aspect Ratio (Command: k c) (Main picture size)

To adjust the screen format. (Main picture format)

You can adjust the screen format using the Aspect Ratio in the PICTURE menu.

Transmission [k][c][][Set ID][][Data][Cr]

Data 01: Normal screen (4:3) Data 07: 14:9
Data 02: Wide screen (16:9) Data 09: Just Scan
Data 04: Zoom Data 10 to 1f: Cinema Zoom
Data 06: Original

Acknowledgement [c][][Set ID][][OK/NG][Data][x]

* Using the RGB-PC, Component or HDMI input, you select either 16:9 or 4:3 screen aspect ratio.

* In HDMI/Component (over 720p) mode, **Just Scan** is available.

03. Screen Mute (Command: k d)

To select screen mute on/off.

Transmission [k][d][][Set ID][][Data][Cr]

Data 00 : Screen mute off (Picture on)
Data 01 : Screen mute on (Picture off)
Data 00 : Video Mute off
Data 10 : Video Mute on

Acknowledgement [d][][Set ID][][OK/NG][Data][x]

04. Volume Mute (Command: k e)

To control volume mute on/off.

You can also adjust mute using the MUTE button on remote control.

Transmission [k][e][][Set ID][][Data][Cr]

Data 00 : Volume mute on (Volume off)
Data 01 : Volume mute off (Volume on)

Acknowledgement [e][][Set ID][][OK/NG][Data][x]

05. Volume Control (Command: k f)

To adjust volume.

You can also adjust volume with the volume buttons on remote control.

Transmission [k][f][][Set ID][][Data][Cr]

Data Min : 00 to Max : 64

Refer to 'Real data mapping 1'. See page 95.

Acknowledgement [f][][Set ID][][OK/NG][Data][x]

06. Contrast (Command: k g)

To adjust screen contrast.

You can also adjust contrast in the PICTURE menu.

Transmission [k][g][][Set ID][][Data][Cr]

Data Min : 00 to Max : 64

Refer to 'Real data mapping 1'. See page 95.

Acknowledgement [g][][Set ID][][OK][Data][x]

07. Brightness (Command: k h)

To adjust screen brightness.

You can also adjust brightness in the PICTURE menu.

Transmission [k][h][][Set ID][][Data][Cr]

Data Min : 00 to Max : 64

Refer to 'Real data mapping 1'. See page 95.

Acknowledgement [h][][Set ID][][OK/NG][Data][x]

08. Colour (Command: k i)

To adjust the screen colour.

You can also adjust colour in the PICTURE menu.

Transmission [k][i][][Set ID][][Data][Cr]

Data Min : 00 to Max : 64

Refer to 'Real data mapping 1'. See page 95.

Acknowledgement [i][][Set ID][][OK/NG][Data][x]

09. Tint (Command: k j)

To adjust the screen tint.

You can also adjust tint in the PICTURE menu.

Transmission [k][j][][Set ID][][Data][Cr]

Data Red : 00 to Green : 64

Refer to 'Real data mapping 1'. See page 95.

Acknowledgement [j][][Set ID][][OK/NG][Data][x]

APPENDIX

10. Sharpness (Command: k k)

To adjust the screen sharpness.

You can also adjust sharpness in the PICTURE menu.

Transmission [k][k][][Set ID][][Data][Cr]

Data Min: 00 to Max: 64

Refer to 'Real data mapping 1'. See page 95.

Acknowledgement [k][][Set ID][][OK/NG][Data][x]

11. OSD Select (Command: k l)

To select OSD (On Screen Display) on/off when controlling remotely.

Transmission [k][l][][Set ID][][Data][Cr]

Data 00: OSD off

Data 01: OSD on

Acknowledgement [l][][Set ID][][OK][Data][x]

12. Remote Control Lock/Key Lock Mode (Command: k m)

To lock the remote control and the front panel controls on the set.

Transmission [k][m][][Set ID][][Data][Cr]

Data 00: Lock off

Data 01: Lock on

Acknowledgement [m][][Set ID][][OK/NG][Data][x]

* When main power is on/off, remote control lock is released.

* In the standby mode, if key lock is on, TV will not turn on by power on key of IR & Local Key.

13. Balance (Command: k t)

To adjust balance.

You can also adjust balance in the AUDIO menu.

Transmission [k][t][][Set ID][][Data][Cr]

Data Min: 00 to Max: 64

Refer to 'Real data mapping 1'. See page 95.

Acknowledgement [t][][Set ID][][OK/NG][Data][x]

14. Colour Temperature (Command: k u)

To adjust colour temperature.

You can also adjust Colour Temperature in the PICTURE menu.

Transmission [k][u][][Set ID][][Data][Cr]

Data 00: Medium 01: Cool 02: Warm

Acknowledgement [u][][Set ID][][OK/NG][Data][x]

15. Abnormal State (Command: k z)

To recognize an abnormal state.

Transmission [k][z][][Set ID][][FF][][Cr]

Data FF: Read

Acknowledgement [z][][Set ID][][OK/NG][Data][x]

Data 00: Normal (Power on and signal exist)

Data 01: No signal (Power on)

Data 02: Turn the TV off by remote control

Data 03: Turn the TV off by sleep time function

Data 04: Turn the TV off by RS-232C function

Data 05: 5V down

Data 06: AC down

Data 07: Turn the TV off by Fan Alarm function (option)

Data 08: Turn the TV off by Off time function

Data 09: Turn the TV off by Auto off function

Data a: Turn the TV off by AV board detection.

* This function is "read only".

16. Auto Configure (Command: j u)

To adjust picture position and minimize image shaking automatically. It works only in RGB (PC) mode.

Transmission [j][u][][Set ID][][Data][Cr]

Data 01: To set

Acknowledgement [u][][Set ID][][OK/NG][Data][x]

17. Channel Skip (Command: m b)

To set skip status for the current Programme.

Transmission [m][b][][Set ID][][Data][Cr]

Data 00 : Skip

01 : Add

Acknowledgement [b][][Set ID][][OK/NG][Data][x]

18. Key (Command: m c)

To send IR remote key code.

Transmission [m][c][][Set ID][][Data][Cr]

Data: Key code - Refer to page 89.

Acknowledgement [c][][Set ID][][OK/NG][Data][x]

19. Input select (Command: x b)
(Main Picture Input)

To select input source for TV.

Transmission [x][b][][Set ID][][Data][Cr]

Data: Structure

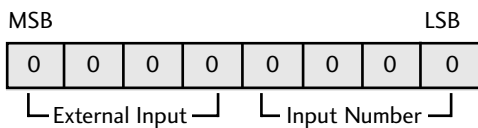

External Input				Data
0	0	0	1	Analog
0	0	1	0	AV
0	1	0	0	Component
0	1	1	0	RGB-PC
1	0	0	1	HDMI

Input Number				Data
0	0	0	0	Input1
0	0	0	1	Input2
0	0	1	0	Input3
0	0	1	1	Input4

Acknowledgement [b][][Set ID][][OK/NG][Data][x]

20. Control Back Light (Command: m g)

To Control the back light.

Transmission [m][g][][Set ID][][Data][Cr]

Data : data Min: 00 to Max: 64
 (* transmit by Hexadecimal code)

Acknowledgement [g][][Set ID][][OK/NG][Data][x]

21. Energy Saving (Command: j q)

To reduce the power consumption of the TV. You can also adjust Energy Saving in OPTION menu.

Transmission [j][q][][Set ID][][Data][Cr]

Data Min: 00H to Max: 05H

Data 00 : Off
 01 : Minimum
 02 : Medium
 03 : Maximum
 05 : Screen Off

Acknowledgement [q][][Set ID][][OK/NG][Data][x]

*** Real data mapping 1**

- 00 : Step 0
- ⋮
- A : Step 10
- ⋮
- F : Step 15
- 10 : Step 16
- ⋮
- 64 : Step 100
- ⋮
- 6E : Step 110
- ⋮
- 73 : Step 115
- 74 : Step 116
- ⋮
- C7 : Step 199
- ⋮
- FE : Step 254
- FF : Step 255

APPENDIX

22 . Tune Command / Channel Tuning (Command: m a)

Tune Channel to following Physical number.

```
Transmission [m][a][ ][Set ID][ ][Data0][ ][Data1]
[ ][Data2][Cr]
```

Data0 : 00

Data1: Min: 00 to Max: C7

* Refer to 'Real data mapping 1' See page 95.

Data2: 00

```
Acknowledgement [a][ ][Set ID][OK][ ][Data0][Data1][x]
[a][ ][Set ID][NG][ ][Data0][x]
```

23. Treble (Command: k r)

To adjust treble.

You can also adjust treble in the AUDIO menu.

```
Transmission [k][r][ ][Set ID][ ][Data][Cr]
```

Data Min : 00 to Max : 64

* Refer to 'Real data mapping 1' See page 95.

```
Acknowledgement [r][ ][Set ID][ ][OK/NG][Data][x]
```

24. Bass (Command: k s)

To adjust bass.

You can also adjust bass in the AUDIO menu.

```
Transmission [k][s][ ][Set ID][ ][Data][Cr]
```

Data Min : 00 to Max : 64

* Refer to 'Real data mapping 1' See page 95.

```
Acknowledgement [s][ ][Set ID][ ][OK/NG][Data][x]
```



Record the model number and serial number of the TV.

Refer to the label on the back cover and quote this information to your dealer when requiring any service.

Model : _____

Serial No. : _____