



**MDD64 (MDD64-A0U, MDS64V)**  
**MDD104 (MDD104-A0U, MDS104V)**  
**MDT354 (MDT354-A0U, MDS354V/W)**  
**RDD264 (RDD264-A0U, RDS264V)**



P/NO : MFL62755775



As an ENERGY STAR® Partner,  
LG has determined that this  
product or product models meet  
the ENERGY STAR® guidelines for  
energy efficiency.

ENERGY STAR® is a U.S. registered mark.

## Safety Precaution



**CAUTION:** TO REDUCE THE RISK OF ELECTRIC SHOCK DO NOT REMOVE COVER (OR BACK) NO USER-SERVICEABLE PARTS INSIDE REFER SERVICING TO QUALIFIED SERVICE PERSONNEL.



This lightning flash with arrowhead symbol within an equilateral triangle is intended to alert the user to the presence of uninsulated dangerous voltage within the product's enclosure that may be of sufficient magnitude to constitute a risk of electric shock to persons.



The exclamation point within an equilateral triangle is intended to alert the user to the presence of important operating and maintenance (servicing) instructions in the literature accompanying the product.

**WARNING:** TO PREVENT FIRE OR ELECTRIC SHOCK HAZARD, DO NOT EXPOSE THIS PRODUCT TO RAIN OR MOISTURE.

**WARNING:** Do not install this equipment in a confined space such as a book case or similar unit.

**CAUTION:** Do not block any ventilation openings. Install in accordance with the manufacturer's instructions.

Slots and openings in the cabinet are provided for ventilation and to ensure reliable operation of the product and to protect it from over heating. The openings shall be never be blocked by placing the product on a bed, sofa, rug or other similar surface. This product shall not be placed in a built-in installation such as a bookcase or rack unless proper ventilation is provided or the manufacturer's instruction has been adhered to.

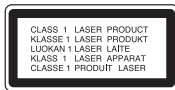

**CAUTION:** This product employs a Laser System.

To ensure proper use of this product, please read this owner's manual carefully and retain it for future reference. Shall the unit require maintenance, contact an authorized service center.

Use of controls, adjustments or the performance of procedures other than those specified herein may result in hazardous radiation exposure.

To prevent direct exposure to laser beam, do not try to open the enclosure. Visible laser radiation when open. DO NOT STARE INTO BEAM.

**CAUTION:** The apparatus shall not be exposed to water (dripping or splashing) and no objects filled with liquids, such as vases, shall be placed on the apparatus.

### CAUTION concerning the Power Cord

**Most appliances recommend they be placed upon a dedicated circuit;** That is, a single outlet circuit which powers only that appliance and has no additional outlets or branch circuits. Check the specification page of this owner's manual to be certain.

Do not overload wall outlets. Overloaded wall outlets, loose or damaged wall outlets, extension cords, frayed power cords, or damaged or cracked wire insulation are dangerous. Any of these conditions could result in electric shock or fire. Periodically examine the cord of your appliance, and if its appearance indicates damage or deterioration, unplug it, discontinue use of the appliance, and have the cord replaced with an exact replacement part by an authorized service center.

Protect the power cord from physical or mechanical abuse, such as being twisted, kinked, pinched, closed in a door, or walked upon. Pay particular attention to plugs, wall outlets, and the point where the cord exits the appliance.

To disconnect power from the mains, pull out the mains cord plug. When installing the product, ensure that the plug is easily accessible.



## Contents



Safety Precaution	2
Contents	3



Setting up	4
Hooking up the unit	5
Main Unit	6
Remote control	7
OSD Initial language setting - Optional	8
Initial Setting the Area Code	8
Adjust the general settings	8-10
Setting the sound mode	10-11
Setting the clock	11



Displaying Disc Information	12
Playing a Disc	12-14
Viewing photo files	14
Listening to the radio	15
Listening to the cassette tapes	15
Listening to music from your external device	16
Using an USB device	16



Recording to USB	17
Recording to TAPE	18
Synchronized Recording from CD to TAPE	18



Language Codes	19
Area Codes	19
Troubleshooting	20
Types of Playable Discs	21
Specifications	22

# Setting up

## Attaching the speakers to the unit

Connect the black end of each wire to the terminals marked - (minus) and the other end to the terminals marked + (plus).  
To connect the cable to the each speakers, press each plastic finger pad to open the connection terminals on the back of each speaker. Insert the wire and release the finger pad.

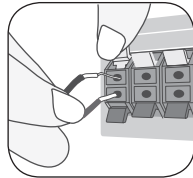

## Be careful of the following

- Be careful to make sure children not to put their hands or any objects into the \*speaker duct.
- \* Speaker duct : A hole for plentiful bass sound on speaker cabinet (enclosure).

## MDT354 (2.1 channel)

COLOUR	SPEAKER	POSITION
Red	Front	In front of you, to the right of the screen.
White	Front	In front of you, to the left of the screen.
Orange	Sub Woofer	This can be placed in any front position.

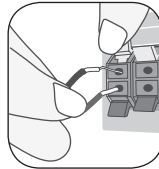

## MDD64/MDD104/RDD264 (2 channel)

COLOUR	SPEAKER	POSITION
Red	Front	In front of you, to the right of the screen.
White	Front	In front of you, to the left of the screen.

# Hooking up the unit

## VIDEO OUT jack connection

Connect the VIDEO OUT jack on the unit to the corresponding input jacks on your TV using a Video cable.

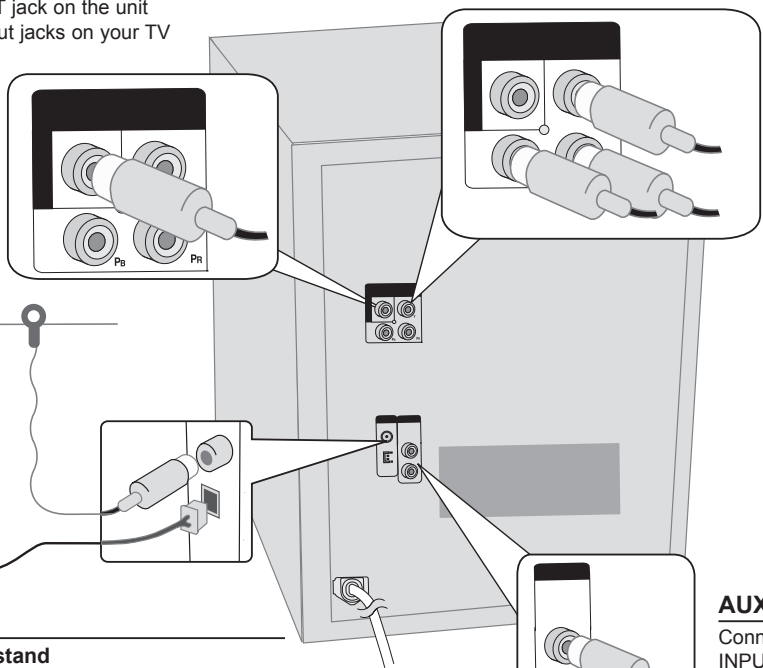

## COMPONENT VIDEO OUT (PROGRESSIVE SCAN) jacks connection

Connect one end of the component (Y PB PR) cable to the COMPONENT VIDEO OUT (PROGRESSIVE SCAN) jack on the unit and other end to the COMPONENT INPUT jack on your TV.

## Antenna connection

### Fit the AM loop aerial to its stand

Connect the AM loop aerial to the unit.

### Connect the FM aerial



The reception will be at its best when the two loose ends of the aerial are in a straight line and horizontal.

## AUX IN (L/R) jacks connection

Connect a VCR or Auxiliary device, etc. to the INPUT jack of this unit.

Press the **FUNCTION** button on the remote control until the "AUX" indicator is displayed in the display window.

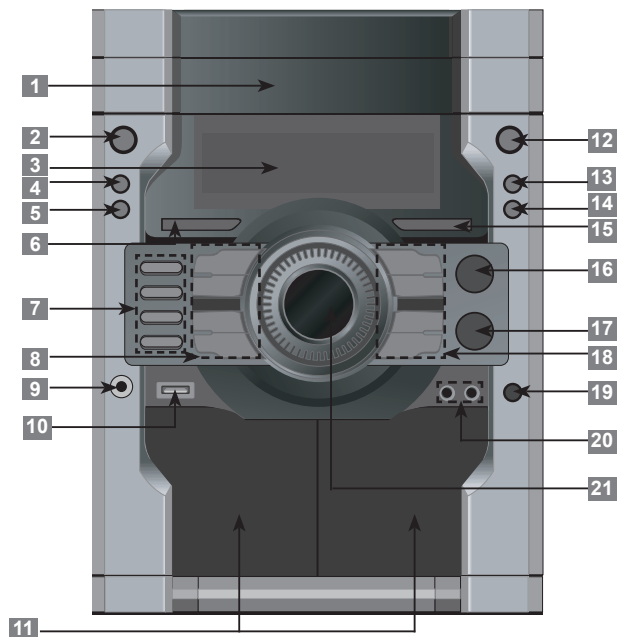

## Main unit

- 1 Disc tray
- 2  / I **STANDBY/ON**
- 3 Display window
- 4 **CLOCK**
- 5 **TIMER**
- 6 **USER EQ**
- 7 Selects **DVD/CD** function.  
Selects **TUNER** function.  
Selects **TAPE** function.  
Selects **AUX** function.
- 8 **SET** Confirms the settings.  
(**TIMER/ CLOCK**)  
**CD II** Pauses  
**PRESET(-)**  
**I<<<< TUNING(-)**  
**USB** Selects **USB** function.  
**DEMO** In power off state to demonstrate the function on display window. To cancel it, press  or this button again.
- 9 Headphone jack
- 10 USB connector
- 11 Cassette Door 1, 2



- 12  **OPEN/CLOSE**: Open or close your CD door.
- 13 **DISC SKIP**  
Choose a desired disc.
- 14 **EQ**  
You can choose fixed sound impression
- 15 **XDSS**  
Extreme Dynamic Sound System  
Reinforce the treble, bass and surround effect.
- MP3 OPT**  
Optimizes compressible MP3 files so that it improves the bass sound.
- 16 **REC./PAUSE(USB/TAPE)**
- 17 **LG EQ**  
You can choose fixed sound impression
- 18 **CD SYNC.** CD to Tape Synchronized.  
**DUBB.** Recording from tape to tape.  
**▶ PRESET (+)**  
**▶▶▶▶ I TUNING(+)**  
**■ STOP**
- 19 **MIC VOL.**  $\wedge/\vee$   
Adjust microphone volume.
- 20 **MIC 1, 2**
- 21 Volume control

### Power Save Mode

You can set up the unit into an economic power save mode.  
In power-on status, press and hold  button for about 3 seconds.  
- Nothing is displayed in the display window when the unit is turned off.  
To cancel, press .

# Remote control

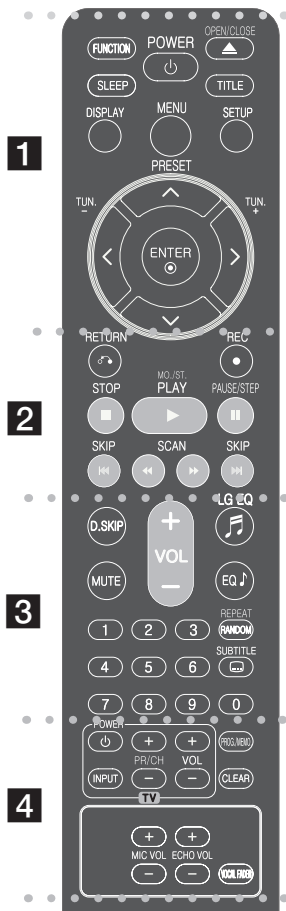

**1**

**POWER** (⏻): Switches the unit ON or OFF.  
**FUNCTION**: Changes the function.  
**SLEEP**: Sets the System to turn off automatically at a specified time. (Dimmer : Dims the LED (Light-emitting diode) of front panel by half in power-on status.)  
**OPEN/CLOSE** (⏮): Open or close your CD door.  
**TITLE**: If the current DVD title has a menu, the title menu appears on the screen. Otherwise, the disc menu may appear.  
**DISPLAY**: Accesses On-Screen Display.  
**MENU**: Accesses the menu on a DVD disc.  
**SETUP**: Accesses or removes setup menu.  
**< > ^ v (left/right/up/down)**: Used to navigate on-screen displays.  
**ENTER**: Acknowledges menu selection.  
**PRESET** (⏮): Selects programme of Radio.  
**TUN. +/- (< >)**: Tunes in the desired radio station.

**2**

**RETURN** (↶): Moving back wards in the menu.  
**REC** (●): Recording to USB/ TAPE.  
**STOP** (■): Stops playback or recording.  
**PLAY** (▶): Starts playback.  
**MO./ST.:** MONO/STEREO FM mode state, selects MONO or STEREO by pressing this button.  
**PAUSE/STEP** (⏸): Pausing playback.  
**SCAN** (◀▶): Search backward or forward.  
**SKIP** (◀◀▶▶): Go to next or previous chapter/track/Title.

**Remote control Operation**  
 Point the Remote Control at the display window and press the buttons.

**Remote control Battery Installation**

- 1 Detach the battery cover on the rear of the remote control.
- 2 Insert the R03 (size AAA) battery with ⊕ and ⊖ aligned correctly.

**3**

**D.SKIP**: Choose a desired disc.  
**MUTE**: To mute the sound.  
**VOL (Volume) +/-**: Adjusts speaker volume.  
**EQ/ LG EQ** (EQUALIZER Effect): You can choose sound impressions.  
**0-9 numerical buttons**: Selects numbered options in a menu.  
**REPEAT/RANDOM** : To select a play mode. (Random, repeat)  
**SUBTITLE**: During playback, you can select a desired subtitle language.

**4**

**TV Control buttons** : Controls the TV. (LG TV only)

**Controlling the TV.**  
 You can control the sound level, input source, and power switching of LG TVs as well. Hold **POWER** (TV) and press **PR/CH** (+/-) button repeatedly until the TV turns on or off.

**PROG./MEMO.:** Accesses or removes Program menu.  
**MIC VOL. (+/ -)**: Adjusts microphone volume.  
**ECHO VOL. (+/ -)**: Adjusts echo volume.  
**VOCAL FADER**: You can enjoy the function as karaoke, by reducing singer vocal of music in the various source.  
**CLEAR**: Removes a track number on the Program List.

## OSD Initial language setting - Optional

During the first use of this unit, the initial language setup menu appears on your TV screen. You must complete initial language selection before using the unit. English will be selected as the initial language.

	ON REMOTE
<b>1 Turn the power on</b> The language list appears	<b>POWER</b>
<b>2 Select the language</b>	^ v < >
<b>3 Press</b>	<b>ENTER</b>
<b>4 To confirm press</b>	< > and <b>ENTER</b>

## Initial Setting the Area Code

When you use this unit for the first time, you have to set the Area Code as shown below.

	ON REMOTE
<b>1 Display setup menu</b>	<b>SETUP</b>
<b>2 Select LOCK menu on the first level</b>	^ v
<b>3 Move to second level</b> The activated Area Code appears on the second level.	>
<b>4 Move to the third level</b>	>
<b>5 Enter a new password</b>	<b>numerical buttons (0-9) and ENTER</b>
<b>6 Recheck the entered new password</b>	<b>numerical buttons (0-9) and ENTER</b>
<b>7 Select a code for a geographic area</b> After select, Rating and Password will be activated. (page 19)	^ v < > and <b>ENTER</b>
<b>8 To confirm what you press</b> Make sure to finish setting the Area Code before leaving the setup menu if you cannot set the rating and Password	<b>ENTER</b>

## Adjust the general settings

	ON REMOTE
<b>1 Display setup menu</b>	<b>SETUP</b>
<b>2 Select a desired option on the first level</b>	^ v
<b>3 Move to second level</b>	>
<b>4 Select a desired option on the second level</b>	^ v
<b>5 Move to third level</b>	>
<b>6 Change the setting</b>	^ v and <b>ENTER</b>

## Adjust the general settings - More you can do

### Adjust the language settings

**OSD** – Selects a language for the Setup menu and on-screen display.

**Disc Audio/ Disc Subtitle/ Disc Menu** – Selects a language for the Audio/ Menu/ Subtitle.

[Original]: Refers to the original language in which the disc was recorded.

[Others]: To select another language, press number buttons then **ENTER** to enter the corresponding 4-digit number according to the language code list in the reference chapter.

Refer to the language code on **Page 19**.

[Off] (for Disc Subtitle): Turn off Subtitle.



## Adjust the display settings

**TV Aspect** – Select which screen aspect to use based on the shape of your TV screen.

[4:3]: Select when a standard 4:3 TV is connected.

[16:9]: Select when a 16:9 wide TV is connected.

**Display Mode** – If you selected 4:3, you'll need to define how you would like widescreen programs and films to be displayed on your TV screen.

[Letterbox]: This displays a widescreen picture with black bands at the top and bottom of the screen.

[Panscan]: This fills the entire 4:3 screen, cropping the picture as necessary

### Progressive Scan

Progressive Scan Video provides the high quality pictures with less flickering. If you are using the Component Video jacks for connection to a TV or monitor that is compatible with a progressive scan signal, set [Progressive Scan] to [On].

Press **ENTER** to confirm your selection

- If you not press **ENTER** within 10 seconds it will be [Off].

## Adjust the audio settings

**DRC (Dynamic Range Control)** – Make the sound accurate when the volume is turned down (Dolby Digital only). Set to [On] for this effect.

**Vocal** – Select [On] to mix karaoke channels into normal stereo. This function is effective for multi-channel karaoke DVDs only.

## 2.1 Speaker Setup (MDT354)

	ON REMOTE
<b>1 Open the settings menu</b>	<b>SETUP</b>
<b>2 Select the audio icon</b>	^ v
<b>3 Select right to enter the audio menu, then select 2.1 Speaker Setup</b>	> <b>ENTER</b>
<b>4 Select the speaker you want to adjust</b>	< >
	
<b>5 Select an option and change the settings</b>	^ v < >
<b>6 Set the output level (volume) of a speaker from -5dB to +5dB.</b>	< >
<b>7 Test the signals of each speaker</b> Adjust the volume to your taste according to these signals.	< >
<b>8 Save your settings and exit the Setup menu</b>	↶ <b>RETURN</b>

## Adjust the lock settings

---

To access the lock options, you must enter the 4-digit password. If you have not yet entered a password you are prompted to do so. Enter a 4-digit password. Enter it again to verify. If you make a mistake while entering number, press **CLEAR** to delete numbers then correct it.

If you forget your password you can reset it. Press **SETUP** and Input '210499' and press **ENTER**. The password has now been cleared.

**Rating** – Select a rating level. The lower the level, the stricter the rating. Select [Unlock] to deactivate the rating.

**Password** – Sets or changes the password for lock settings.

[New]: Enter a new 4-digits password using the numerical buttons then press **ENTER**. Enter the password again to confirm.

[Change]: Enter the new password twice after entering the current password.

**Area code** – Select a code for a geographic area as the playback rating level.  
This determines which area's standards are used to rate DVDs controlled by the parental lock. See the Area Codes on **Page 19**.

## Adjust the others settings

---

**DivX (R) Registration** - We provide you with the DivX® VOD (Video on demand) registration code that allows you to rent and purchase videos using the DivX® VOD service.

For more information, visit [www.divx.com/vod](http://www.divx.com/vod).

Press **ENTER** when [Select] icon is highlighted and you can view the registration code of the unit.

**Semi Karaoke (optional)** - When a chapter/ title/ track is fully finished, this function shows the score in the screen with a fanfare sound.

## Setting the sound mode

### USER EQ

---

- 1 Press **USER EQ**.
- 2 "USER EQ" is displayed.
- 3 Press **SET**.
- 4 Select the sound effect you want among BASS(100HZ), MIDDLE(1kHz), TREBLE(10kHz) by pressing **PRESET(-)/PRESET(+)**.
- 5 Adjust sound level by pressing **◀◀◀/▶▶▶▶▶**.
- 6 To finish the setting, press **SET**.

### VOCAL FADER

---

You can enjoy the function as karaoke, by reducing singer vocal of music in the various source. (MP3/ WMA/ CD/ etc.) Press the **VOCAL FADER**, and "FADE ON" will appear in display window.

To cancel it, press **VOCAL FADER** again.

- This function is available to use only when a microphone is connected.
- The quality of the VOCAL FADER may be different depending on the recording conditions of music files.
- It is not available on the MONO mode.





## Enjoying a pre-programmed sound field

The system has a number of pre-set surround sound fields. You can select a desired sound mode by using **EQ/LG EQ**.



The displayed items for the Equalizer may be different depending on sound sources and effects.

ON DISPLAY	Description
<b>NATURAL</b>	You can enjoy comfortable and natural sound.
<b>Local Specialization equalizer</b>	Regionally optimized sound effect.(DANGDUT/ ARABIC/ PERSIAN/ INDIA/ REGUETON/ MERENGUE/ SAMBA/ SALSA)
<b>AUTO EQ</b>	Realizes the sound equalizer that is the most similar to the genre of which is included in the MP3 ID3 tag of song files.
<b>POP CLASSIC JAZZ ROCK</b>	This program lends an enthusiastic atmosphere to the sound, giving you the feeling you are at an actual rock , pop, jazz or classic concert.
<b>MP3 OPT</b>	This function is optimized for compressible MP3/WMA file. It improves the bass sound.
<b>XDSS ON</b>	Reinforce the treble, bass and surround sound effect.
<b>VIRTUAL</b>	You can enjoy more virtual surround sound.
<b>NORMAL(OFF)</b>	You can enjoy the sound without equalizer effect.

## Setting the Clock

	ON UNIT
<b>1 Turn the power on</b>	
<b>2 Press for at least 2 seconds</b>	<b>CLOCK</b>
<b>3 Choose from either</b> AM 12:00 (for an AM and PM display) or 0:00 (for a 24 hour display)	
<b>4 Confirm your selection</b>	<b>SET</b>
<b>5 Select the hours</b>	
<b>6 Press</b>	<b>SET</b>
<b>7 Select the minutes</b>	
<b>8 Press</b>	<b>SET</b>

### Using your player as an alarm clock

- Press and hold **TIMER**. Each functions flashes(Ex. TUNER, USB, ...)
- Press **SET** when the function you want to be woken by is showing.  
If you choose TUNER, "PLAY" and "REC" flashes in the display window alternately.
- Choose one of them by pressing the **SET**.
- "ON TIME" will be displayed. This is where you set the time you want the alarm to start. Use  to change the hours and minutes and **SET** to save.
- The "OFF TIME" will be displayed. This is where you set the time you want the function to stop.
- Use  to change the hours and minutes and press **SET** to save.
- You will be shown the volume (VOL) you want to be woken by. Use  to change the volume and **SET** to save. Switch the system off. The clock icon "⌚" shows that the alarm is set.
- When the system is turned off you can check the time the alarm and turn the alarm on and off by pressing **TIMER**.

### Fall asleep while listening to your player

Press **SLEEP** one or more times to select delay time between 10 and 180 minutes, after the player will turn off. To check the remaining time, press **SLEEP**.

(DIMMER ON) -> SLEEP 180 -> ... -> SLEEP 10 -> (DIMMER OFF)





\*DIMMER: The LED (Light-emitting diode) of front panel is turned off and the display window will be darkened by half.

## Displaying Disc Information

	ON REMOTE
1 Press	DISPLAY
2 Select an item	^ v
3 Adjust the Display menu settings	< >
4 To return the exit	DISPLAY

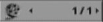
## Displaying Disc Information - More you can do

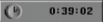
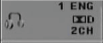
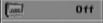
You can select an item by pressing ^ v and change or select the setting by pressing < >.

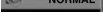
 1 / 1	Current title (or track/ file) number/total number of titles (or tracks/ files)
 13 / 18	Current chapter number/total number of chapters
 0:39:02	Elapsed playing time
 1 ENG DSD 2 CH	Selected audio language or channel
 Off	Selected subtitle
 1 / 1	Selected angle/total number of angles
 NORMAL	Selected Sound/EQ mode

## Symbol Used in this Manual

All discs and file listed below		MP3 files	
DVD and finalized DVD±R/RW		WMA files	
DivX files		Audio CDs	

## Playing a Disc

	ON UNIT	ON REMOTE
1 Open the disc tray	▲ OPEN/CLOSE	▲ OPEN/CLOSE
2 Insert a disc		
3 Close the disc tray	▲ OPEN/CLOSE	▲ OPEN/CLOSE
4 To Start playback	▶	▶
5 To stop playback	STOP	■

## Playing a Disc - More you can do

### Playing a DVD that has a menu

Most DVDs now have menus which load first before the film begins to play. You can navigate these menus using < > ^ v to highlight an option. Press **PLAY** to select.

### Skipping to the next/previous chapter/ track/ file

Press **▶▶** to move to the next chapter/ track/ file.  
Press **◀◀** to return to the beginning of the current chapter/ track/ file.  
Press **◀◀** twice briefly to step back to the previous chapter/ track/ file.

### Pausing a playback

Press **PAUSE/STEP (II)** on the remote control to pause playback. Press **▶** to continue playback.

### Frame-by-Frame playback

Press **PAUSE/STEP (II)** on the remote control repeatedly to play Frame-by-Frame playback.

### Playing repeatedly or randomly

- 1 Press **REPEAT/RANDOM** repeatedly. The current track/ file will be played back repeatedly or randomly.
  - 2 To return to normal playback, press **REPEAT/RANDOM** repeatedly to select [Off].
- Random play mode : only music files.

### Selecting a subtitle language

During playback, press **SUBTITLE** on the remote control repeatedly.

### Fast forward or fast reverse

- 1 Press **◀◀** or **▶▶** on remote control during playback.
- 2 You can change the various playback speed by pressing **◀◀** or **▶▶** repeatedly.
- 3 Press **▶** to continue play at normal speed.

### 1.5 times faster playback

- 1 Press **▶** when a disc is already playing to watch and listen.
- 2 **▶** x1.5 will appear on the screen.
- 3 Press **▶** again to return to normal playback speed.

### Slow down the playing speed

- 1 While playback is paused, press **◀◀/▶▶**.
- 2 You can change the various playback speed by pressing **◀◀/▶▶** repeatedly.
- 3 Press **▶** to continue play at normal speed.

### Starting play from selected time

Searches for the starting point of entered time code.

- 1 Press **DISPLAY** then select clock icon. and then press **ENTER**.

- 2 Enter a time then press **ENTER**.

For example, to find a scene at 1 hour, 10 minutes, and 20 seconds, enter "11020" by using numerical buttons and press **ENTER**. If you enter the wrong number, press **CLEAR** to enter again.

### Last Scene Memory

This unit memorizes last scene from the last disc that is viewed. The last scene remains in memory even if you remove the disc from the player or switch off the unit. If you load a disc that has the scene memorized, the scene is automatically recalled.

### Screen Saver

The screen saver appears when you leave the unit in stop mode for about five minutes.

### System Select - Optional

You must select the appropriate system mode for your TV system. In DVD/CD function, remove any disc that might be in the unit, press and hold **PAUSE/STEP (II)** for more than five seconds to be able to select a system (PAL, NTSC, AUTO).

### Mixed disc or USB Flash Drive – DivX, MP3/WMA and JPEG

When playing a disc or USB Flash Drive contained with DivX, MP3/WMA and JPEG files together, you can select file type with **MENU** button on the remote control.

### Changing the character set to display DivX<sup>®</sup> subtitle correctly - Optional

- 1 If the subtitle does not display properly, press and hold **SUBTITLE** about 3 seconds to display the language code menu.
- 2 Press **SUBTITLE** repeatedly to change the language code until the subtitle is displayed properly.

### DivX disc compatibility with this player is limited as follows

- Available resolution: within 800x600 (W x H) pixels
- The file name of the DivX subtitle should be entered within 45 characters.
- If there is impossible code to express in the DivX file, it may be displayed as " \_ " mark on the display.
- **If the video and audio structure of recorded files is not interleaved, either video or audio is outputted.**
- **Playable DivX file** : ".avi", ".mpg", ".mpeg", ".divx"
- **Playable Subtitle format** : SubRip (\*.srt/ \*.txt), SAMI (\*.smi), SubStation Alpha (\*.ssa/ \*.txt), MicroDVD (\*.sub/ \*.txt), SubViewer 2.0 (\*.sub/ \*.txt).
- **Playable Codec format** : "DIVX3.xx", "DIVX4.xx", "DIVX5.xx", "MP4V3", "3IVX".
- Playable Audio format : "AC3", "PCM", "MP3", "WMA".
- For Discs formatted in Live file system, you can not it on this player.
- If the name of movie file is different from that of the subtitle file, during playback of a DivX file, subtitle may not be display.
- If you play a DivX file differ from DivXspec, it may not operate normally.

## Creating your own program **WMA** **MP3** **ACD**

You can play the contents of a disc in the order you want by arranging the order of the songs on the disc. The program is cleared when the disc is removed.

- 1 Select a desired music then press **PROG./MEMO**, or select “**⏪**” and then press **ENTER** to add the music to the program list.
- 2 To add all music in the disc, select “**⏪**” and then press **ENTER**.
- 3 Select a music from the program list then press **ENTER** to start programmed playback.
- 4 To clear a music from the program list, select the music you want to clear then press **CLEAR** or select “**⏸**” icon and then press **ENTER**.  
To clear all music from the program list, select “**⏸**” then press **ENTER**.

## Displaying file information (ID3 TAG) **MP3**

While playing a MP3 file containing file information, you can display the information or time by pressing **DISPLAY** repeatedly.

**MP3 / WMA disc compatibility with this player is limited as follows**

**WMA** **MP3**

- Sampling frequency : within 32 - 48 kHz (MP3/ WMA)
- Bit rate : within 32 - 320kbps (MP3), 40 - 192kbps (WMA)
- File extensions : “.mp3”/ “.wma”/ JOLIET
- CD-ROM file format : ISO9660
- We recommend that you use Easy-CD Creator, which creates an ISO 9660 file system.
- They should not contain special letters such as / ? \* : “ < > | etc.
- The total number of files on the disc should be less than 999.

This unit requires discs and recordings to meet certain technical standards in order to achieve optimal playback quality. Pre-recorded DVDs are automatically set to these standards. There are many different types of recordable disc formats (including CD-R containing MP3 or WMA files) and these require certain pre-existing conditions (see above) to ensure compatible playback.

**Customers should note that permission is required in order to download MP3 / WMA files and music from the Internet. Our company has no right to grant such permission. Permission should always be sought from the copyright owner.**

## Viewing photo files

	ON UNIT	ON REMOTE
1 Open the disc tray	▲ OPEN/CLOSE	▲ OPEN/CLOSE
2 Insert a Disc	-	
3 Close the disc tray	▲ OPEN/CLOSE	▲ OPEN/CLOSE
4 Select a photo file on the menu	-	^ v
5 Display the selected file in full screen	▶	ENTER
6 To stop playback	STOP	■

## Viewing photo files - More you can do

### Viewing photo files as a slide show

- 1 Use < > ^ v to highlight **▶** icon then press **ENTER** to start slide show.
- 2 You can change slide show speed using < > when **⏮** icon is highlighted.

### Skipping to the next/previous photo

Press **⏮** or **⏭** to view the previous/next photo.

### Rotating a photo

Use ^ v to rotate the photo in full screen.

### Pausing a slide show

- 1 Press **PAUSE/STEP (⏸)**.
- 2 Press **▶** or **⏸** to continue the slide show.

### JPEG disc compatibility with this player is limited as follows

JPEG disc compatibility with this player is limited as follows :

- Max pixel in width : 5120 x 3840, Progressive jpeg: 2043 x 1536
- Recording condition: ISO 9660 LEVEL 1/ JOLIET
- Maximum files : Under 999.
- Some discs may not operate due to a different recording format or the condition of disc.
- File extensions: “.jpg”

## Listening to the radio

	ON UNIT	ON REMOTE
<b>1 Select FM/ AM</b>	<b>TUNER</b>	<b>FUNCTION</b>
<b>2 Select the radio station</b>	<b>TUNING(-/+)</b>	<b>TUN. +/-</b>
<b>3 To 'save' a radio station</b> A preset number will show in the display.		<b>PROG./MEMO.</b>
<b>4 Select the preset number</b>	<b>PRESET(-/+)</b>	<b>PRESET ^ v</b>
<b>5 To confirm press</b> Up to 50 radio stations can be saved		<b>PROG./MEMO.</b>
<b>6 To select a 'saved' station press</b>	<b>PRESET(-/+)</b>	<b>PRESET ^ v</b>

### Listening to the radio - More you can do

#### Looking for radio stations automatically

Press **TUNING(-/+)** on the front panel (**TUN.- /TUN.+** on the remote control) for more than 0.5 second. The tuner will scan automatically and stop when it finds a radio station.

#### Deleting all the saved stations

- 1 Press and hold **PROG./MEMO.** on the remote control. "ERASE ALL" shows.
- 2 Press **PROG./MEMO.** to erase all the saved stations.

#### Improving poor FM reception

Press **PLAY (▶)** (**MO./ST.**) on the remote control.

## Listening to the cassette tapes

	ON UNIT	ON REMOTE
<b>1 Open the tape door</b>	<b>▲ PUSH EJECT</b>	
<b>2 Insert the tape</b>		
<b>3 Close the tape door</b>	<b>▲ PUSH EJECT</b>	
<b>4 Select the TAPE function</b>	<b>TAPE</b>	<b>FUNCTION</b>
<b>5 Start the tape playing</b>	<b>▶</b>	<b>▶</b>
<b>6 To stop a tape playing</b>	<b>STOP</b>	<b>■</b>

### Listen to the cassette tapes - More you can do

#### Playing Fast backward or Forward

After pressing **⏮⏮⏮/▶▶▶** (**◀◀/▶▶** on the remote control) during playback, press **▶** at a point you want.

#### Dubbing

This function allows you to record from tape to tape.

- 1 Press **TAPE** to select "TAPE-1".
- 2 Insert the tape as follows.  
TAPE1 - Insert a playback tape to dub.  
TAPE2 - Insert a blank tape.
- 3 Press **DUBB.** "DUBBING" shows. Dubbing starts.
- 4 To stop dubbing, press **■**.

**NOTE:** In case you use the tape for the first time push the **▲ PUSH EJECT** to open the tape door and then remove the cushion in it.

## Listening to music from your external device

The unit can be used to play the music from many types of external device.

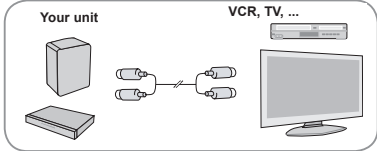
	ON UNIT	ON REMOTE
<b>1 Connect</b> the external device to the <b>AUX</b> connector of the unit. > If your TV has only one output for audio(MONO), connect it to the left(white) audio jack on the unit. 		
<b>2 Turn the power on.</b>	⏻	<b>POWER</b>
<b>3 Select the AUX function.</b>	<b>AUX</b>	<b>FUNCTION</b>
<b>4 Turn on the external device and start it playing.</b>		

## Using an USB device

You can enjoy media files saved on an USB device by connecting the USB device to the USB port of the unit.  
 If you want to operate other function, see the CD playback section.

	ON UNIT	ON REMOTE
<b>1 Connect the USB device to the USB port of the unit.</b>		
<b>2 Select the USB function.</b>	<b>USB</b>	<b>FUNCTION</b>
<b>3 Select a file you want to play.</b>		^ v
<b>4 Start your media playing.</b>	▶	▶ / ENTER
<b>5 To stop, press</b>	<b>STOP</b>	■
<b>6 Before disconnecting the portable USB device, change to any other function.</b>	TUNER/TAPE/...	<b>FUNCTION</b>

### Compatible USB Devices

- MP3 Player : Flash type MP3 player.
- USB Flash Drive : Devices that support USB 2.0 or USB 1.1.
- This USB Function may not be available depending on devices.

### USB device requirement

- Devices which require additional program installation when you have connected it to a computer, are not supported.

### Look out for the follows

- **Do not extract the USB device while in operation.**
- For a large capacity USB, it may take longer than a few minute to be searched.
- To prevent data loss, back up all data.
- If you use a USB extension cable or USB hub, the USB device is not recognized.
- Using NTFS file system is not supported. (Only FAT(16/32) file system is supported.)
- This unit is not supported when the total number of files is 1000 or more.
- External HDD, Locked devices or hard type USB devices are not supported.
- The unit can not be used as a storage device.
- USB port of the unit can not be connected to PC.



## Recording to USB

You can record a various sound source to USB.

	ON UNIT	ON REMOTE
<b>1 Connect the USB device to the unit.</b>		
<b>2 Select a mode in which you want to record. (TUNER/ CD/ ....) Play back a sound source first.</b>	TUNER/TAPE/...	FUNCTION
<b>3 Start the recording.</b> > If you press the button on the remote control, the display changed in the following order, "USB REC" <-> "TAPE REC". Then press the button on "USB REC" once more.	REC/PAUSE	● REC
<b>4 To stop recording, press :</b>	STOP	■

## Recording to USB - More you can do

### Recording Music file in disc source to USB

#### One track recording

If the USB recording is played during playback of the CD, the one track/ file would be recording into the USB.

#### All tracks recording



If the recording button is pressed at the CD stop, all tracks/ files would be recording.

#### Program list recording

USB records after creating your own program if you want to record the track you want (Audio CD only).

### When you are recording, look out for the following

- You can check the recording percentage rate for the USB record on the screen during the recording. (AUDIO, MP3/ WMA CD only)
- During recording MP3/ WMA, there is no sound.
- When you stop recording during playback, the file that has been recorded at that time will be stored. (AUDIO CD Only)
- Do not remove the USB device during USB recording. If not, an incomplete file may be made and not deleted on PC.
- If USB recording does not work, the message like "NO USB", "ERROR", "USB FULL" or "NO REC" is displayed on the display window.
- Multi card reader device or External HDD can not be used for USB recording.
- A file is rerecorded by 128 Mbyte when you record for a long term.
- When you stop recording during playback, the file will not be stored.
- In the state CD-G disc, USB record is not operated.
- You may not record more than 999 files.
- The file number is saved automatically.
- **It'll be stored as follows.**

AUDIO CD	MP3/ WMA	the other sources
 CD_REC  — TRK-001  — TRK-002       	 FILE_REC  — 001_ABC(File name)  — 002_DEF(File name)       	 EXT_REC  — AUD-001  — AUD-002       

The making of unauthorized copies of copy-protected material, including computer programs, files, broadcasts and sound recordings, may be an infringement of copyrights and constitute a criminal offence.

This equipment should not be used for such purposes.

**Be responsible  
Respect copyrights**

## Recording to TAPE

You can record a various sound source to TAPE.

	ON UNIT	ON REMOTE
<b>1 Open the tape deck.</b> > There are 2 tape decks on the unit, open the second one.	<b>PUSH EJECT</b>	
<b>2 Insert a blank tape and close the door.</b>		
<b>3 Select a mode in which you want to record.</b>	TUNER/USB/...	<b>FUNCTION</b>
<b>4 Play back a sound source first.</b>	▶	▶
<b>5 Press</b> > The display changed in the following order, "USB REC" <-> "TAPE REC"	<b>REC/PAUSE</b>	● <b>REC</b>
<b>6 Press the button once more when "TAPE REC" is displayed.</b> > Recording starts.	<b>REC/PAUSE</b>	● <b>REC</b>
<b>7 To stop recording, press</b>	<b>STOP</b>	■

## Synchronized Recording from CD to Tape

	ON UNIT	ON REMOTE
<b>1 Open the tape deck and then insert a blank tape.</b> > There are 2 tape decks on the unit, open the second one.	<b>PUSH EJECT</b>	
<b>2 Close the door and insert a CD.</b> > Audio CD only	▲ <b>OPEN/CLOSE</b>	▲ <b>OPEN/CLOSE</b>
<b>3 To select CD function, press</b>	<b>DVD/CD</b>	<b>FUNCTION</b>
<b>4 Press the button on a stop status to move to CD synchronizing mode.</b> > Recording automatically starts 7 seconds later after "CD SYNC" blinks.	<b>CD SYNC.</b>	
<b>5 To stop, press</b>	<b>STOP</b>	■

## Language Codes

Use this list to input your desired language for the following initial settings: Disc Audio, Disc Subtitle, Disc Menu.

Language	Code	Language	Code	Language	Code	Language	Code	Language	Code	Language	Code
Afar	6565	Croatian	7282	Hausa	7265	Lingala	7678	Quechua	8185	Tajik	8471
Afrikaans	6570	Czech	6783	Hebrew	7387	Lithuanian	7684	Rhaeto-Romance	8277	Tamil	8465
Albanian	8381	Danish	6865	Hindi	7273	Macedonian	7775	Rumanian	8279	Telugu	8469
Ameharic	6577	Dutch	7876	Hungarian	7285	Malagasy	7771	Russian	8285	Thai	8472
Arabic	6582	English	6978	Icelandic	7383	Malay	7783	Samoan	8377	Tonga	8479
Armenian	7289	Esperanto	6979	Indonesian	7378	Malayalam	7776	Sanskrit	8365	Turkish	8482
Assamese	6583	Estonian	6984	Interlingua	7365	Maori	7773	Scots Gaelic	7168	Turkmen	8475
Aymara	6588	Faroese	7079	Irish	7165	Marathi	7782	Serbian	8382	Twi	8487
Azerbaijani	6590	Fiji	7074	Italian	7384	Moldavian	7779	Serbo-Croatian	8372	Ukrainian	8575
Bashkir	6665	Finnish	7073	Javanese	7487	Mongolian	7778	Shona	8378	Urdu	8582
Basque	6985	French	7082	Kannada	7578	Nauru	7865	Sindhi	8368	Uzbek	8590
Bengali, Bangla	6678	Frisian	7089	Kashmiri	7583	Nepali	7869	Singhalese	8373	Vietnamese	8673
Bhutani	6890	Galician	7176	Kazakh	7575	Norwegian	7879	Slovak	8375	Volapük	8679
Bihari	6672	Georgian	7565	Kirghiz	7589	Oriya	7982	Slovenian	8376	Welsh	6789
Breton	6682	German	6869	Korean	7579	Panjabi	8065	Spanish	6983	Wolof	8779
Bulgarian	6671	Greek	6976	Kurdish	7585	Pashto, Pushto	8083	Sudanese	8385	Xhosa	8872
Burmese	7789	Greenlandic	7576	Laothian	7679	Persian	7065	Swahili	8387	Yiddish	7473
Byelorussian	6669	Guarani	7178	Latin	7665	Polish	8076	Swedish	8386	Yoruba	8979
Chinese	9072	Gujarati	7185	Latvian, Lettish	7686	Portuguese	8084	Tagalog	8476	Zulu	9085

## Area Codes







Choose a area code from this list.

Area	Code	Area	Code	Area	Code	Area	Code	Area	Code	Area	Code
Afghanistan	AF	Costa Rica	CR	Greenland	GL	Maldives	MV	Paraguay	PY	Sri Lanka	LK
Argentina	AR	Croatia	HR	Hong Kong	HK	Mexico	MX	Philippines	PH	Sweden	SE
Australia	AU	Czech Republic	CZ	Hungary	HU	Monaco	MC	Poland	PL	Switzerland	CH
Austria	AT	Denmark	DK	India	IN	Mongolia	MN	Portugal	PT	Taiwan	TW
Belgium	BE	Ecuador	EC	Indonesia	ID	Morocco	MA	Romania	RO	Thailand	TH
Bhutan	BT	Egypt	EG	Israel	IL	Nepal	NP	Russian Federation	RU	Turkey	TR
Bolivia	BO	El Salvador	SV	Italy	IT	Netherlands	NL	Saudi Arabia	SA	Uganda	UG
Brazil	BR	Ethiopia	ET	Jamaica	JM	Netherlands Antilles	AN	Senegal	SN	Ukraine	UA
Cambodia	KH	Fiji	FJ	Japan	JP	New Zealand	NZ	Singapore	SG	United States	US
Canada	CA	Finland	FI	Kenya	KE	Nigeria	NG	Slovak Republic	SK	Uruguay	UY
Chile	CL	France	FR	Kuwait	KW	Norway	NO	Slovenia	SIB	Uzbekistan	UZ
China	CN	Germany	DE	Libya	LY	Oman	OM	South Africa	ZA	Vietnam	VN
Colombia	CO	Great Britain	GB	Luxembourg	LU	Pakistan	PK	South Korea	KR	Zimbabwe	ZW
Congo	CG	Greece	GR	Malaysia	MY	Panama	PA	Spain	ES		

## Troubleshooting

Symptom	Cause	Correction
<b>POWER</b>		
No power	The power cord is not plugged in.	Plug in the power cord.
<b>RADIO</b>		
No sound	The function switch is not set to the Radio mode.	Set the switch to the Radio mode.
	There are electronic devices near the unit.	Set the unit far from the devices.
Some noise occurs.	The antenna is positioned or connected poorly	Check the antenna connection and adjust its position
<b>DVD/CD</b>		
The unit does not start playback	An unplayable disc is inserted.	Insert a playable disc.
	The disc is placed upside down.	Place the disc with the playback side down.
No picture	The disc is not placed within the guide.	Place the disc on the disc tray correctly inside the guide. Clean the disc.
	The TV is not set to receive the video signal	Select the appropriate video input model on the TV so the picture from the unit appears on the TV
<b>REMOTE CONTROL</b>		
The remote control does not work properly.	The remote control is not pointed at the remote sensor of the unit directly.	Point the remote control to remote sensor directly of the unit.
	The battery in the remote control is exhausted.	Replace the battery with new ones.
<b>TAPE</b>		
Unable to record	Record protect tabs are removed.	Cover holes on back edge of tape with tap.

## Types of Playable Discs

Type	Logo
<b>DVD-VIDEO:</b> Discs such as movies that can be purchased or rented.	
<b>DVD-R:</b> Video mode and finalized only	
<b>DVD-RW:</b> Video mode and finalized only DVD VR format that have been finalized can not be played in this unit.	
<b>DVD+R:</b> Video mode only Supports the double layer disc also.	
<b>DVD+RW:</b> Video mode only	
<b>Audio CD:</b> Music CDs or CD-R/ CD-RW in music CD format that can be purchased.	

In addition, this unit can play a DVD±R/RW and CD-R or CD-RW that contains audio titles, MP3, WMA, JPEG files. Depending on the conditions of the recording equipment or the CD-R/ RW (or DVD±R/RW) disc itself, some CD-R/RW (or DVD±R/RW) discs may not be played on the unit due to the recording quality or physical condition of the disc, or the characteristics of the recording device and authoring software. The disc will not play if it has not been correctly finalized. Player does not support these kinds of discs.

“Dolby”, “Pro Logic”, and the double-D symbol are trademarks of Dolby Laboratories.  
Manufactured under license from Dolby Laboratories.

### About the Symbol Display

“  ” may appear on your TV display during operation and indicates that the function explained in this owner’s manual is not available on that specific DVD video disc.

### Regional code

This unit has a regional code printed on the rear of the unit. This unit can play only DVD discs labeled same as the rear of the unit or “ALL”.

- Most DVD discs have a globe with one or more numbers in it clearly visible on the cover. This number must match your unit’s regional code or the disc cannot play.
- If you try to play a DVD with a different regional code from your player, the message “Check Regional Code” appears on the TV screen.

### Copyrights

It is forbidden by law to copy, broadcast, show, broadcast via cable, play in public, or rent copyrighted material without permission. This product features the copy protection function developed by Macrovision. Copy protection signals are recorded on some discs. When recording and playing the pictures of these discs picture noise will appear. This product incorporates copyright protection technology that is protected by U.S. patents and other intellectual property rights. Use of this copyright protection technology must be authorized by Macrovision, and is intended for home and other limited viewing uses only unless otherwise authorized by Macrovision. Reverse engineering or disassembly is prohibited.

CONSUMERS SHOULD NOTE THAT NOT ALL HIGH DEFINITION TELEVISION SETS ARE FULLY COMPATIBLE WITH THIS PRODUCT AND MAY CAUSE ARTIFACTS TO BE DISPLAYED IN THE PICTURE. IN CASE OF 525 OR 625 PROGRESSIVE SCAN PICTURE PROBLEMS, IT IS RECOMMENDED THAT THE USER SWITCH THE CONNECTION TO THE ‘STANDARD DEFINITION’ OUTPUT. IF THERE ARE QUESTIONS REGARDING OUR TV SET COMPATIBILITY WITH THIS MODEL 525p AND 625p UNIT, PLEASE CONTACT OUR CUSTOMER SERVICE CENTER.

# Specifications

## General

Power supply	Refer to main label.			
Power consumption	Refer to main label.			
Net Weight	MDD64: 5.4 kg	MDD104: 5.5 kg	MDT354: 5.8 kg	RDD264: 5.7 kg
External dimensions (W x H x D)	274 x 334 x 344 mm			
Operating conditions	Temperature: 5°C to 35°C, Operation status: Horizontal			
Operating humidity	5% to 85%			

## Tuner

FM Tuning Range	87.5 - 108.0 MHz or 87.50 - 108.00 MHz
Intermediate Frequency	128 KHz
AM Tuning Range	522 - 1,620 KHz or 522 - 1,710 KHz or 520 - 1,710 KHz
Intermediate Frequency	45 KHz

## Amplifier

OUTPUT POWER	MDD64: 30 W x 2 (4 Ω) MDD104: 50 W x 2 (4 Ω) RDD264: 130 W x 2 (4 Ω) MDT354: Front: 100 W x 2 (4 Ω) Subwoofer: 150 W (3 Ω)
--------------	--

## DVD/CD player

Frequency response (audio)	40 - 20000 Hz
Signal-to-noise ratio (audio)	More than 75 dB (1 kHz)
Signal-to-noise ratio (video)	More than 55 dB (1 kHz)
Dynamic range (audio)	More than 80 dB
Video output	1.0 V (p-p), 75 Ω
Component Video output	(Y) 1.0 V (p-p), 75 Ω (Pb)/(Pr) 0.7 V (p-p), 75 Ω

## Cassette tape player

F.F/REW Time	120 sec (C-60)
Frequency Response	250 - 8000 Hz
Signal to Noise Ratio	43 dB
Channel Separation	50 dB (P/B)/45 dB (R/P)
Erase Ratio	55 dB (MTT-5511)

## Speakers

	MDS64V	MDS104V	MDS354V	MDS354W	RDS264V
Type	Front Speaker	Front Speaker	Front Speaker	Subwoofer	Front Speaker
Impedance	2 way 2 speaker	2 Way 2 Speaker	2 way 2 speaker	1 Way 1 Speaker	2 way 2 speaker
Rated Input Power	4 Ω	4 Ω	4 Ω	3 Ω	4 Ω
Max. Input Power	30 W	50 W	100 W	150 W	130 W
Net Dimensions (W x H x D)	60 W	100 W	200 W	300 W	260 W
Net Weight (1 EA)	220 x 333 x 253 mm	220 x 333 x 253 mm	220 x 333 x 283 mm	274 x 333 x 342 mm	214 x 382 x 301 mm
	3.0 kg	3.2 kg	3.7 kg	5.9 kg	4.1 kg

Designs and specifications are subject to change without prior notice.



