



OWNER'S MANUAL

# CAR CD/MP3/WMA Receiver

Please read this manual carefully before operating your set and retain for future reference.

MODEL  
NCS400UR

P/NO : MFL63284938

ENGLISH

DEUTSCH

FRANÇAIS

ESPAÑOL

ITALIANO

PORTUGUÊS

ΕΛΛΗΝΙΚΑ

## Table of Contents

<b>3</b>	Safety Note	<b>10</b>	Listening to music from an external device
<b>4</b>	Front Panel	<b>11-12</b>	Listening to the radio Storing desired frequencies manually Listening to a preset station Adjusting tuner settings
<b>5</b>	About detachable control panel Attaching the control panel Detaching the control panel	<b>12</b>	Using an USB device (OPTIONAL) Moving to another drive Quick search of a desired file
<b>6</b>	Installation Basic installation Removing the existing receiver unit ISO-DIN installation	<b>13</b>	Troubleshooting
<b>7</b>	Connection	<b>14</b>	Specifications
<b>8-9</b>	Basic operation Mute Using the EQ Using XDSS+ (Extreme Dynamic Sound System) Checking the clock Turning off the display light Resetting the unit Adjusting general settings		
<b>9-10</b>	Listening to a CD Pausing or restarting CD playback Searching for a section within a track /file Skipping to another track/ file Checking information about your music Playing back tracks/files in a way you want		



LG Electronics hereby declares that this/ these product(s) is/ are in compliance with the essential requirements and other relevant provisions of Directive 2006/28/EC (ANNEX I , 3.2.9), 72/245/EEC, and 2006/95/EC.

European representative :

LG Electronics Service Europe B.V. Veluwezoom 15, 1327  
AE Almere, The Netherlands  
(Tel : +31-(0)36-547-8888)

## Safety Note



**CAUTION**  
RISK OF ELECTRIC SHOCK  
DO NOT OPEN



**CAUTION : TO REDUCE THE RISK OF ELECTRIC SHOCK DO NOT SPLIT COVER(OR BACK) NO USER SERVICEABLE PARTS INSIDE. REFER SERVICING TO QUALIFIED SERVICE PERSONNEL.**



This lightning flash with arrowhead symbol within an equilateral triangle is intended to alert the user to the presence of uninsulated dangerous voltage within the product's enclosure that may be of sufficient magnitude to constitute a risk of electric shock to persons.



The exclamation point within an equilateral triangle is intended to alert the user to the presence of important operating and maintenance (servicing) instructions in the literature accompanying the product.



Always operate the vehicle in a safe manner. Do not become distracted by the vehicle while driving, and always be fully aware of all driving condition. Do not change settings, or any functions. Pull over in a safe and legal manner before attempting such operations.



Do not use for many hours at extremely low or high temperature. (-10 °C to 60 °C)



To reduce the risk of electric shock, do not remove the cover or back of this product. There are no user-serviceable parts inside. Refer servicing to qualified service personnel.



To reduce the risk of fire or electric shock, do not expose this product to dripping or splashing water, rain, or moisture.



The temperature of unit's outside can be extremely high, please use the unit after proper installation in your vehicle.



This unit cannot play 8 cm disc (use 12 cm disc only).

**CAUTION :** This product uses a Laser System.

To ensure proper use of this product, please read this owner's manual carefully and retain it for future reference.

Should the unit require maintenance, contact an authorized service center. Performing controls, adjustments, or carrying out procedures other than those specified herein may result in hazardous radiation exposure.

To prevent direct exposure to laser beam, do not try to open the enclosure. Visible laser radiation when open. **DO NOT STARE INTO BEAM.**

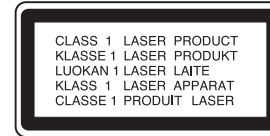

"This device is equipped with a portable battery or accumulator.

**Safe way to remove the battery or the battery from the equipment:**

Remove the old battery or battery pack, follow the steps in reverse order than the assembly. To prevent contamination of the environment and bring on possible threat to human and animal health, the old battery or the battery put it in the appropriate container at designated collection points. Do not dispose of batteries or battery together with other waste. It is recommended that you use local, free reimbursement systems batteries and accumulators."

The battery shall not be exposed to excessive heat such as sunshine, fire or the like.



### **Disposal of your old appliance**

1. When this crossed-out wheeled bin symbol is attached to a product it means the product is covered by the European Directive 2002/96/EC.
2. All electrical and electronic products should be disposed of separately from the municipal waste stream via designated collection facilities appointed by the government or the local authorities.
3. The correct disposal of your old appliance will help prevent potential negative consequences for the environment and human health.
4. For more detailed information about disposal of your old appliance, please contact your city office, waste disposal service or the shop where you purchased the product.

### **Caution**

When being connected in a wrong way, the unit displays as follows.

- Antenna port short : **"ANTENNA ON PORT SHORT CIRCUIT CHECK"**

After connecting it again, restart the unit.

# Front Panel

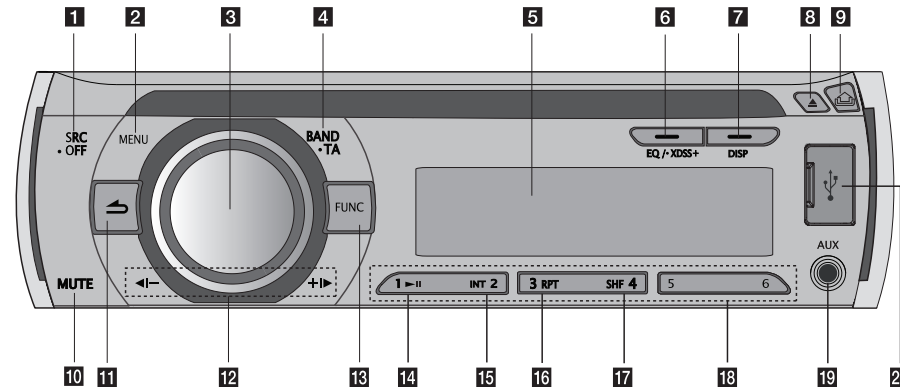

- 1** [SRC] Selects function sources.  
[• OFF] Power on/ off.
- 2** [MENU] Activates setting menu.
- 3** **Volume knob**
  - Adjusts volume level.
  - Confirms the settings.
  - Checking tracks or files in CD mode or preset stations in TUNER mode.
- 4** [BAND] Selects a band.  
[• TA] Traffic Announcement (OPTIONAL)  
Searches stations that have TA/TP information.
- 5** Display window
- 6** [EQ]/[• XDSS+]  
Improves sound quality.
- 7** [DISP]
  - Press it, you can check the clock time.
  - Press and hold it, you can turn off the display light.
- 8** [▲] Releases a disc.
- 9** [⏏] Opens the front panel.
- 10** [MUTE]  
Temporarily stops the sound.
- 11** [↶] Returns to the previous step.
- 12** [◀-/+▶]  
Skip / Search / Seek / Tune
- 13** [FUNC] In each mode, sets playback items.
- 14** [▶||] Plays and pauses playback.
- 15** [INT] Intro scan
- 16** [RPT] Repeat function
- 17** [SHF] Shuffle
- 18** **Numeric buttons**  
Selects a numbered preset station in TUNER
- 19** [AUX] If connected to other portable player, you can enjoy musics from it on the unit.
- 20** USB port (OPTIONAL)

## About detachable control panel

### Attaching the control panel

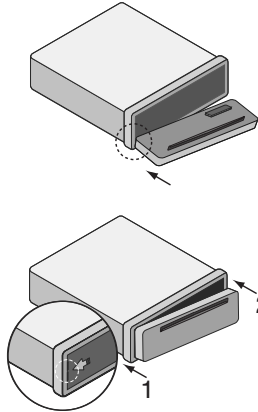



- 1 Align the left side of the panel with the stopper.
- 2 Push the right side of panel into the unit until it clicks.

#### **Caution**

- The control buttons may not work properly if the control panel is not attached properly. If this occurs, gently press the display.
- Do not leave the control panel in any area exposed to high temperatures or direct sunlight.
- Do not drop the control panel or otherwise subject it to strong impact.
- Do not allow such volatile agents as benzine, thinner, or insecticides to come into contact with the surface of the control panel.

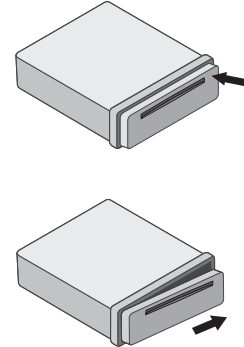
### Detaching the control panel



- 1 Press the  to open the control panel.
- 2 Push the control panel to right.

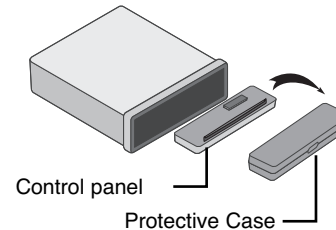

- 3 Pull the control panel out of the unit.
- 4 Put the detached control panel into the protective case.

#### **Note**

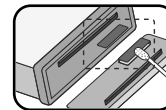

Periodically wipe the contacts on the back of the control panel with a cotton swab moistened with alcohol. For safety, turn off the ignition before cleaning, and remove the key from the ignition switch.

## Installation

### Basic Installation

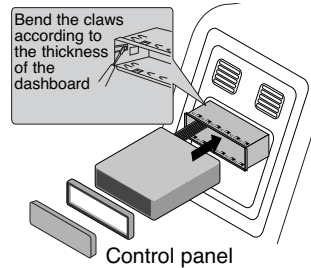

Before installing, make sure that the ignition-switch is set to OFF and remove the terminal of the car battery to avoid short-circuiting.

- 1 Remove the existing receiver unit.
- 2 Make the necessary connections.
- 3 Install the installation sleeve.
- 4 Install the unit into the installation sleeve.

### ISO-DIN Installation

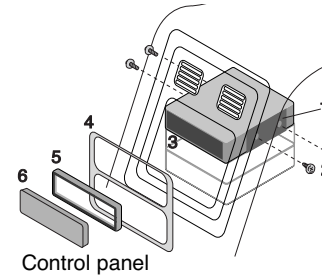

- 1 Slide the unit into the ISO-DIN frame.
- 2 Fit screws removed from the old unit.
- 3 Slide the unit and frame into the dash opening.
- 4 Install the dash panel or adapter plate.
- 5 Install the trim ring to the unit.
- 6 Install the control panel to the unit.

### Removing the existing receiver unit

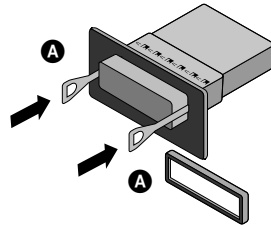

If there is already an installation sleeve for the receiver unit in the dashboard, it must be removed.

- 1 Remove the rear support from the unit.
- 2 Remove the control panel and trim ring from the unit.
- 3 Insert the lever **A** into the hole on one side of the unit. Perform the same operation on the other side and pull the unit out from the mounting sleeve.

# Connection

Before connecting, make sure that the ignition switch is set to OFF, and remove the battery ⊖ terminal to avoid short circuits.

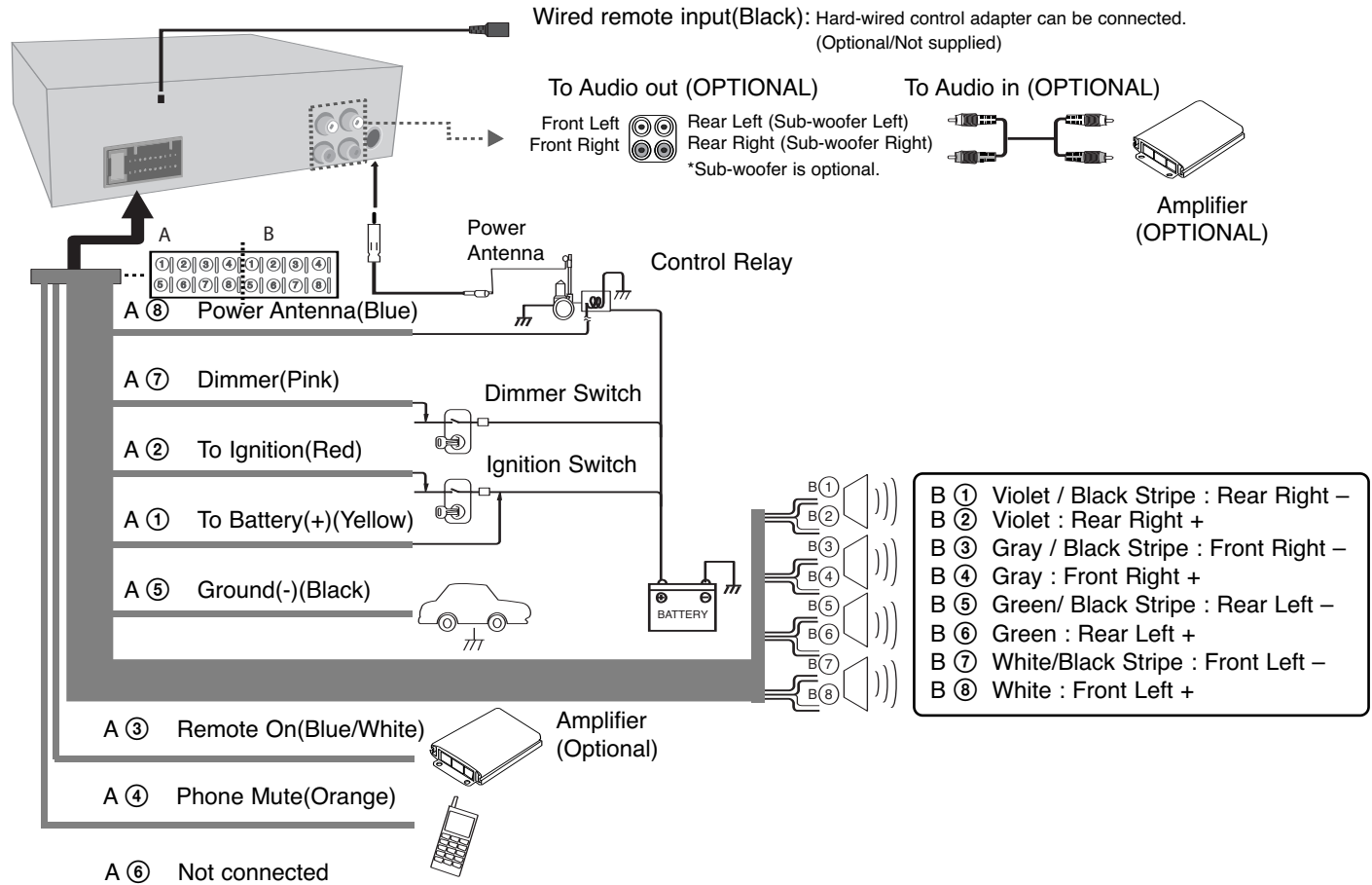

## Basic Operation

	ON PLAYER
1. Turn the unit on.	Any key
2. Select a source.	SRC
3. Adjust the volume.	Rotate the volume knob
4. Turn the unit off.	Press and hold ● OFF

## Basic operation - more you can do

### Mute

1. Press **MUTE** to cut the sound.
2. To cancel it, press again.

### Using EQ(Equalizer)

EQ is to increase or decrease the signal strength of audio frequencies. The function helps you to enjoy sound more plentifully.

Press **EQ/•XDSS+** on the unit repeatedly. The indicator lights up in the following order.

POP → CLASSIC → ROCK → JAZZ → VOCAL → SALSA → SAMBA → REGGAE → RUSSY → USER1 → USER2 → Off(not displayed)

#### Note

- When XDSS+ is set to "Off", you can adjust the EQ settings.
- You can adjust sound level to your preference. Once you select a USER mode and press [SOUND], then adjust the sound level(BASS(bass), MID(middle), TRB(treble)), it will be automatically stored for the currently selected USER mode. Refer to the "For sound setting" for USER 1/2 mode.

### Using XDSS+ (Extreme Dynamic Sound System)

It improves the treble and bass sound.

1. Press and hold **EQ/•XDSS+** on the unit.
2. To cancel it, press and hold it again.

### Checking the clock

1. Press **DISP** once to check the clock.
2. Press it again to remove it.

### Turning off the display light

1. Press and hold **DISP**.
2. Press and hold it again to turn it on.

#### Note

Under the light-off condition, press any keys, the light is turned on and then off automatically if you don't press it within a few seconds.

### Resetting the unit

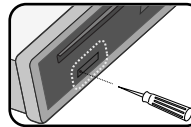

It resets the unit when it does not operate properly.

1. Press [] and pull out the front panel. (Refer to page 5 for detaching the control panel.)
2. Prick the RESET hold with sharp object.

### Adjusting general settings

You can adjust sound, light and other settings by using the **MENU** button.

1. Press **MENU**.
2. Rotate the volume knob to select [SOUND], [LIGHT], or [OTHER] and press it.
3. Rotate the volume knob to select the item and press it.
4. Rotate the volume knob clockwise or counterclockwise to adjust the level.
5. Press the volume knob to confirm the setting.

If you want to return to the previous step, press .

### For Sound setting

You can adjust sound quality by adjusting the level of BAL(left/right speaker), FAD(front/rear speaker) and S--W(Sub-woofer:optional).



### For Light setting

You can adjust the light effects by adjusting LED, DIM, or DIM L.

- DIM(Dimmer) OFF / ON / AUTO : You can change the brightness of the display window during the power-on status. When you set DIMMER to AUTO, the dimmer operates according to the car dimmer setting.
- DIM L (Dimmer Level): When you set DIM to ON/AUTO, you can adjust the dimmer level. (-2,-1,0,+1,+2)

### For Other setting

- AUX (Auxiliary) ON / OFF  
It is possible to use auxiliary equipment with this unit. Activate the auxiliary setting when using auxiliary equipment connected to this unit.
- BEEP 2ND / ALL  
BEEP 2ND : The beep is generated when a key is long pressed. (1 sec)  
BEEP ALL : The beep is generated when any key is pressed.
- A-EQ(Auto EQ) ON/OFF  
AUTO EQ operates only in the music file supported with Genre in the device. When you set AUTO EQ to ON, POP, CLASSIC, ROCK, or JAZZ is automatically selected according to the music genre.
- SW(Subwoofer) OFF / SW 55 Hz / SW 85 Hz / SW 120 Hz  
You can enable the subwoofer.  
SW OFF <-> SW 55 Hz <-> SW 85 Hz <-> SW 120 Hz.
- DEMO OFF/ ON  
You can change the initial indication on the display to information name (function name, EQ name, etc..) while listening to a source.
- CLK(Clock)  
For the model RDS is not supported or even for a RDS supported unit, when RDS CT information is not received and then you set CT on the setting menu to OFF, you can adjust the time by yourself. Refer to the page 11 for setting the CT(Clock Time) ON/OFF.

## Listening to a CD

ON PLAYER	
1. Insert a CD.	-
2. Adjust the volume.	Rotate the volume knob

## Listening to a CD - more you can do

### Pausing or restarting CD playback

1. Press **▶||** on the player during playback.
2. Press it to resume playback.

### Searching for a section within a track / file

1. During playback, press **◀|** or **|▶** on the player for longer than 1 second and then release.
2. Press **▶||** on the player again at the point you want.

### Skipping to another track/ file

Press **◀|** or **|▶** on the unit.

Or

1. Press the volume knob.
2. Rotate the volume knob on unit to select a desired track or file.
3. Press the volume knob to start playback.

### Note

To skip to previous track, press briefly **◀|** within 3 seconds of playing time.

### Checking information about your music

MP3/WMA files often come with tags. The tag gives the Title, Artist or Album. Press **DISP** repeatedly during MP3/WMA/CD TEXT file playback. If there is no information, "NO TEXT" will be shown in the display window.

## Playing back tracks/files in a way you want

### For using easy buttons

1. Press **INT/ RPT/ SHF**.
2. Press it again to cancel.

Or

### Using the FUNC button

1. Press **FUNC**.
2. Rotate the volume knob to select an item and press it.
3. Rotate the volume knob to set the option.
4. Press the volume knob to confirm the setting.

If you want to return to the previous step, press ↶.

#### ● INT (Intro Scan)

Each files in the current selected folder (  **INT**) or the first 10 seconds of each tracks/files (**INT**) on the disc are played.

#### ● RPT (Repeat)

The current selected tracks/files (**1 RPT**) or folder (  **RPT**) on the disc is played repeatedly.

#### ● SHF (Shuffle)

Each files in the current selected folder (  **SHF**) or all of the tracks/files (**SHF**) on the disc is played randomly. During random playback, even if you press ◀I- , you won't go back to the previous track.

#### **Note**

-  : The icon is displayed during MP3/WMA playback.
- **MP3/WMA Disc compatibility with this unit is limited as follows:**
  1. Sampling Frequency / 8 kHz to 48 kHz (MP3) 22.05 kHz to 48 kHz (WMA)
  2. Bit rate / within 8 kbps to 320 kbps (include VBR) (MP3) 32 kbps to 320 kbps (WMA)
  3. CD-R/CD-RW file system should be "ISO 9660"
  4. If you record MP3/WMA files using software which cannot create a FILE SYSTEM, for example "Direct-CD" etc., it will not be possible to playback MP3/WMA files. We recommend that you use "Easy-CD Creator" which creates an ISO9660 file system.

You have to set the disc format option to [Mastered] in order to make the discs compatible with the LG players when formatting rewritable discs. When setting the option to Live File System, you cannot use it on LG players. (Mastered/Live File System : Disc format system for Windows Vista)

**Customers should also note that permission is required in order to download MP3/WMA files and music from the Internet. Our company has no right to grant such permission. Permission should always be sought from the copyright owner.**

## Listening to music from an external device

	ON PLAYER
1. Connect an external device to the AUX jack with line input cable.	-
2. Select a source to AUX.	SRC
3. Play the connected Auxiliary Equipment.	-
4. Adjust the volume.	Rotate the volume knob

## Listening to music from an external device - more you can do

### Preventing radical changes in volume as switching sources

Only when you set AUX to ON as switching sources, you can adjust the volume level of each source to prevent radical changes in volume by selecting GAIN LOW or HIGH.

1. Press **FUNC** on the unit.
2. Rotate the volume knob on unit to set the option(GIN L/H).
3. Press the volume knob on unit to confirm the setting.
4. If you want to return to the previous step, press ↶.

## Listening to the radio

	ON PLAYER
1. Select a source to tuner.	SRC
2. Select a band.	BAND
3. Auto seek. Manual seek.	◀ -/+ ▶
	Press and hold ◀ -/+ ▶

## Listening to the radio - more you can do

### Storing desired frequencies manually

1. Press **BAND** to select a desired band you want to store.
2. Press and hold **◀|-/+|▶** on the unit until the beep sound is heard.
3. Press it repeatedly to select a desired frequency.
4. Press and hold one of preset buttons among 1 to 6 until the beep sound is heard.
5. Repeat steps 1 to 4 to preset other stations.

#### **Note**

- When a station is stored on the preset numbers on which another station of the same band has already been preset, the previously preset station is automatically erased.

### Listening to a preset station

1. Press **BAND** to select a desired band.
2. Press the volume knob.
3. Rotate the volume knob to select a preset station.
4. Press the volume knob.

Or

Press **BAND** and then the desired preset button among 1 to 6.

## Adjusting TUNER settings

1. Press **FUNC.**
  2. Rotate the volume knob to select an item and press it.
  3. Rotate the volume knob to set the option and press it.
  4. If you want to return to the previous step, press **↶**.
- **PTY (vrsti programa) (OPTIONAL)**  
It searches the radio stations by program type of FM tuner in a way as follows; The program types are displayed as follows.

NEWS	VARIED	LEISURE	JAZZ
AFFAIRS	WEATHER	DOCUMENT	COUNTRY
INFO	FINANCE	POP M	NATION M
SPORT	CHILDREN	ROCK M	OLDIES
EDUCATE	SOCIAL	EASY M	FOLK M
DRAMA	RELIGION	LIGHT M.	
CULTURE	PHONE IN	CLASSICS	
SCIENCE	TRAVEL	OTHER M	

- **PI (Programme Identification) SOUND/ MUTE (OPTIONAL)**  
PI SOUND : When the frequency of a tuned station switches to an AF(Alternative frequency) with an unidentified PI, it keeps the sound.  
PI MUTE : When the frequency of a tuned station switches to an AF with an unidentified PI, it mutes the sound until the PI is identified.
- **CT (Clock Time) ON/OFF (OPTIONAL)**  
You can use the RDS CT information to update the time. When RDS CT information is not received and then you set CT to OFF, you can adjust the time by yourself. Refer to the page 9 for setting the clock.
- **TA(Traffic Announcement) ALARM/ SEEK (OPTIONAL)**  
TA ALARM : When the tuned station has no TP information for 5 seconds, a double beep sound is output.  
TA SEEK : When the tuned station does not receive TP information for 5 seconds, the receiver retunes to the next station that has the TP information.

- REG (Region) ON/ OFF (OPTIONAL)  
REG ON : The unit switches to another station, within the same network, broadcasting the same program when the receiving signals from the current station become weak.  
REG OFF : The unit switches to another station, within the same network when the receiving signals from the current station become weak. (This mode, the program may differ from the one currently received.)
- AF(Alternative frequency) ON/ OFF (OPTIONAL)  
When the reception quality drops, the tuner automatically changes to another station in the network, broadcasting a better reception quality, using the PI and AF codes.
- SENS(Tuner sensitivity) MID/ HI/ LOW  
In an area in which signal reception is weak, it helps the tuner to search more stations. The weaker the reception is, the lower option you should set to.
- PS(Preset scan)  
Each preset station appears. To cancel, press the volume knob.
- AS (Auto Store)  
The six strongest broadcasting frequencies will be stored under preset button 1 to 6 in the order of their signal strength. To cancel, press the volume knob.

## Using an USB device (OPTIONAL)

	ON PLAYER
1. Open the USB cover.	-
2. Connect the USB device.	-
3. Adjust the volume.	Rotate the volume knob

## Using an USB device - more you can do

### Moving to another drive

When connecting this unit to multi reader, press **BAND** to go to the next drive. Each time you press the button, the driver modes changes.

### Quick search of a desired file

You can select and play a desired file regardless of the order in USB.

1. Press the volume knob to check all files.
2. Rotate the volume knob on unit to select a desired file.
3. Press the volume knob to start playback.

#### Note

- Press and hold the volume knob to check all folders. Then, repeat the previous the steps from 1 to 3 for playing a desired file.
- If the USB device is already connected, press **SRC** to select a source to USB.
- Other functions are same with "Listening to a CD - more you can do". Refer to page 9.

### Look out for the followings

- **Do not extract the USB device while in operation.**
- For a large capacity USB, it may take longer than a few minute to be searched
- To prevent data loss, back up all data.
- If you use a USB extension cable or USB hub, the USB device is not recognized.
- Using NTFS file system is not supported. (Only FAT(16/32) file system is supported.
- External HDD, Card readers, Locked devices, or hard type usb devices are not supported.
- USB port of the unit cannot be connected to PC. The unit can not be used as a storage device.

## Troubleshooting

	Symptom	Cause	Correction
General	Power doesn't turn on/ The unit doesn't operate.	Leads and connectors are not properly.	Confirm once more that all connections are correct.
		The fuse is blown.	Rectify the problem that caused the fuse to blow, and then replace it. Be very sure to install the correct fuse with the same rate.
		Noise and other factors are causing the built-in microprocessor to operate incorrectly.	Turn the unit off and then on.
	No sound is heard / The volume level will not rise.	Cables are not connected correctly.	Connect the cables correctly.
CD	There's audio skipping.	This unit is not firmly secured.	Secure this unit firmly.
	The playback is not possible.	The disc is dirty.	Clean the disc.
		The loaded disc is of a type this unit cannot play.	Check what type the disc.
Radio	Radio stations cannot be tuned in.	The signal strength of the stations is too weak(when tuning in with automatic tuning.)	Tune in the stations manually.
		No station has been preset or preset stations have been cleared(when tuning by scanning preset stations.)	Preset the stations.(Refer to the page 11)

## Specifications

### General

Output Power	53 W x 4 CH (Max.)
Power Source	DC 12 V
Speaker impedance	4Ω
Ground System	Negative
Dimensions (W x H x D)	178 x 50 x 169 mm (Without Control Panel)
Net Weight	1.37 kg

### Tuner

#### FM

Frequency Range	87.5 MHz to 107.9, 87.5 MHz to 108 MHz, 65 MHz to 74 MHz, or 87.5 MHz to 108 MHz
S/N Ratio	55 dB
Distortion	0.7 %
Usable Sensitivity	12 dBμV

#### AM (MW)

Frequency Range	520 MHz to 1720 or 522 MHz to 1620 kHz
S/N Ratio	50 dB
Distortion	1.0 %
Usable Sensitivity	28 dBμV

### CD

Frequency Response	20 Hz to 20 kHz
S/N Ratio	80 dB
Distortion	0.12 %
Channel Separation (1 kHz)	55 dB

### AUX

Frequency Response	20 Hz to 20 kHz
S/N Ratio	80 dB
Distortion	0.1 %
Channel Separation (1 kHz)	45 dB
Max Input Level (1 kHz)	1.1 V

### USB

Version	USB 1.1
---------	---------

### Line OUT

Frequency Response	20 Hz to 20 kHz
Output Voltage	2 V (Max.)

### Subwoofer (optional)

Frequency Response	20 Hz to 120 Hz
Output Voltage	2.0 V (Max.)

Designs and specifications are subject to change without notice.



