



ENGLISH

DEUTSCH

FRANÇAIS

NEDERLANDS

SLOVENŠČINA

ITALIANO

ESPAÑOL

EMAHNIKA

PORTUGUÊS

# OWNER'S MANUAL

# Speaker Sound Bar

Please read this manual carefully before operating your set and retain it for future reference.

HLS36W (HLS36W, SHS36-D)

P/NO : MFL66306882

## Safety Information

1

Getting Started



**CAUTION:** TO REDUCE THE RISK OF ELECTRIC SHOCK DO NOT REMOVE COVER (OR BACK) NO USER-SERVICEABLE PARTS INSIDE REFER SERVICING TO QUALIFIED SERVICE PERSONNEL.



This lightning flash with arrowhead symbol within an equilateral triangle is intended to alert the user to the presence of uninsulated dangerous voltage within the product's enclosure that may be of sufficient magnitude to constitute a risk of electric shock to persons.



The exclamation point within an equilateral triangle is intended to alert the user to the presence of important operating and maintenance (servicing) instructions in the literature accompanying the product.

**WARNING:** TO PREVENT FIRE OR ELECTRIC SHOCK HAZARD, DO NOT EXPOSE THIS PRODUCT TO RAIN OR MOISTURE.

**WARNING:** Do not install this equipment in a confined space such as a book case or similar unit.

**CAUTION:** Do not block any ventilation openings. Install in accordance with the manufacturer's instructions.

Slots and openings in the cabinet are provided for ventilation and to ensure reliable operation of the product and to protect it from over heating. The openings shall be never be blocked by placing the product on a bed, sofa, rug or other similar surface. This product shall not be placed in a built-in installation such as a bookcase or rack unless proper ventilation is provided or the manufacturer's instruction has been adhered to.

Most appliances recommend they be placed upon a dedicated circuit;

That is, a single outlet circuit which powers only that appliance and has no additional outlets or branch circuits. Check the specification page of this owner's manual to be certain. Do not overload wall outlets. Overloaded wall outlets, loose or damaged wall outlets, extension cords, frayed power cords, or damaged or cracked wire insulation are dangerous. Any of these conditions could result in electric shock or fire. Periodically examine the cord of your appliance, and if its appearance indicates damage or deterioration, unplug it, discontinue use of the appliance, and have the cord replaced with an exact replacement part by an authorized service center. Protect the power cord from physical or mechanical abuse, such as being twisted, kinked, pinched, closed in a door, or walked upon. Pay particular attention to plugs, wall outlets, and the point where the cord exits the appliance. To disconnect power from the mains, pull out the mains cord plug. When installing the product, ensure that the plug is easily accessible.

This device is equipped with a portable battery or accumulator.

**Safety way to remove the battery or the battery from the equipment:** Remove the old battery or battery pack, follow the steps in reverse order than the assembly. To prevent contamination of the environment and bring on possible threat to human and animal health, the old battery or the battery put it in the appropriate container at designated collection points. Do not dispose of batteries or battery together with other waste. It is recommended that you use local, free reimbursement systems batteries and accumulators. The battery shall not be exposed to excessive heat such as sunshine, fire or the like.

**Europe Notice**

LG Electronics hereby declares that this/these product(s) is/are in compliance with the essential requirements and other relevant provisions of Directive 1999/5/EC, 2004/108/EC, 2006/95/EC and 2009/125/EC.

Please contact to the following address for obtaining a copy of the DoC (Declaration of Conformity).

European representative :  
 LG Electronics Service Europe B.V.  
 Veluwezoom 15, 1327  
 AE Almere. The Netherlands  
 (Tel : +31-(0)36-547-8888)

Indoor Use Only

**RF Radiation Exposure Statement**

This equipment should be installed and operated with minimum distance 20 cm between the radiator and your body.

**Italy Notice**

A general authorization is requested for outdoor use in Italy.

The use of these equipments is regulated by:

1. D.L.gs 1.8.2003, n. 259, article 104 (activity subject to general authorization) for outdoor use and article 105 (free use) for indoor use, in both cases for private use.
2. D.M. 28.5.03, for supply to public of RLAN access to networks and telecom services.

L'uso degli apparati è regolamentato da:

1. D.L.gs 1.8.2003, n. 259, articoli 104 (attività soggette ad autorizzazione generale) se utilizzati al di fuori del proprio fondo e 105 (libero uso) se utilizzati entro il proprio fondo, in entrambi i casi per uso private.
2. D.M. 28.5.03, per la fornitura al pubblico dell'accesso R-LAN alle reti e ai servizi di telecomunicazioni.

**Brazil Notice**

Este equipamento opera em caráter secundário, isto é, não tem direito a proteção contra interferência prejudicial, mesmo de estações do mesmo tipo, e não pode causar interferência a sistemas operando em caráter primário.

# Table of Contents

## 1 Getting Started

- 2 Safety Information
- 6 Unique Features
  - 6 - Portable In
  - 6 - Speaker ez (easy) Setup
- 6 Accessories
- 7 Introduction
  - 7 - Symbols Used in this Manual
- 7 Playable file
  - 7 - MP3/ WMA music file requirement
- 8 Remote control
- 9 Front panel
- 9 Rear panel

## 2 Connecting

- 10 Mounting the main unit on a wall
- 12 Setting up
  - 12 - Pairing wireless subwoofer
- 13 Optional Equipment Connection
  - 13 - AUDIO (PORT. IN) In Connection
  - 13 - Listening to music from your portable player
  - 13 - OPTICAL In connection
  - 13 - Speaker ez (easy) setup
- 14 - USB Playback

## 3 Operating

- 15 Basic Operations
  - 15 - USB Operation
- 15 Other Operations
  - 15 - DOLBY DRC (Dynamic Range Control)
  - 15 - AV Sync
  - 16 - Sleep Timer Setting
  - 16 - Dimmer
  - 16 - Turn off the sound temporarily
  - 16 - Adjust the woofer level settings
  - 16 - Displaying file and input source
- 17 Sound adjustment
  - 17 - Setting the surround mode
- 18 Controlling a TV with the Supplied Remote Control
  - 18 - Setting up the remote to control your TV

## 4 Troubleshooting

---

19 Troubleshooting

## 5 Appendix

---

20 Maintenance

20 – Handling the Unit

21 Trademarks and Licenses

22 Specifications

1

2

3

4

5

## Unique Features

1

Getting Started

### Portable In

Listen to music from your portable device. (MP3, Notebook, etc)

### Speaker ez (easy) Setup

Listen to sounds from TV, DVD or Digital device with vivid 2.1 or 2.0 ch mode.

## Accessories

Please check and identify the supplied accessories.



Remote control (1)

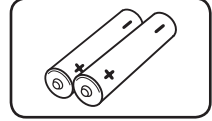

Batteries (2)

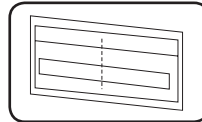

WALL BRACKET  
INSTALL GUIDE (1)

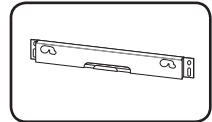

Wall bracket (1)

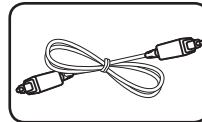

Optical cable (1)

## Introduction

### Symbols Used in this Manual

 **Note**

Indicates special notes and operating features.

 **Tip**

Indicates tip and hints for making the task easier.

 **Caution**

Indicates cautions for preventing possible damages from abuse.

## Playable file

### MP3/ WMA music file requirement

MP3/ WMA file compatibility with this unit is limited as follows :

- Sampling frequency : within 32 to 48 kHz (MP3), within 32 to 48 kHz (WMA)
- Bit rate : within 32 to 320 kbps (MP3), 40 to 192 kbps (WMA)
- Maximum files : Under 999
- File extensions : ".mp3"/ ".wma"

# Remote control

1  
Getting Started

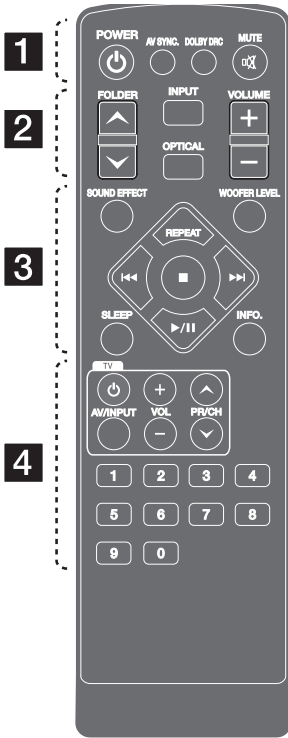

..... **1** .....

- POWER:** Switches the unit ON or OFF.
- AV SYNC:** Synchronizes the audio and video.
- DOLBY DRC:** Sets the Doby DRC.
- MUTE:** Mutes the sound.

..... **2** .....

- FOLDER:** Searches for a folder of MP3/ WMA files. When a USB containing MP3/ WMA files in several folders is being played, press FOLDER to select the folder you want to play.
- INPUT:** Changes input sources.
- OPTICAL:** Changes input source to optical directly.
- VOLUME:** Adjusts speaker volume.

..... **3** .....

- SOUND EFFECT:** Selects a sound effect mode.
- WOOFER LEVEL:** Sets the sound level of woofer.
- REPEAT:** Listens to your files repeatedly or randomly.
- ◀◀ / ▶▶:** Goes to next or previous file.
- :** Stops playback.
- ▶ / ||:** Starts playback. / Pauses playback.
- SLEEP:** Sets the system to turn off automatically at a specified time.
- INFO.:** Displays the file or input source information.

..... **4** .....

- TV Control buttons:** See page 18
- 0 to 9 numerical buttons:** Selects numbered numbered files. Enters the PIN code.

## Battery Installation

Remove the battery cover on the rear of the Remote Control, and insert two (size AAA) battery with **+** and **-** matched correctly.



## Front panel

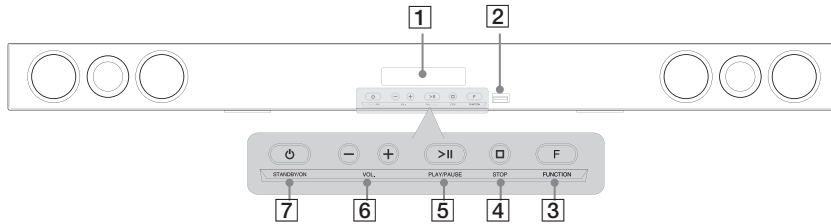

- |  |   |
|--|---|
| <p><b>1</b> Display</p> <p><b>2</b> USB Port</p> <p><b>3</b> <b>F</b> FUNCTION<br/>Press it repeatedly to select other function.</p> | <p><b>4</b> <b>□</b> STOP</p> <p><b>5</b> <b>&gt;  </b> PLAY / PAUSE</p> <p><b>6</b> <b>- VOL +</b><br/>Adjusts speaker volume.</p> <p><b>7</b> <b>⏻</b> STANDBY/ON</p> |
|--|---|

## Rear panel

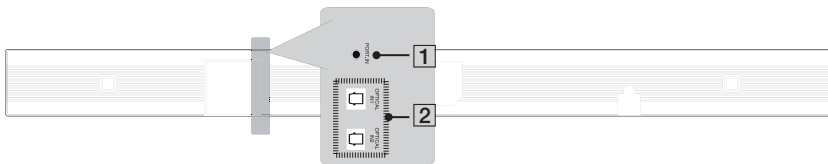

- |                              |                         |
|------------------------------|-------------------------|
| <b>1</b> PORT. (Portable) IN | <b>2</b> OPTICAL IN 1/2 |
|------------------------------|-------------------------|

# Mounting the main unit on a wall

You can mount the main unit on a wall. Prepare screws and brackets.

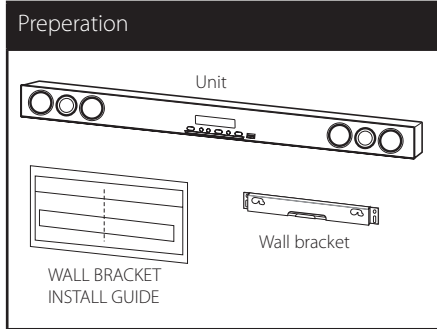

1. Match the TV's BOTTOM EDGE of WALL BRACKET INSTALL GUIDE with the bottom of TV and attach to the position.

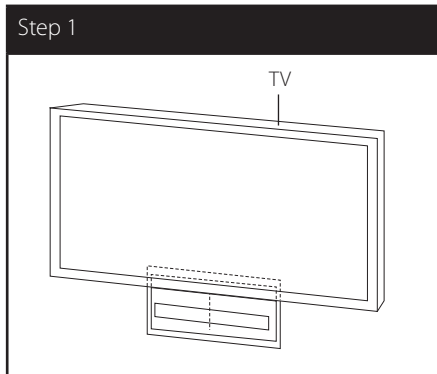

2. When you mount it on a wall (concrete), use the wall plugs (Not supplied). You should drill some holes. A guide sheet (WALL BRACKET INSTALL GUIDE) is supplied to drill. Use the sheet to check the point to drill.

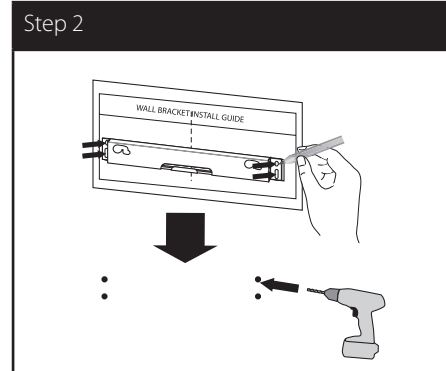

**Note**

Screws and Wall Plugs are not supplied for mounting the unit. We recommend the Hilti (HUD-1 6 x 30) for the mounting. Please purchase it.

2 Connecting

3. Remove the WALL BRACKET INSTALL GUIDE.
4. Fix it with screws (not supplied) as shown in the illustration below.

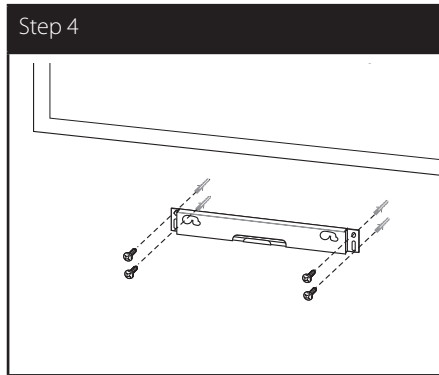

**! Note**

Detach the unit from the bracket as shown below.

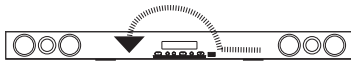

5. Hang the main unit onto the bracket as shown below.

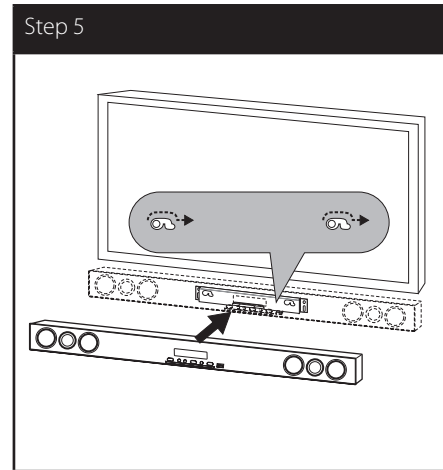

**! Note**

You can arrange power cord cable with the bracket as shown below.

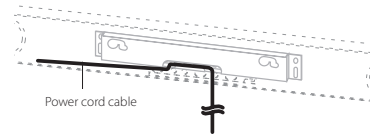

**! Caution**

- Do not hang onto the installed unit and avoid any impact to the unit.
- Secure the unit firmly to the wall so that it does not fall off. If the unit falls off, it may result in an injury or damage to the product.
- When the unit is installed on a wall, please make sure that a child does not pull any of connecting cables, as it may cause it to fall.

## Setting up

### Pairing wireless subwoofer

#### LED indicator of wireless subwoofer



LED Color	Status
Blue	The wireless subwoofer is receiving the signal of the unit.
Blue (blink)	The wireless subwoofer is trying to connect.
Red	The Wireless subwoofer is in standby mode.
Off (No display)	The Wireless subwoofer is turned off.

#### Setting up the wireless subwoofer for the first time

1. Connect the power cord of the Wireless subwoofer to the outlet.
2. Turn on the main unit : The main unit and wireless subwoofer will be automatically connected.

### Manually pairing wireless subwoofer

When your connection is not completed, you can see the red LED on the woofer and woofer is not made sound. To solve the problem, follow the below steps.

1. Press and hold  STOP button on the unit and  MUTE button on the remote control simultaneously.
  - Displays the "REMATE".
2. Press **PAIRING** on back of the woofer.
  - The blue LED will flicker
3. Turn off and on the unit.
  - If you see "blue" LED, it's successful.
4. If you don't see "blue" LED, try again Step 1 - Step 3.

#### Note

- If you operate main unit then wireless subwoofer (rear speakers) sound within a few seconds in standby mode.
- Set the distance between this unit and subwoofer Receiver within 10 m (32 ft.).
- Optimum performance can be implemented only when the unit and the Wireless subwoofer within distance of 2 m (6 ft.) to 10 m (32 ft.) is used since communication failure may occur if longer distance is used.
- It takes a few seconds (and may take longer) for the Wireless Transmitter and subwoofer to communicate with each other.

## Optional Equipment Connection

### AUDIO (PORT. IN) In Connection

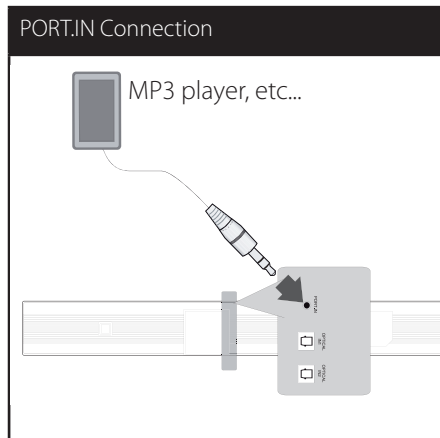

### Listening to music from your portable player

The unit can be used to play the music from many types of portable player or external devices.

1. Connect the portable player to the AUDIO (PORT. IN) IN connector of the unit.
2. Turn the power on by pressing **POWER**.
3. Select the PORTABLE function by pressing **INPUT**.
4. Turn on the portable player or external device and start playing it.

### OPTICAL In connection

Connect an optical output of Unit (or Digital Device etc) to the OPTICAL IN 1/2 connector.

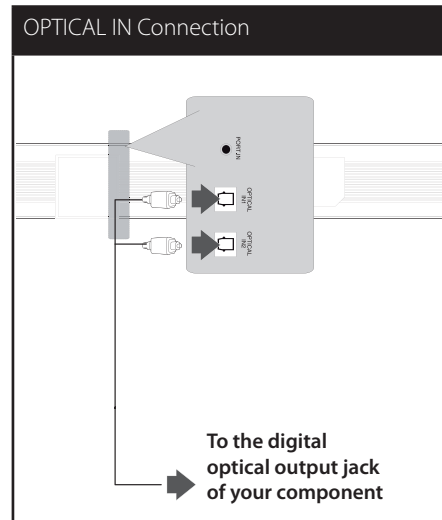

### Speaker ez (easy) setup

Listens to sound from TV or DVD or Digital Device with 2.1 or 2ch mode.

1. Connect the unit's OPTICAL IN 1/2 jack to jack on optical out of your TV (or Digital Device etc.).
2. Select the OPTICAL 1/2 by using the **OPTICAL**. To select the OPTICAL 1/2 directly
3. Listen to sound with 2.1 or 2ch speaker.
4. Press **OPTICAL** to exit from OPTICAL 1/2. Function is returned to previous one.

## USB Playback

Insert USB memory device to the USB port on the front of the unit.

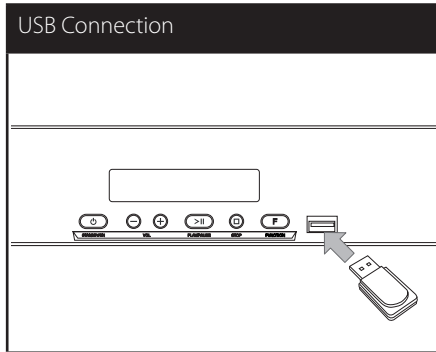

Removing the USB Device from the unit.

1. Choose a different function mode or press  STOP twice in a row.
2. Remove the USB device from the unit.

## Compatible USB Devices

- MP3 Player : Flash type MP3 player.
- USB Flash Drive : Devices that support USB2.0 or USB1.1.
- The USB function of this unit does not support some USB devices.

## USB device requirement

- Devices which require additional program installation connected to a computer, are not supported.
- Do not extract the USB device while in operation.
- For a large capacity USB, it may take longer than a few minutes to be searched.
- To prevent data loss, back up all data.
- If you use a USB extension cable or USB hub, the USB device is not recognized.
- Using NTFS file system is not supported. (Only FAT(16/32) file system is supported.)
- This unit is not supported when the total number of files is 1 000 or more.
- External HDD, Card readers, Locked devices, or hard type USB devices are not supported.
- The unit's USB Port cannot be connected to PC. The unit can not be used as a storage device.

## Basic Operations

### USB Operation

1. Connect the USB device to the USB port.
2. Select the USB function by pressing **INPUT**.
3. Select a file you want to play by pressing **◀◀** or **▶▶**.

To	Do this
Stop	Press <b>■</b>
Playback	Press <b>▶/  </b>
Pause	Press <b>▶/  </b>
Skipping to the next/ previous file	During playback, press <b>◀◀</b> or <b>▶▶</b> to go to the next file or to return to the beginning of the current file. Press <b>◀◀</b> twice briefly to step back to the previous file.
Playing repeatedly or randomly	Press <b>REPEAT</b> on the remote control repeatedly, the display change in the following order, RPT 1 → RPT D (DIRECTORY) → RPT ALL → RANDOM → OFF.
Selecting files directly	Press <b>0 to 9 numerical buttons</b> on the remote control to go to the desired file directly.

## Other Operations

### DOLBY DRC (Dynamic Range Control)

Make the sound clear when the volume is turned down (Dolby Digital only). Set to [DRC ON] by using **DOLBY DRC**.

### AV Sync

When receiving audio signals from TV, sound and images may not be matched. In the case, this function can adjust the delay time.

1. Press **AV SYNC**.
2. Use **◀◀▶▶** to scroll up and down through the delay amount, which you can set at anything between 0 and 300m/sec.

## Sleep Timer Setting

Press **SLEEP** one or more times to select delay time between 10 and 180 minutes, after the unit will turn off.

To check the remaining time, press **SLEEP**.

To cancel the sleep function, press **SLEEP** repeatedly until "SLEEP 10" appears, and then press **SLEEP** once again while "SLEEP 10" is displayed.

### Note

You can check the remaining time before the Unit turns off.

Press **SLEEP** The remaining time appears in the display window.

## Displaying file and input source

You can display various information on the USB and OPTICAL IN 1/ 2 mode by pressing **INFO.**

USB : MP3/WMA containing file information

OPTICAL IN 1/ 2 : Audio format, Audio channel

3

Operating

## Dimmer

Press **SLEEP** once. The display window will be darkened by half. To cancel it, press **SLEEP** repeatedly until dim off.

## Turn off the sound temporarily

Press  **MUTE** to mute your unit.

You can mute your unit in order, for example, to answer the telephone, appearing the  in the display window.

## Adjust the woofer level settings

You can adjust the sound level of woofer.

1. Press **WOOFER LEVEL**.
2. Press **VOLUME +/-** to adjust the sound level of the woofer.



# Sound adjustment

## Setting the surround mode

This system has a number of pre-set surround sound fields. You can select a desired sound mode by using **SOUND EFFECT**.

The displayed items for the equalizer may be different depending on sound sources and effects.

On Display	Description
NATURAL	You can enjoy comfortable and natural sound.
BYPASS	You can enjoy the sound without equalizer effect.
BASS	The BASS is Bass Blast. During playback, reinforce the treble, bass and surround sound effect.
CLRVOICE	The CLRVOICE is Clear Voice. This program make voice sound clear, improving the quality of voice sound. (We encourage to use this EQ when you watch the movie of 5.1 channel.)
VIRTUAL	The VIRTUAL is VSM Plus. You can enjoy more virtual surround sound.
GAME	The GAME is Game Equalizer. You can enjoy more virtual sound while playing video games.
NIGHT	The NIGHT is Night Mode. This may be useful when you want to watch movies at low volume late at night.
UPSCALER	The UPSCALER is MP3 Up-Scaling. When listening to MP3 files or other compressed music, you can enhance the sound. This mode is available only to 2 channel sources.
LOUDNESS	Improves the bass and treble sound.

### ! Note

- In some of surround modes, some speakers, there's no sound or low sound. It depends on the mode of surround and the source of audio, it is not defective.
- You may need to reset the surround mode, after switching the input, sometimes even after the sound file changed.

## Controlling a TV with the Supplied Remote Control

You can control your TV using the buttons below.

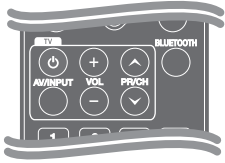

Button	Operation
(TV POWER)	Turn the TV on or off.
AV/INPUT	Switch the TV's input source between the TV and other input sources.
VOL +/-	Adjust the volume of the TV.
PR/CH ^ / V	Scan up or down through memorized channels.

### Note

Depending on the unit being connected, you may not be able to control your TV using some of the buttons.

## Setting up the remote to control your TV

You can operate your TV with the supplied remote control.

If your TV is listed in the table below, set the appropriate manufacturer code.

1. While holding down (TV POWER) button, and press the manufacturer code for your TV with the numerical buttons (see the table below).

Manufacturer	Code Number
LG	1(Default), 2
Zenith	1, 3, 4
GoldStar	1, 2
Samsung	6, 7
Sony	8, 9
Hitachi	4

2. Release the (TV POWER) button to complete setting.

Depending on your TV, some or all buttons may not function on the TV, even after entering the correct manufacturer code. When you replace the batteries of the remote, the code number you have set may be reset to the default setting. Set the appropriate code number again.

# Troubleshooting

PROBLEM	CORRECTION
No Power	Plug in the power cord.
	Check the condition by operating other electronic devices.
No sound	<p>Press FUNCTION and check the selected function.</p> <p>The power cord of woofer is not connected. Plug the power cord into the wall outlet securely.</p> <p>Pairing between the unit and woofer gets disconnected. Connect the unit and woofer. (Refer to the page 12)</p>
The remote control does not work properly.	The remote control is too far from the unit.
	Operate the remote control within about 23 ft (7m).
	<p>There is an obstacle in the path of the remote control and the unit.</p> <p>Remove the obstacle.</p>
	<p>The battery in the remote control is exhausted.</p> <p>Replace the battery with new one.</p>

# Maintenance

## Handling the Unit

### When shipping the unit

Please save the original shipping carton and packing materials. If you need to ship the unit, for maximum protection, re-pack the unit as it was originally packed at the factory.

Keeping the exterior surfaces clean

- Do not use volatile liquids such as insecticide spray near the unit.
- Wiping with strong pressure may damage the surface.
- Do not leave rubber or plastic products in contact with the unit for a long period of time.

### Cleaning the unit

To clean the player, use a soft, dry cloth. If the surfaces are extremely dirty, use a soft cloth lightly moistened with a mild detergent solution. Do not use strong solvents such as alcohol, benzine, or thinner, as these might damage the surface of the unit.

## Trademarks and Licenses



Manufactured under license from Dolby Laboratories. Dolby and the double-D symbol are trademarks of Dolby Laboratories.



Manufactured under license under U.S. Patent #s: 5,451,942; 5,956,674; 5,974,380; 5,978,762; 6,487,535 & other U.S. and worldwide patents issued & pending. DTS and the Symbol are registered trademarks & DTS Digital Surround and the DTS logos are trademarks of DTS, Inc. Product includes software. © DTS, Inc. All Rights Reserved.

---

# Specifications

General	
Power requirements	200 - 240 V ~ 50 / 60 Hz
Power consumption	30 W
Dimensions (W x H x D)	1 000 x 80 x 500 mm without foot
Net Weight (Approx.)	2.3 kg
Operating temperature	41 °F to 95 °F (5 °C to 35 °C)
Operating humidity	5 % to 90 %
Bus Power Supply (USB)	DC 5 V  500 mA

Inputs	
DIGITAL IN (OPTICAL IN)	3 V (p-p), Optical jack x 2
PORT. IN	0.5Vrms (3.5 mm stereo jack)

Amplifier	
Stereo mode	70 W + 70 W (4 Ω at 1 kHz)
Subwoofer	140 W (3 Ω at 60 Hz)

Wireless subwoofer	
Power requirements	200 - 240 V ~ 50 / 60 Hz
Power consumption	35 W
Reception Output	5.8 GHz
Type	1 Way 1 Speaker
Impedance Rated	3 Ω
Input Power	140 W
Max. Input Power	280 W
Net Dimensions (W x H x D)	196 X 392 X 317 mm
Net Weight	6.88 kg

Designs and specifications are subject to change without prior notice.

