



ENGLISH

# OWNER'S MANUAL

## Mini Hi-Fi System

Please read this manual carefully before operating your set and retain it for future reference.

RAT376B (RAT376B, RAS376BF/BW)  
RAD226B (RAD226B, RAS376BF)  
RAD136/ RAD136B (RAD136/ RAD136B, RAS136F/ RAS136BF)  
P/NO : MFL67006448

# Safety Information

1

Getting Started



**CAUTION:** TO REDUCE THE RISK OF ELECTRIC SHOCK DO NOT REMOVE COVER (OR BACK) NO USER-SERVICEABLE PARTS INSIDE REFER SERVICING TO QUALIFIED SERVICE PERSONNEL.



This lightning flash with arrowhead symbol within an equilateral triangle is intended to alert the user to the presence of uninsulated dangerous voltage within the product's enclosure that may be of sufficient magnitude to constitute a risk of electric shock to persons.



The exclamation point within an equilateral triangle is intended to alert the user to the presence of important operating and maintenance (servicing) instructions in the literature accompanying the product.

**WARNING:** TO PREVENT FIRE OR ELECTRIC SHOCK HAZARD, DO NOT EXPOSE THIS PRODUCT TO RAIN OR MOISTURE.

**WARNING:** Do not install this equipment in a confined space such as a book case or similar unit.

**CAUTION:** Do not block any ventilation openings. Install in accordance with the manufacturer's instructions.

Slots and openings in the cabinet are provided for ventilation and to ensure reliable operation of the product and to protect it from over heating. The openings shall be never be blocked by placing the product on a bed, sofa, rug or other similar surface. This product shall not be placed in a built-in installation such as a bookcase or rack unless proper ventilation is provided or the manufacturer's instruction has been adhered to.

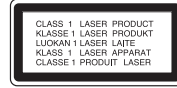

**CAUTION:** This product employs a Laser System.

To ensure proper use of this product, please read this owner's manual carefully and retain it for future reference. Shall the unit require maintenance, contact an authorized service center.

Use of controls, adjustments or the performance of procedures other than those specified herein may result in hazardous radiation exposure.

To prevent direct exposure to laser beam, do not try to open the enclosure. Visible laser radiation when open. **DO NOT STARE INTO BEAM.**

### CAUTION concerning the Power Cord

Most appliances recommend they be placed upon a dedicated circuit;

That is, a single outlet circuit which powers only that appliance and has no additional outlets or branch circuits. Check the specification page of this owner's manual to be certain. Do not overload wall outlets. Overloaded wall outlets, loose or damaged wall outlets, extension cords, frayed power cords, or damaged or cracked wire insulation are dangerous. Any of these conditions could result in electric shock or fire. Periodically examine the cord of your appliance, and if its appearance indicates damage or deterioration, unplug it, discontinue use of the appliance, and have the cord replaced with an exact replacement part by an authorized service center. Protect the power cord from physical or mechanical abuse, such as being twisted, kinked, pinched, closed in a door, or walked upon. Pay particular attention to plugs, wall outlets, and the point where the cord exits the appliance. To disconnect power from the mains, pull out the mains cord plug. When installing the product, ensure that the plug is easily accessible.

This device is equipped with a portable battery or accumulator.

**Safety way to remove the battery or the battery from the equipment:** Remove the old battery or battery pack, follow the steps in reverse order than the assembly. To prevent contamination of the environment and bring on possible threat to human and animal health, the old battery or the battery put it in the appropriate container at designated collection points. Do not dispose of batteries or battery together with other waste. It is recommended that you use local, free reimbursement systems batteries and accumulators. The battery shall not be exposed to excessive heat such as sunshine, fire or the like.

**CAUTION:** The apparatus shall not be exposed to water (dripping or splashing) and no objects filled with liquids, such as vases, shall be placed on the apparatus.

#### Disposal of your old appliance



1. When this crossed-out wheeled bin symbol is attached to a product it means the product is covered by the European Directive 2002/96/EC.
2. All electrical and electronic products should be disposed of separately from the municipal waste stream via designated collection facilities appointed by the government or the local authorities.
3. The correct disposal of your old appliance will help prevent potential negative consequences for the environment and human health.
4. For more detailed information about disposal of your old appliance, please contact your city office, waste disposal service or the shop where you purchased the product.

The equipment complies with requirements of the Technical Regulation, in terms of restrictions for the use of certain dangerous substances in electrical and electronic equipment.

## Copyrights

It is forbidden by law to copy, broadcast, show, broadcast via cable, play in public, or rent copyrighted material without permission. This product features the copy protection function developed by Macrovision. Copy protection signals are recorded on some discs. When recording and playing the pictures of these discs picture noise will appear. This product incorporates copyright protection technology that is protected by U.S. patents and other intellectual property rights. Use of this copyright protection technology must be authorized by Macrovision, and is intended for home and other limited viewing uses only unless otherwise authorized by Macrovision. Reverse engineering or disassembly is prohibited.

CONSUMERS SHOULD NOTE THAT NOT ALL HIGH DEFINITION TELEVISION SETS ARE FULLY COMPATIBLE WITH THIS PRODUCT AND MAY CAUSE ARTIFACTS TO BE DISPLAYED IN THE PICTURE. IN CASE OF 525 OR 625 PROGRESSIVE SCAN PICTURE PROBLEMS, IT IS RECOMMENDED THAT THE USER SWITCH THE CONNECTION TO THE 'STANDARD DEFINITION' OUTPUT. IF THERE ARE QUESTIONS REGARDING OUR TV SET COMPATIBILITY WITH THIS MODEL 525p AND 625p UNIT, PLEASE CONTACT OUR CUSTOMER SERVICE CENTER.

You have to set the disc format option to [Mastered] in order to make the discs compatible with the LG players when formatting rewritable discs. When setting the option to Live File System, you cannot use it on LG players.

(Mastered/ Live File System : Disc format system for Windows Vista)

## Table of Contents

### 1 Getting Started

---

- 2 Safety Information
- 6 Unique Features
- 6 Accessories
- 6 Playable file Requirement
  - 6 – MP3/ WMA music file requirement
  - 6 – Compatible USB Devices
  - 6 – USB device requirement
- 7 Remote control
- 8 Front panel
- 10 Rear panel

### 2 Connecting

---

- 11 Connecting to speakers
  - 11 – Attaching the speakers to the unit
- 11 Optional Equipment Connection
  - 11 – AUX IN Connection
  - 12 – USB Connection
  - 12 – Antenna Connection

### 3 Operating

---

- 13 Basic Operations
  - 13 – CD/ USB Operations
  - 13 Other Operations
    - 13 – Programmed Playback
    - 13 – Displaying file information (ID3 TAG)
    - 13 – Turn off the sound temporarily
    - 13 – DEMO
    - 14 – AUTO DJ playback
  - 14 Radio Operations
    - 14 – Listening to the radio
    - 14 – Presetting the Radio Stations
    - 15 – Deleting all the saved stations
    - 15 – Improving poor FM reception
  - 15 Sound adjustment
    - 15 – Setting the surround mode
  - 16 Setting the Clock
    - 16 – Using your player as an alarm clock
    - 17 – Sleep Timer Setting
    - 17 – Dimmer
  - 17 Advanced Operations
    - 17 – Listening to music from your external device
    - 17 – Recording to USB
    - 18 – To select recording bit rate and speed

## 4 Troubleshooting

---

- 19 Troubleshooting
- 19 - General

## 5 Appendix

---

- 20 Trademarks and Licenses
- 21 Specifications
- 23 Maintenance
- 23 - Notes on Discs
- 23 - Handling the Unit

1

2

3

4

5

## Unique Features

### USB Direct Recording

Records music to your USB device.

## Accessories

Please check and identify the supplied accessories.

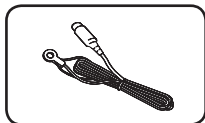

FM Antenna (1)

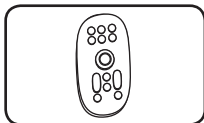

Remote Control (1)

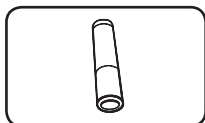

Battery (1)

## Playable file Requirement

### MP3/ WMA music file requirement

MP3/ WMA file compatibility with this unit is limited as follows :

- Sampling frequency : within 32 to 48 kHz (MP3), within 32 to 48 kHz (WMA)
- Bit rate : within 32 to 320 kbps (MP3), 40 to 192 kbps (WMA)
- Maximum files : Under 999
- File extensions : “.mp3”/ “.wma”
- CD-ROM file format : ISO9660/ JOLIET
- We recommend that you use Easy-CD Creator, which creates an ISO 9660 file system.

### Compatible USB Devices

- MP3 Player : Flash type MP3 player.
- USB Flash Drive :  
Devices that support USB2.0 or USB1.1.
- The USB function of this unit does not support all USB devices.

### USB device requirement

- Devices which require additional program installation when you have connected it to a computer, are not supported.
- Do not extract the USB device while in operation.
- For a large capacity USB, it may take longer than a few minute to be searched.
- To prevent data loss, back up all data.
- If you use a USB extension cable or USB hub, the USB device is not recognized.
- Using NTFS file system is not supported. (Only FAT(16/ 32) file system is supported.)
- This unit is not supported when the total number of files is 1 000 or more.
- External HDD, Card readers, Locked devices, or hard type USB devices are not supported.
- USB port of the unit cannot be connected to PC. The unit cannot be used as a storage device.

## Remote control

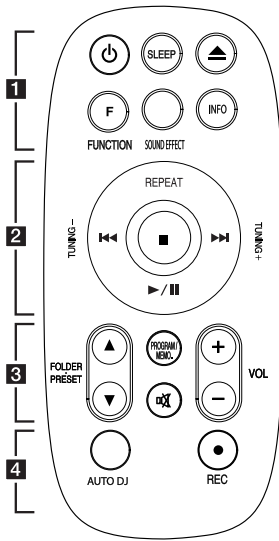

### Battery Installation

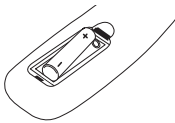

Remove the battery cover on the rear of the Remote Control, and insert one (size AAA) battery with **+** and **-** matched correctly

..... **1** .....

**⏻ (POWER):** Switches the unit ON or OFF.

**SLEEP:** Sets the system to turn off automatically at a specified time. (Dimmer : The display window will be darkening by half.)

**▲ (OPEN/CLOSE):** Opens and closes the disc tray.

**F (FUNCTION):** Selects the fuction and input source.

**SOUND EFFECT:** Chooses sound impressions.

**INFO.:** Checks information about your music. MP3 files often come with tags. The tag gives the Title, Artist, Album or Time information.

..... **2** .....

**REPEAT:** Listens to your tracks repeatedly or randomly.

**TUNING -/+:** Selects the radio station.

**⏮/⏭ (Skip/Search):**

-Skips Fast backward or Forward.  
-Searches for a section within a track.

**▶/⏸ (Play/Pause):** Starts or pauses playback.

**■:** Stops playback or recording.

..... **3** .....

**FOLDER · PRESET ▲/▼:** Searches for a folder of MP3/WMA files.

When a CD/ USB containing MP3/WMA files in several folders is being played, press

**FOLDER · PRESET ▲/▼** selects to the folder you want to play. Choose a 'preset number' for a radio station.

**PROGRAM/MEMO.:**

- For storing radio stations if you have saved radio stations using **PROGRAM/MEMO.**, you can scroll through them and select one.

- Listens to your tracks in any order.

**🔇 (MUTE):** Mutes the sound.

**VOLUME +/-:** Adjusts speaker volume.

..... **4** .....

**AUTO DJ:** Selects the AUTO DJ mode. (For more information refer to the page 14)

● **REC:** USB direct recording.





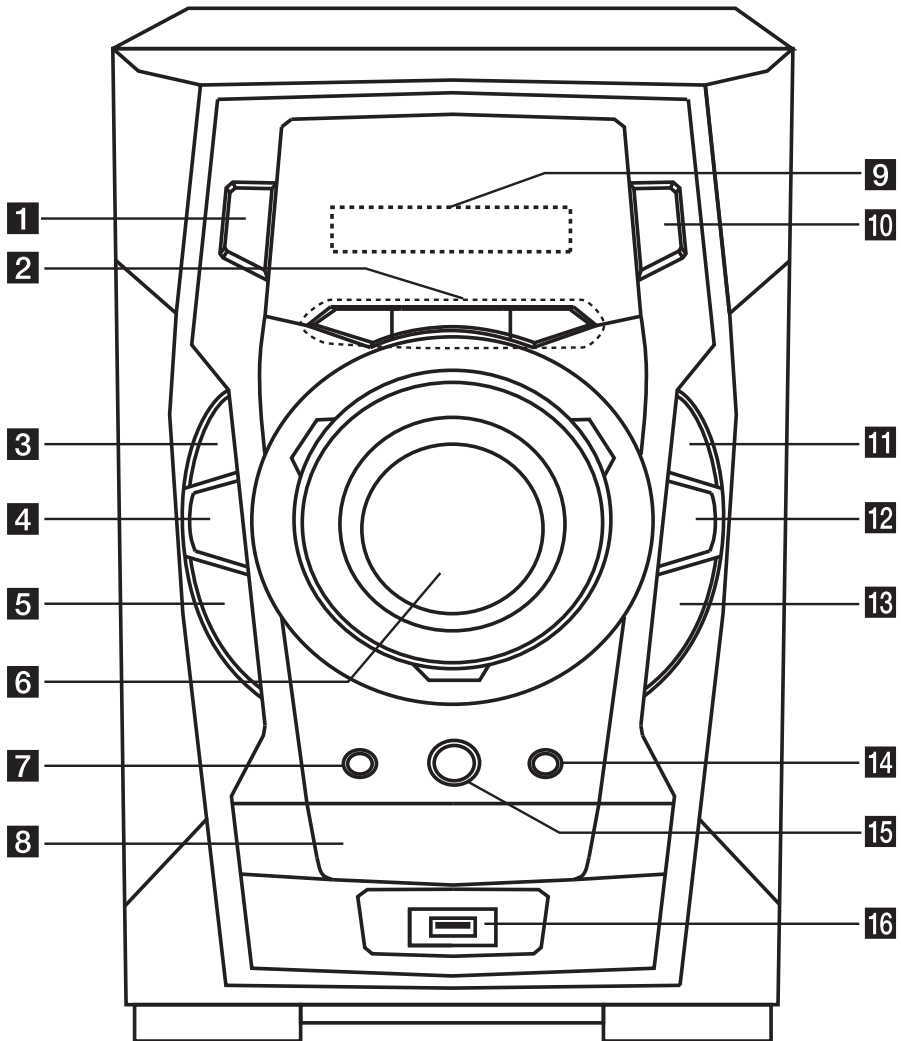

## Front panel

1

Getting Started





- 1**  **(Power)**
- 2** **TIMER**  
With the TIMER function you can turn CD, USB play and TUNER reception on or off at a desired time.  
**SET/ DEMO**  
Confirms the setting. / show demo.  
**CLOCK**  
For setting the clock and checking the time.
- 3**  **STOP**
- 4** **BASS BLAST**  
Reinforces the treble, bass and surround effect.
- 5**  **TUN. - (Skip/Search)**
- 6** **VOLUME**
- 7** **R (REC)**  
Recoding to USB.
- 8** **Disc tray**
- 9** **Display window**
- 10** **FUNC.**  
Selects the function or input source.
- 11**  **ST./ MO.**  
Starts playback and pauses. Selects Mono/ Stereo.
- 12** **EQ**  
Chooses sound impressions.
- 13**  **TUN. + (Skip/Search)**
- 14**  **(OPEN/CLOSE)**
- 15** **AUTO DJ**  
Selects the AUTO DJ mode. (For more informaion refer to the page 14).
- 16** **USB Port**  
You can play or recoding sound files by connecting the USB device.

# Rear panel

1

Getting Started

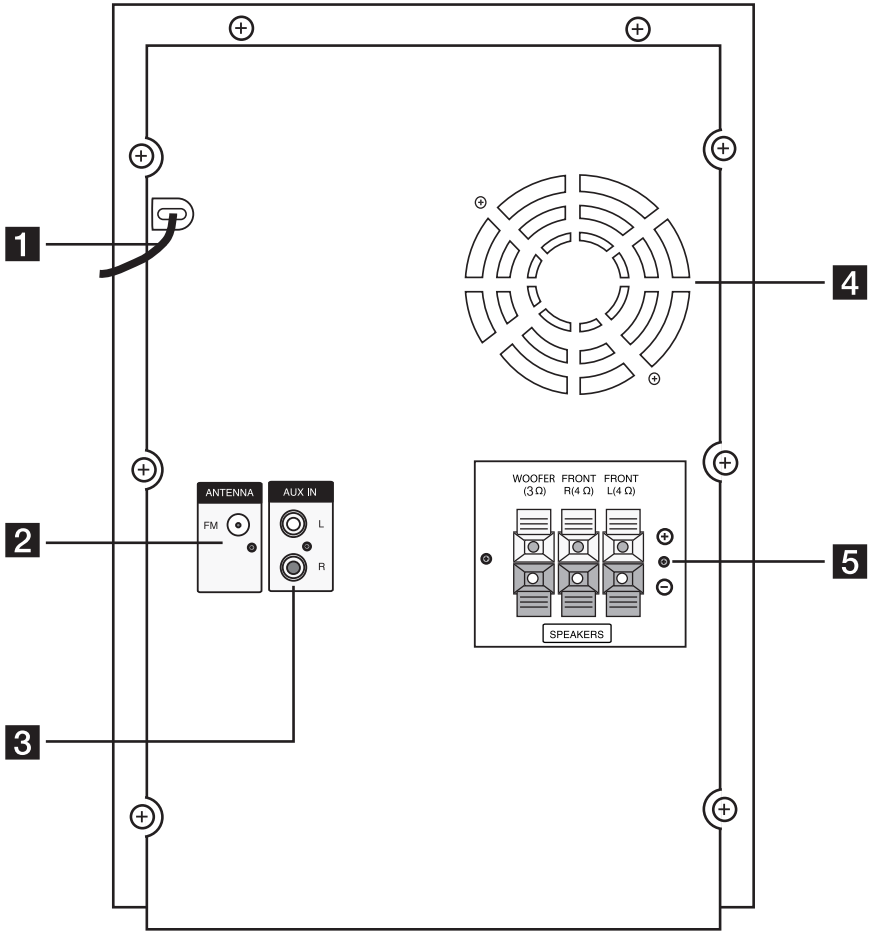

- 1** Power cord
- 2** ANTENNA (FM)
- 3** AUX IN connectors
- 4** Cooling fan (RAD376B)
- 5** Speaker terminal

## RAD136(B)/ RAD226B Speaker terminal

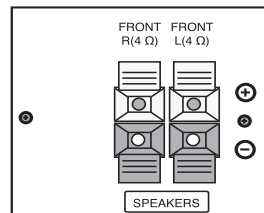

## Connecting to speakers

### Attaching the speakers to the unit

To connect the cable to the unit, press each plastic finger pad to open the connection terminals on the unit. Insert the wire and release the finger pad.

Connect the black stripe of each wire to the terminals marked - (minus) and the other end to the terminals marked + (plus).

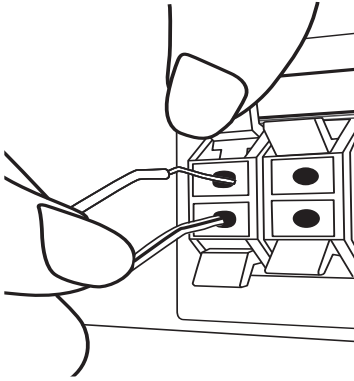

#### ⚠ Caution

- Be careful to make sure children not to put their hands or any objects into the \*speaker duct.  
\*Speaker duct: A hole for plentiful bass sound on speaker cabinet. (enclosure)
- The speakers contain magnet parts, so color irregularity may occur on the TV screen or PC monitor screen. Please use the speakers far away from either TV screen or PC monitor.
- Make sure to install the speaker with other people in order to prevent it from falling and causing injuries to the installer.

## Optional Equipment Connection

### AUX IN Connection

Connect an output of auxiliary device (Camcorder, TV, Player, etc) to the AUX AUDIO Input (L/R) connector.

If your device has only one output for audio (mono), connect it to the left (white) audio jack on the unit.

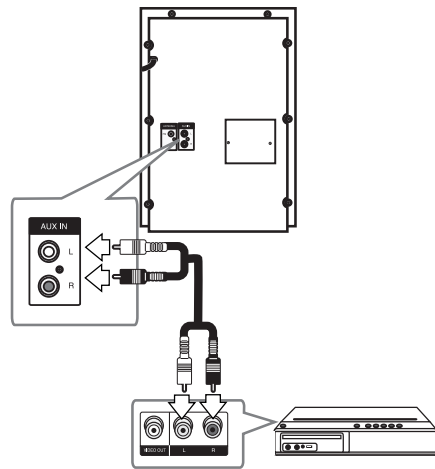

## USB Connection

Connect the USB port of USB Memory (or MP3 player, etc.) to the USB port on the front of the unit.

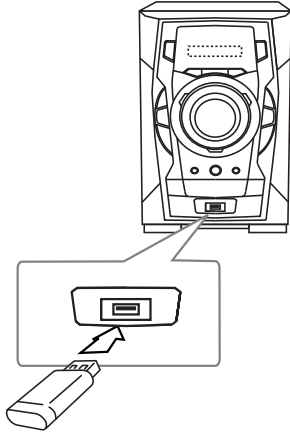

### ! Note

- Removing the USB Device from the unit
  1. Choose a different function/ mode or press **■ STOP** twice in a row.
  2. Remove the USB device from the unit.

## Antenna Connection

Connect the supplied FM antenna for listening to the radio.

Connect the FM wire antenna to the FM antenna connector.

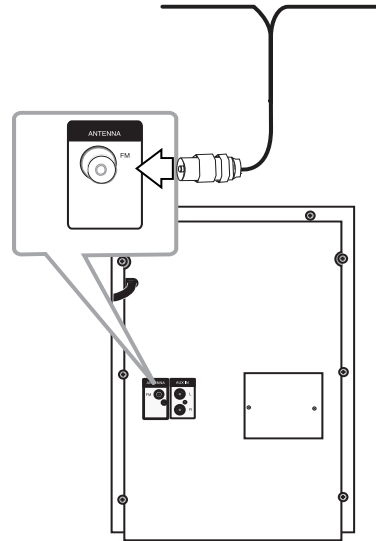

### ! Note

Be sure to fully extend the FM wire antenna. After connecting the FM wire antenna, keep it horizontal.

## Basic Operations

### CD/ USB Operations

1. Insert the disc by pressing **▲ (OPEN/CLOSE)** or connect the USB device to the USB port.
2. Select the **CD** or **USB** function by pressing **F (FUNCTION)**.
3. Select a file (or track) you want to play by pressing **◀◀/▶▶**.

To	Do this
Stop	Press <b>■</b>
Playback	Press <b>▶/  </b>
Pause	Press <b>▶/  </b>
Skipping to the next/previous track/ file	During playback, press <b>◀◀/▶▶</b> to go to the next track/ file or to return to the beginning of the current track/ file. Press <b>◀◀</b> twice briefly to step back to the previous track/ file.
Searching for a section within a track	Press and hold <b>◀◀/▶▶</b> during playback and release it at the point you want to listen to.
Playing repeatedly or randomly	Press <b>REPEAT</b> on the remote control repeatedly, the display change in the following order, RPT1 -> RPT DIR (only MP3/WMA) -> RPT ALL -> RANDOM -> OFF

## Other Operations

### Programmed Playback

The program function enables you to store your favorite files from any disc or USB device.

A program can contain 20 tracks.

1. Insert a CD or USB and wait for it to be order.
2. Press **PROGRAM/MEMO.** on the remote control in stop status.
3. Press **◀◀/▶▶** on the unit or on the remote control in stop satus.
4. Press **PROGRAM/MEMO.** again to save and select a next track.
5. Press **▶/||** to play the programmed music files.

6. To clear your selection, press **■**, **PROGRAM/MEMO.** and then **■**.

#### ! Note

The programs are also cleared when the disc or USB device is removed, the unit is powered off or the function is switched to others.

### Displaying file information (ID3 TAG)

While playing an MP3 file containing file information, you can display the information by pressing **INFO.**

### Turn off the sound temporarily

Press **⊗ MUTE** to mute your unit.

You can mute your unit, for example, to answer the telephone, the "MUTE" is displayed in the display window.

### DEMO

In the power off state, it demonstrates the function on display window by pressing **DEMO.** To cancel the DEMO, press it again.

#### ! Note

- While DEMO, this unit will keep DEMO status even if you unplug the power cord connection.
- You can enjoy other functions during the DEMO. Then the DEMO will pause to temporary.  
- Without input key in 10 sec, the DEMO will play back automatically.

## AUTO DJ playback

Auto DJ blends the end of one song into the beginning of another for seamless playback. It equalizes volume across tracks for uninterrupted playback.

Press **AUTO DJ** on the remote control or unit repeatedly, the display changes as follows.  
 RANDOM (AUTO DJ RANDOM) -> RPT (AUTO DJ SEQUENTIAL) -> (AUTO DJ OFF)

Mode	Display Window	Description
OFF	- (AUTO DJ OFF)	-
RANDOM	RANDOM (AUTO DJ RANDOM)	The music is played randomly on this mode.
REPEAT	RPT (AUTO DJ SEQUENTIAL)	The music is played repeatedly on this mode.

### ! Note

- Searching for a section within a track or playing repeatedly or randomly is not supported on the AUTO DJ mode.
- If you move to other functions or stop the music using **STOP** on the unit (or **STOP** on the remote control) on AUTO DJ mode, AUTO DJ function will be disabled.
- AUTO DJ function is not supported in the music file whose length is less than 60 seconds.
- During recording, AUTO DJ function is not available.
- If you change a disc while the AUTO DJ function is activated, the function is deactivated.

## Radio Operations

Be sure that FM aerial is connected.  
 (Refer to the page 12)

### Listening to the radio

1. Press **F (FUNCTION)** until FM appears in the display window.  
 The last received station is tuned in.
2. Press and hold **TUNING +/-** for about two seconds until the frequency indication starts to change, then release. Scanning stops when the unit tunes in a station.  
 Or  
 Press **TUNING +/-** repeatedly.
3. Adjust the volume by rotating **VOLUME** on the unit or by pressing **VOL +/-** on the remote control repeatedly.

### Presetting the Radio Stations

You can preset 50 stations for FM.

Before tuning, make sure to turn down the volume.

1. Press **F (FUNCTION)** until FM appears in the display window.
2. Select the desired frequency by pressing **TUNING +/-**.
3. Press **PROGRAM/MEMO**. a preset number will flash in the display window.
4. Press **FOLDER · PRESET ▲/▼** to select the preset number you want.
5. Press **PROGRAM/MEMO**. The station is stored.
6. Repeat steps 2 to 5 to store other stations.

## Deleting all the saved stations

1. Press and hold **PROGRAM/MEMO.** for two seconds. "ERASE ALL" will flash up on the unit display.
2. Press **PROGRAM/MEMO.** to erase all saved radio stations.

## Improving poor FM reception

Press **▶/II ST./ MO.** on the unit or on the remote control. This will change the tuner from stereo to mono and usually improve the reception.

## Sound adjustment

### Setting the surround mode

This system has a number of pre-set surround sound fields. You can select a desired sound mode by using **SOUND EFFECT** on the remote control or **EQ** on the unit.

The displayed items for the Equalizer may be different depending on sound sources and effects.

On Display	Description
NATURAL	You can enjoy comfortable and natural sound.
Local Specialization equalizer	Regionally optimized sound effect. (FORRO/ FUNK/ SERTANEJO/ DANGDUT/ ARABIC/ PERSIAN/ INDIA/ REGUETON/ MERENGUE/ SALSA/ SAMBA/ CUMBIA/ AFRO)
AUTO EQ	Realizes the sound equalizer that is the most similar to the genre of which is included in the MP3 ID3 tag of song files.
POP CLASSIC JAZZ ROCK	This program lends an enthusiastic atmosphere to the sound, giving you the feeling you are at an actual rock pop, jazz or classic concert.
MP3 -- OPT	This function is optimized for compressible MP3 file. It improves the treble sound.
BASS	Reinforces the treble, bass and surround sound effect.
LOUDNESS	Improves the bass and treble sound.
VIRTUAL	You can enjoy more virtual surround sound.
BYPASS	You can enjoy the sound without equalizer effect.

### ! Note

- On some speakers, sound may not be heard or heard in low sound depending on the sound mode.
- Maybe you need reset the surround mode, after switching the input, sometimes even after the sound track changed.
- By pressing **BASS BLAST** on the unit you can directly select the **BYPASS** or **BASS BLAST** sound.

## Setting the Clock

1. Turn the unit on.
2. Press **CLOCK** for at least 2 seconds.
3. Choose time mode by pressing **◀◀/▶▶**.  
- AM 12:00 (for an AM and PM display) or 0:00 (for a 24 hour display)
4. Press **SET** to confirm your selection.
5. Select the hours by pressing **◀◀/▶▶**.
6. Press **SET**.
7. Select the minutes by pressing **◀◀/▶▶**.
8. Press **SET**.

## Using your player as an alarm clock

1. Turn the unit on.
2. Press **TIMER**. Each functions flashes.
3. Press **SET** when the function you want to be woken by is showing.
4. "ON TIME" will be displayed. This is your desired time to unit turns on. Press **◀◀/▶▶** to change the hours and minutes and press **SET** to save.
5. The "OFF TIME" will be displayed. This is your desired time to unit turns off.
6. Press **◀◀/▶▶** to change the hours and minutes and press **SET** to save.
7. Press **◀◀/▶▶** to change the volume and press **SET** to save. The clock icon "⌚" shows that the alarm is set.
8. Press **TIMER** button 2 times. You can check the setting status.

### ! Note

- If you set the clock time, you can check the time by pressing **CLOCK** even when the player is turned off.
- If you set the clock time and alarm, you can check the alarm icon "⌚" by pressing **CLOCK** even when the player is turned off.
- If you set the clock time and alarm, you can check the alarm icon "⌚" and setting information by pressing **TIMER** even when the unit is turned off.



## Sleep Timer Setting

Press **SLEEP** repeatedly to select delay time between 10 and 180 minutes. After the delay time, unit will turn off.

To cancel the sleep function, press **SLEEP** repeatedly until "SLEEP 10" appears, and then press **SLEEP** once again while "SLEEP 10" is displayed.

### Note

- You can check the remaining time before the unit turns off.
- Press **SLEEP**. The remaining time appears in the display window.

## Dimmer

Press **SLEEP** once. The display window will be darkening by half. To cancel it, press **SLEEP** repeatedly until dim off.

## Advanced Operations

### Listening to music from your external device

The unit can be used to play the music from many types of external device.  
(Refer to the page 11)

1. Connect the external device to the AUX IN connector of the unit.
2. Turn the power on by pressing  (Power).
3. Select the AUX function by pressing **F (FUNCTION)**.
4. Turn the external device and start it playing.



### Recording to USB

1. Connect the USB device to the unit.
2. Select a function by pressing **F (FUNCTION)**.

One track recording - You can record to USB after playing a file you want.

All tracks recording - You can recording to USB after stop.

Program list recording - After showing the programmed list, you can record it to USB.

3. Start the recording by pressing **R** on the unit or  **REC** on the remote control.
4. To stop recording, press  **STOP**.

## Pausing recording

During recording, press **R** on the unit or **● REC** on the remote control to pause recording. Press it again to restart recording. (Only Radio/ AUX)

## To select recording bit rate and speed

1. Press **R** on the unit or **● REC** on the remote control for longer than 3 seconds.
2. Use **⏮/⏭** on the unit or remote control to select the bit rate.
3. Press **R** on the unit or **● REC** on the remote control again to select the recording speed.
4. Press **⏮/⏭** on the unit or on the remote control to select a desired recording speed; (Only AUDIO CD)

### X1 SPEED

- You can listen to music while recording it.

### X2 SPEED

- You can just record the music file.

5. Press **R** on the unit or **● REC** on the remote control to finish the setting.

## ! Note

- You can check the recording percentage rate for the USB record on the display window during the recording. (MP3/ WMA CD Only)
- During recording MP3/ WMA, there is no sound.
- When you stop recording during playback, the file that has been recorded at that time will be stored. (AUDIO CD Only)
- Do not remove the USB device or turn off the unit during USB recording. If not, an incomplete file may be made and not deleted on PC.
- If USB recording does not work, the message like "NO USB", "ERROR", "FULL" or "NO REC" is displayed on the display window.
- Multi card reader device or External HDD can not be used for USB recording.
- A file is recorded by about 512 Mbyte when you record for a long term.
- When you stop recording during playback, the file will not be stored.
- You may not store more than 999 files.
- It'll be stored as follows.

AUDIO CD	MP3/ WMA	The other source*
<pre> CD_REC ├── TRK_001 ├── TRK_002 ├── ⋮           </pre>	<pre> FILE_REC ├── ABC(File name) ├── DEF(File name) ├── ⋮           </pre>	<pre> EXT_REC ├── AUDIO_001 ├── AUDIO_002 ├── ⋮           </pre>

The making of unauthorized copies of copy-protected material, including computer programs, files, broadcasts and sound recordings, may be an infringement of copyrights and constitute a criminal offense. This equipment should not be used for such purposes.

**Be responsible**  
**Respect copyrights**

# Troubleshooting

## General

Problem	Cause & Correction
No Power.	<ul style="list-style-type: none"> <li>• The power cord is not plugged in. Plug in the power cord.</li> <li>• Check whether electricity failed. Check the condition by operating other electronic devices.</li> </ul>
No sound.	<ul style="list-style-type: none"> <li>• Check whether you select right function. Press FUNCTION and check the selected function.</li> <li>• If not, connect speaker cables correctly. Speaker cables connected correctly.</li> </ul>
The unit does not start playback.	<ul style="list-style-type: none"> <li>• An unplayable disc is inserted. Insert a playable disc.</li> <li>• No disc is inserted. Insert a disc.</li> <li>• The disc is dirty. Clean the disc. (Refer to the 23 page)</li> <li>• The disc is inserted upside down. Place the disc with the label or printed side facing upwards.</li> </ul>
Radio stations cannot be tuned in properly.	<ul style="list-style-type: none"> <li>• The antenna is positioned or connected poorly. Connect the antenna securely.</li> <li>• The signal strength of the radio station is too weak. Tune to the station manually.</li> <li>• No stations have been preset or preset stations have been cleared. (when tuning by scanning preset channels) Preset some radio stations, see page 14 for details.</li> </ul>
The remote control does not work properly.	<ul style="list-style-type: none"> <li>• The remote control is too far from the unit. Operate the remote control within about 23 ft. (7 m)</li> <li>• There is an obstacle in the path of the remote control and the unit. Remove the obstacle.</li> <li>• The batteries in the remote control are exhausted. Replace the batteries with new ones.</li> </ul>

# Trademarks and Licenses

---



## Specifications

General			
Model	RAT376B	RAD226B	RAD136/ RAD136B
Power requirements	200 - 240 V ~ 50 / 60 Hz		
Power consumption	60 W	60 W	30 W
Dimensions (W x H x D)	202 x 307 x 297.5 mm without foot		
Net Weight (Approx.)	3.4 kg	3.2 kg	3.1 kg
Operating temperature	5 °C to 35 °C (41 °F to 95 °F)		
Operating humidity	5 % to 90 %		
Bus Power Supply (USB)	DC 5 V  500 mA		

Inputs/ Outputs	
ANALOG AUDIO IN	2.0 Vrms (1 kHz, 0 dB), 600 Ω, RCA jack (L, R) x 1

Tuner	
FM Tuning Range	87.5 to 108.0 MHz or 87.50 to 108.00 MHz

Amplifier				
Model		RAT376B	RAD226B	RAD136/ RAD136B
Stereo mode		110 W + 110 W (4 Ω at 1 KHz, THD 10 %)	110 W + 110 W (4 Ω at 1 KHz, THD 10 %)	65 W + 65 W (4 Ω at 1 KHz, THD 10 %)
Surround mode	Front	110 W + 110 W (4 Ω at 1 KHz, THD 10 %)		
	Subwoofer	150 W (3 Ω at 60 Hz, THD 10 %)		

CD	
Frequency Response	40 to 20 000 Hz
Signal-to-noise ratio	75 dB
Dynamic range	80 dB

Front speaker			
Model	RAT376B	RAD226B	RAD136/ RAD136B
Type	2 Way 2 speaker		
Impedance	4 Ω		
Rated Input Power	110 W	110 W	65 W
Max. Input power	220 W	220 W	130 W
Net Dimensions (W x H x D)	232 x 360 x 265 mm	232 x 360 x 265 mm	214 x 308 x 245 mm
Net Weight	3.15 kg	3.15 kg	2.51 kg

Passive subwoofer	
Model	RAT376B
Type	1 Way 1 speaker
Impedance	3 Ω
Rated Input Power	150 W
Max. Input power	300 W
Net Dimensions (W x H x D)	250 x 345 x 330 mm
Net Weight	5.35 kg

- Design and specifications are subject to change without notice.

# Maintenance

## Notes on Discs

### Handling Discs

Never stick paper or tape on the disc.

### Storing Discs

After playing, store the disc in its case. Do not expose the disc to direct sunlight or sources of heat and never leave it in a parked car exposed to direct sunlight.

### Cleaning Discs

Do not use strong solvents such as alcohol, benzene, thinner, commercially available cleaners, or anti-static spray intended for older vinyl records.

## Handling the Unit

### When shipping the unit

Please save the original shipping carton and packing materials. If you need to ship the unit, for maximum protection, re-pack the unit as it was originally packed at the factory.

### Keeping the exterior surfaces clean

Do not use volatile liquids such as insecticide spray near the unit.

Wiping with strong pressure may damage the surface.

Do not leave rubber or plastic products in contact with the unit for a long period of time.

### Cleaning the unit

To clean the player, use a soft, dry cloth. If the surfaces are extremely dirty, use a soft cloth lightly moistened with a mild detergent solution. Do not use strong solvents such as alcohol, benzene, or thinner, as these might damage the surface of the unit.

### Maintaining the Unit

The unit is a high-tech, precision device. If the optical pick-up lens and disc drive parts are dirty or worn, the picture quality could be diminished. For details, please contact your nearest authorized service center.



Импортер LG Electronics RUS

Адрес импортера 143160 Российская Федерация,  
Московская область, Рузский район, сельское поселение  
Дороховское, 86 км. Минского шоссе, д.9

Адрес производителя : ЛГ Электроникс инк. Китай, г.  
Хучжоу, Индустриальный парк, Зона  
развития Зонг Каи, ул. Хью Фенг  
Донг, 13

	Телефон	Режим работы	Интернет
<b>Россия</b>	8-800-200-7676	Круглосуточно	<a href="http://www.lg.com">http://www.lg.com</a>
<b>Беларусь</b>	8-820-0071-1111		
<b>Латвия</b>	8-0003-271		
<b>Литва</b>	8-800-30-800		
<b>Эстония</b>	800-9990		
<b>Украина</b>	0-800-303-000	8:00 - 21:00 (Пн.-Пят.) 9:00 - 18:00 (Суб., Вс.)	
<b>Казахстан</b>	8-8000-805-805	9:00 - 18:00 (Пн.-Пят.) 9:00 - 18:00 (Суб.)	
	2255 (для мобильных телефонов)		
<b>Кыргызстан</b>	8-0000-710-005	Круглосуточно	
<b>Узбекистан</b>			

Сделано в Китае