



OWNER'S MANUAL

CLEANING ROBOT

Before using, please carefully read the Safety Precautions pages to allow for safe operation of the product. After reading the operation manual, please keep it in an easily accessible location.

*M : Ultra microfiber mop (option)

VR5901LVM
VR5902LVM



3828FI3868Z

www.lg.com

FEATURES

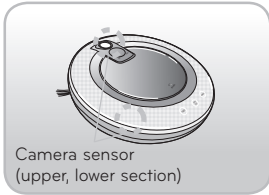

Images of the ceiling and floor are obtained from the sensors of the upper and lower cameras, and through this, the location of Roboking will be confirmed, therefore, elaborate cleaning can be accomplished for every part of the room.

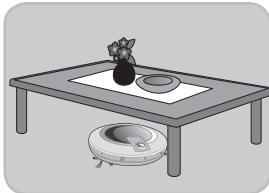

As the height of the Roboking is low (90mm), even the underside of a framed bed or furniture can be cleaned.

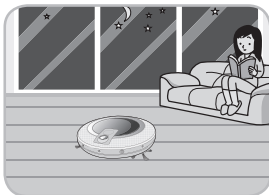

As the noise levels are at a quiet 60dB, cleaning can be performed at night.
*Less than 60dB

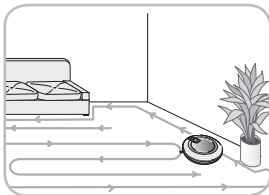

The Roboking has two auto cleaning modes that can be selected by the user.
*Spatial expansion mode, zigzag mode

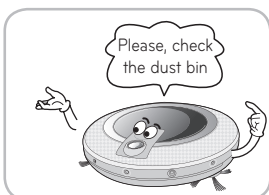

The Roboking also has voice confirmation and instruction that can be easily understood by the user.

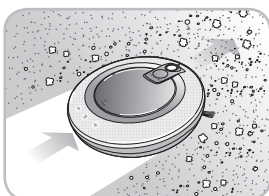

The use of the ultra microfiber mop accessory allows finer dust to be collected. (option)

CONTENTS

1

BEFORE USING

- 2~4 Safety Precautions
- 5 Included with Product
- 6~7 Parts Descriptions
- 8~9 Button Functions
- 10 Display Status Information
- 11 Before You Start
- 12 Overview

2

HOW TO USE

- 13 How to Install the Home Station
- 14 How to Turn the Power Supply On and Off.
- 15 How to Start and Stop Cleaning
- 16~17 How to Charge the Battery
- 18 Cleaning Modes
- 19 Auxiliary Cleaning Modes
- 20 Timer Cleaning
- 21 Mop Cleaning (option)

3

CARE AND MAINTENANCE

- 22 Cleaning the Dust Bin
- 23 Cleaning the Dust Bin Filter
- 24 Cleaning the Brush
- 25 Cleaning the Sensor/Charging Terminal
- 26 Cleaning the Side Brush
- 27 Cleaning the Ultra Microfiber Mop (option)

4

ADDITIONAL INFORMATION

- 28-30 Troubleshooting
- 31 Before You Call for Service

5

REFERENCE ITEMS

- 32 Product Specifications
- 33 Open Source Software Notice

SAFETY PRECAUTIONS

The purpose of the safety precautions described below is for the user to use the product safely and correctly to prevent any unexpected risk of injury or damage.

Basic safety precautions

After reading this manual, please keep it in an easily accessible location.



This is the safety alert symbol. This symbol alerts you to potential hazards that can result in property damage and/or serious bodily harm or death.



WARNING Indicates a hazardous situation which, if not avoided, could result in death or serious injury.



CAUTION Indicates a hazardous situation which, if not avoided, could result in minor or moderate injury.



WARNING

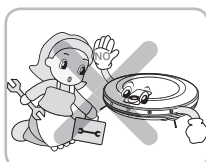

For your safety, do not remove the battery from the Roboking. If you need to replace the battery of the Roboking, take it to the nearest authorized LG Electronics service center or dealer for assistance.

Failure to follow this warning can cause fire or product failure.

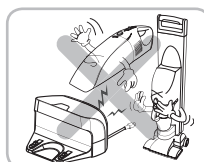

Never use the Roboking with a battery and/or home station from any other product than the Roboking.

Doing so can cause fire or product failure.

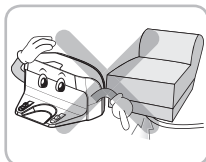

Make sure the power cord of the home station is not crushed under a heavy object or damaged by contact with sharp objects.

Failure to follow this warning can cause electric shock, fire or product failure. If the power cord is broken, do not plug it in. Take the product to an LG Electronics Authorised service repairer.

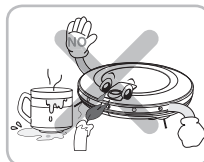

Do not use the Roboking when candles or fragile objects are placed on the floor.

Doing so can cause fire or product failure.

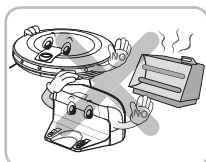

Do not place the home station and the Roboking near a heating device.

Doing so can cause product deformation, fire, or product failure.

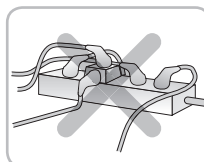

Always use a dedicated outlet.

If multiple appliances are connected to an outlet simultaneously, they can generate enough heat to cause a fire.

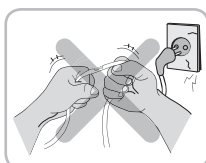

Do not force the power plug to bend. Do not use the power plug when it has been damaged or loosened.

Doing so can cause fire or product failure.

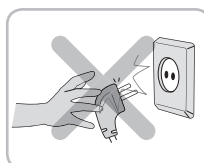

When pulling out the power plug, always pull it out by grabbing the plug, not the cord. When pulling out the power plug, do not touch the prongs with your fingers.

Doing so can cause an electric shock.

SAFETY PRECAUTIONS

! WARNING



Do not touch the power plug with wet hands.
Doing so can cause electric shock.

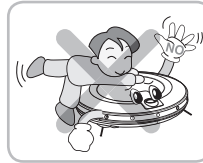

Do not allow children or pets to play with or rest upon the Roboking at any time. Do not use the Roboking while an object is hanging from it.
Doing so can cause injury or product damage.

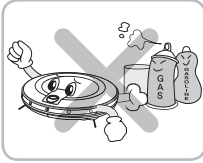

Do not spray or place inflammable materials, surfactants, or drinking water in the vicinity of the Roboking.
Doing so can cause fire or product failure.
* Inflammable materials: gasoline, thinner, etc.
* Surfactant: detergent, articles for bath, etc.



Turn the power supply off immediately if any abnormal sound, odor, or smoke is generated from the Roboking.
Failure to do so can cause fire or product failure.

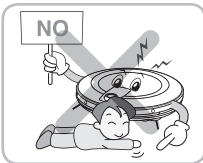

Do not insert any part of the body, such as a hand or foot, below the brush or wheels of the Roboking while in use.
Doing so can cause injury or product damage.



Do not operate the Roboking in a room where a child is sleeping.
Doing so can cause injury or product damage.



Do not operate the Roboking on narrow and high furniture such as a wardrobe, refrigerator, desk, table, etc.
Doing so can cause injury, product failure or damage which is not covered by the warranty.

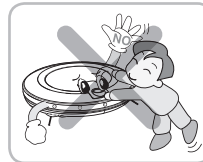

Do not leave Children or pets near the Roboking unsupervised.
Doing so can cause injury or product damage.

! CAUTION



Frequently empty the dust bin and maintain its cleanliness.
The dust collected in the dust bin can trigger allergies and may contain harmful insects.

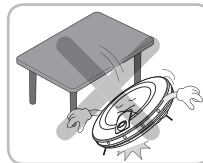

Do not drop the Roboking or subject it to strong impacts.
Doing so can cause injury or product failure not covered by the warranty.

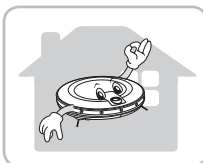

Use the Roboking indoors only.
Using it outdoors can cause product failure and irreparable damage to the unit.

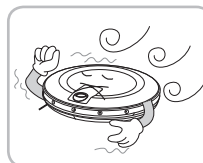

Do not expose the Roboking to cold temperatures (less than -5°C) for a long period of time.
Doing so can cause product failure.

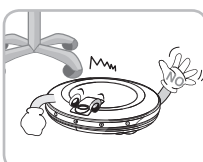

The Roboking may bump into furniture such as chair legs, table legs, thin and long furniture, etc. while operating.
For a quicker and cleaner performance, place the chairs on top of the table.

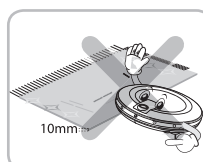

Cleaning will not proceed smoothly on carpets with tassels or carpets thicker than 10 mm.
It may be more convenient to arrange them before using the product.

SAFETY PRECAUTIONS

! CAUTION

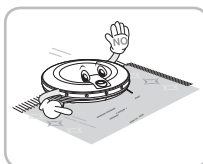

In rare cases, the Roboking's brush can damage the carpet. If this happens, immediately stop the cleaning operation.

When a carpet has long tassels, the tassels can be damaged.

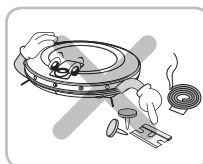

Do not allow the Roboking to sweep up liquids, blades, thumb tacks, kindling, etc.

These items can cause product failure.

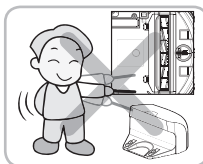

Do not let the main frame and charging terminal of the home station come into contact with metallic objects.

Doing so can cause product failure.

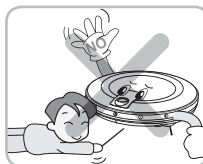

Do not put sharp objects into the opening of the Roboking's super-sonic sensor.

Doing so can cause product failure.



Do not put water, detergent, etc. into the Roboking.

Doing so can cause product failure. Do not put any water or detergent on the Roboking. If liquids get inside of the Roboking, turn off the power supply and contact an LG Electronics sales agent or customer care center.

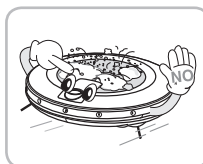

Do not use the Roboking when the dust bin is completely filled up.

Doing so can cause product failure.

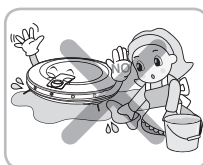

If the floor is wet or has wet spots, wipe them up before using the Roboking. Do not use the Roboking on a wet surface.

Failure to do so can cause product failure.

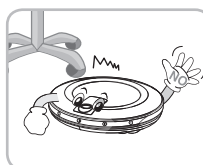

When the robot cleaner is operating, it may hit Chair, desk and table legs or other narrow pieces of furniture.

For quicker and better cleaning, place the dining chairs on top of the dining table.



Tip

Check the following items before use:

- Remove fragile or unnecessary objects from the room to be cleaned. For example, remove expensive ceramics and valuables from the floor.
- Do not use this product in the room where a child is sleeping alone. The child can be hurt.
- Confirm whether the battery has sufficient power, and if it is low, recharge it.
- Empty the dust bin after it fills up.
- Close the doors of any room that you do not want the Roboking to enter. During cleaning, the Roboking may enter another room and continue cleaning.
- Remove any moisture from the floor before cleaning.
- Remove any cables or long strings from the floor.
- Remove cables, strips, towels, socks, etc. from the floor so they will not get caught by the brush.
- Cleaning will not proceed smoothly on carpets with tassels or carpets thicker than 8 mm (0.315 in). It may be more convenient to remove or rearrange the position of these rugs or carpets before using the product.

Please note, this product is not intended for use in any workshop, commercial office, garage or outdoor environment. It is for normal Domestic internal home use only.

INCLUDED WITH PRODUCT

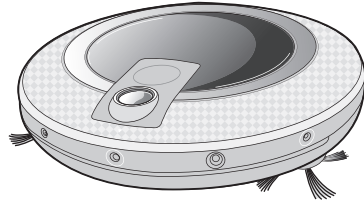

Roboking



Remote controller

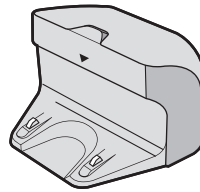

Home station

► Figures can be different from actual objects.

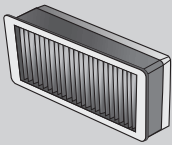

Dust bin filter (spare)

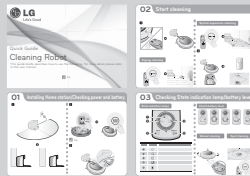

Quick guide



Operation manual

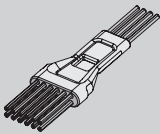

Brush for cleaning Filter / Sensor

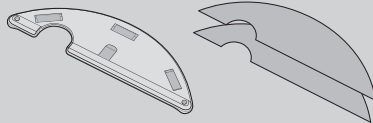

Mop plate Ultra microfiber mop (option) (2 pieces)

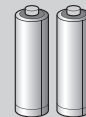

Dry cell for remote controller (2 units of AAA size)

PARTS DESCRIPTION - Roboking

Plan view

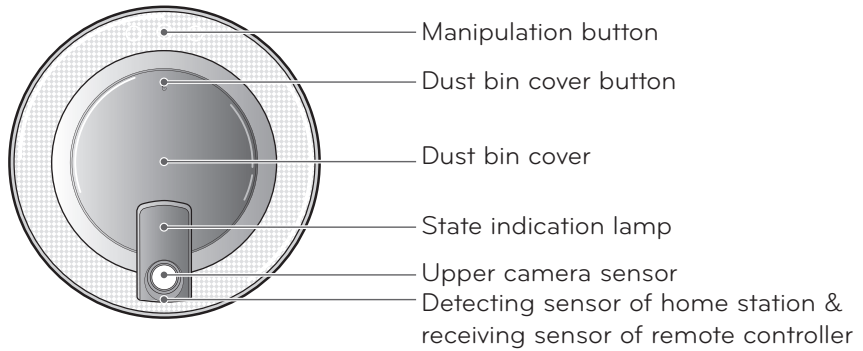

Front view

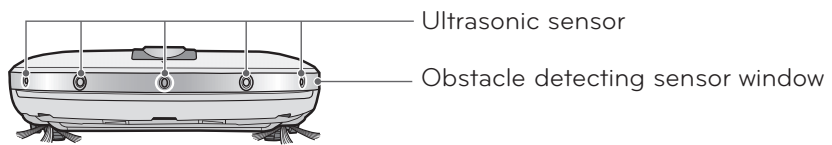

Rear view



Bottom view

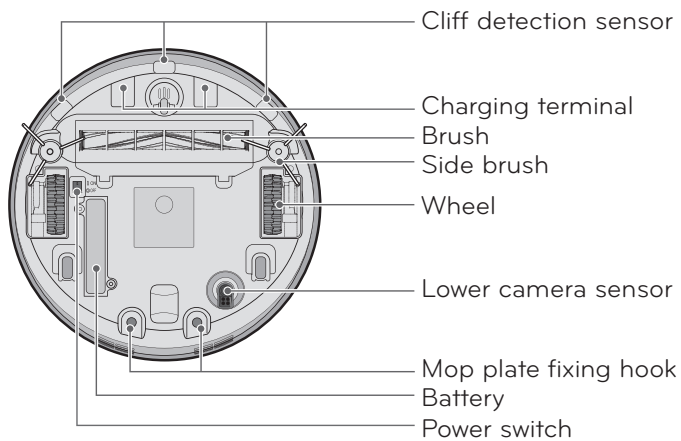

► Figures can be different from actual objects.

PART DESCRIPTION – HOME STATION / DUST BIN

Home station

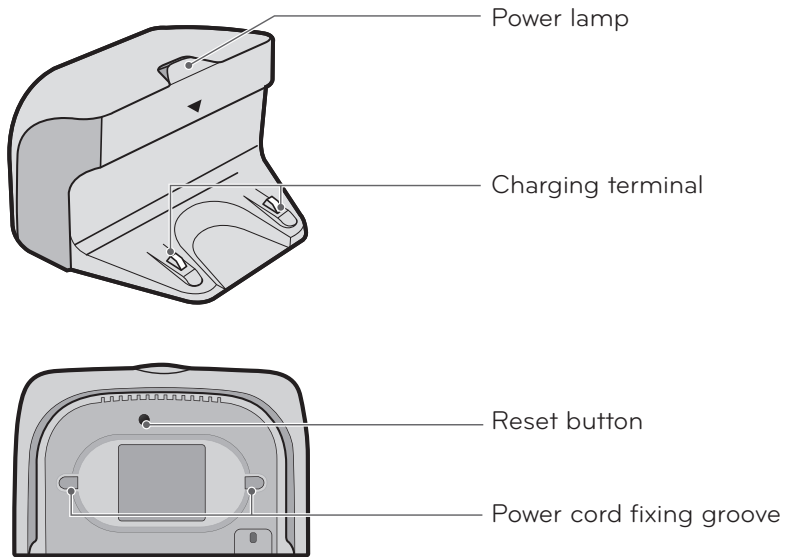

Dust bin

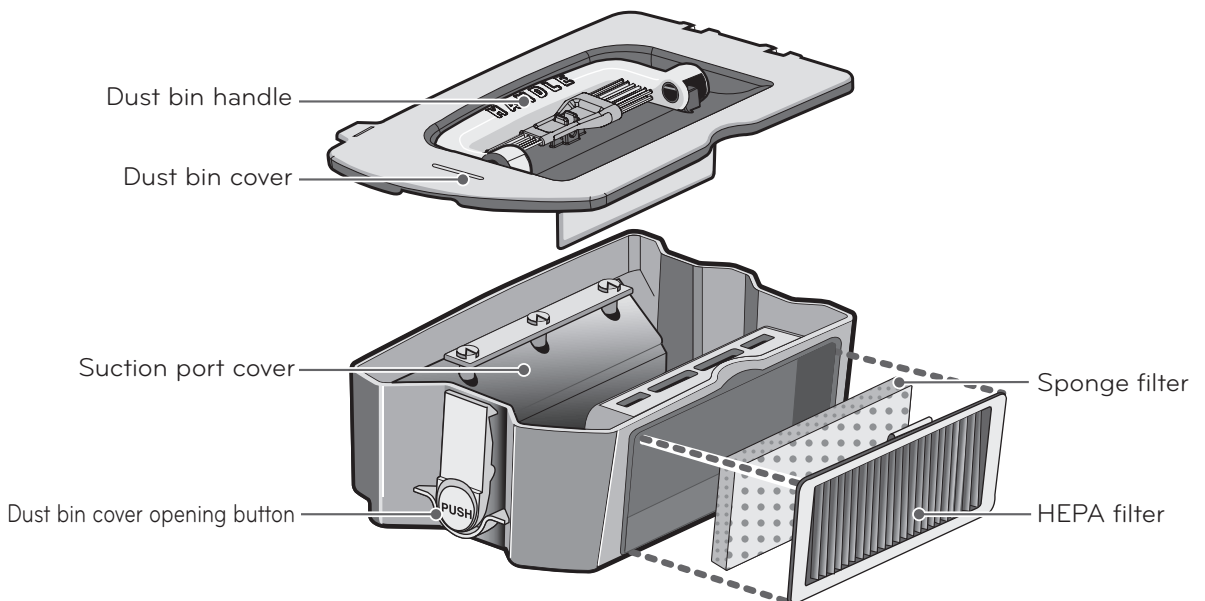

► Figures can be different from actual objects.

BUTTON FUNCTIONS – Roboking

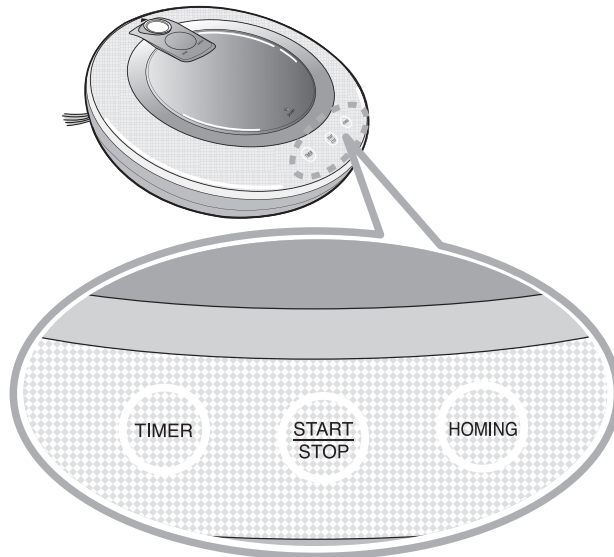

TIMER

- Use the TIMER button to start cleaning after a set amount of time has elapsed.
- The timer can be set from 1 to 12 hours.
- The timer button only works when the Roboking is attached to the home station. Always attach Roboking to the home station when setting the timer function

START/STOP

- Press the START/STOP button to turn the Roboking on/off or start/stop cleaning.
- Press the START/STOP button while the Roboking is on and it will automatically start cleaning.
- If the START/STOP button is pressed during automatic cleaning, the Roboking will stop cleaning.
- Press and hold the START/STOP button for approximately two seconds to turn off the Roboking.
- This puts the Roboking into the Stand By mode
- If the button is pressed while in the timer mode, the timer setting will be canceled.

HOMING

- Press the HOMING button to move the Roboking to the home station for battery charging.
- When cleaning is complete or the battery is low, the device will automatically move to the home station to charge the battery even without pressing the HOMING button.
- If the home station become obstructed, the Roboking may not be able to find it's signal and return to it.

BUTTON FUNCTIONS – REMOTE CONTROL

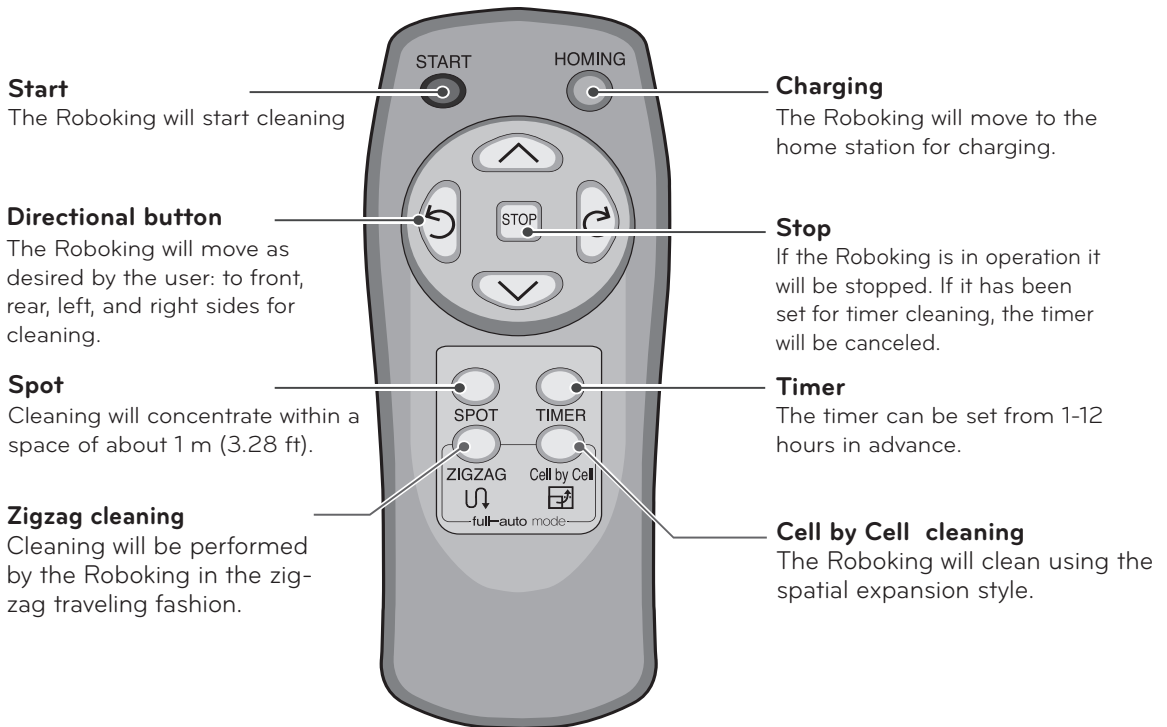

Tip

- The Roboking's power supply cannot be turned on with the remote control.
- To turn on the power supply, use START/STOP button on the top of Roboking.
- In order to do spot cleaning, timer cleaning, zigzag cleaning, and spatial expansion cleaning, you must first stop the operation of the Roboking.
- If the main power switch on the underside of the Roboking is turned off, the remote will not function, and the battery cannot be charged.
- If the main switch on the underside of the Roboking is in the off position, the Status display will flash and sound when the unit is manually placed onto the home station, to indicate that the main switch is off.

DISPLAY STATUS INFORMATION

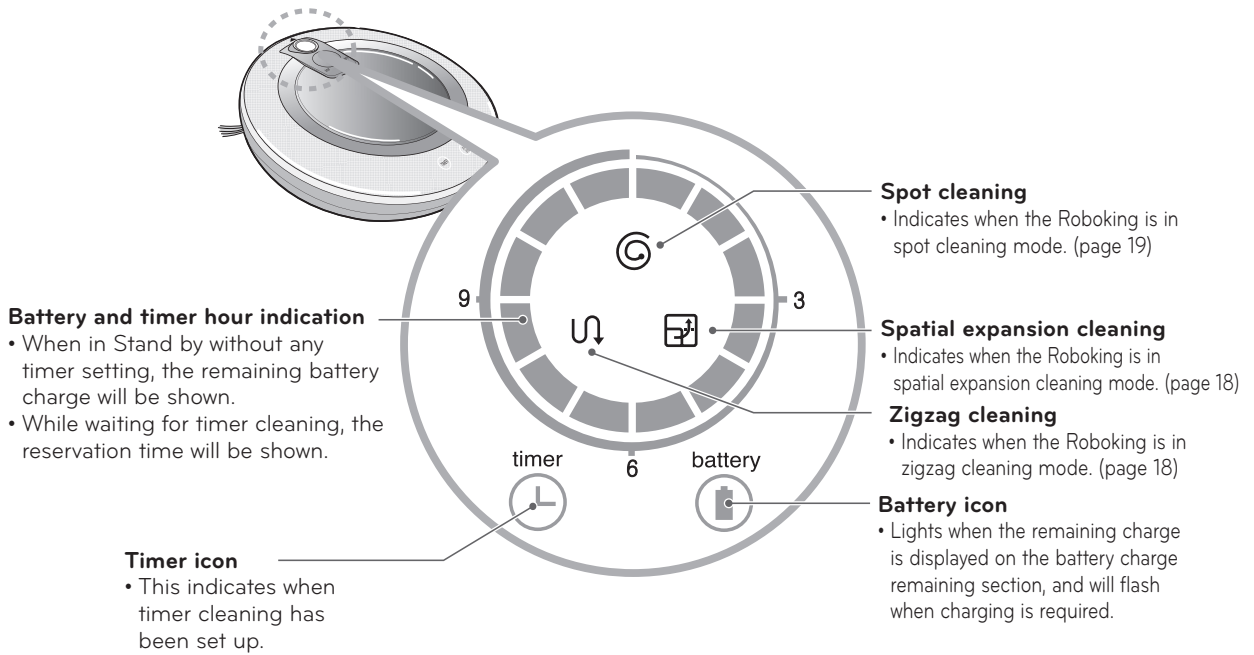

Tip

- Use the remote control to change the cleaning mode.
- Once the cleaning mode has been selected, it will be memorised and automatically selected when the unit is turned on again, until it is changed again.
- To cancel the timer setting, press the STOP button on the remote control or the START/STOP button on the Roboking.

BEFORE YOU START

Check these items before cleaning

- Do not use this device in a room where a child is left alone. The child could be injured.
- Remove fragile or unnecessary objects from the room to be cleaned. Especially, remove expensive ceramics and valuables from the floor.
- Remove any moisture that might be on the floor.
- Remove cables, strips, towels, socks, etc. from the floor so they will not get caught by the brush.
- Confirm whether battery charge is sufficient, and if it is low, recharge it.
- Empty the dust bin if it is full.
- Close the doors of any room that you do not want the Roboking to enter. During cleaning, the Roboking may enter another room and continue cleaning.

Loading the remote control battery

1. Open the battery cover by lifting the rear hook of the remote control.
2. Insert two AAA batteries, checking for +, - nodes while loading.
3. Close the battery cover completely so that the batteries will not fall out.

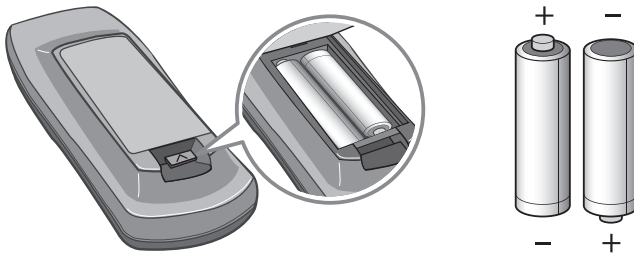

Precautions while using the remote control

- Only press one button at a time.
- Do not drop or subject it to forceful impact.
- Do not store it near devices that give off heat, fire or hot air.
- Certain fluorescent lamps, such as 3 wavelength fluorescent lamps, can interfere with the activation of the remote control. Therefore, use it as far away as possible from such lamps.
- If the remote control is too far from the Roboking when operated, it may fail to operate properly. Use the device within 3 m (9.84 ft) of the Roboking if possible.

OVERVIEW

1

Install the home station. (page 13)

Insert the power cord plug into an outlet and locate the station against a wall. If power is not supplied to the home station, the Roboking will not charge.

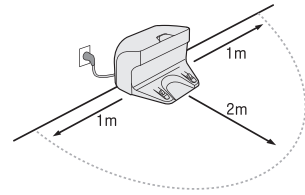

2

Turn on the power supply of the Roboking. (page 14)

Turn on the power switch located on the bottom of the Roboking and press the upper START/STOP button to turn on the power supply.

* If the power supply is not turned on, refer to page 14.

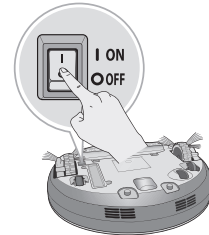

3

Start cleaning. (page 15)

Press the START/STOP button once again while the Roboking is turned on. You will hear the sound of cleaning and cleaning will begin.

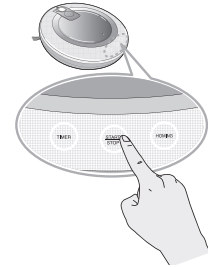

4

Automatic charge. (page 16-17)

The Roboking will self-diagnose and automatically return to the home station to recharge before the complete discharge of the battery. It can take up to three hours to charge the battery.

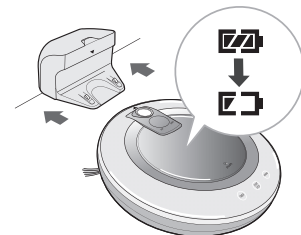

5

Use cleaning methods and auxiliary functions. (page 18~21)

With remote controller, cleaning method can be selected and auxiliary function can be used. For cleaning methods, zigzag cleaning or spatial expansion cleaning can be selected, and for auxiliary functions, manual cleaning, spot, timer function, and ultra microfiber mop cleaning can be used.

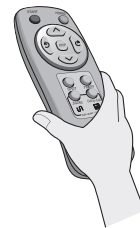

HOW TO INSTALL THE HOME STATION

How to Install the Home Station

1. Position the home station against a wall, to prevent sliding during docking, on hard level flooring.
Remove objects within 1m. to the right and left side and within 2m. to the front.

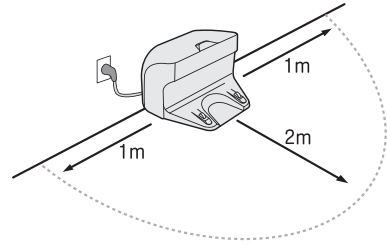
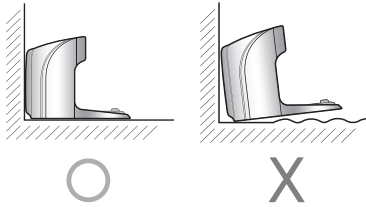

2. Plug the power cord into an outlet.

Wrap the power cord around the fixed hanger on the back side of the home station or along the wall surface so that the travel path of the Roboking will not be obstructed.

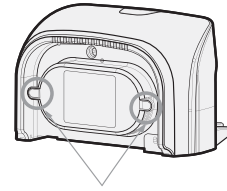
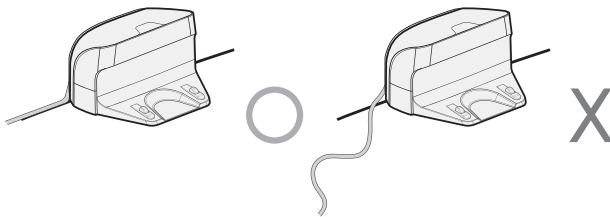

Fixing groove of power cord

3. Fix the home station against the wall so that it does not move.

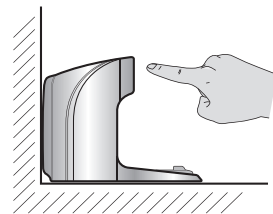

- Tip**
- Always keep the home station plugged in. If the home station is not plugged in, the Roboking will not return to the station to charge automatically.
 - Do not operate the Home Station if it has a damaged cord or plug, if it is not working properly, or if it has been damaged or dropped. To avoid any electrical hazard, the cord must be replaced by LG Electronics, or a qualified service person.

HOW TO TURN THE Roboking POWER SUPPLY ON & OFF

Turning on the main power supply

To turn the power supply on, turn the Roboking upside down on a smooth/soft surface and check whether the main power supply switch is turned on.

If the main power supply switch is turned off, turn on the switch.

- * When turning on the power switch, do not press the button located at the upper section of the Roboking. Operation of the button can be delayed.
- * Turn off the power switch if the Roboking will not be used for a long period of time, in order to protect the battery.
- * The power switch cover is used for protecting the switch from the dust. Always keep the cover attached.

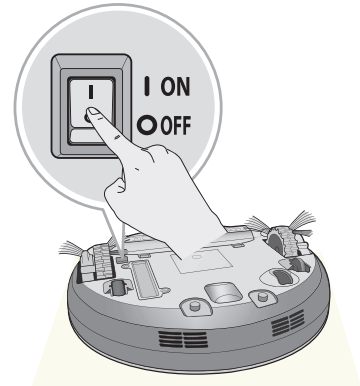

Turning on from Stand By power.

When the Roboking is not at the Home Station, and is in the Stand by mode, press the 'START/STOP' button for more than 1 second. The Roboking will be turned on and a melody will be sounded.

- * If the power is turned on while the Roboking is not at the Home Station, and nothing is done for ten minutes, the power supply will automatically turn off to reduce battery consumption.

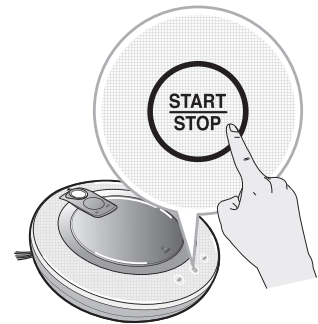

Turning off the power supply

Press the START/STOP button for two seconds while the Roboking is turned on. A melody will sound when the power is turned off.

- ✓ **Tip**
- The power can be turned off due to the static electricity during the operation.
 - If the power is turned off, turn off the main power switch and then turn it back on.
 - If the power cannot be turned on, do the following.
 - Turn on the power switch and wait for more than 3 seconds.
 - Press the 'START/STOP' button when the power switch is turned on.
 - If the power is not turned on or if there is no display but only the "Ting" sound, put the Roboking on the home station.
 - If there is no change even when Roboking is attached to the home station, press the reset switch located on the rear side of the home station while the Roboking is attached on the home station.

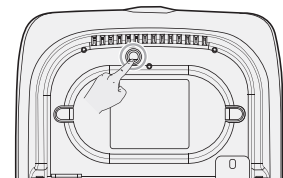
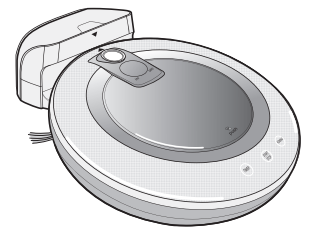

HOW TO START AND STOP CLEANING

Using the buttons on the Roboking

After the Roboking is turned on, press the START/STOP button to begin cleaning. A melody will sound and cleaning will begin.

Press the START/STOP button during the cleaning cycle to stop cleaning.

※ When the 'START/STOP' button is pressed while the power supply of the Roboking is turned off, the power will be turned on. Press the 'START/STOP' button one more time to start cleaning.

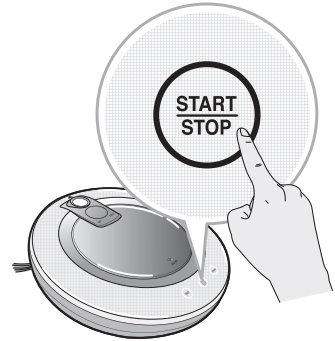

Using the remote control

After the Roboking is turned on, press the START button on the remote control. A melody will sound and cleaning will begin.

Press the STOP button during the cleaning cycle to stop cleaning.

※ The Roboking cannot be turned on from Stand By, by using the remote control when the power of the Roboking is off. When the power is off, press the 'START/STOP' button on the upper side of Roboking to turn the power on and to allow the remote to be used.



- ※ When the START button on the main unit or remote control is pressed, Roboking will start cleaning in 'Spatial expansion' mode.
- ※ During cleaning, collisions can happen when the sensor cannot detect objects because of their shape. When this happens, the internal impact detecting sensor will activate and engage a backward motion.
- ※ If the Roboking is set to start cleaning at a location away from the home station, put the device on a flat floor in order to prevent a malfunction of the obstacle detecting sensor. In addition, start cleaning from a location where there are no obstacles such as curtains or walls within 30 cm (11.8 in) of the Roboking.

✓ **Tip** For best results:

- Briefly scan the area to be cleaned for big and small objects that may cause difficulty for the Roboking.
- If cleaning is started when the Roboking is at the home station, the device can rapidly be returned to the home station as the current home position has been accurately read.

HOW TO CHARGE THE BATTERY

Automatic charging

The Roboking returns to the home station at the end of a cleaning cycle or when its battery is running low.

- ※ In the event that the unit returns to the Home Station due to a low battery, cleaning will be started, after the charging, from the nearest place of the area which has not been cleaned before.
- ※ If the Roboking is unable to dock to the home station on its first attempt, it will try again until it docks successfully.
- ※ When the Roboking has cleaned all areas that it can clean, it will return to the home station even when the battery level is not low.

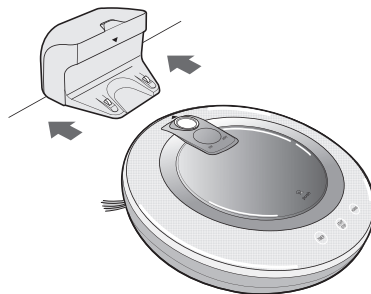

Manual charging

If using the Roboking for the first time or to charge the battery by interrupting the cleaning, you can manually charge the battery.

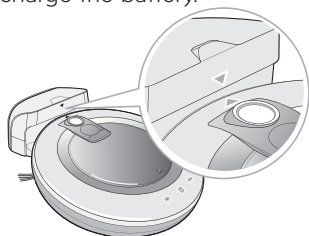

Method 1. Attach the Roboking to the home station by matching up the two arrows on the Roboking and the home station. A melody will sound and charging will begin.

- ※ When the Roboking is attached to the home station, and a "TING" sound is generated repeatedly, please check and ensure that the main On/Off on the underside of the Roboking is in the ON position.



Method 2. When the HOMING button of the remote control or the Roboking is pressed, charging will start automatically when the Roboking has returned to the Home Station.

- ※ If the Roboking is within 10 cm (3.9 in) of the front of the charging terminal while the power supply is turned on, it will automatically be returned to the home station and charging will begin.

Tip

Take the following precautions when using the home station:

- If foreign material is caught in the charging terminal, charging may not proceed smoothly. Wipe the terminal from time to time with a dry cloth after the power plug is disconnected.
- To prevent electric shock, do not touch the charging terminal with any metallic objects.
- To avoid fire or electric shock, never disassemble or modify the home station.
- Do not to place the home station or power plug near to a heating appliance.

HOW TO CHARGE THE BATTERY

Remaining Battery Charge Indicator

The remaining battery charge can be confirmed from the charge indication lights, which will indicate charge as follows:

- During charging, the charge remaining indication lights will flicker.
- When charging is completed at the home station, only the battery icon will illuminate to save power.
- The battery icon will flicker when battery charging is required.

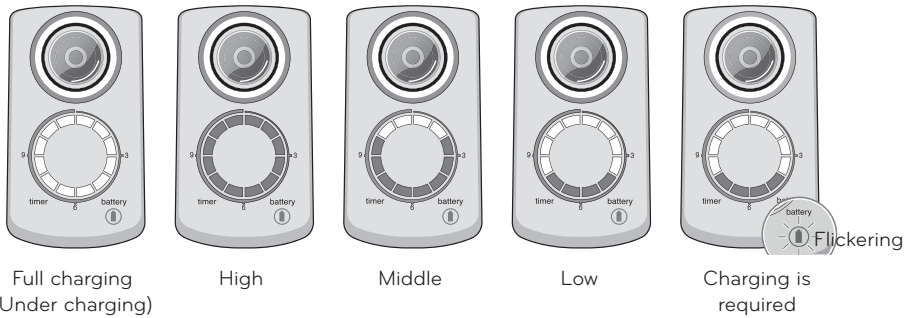

- ※ If there is still an area to be cleaned and it returned to the home station for recharging, the cleaning mode indicator will be displayed.
 - When the battery is fully recharged, it cleans the area that remains to be cleaned.
 - If the cleaning mode indicator is lit during charging, pressing the 'START' button of the remote controller or 'START/STOP' button of the Roboking will cause the Roboking to search for the uncleaned area and start cleaning.
 - Pressing the mode selection button on the remote, (ZIGZAG, Cell by Cell) will start the cleaning from the beginning.

The status indication lamp while robot is charged.

(In spatial expand mode)

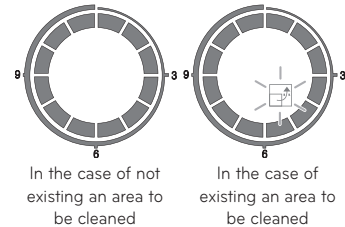

If the Battery is Not Charging

Check 1. If the battery is not charging even when the Roboking is attached to the home station, check the following items.

- Turn the power switch on the bottom of the Roboking off once and then on again.
- Unplug and plug in the power plug on the home station.
- Wipe the terminal on the home station with a dry cloth.

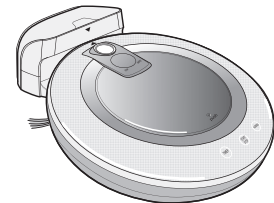

Check 2. If the battery is still not charging after the previous check, try the following.

- Attach the Roboking to the home station.
- Press the reset button at the rear of the home station for three seconds.

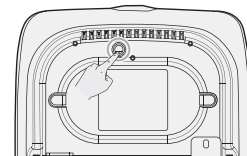

CLEANING MODES

Zigzag cleaning

With zigzag cleaning, total inside of the house will be cleaned with the repetition of zigzag traveling.

If rapid cleaning is desired, use the zigzag cleaning. When pressing 'ZIGZAG' button of remote controller, zigzag cleaning will be started while zigzag cleaning icon is indicated at the state indication lamp.

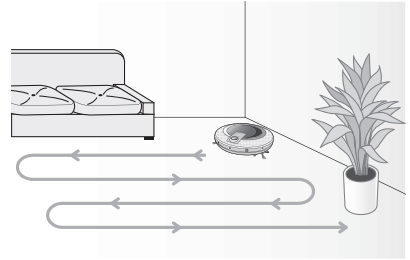
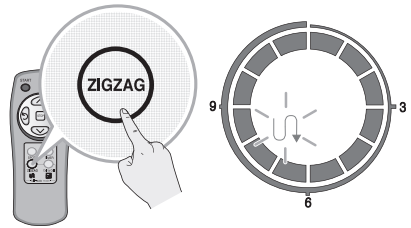

Spatial expansion cleaning

With spatial expansion cleaning, the cleaning will be performed by dividing the inside of the house into partial square spaces.

If elaborate cleaning is desired, use the spatial expansion cleaning.

When pressing 'Cell by Cell' button of remote controller, spatial expansion cleaning will be started while spatial expansion cleaning icon is indicated at the state indication lamp.

The 1st stage : The maximum outline of 3m x 3m of cleaning area will be cleaned. (The size of outline will be changed in accordance with the shape of the house inside.)

The 2nd stage : Inside of the outline will be cleaned with zigzag traveling.

When the 1st, 2nd stages are completed, the inside of the house will be cleaned through the repetition of above cleaning method as the device is being moved to the next cleaning area.

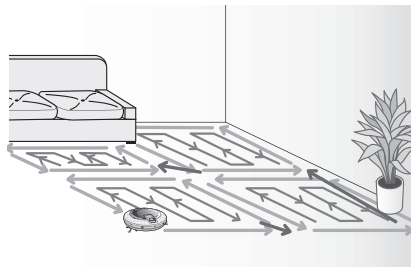
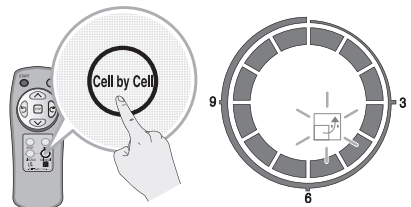

Tip

- The cleaning mode can only be changed with the remote control.
- Once selected, the cleaning mode will be maintained even after the power supply is turned off.
- During operation, if a cleaning change is required, press the STOP button and then select the mode.

AUXILIARY CLEANING MODES

Manual cleaning

This method of cleaning involves manually moving the Roboking by pressing the directional (arrow) buttons on the remote control.

The interior space will be cleaned by the Roboking as it is being moved to the front, rear, or rotated to the left and right side according to the input of the directional buttons.

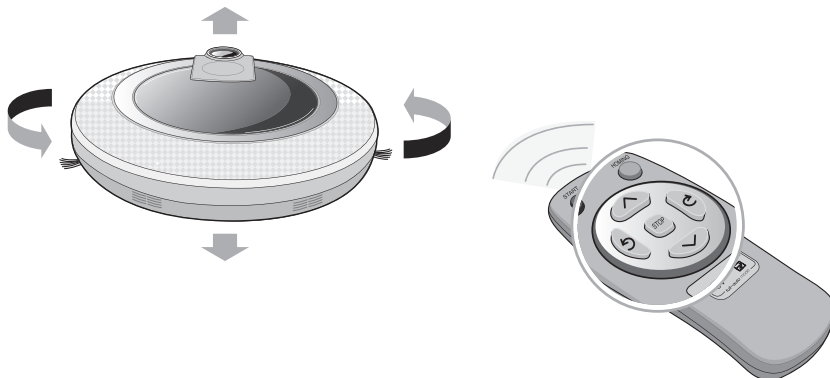

Spot Cleaning

Use this cleaning method when concentrated cleaning of a small interior space is required.

After moving the Roboking to the location to be cleaned, press the SPOT button on the remote control.

The spot cleaning icon will illuminate on the Roboking, and concentrated cleaning will be performed for a space within a radius of 1 m (3.28 ft).

* During charging, the spot cleaning button on the remote control will not activate.

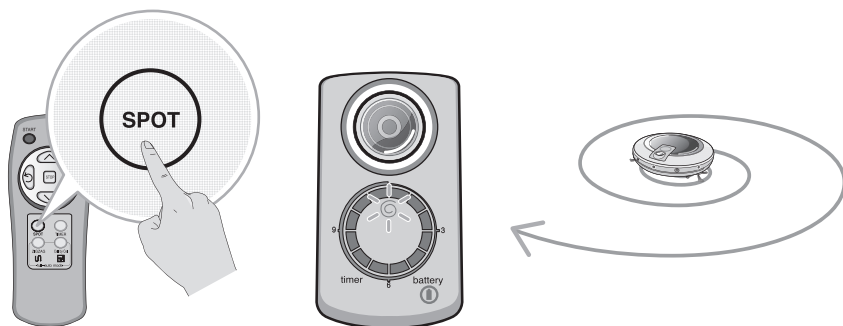

TIMER CLEANING

Set the timer to schedule the cleaning and begin in 1-12 hours.

1. By pressing the TIMER button on the remote control or the Roboking, a cleaning start time can be scheduled.

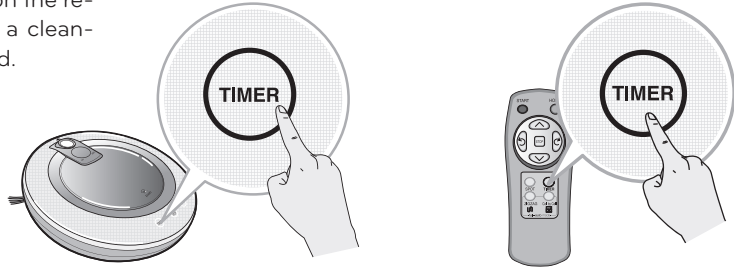

2. Adjust the time as much as desired by multiple presses of the TIMER button. Each time you press the button, the time will increase by one hour.

- The start time can be set up to a maximum of 12 hours and once set up, the time in hours, will be indicated by the status indication lamps.

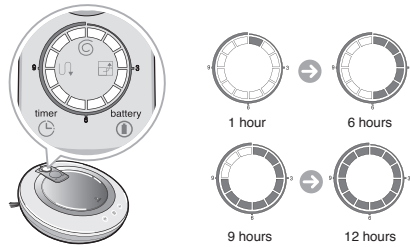

3. After setting up the start time, press the START/STOP button on the Roboking or wait about five seconds. When the timer setting is complete, a melody will sound, and the timer indicator will remain on.

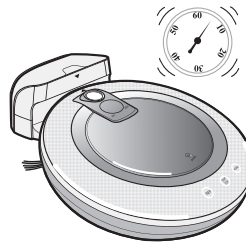

Tip

- When the set up time is being elapsed, cleaning will be started automatically.
- Use the timer setting when the Roboking is attached to the home station. If the timer is set up when the Roboking is detached from the home station, the cleaning time may not be accurate.
- To cancel the timer setting during the set up time, press the STOP button on the remote control or the START/STOP button on the Roboking.

MOP CLEANING (option)

By attaching the ultra microfiber mop, you can effectively use the Roboking to remove dust.

When the mop plate is attached, the Roboking will not climb on to carpets or over thresholds, in order to prevent transferring dirt from the mop.

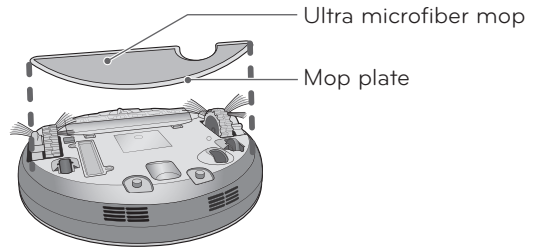

For mop cleaning, mount the mop and mop plate to the Roboking according to the following instructions:

1. Attach the ultra microfiber mop to the Velcro of the mop plate as shown in the figure.
* To prevent the Roboking from malfunctioning, attach the mop so that the mop attaching guide will not be covered by the mop.

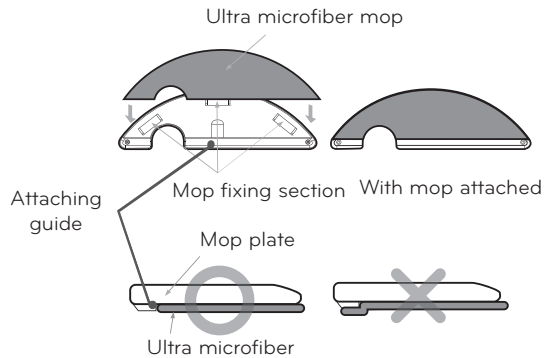

2. Accurately match up and insert the mop plate fixing hook on the lower section of the Roboking into the fixing groove of the mop plate.

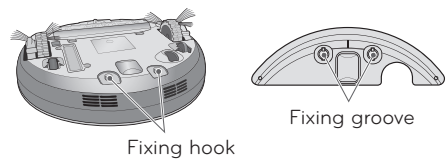

3. When you accurately match up and press the mop plate to the rear side of the Roboking, it will mount with a clicking sound.
* Be careful to properly mount the mop plate, or it can separate during cleaning.

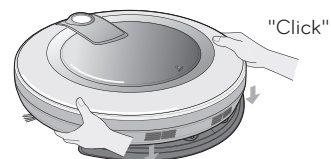

Tip

- To avoid odors, wash any foreign material or dust off the mop after cleaning is complete.
- To avoid staining floors, do not use the ultra microfiber mop to clean when dirt is mixed with liquids such as coffee or ink.
- To avoid damage to carpets from the Velcro or dirt transfer from the mop, do not clean the carpet while the mop plate or mop is attached.
- Keep the ultra microfiber mop dry. Do not use it on wet surfaces.

CLEANING THE DUST BIN

If the dust bin is full, suction power can be weakened. Clean the dust bin before and after each cleaning session. Clean the dust bin using the following sequence:

1. Open the dust bin cover by pressing the PUSH button on the Roboking.
2. Grab the handle of the dust bin and pull it upward.
3. Separate the HEPA filter and the inside sponge filter by removing the HEPA filter
* To clean the dust bin filter, refer to page 23.
4. Lift the cover upward while pressing the separation button on the dust bin.
5. Empty the dust bin and clean it with a cleaning brush or under running water.
6. After cleaning with water, completely dry the dust bin in a well-ventilated area out of the direct sunlight.
7. When you have completed cleaning the dust bin, close the cover and replace the sponge filter and HEPA filter.
8. Put the dust bin into the Roboking and close the dust bin cover.

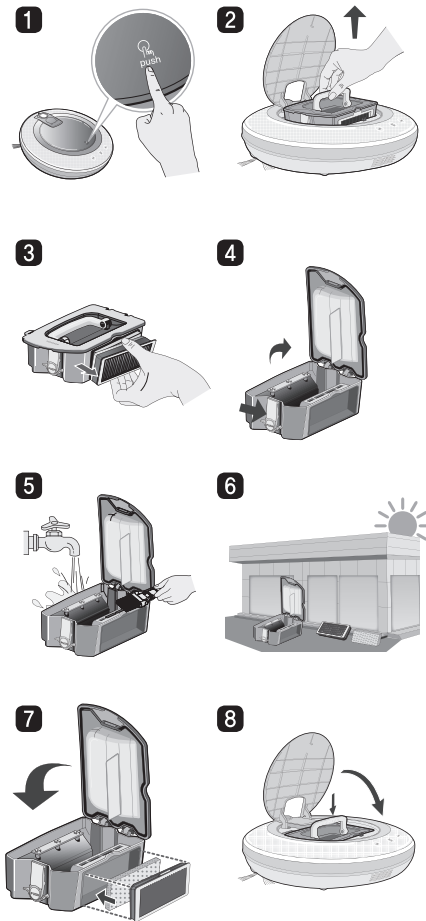

Tip

- After cleaning, always mount the dust bin filters (HEPA filter, sponge filter) to the dust bin. If they are not mounted, dust may enter the Roboking interior and cause product failure.
- When dust bin filter (HEPA filter, sponge filter) is full the warning sound "empty the dust bin!" may be generated. In this case, clean the filter by referring to "cleaning of dust bin filter" on page 23.
- Always close the dust bin cover. If you attempt to operate the Roboking while the cover is open, you will hear a voice message stating "Please check the dust bin."

CLEANING THE DUST BIN FILTER

The dust bin filters are comprised of the HEPA filter and the sponge filter.
Clean the HEPA filter and the sponge filter according to the following sequence:

1. Separate the HEPA filter and the inside sponge filter by removing the HEPA filter (as shown).

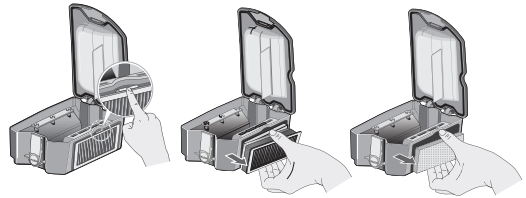

2. Carefully clean any fine dust off the HEPA filter and the sponge filter with a vacuum cleaner or water.



3. After washing the HEPA filter and the sponge filter with water, place them out of direct sunlight and allow them to dry completely.

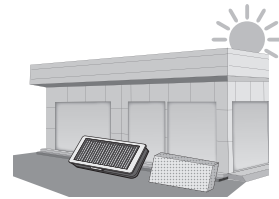

4. Mount the cleaned HEPA filter and sponge filter into the dust bin according to the sequence shown to the right. When assembling the filter, the filter handle should face upward.

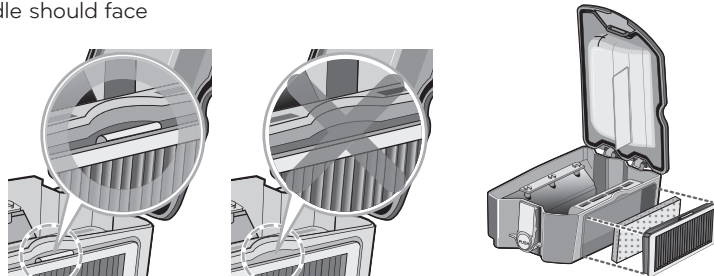

Tip

- In order to maintain the performance of the Roboking, the HEPA filter should be cleaned with a cleaning brush or vacuum cleaner at least once a week, and should be washed under running water at least once a month.

CLEANING THE BRUSH

The brush, located on the bottom of the Roboking, helps with the suction of foreign objects. Perform the following steps to clean the brush:

- 1** Lay a smooth cloth on the floor. Turn the Roboking over and put the Roboking on the cloth. Turn off the power switch before cleaning.
- 2** Separate the cover by pressing the fixing hook and pulling upward.
- 3** Wearing gloves turn the brush until the separation groove of the brush appears.

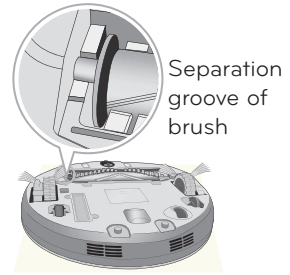
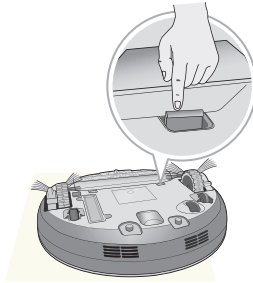
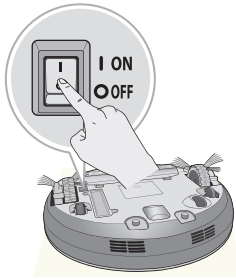

- 4** Grab the brush and remove by pulling it up.
- 5** Clean the brush with a vacuum cleaner by hand, or an old unused firm bristle toothbrush.
- 6** Insert the fixing hook on the side of the brush (marked with the square) by matching it to the fixing groove of the brush.

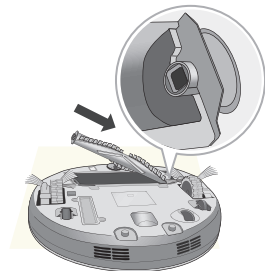
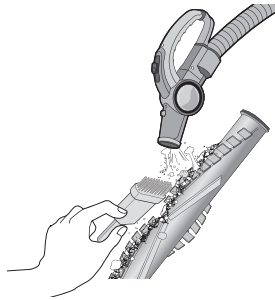
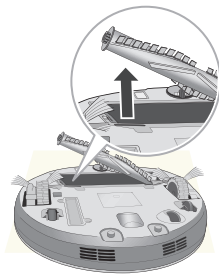

- 7** Insert the fixing hook on the opposite side of the brush (marked with a rounded rectangle) by matching it to the separation groove of the brush.
- 8** Align the cover with the fixing guides on the edge, by matching it to the fixing groove located on the main frame.
- 9** Close the cover by pressing it down until you hear a click from the fixing hook.
* NOTE: Please make sure that the side rotating brushes are not caught under the cover when refitting.

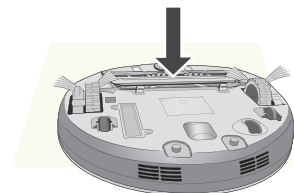
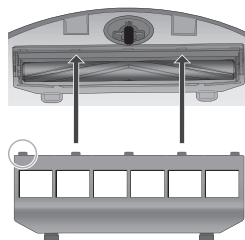
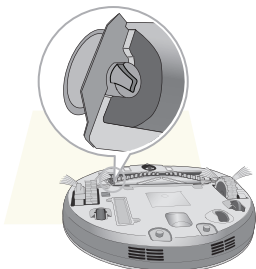

CLEANING THE SENSOR/CHARGING TERMINAL

There are sensors on the Roboking that can detect obstacles, stairways and the home station for charging the battery. In order to maintain the performance of the Roboking, regularly clean the sensors and charging terminal as follows:

1. Lay a smooth cloth on the floor, overturn the Roboking and put it on the cloth.
2. Turn off the power switch on the bottom of the Roboking. Injury can be caused by the activation of the Roboking if the main power is not turned off.
3. Use a smooth cloth or cleaning brush to wipe the dust off each sensor and the charging terminal as described below.

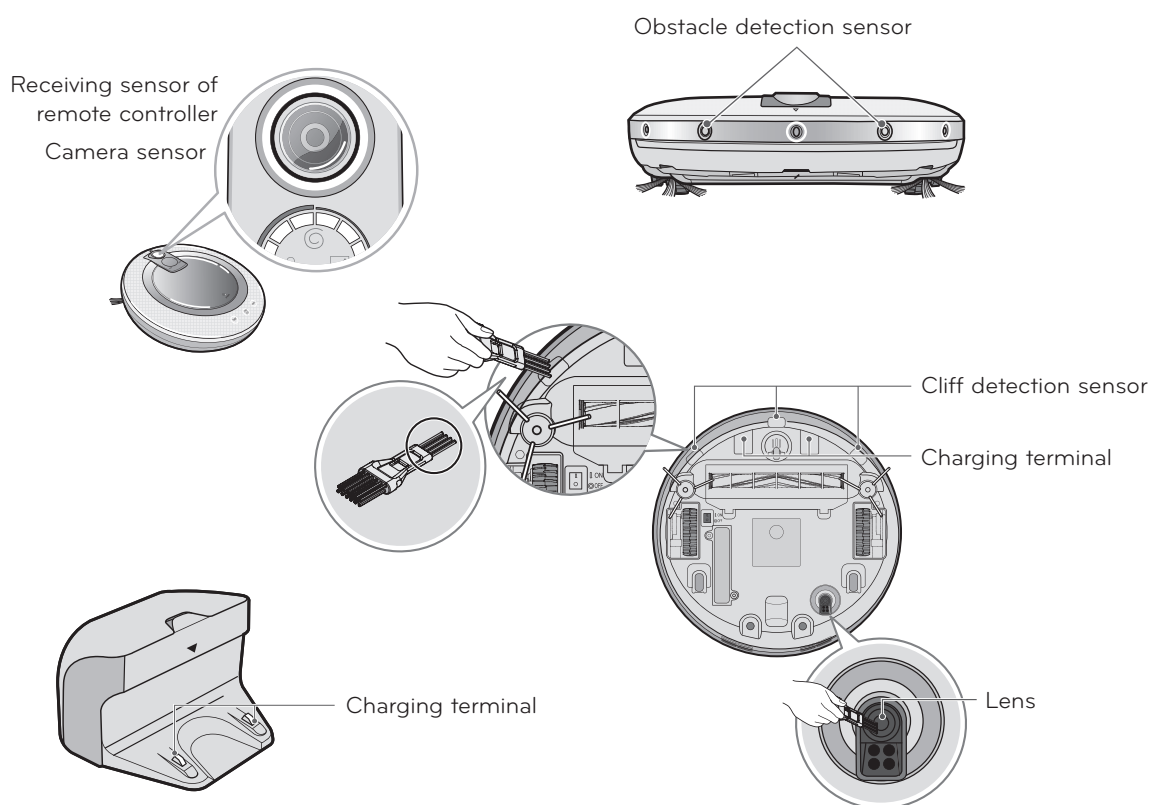
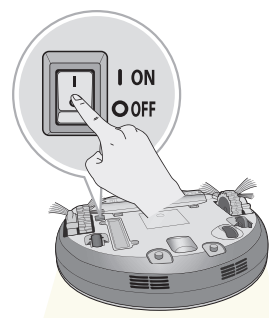

Tip

- Do not clean the Roboking by directly spraying it with water, thinner, benzene, etc.
- Call the service center if the sensors or charging terminals are damaged. Sensor and terminal damage can cause the product to malfunction.

CLEANING THE SIDE BRUSH

Foreign objects/materials such as hair can easily adhere to the side brush. Remove such materials at least once a week.

If excessive amounts of foreign materials are stuck to the brush, there is a risk of damage to the brushes.

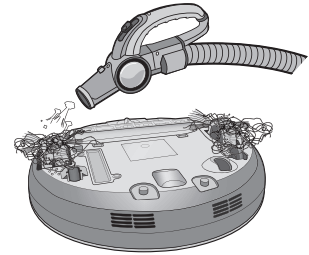

If the floor is rough or wall skirtings are frequently cleaned, the side brush may bend or become damaged. In this case, use the following method to straighten the side brush.

1. The following procedure is helpful in restoring deformed brushes.
2. Turn off the power supply by pressing the START/STOP button on the Roboking for two seconds.
3. Place the Roboking at the end of a table to make cleaning the side brush easier. Make sure that the Roboking is not in danger of falling.
4. Soak the side brush in warm water.
5. Press down on the side brush for about ten seconds so that it is completely submerged in the water.
6. Slowly wipe the side brush by sliding it through your hand.
7. Rotate the side brush and repeat steps 4-6 for each section of the brush.
8. Use the side brush only after it has completely dried.

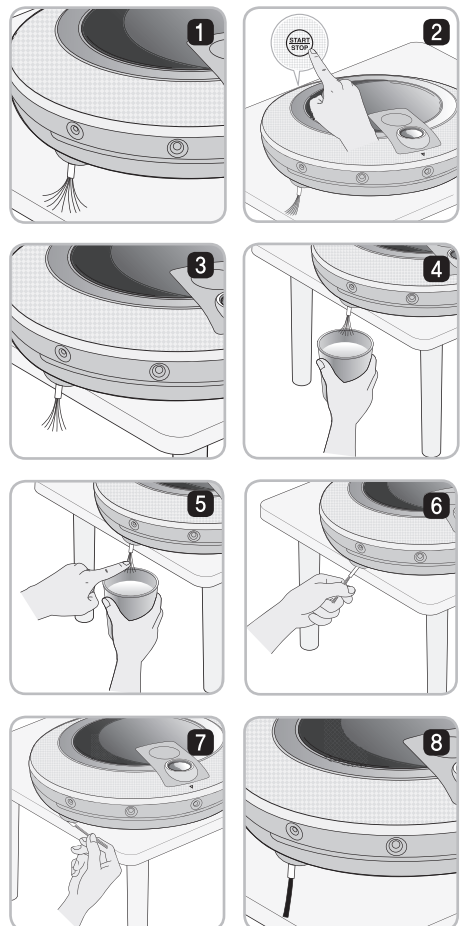

CLEANING THE ULTRA MICROFIBER MOP (option)

To avoid odors, dirt and dust should be washed off the mop after it is used for cleaning. Follow these directions to wash the ultra microfiber mop:

1. Separate the ultra microfiber mop from the mop plate.

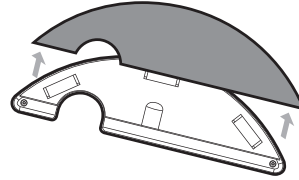

2. Carefully clean it with water.



3. Use the mop only after allowing it to dry completely in a sunny, well-ventilated area.

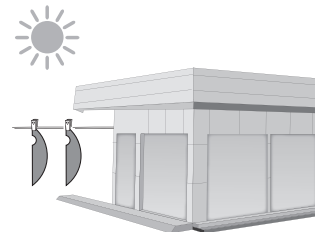

-  **Tip**
- To avoid product malfunction, only use the ultra microfiber mop provided with the Roboking.
 - Additional microfiber mops can be purchased by visiting a nearby LG Electronics service center.

TROUBLESHOOTING

When the voice, "Please check the wheels", is announced.

If the unit becomes stuck or suspended and the wheels do not allow the unit to move, the voice, "Please check the wheels", will be announced.

- Is a wheel trapped in the front door, balcony, stairway, etc?
 - ▶ Move the Roboking on to the flat floor.



- Is any foreign material wound around the wheel?
 - ▶ Lay smooth cloth on the floor, overturn the Roboking, and put it on the cloth. Remove foreign material by confirming the wheel.

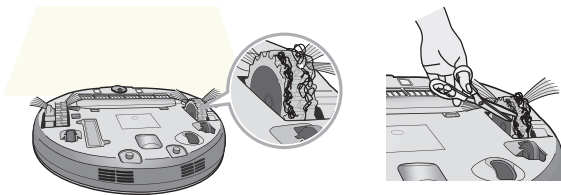

TROUBLESHOOTING

When the voice, "Please check the dust bin", is announced

When an abnormality is detected with the dust bin, the voice, "Please check the dust bin", is announced.

- Is the dust bin fitted correctly?
 - ▶ Open the dust bin cover, and if check if the dust bin is actually fitted. The unit will not operate without the dust bin.
 - ▶ If the dust bin cover is opened, close the cover before operating the unit.

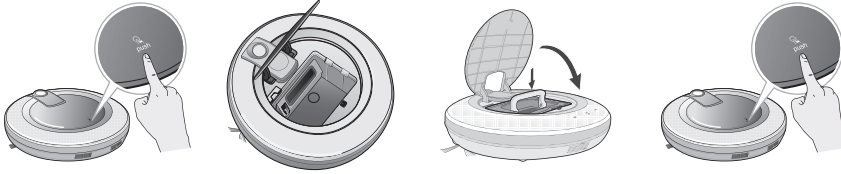

When the voice, "Battery is low", is announced.

When remaining amount of battery is almost nil, the voice, "Battery is low", is generated.

- Initiate battery charging of Roboking by moving it to the home station.
 - ▶ When attaching the Roboking to the home station by matching both arrows of Roboking and home station, charging will be started and the sound of charging start melody will be heard.

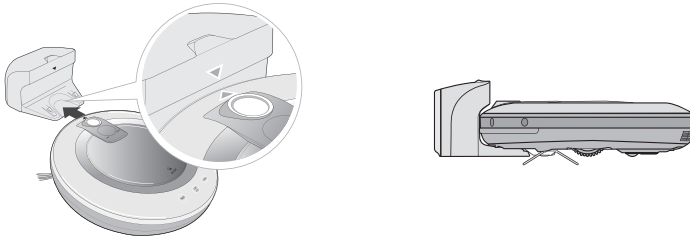

TROUBLESHOOTING

When you hear "Please check the brush"

When the Roboking detects that the brush is not functioning properly, you will hear the message "Please check the brush."

Lay a smooth cloth on the floor, overturn the Roboking, and place it on the cloth.

- The side brush is stuck.
 - ▶ Remove any foreign materials such as cables, thread or hair caught in the side brush or the brush.

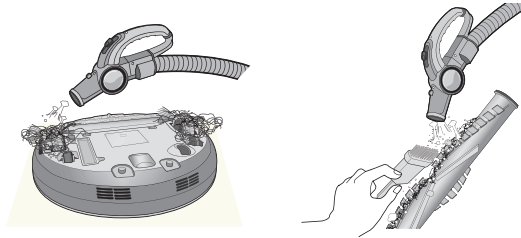

- ▶ Confirm the correct assembly of the brush by checking the separation groove of the brush.

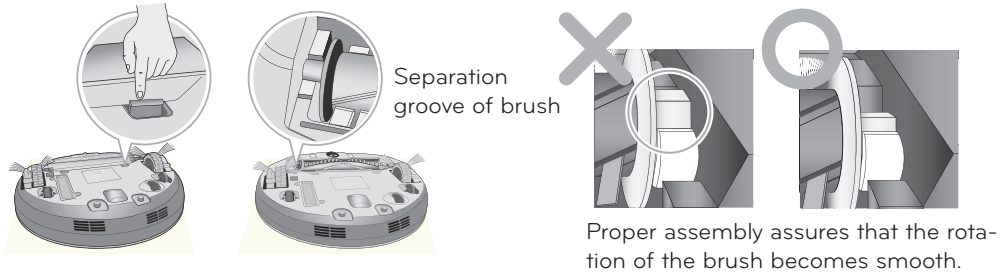

- The brush is making a loud, abnormal sound.
 - ▶ Remove the brush from the Roboking and remove any foreign material from the brush.



* For a more detailed description of this process, refer to the instructions on page 24.

BEFORE YOU CALL FOR SERVICE

Confirm before reporting the failure of Roboking.

Problem	Solutions (Reference page)
The Roboking will not activate.	<ul style="list-style-type: none"> ▶ Confirm that the power switch is turned on. (page 14) ▶ Confirm that the battery has been charged. (page 17)
Movements or travel path are abnormal.	<ul style="list-style-type: none"> ▶ Carefully wipe the sensor with a smooth cloth. (page 25) ▶ If the ultra microfiber mop is attached, confirm that it is mounted properly. (page 21) ▶ Turn on the power switch off and on.
Suction power becomes weak.	<ul style="list-style-type: none"> ▶ Check whether there is foreign material blocking the suction port. (page 24) ▶ Empty the dust bin. (page 22) ▶ Clean the dust bin filter. (page 23)
Noise becomes louder.	<ul style="list-style-type: none"> ▶ Confirm that the dust bin has been fitted properly. ▶ Confirm that the dust bin filter has been fitted properly. (page 23) ▶ Check whether foreign material is caught in the brush. (page 24)
The Roboking cannot be activated with the remote control.	<ul style="list-style-type: none"> ▶ Replace the remote control batteries. (page 11) ▶ Confirm that the control is within the coverage area of the main frame, which is up to 3 m or 9.84 ft. (page 11)
The brush does not rotate.	<ul style="list-style-type: none"> ▶ Clean the brush. (page 24) ▶ Confirm that the brush has been fitted properly. (page 24)
The Roboking will not charge.	<ul style="list-style-type: none"> ▶ Remove objects around the home station. (page 13) ▶ Confirm that the power supply is connected to the home station. (page 13) ▶ Wipe the charging terminal with a dry cloth.
The power supply automatically turns off.	This is not a failure. Roboking has its own power saving function. If it is not used for ten minutes after the power supply is turned on, the power will automatically turn off.
The power supply cannot be turned on.	Check that the power switch on the underside is turned on. (Page 14)

PRODUCT SPECIFICATIONS

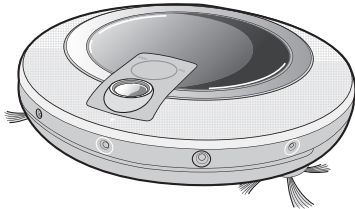

Item/model	LG Roboking VR5901LVM, VR5902LVM
External dimension	Φ 360 mm X 90 mm
Weight	3.2 kg
Power consumption	18 W
Battery (fully charged)	DC 16.8 V
Maximum Traveling Velocity	350 mm/sec
Use time (1 time charging)	Approx. 75 minutes Based on general floor surface
Charging time	3 hours
Main functions	Obstacle detection function Falling prevention function Timer cleaning function Error indication function Automatic, manual charging function Dry mop function (wiping) (option) Edge cleaning function Voice announcement function Map building function Spot cleaning function Spatial expansion cleaning function Zigzag cleaning function

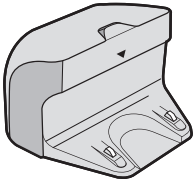

Item/model	Home station VR591
External dimension	204 mm X 158 mm X 125 mm
Rating	AC 220-240 V, 50Hz
Output voltage/current	17.1 V / 1.1 A
Power consumption	23 W

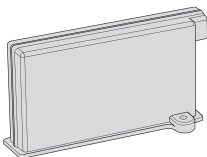

Item/model	Battery EAC60766102
Charging battery	Lithium ion Polymer Battery
Nominal voltage	14.8 V / 1900mAh

Open source software notice

To obtain the source code under GPL, LGPL, MPL and other open source licenses, that is contained in this product, please visit <http://opensource.lge.com> .

In addition to the source code, all referred license terms, warranty disclaimers and copyright notices are available for download.



Disposal of waste batteries/accumulators

1. When this crossed-out wheeled bin symbol is attached to batteries/accumulators of Your product it means they are covered by European Directive 2006/06/EC.
2. This symbol may be combined with chemical symbols for mercury(Hg), cadmium(Cd) or lead(Pb) if the battery Contains more than 0.0005% of mercury, 0.002% of cadmium or 0.004% of lead.
3. All batteries/accumulators should be disposed separately from the municipal waste stream via designated collection facilities appointed by the government or the local authorities.
4. The correct disposal of Your old batteries/accumulators will help to prevent potential negative consequences for the environment, animal and human health.
5. For more detailed information about disposal of Your old batteries/accumulators, please contact Your city office, waste disposal service or the shop where You purchased the product.



Disposal of your old appliance

1. When this crossed-out wheeled bin symbol is attached to a product it means the product is covered by the European Directive 2002/96/EC.
2. All electrical and electronic products should be disposed of separately from the municipal waste stream via designated collection facilities appointed by the government or the local authorities.
3. The correct disposal of your old appliance will help prevent potential negative consequences for the environment and human health.
4. For more detailed information about disposal of your old appliance, please contact your city office, waste disposal service or the shop where you purchased the product.