



OWNER'S MANUAL DRYER

Please read this manual carefully before operating your dryer and retain it for future reference.

RC7020A/B/C

RC7020A1/B1/C1

SEC. WORK	가	나	다	PRINTING DEGREE		MATERIAL AND PRINTING DESCRIPTION	LG MODEL 명	LANGUAGE	PAGE	REMARK
	BRAND	MODEL	P/NO.	EXTERIER	INTERIER					
25	LG	RC7020A/B/C RC7020A1/B1/C1	MFL63749025	1	1	SNOW WHITE 80g OFFSET 인쇄	-	ENGLISH	28	LGEAF

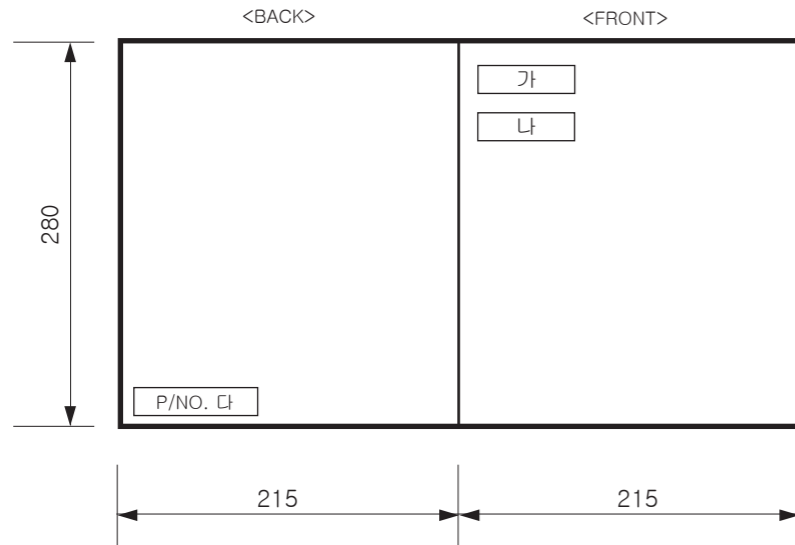

<< 주기 >>

1. 재질, 인쇄방법, 인쇄도수, 외곽치수등은 작업표에 준한다.
2. 인쇄내용, 문자크기 및 형상, 선의 굵기 등은 설계에서 제시된 FILM에 준함.
3. 외곽치수는 절단후 치수임.
4. 양산전에 설계 한도를 득할 것.
5. 본 부품에 금지물질이 포함되지 않도록 하고, 상세 내용은 LG(63)-A-5501-34를 만족할 것.

<< NOTES >>

1. Material, printing and exterier size are refer to work tables.
2. Printing, text size and line are based on LG design film.
3. Exterier size on the drawing is cutting line.
4. Before product controlled by criteria sample.
5. The part should not contain prohibited substances(Pb,Cd,Hg,Cr+6,PBB,PBDE) and details should comply with LG standard of LG(63)-A-5501-34.

REV. NO. 기호	REVISION DESCRIPTION 변경 사항	REF. NO. 시정 번호	DATE 년/월/일	PREPARED 시정자	APPROVED 승인자
△	정격 수정.	AWCL101132	11.02.23	김진영	윤주한
△					
△					
△					

TRIG.	UNIT	mm	SCALE	1/1
MODELING	DESIGNED	REVIEWED	CHECKED	APPROVED
	김진영 10.08.19		홍민환 10.08.19	최연식 10.08.20
LG 전자 (주) LG Electronics Inc.			RELATED DWG.	DWG. No.

MANUAL, OWNER'S
PRIME3(D)-PJT 1/1
MFL63749025

PDF ILLUSTRATOR DR COMPLETED 도면 DR 완료 완료일 :

Features

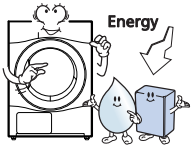

● Lower Energy Consumption

LG dryers use less energy than conventional dryers due to the cutting-edge technology we have applied to the drying system and to the heat control mechanism. This LG Dryer has been designed to save you money.

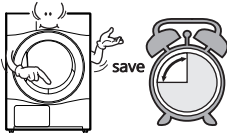

● Reduced drying times

Drying times are now shorter due to the efficient air flow mechanism and optimised heater on this LG Dryer.

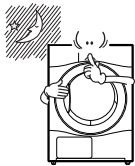

● Reduced noise levels

We have reduced the operating noise of this LG Dryer by using innovative sound-absorbing and noise-screening technologies, making it much quieter than conventional dryers.

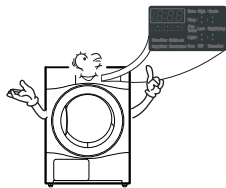

● Dryers to Use

The wide, electronically controlled LED display on this machine is very easy to use. Simply select the programme you require and your LG Dryer will do the rest.

Contents

Safety Instructions	3
Installation Instructions	6
Appearance & Design	10
Operating Your Dryer	11
Additional Functions	14
Caring for Your Dryer.....	16
Additional Tips for Smart Use	19
Troubleshooting Guidelines	21
Technical Data	23
Warranty	24

Safety Instructions

To help reduce any risk of electric shock, fire, or other personal or property injury when using your dryer, please follow basic safety instructions.

⚠ WARNING

Serious injury or death may occur when not observing the following rules.

⊘ Hazards

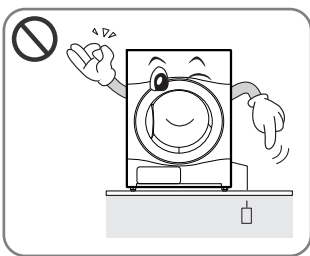

- Before plugging power cord, make sure cord is earthed and connected to circuit breaker.

.....

No Earthing may cause breakdowns or an electric shock.

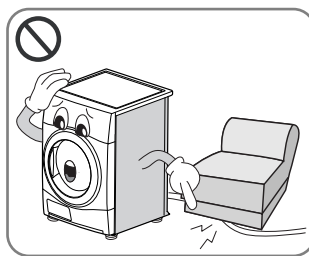

- Do not use a damaged power cord or place heavy objects on the cord.

.....

A damaged power cord may cause fire or electric shock

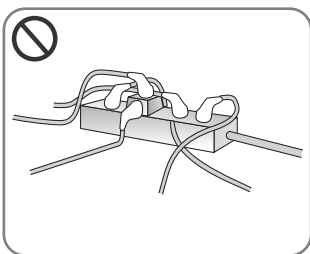

- Do not plug into an adaptor. Do not use with an extension lead.

.....

Abnormal heating of outlet may cause a fire.



- Do not touch the plug or switch on with wet hands

.....

May cause electric shock

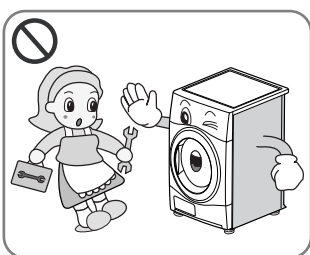

- Do not remove the top plate when installing the dryer.
- Do not modify this product.

.....

May cause breakdown, fire or electric shock

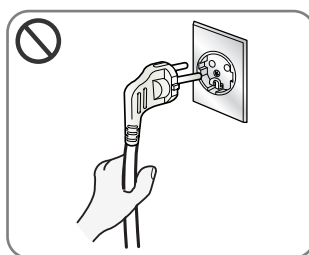

- Disconnect the power cord by grasping the plug, not the cord.

.....

May cause wires to loosen resulting in fire

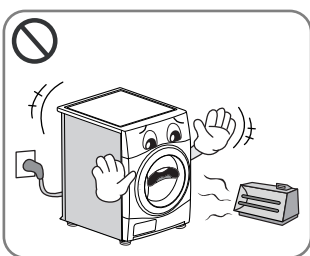

- Keep the dryer away from cookers, naked flames, or any other inflammable objects.

.....

May cause parts to melt or fire

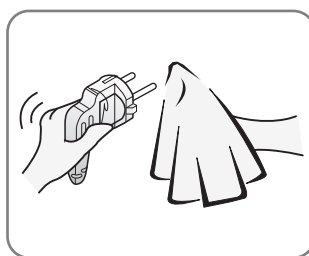

- Wipe dirt and stains from the power cord and insert firmly into the socket

.....

Dirt and poor connections may cause fire

Safety Instructions

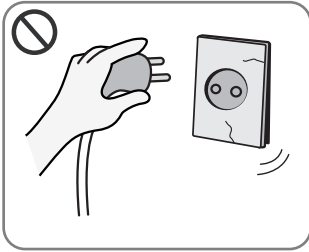

- Do not use if power cord, plug or socket is damaged

May cause fire or electric shock

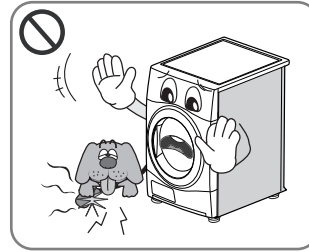

- Keep pets away from the dryer

Pets may damage the dryer, or may receive an electric shock



- Do not install or store the dryer where it will be exposed to the weather.

May cause fire, electric shock or malfunction

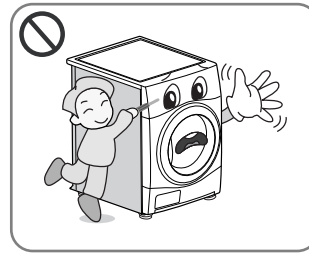

- Do not depress buttons using sharp implements such as knives and screwdrivers

May damage the dryer or cause electric shock

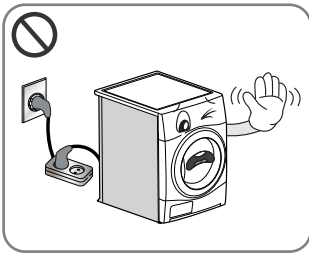

- Do not use an extension cord or an adaptor to connect the power cord.

May cause fire or electric shock

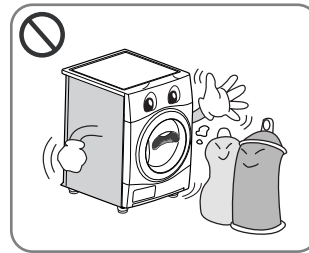

- Do not dry articles that have been cleaned in, washed in, soaked in, or spotted with combustible or explosive substances (such as wax, oil, paint, gasoline, degreasers, dry-cleaning solvents, kerosene, etc.)

May cause fire or electric shock

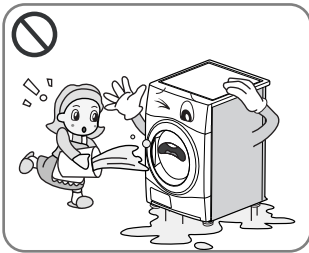

- Do not splash water on to the dryer.

May cause fire or electric shock

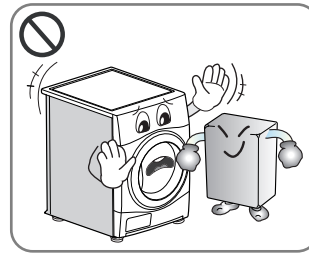

- Do not place flammable items near the dryer.

May cause toxic gases, parts damage, fire or explosion

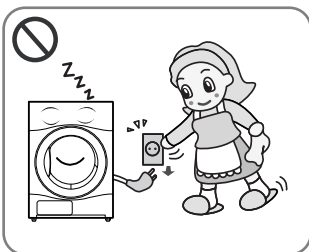

- Unplug the power cord when cleaning or not using the dryer.

Water or dirt may cause an electric shock.

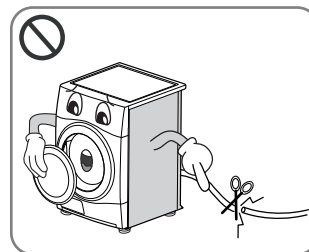

- Before the appliance is removed from service or discarded, disassemble the door and cut off the power cord to prevent the future use.

May cause accident and injury



- Do not allow children or pets to play on or inside the dryer.
- The appliance is not intended for use by young children or infirm persons without supervision.
- Young Children should be supervised to ensure that they do not play with appliance.

Children and pets may injure or suffocate themselves.

Safety Instructions

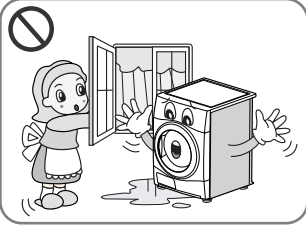

- If this appliance is supplied from a cord extension set or an electrical connector, portable outlet device must be positioned so that is not subject to splashing or ingress of moisture.

It may cause an electric shock, a fire, malfunction and deformation.

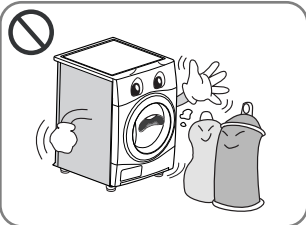

- Items that have been spotted or soaked with vegetable or cooking oil constitute a fire hazard and should not be placed in a tumble dryer.
- Items that have been soiled with substances such as cooking oil, acetone, alcohol, petrol, kerosene, spot removers, turpentine, waxes and wax removers should be washed in hot water with an extra amount of detergent before being dried in the tumble dryer.

May cause spontaneous combustion leading to explosion and fire

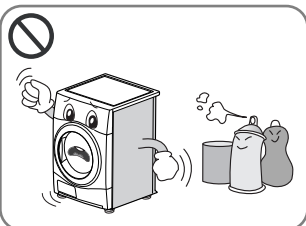

- Items that have been previously cleaned in washed in soaked in or spotted with petrol/gasoline, dry cleaning solvents or other flammable or explosive substances should not be used in a tumble dryer.

May cause spontaneous combustion leading to explosion and fire

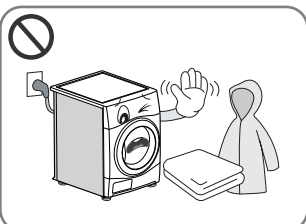

- Items made of foam, rubber, plastic, or other heat-sensitive fabrics (such as bathroom rugs, nonslip mats or raincoats) should not be dried in a tumble dryer on a heat setting.
- Items such as foam rubber (latex foam), shower caps, waterproof textiles, rubber backed articles and clothes or pillows fitted with foam rubber pads should not be dried in the tumble dryer.

May cause spontaneous combustion leading to explosion and fire

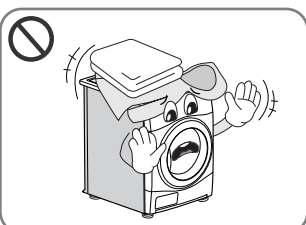

- Plastic articles such as shower caps or waterproof nappy covers should not be placed in a tumble dryer.

May cause spontaneous combustion leading to explosion and fire

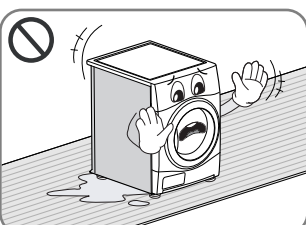

- If dryer is installed on a carpet, damage may be caused to it by ventilated air

May cause spontaneous combustion leading to explosion and fire

- Fabric softeners, or similar products, should be used as specified by the fabric softener instructions.
- To reduce the risk of personal injury, adhere to all industry recommended safety procedures including the use of long sleeved gloves and safety glasses. Failure to follow all of the safety warnings in this manual could result in property damage, personal injury or death.

Installation Instructions

The following instructions will guide you through the initial steps of setting up your dryer. Please note that every section of this manual provides important information regarding the preparation and use of your dryer, and it is important that you review this entire manual before proceeding with any installation or use. Be sure to observe all listed warnings and cautions. These installation instructions are intended for use by qualified installers. Read these installation instructions completely and carefully.

Safety Information

Risk of Injury

The dryer is very heavy so you shouldn't try to lift it alone.

Do not lift the dryer by grasping any of the protruding parts e.g. or the jog dial or the door. they may break off.

Risk of Tripping

Ensure there are no loose hoses or cables.

Check the dryer for damage occurred during transportation.

Do not connect the dryer if it has visible signs of damage.

If you are not confident, contact your local LG agent. Always empty the dryer completely before transporting it.

Your dryer should not be located near to a gas hob, cooker, heater or grill, as flames from the burners could damage your dryer. When the dryer is fitted beneath a work surface, allow 30cm~50cm space at either side of the dryer and at the back of the dryer to allow air to exit the rear grille. This air flow is critical for condensation of water during the drying process.

If you use this dryer near or stacked on top of your washing machine, separate main plugs and sockets must be used for each appliance. Do not use 2-way adaptor or extension lead.

You can stack the dryer on top your washing of washing machine to save space. A stacking kit is available from your local shop.

Stacking Installation Instructions

Your LG dryer can be placed on top of a front loading washing machine and securely fixed with a stacking kit (see following page for instructions). This installation must be conducted by an experienced installer to ensure it has been installed correctly.

An installer will ensure you have the correct stacking kit for your model of washing machine and will ensure it is firmly fixed. For these reasons, expert fitting is essential.

⚠ CAUTION

CAUTION Concerning the power cord

Most appliances recommend they be placed upon a dedicated circuit; that is, a single outlet circuit which powers only that appliance and has no additional outlets or branch circuits. Check the specification page of this owner's manual to be certain.

Do not overload wall outlets. Overloaded wall outlets, loose or damaged wall outlets, extension cords, frayed power cords, or damaged or cracked wire insulation are dangerous. Any of these could result in electric shock or fire. Periodically examine the cord of your appliance, and if its appearance indicates damage or deterioration, unplug it, discontinue use of the appliance, and have the cord replaced with an exact replacement part by an authorized servicer.

Protect the power cord from physical or mechanical abuse, such as being twisted, kinked, trapped in a door, or walked upon. Pay particular attention to plugs, wall outlets, and the point where the cord exits the appliance.

Installation Instructions

Stacking Kit

In order to stack this dryer an LG stacking kit is required.

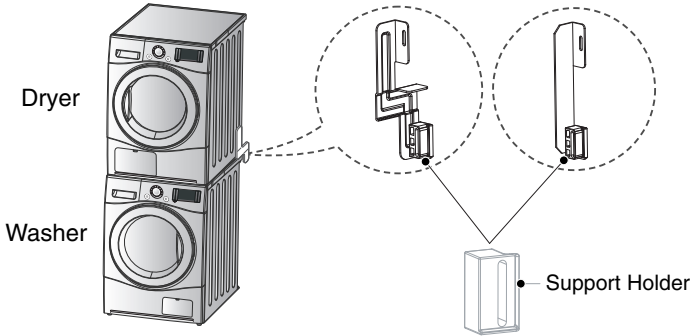

This dryer may only be stacked on top of an LG washer. DO NOT attempt to stack this dryer on any other washer, as damage, injury or property damage could result.

To stack this dryer, the support holder included with the stacking kit must be used.

Shape	Washer Top plate size		Support Holder
	21.7 inch (550mm)	23.6 inch (600mm)	

Installation Procedure

1. Place the LG dryer on the LG Washing machine.
2. Remove the two screws from the bottom of the rear cover on each side as illustrated below.

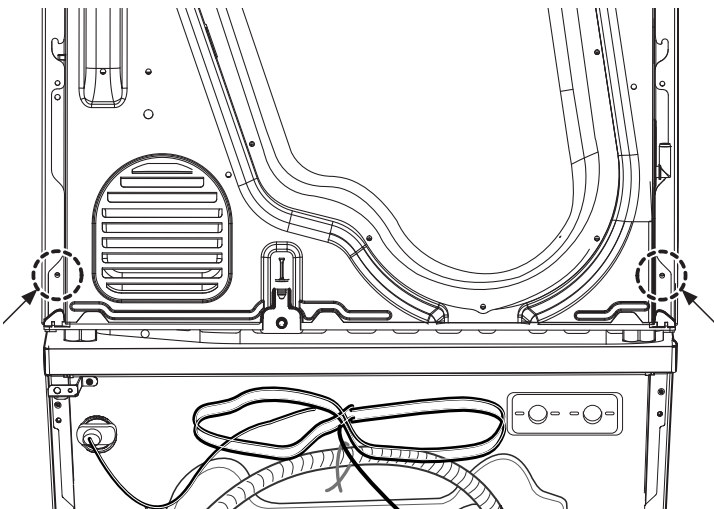

WARNING

- Incorrect installation can cause serious accidents.
- The weight of the dryer and the height of installation makes the stacking procedure too risky for one person. This procedure should be performed by 2 or more experienced service personnel.
- The dryer is not suitable for a built-in installation. Please do not install as a built-in.
- Do not operate if the dryer is disassembled.

3. Assemble the stacking kit as following.

- Peel the protective film from the double-sided tape on the bracket for your size washer.
- Attach the support holder.
- Align the stacking kit holes and the rear cover holes and then firmly attach the bracket to the side of the washer in that position.

23.6 inch(600 mm)

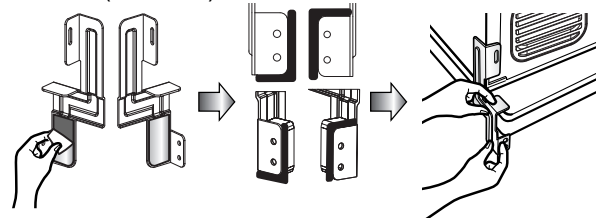

21.7 inch(550 mm)

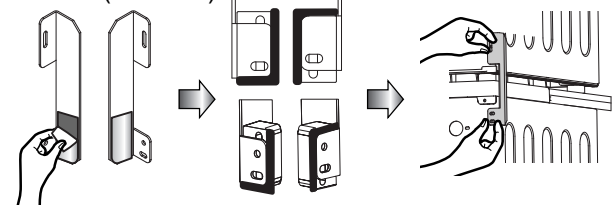

4. Assemble the stacking kit as follows

- Screw the 2 screws that were removed earlier into the washer, dryer and stacking kit
- Use accessory screws [1.2inch (30mm)] to assemble washer rear cover and stacking kit. ②,③
- The procedure for the opposite side will be the same.

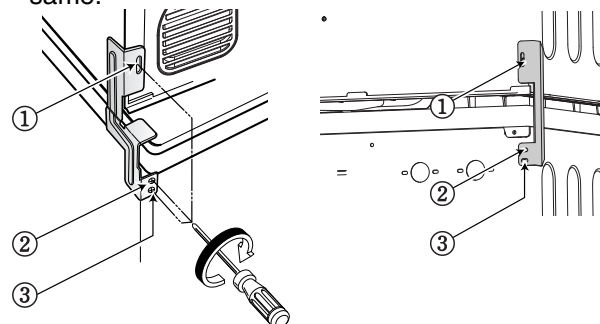

Installation Instructions

Earthing Instructions

This appliance must be earthed. In the event of malfunction or breakdown, earthing will reduce the risk of electric shock by providing a path of least resistance for the electric current.

This appliance is equipped with a earthed cord and an earthing plug. The plug must be plugged into an appropriate outlet that is properly installed and earthed in accordance with Standard.

Additional Grounding Procedure

Some local power cord may require a separate ground. In such cases, the required accessory ground wire, clamp and screw must be purchased separately.

Condensed Water Drain

This appliance can be plumbed directly into the mains waste with the adaptor supplied. Condensed water will drain away. A plumber will be required.

Note

For better drying performance, Please keep the rear of product away from wall.

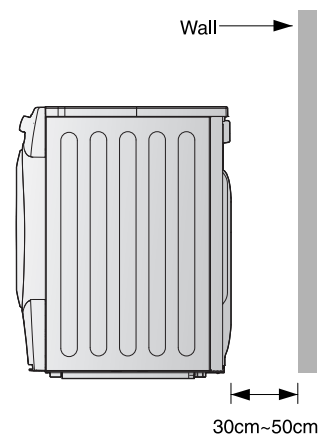

Installation Instructions

● Level the Dryer

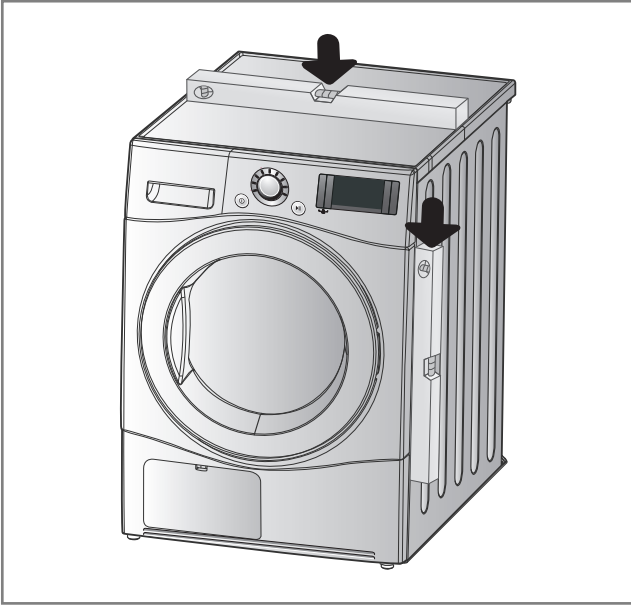

1. Levelling the dryer prevents undesirable noise and vibration. Place your dryer on a solid, level floor

Place the dryer in an area free from flammable materials, condensation and not liable to freezing.

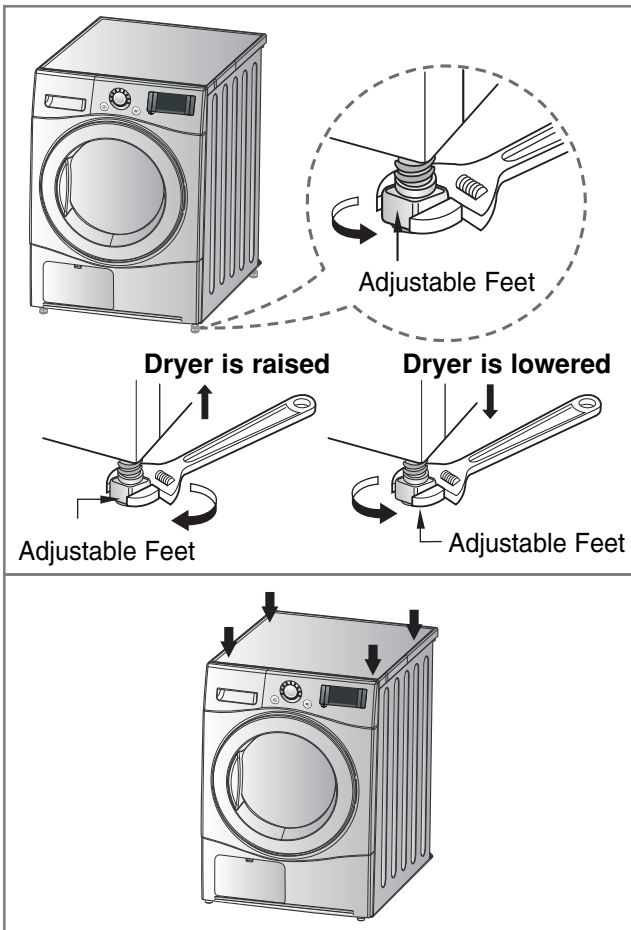

2. If the dryer is not properly level, adjust the front levelling legs as necessary.

Turn them clockwise to raise and counterclockwise to lower until the dryer is not wobbling both front-to-back and side-to-side.

* Diagonal Check

When pushing down the edges of the machine, the machine should not move up and down at all.

(Please, check both of two directions)

If machine rocks when pushing the machine top plate diagonally, adjust the feet again.

Appearance & Design

RC7020A/B/C

RC7020A1/B1/C1

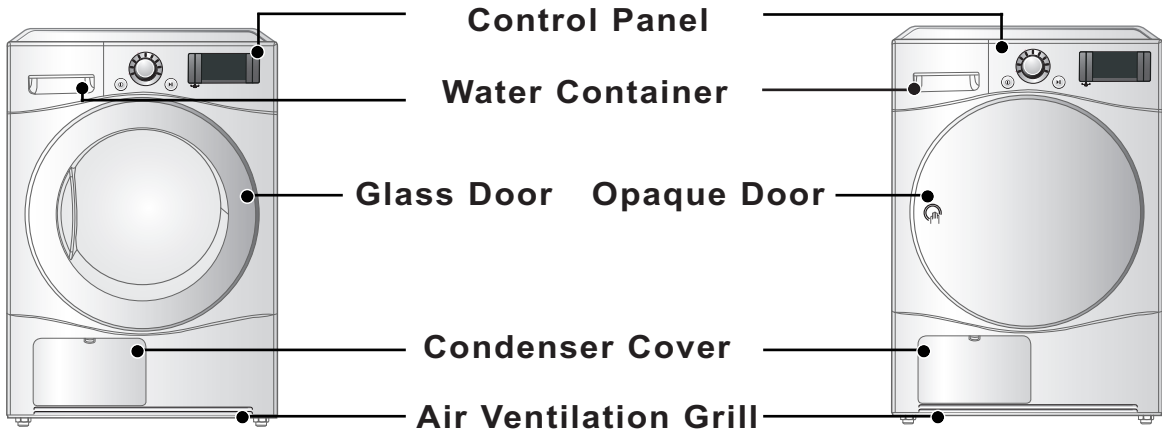

Control Panel

RC7020A/B/C

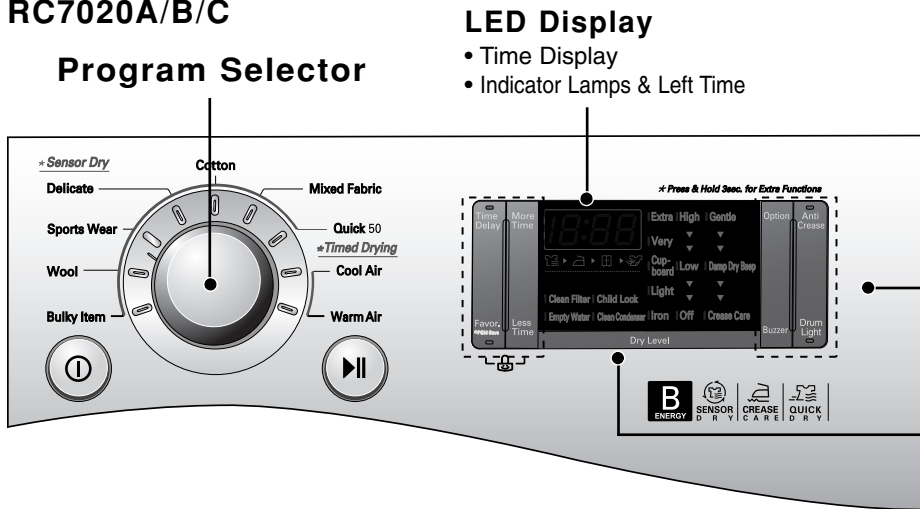

Additional Function Buttons

- More Time
- Less Time
- Option
- Buzzer
- Time Delay/Favorite
- Anti-Crease/Drum Light

Drying Level

- Iron
- Light
- Cupboard
- Very
- Extra

RC7020A1/B1/C1

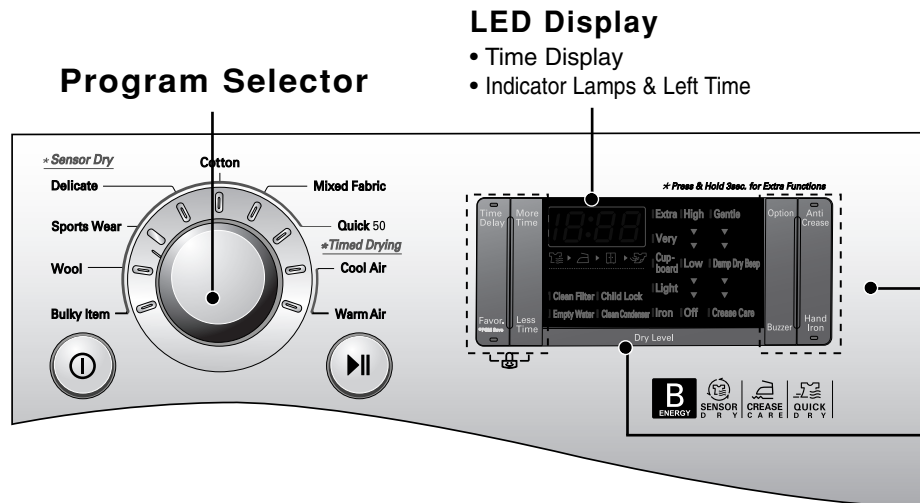

Additional Function Buttons

- More Time
- Less Time
- Option
- Buzzer
- Time Delay/Favorite
- Anti-Crease/Hand Iron

Drying Level

- Iron
- Light
- Cupboard
- Very
- Extra

Operating Your Dryer

Cycle Selection Table

Electronic Sensor Dry Course			
Course	A kind of Laundry	Detail	Drying Level
Cotton Cycles Note Select the gentle cycle by pressing the option button for heat-sensitive items	Towels, dressing gowns and bed linen	For thick and quilted fabrics	Extra
	Terry towels, tea towels, towels, bed linen	For thick and quilted fabrics that do not need to be ironed	Very
	Bath towels, tea towels, underwear, cotton socks	For fabrics that do not need to be ironed	Cupboard
	Sheets, pillowcase, towels	For fabrics that do not need to be ironed	Light
	Bed linen, table linen, towels, T-shirts, Polo shirts and work clothes	For fabrics that do need to be ironed	Iron
Mixed Fabric Cycles Note Select the gentle cycle by pressing the option button for heat-sensitive items	Bed linen, table linen, tracksuits, anorak, blankets	For thick and quilted fabrics that do not need to be ironed	Very
	Shirts, blouses	For fabrics that do not need to be ironed	Cupboard
	Trousers, dressers, skirts, blouses	For fabrics that do need to be ironed	Iron
Quick 50	Linen and towel except for fabrics applied to Delicate, Sports wear, Wool and Bulky Item course.	For the small loads of qualified fabrics with short drying times	-
Delicate	Silk, Fine fabrics, Lingerie	For fabrics that are heat-sensitive like synthetic fabrics	-
Sports Wear	Soccer kit, training wear	For 100% polyester material	-
Wool	Wool	For wool fabrics	-
Bulky Item	Bed clothes, sheets	For bulky items	-
Timed Drying Programme			
Cool Air	All fabrics that need refreshing.	Tumbles without heat	-
Warm Air	Bath towels, bath robes, dishclothes, quilted fabrics made of acrylic	Small clothes & pre-dried laundry. Normal fabrics using hot temperature for drying.	-

CAUTION

If the load is less than 1kg, please use "Warm Air" programme in timed drying programme. Wool items should be dried using in "Wool" programme and heat-sensitive fabrics including silk, underwear, lingerie should be dried using "Delicate" programme. Please comply with the recommended laundry load when you use the assigned programme. Otherwise, your clothes may be damaged.

Operating Your Dryer

● Please read before using your LG Dryer for the first time

※ After removing the packaging, please carry out the following checks to ensure the LG Dryer is correctly installed and ready for use. (see installation instructions)

1. Check the dryer is well balanced by using a spirit level. If not, adjust the feet of the LG Dryer until the machine is balanced.
2. Check the water container, condenser, control panel and drum to make sure everything is in place.
3. Set the machine to dry for 5 minutes to warm up the drum.
4. Open the door between loads the first few times you use the machine to allow any odours from the interior of the LG Dryer to escape.

Note

The final part of a tumble dryer cycle occurs without heat (cool down cycle) to ensure that the items are left at a temperature that ensures that the items will not be damaged.

1. Turn the power on.

First, press the "Power" button. The indicator light above the button will become illuminated indicating that the machine is all set to run.

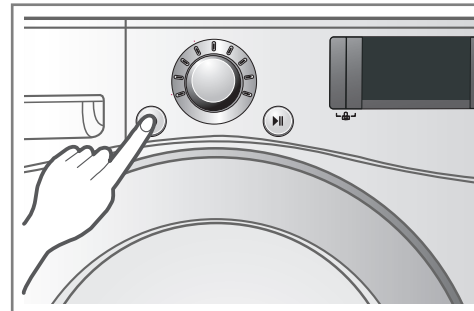

Turn the power on.

2. Open the door.

3. Check the lint filter and container are clean.

All fabrics that need refreshing. Tumbles without heat. The lint filter is inside the door rim or in the back of the door. It needs to be cleaned before and after drying.

Open the door and check the lint filter is clean.

If not, please clean it referring to page 16.

Also check if water container or condenser need to be emptied and cleaned for better drying results.

4. Place laundry into the drum after sorting.

The clothes should be sorted by fabric type and dryness level and all the strings and belts of clothes should be well tied and fixed before being put into the drum.

Push the laundry to the back to keep it away from the door seal.

If not, the door seal and clothes may be damaged.

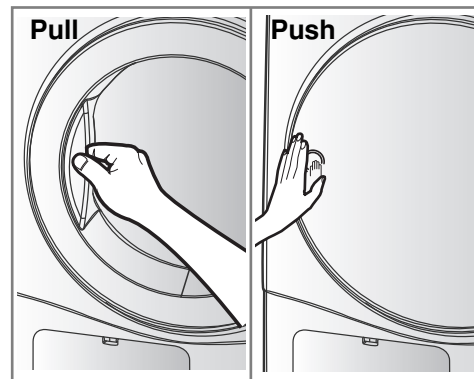

Open the Door.

Glass Door

Opaque Door

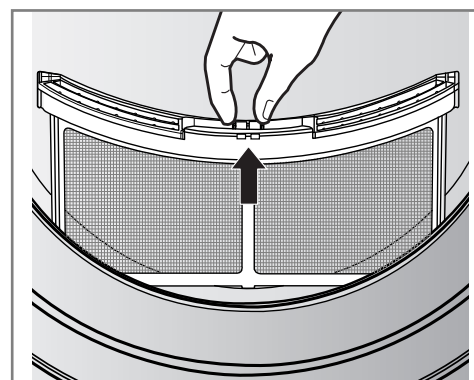

Check the lint filter.

⚠ CAUTION

Do not dry unwashed items in the tumble dryer.

Operating Your Dryer

5. Close the door.

Before you close the door, make sure fabrics are well placed inside and that foreign objects, especially flammable ones, are not caught around door.

⚠ CAUTION

- Be careful not to trap laundry between the loading door and rubber seal.

6. Select the drying cycle you want.

You can choose a cycle by turning the program control knob until the required program is indicated. If you press Start/Pause button without choosing a cycle, the dryer will proceed with the Cupboard program. [Please refer to Cycle Selection table (page 11) for the detailed information.]

7. Press the start button.

You will hear drum rotating.

8. After the cycle has finished, open the door and remove the laundry.

Careful! the drum inside could still be hot. (Operation time varies depending on your cycle selection or options.)

Note

The final part of a tumble dryer cycle occurs without heat (cool down cycle) to ensure that the items are left at a temperature that will not damage them.

9. Clean the lint filters and empty water container.

The lint filter should be cleaned after each load.

10. Turn off the dryer.

Press the "Power" button.

⚠ CAUTION

- if using a vacuum cleaner to clean the lint as it is easily damaged and torn. If there is a residue build up on the filter, scrub the lint screen with a brush to remove.
- If you want to open the door while dryer is operating, please press the Start/Pause button first, wait until drum completely stops and then open the door.

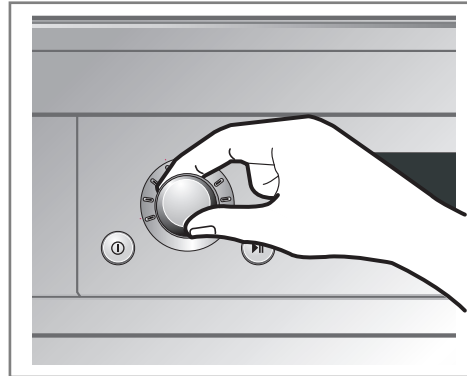

Select the desired cycle.

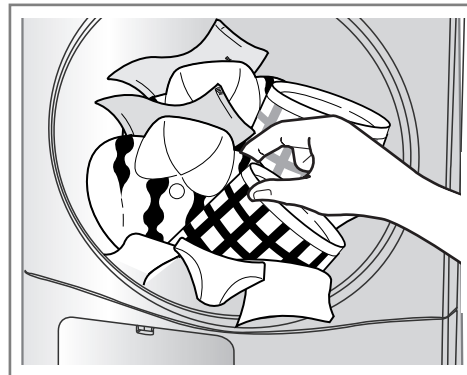

Take out the laundry.

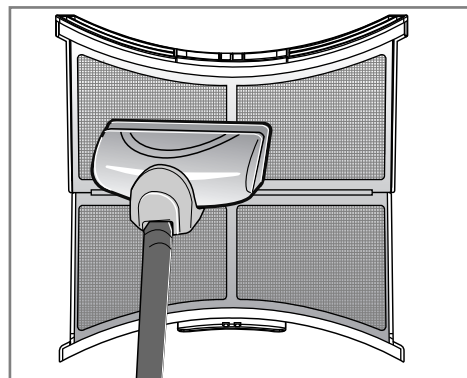

Clean the door lint filter.

⚠ WARNING

Never stop a tumble dryer before the end of the drying cycle unless all items are quickly removed and spread out so that the heat is dissipated.

⚠ CAUTION

It must not be used for purposes other than those for which it was designed.

Additional Functions

RC7020A/B/C

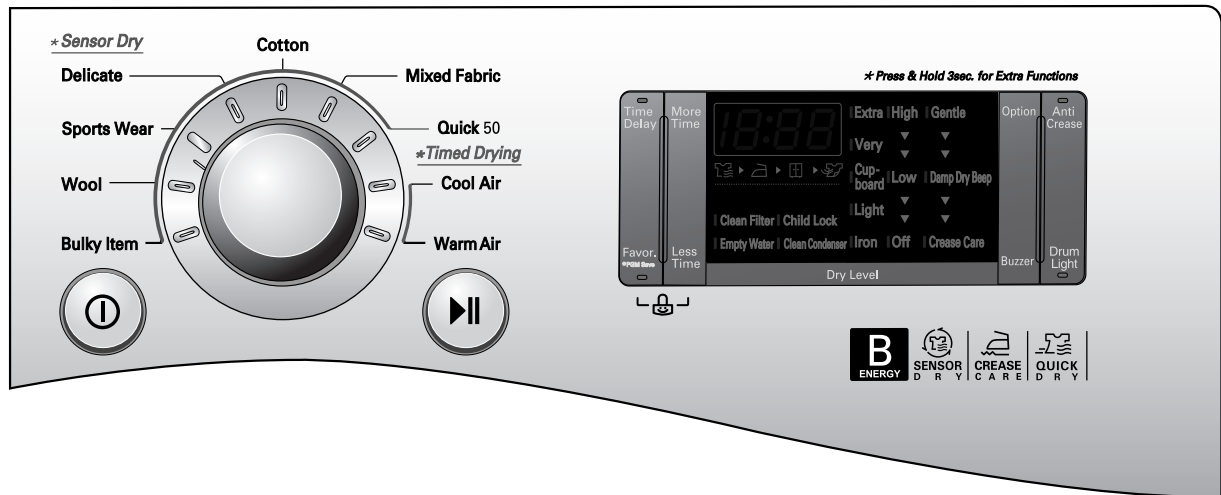

RC7020A1/B1/C1

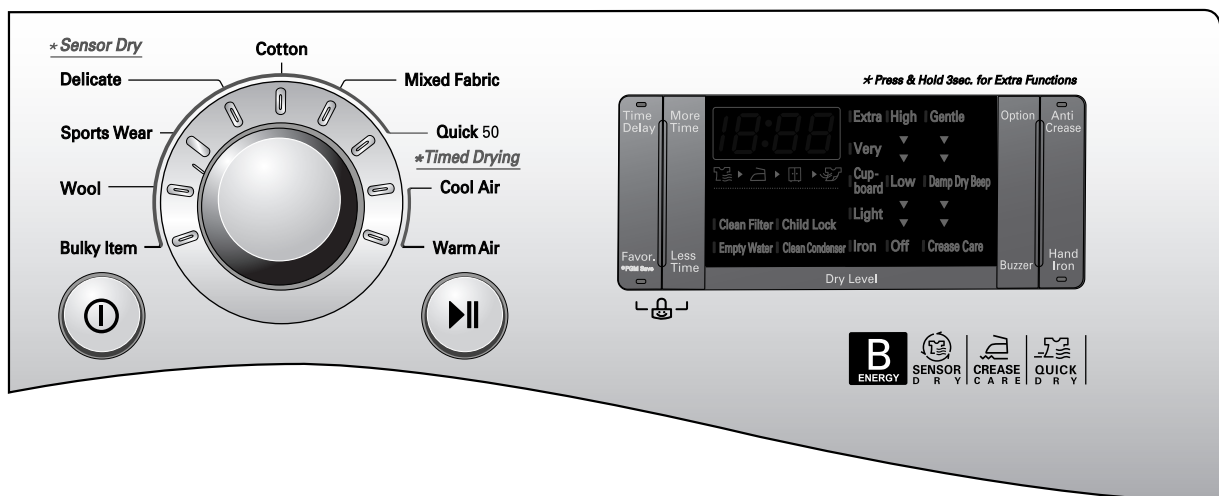

Time Delay

You can use the Time Delay function to delay the finishing time of drying cycle.

Maximum Time Delay is 19 hours.

Minimum Time Delay is 3 hours.

1. Turn the dryer on
2. Select cycle
3. Set time delay hour
4. Press Start/Pause button

Favorite

If you have a series of settings that you always seem to come back to, you can store this as a unique drying programme. For example, if your favorite setting is normally Extra Dry Cotton, with Low Temp and Anti-Crease, just select these settings and press "Favorite" until the dryer beeps. This programme is now stored as your Favorite and ready to be used again and again.

Additional Functions

● Anti-Crease

The Anti Crease function prevents creases that are formed when the laundry is not unloaded promptly at the end of the drying cycle. When Anti Crease is selected, the dryer repeatedly runs and pauses, giving you 4 hours to unload the washing.

If the door is opened during the Anti-Crease cycle, the cycle is cancelled.

● Drum Light/Hand Iron

Drum Light (Glass Door)

- Whilst the dryer is running it is possible to see inside the drum if you select the Drum Light function.

Hand Iron (Opaque Door)

The Hand Iron setting leaves a higher level of moisture in the laundry than Machine Iron.

Note

This function is available only with Cotton-Iron and Mixed-Iron cycles.

● More Time/Less Time

Press More Time or Less Time until the desired drying time is set.

Note

These buttons are available only with Timed Drying, before you push Start/Pause button.

● Child Lock ([L])

For the safety of your children, press Favorite and Less Time buttons at the same time for about 3 seconds. You will see “ [L] ” sign on LED window.

- all controls except child lock and power buttons will be disabled.
- child lock lasts after the end of cycle.

Note

For “ [L] ” off, press Favorite and Less Time buttons at the same time for about 3 seconds.

● Option

Gentle

- This function shortens or lengthens the cycle time by increasing or decreasing temperature.
- This option is used only with the Cotton and Mixed Fabric cycles.

Damp Dry Beep

- This function lets you know when the clothes are ready for ironing
- This option is used only with the Cotton and Mixed Fabric cycles.
- You cannot use the ‘Damp Dry Beep’ when you select Iron Dry

Crease Care

- This function reduces creases.
- This is the default function when you select the Mixed Fabric cycle and it cannot be cancelled.

Note

The above functions can all be selected using the option button.

- Once : Gentle is selected.
- Twice : Damp Dry Beep option is selected.
- 3 Times : Gentle and Damp Dry Beep options are selected.
- 4 Times : No selected.

● Buzzer

This function allows the volume of the beeper sound to be adjusted.

Caring for Your Dryer

Care and Cleaning is very Important

It's not difficult to care for your dryer but it is important that you do care for it. Follow the instructions below

Clean Lint Filter

Clean lint filter after each use and check it before each use. It should also be cleaned if the "Clean Filter" light becomes illuminated and the buzzer sounds during operation of the dryer:

Cleaning or emptying the filter will reduce drying times and energy consumption and lengthen the dryer life.

⚠ CAUTION

- The lint trap has to be cleaned frequently, if applicable.
- Lint must not be allowed to accumulate around the tumble dryer.

1. Open the door.

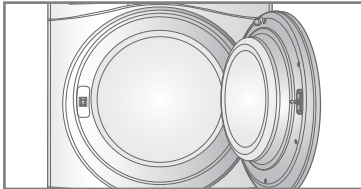

2. Pull the filter out.

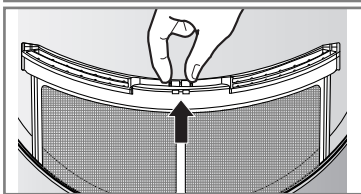

3. Clean the filter by using a vacuum cleaner or rinsing under the tap.

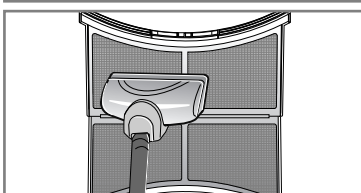

4. Replace the filter.

- Push the filter all the way down to avoid interference with the door.

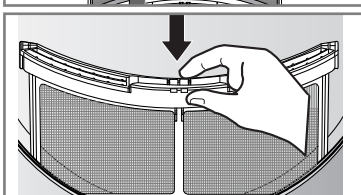

5. Close the door.

⚠ CAUTION

- After washing the lint filter please dry thoroughly
- Lint must not be left to accumulate in the dryer

Clean lint filter during a cycle

If "Clean Filter" indicator lamp flashes during operation, clean the filter promptly.

1. Cool the dryer down and follow the mentioned steps.
2. Press the start/Pause button.

Empty Water Container

Condensed water is collected in the water container.

Empty the water container after every use. Not doing so will affect the drying performance.

If the water container is full, the "Empty Water" lamp glows and the buzzer sounds while the dryer is operating. If this should occur, the water container needs to be emptied within the next hour.

1. Draw water container out.

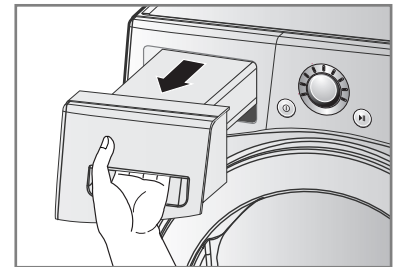

2. Empty water container to sink.

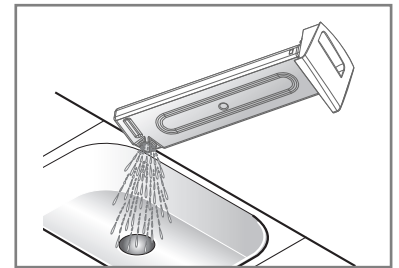

3. Push it back.

4. Press the Start/Pause button.

Note

A high atmospheric temperature and a small room may both increase drying time as well as energy consumption

⚠ WARNING

Do not drink the condensed water.

⚠ CAUTION

If the laundry is not spun at a high speed during washing, energy consumption and drying time will increase

In some instances, the laundry lamp may flash "Empty Water" and the dryer may stop because the water container is full

Caring for Your Dryer

Condenser

Condenser is also a very important part for efficient drying performance result so it needs a special care from you. It is recommended that condenser be cleaned three or four times a year or when the condenser clean lamp blinks.

1. Push the cap and open the condensing cover.

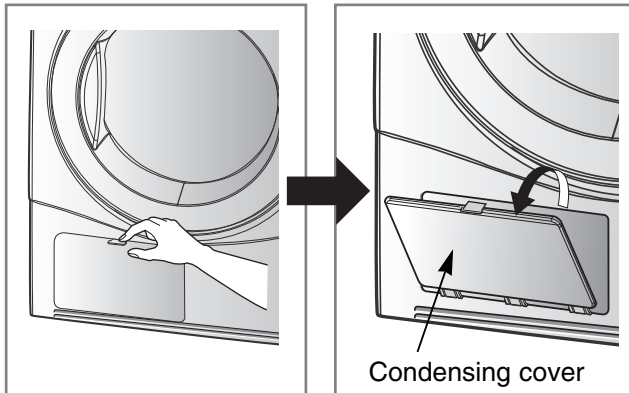

2. Open seal by turning the locking lever

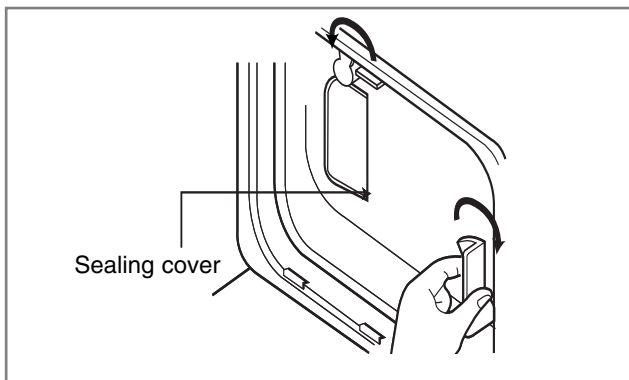

3. Pull the condenser out by inserting a finger into the tab at the front of the condenser. (Don't force the condenser)

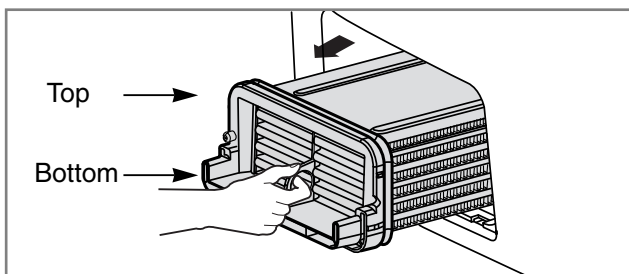

4. Clean the condenser thoroughly under a tap, letting the water flow through

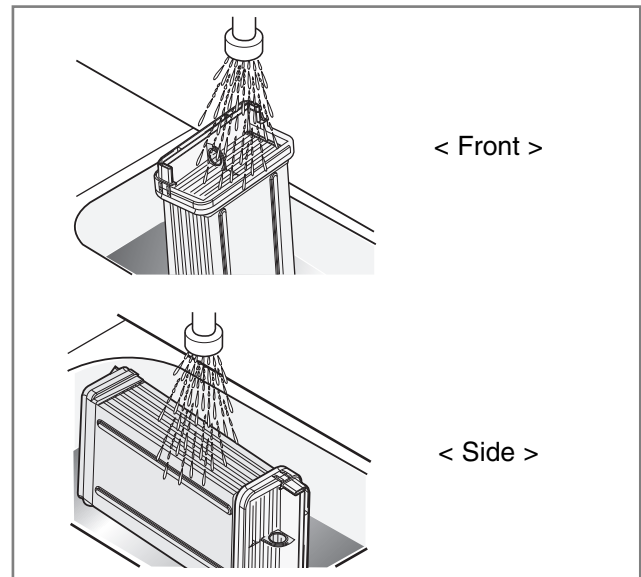

5. Put everything back together by following the instructions in reverse order

⚠ CAUTION

The locking lever must be closed after cleaning the condenser as below.

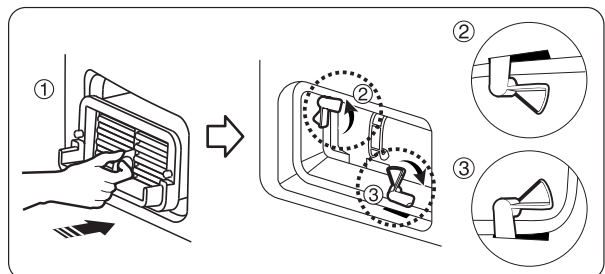

⚠ CAUTION

- Operating when the condenser is clogged with lint can damage the dryer. This also increases energy consumption.
- Do not use sharp objects to clean the heat exchanger. This could cause damage and leaking.
- Never operate the dryer without the heat exchanger.

Caring for Your Dryer

Ventilation Grille and Cool Air Inlet Grille

Vacuum the front ventilation grille 3-4 times a year to make sure there is no build up of lint or dirt that could cause improper air flow

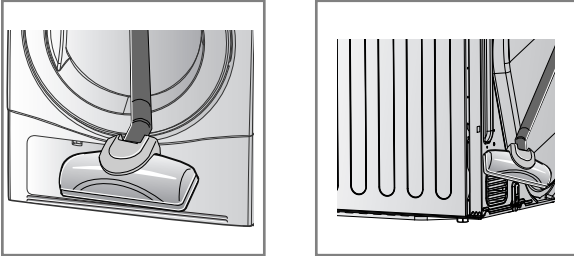

Note

- Warm air is exhausted through the ventilation grill
- Adequate ventilation has to be provided to avoid the back flow of gases into the room from appliance's burning other fuels, including open fires.

Condensed Water Drain-out

Normally, condensed water is pumped up to the water container where water is collected until manually emptied. Water can also be drained out directly to a mains drain, especially when the dryer is stacked on top of a washing machine. With a connecting kit for a mains drain hose, simply change the water path and reroute to the drainage facility as below:

1. Take connecting kit out.

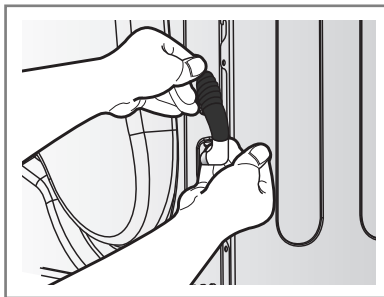

2. Separate water container hose from the kit.

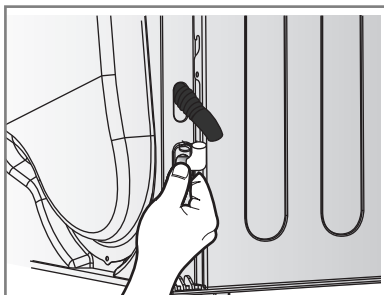

3. Connect drain hose to the kit.

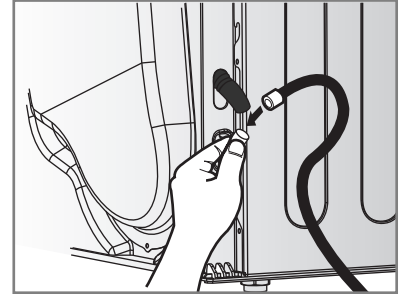

Moisture Sensor?

The device senses the moisture level of the laundry during operation, which means it must be cleaned regularly to remove any build up of lime scale on the surface of the sensor. Wipe the sensors inside drum (as illustrated)

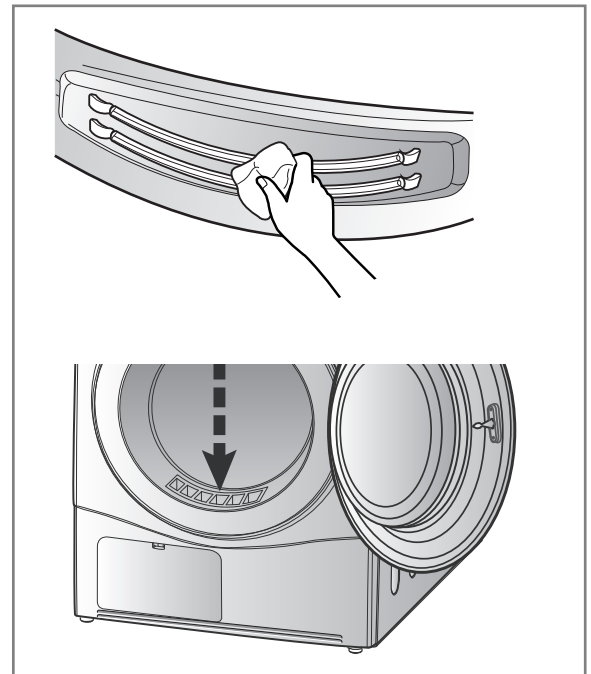

Additional Tips for Smart Use

● Drying Guide Capacity for laundry type

PROGRAMME		Ca. of Dryer	Display Drying Time (Including Cooling Time)
Cotton	Iron	7kg	97min
	Light *	7kg	103min
	Cupboard	7kg	115min
Mixed Fabric	Cupboard	3kg	48min
Quick 50		2kg	50min
Delicate		1.5kg	45min
Sports Wear		1.5kg	30min
Wool		1kg	21min
Bulky Item		1.5kg	60min

WOOLLENS

Dry woollens on "wool" cycle. Be sure to follow fabric care label "symbols", first. Wool is not completely dried from the program so don't repeat drying. Pull woollens to their original shape and dry them flat.

Woven and Loopknit Materials

Some woven and loop knit materials may shrink, depending on quality

Permanent Press and Synthetics

Do not overload your dryer. Take out permanent press items as soon as the dryer stops to reduce creases.

Baby Clothes and Night Gowns

Always check the manufacturer's instructions.

Rubber and Plastics

Do not dry any items made from or containing rubber or plastics such as:

- Aprons, Bibs and Chair Covers
- Curtains and Table Clothes
- Bathmats

FIBREGLASS















Do not dry fiberglass articles in your dryer. Glass particles left in the dryer could be picked up by your clothes the next time you use the dryer and irritate your skin.

Fabric Care Labels

Clothes have their own wash care labels, so drying according to the wash care label is recommended. Not only that, the laundry must be sorted according to size and fabric type.

For the best drying performance and most efficient energy usage, do not overload the dryer.

Below are fabric care labels.

Symbols	Instructions
	Dry
	Tumble dry
	Permanent Press / Wrinkle resistant
	Gentle / Delicate
	Do not tumble dry
	Do not dry
	High heating
	Medium heating
	Low heating
	No heat / air
	Line Dry / hang to dry
	Drip dry
	Dry flat
	In the shade

Additional Tips for Smart Use

Spare Parts

Spare parts that are required under the terms of warranty are provided free of charge. If the warranty has expired then spare parts must be purchased from the service centre.

Disposal of the Dryer

It is requested that you dispose of your dryer safely to protect your children and others from possible injury. The door, lid and other protruding parts must be removed and the power cord cut off before safe disposal.

Service Contact

If there is a problem with your dryer, first consult the Trouble Shooting table. If you cannot find the error and you are unable to resolve the problem, please contact the Service Centre.

A Customer Service representative will ask you the following questions:

1. Name, address and postcode
2. Phone number
3. Description of problem
4. Model number and serial number of your dryer
5. Date of Purchase

Accessory Parts

- Your dryer comes with accessories such as

1. Condensing Drain Hose

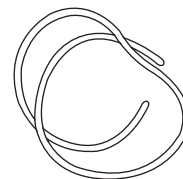

2. Hose Holder

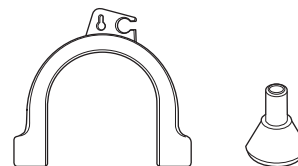

Stacking Kit

①



Holder : 2EA, Screw : 4EA
Supporter Holder : 2EA
Purchased Separately

②

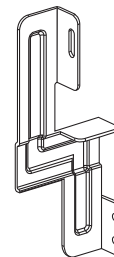

Holder : 2EA, Screw : 4EA
Supporter Holder : 2EA
Purchased Separately

Stacking kit Use

- fig ① : Washer top plate size 550
- fig ② : Washer top plate size 600

If stacking is needed, you must stack the dryer upon LG washing machine. In order to do this, stacking kit must be purchased separately.

Troubleshooting Guidelines

● Troubleshooting Tips

To save you time and money, the following page will help answer your questions before service call.

Questions	What to do
Dryer won't run	<ol style="list-style-type: none"> 1. Check dryer is plugged in. 2. Check "Start" button is pressed. 3. Check door is properly closed. 4. Check Room temperature is below 5°C. 5. Check a fuse is not blown or the circuit breaker is tripped and replace them. (Caution : electric dryers generally use two fuses or breakers) After emptying the water container and Cleaning filter during operation, you must press Start button, then the dryer operates again.
It takes a long time to dry	<ol style="list-style-type: none"> 1. Filter should be cleaned after each load. 2. Check water container is emptied. 3. Check cleanness of condenser. 4. Select correct programme setting for fabric type. 5. Check air ventilation grille or rear vents of dryer are not obstructed. 6. Check clothes are not excessively wet. 7. Check correct program selected. 8. Check the dryer is not overloaded.
"Clean Filter" lamp flashes	<ol style="list-style-type: none"> 1. Check filter is clean 2. Check condenser unit is not clogged
Clothes are covered in Fluff	<ol style="list-style-type: none"> 1. Check lint filter is empty. 2. Check all the items in the dryer are clean 3. Check all the laundry has been correctly sorted by fabric type 4. Check laundry is not overloaded 5. Check if there is any paper, tissues or other degradable items amongst the laundry and remove.
The drying time is not consistent	The drying time for a load will vary depending on the heat setting, the size of the load, the type of fabrics, the wetness of the clothes and the condition of the lint filter.
Water is leaking	Check if the door or seal cover is dirty or damaged
The clothes are creased	Check the laundry is not overloaded. Try a shorter drying time and remove items whilst they still retain a slight amount of moisture. Use the anti-crease function
The garments have shrunk	To avoid shrinkage, please follow the care and use instructions for your garment, as some fabrics shrink naturally when washed and other fabrics should not be placed in a dryer.

Troubleshooting Guidelines

● Error Mode

- dE : LED displays “ dE ” in case of the door open. The door must be closed and start Button must be pressed for re-operation.
- $EE1, EE3$: If error message continues to occur, unplug the power cord and call the Service Centre for advice.

● Drum light does not work

- Contact the customer service centre.

T echnical Data

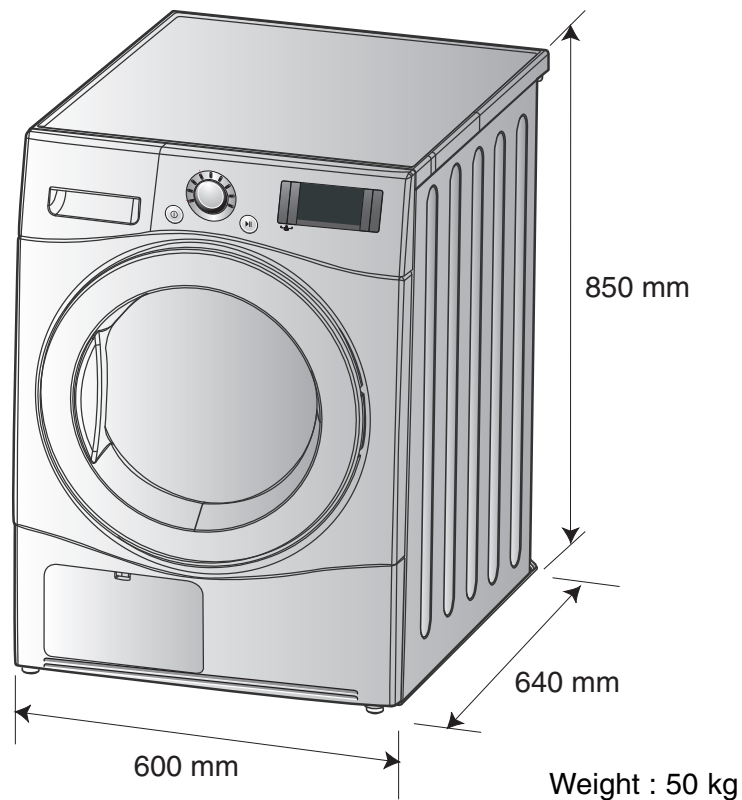

● Electrical Requirements

Volts	Hertz	Watts
220 - 240 V	50 Hz	2600

Ensure you connect the dryer to the correct electricity voltage. The ratings plate on your dryer shows you what the voltage should be.

● Ventilation Requirement

Alcove or undercounter	Closet
Ensure air flow of 112 cu.ft./min through dryer	Closet door must have 2 (louvered) openings, each having a minimum area of 60 sq. inches (387 sq.cm), located 3 inches (8 cm) from bottom and top of door.

Warranty

Disposal of your old appliance

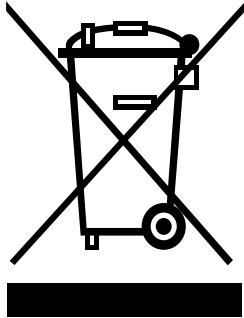

1. When this crossed-out wheeled bin symbol is attached to a product it means the product is covered by the European Directive 2002/96/EC.
2. All electrical and electronic products should be disposed of separately from the municipal waste stream via designated collection facilities appointed by the government or the local authorities.
3. The correct disposal of your old appliance will help prevent potential negative consequences for the environment and human health.
4. For more detailed information about disposal of your old appliance, please contact your city office, waste disposal service or the shop where you purchased the product.

■ What is not covered.

Service trips to your home to instruct you on the product.

If the product is connected to any voltage other than that shown on the rating plate.

Faults caused by accidental damage, neglect, misuse or Acts of God

If the fault is caused by reasons except for normal domestic use or use in accordance with the owner's manual.

Faults caused by vermin, for example rats, mice etc

Noise or vibration that is considered normal, for example, water drain sound, spin sound or warning beeps.

Correcting the installation for example, levelling the product, adjustment of drain.

Normal maintenance recommended by the owner's manual.

Removal of foreign objects/substances from the machine including the pump and inlet hose filter, for example, grit, nails, bra wires and buttons etc..

Replacing fuses, correcting wiring or correcting plumbing

Correction of unauthorized repairs.

Incidental or consequential damage to personal property caused by possible defects with this appliance.

If this product is used for commercial purposes its warranty is invalidated

(Example: Public places such as public bathroom, lodging house, training center, dormitory)

If the product is installed outside the normal service area, any cost of transportation involved in the repair of the products, or the replacement of a defective part, shall be borne by the owner.

Memo

Memo

Memo

