

# User's Guide

W2361V  
W2261VP  
W2261VG  
W2361VG

**M**ake sure to read the **Important Precautions** before using the product.  
Keep the User's Guide(CD) in an accessible place for future reference.

**S**ee the label attached on the product and give the information to your  
dealer when you ask for service.

---

**This unit has been engineered and manufactured to ensure your personal safety, however improper use may result in potential electrical shock or fire hazards. In order to allow the proper operation of all safeguards incorporated in this display, observe the following basic rules for its installation, use, and servicing.**

## On Safety

Use only the power cord supplied with the unit. In case you use another power cord, make sure that it is certified by the applicable national standards if not being provided by the supplier. If the power cable is faulty in any way, please contact the manufacturer or the nearest authorized repair service provider for a replacement.

The power supply cord is used as the main disconnection device. Ensure that the socket-outlet is easily accessible after installation.

Operate the display only from a power source indicated in the specifications of this manual or listed on the display. If you are not sure what type of power supply you have in your home, consult with your dealer.

Overloaded AC outlets and extension cords are dangerous. So are frayed power cords and broken plugs. They may result in a shock or fire hazard. Call your service technician for replacement.

As long as this unit is connected to the AC wall outlet, it is not disconnected from the AC power source even if the unit is turned off.

Do not Open the Display:

- There are no user serviceable components inside.
- There are Dangerous High Voltages inside, even when the power is OFF.
- Contact your dealer if the display is not operating properly.

To Avoid Personal Injury :

- Do not place the display on a sloping shelf unless properly secured.
- Use only a stand recommended by the manufacturer.
- Do not drop an object on or apply impact to the product. Do not throw any toys or objects on the product screen.  
It can cause injury to human, problem to product and damage the display.

To Prevent Fire or Hazards:

- Always turn the display OFF if you leave the room for more than a short period of time. Never leave the display ON when leaving the house.
- Keep children from dropping or pushing objects into the display's cabinet openings. Some internal parts carry hazardous voltages.
- Do not add accessories that have not been designed for this display.
- When the display is to be left unattended for an extended period of time, unplug it from the wall outlet.
- In the presence of thunder and lightning, never touch the power cord and signal cable because it can be very dangerous. It can cause electric shock.

## On Installation

Do not allow anything to rest upon or roll over the power cord, and do not place the display where the power cord is subject to damage.

Do not use this display near water such as near a bathtub, washbowl, kitchen sink, laundry tub, in a wet basement, or near a swimming pool.

Displays are provided with ventilation openings in the cabinet to allow the release of heat generated during operation. If these openings are blocked, built-up heat can cause failures which may result in a fire hazard. Therefore, NEVER:

- Block the bottom ventilation slots by placing the display on a bed, sofa, rug, etc.
- Place the display in a built-in enclosure unless proper ventilation is provided.
- Cover the openings with cloth or other material.
- Place the display near or over a radiator or heat source.

Do not rub or strike the Active Matrix LCD with anything hard as this may scratch, mar, or damage the Active Matrix LCD permanently.

Do not press the LCD screen with your finger for a long time as this may cause some afterimages.

Some dot defects may appear as Red, Green or Blue spots on the screen. However, this will have no impact or effect on the display performance.

If possible, use the recommended resolution to obtain the best image quality for your LCD display. If used under any mode except the recommended resolution, some scaled or processed images may appear on the screen. However, this is characteristic of the fixed-resolution LCD panel.

Leaving a fixed image on the screen for a long time may cause damage to the screen and cause image burn-in. Make sure to use a screen saver on the product. Burn-in and related problems are not covered by the warranty on this product.

Do not shock or scratch the front and sides of the screen with metallic objects. Otherwise, it may cause damage to the screen.

Make sure the panel faces forward and hold it with both hands to move. If you drop the product, the damaged product can cause electric shock or fire. Contact an authorized the service center for repair.

Avoid high temperatures and humidity.

## On Cleaning

- Unplug the display before cleaning the face of the display screen.
- Use a slightly damp (not wet) cloth. Do not use an aerosol directly on the display screen because over-spraying may cause electrical shock.
- When cleaning the product, unplug the power cord and scrub gently with a soft cloth to prevent scratching. Do not clean with a wet cloth or spray water or other liquids directly onto the product. An electric shock may occur. (Do not use chemicals such as benzene, paint thinners or alcohol)
- Spray water onto a soft cloth 2 to 4 times, and use it to clean the front frame; wipe in one direction only. Too much moisture may cause staining.

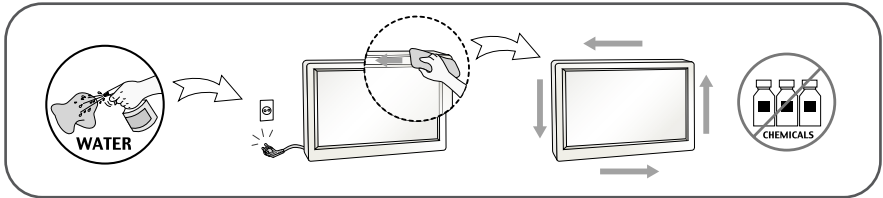

## On Repacking

- Do not throw away the carton and packing materials. They make an ideal container in which to transport the unit. When shipping the unit to another location, repack it in its original material.

## On Disposal

- The fluorescent lamp used in this product contains a small amount of mercury.
- Do not dispose of this product with general household waste.
- Disposal of this product must be carried out in accordance to the regulations of your local authority.

## Connecting the stand

1. Place the monitor with its front facing downward on a soft cloth.
2. Assemble the stand base into stand body in the correct direction as shown in the picture, then tighten the screw which is attached to the stand base.

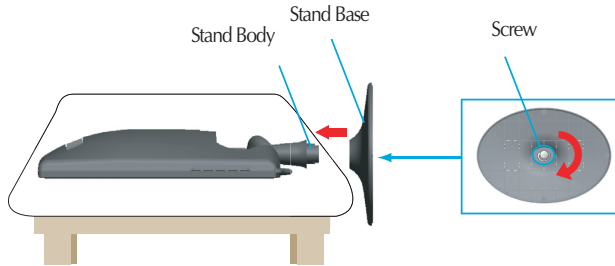

3. Once assembled take the monitor up carefully and face the front side.

## Disassembling the stand

1. Place the monitor face down on the cushion or soft cloth.
2. Loosen the screw which is attached to the stand base, then take off the stand base from stand body.

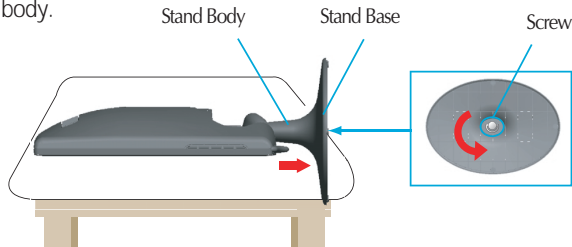

### Important

- This illustration depicts the general model of connection. Your monitor may differ from the items shown in the picture.
- Do not carry the product upside down holding only the stand base. The product may fall and get damaged or injure your foot.

# Connecting the Display

- Before setting up the monitor, ensure that the power to the monitor, the computer system, and other attached devices is turned off.

## Positioning your display

1. Adjust the position of the panel in various ways for maximum comfort.
  - Tilt Range:  $-5^{\circ}$ ~ $17^{\circ}$

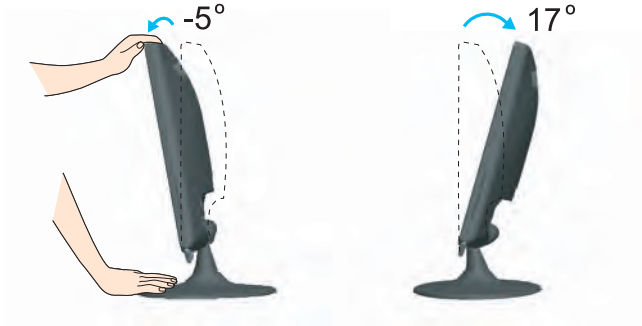

### Ergonomic

It is recommended that in order to maintain an ergonomic and comfortable viewing position, the forward tilt angle of the monitor should not exceed 5 degrees.

## Using the Computer

1. Make sure to turn off the computer and product. Connect the cable as below sketch map form ① to ②.

- A Connect DVI-D Cable
- B Connect D-sub Cable (PC)
- C Connect D-sub Cable (Mac)
- D Connect HDMI Cable

### NOTE

- This is a simplified representation of the rear view.
- This rear view represents a general model; your display may differ from the view as shown.
- User must use shielded signal interface cables (D-sub 15 pin cable, DVI cable) with ferrite cores to maintain standard compliance for the product.

## ■ W2261VP/W2261VG

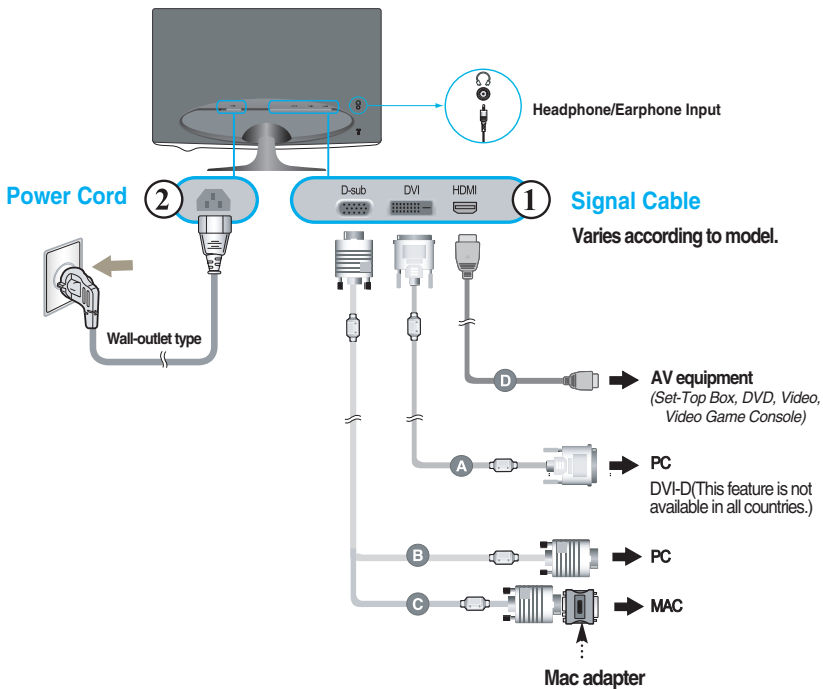

For Apple Macintosh use, a separate plug adapter is needed to change the 15 pin high density (3 row) D-sub VGA connector on the supplied cable to a 15 pin 2 row connector.

# Connecting the Display

## ■ W2361V/W2361VG

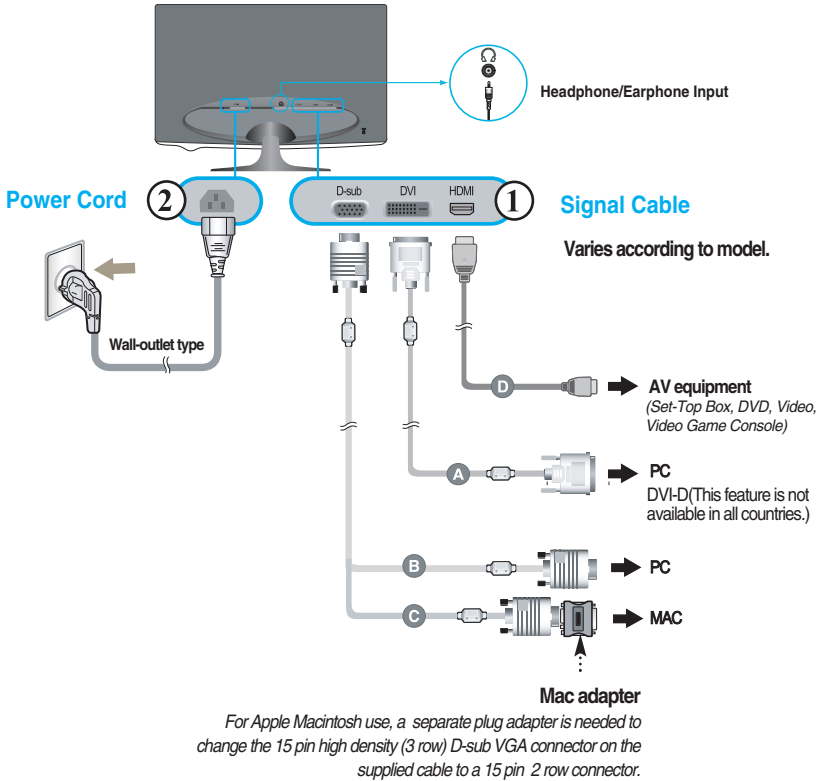

2. Touch the power button on the front of panel to turn the power on. When monitor power is turned on, the 'Self Image Setting Function' is executed automatically. (Only to the D-sub signal cable input)

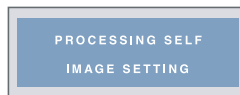
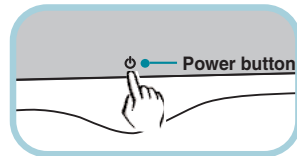

### NOTE



'Self Image Setting Function'? This function provides the user with optimal display settings. When the user connects the monitor for the first time, this function automatically adjusts the display to optimal settings for individual input signals.

'AUTO/SET Function'? When you encounter problems such as blurry screen, blurred letters, screen flicker or tilted screen while using the device or after changing screen resolution, touch the AUTO/SET function button to improve resolution.

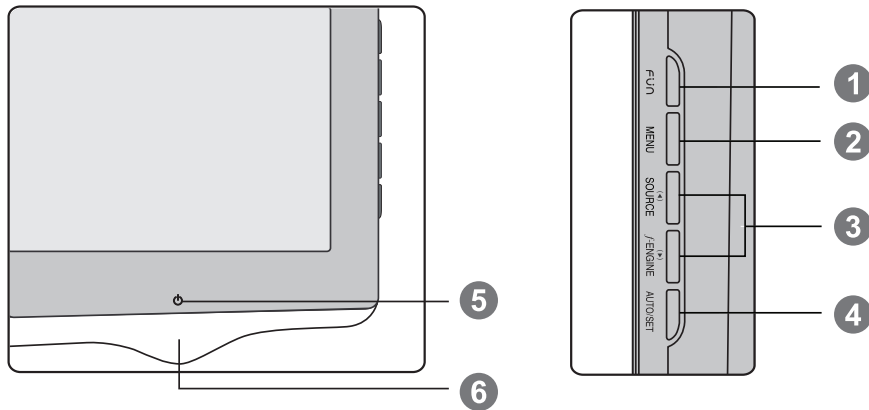

## Front Panel Controls



Control	Function
<b>1 FUN Button</b>	Use this button to enter <b>EZ ZOOMING, 4:3 IN WIDE, PHOTO EFFECT, CINEMA MODE, VOLUME, TIME CONTROL</b> items, for more information, refer to page A16-A17.
<b>2 MENU Button</b>	Use this button to enter or exit from the On Screen Display.
 	<b>OSD LOCKED/UNLOCKED</b> This function allows you to lock the current control settings, so that these settings are not inadvertently changed. To lock the OSD settings, press and hold the <b>MENU button</b> for several seconds. The message " <b>OSD LOCKED</b> " appears. You can unlock the OSD settings at any time by pushing the <b>MENU button</b> for several seconds. The message " <b>OSD UNLOCKED</b> " appears.

Control	Function
<p><b>3</b> ▲▼ <b>Buttons</b></p> <hr/> <p>▼ <b>Button</b> ( f·ENGINE )</p> <hr/> <p>▲ <b>Button</b> (SOURCE)</p>	<p>Use these buttons to select or adjust functions in the On Screen Display.</p> <hr/> <p>For more information, refer to page A18~A19.</p> <div data-bbox="493 331 714 437" data-label="Image"> </div> <hr/> <p>Use this button to make DSUB, DVI or HDMI connector active. This feature is used when two computers are connected to the display. *HDMI is optimized on the AV equipment.</p>
<p><b>4</b> <b>AUTO/SET Button</b></p> <div data-bbox="202 863 421 951" data-label="Image"> </div>	<p>Use this button to select an icon in the On Screen Display.</p> <hr/> <p><b>AUTO IMAGE ADJUSTMENT</b> When adjusting your display settings, always press the <b>AUTO/SET</b> button prior to entering the On Screen Display(OSD). This will automatically adjust your display image to the ideal settings for the current screen resolution size (display mode).</p> <p>The best display mode is: 1920 x 1080</p>
<p><b>5</b> <b>Power Button</b></p>	<p>Use this button to turn the display on or off. Operate key up to Red decoration area around button even back side.</p>
<p><b>6</b> <b>Power Indicator</b></p>	<p>This Indicator lights up as red when the display is operating normally(On Mode). If the display is in Sleep Mode (Energy Saving), this indicator color changes to flicker.</p>

## Screen Adjustment

**Making adjustments to the image size, position and operating parameters of the display is quick and easy with the On Screen Display Control system.**

**A short example is given below to familiarize you with the use of the controls. The following section is an outline of the available adjustments and selections you can make using the OSD.**

### NOTE

- Allow the display to stabilize for at least 30 minutes before making image adjustments.

To make adjustments in the On Screen Display, follow these steps:

**MENU → ▲▼ → AUTO/SET → ▲▼ → MENU**

- 1** Press the MENU Button, then the main menu of the OSD appears.
- 2** To access a control, use the ▲ or ▼ Buttons. When the icon you want becomes highlighted, press the AUTO/SET Button.
- 3** Use the ▲ / ▼ Buttons to adjust the image to the desired level. Use the AUTO/SET Button to select other sub-menu items.
- 4** Push the MENU Button once to return to the main menu to select another function. Push the MENU Button twice to exit from the OSD.

# On Screen Display(OSD) Selection and Adjustment

The following table indicates all the On Screen Display control, adjustment, and setting menus.

Main menu	Sub-menu	R	D	H	Reference	
<b>EZ ZOOMING</b>		●	●		To adjust the resolution	
<b>4:3 IN WIDE</b>		●	●	●	To adjust the image size	
<b>PHOTO EFFECT</b>	NORMAL	●	●		To adjust screen color mode	
	GAUSSIAN BLUR	●	●			
	SEPIA	●	●			
	MONOCHROME	●	●			
<b>CINEMA MODE</b>		●	●		To focus on the moving picture selected.	
<b>VOLUME</b>				●	To adjust the volume	
<b>TIME CONTROL</b>			●	●	To mind user using time.	
<b>PICTURE</b>	BRIGHTNESS	●	●	●	To adjust the brightness, contrast and gamma of the screen	
	CONTRAST	●	●	●		
	GAMMA	●	●	●		
	**BLACK LEVEL			●	To set offset level	
<b>COLOR</b>	PRESET	sRGB	●	●	●	To customize the color of the screen
		6500K	●	●	●	
		9300K	●	●	●	
	RED	●	●	●		
	GREEN	●	●	●		
BLUE	●	●	●			
<b>TRACKING</b>	HORIZONTAL	●			To adjust the position of the screen	
	VERTICAL	●				
	CLOCK	●			To improve the clarity and stability of the screen	
	PHASE	●				
	SHARPNESS	●	●	●		
<b>SETUP</b>	LANGUAGE	●	●	●	To customize the screen status for a user's operating environment	
	OSD POSITION	HORIZONTAL	●	●		●
		VERTICAL	●	●		●
	*WHITE BALANCE	●				
	**OVERSCAN			●		
	RTC	●	●	●		
	POWER INDICATOR	●	●	●		
FACTORY RESET	●	●	●			
<b>FLATRON F-ENGINE</b>	MOVIE	●	●	●	To select or customize desired image settings	
	*INTERNET	●	●			
	**GAME			●		
	USER	●	●	●		
	*NORMAL	●	●			
	**STANDARD			●		
	*DEMO	●	●			
**SPORTS			●			

● : Adjustable  
 \* : only for D-sub/DVI Input  
 \*\* : only for HDMI Input

R : DSUB Input  
 D : DVI Input  
 H : HDMI Input

## NOTE

- The order of icons may differ depending on the model (A11~A19).

# On Screen Display(OSD) Selection and Adjustment

You were introduced to the procedure of selecting and adjusting an item using the OSD system. Listed below are the icons, icon names, and icon descriptions of the all items shown on the Menu.

Press the MENU Button, then the main menu of the OSD appears.

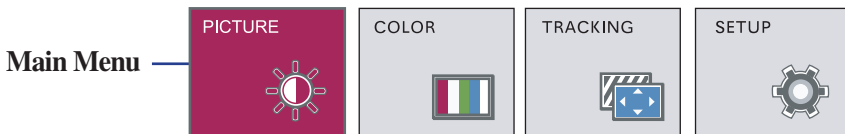

- MENU : Exit
- ▼ ▲ : Adjust (Decrease/Increase)
- SET : Enter
  - ▾ : Select another sub-menu
  - ↺ : Restart to select sub-menu

Button Tip

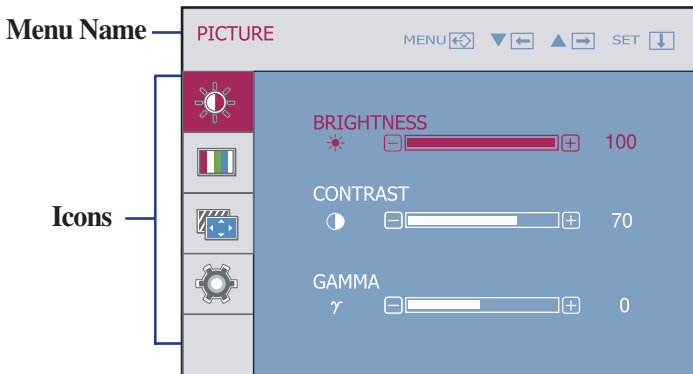

Menu Name

Icons

Sub-menus

## NOTE

- OSD (On Screen Display) menu languages on the monitor may differ from the manual.

Main menu	Sub menu	Description
-----------	----------	-------------



## PICTURE

DSUB/DVI input

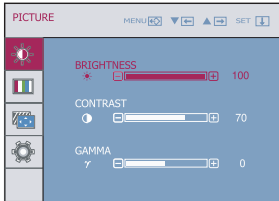

**BRIGHTNESS**

To adjust the brightness of the screen.

**CONTRAST**

To adjust the contrast of the screen.

**GAMMA**

Set your own gamma value. : -50/0/50  
On the monitor, high gamma values display whitish images and low gamma values display high contrast images.

HDMI input

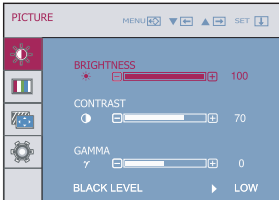

**BLACK LEVEL**

You can set the offset level. If you select 'HIGH', the screen will be bright and if you select 'LOW', the screen will be dark. (only for HDMI input)

\* **Offset?** As the criteria for video signal, it is the darkest screen the monitor can show.

- **MENU** : Exit
- ▼ : Decrease
- ▲ : Increase
- **SET** : Select another sub-menu



## COLOR

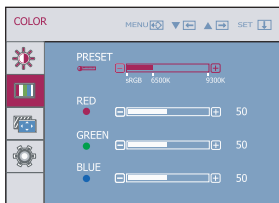

**PRESET**

- sRGB: Set the screen color to fit the sRGB standard color specification.
- 6500K: Slightly reddish white.
- 9300K: Slightly bluish white.

**RED**

Set your own red color levels.

**GREEN**



Set your own green color levels.

**BLUE**

Set your own blue color levels.

- **MENU** : Exit
- ▼ : Decrease
- ▲ : Increase
- **SET** : Select another sub-menu

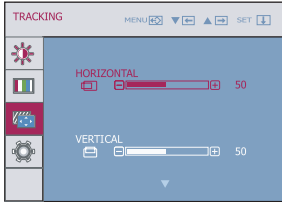
# On Screen Display(OSD) Selection and Adjustment

Main menu	Sub menu	Description
	<b>TRACKING</b>	
	<b>HORIZONTAL</b> <b>VERTICAL</b>	<b>HORIZONTAL</b> To move image left and right. <b>VERTICAL</b> To move image up and down.
	<b>CLOCK</b> <b>PHASE</b> <b>SHARPNESS</b>	<b>CLOCK</b> To minimize any vertical bars or stripes visible on the screen background. The horizontal screen size will also change. <b>PHASE</b> To adjust the focus of the display. This item allows you to remove any horizontal noise and clear or sharpen the image of characters.
<ul style="list-style-type: none"><li>■ <b>MENU</b> : Exit</li><li>■ <b>▼</b> : Decrease</li><li>■ <b>▲</b> : Increase</li><li>■ <b>SET</b> : Select another sub-menu</li></ul>	<b>SHARPNESS</b>	To adjust the clearness of the screen.

# On Screen Display(OSD) Selection and Adjustment

Main menu	Sub menu	Description
-----------	----------	-------------



## SETUP

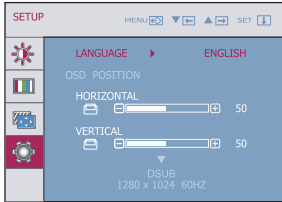

### DSUB/DVI input

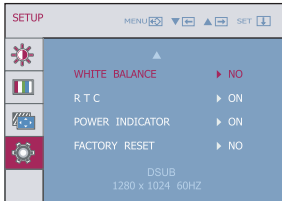

### HDMI input

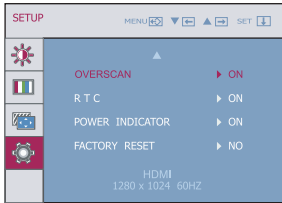

- MENU : Exit
- ▼ : Adjust
- ▲ : Adjust
- SET : Select another sub-menu

**LANGUAGE** To choose the language in which the control names are displayed.

**OSD POSITION** To adjust position of the OSD window on the screen.

**WHITE BALANCE** If the output of the video card is different the required specifications, the color level may deteriorate due to video signal distortion. Using this function, the signal level is adjusted to fit into the standard output level of the video card in order to provide the optimal image. Activate this function when white and black colors are present in the screen. (only for DSUB input)

**OVERSCAN** To select the range of output image for DTV timing in HDMI input. (only for HDMI input)  
Recommend **overscan** function to turn on when connect **AV** equipment.

**RTC** If you set **ON**, you enable the Response Time Control function.  
If you set **OFF**, you disable the Response Time Control function.

**POWER INDICATOR** Use this function to set the power indicator on the front side of the monitor to **ON** or **OFF**.  
If you set **OFF**, it will go off.  
If you set **ON** at any time, the power indicator will automatically be turned on.

**FACTORY RESET** Restore all factory default settings except "**LANGUAGE.**"  
Press the ▲, ▼ buttons to reset immediately.

If this does not improve the screen image, restore the factory default settings.  
If necessary, perform the white balance function again. This function will be enabled only when the input signal is an analog signal.



# On Screen Display(OSD) Selection and Adjustment

■ ■ ■ The OSD screen will appear when you touch the **FUN** button on the right bottom of the monitor.

DSUB/DVI input



HDMI input

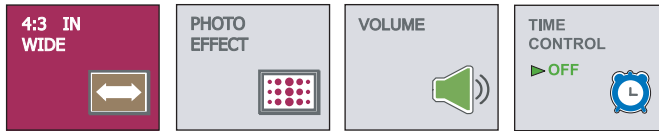

Main menu	Sub menu	Description
-----------	----------	-------------

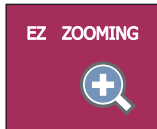

### EZ ZOOMING

EZ Zoom lowers the display's resolution in single-step increments. Depressing the button once lowers the resolution by one step; while a second button-press returns the resolution to the original display settings.

\*This function is operated only if the forteManager is installed to PC.

\*ForteManager is not supported in HDMI input.



### 4:3 IN WIDE

To select the image size of the screen.









WIDE

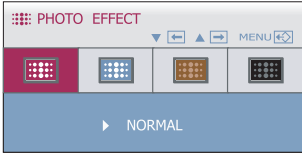

4:3

- **WIDE** : Switch to full screen mode according to input image signal.
- **4 : 3** : Change the image signal ratio into 4:3.

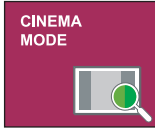
# On Screen Display(OSD) Selection and Adjustment

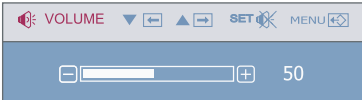
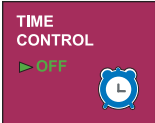
Main menu	Sub menu	Description
	<b>PHOTO EFFECT</b>	To select the color of the screen.  <ul style="list-style-type: none"><li>• <b>NORMAL :</b> The PhotoEffect function is disabled.</li><li>• <b>GAUSSIAN BLUR :</b> This option is to add the effect to the screen that the dark and sharp image becomes brighter and more blurred.</li><li>• <b>SEPIA :</b> This option changes the screen to be Sepia tone. The Sepia tone is brown color tone.</li><li>• <b>MONOCHROME :</b> This option changed the screen to be Gray tone. The screen image is displayed with just white, black, gray colors.</li></ul> <p>*Photo Effect feature may not work in HDMI Input. (Photo effect operate at DSUB format)</p>
	<b>NORMAL</b>	
	<b>GAUSSIAN BLUR</b>	
	<b>SEPIA</b>	
	<b>MONOCHROME</b>	
	<b>CINEMA MODE</b>	It focuses better on the moving picture in selected area. *This function is operated only if the fortmanager is installed to pc. (only for DSUB/DVI input)
	<b>VOLUME</b>	To adjust the volume of headphone/Earphone. (only for HDMI input) 
	<b>TIME CONTROL</b>	Remind user using time by showing alarm OSD and flickering power LED. Selection: <b>OFF/1HR/2HR</b>

# On Screen Display(OSD) Selection and Adjustment

- ■ ■ The OSD screen will appear when you touch the **f-ENGINE** button on the right bottom of the monitor.

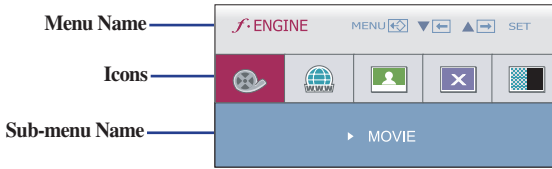

Main menu	Sub menu	Description
-----------	----------	-------------

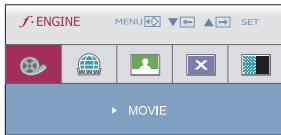

**MOVIE** Select this when you are watching a video or movie.

DSUB/DVI input

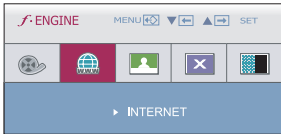

**INTERNET** Select this when you are working on the document (Word etc.)

HDMI input

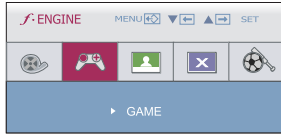

**GAME** Select this when you are playing a game.

DSUB/DVI input

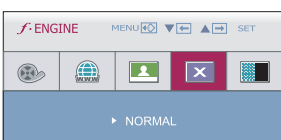

**NORMAL** Select this when you want to use the product in the most general using environment.

\* Normal mode is when f-ENGINE is turned off.

HDMI input

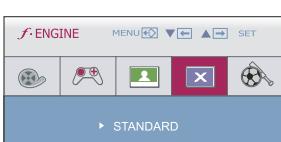

**STANDARD** Select this when you want to use the original standard video.

\* In the General (Standard) mode, the f-ENGINE is turned off.

# On Screen Display(OSD) Selection and Adjustment

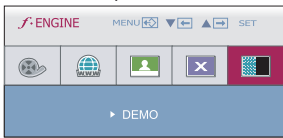
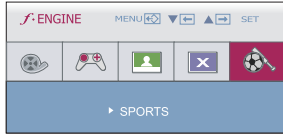
Main menu	Sub menu	Description
	<b>DEMO</b>	This is used for advertising in the store. The screen will be divided to show the standard mode on the left and video mode on the right so that the consumers can check the difference after applying the video mode.
	<b>SPORTS</b>	Select this when you watching general sports.

**USER**

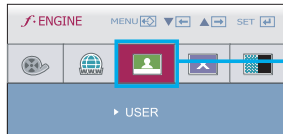

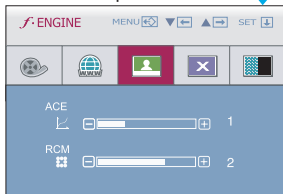

To adjust the USER sub-menu function, press the AUTO/SET Button.

DSUB/DVI input



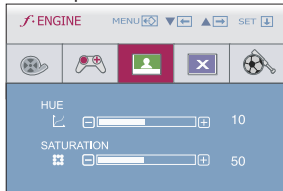

HDMI input



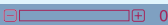

- **MENU** : Exit
-  : Decrease
-  : Increase
- **AUTO/SET** : Select another sub-menu

You can manually adjust **ACE** or **RCM**. (only for DSUB/DVI input), **HUE** or **SATURATION** (only for HDMI input). You can save or restore the adjusted value even when using a different environment.

... **ACE**(Adaptive Clarity Enhancer) : Selects the clarity mode.

	0	Not applied
	1	Weak clarity and luminosity contrast.
	2	Strong clarity and luminosity contrast.

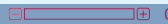
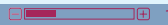
... **RCM**(Real Color Management) : Selects the color mode.

	0	Not applied
	1	Green enhance
	2	Flesh tone
	3	Color Enhance

... **HUE** : Adjust the screen hue.

... **SATURATION** : Adjust the screen saturation.

Check the following before calling for service.

No image appears	
<ul style="list-style-type: none"><li>● Is the power cord of the display connected?</li></ul>	<ul style="list-style-type: none"><li>• Check and see if the power cord is connected properly to the power outlet.</li></ul>
<ul style="list-style-type: none"><li>● Is the power indicator light on?</li></ul>	<ul style="list-style-type: none"><li>• Press the Power button.</li></ul>
<ul style="list-style-type: none"><li>● Is the power indicator flickering?</li></ul>	<ul style="list-style-type: none"><li>• If the display is in power saving mode, try moving the mouse or pressing any key on the keyboard to bring up the screen.</li><li>• Try to turn on the PC.</li></ul>
<ul style="list-style-type: none"><li>● Do you see an "OUT OF RANGE" message on the screen?</li></ul>	<ul style="list-style-type: none"><li>• This message appears when the signal from the PC (video card) is out of horizontal or vertical frequency range of the display. See the 'Specifications' section of this manual and configure your display again.</li></ul>
<ul style="list-style-type: none"><li>● Do you see a "CHECK SIGNAL CABLE" message on the screen?</li></ul>	<ul style="list-style-type: none"><li>• This message appears when the signal cable between your PC and your display is not connected. Check the signal cable and try again.</li></ul>

Do you see a "OSD LOCKED" message on the screen?	
<ul style="list-style-type: none"><li>● Do you see "OSD LOCKED" when you push MENU button?</li></ul>	<ul style="list-style-type: none"><li>• You can secure the current control settings, so that they cannot be inadvertently changed. You can unlock the OSD controls at any time by pushing the <b>MENU</b> button for several seconds: the message "OSD UNLOCKED" will appear.</li></ul>

## Display image is incorrect

- |   |  |
|---|--|
| <ul style="list-style-type: none"><li>● <b>Display Position is incorrect.</b></li></ul>   | <ul style="list-style-type: none"><li>● Press the <b>AUTO/SET</b> button to automatically adjust your display image to the ideal setting. If the results are unsatisfactory, adjust the image position using the <b>H position and V position</b> icon in the on screen display.</li></ul>   |
| <ul style="list-style-type: none"><li>● <b>On the screen background, vertical bars or stripes are visible.</b></li></ul>                      | <ul style="list-style-type: none"><li>● Press the <b>AUTO/SET</b> button to automatically adjust your display image to the ideal setting. If the results are unsatisfactory, decrease the vertical bars or stripes using the <b>CLOCK</b> icon in the on screen display.</li></ul>   |
| <ul style="list-style-type: none"><li>● <b>Any horizontal noise appearing in any image or characters are not clearly portrayed.</b></li></ul> | <ul style="list-style-type: none"><li>● Press the <b>AUTO/SET</b> button to automatically adjust your display image to the ideal setting. If the results are unsatisfactory, decrease the horizontal bars using the <b>PHASE</b> icon in the on screen display.</li><li>● Check <b>Control Panel --&gt; Display --&gt; Settings</b> and adjust the display to the recommended resolution or adjust the display image to the ideal setting. Set the color setting higher than 24 bits (true color).</li></ul> |

## Important

- Check **Control Panel --> Display --> Settings** and see if the frequency or the resolution were changed. If yes, readjust the video card to the recommend resolution.
- If the recommended resolution (optimal resolution) is not selected, letters may be blurred and the screen may be dimmed, truncated or biased. Make sure to select the recommend resolution.
- The setting method can differ by computer and O/S (Operation System), and resolution mentioned above may not be supported by the video card performance. In this case, please ask to the computer or the video card manufacturer.
- When HDMI interleaved signal (1920 x 1080i) input, static picture will be shaking, however moveable picture is not. So the recommend resolution is 1920 x 1080 @ 60Hz.

## Display image is incorrect

- |  |   |
|--|---|
| <ul style="list-style-type: none"><li>● <b>The screen color is mono or abnormal.</b></li></ul> | <ul style="list-style-type: none"><li>• Check if the signal cable is properly connected and use a screwdriver to fasten if necessary.</li><li>• Make sure the video card is properly inserted in the slot.</li><li>• Set the color setting higher than 24 bits (true color) at <b>Control Panel - Settings</b>.</li></ul> |
| <ul style="list-style-type: none"><li>● <b>The screen blinks.</b></li></ul>                    | <ul style="list-style-type: none"><li>• Check if the screen is set to interlace mode and if yes, change it to the recommend resolution.</li></ul>   |

## Have you installed the display driver?

- |  |   |
|--|---|
| <ul style="list-style-type: none"><li>● <b>Have you installed the display driver?</b></li></ul>  | <ul style="list-style-type: none"><li>• Be sure to install the display driver from the display driver CD (or diskette) that comes with your display. Or, you can also download the driver from our web site: <a href="http://www.lge.com">http://www.lge.com</a>.</li></ul> |
| <ul style="list-style-type: none"><li>● <b>Do you see an "Unrecognized monitor, Plug&amp;Play (VESA DDC) monitor found" message?</b></li></ul> | <ul style="list-style-type: none"><li>• Make sure to check if the video card supports Plug&amp;Play function.</li></ul>   |

<b>Display</b>	21.5 inches (54.6 cm) Flat Panel Active matrix-TFT LCD Anti-Glare coating Visible diagonal size: 54.6 cm 0.248*0.248 mm pixel pitch		
<b>Sync Input</b>	Horizontal Freq.	30 - 83 kHz (Automatic)	
	Vertical Freq.	Analog,Digital: 56 - 75 Hz (Automatic) HDMI: 56 - 61 Hz (Automatic)	
	Input Form	Separate TTL, Positive/Negative SOG (Sync On Green) Digital (HDCP)	
<b>Video Input</b>	Signal Input	15 pin D-Sub Connector DVI - D connector (Digital) 19 pin HDMI Connector	
	Input Form	Analog (0.7 Vp-p/ 75 ohm), Digital, HDMI	
<b>Resolution</b>	Max	Analog : VESA 1920 x 1080 @60 Hz Digital : VESA 1920 x 1080 @60 Hz	
	Recommend	VESA 1920 x 1080 @60 Hz	
<b>Plug&amp;Play</b>	DDC 2B (Digital, HDMI), DDC 2AB (Analog)		
<b>Power Consumption</b>	On Mode	: 39 W(Typ.)	
	Sleep Mode	≤ 1 W	
	Off Mode	≤ 1 W	
<b>Dimensions &amp;Weight</b>	With Stand		Without Stand
	Width	51.90 cm / 20.43 inches	51.90 cm / 20.43 inches
	Height	38.73 cm / 15.24 inches	33.08 cm / 13.02 inches
	Depth	19.32 cm / 7.61 inches	6.34 cm / 2.50 inches
	Net	4.2 kg (9.26 lbs)	
<b>Tilt Range</b>	Tilt	-5° ~17°	
<b>Power Input</b>	AC 100-240V~ 50/60Hz 1.0A		
<b>Environmental Conditions</b>	Operating Conditions		
	Temperature	10°C to 35 °C	
	Humidity	10 % to 80 % non-Condensing	
	Storage Conditions		
Temperature	-20°C to 60 °C		
Humidity	5 % to 90 % non-Condensing		
<b>Stand Base</b>	Attached( <input type="checkbox"/> ), Detached ( <input type="radio"/> )		
<b>Signal cable</b>	Attached( <input type="checkbox"/> ), Detached ( <input type="radio"/> )		
<b>Power cord</b>	Wall-outlet type		

**NOTE**

- Information in this document is subject to change without notice.



<b>Display</b>	21.5 inches (54.6 cm) Flat Panel Active matrix-TFT LCD Glare coating Visible diagonal size: 54.6 cm 0.248*0.248 mm pixel pitch		
<b>Sync Input</b>	Horizontal Freq.	30 - 83 kHz (Automatic)	
	Vertical Freq.	Analog,Digital: 56 - 75 Hz (Automatic) HDMI: 56 - 61 Hz (Automatic)	
	Input Form	Separate TTL, Positive/Negative SOG (Sync On Green) Digital (HDCP)	
<b>Video Input</b>	Signal Input	15 pin D-Sub Connector DVI - D connector (Digital) 19 pin HDMI Connector	
	Input Form	Analog (0.7 Vp-p/ 75 ohm), Digital, HDMI	
<b>Resolution</b>	Max	Analog : VESA 1920 x 1080 @60 Hz Digital : VESA 1920 x 1080 @60 Hz	
	Recommend	VESA 1920 x 1080 @60 Hz	
<b>Plug&amp;Play</b>	DDC 2B (Digital, HDMI), DDC 2AB (Analog)		
<b>Power Consumption</b>	On Mode	: 39 W(Typ.)	
	Sleep Mode	≤ 1 W	
	Off Mode	≤ 1 W	
<b>Dimensions &amp;Weight</b>		With Stand	Without Stand
	Width	51.90 cm / 20.43 inches	51.90 cm / 20.43 inches
	Height	38.73 cm / 15.24 inches	33.08 cm / 13.02 inches
	Depth	19.32 cm / 7.61 inches	6.34 cm / 2.50 inches
	Net	4.2 kg (9.26 lbs)	
<b>Tilt Range</b>	Tilt	-5°~17°	
<b>Power Input</b>	AC 100-240V~ 50/60Hz 1.0A		
<b>Environmental Conditions</b>	Operating Conditions		
	Temperature	10°C to 35 °C	
	Humidity	10 % to 80 % non-Condensing	
	Storage Conditions		
Temperature	-20°C to 60 °C		
Humidity	5 % to 90 % non-Condensing		
<b>Stand Base</b>	Attached( <input type="checkbox"/> ), Detached ( <input type="radio"/> )		
<b>Signal cable</b>	Attached( <input type="checkbox"/> ), Detached ( <input type="radio"/> )		
<b>Power cord</b>	Wall-outlet type		

**NOTE**

- Information in this document is subject to change without notice.

<b>Display</b>	23 inches (58.4 cm) Flat Panel Active matrix-TFT LCD Anti-Glare coating Visible diagonal size: 58.4 cm 0.266*0.266 mm pixel pitch		
<b>Sync Input</b>	Horizontal Freq.	30 - 83 kHz (Automatic)	
	Vertical Freq.	Analog,Digital: 56 - 75 Hz (Automatic) HDMI: 56 - 61 Hz (Automatic)	
	Input Form	Separate TTL, Positive/Negative SOG (Sync On Green) Digital (HDCP)	
<b>Video Input</b>	Signal Input	15 pin D-Sub Connector DVI - D connector (Digital) 19 pin HDMI Connector	
	Input Form	Analog (0.7 Vp-p/ 75 ohm), Digital, HDMI	
<b>Resolution</b>	Max	Analog : VESA 1920 x 1080 @60 Hz Digital : VESA 1920 x 1080 @60 Hz	
	Recommend	VESA 1920 x 1080 @60 Hz	
<b>Plug&amp;Play</b>	DDC 2B (Digital, HDMI), DDC 2AB (Analog)		
<b>Power Consumption</b>	On Mode	: 42 W(Typ.)	
	Sleep Mode	≤ 1 W	
	Off Mode	≤ 1 W	
<b>Dimensions &amp;Weight</b>		With Stand	Without Stand
	Width	55.69 cm / 21.93 inches	55.69 cm / 21.93 inches
	Height	40.76 cm / 16.05 inches	34.09 cm / 13.42 inches
	Depth	19.32 cm / 7.61 inches	6.78 cm / 2.67 inches
	Net	4.5 kg (9.56 lbs)	
<b>Tilt Range</b>	Tilt	-5° ~17°	
<b>Power Input</b>	AC 100-240V~ 50/60Hz 1.0A		
<b>Environmental Conditions</b>	Operating Conditions		
	Temperature	10°C to 35 °C	
	Humidity	10 % to 80 % non-Condensing	
	Storage Conditions		
	Temperature	-20°C to 60 °C	
	Humidity	5 % to 90 % non-Condensing	
<b>Stand Base</b>	Attached( <input type="checkbox"/> ), Detached ( <input type="radio"/> )		
<b>Signal cable</b>	Attached( <input type="checkbox"/> ), Detached ( <input type="radio"/> )		
<b>Power cord</b>	Wall-outlet type		

**NOTE**

- Information in this document is subject to change without notice.

<b>Display</b>	23 inches (58.4 cm) Flat Panel Active matrix-TFT LCD Glare coating Visible diagonal size: 58.4 cm 0.266*0.266 mm pixel pitch		
<b>Sync Input</b>	Horizontal Freq.	30 - 83 kHz (Automatic)	
	Vertical Freq.	Analog,Digital: 56 - 75 Hz (Automatic) HDMI: 56 - 61 Hz (Automatic)	
	Input Form	Separate TTL, Positive/Negative SOG (Sync On Green) Digital (HDCP)	
<b>Video Input</b>	Signal Input	15 pin D-Sub Connector DVI - D connector (Digital) 19 pin HDMI Connector	
	Input Form	Analog (0.7 Vp-p/ 75 ohm), Digital, HDMI	
<b>Resolution</b>	Max	Analog : VESA 1920 x 1080 @60 Hz Digital : VESA 1920 x 1080 @60 Hz	
	Recommend	VESA 1920 x 1080 @60 Hz	
<b>Plug&amp;Play</b>	DDC 2B (Digital, HDMI), DDC 2AB (Analog)		
<b>Power Consumption</b>	On Mode	: 42 W(Typ.)	
	Sleep Mode	≤ 1 W	
	Off Mode	≤ 1 W	
<b>Dimensions &amp;Weight</b>		With Stand	Without Stand
	Width	55.69 cm / 21.93 inches	55.69 cm / 21.93 inches
	Height	40.76 cm / 16.05 inches	34.09 cm / 13.42 inches
	Depth	19.32 cm / 7.61 inches	6.78 cm / 2.67 inches
	Net	4.5 kg (9.56 lbs)	
<b>Tilt Range</b>	Tilt	-5°~17°	
<b>Power Input</b>	AC 100-240V~ 50/60Hz 1.0A		
<b>Environmental Conditions</b>	Operating Conditions		
	Temperature	10°C to 35 °C	
	Humidity	10 % to 80 % non-Condensing	
	Storage Conditions		
Temperature	-20°C to 60 °C		
Humidity	5 % to 90 % non-Condensing		
<b>Stand Base</b>	Attached( <input type="checkbox"/> ), Detached ( <input type="radio"/> )		
<b>Signal cable</b>	Attached( <input type="checkbox"/> ), Detached ( <input type="radio"/> )		
<b>Power cord</b>	Wall-outlet type		

**NOTE**

- Information in this document is subject to change without notice.

## Preset Modes (Resolution)

### DSUB/DVI Timing

Display Modes (Resolution)		Horizontal Freq. (kHz)	Vertical Freq. (Hz)
1	720 x 400	31.468	70
2	640 x 480	31.469	60
3	640 x 480	37.500	75
4	800 x 600	37.879	60
5	800 x 600	46.875	75
6	1024 x 768	48.363	60
7	1024 x 768	60.123	75
8	1152 x 864	67.500	75
9	1280 x 1024	63.981	60
10	1280 x 1024	79.976	75
11	1680 x 1050	65.290	60
*12	1920 x 1080	67.500	60

\* Recommend Mode

### HDMI Timing

Display Modes (Resolution)		Horizontal Freq. (kHz)	Vertical Freq. (Hz)
1	480P	31.50	60
2	576P	31.25	50
3	720P	37.50	50
4	720P	45.00	60
5	1080i	28.12	50
6	1080i	33.75	60
7	1080P	56.25	50
8	1080P	67.50	60

## Indicator

MODE	LED Color
On Mode	Red
Sleep Mode	Flicker
Off Mode	Off

Digitally yours ■■■■■

