



## OWNER'S MANUAL

# 3D Blu-ray Disc™ Player with DVB-S2 Tuner

Please read this manual carefully before operating your set and retain it for future reference.

MODEL  
BDS590

P/NO : MFL65225402



# 1 Safety Information



**CAUTION:** TO REDUCE THE RISK OF ELECTRIC SHOCK DO NOT REMOVE COVER (OR BACK) NO USER-SERVICEABLE PARTS INSIDE REFER SERVICING TO QUALIFIED SERVICE PERSONNEL.



This lightning flash with arrowhead symbol within an equilateral triangle is intended to alert the user to the presence of uninsulated dangerous voltage within the product's enclosure that may be of sufficient magnitude to constitute a risk of electric shock to persons.



The exclamation point within an equilateral triangle is intended to alert the user to the presence of important operating and maintenance (servicing) instructions in the literature accompanying the product.

## Cautions and Warnings

**WARNING:** TO PREVENT FIRE OR ELECTRIC SHOCK HAZARD, DO NOT EXPOSE THIS PRODUCT TO RAIN OR MOISTURE.

**WARNING:** Do not install this equipment in a confined space such as a book case or similar unit.

**CAUTION:** Do not block any ventilation openings. Install in accordance with the manufacturer's instructions.

Slots and openings in the cabinet are provided for ventilation and to ensure reliable operation of the product and to protect it from over heating. The openings shall be never be blocked by placing the product on a bed, sofa, rug or other similar surface. This product shall not be placed in a built-in installation such as a bookcase or rack unless proper ventilation is provided or the manufacturer's instruction has been adhered to.

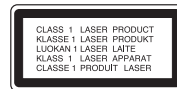

**CAUTION:** This product employs a Laser System. To ensure proper use of this product, please read this owner's manual carefully and retain it for future reference. Shall the unit require maintenance, contact an authorized service center. Use of controls, adjustments or the performance of procedures other than those specified herein may result in hazardous radiation exposure. To prevent direct exposure to laser beam, do not try to open the enclosure. Visible laser radiation when opened. DO NOT STARE INTO BEAM.

### CAUTION concerning the Power Cord

Most appliances recommend they be placed upon a dedicated circuit;

That is, a single outlet circuit which powers only that appliance and has no additional outlets or branch circuits. Check the specification page of this owner's manual to be certain. Do not overload wall outlets. Overloaded wall outlets, loose or damaged wall outlets, extension cords, frayed power cords, or damaged or cracked wire insulation are dangerous. Any of these conditions could result in electric shock or fire. Periodically examine the cord of your appliance, and if its appearance indicates damage or deterioration, unplug it, discontinue use of the appliance, and have the cord replaced with an exact replacement part by an authorized service center. Protect the power cord from physical or mechanical abuse, such as being twisted, kinked, pinched, closed in a door, or walked upon. Pay particular attention to plugs, wall outlets, and the point where the cord exits the appliance. To disconnect power from the mains, pull out the mains cord plug. When installing the product, ensure that the plug is easily accessible.

This device is equipped with a portable battery or accumulator.

**Safety way to remove the battery or the battery from the equipment:**

Remove the old battery or battery pack, follow the steps in reverse order than the assembly. To prevent contamination of the environment and bring on possible threat to human and animal health, the old battery or the battery put it in the appropriate container at designated collection points. Do not dispose of batteries or battery together with other waste. It is recommended that you use local, free reimbursement systems batteries and accumulators. The battery shall not be exposed to excessive heat such as sunshine, fire or the direct sun light.

**CAUTION:** The apparatus shall not be exposed to water (dripping or splashing) and no objects filled with liquids, such as vases, shall be placed on the apparatus.



For Wireless product  
European Union Notice

Products bearing the CE  
marking comply with

the R&TTE Directive (1999/5/EC), EMC Directive (2004/108/EC), and the Low Voltage Directive (2006/95/EC) issued by the Commission of the European Community. Indoor use only.

Compliance with these directives implies conformity to the following European Norms (in parentheses are the equivalent international standards and regulations):

- EN 55022 (CISPR 22)-Electromagnetic Interference
- EN 55024 (IEC61000-4-2,3,4,5,6,8,11)-Electromagnetic Immunity
- EN 60065 (IEC 60065) - Product Safety
- EN 300 328-Technical requirements for radio equipment
- 301 489-1 and EN 301 489-17-General EMC requirements for radio equipment.

European representative :

LG Electronics Service Europe B.V.  
Veluwezoom 15, 1327 AE Almere, The Netherlands  
(Tel : +31-036-547-8940)

### Disposal of your old appliance



1. When this crossed-out wheeled bin symbol is attached to a product it means the product is covered by the European Directive 2002/96/EC.
2. All electrical and electronic products should be disposed of separately from the municipal waste stream via designated collection facilities appointed by the government or the local authorities.
3. The correct disposal of your old appliance will help prevent potential negative consequences for the environment and human health.
4. For more detailed information about disposal of your old appliance, please contact your city office, waste disposal service or the shop where you purchased the product.

### Notes on Copyrights

- Recording equipment should be used only for lawful copying and you are advised to check carefully what is lawful copying in the area in which you are making a copy. Copying of copyright material such as films or music is unlawful unless permitted by a legal exception or consented to by the rights owner.
- This product incorporates copyright protection technology that is protected by U.S. patents and other intellectual property rights. Use of this copyright protection technology must be authorized by Rovi Corporation, and is intended for home and other limited viewing uses only unless otherwise authorized by Rovi Corporation. Reverse engineering or disassembly is prohibited.
- CONSUMERS SHOULD NOTE THAT NOT ALL HIGH DEFINITION TELEVISION SETS ARE FULLY COMPATIBLE WITH THIS PRODUCT AND MAY CAUSE ARTIFACTS TO BE DISPLAYED IN THE PICTURE. IN CASE OF 625 PROGRESSIVE SCAN PICTURE PROBLEMS, IT IS RECOMMENDED THAT THE USER SWITCH THE CONNECTION TO THE 'STANDARD DEFINITION' OUTPUT. IF THERE ARE QUESTIONS REGARDING OUR TV SET COMPATIBILITY WITH THIS MODEL 625p UNIT PLEASE CONTACT OUR CUSTOMER SERVICE CENTRE.

- Because AACS (Advanced Access Content System) is approved as content protection system for BD format, similar to use of CSS (Content Scramble System) for DVD format, certain restrictions are imposed on playback, analogue signal output, etc., of AACS protected contents. The operation of this product and restrictions on this product may vary depending on your time of purchase as those restrictions may be adopted and/or changed by AACS after the production of this product.
- Furthermore, BD-ROM Mark and BD+ are additionally used as content protection systems for BD format, which imposes certain restrictions including playback restrictions for BD-ROM Mark and/or BD+ protected contents. To obtain additional information on AACS, BD-ROM Mark, BD+, or this product, please contact an authorized Customer Service Centre.
- Many BD-ROM/DVD discs are encoded with copy protection. Because of this, you should only connect your player directly to your TV, not to a VCR. Connecting to a VCR results in a distorted picture from copy-protected discs.
- This product incorporates copyright protection technology that is protected by U.S. patents and other intellectual property rights. Use of this copyright protection technology must be authorized by Rovi Corporation, and is intended for home and other limited viewing uses only unless otherwise authorized by Rovi Corporation. Reverse engineering or disassembly is prohibited.
- Under the U.S. Copyright laws and Copyright laws of other countries, unauthorized recording, use, display, distribution, or revision of television programs, videotapes, BD-ROM discs, DVDs, CDs and other materials may subject you to civil and/or criminal liability.



# Contents

## 1 Safety Information

3 Cautions and Warnings

## 2 Preparation

8 **Introduction**

8 About the "⊘" Symbol Display

8 Symbols Used in this Manual

8 Supplied Accessories

9 Playable Discs

10 File compatibility

11 Regional Code

11 AVCHD (Advanced Video Codec High Definition)

11 System Requirements

11 Compatibility Notes

12 **Remote control**

13 **Main Unit**

## 3 Installation

14 **Connections to Your TV**

14 Terrestrial Antenna connection

14 Satellite Antenna connection

15 Satellite Setting

17 HDMI Connection

18 Component Video Connection

18 Composite connection

19 Scart connection

19 Resolution Setting

20 **Connecting to an Amplifier**

20 Connecting to an Amplifier via HDMI Output

21 Connecting to an Amplifier via Digital Audio Output

21 Connecting to an Amplifier via 2 Channel Audio Output

22 **Connecting to your Home Network**

22 Wired network connection

23 Wired Network Setup

24 Wireless Network Connection

24 Wireless Network Setup

27 **USB device connection**

30 **Auto Set UP**

31 **Home Menu Overview**

32 **Settings**

32 Adjust the Setup Settings

32 Settings for Digital TV

32 Scanning programmes automatically (Auto Tuning)

33 Scanning programmes manually (Manual Tuning)

33 Editing Programme List (Channel Edit)

34 Setting the DTV Lock

34 Adjusting DTV Rating

35 Setting the antenna power

35 [DTV] Menu

36 [DISPLAY] Menu

37 [LANGUAGE] Menu

38 [AUDIO] Menu

39 [LOCK] Menu

41 [NETWORK] Menu

41 [OTHERS] Menu

## 4

### Operation

---

- 43 Using the Digital TV functions
- 47 Recording TV programmes
- 49 General Playback
- 54 Advanced Playback
- 57 On-Screen display
- 61 Enjoying BD-LIVE
- 62 Playing movie file and VR discs
- 63 Viewing a photo
- 66 Listening to music
- 69 Playing content via your home network (Home Link)
- 73 Using the NetCast™ Entertainment Access
  - 74 Playing maxdome videos
  - 75 Playing YouTube™ videos
  - 78 Viewing Picasa™ Web Albums
- 81 Using the AccuWeather

## 5

### Maintenance

---

- 83 Notes on Discs
- 83 Handling the Unit

## 6

### Troubleshooting

---

- 84 General
- 85 Picture
- 85 Sound
- 86 Network
- 87 Recording

## 7

### Appendix

---

- 88 Controlling a TV with the Supplied Remote Control
  - 88 Setting up the remote to control your TV
- 89 Area Code List
- 90 Language code List
- 91 Trademarks and Licenses
- 93 Network Software Update
- 95 Audio Output Specifications
- 97 Video Output Resolution
- 98 Specifications
  - 98 General
  - 98 TV Recording
  - 98 Connectors
  - 98 System
- 99 Important Information Relating to Network Services
- 100 Open source software notice

1

2

3

4

5

6

7

# 2 Preparation

2

Preparation

## Introduction

### About the "⊘" Symbol Display

"⊘" may appear on your TV display during operation and indicates that the function explained in this owner's manual is not available on that specific media.

### Symbols Used in this Manual

**NOTE**

Indicates special notes and operating features.

**CAUTION**

Indicates caution for preventing possible damages from abuse.

A section whose title has one of the following symbols are applicable only to the disc represented by the symbol.

<b>BD</b>	BD-ROM disc
<b>DVD</b>	DVD-Video, DVD±R/RW in Video mode or VR mode and finalized
<b>AVCHD</b>	DVD±R/RW in AVCHD format
<b>ACD</b>	Audio CDs
<b>MOVIE</b>	Movie files contained in the Disc/USB
<b>MOVIE-N</b>	Movie files in the DLNA server or PC

<b>MUSIC</b>	Music files contained on a Disc/USB
<b>MUSIC-N</b>	Music files on a DLNA server or PC
<b>PHOTO</b>	Photo files contained on a DLNA server, PC or Disc
<b>REC</b>	Titles recorded via this unit (external HDD)

### Supplied Accessories

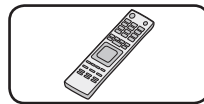

Remote control (1)

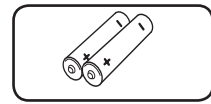

Batteries (2)



Nero MediaHome4 Essentials software CD-ROM (1)

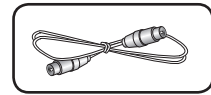

RF cable (1)



## Playable Discs



### Blu-ray Disc

- Discs such as movies that can be purchased or rented.
- BD-R/RE discs that contain Movie, Music or Photo files.



### DVD-VIDEO (8 cm / 12 cm disc)

- Discs such as movies that can be purchased or rented.



### DVD±R (8 cm / 12 cm disc)

- Video mode and finalized only
- Supports the dual layer disc also
- Finalized AVCHD format
- DVD±R discs that contain Movie, Music or Photo files.



### DVD-RW (8 cm / 12 cm disc)

- VR mode, Video mode and finalized only
- Finalized AVCHD format
- DVD-RW discs that contain Movie, Music or Photo files.



### DVD+RW (8 cm / 12 cm disc)

- Video mode and finalized only
- Finalized AVCHD format
- DVD+RW discs that contain Movie, Music or Photo files.



### Audio CD (8 cm / 12 cm disc)



### CD-R/RW (8 cm / 12 cm disc)

- CD-R/RW discs that contain audio titles, Movie, Music or Photo files.



## NOTE

- Depending on the conditions of the recording equipment or the CD-R/RW (or DVD-R/RW) disc itself, some CD-R/RW (or DVD±R/RW) discs cannot be played on the unit.
- Depending on the recording software & the finalization, some of recorded discs (CD-R/RW or DVD±R/RW) may not be playable.
- BD-R/RE, DVD±R/RW and CD-R/RW discs recorded using a personal computer or a DVD or CD Recorder may not play if the disc is damaged or dirty, or if there is dirt or condensation on the player's lens.
- If you record a disc using a personal computer, even if it is recorded in a compatible format, there are cases in which it may not play because of the settings of the application software used to create the disc. (Check with the software publisher for more detailed information.)
- This unit requires discs and recordings to meet certain technical standards in order to achieve optimal playback quality.
- Pre-recorded DVDs are automatically set to these standards. There are many different types of recordable disc formats (including CD-R containing MP3 or WMA files) and these require certain pre-existing conditions to ensure compatible playback.
- Hybrid disc have both BD-ROM and DVD (or CD) layers on one side. On such discs, BD-ROM layer will be only played back in this player.
- Customers should note that permission is required in order to download MP3 / WMA files and music from the Internet. Our company has no right to grant such permission. Permission should always be obtained from / guaranteed by the copyright owner.
- You have to set the disc format option to [Mastered] in order to make the discs compatible with the LG players when formatting rewritable discs. If you set the option to "Live System", the disc cannot be played on LG player. (Mastered/Live File System : Disc format system for windows Vista)

## File compatibility

### Overall

**Available File extensions:** ".jpg", ".jpeg", ".png", ".avi", ".divx", ".mpg", ".mpeg", ".mkv", ".mp4", ".mp3", ".wma", ".ts"

- There could be a variance on the available file extensions depending on DLNA server.
- The file name is limited to 180 characters.
- Depending on the size and number of the files, it may take several minutes to read the contents on the media.

**Maximum Files/Folder:** Less than 2000 (total number of files and folders)

**CD-R/RW, DVD±R/RW, BD-R/RE Format:** ISO 9660+JOLIET, UDF and UDF Bridge format

### MOVIE

**Available resolution:** 1920 x 1080 (W x H) pixels

**Playable subtitle:** SubRip (.srt / .txt), SAMI (.smi), SubStation Alpha (.ssa/.txt), MicroDVD (.sub/.txt), VobSub (.sub), SubViewer 1.0 (.sub), SubViewer 2.0 (.sub/.txt), DVD Subtitle System (.txt)

**Playable Codec format:** "DIVX3.xx", "DIVX4.xx", "DIVX5.xx", "XVID", "DIVX6.xx" (Standard playback only), H.264/MPEG-4 AVC, DIVX-HD, MPEG1 SS, MPEG2 PS, MPEG2 TS

**Playable Audio format:** "Dolby Digital", "DTS", "MP3", "WMA", "AAC", "AC3"

- Not all the WMA and AAC Audio formats are compatible with this unit.

**Sampling frequency:** within 32-48KHz (WMA), within 16-48KHz (MP3)

**Bit rate:** within 20-320Kbps (WMA), within 32-320Kbps (MP3)



### NOTE

- HD movie files contained on the CD or USB 1.0/1.1 may not be played properly. BD, DVD or USB 2.0 are recommended to play back HD movie files.
- This player supports H.264/MPEG-4 AVC profile Main, High at Level 4.1. For a file with higher level, there will be a warning message on the screen.
- This player does not support the file that are recorded with GMC\*<sup>1</sup> or Qpel\*<sup>2</sup>. Those are video encoding techniques in MPEG4 standard, like DivX or XVID.  
\*<sup>1</sup> GMC – Global Motion Compensation  
\*<sup>2</sup> Qpel – Quarter pixel
- HD movie files that need high performance playback could react slowly.
- The total playback time indicated on the screen may not be correct for .ts files.

### MUSIC

**Sampling frequency:** between 8 - 48KHz (WMA), within 11 - 48KHz (MP3), 44.1 and 48KHz (LPCM)

**Bit rate:** between 8 - 320kbps (WMA, MP3), 768Kbps and 1.536Mbps (LPCM)



### NOTE

- This unit cannot support the ID3 Tag embedded MP3 file.
- The total playback time indicated on the screen may not be correct for VBR files.

### PHOTO

#### Recommended size:

Less than 4,000 x 3,000 x 24 bit/pixel

Less than 3,000 x 3,000 x 32 bit/pixel

- Progressive and lossless compression photo image files are not supported.
- Depending on the size and number of the photo files, it may take several minutes to read the contents of the media.

## Regional Code

This unit has a regional code printed on the rear of the unit. This unit can play only BD-ROM or DVD discs labelled same as the rear of the unit or "ALL".

## AVCHD (Advanced Video Codec High Definition)

- This player can playback AVCHD format discs. These discs are normally recorded and used in camcorders.
- The AVCHD format is a high definition digital video camera format.
- The MPEG-4 AVC/H.264 format is capable of compressing images at higher efficiency than the conventional image compressing format.
- Some AVCHD discs use the "x.v.Color" format.
- This player can playback AVCHD discs using "x.v.Color" format.
- Some AVCHD format discs may not be played, depending on the recording condition.
- AVCHD format discs need to be finalized.
- "x.v.Color" offers a wider colour range than normal DVD camcorder discs.

## System Requirements

For high definition video playback:

- High definition display that has COMPONENT or HDMI input jacks.
- BD-ROM disc with high definition content.
- HDMI or HDCP capable DVI input on your display device is required for some content (as specified by disc authors).
- For up-conversion of standard definition DVD, a HDMI or HDCP capable DVI input on your display device is required for copy-protected content.

For Dolby® Digital Plus, Dolby TrueHD and DTS-HD multi-channel audio playback:

- An amplifier/receiver with a built-in (Dolby Digital, Dolby Digital Plus, Dolby TrueHD, DTS or DTS-HD) decoder.
- Main, centre, surround speakers and subwoofer as necessary for chosen format.

## Compatibility Notes

- Because BD-ROM is a new format, there can be issues regarding certain disc, digital connection and other compatibility issues. If you experience compatibility problems, please contact an authorized Customer Service Center.
- Viewing high-definition content and up-converting standard DVD content may require a HDMI-capable input or HDCP-capable DVI input on your display device.
- Some BD-ROM and DVD discs may restrict the use of some operation commands or features.
- Dolby TrueHD, Dolby Digital Plus and DTS-HD are supported with maximum 7.1 channels if you use HDMI connection as the audio output.
- You can use a USB device that is used to store some disc related information, including downloaded on-line content. The disc you are using will control how long this information is retained.
- While watching 3D contents, on-screen displayed may not be displayed properly. To display proper on-screen display, turn off 3D mode on TV.

**For CI+ CAM, It takes more than 3 minutes to authenticate at the first time. If you are using more 2 CI+ CAM, there could be a failure in authentication when you change CI+ CAM, (It is a normal operation). Please insert CAM again when the failure is occurred.**

# Remote control

2

Preparation



### Battery Installation

Remove the battery cover on the rear of the Remote Control, and insert two R03 (size AAA) batteries with + and - matched correctly.

• • • • • **1** • • • • •

**Power (⏻):** Switches the unit ON or OFF.

**MUTE (🔇):** Mutes the sound.

**OPEN/CLOSE (⏏):** Opens and closes the disc tray.

**0-9 numerical buttons:** Selects numbered options in a menu.

**CLEAR:** Removes a mark on the search menu or a number when setting the password.

**REPEAT:** Repeats a desired section or sequence.

**TV/RADIO:** Switches between TV and radio modes.

• • • • • **2** • • • • •

**⏪/⏩:** Goes to next or previous chapter/track/file.

**⏮/⏭:** Searches backward or forward.

**■:** Stops playback.

**▶:** Starts playback.

**⏸:** Pauses playback or recording.

• • • • • **3** • • • • •

**GUIDE:** Displays the EPG menu.

**PR (⏮/⏭):** Scans up or down through memorized programmes.

**REC. (●):** Starts recording.

**PR LIST:** Displays the Channel list.

**TIMER REC.:** Displays [Timer Recording] menu.

**HOME (🏠):** Accesses or removes the HOME menu.

**MUSIC ID (🎵):** When the player is connected to the network, it can provide information about the song played during movie playback..

**INFO/DISPLAY (📺):** Displays or exits On-Screen Display.

**⏮/⏭/</> (left/right/up/down):** Navigates on-screen displays.

**ENTER (⏏):** Acknowledges menu selection or displays the TV info.

**RETURN (↶):** Exits the menu or back to previous step.

**TITLE/POPUP:** Displays the DVD title menu or BD-ROM's popup menu, if available.

**DISC MENU/REC.LIST:** Accesses menu on a disc or switches between recording list menu.

• • • • • **4** • • • • •

**Coloured (R, G, Y, B) buttons:** Use to navigate BD-ROM menus. They are also used for [MOVIE], [PHOTO], [MUSIC], [Home Link] and [NetCast] menu.

**MARKER:** Marks any point during playback.

**SEARCH:** Displays or exits the search menu.

**ZOOM:** Displays or exits the [Zoom] menu.

**TEXT:** Switches between teletext mode and normal TV viewing.

**SUBTITLE:** Selects a subtitle language.

**EXIT:** Exits a menu or hides on-screen information.

**TV Control Buttons:** See page 88.

## Main Unit

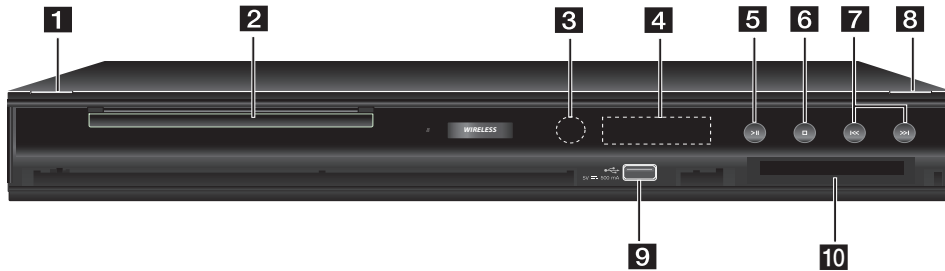

**1** ⏻ (Power)

**2** Disc Tray

**3** Remote Sensor

**4** Display window

**5** >|| (Play/Pause)

**6** □ (Stop)

**7** |<</>>| (Skip)

**8** ▲ (Open/Close)

**9** USB Port

**10** COMMON INTERFACE(CI or CI+) SLOT  
Slot for external Conditional Access (CA)-module and smart card used to decode scrambled channels. This device works with CI or CI+ CAM.

2  
Preparation

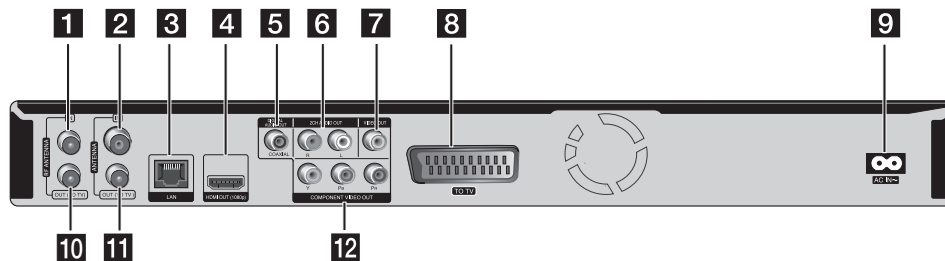

**1** RF ANTENNA IN

Connects a satellite antenna cable.

**2** ANTENNA IN

Connects a terrestrial antenna cable.

**3** LAN port

**4** HDMI OUT (1080p)

**5** DIGITAL AUDIO OUT (COAXIAL)

**6** 2CH AUDIO OUT (Left/Right)

**7** VIDEO OUT

**8** TO TV (SCART Jack)

**9** AC IN connector

Connects the supplied power cord.

**10** RF ANTENNA OUT (TO TV)

Connects another digital satellite receiver.

**11** ANTENNA OUT (TO TV)

**12** COMPONENT VIDEO OUT (Y Pb Pr)

# 3 Installation

## Connections to Your TV

3  
Installation

Make one of the following connections, depending on the capabilities of your existing equipment.

- Antenna connection (page 14)
- HDMI connection (page 17)
- Component Video connection (page 18)
- Composite connection (page 18)
- Scart connection (page 19)

### ! NOTE

- Depending on your TV and other equipment you wish to connect, there are various ways you could connect the unit. Use only one of the connections described in this manual.
- Please refer to the manuals of your TV, Stereo System or other devices as necessary to make the best connections.
- Make sure the player is connected directly to the TV. Tune the TV to the correct video input channel.
- Do not connect the player's AUDIO OUT jack to the phono in jack (record player) of your audio system.
- Do not connect your player via your VCR. The image could be distorted by the copy protection system.

### Terrestrial Antenna connection

Connect the Terrestrial TV antenna to the ANTENNA IN jack on the unit. Connect one end of the RF cable to ANTENNA OUT(TO TV) jack on the unit and other end to ANTENNA IN jack on your TV. Passes the signal from the ANTENNA IN jack to your TV/monitor. If you want to use an indoor antenna, use one with a signal amplifier rated at 5V, 100mA and set [Antenna 5V] to [ON] in the setup menu (See page 35).

### Satellite Antenna connection

Connect the Satellite antenna to the RF ANTENNA IN jack on the unit. Connect one end of the RF cable to RF ANTENNA OUT(TO TV) jack on the unit and other end to RF ANTENNA IN jack on your TV. Passes the signal from the RF ANTENNA IN jack to your TV/monitor.

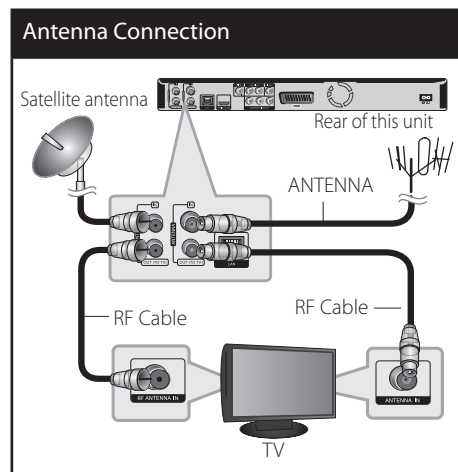

## Satellite Setting

Once you have completed setting the digital receiver to your individual preferences, you can proceed, if necessary, to adjust the unit settings to your antenna. The menu [Satellite Setting] contains the satellites that have been selected in the installation assistant. If the installation assistant was interrupted, the satellite position [Astra19.2E] is pre-programmed. Should you wish to receive other satellites, or if you are using a different type of LNB, you can adjust your digital receiver to the appropriate data as follows.

### Antenna Setting

1. Select [Satellite Setting] option in the [DTV] menu, then press ENTER (⊙).

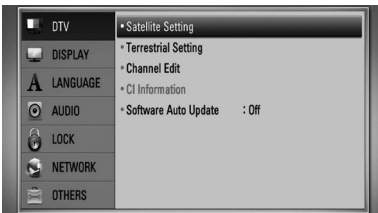

#### NOTE

If the [DTV Lock] option is set to [Lock], this function is available when you enter the password correctly. (page 34).

2. The [Satellite Setting] menu appear on the screen. Use  $\wedge/\vee$  to select the [Antenna Setting] and then press ENTER (⊙).



3. Use  $\lt;/\gt$  to select a desired particular satellite.

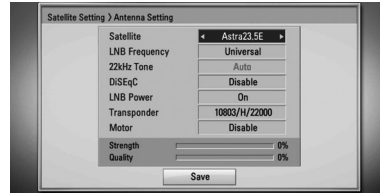

4. Select an item using  $\wedge/\vee$ . If you know the programmed [LNB Frequency], [22kHz Tone], [DiSEqC], [LNB Power], [Transponder] and [**Motor**], use  $\lt;/\gt$  to select the desired.

If you select [DiSEqC 1.2], you can set Motor Driving Mode, Motor Move and Set Limit, and if you select [USALS], you can set the longitude and latitude and use  $\vee$  to select [Go to position]; then motor will move to your selected satellite as calculating its position.

#### NOTE

If you use USALS, you should know lines of longitude and latitude at your location.

5. Use  $\wedge/\vee$  to select the [Save] and press ENTER (⊙) to display the [Saved List] menu.

#### NOTE

If there isn't LNB Frequency what you want in [LNB Frequency], input LNB Frequency with numerical buttons.

6. Use  $\wedge/\vee/\lt;/\gt$  to select the [Go To Tuning] and press ENTER (⊙).

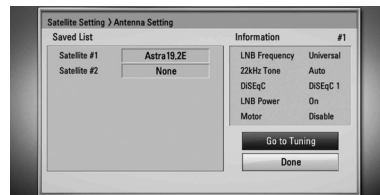

7. Select [Start] and press ENTER (⊙) to begin the channel search.

Use ▲/▼ to select a satellite check box and press ENTER (⊙) to select or deselect it.

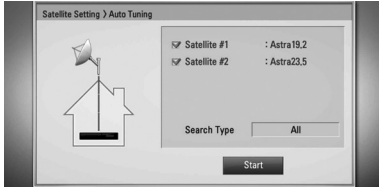

You can search **All**, **FREE**, **CAS** channels individually. Press ▲, you can select Search Type with </>.

**All** : All channels the satellite searches.

**FREE**: Free of charge channels.

**CAS(Conditional Access System)**: Pay channels.

Select [Stop] and press ENTER (⊙) to stop the channel search.

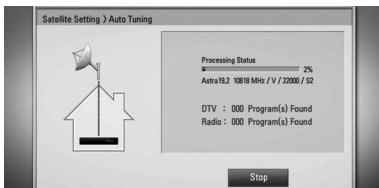

8. Press ENTER (⊙).

**NOTE**  
Please refer to the manuals of your TV, Stereo System or other devices as necessary to make the best connections.

### Auto Tuning

All available satellite TV or radio programmes are searched.

1. Use ▲/▼ to select the [Auto Tuning] and press ENTER (⊙).

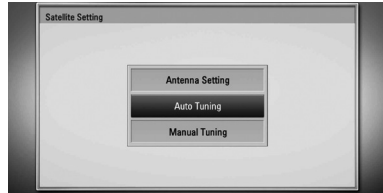

2. Follow the steps 7-8 from “Antenna Setting” on page 15-16.

### Manual Tuning

All available satellite TV or radio programmes are searched.

1. Use ▲/▼ to select the [Manual Tuning] and press ENTER (⊙).
2. Select an item using ▲/▼ and If you know the programmed [Satellite], [Frequency], [Polarization], [Symbol Rate], [Modulation], [Network Search] and [Search Type], use </> to select the desired, Fill the [Frequency] and [Symbol Rate] field using numerical buttons.

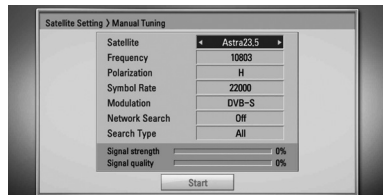

3. Select [Start] and press ENTER (⊙) to begin the channel search.  
Select [Stop] and press ENTER (⊙) to stop the channel search.
4. Press ENTER (⊙).

**NOTE**

- Select [Stop] and press ENTER (⊙) to stop the network search.
- If you set this option to [On], the unit will search available transponders through network.



## HDMI Connection

If you have a HDMI TV or monitor, you can connect it to this unit using a HDMI cable (Type A, Version 1.3). Connect the HDMI jack on the unit to the HDMI jack on a HDMI compatible TV or monitor.

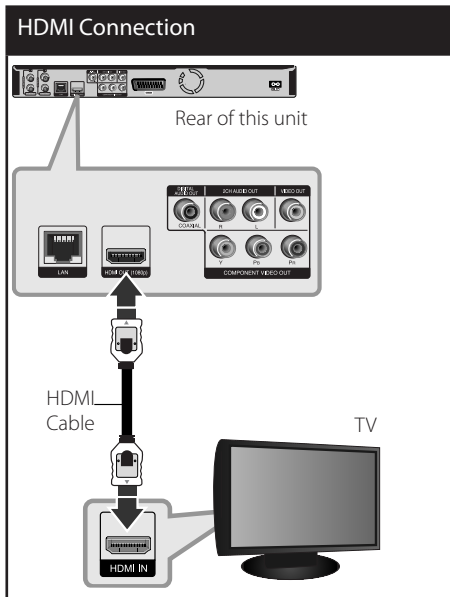

Set the TV's source to HDMI (refer to TV's Owner's manual).

### NOTE

- If a connected HDMI device does not accept the audio output of the unit, the HDMI device's audio sound may be distorted or may not output.
- When you use HDMI connection, you can change the resolution for the HDMI output. (Refer to "Resolution Setting" on page 19.)
- Select the type of video output from the HDMI OUT jack using [HDMI Color Setting] option on the [Setup] menu (see page 37).
- Changing the resolution when the connection has already been established may result in malfunctions. To solve the problem, turn off the player and then turn it on again.
- When the HDMI connection with HDCP is not verified, TV screen is changed to black screen. In this case, check the the HDMI connection, or disconnect the HDMI cable.
- If there is noise or lines on the screen, please check the HDMI cable (length is generally limited to 4.5m).

### Additional Information for HDMI

- When you connect a HDMI or DVI compatible device make sure of the following:
  - Try switching off the HDMI/DVI device and this player. Next, switch on the HDMI/DVI device and leave it for around 30 seconds, then switch on this player.
  - The connected device's video input is set correctly for this unit.
  - The connected device is compatible with 720x576p, 1280x720p, 1920x1080i or 1920x1080p video input.
- Not all HDCP-compatible HDMI or DVI devices will work with this player.
  - The picture will not be displayed properly with non-HDCP device.
  - This player does not playback and TV screen is changed to black screen.

### Component Video Connection

Connect the COMPONENT VIDEO OUT jacks on the unit to the corresponding input jacks on the TV using Y PB PR cables. Connect the left and right AUDIO OUT jacks of the unit to the audio left and right IN jacks on the TV using the audio cables.

3 Installation

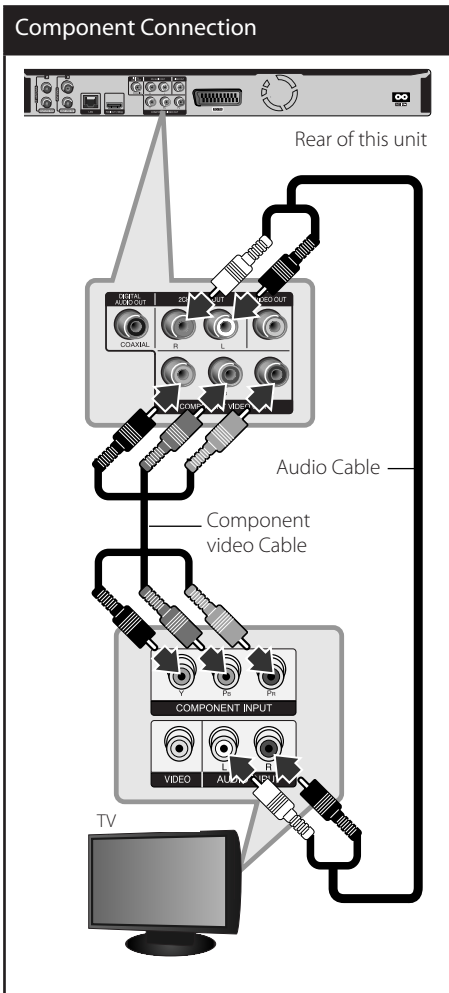

**NOTE**

When you use COMPONENT VIDEO OUT connection, you can change the resolution for the output. (Refer to "Resolution setting" on page 19.)

### Composite connection

Connect the VIDEO OUT jack on the Recorder to the video in jack on the TV using the video cable supplied. Connect the Left and Right AUDIO OUT jacks on the Recorder to the audio left/right in jacks on the TV using the supplied audio cables.

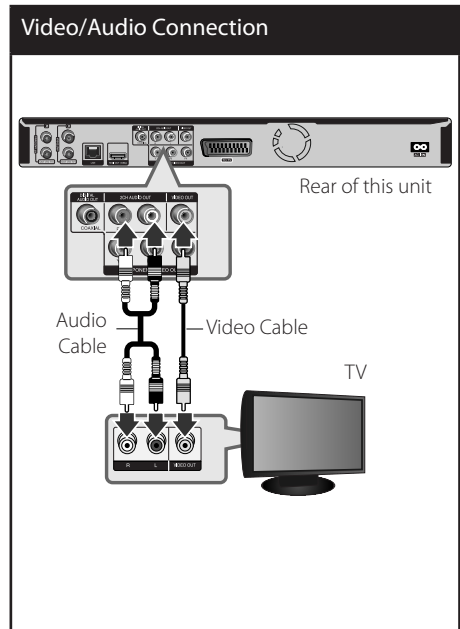

### Scart connection

Connect one end of the scart cable into the TO TV SCART jack on the unit and other end to the corresponding in jack on your TV. You can get Audio and Video signals together with this connection.

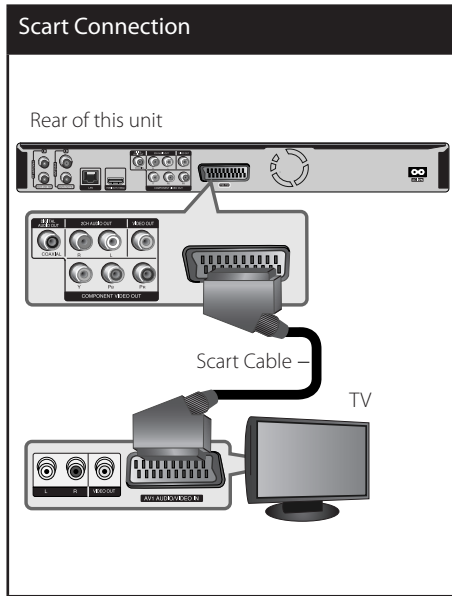

### Resolution Setting

The player provides several output resolutions for HDMI OUT and COMPONENT VIDEO OUT jacks. You can change the resolution using [Setup] menu.

1. Press HOME (🏠).
2. Use </> to select the [Setup] and press ENTER (⊙). The [Setup] menu appears.

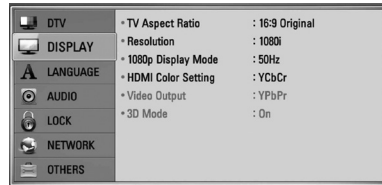

3. Use ^/v to select [DISPLAY] option then press > to move to the second level.

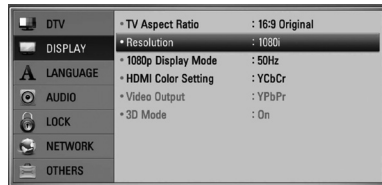

4. Use </> to select the [Resolution] option then press ENTER (⊙) to move to the third level.

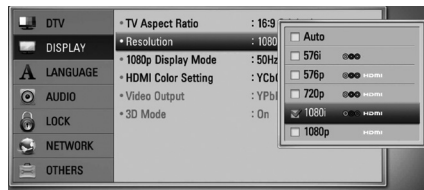

5. Use ^/v to select the desired resolution then press ENTER (⊙) to confirm your selection.

## Connecting to an Amplifier

Make one of the following connections, depending on the capabilities of your existing equipment.

- HDMI Audio connection (page 20)
- Digital Audio connection (page 20)
- 2CH Analogue Audio connection (page 21)

Since many factors affect the type of audio output, see "Audio Output Specifications" for details (pages 95-96).

### About Digital Multi-channel sound

A digital multi-channel connection provides the best sound quality. For this, you need a multi-channel Audio/Video Receiver that supports one or more of the audio formats supported by your unit. Check the receiver manual and the logos on the front of the receiver. (PCM Stereo, PCM Multi-Ch, Dolby Digital, Dolby Digital Plus, Dolby TrueHD, DTS and/or DTS-HD)

## Connecting to an Amplifier via HDMI Output

Connect the player's HDMI OUT jack to the corresponding jack on your amplifier using a HDMI cable. You will need to activate the player's digital output. (See "[AUDIO] Menu" on pages 38-39.)

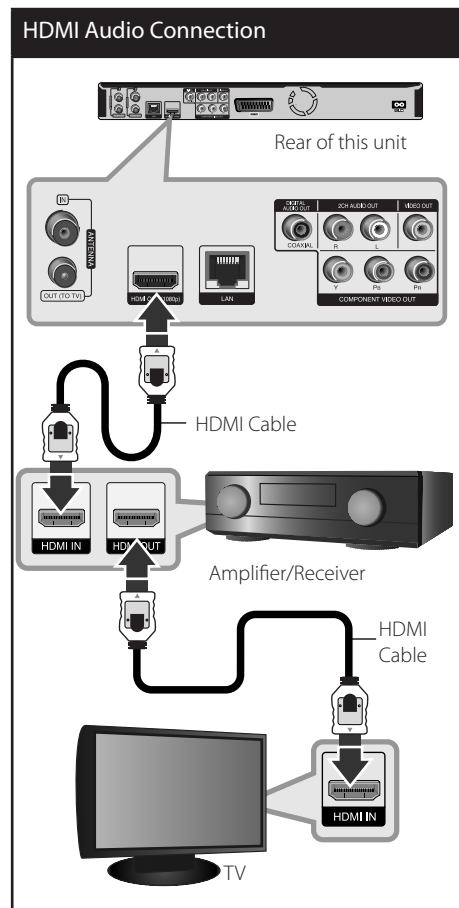

Connect the amplifier's HDMI output jack to HDMI input jack on your TV using a HDMI cable if your amplifier has HDMI output jack.

### Connecting to an Amplifier via Digital Audio Output

Connect the player's DIGITAL AUDIO OUT (COAXIAL) jack to the corresponding jack (COAXIAL) on your amplifier. Use an optional digital (coaxial) audio cable. You will need to activate the unit's digital output. (See "[AUDIO] Menu" on page 38-39.)

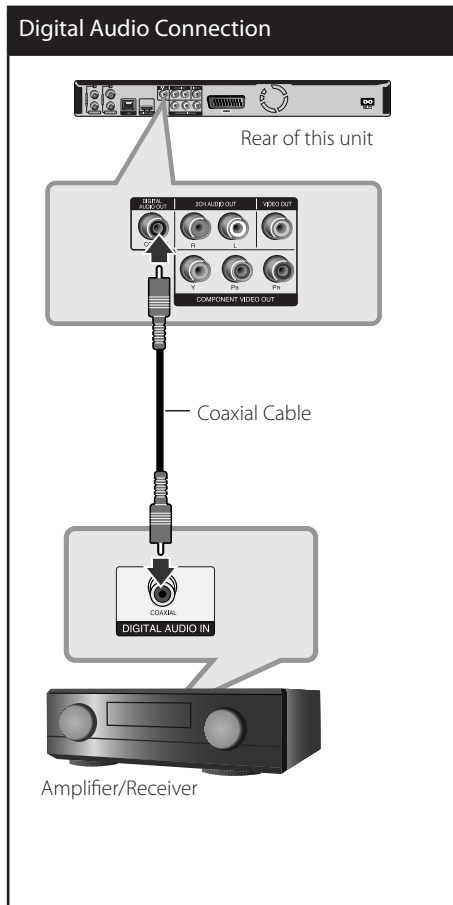

### Connecting to an Amplifier via 2 Channel Audio Output

Connect the Left and Right 2CH AUDIO OUT jacks on the unit to the audio left and right in jacks on your amplifier, receiver, or stereo system, using audio cables.

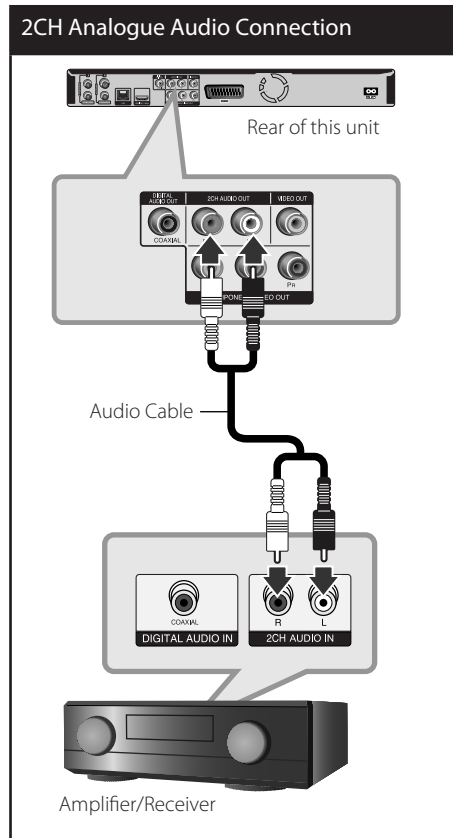

## Connecting to your Home Network

This unit can be connected to a local area network (LAN) via the LAN port on the rear panel or the internal wireless module. By connecting the unit to a broadband home network, you have access to services such as software updates, Home Link, BD-Live interactivity and streaming services.

### Wired network connection

Using a wired network provides the best performance, because the attached devices connect directly to the network and are not subject to radio frequency interference. Please refer to the documentation for your network device for further instructions. Connect the player's LAN port to the corresponding port on your Modem or Router using a commercially available LAN or Ethernet cable (CAT5 or better with RJ45 connector). In the example configuration for wired connection below, this player would be able to access content from either of the PCs.

#### NOTE

- When plugging or unplugging the LAN cable, hold the plug portion of the cable. When unplugging, do not pull on the LAN cable but unplug while pressing down on the lock.
- Do not connect a modular phone cable to the LAN port.
- Since there are various connection configurations, please follow the specifications of your telecommunication carrier or internet service provider.
- If you want to access content from PCs or DLNA servers, this unit must be connected to the same local area network with them via a router.

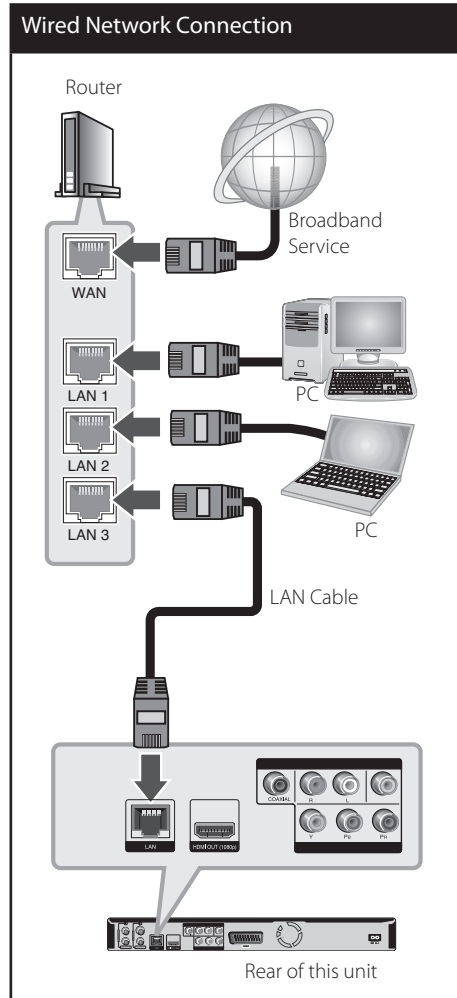

## Wired Network Setup

If there is a DHCP server on the local area network (LAN) via wired connection, this player will automatically be allocated an IP address. After making the physical connection, a small number of home networks may require the player's network setting to be adjusted. Adjust the [NETWORK] setting as follow.

### Preparation

Before setting the wired network, you need to connect the broadband internet to your home network.

1. Select [Connection Setting] option in the [Setup] menu then press ENTER (⊙).

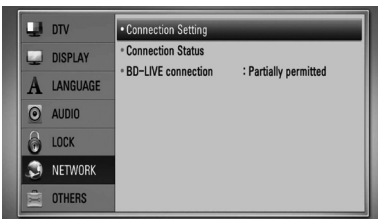

2. The [Connection Setting] menu will appear on the screen. Use  $\wedge/\vee$  to select the [Wired] and press ENTER (⊙).



3. Select [Yes] and press ENTER (⊙) to continue. The new connection settings reset the current network settings.
4. Use  $\wedge/\vee/</>$  to select the IP mode between [Dynamic] and [Static]. Normally, select [Dynamic] to allocate an IP address automatically.

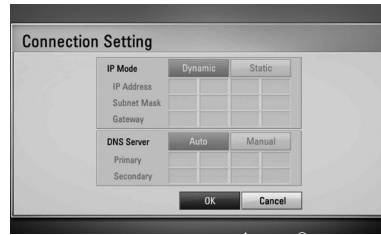

### NOTE

If there is no DHCP server on the network and you want to set the IP address manually, select [Static] then set [IP Address], [Subnet Mask], [Gateway] and [DNS Server] using  $\wedge/\vee/</>$  and numerical buttons. If you make a mistake while entering a number, press CLEAR to clear the highlighted part.

5. Select [OK] and press ENTER (⊙) to apply network settings.
6. The player will ask you to test the network connection. Select [OK] and press ENTER (⊙) to complete the network connection.
7. If you select [Test] and press ENTER (⊙) at step 5 above, the network connection status is displayed on the screen. You can also test it on the [Connection Status] in the [Setup] menu.

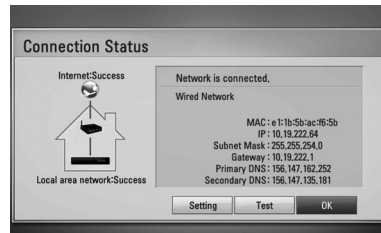

### Wireless Network Connection

Another connection option is to use an Access Point or a wireless router. In the example configuration for wireless connection below, this unit would be able to access content from either of the PCs.

The network configuration and connection method may vary depending on the equipment in use and the network environment.

This player is equipped with an IEEE 802.11n (2.4 GHz band only) wireless module, which also supports the 802.11b/g standards. For the best wireless performance, we recommend using a IEEE 802.11n certified Wi-Fi network (access point or wireless router).

Available WiFi standards:  
802.11b / 802.11g / 802.11n (single-band 2.4 GHz)

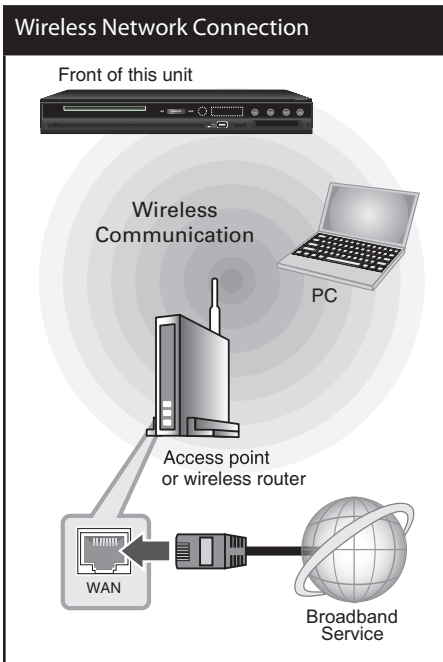

Refer to the setup instructions supplied with your access point or wireless router for detailed connection steps and network settings.

**NOTE**

Wired internet connection is strongly recommended. Using the [My Media] features, network update and video streaming services (such as YouTube Videos) with wireless network can be affected by household devices using radio frequencies.

### Wireless Network Setup

For the wireless network connection, the player needs to be set up for network communication. This adjustment can be done from the [Setup] menu. Adjust the [NETWORK] setting as follows. Setting up the access point or the wireless router is required before connecting the player to the network.

#### Preparation

Before setting the wireless network, you need to:

- connect the broadband internet to the wireless home network.
- set the access point or wireless router.
- note the SSID and security code of the network.

1. Select [Connection Setting] option in the [Setup] menu then press ENTER (Ⓞ).

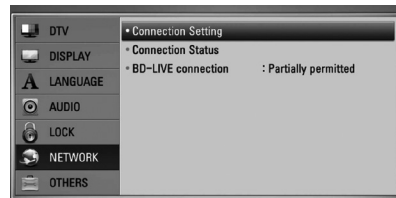



- The [Connection Setting] menu appears on the screen. Use  $\Delta/\nabla$  to select [Wireless] and press ENTER (⊙).



- Select [Yes] and press ENTER (⊙) to continue. The new connection settings reset the current network settings.



- The player scans all available access points or wireless routers within range and displays them as a list. Use  $\Delta/\nabla$  to select an access point or wireless router on the list, and then press ENTER (⊙).



If you have security on your access point or wireless router, verify that the WEP or WPA key that was entered into the player matches the router's information exactly. You need to input the security code as necessary.

**NOTE**

- WEP security mode generally have 4 keys available on an access point or wireless router's setting. If your access point or wireless router uses WEP security, enter the security code of the key "No.1" to connect to your home network.
- An Access Point is a device that allows you to connect to your home network wirelessly.

**[Manual]** – Your access point may not be broadcasting its access point name (SSID). Check your router settings through your computer and either set your router to broadcast SSID, or manually enter the access point name (SSID) in [Manual].

**[Push Button]** – If your access point or wireless router supports the Push Button Configuration method, select this option and press the Push Button on your access point or wireless router within 120 counts. You do not need to know the access point name (SSID) and security code of your access point or wireless router.

- Use  $\Delta/\nabla/</>$  to select the IP mode between [Dynamic] and [Static]. Normally, select [Dynamic] to allocate an IP address automatically.

**NOTE**

If there is no DHCP server on the network and you want to set the IP address manually, select [Static] then set [IP Address], [Subnet Mask], [Gateway] and [DNS Server] using  $\Delta/\nabla/</>$  and numerical buttons. If you make a mistake while entering a number, press CLEAR to clear the highlighted part.

- Select [OK] and press ENTER (⊙) to apply network settings.

7. The player will ask you to test the network connection. Select [OK] and press ENTER (⊙) to complete the network connection.
8. If you select [Test] and press ENTER (⊙) at step 7 above, the network connection status is displayed on the screen. You can also test it on the [Connection Status] in the [Setup] menu.

### Notes on Network Connection:

- Many network connection problems during set up can often be fixed by re-setting the router or modem. After connecting the player to the home network, quickly power off and/or disconnect the power cable of the home network router or cable modem. Then power on and/or connect the power cable again.
- Depending on the internet service provider (ISP), the number of devices that can receive internet service may be limited by the applicable terms of service. For details, contact your ISP.
- Our company is not responsible for any malfunction of the player and/or the internet connection feature due to communication errors/malfunctions associated with your broadband internet connection, or other connected equipment.
- The features of BD-ROM discs made available through the Internet Connection feature are not created or provided by our company, and our company is not responsible for their functionality or continued availability. Some disc related material available by the Internet Connection may not be compatible with this player. If you have questions about such content, please contact the producer of the disc.
- Some internet content may require a higher bandwidth connection.
- Even if the player is properly connect and configured, some internet content may not operate properly because of internet congestion, the quality or bandwidth of your internet service, or problems at the provider of the content.
- Some internet connection operations may not be possible due to certain restrictions set by the Internet service provider (ISP) supplying your broadband Internet connection.
- Any fees charged by an ISP including, without limitation, connection charges are your responsibility.
- A 10 Base-T or 100 Base-TX LAN port is required for wired connection to this player. If your internet service does not allow for such a connection, you will not be able to connect the player.
- You must use a Router to use xDSL service.
- A DSL modem is required to use DSL service and a cable modem is required to use cable modem service. Depending on the access method of and subscriber agreement with your ISP, you may not be able to use the internet connection feature contained in this player or you may be limited to the number of devices you can connect at the same time. (If your ISP limits subscription to one device, this player may not be allowed to connect when a PC is already connected.)
- The use of a "Router" may not be allowed or its usage may be limited depending on the policies and restrictions of your ISP. For details, contact your ISP directly.
- The wireless network operate at 2.4GHz radio frequencies that are also used by other household devices such as cordless telephone, *Bluetooth*® devices, microwave oven, and can be affected by interference from them.
- Turn off all unused network equipment in your local home network. Some devices may generate network traffic.

- For the purpose of the better reception place the player as close as possible to the access point.
- In some instances, placing the access point or wireless router at least 0.45 m above the floor may improve the reception.
- Move closer to the access point if possible or re-orient the player so there is nothing between it and the access point.
- The reception quality over wireless depends on many factors such as type of the access point, distance between the player and access point, and the location of the player.
- Set your access point or wireless router to Infrastructure mode. Ad-hoc mode is not supported.

## USB device connection

This unit can play movie, music and photo files contained on a USB device.

### Playback content in the USB device

1. Insert a USB device into the USB port until it fits into place.

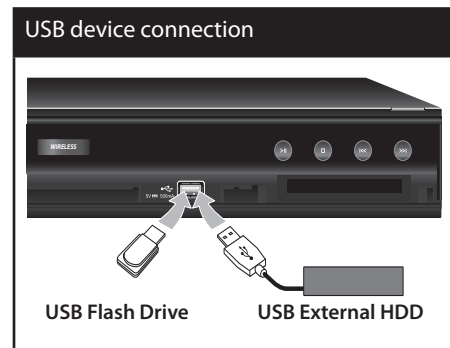

2. Press HOME (🏠).
3. Select [Movie], [Photo] or [Music] using </>, and press ENTER (⊙).

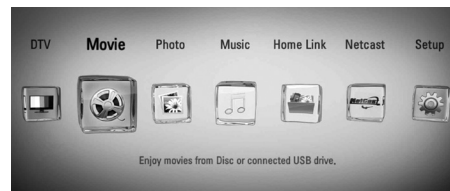

4. Select the [USB] option using </>, and press ENTER (⊙).

3

Installation

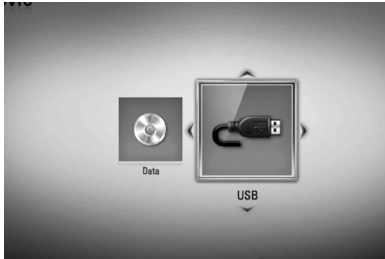

5. Select a file using  $\Delta$ / $\nabla$ / $\leftarrow$ / $\rightarrow$ , and press PLAY or ENTER (●) to play the file.



6. Withdraw the USB device carefully after exiting the USB mode.

## NOTE

- This unit supports USB flash memory/external HDD formatted in FAT16, FAT32 and NTFS when accessing files (music, photo, movie). The USB device can be used for local storage for enjoying BD-Live discs from the Internet.
- Please use the USB flash memory/external HDD formatted in either FAT16 or FAT32 when using BD-Live.
- This unit can support up to 4 partitions of the USB device.
- Do not extract the USB device during operation (play, recording, etc.).
- A USB device which requires additional programme installation when you have connected it to a computer, is not supported.
- USB device: USB device that supports USB1.1 and USB2.0.
- Regular back up is recommended to prevent data loss.
- If you use a USB extension cable or USB HUB, the USB device may not be recognized.
- Some USB device may not work with this unit.
- Digital camera and mobile phone are not supported.
- The USB Port on this unit cannot be connected to a PC. The unit cannot be used as a storage device.
- Unformatted media cannot be used. Please format before using.
- If USB HDD cannot be recognized, try another different USB cable.
- Some USB cables may not supply enough current for normal USB operation.
- It is recommended to use the USB device with one partition.
- Movie Files, Music files and photo files can be played. For details of operations on each file, refer to relevant pages.

## About the external hard disk drive

The hard disk drive (HDD) is a fragile piece of equipment. Please use the player following the guidelines below to protect against possible HDD failure.

- Do not move the player while it is on.
- Do not use the damaged HDD. Product can be damaged.
- Install and use a recorder on a stable, level surface.
- Do not use the recorder in excessively hot or humid places, or in places that may be subject to sudden changes in temperature. Sudden changes in temperature can cause condensation to form inside the recorder. This can be a cause of HDD failure.
- While the recorder is switched on, do not unplug from the wall socket or switch the electricity off from the breaker switch.
- Do not move the recorder immediately after switching it off. If you need to move the recorder, please follow the steps below:
  1. After the message "OFF" is shown in the display, wait at least two minutes.
  2. Unplug from the wall socket.
  3. Move the player.
- If there's a power failure while the recorder is on, there is a chance that some data on the HDD will be lost.
- The HDD is very delicate. If used improperly or in an unsuitable environment, it is possible that the HDD will fail after a few years of use. Signs of problems include playback unexpectedly freezing and noticeable block noise (mosaic) in the picture. However, sometimes there will be no warning signs of HDD failure.
- If the HDD fails, playback of recorded material will not be possible. In this case it will be necessary to replace the HDD.
- The manufacturer disclaims responsibility for loss of data contained in HDD.
- It is strongly recommended to use SATA standard HDD of makers as below for the HDD.  
(Seagate, Western Digital, Hitachi, Samsung)

- While operating this recorder, do not detach HDD. It may cause a serious defect to this recorder.
- Maximum capacity of HDD is limited to 1TB.
- The HDD capacity displayed on your TV screen may not exactly same with the capacity printed on your HDD.
- If is recommended to use external HDD with one partition.



### CAUTION

- HDD partition does not support more than four. If the partition is divided into four or more, it does not work.
- HDD partition divided with extended partition only, can be abnormal.
- During the recording, if you plug off USB external HDD by force, it can cause a serious problem on hard disk drive.
- If you separate the external HDD during the recording, The set does not shut down normally, It can be harmful to the HDD, Also you can not enjoy the recordings in the recording list.



### NOTE

- A recording features is only supported on first primary partition and it must be 4KB block NTFS format.
- 100GB or more of free space is recommended.
- Connection between the Set and an external hard disk must be connected directly. If you connect external hard disk and set with a separate USB HUB, In this case, It is not supported.
- If you edit or delete contents recorded on an external HDD from another PC, It can be deleted but cannot be played in Recordings list.
- External HDD supported USB 2.0
- HDD using a separate external power supply should be connected to power.
- A recording feature needs system folder that is named "REC", and it is unable to browse by user.

## Auto Set UP

You can reset the recorder to all its factory settings. Some options cannot be reset (Rating and Password). The [Factory Set] menu appears on the screen after the factory settings.

### Step 1. Language Setting

1. Use  $\wedge/V/</>$  to select a language for the on-screen display, and press ENTER (⊙).



### Step 2. Channel Setting

1. Use  $\wedge/V/</>$  to select a country, and press ENTER (⊙).



2. Input the new password using numerical buttons. Enter it again to verify.
3. Use  $\wedge/V$  to select the [Satellite], [Terrestrial] or [All] and press ENTER (⊙).



If you want to set the additional satellite setting, select [Detail Setting] on the menu. You can set the satellite option, also add the satellites that you want to search.

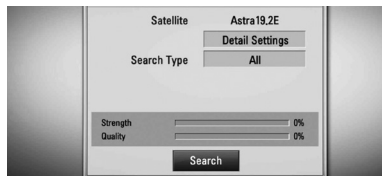

### Detail Setting

Refer to Step 3-5 of "Satellite Setting" on page 15.

### [Search type]

Refer to Step 7 of "Satellite Setting" on page 16.

4. While the Start option is selected, and press ENTER (⊙) to begin the channel search.



The recorder automatically searches for and saves the programmes.

If you select [Stop], the [Channel Setting] function will be skipped.

5. Press ENTER (⊙).

### Step 3. Time Setting

1. Use </> to select an option among [Manual] or [Auto], and press ENTER (⊙).

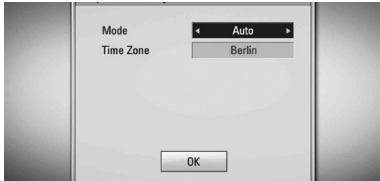

**Auto:** Set the programme that broadcasts a clock signal and the clock will be set automatically.

If the time that has automatically set is not correct comparing your local time, you can set additional time option.

**Manual:** If there is no channel that broadcasts a clock signal in your area, you can set the time and date manually. Use ^/ v to select each field, and input correct time and date using </>. You can use numerical buttons to change the setting.

2. Press ENTER (⊙) to complete the Time setting.

### Step 4. Network Setting

1. Refer to “Wired network connection” on page 22-23 to complete the [Wired] setup option, and press ENTER (⊙).

Select [No] and press ENTER (⊙) to cancel.

2. Refer to “Wireless network connection” on page 24-26 to complete the [Wireless] option, and press ENTER (⊙).

Select [Cancel] and press ENTER (⊙) to cancel. This recorder can apply only one network setup between [Wired] and [Wireless]. If you already set the [Wired] at step 6, you do not need to set [Wireless] setting.

## Home Menu Overview

To access numerous functions of the unit, press HOME on the remote.

### Basic button operations

HOME: Accesses or removes the Home Menu.  
 ^/v/</> : Used to navigate on-screen displays.  
 ENTER (⊙): Acknowledges menu selection.  
 RETURN: Exits the menu.

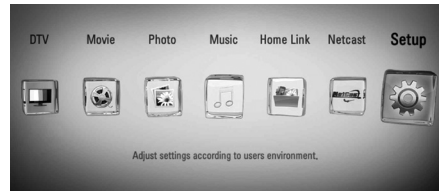

#### DTV

You can watch digital broadcasts. (page 43-49)

#### Movie

Starts video media's playback or displays the [MOVIE] menu.

#### Photo

Displays [PHOTO] menu. (page 63-65)

#### Music

Displays [MUSIC] menu. (page 66-68)

#### Home Link

Displays and play the shared contents from the selected server or PC. (page 69-73)

#### Netcast

Shows maxdome videos, YouTube videos, Picasa Web Albums and Accu Weather streamed from the Youtube server via the internet to your TV. (page 73-82)

#### Setup

Displays [Setup] menu. (page 32-42)

# Settings

## Adjust the Setup Settings

You can change the settings of the player in the [Setup] menu.

1. Press HOME (🏠).

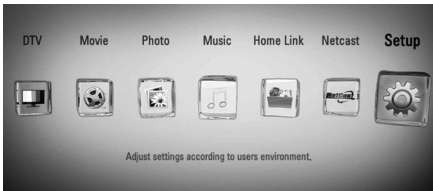

2. Use </> to select [Setup] and press ENTER (⊙). The [Setup] menu appears.

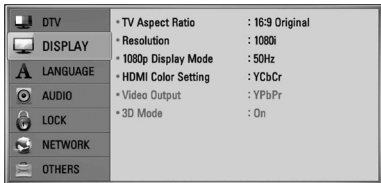

3. Use ^/V to select the first setup option, and press > to move to the second level.

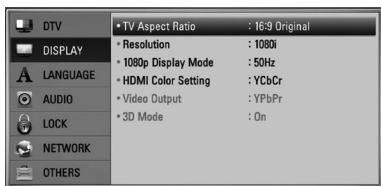

4. Use ^/V to select a second setup option, and press ENTER (⊙) or > to move to the third level.

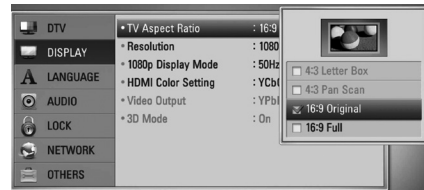

5. Use ^/V to select a desired setting, and press ENTER (⊙) or > to confirm your selection.

## Settings for Digital TV

To use DTV functions, this recorder needs some settings in advance.

## Scanning programmes automatically (Auto Tuning)

All available digital TV or radio programmes are searched for and stored automatically based on the selected country.

1. Press HOME.
2. Use </> to select [Setup], and press ENTER (⊙).
3. Use ^/V to select [DTV], and press ENTER (⊙).
4. Use ^/V to select [Terrestrial Setting], and press ENTER (⊙).
5. Use ^/V to select the [Auto Tuning] and press ENTER (⊙).

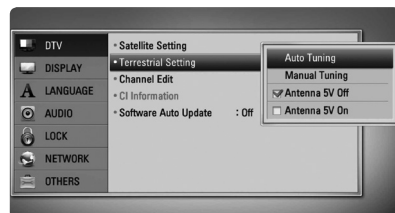



6. Use  $\leftarrow$  to select a country option and then use  $\rightarrow$  to select your country. Then press ENTER (⊙).
7. Use  $\downarrow$  to select [Start], and press ENTER (⊙) to begin the channel search.

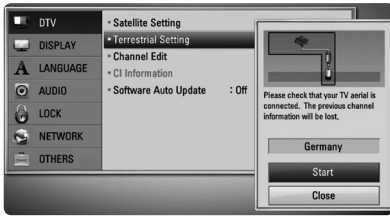

Select [Stop] and press ENTER (⊙) to stop the scanning programmes.

**NOTE**

If the [DTV Lock] option is set to [Lock], this function is available when you enter the password correctly. (see page 34.)

5. Use  $\leftarrow$ / $\rightarrow$  to select the desired multiplexer (MUX), and the unit starts scanning automatically.
6. Use  $\downarrow$  to select the [Add] and press ENTER (⊙) to add the programme the unit scans automatically.

**NOTE**

If the [DTV Lock] option is set to [Lock], this function is available when you enter the password correctly. (see page 34.)

### Editing Programme List (Channel Edit)

You can remove any digital TV or radio stored on this recorder using the [Channel Edit] menu.

1. Display [Setup] menu.
2. Use  $\wedge$ / $\vee$  to select [DTV], and press ENTER (⊙).
3. Use  $\wedge$ / $\vee$ / $\leftarrow$ / $\rightarrow$  to select [Channel Edit] and press ENTER (⊙).
4. Press  $\wedge$  to select [DTV], and use  $\leftarrow$ / $\rightarrow$  to select [DTV] or [Radio] programme list.



5. Use  $\wedge$ / $\vee$ / $\leftarrow$ / $\rightarrow$  to select a programme you want to skip from the list, and press red coloured (R) button.

If you do not want to skip the programme, select the programme and press red coloured (R) button again.

Use  $\wedge$ / $\vee$ / $\leftarrow$ / $\rightarrow$  to select a programme you want to lock from the list, and press blue coloured (B) button.

### Scanning programmes manually (Manual Tuning)

Scans digital TV or radio programmes and adds the found programmes to the programme list.

1. Display [Setup] menu.
2. Use  $\wedge$ / $\vee$  to select [DTV], and press ENTER (⊙).
3. Use  $\wedge$ / $\vee$  to select [Terrestrial Setting], and press ENTER (⊙).
4. Use  $\wedge$ / $\vee$  to select [Manual Tuning] and press ENTER (⊙) to display the [Manual Tuning] menu.



if you do not want to lock the programme, select the programme and press blue coloured (B) button again.

- Press RETURN to return to the previous step.

**skip** : if the programme is assigned to skip, you can't select that programme with PR button in Remote control.

**Block/unblock** : if the programme is assigned to block and [DTV Lock] in the [Setup] menu is set to [Lock], you should enter the password to watch the programme.

## 3

## Installation

## Setting the DTV Lock

Allows you to activate or deactivate all of the lock schemes previously set. When the [DTV Lock] is set to [Unlock].

- Display [Setup] menu.
- Use  $\Delta/V/\leftarrow/\rightarrow$  to select [LOCK] and press ENTER (⊙).
- Use  $\Delta/V$  to select [DTV Lock] and press ENTER (⊙).
- Input the password using numerical buttons.  
If you have not set your password yet, input "1234" and press ENTER (⊙).
- Use  $\Delta/V$  to select [Lock] and press ENTER (⊙) to activate the DTV Lock.

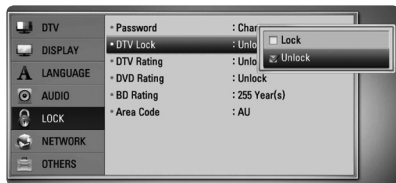

## Adjusting DTV Rating

Viewing of some digital TV programmes can be limited according to the age limit you set.

- Display [Setup] menu.
- Use  $\Delta/V$  to select [LOCK] and press ENTER (⊙).
- Use  $\Delta/V$  to select [DTV Rating] and press ENTER (⊙).
- Input the password using numerical buttons.  
If you have not set your password yet, input and press ENTER (⊙).

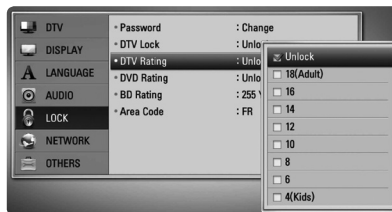

- Use  $\Delta/V$  to set the limitation level and press ENTER (⊙).

### Unlock

You can view all programs.

### 4 (Kids) - 18 (Adult)

Rating [4 (Kids)] has the most restrictions and [18 (Adult)] is the least restrictive.

## Setting the antenna power

If you are using indoor antenna with a signal amplifier rated at DC 5V, 100mA, the recorder can supply power through ANTENNA IN jack.

1. Display [Setup] menu.
2. Use  $\wedge/\vee$  to select the [DTV], and press ENTER (⊙).
3. Use  $\wedge/\vee$  to select the [Terrestrial Setting], and press ENTER (⊙).
4. Use  $\wedge/\vee$  to select the [Antenna 5V On] and press ENTER (⊙) to supply antenna power.



### NOTE

The [Terrestrial Setting] option must be set to [Antenna 5V Off] when your indoor antenna is supplied the power from the mains. If you set the [Terrestrial Setting] option to [Antenna 5V On] for the indoor antenna which is supplied power from the mains, it may cause serious defect to this unit.



## [DTV] Menu

### Satellite Setting

Once you have completed setting the digital receiver to your individual preferences, you can proceed, if necessary, to adjust the unit settings to your antenna. Refer to page 15-16 for more information.

### Terrestrial Setting

#### [Auto Tuning]

This option scans a programme and sets the available programmes. Refer to page 32-33 for more information.

#### [Manual Tuning]

Scans digital TV or radio programmes and adds the found programmes to the programme list. Refer to page 33 for more information.

#### [Antenna 5V Off/On]

If you are using an indoor antenna, use one with a signal amplifier rated at DC 5V, 100mA and set this option to [Antenna 5V On]. Refer to page 35 for more information.

### Channel Edit

This option allows you to edit the TV or Radio programmes. Refer to page 33 for more information.

### CI Information

You can enjoy not only scramble services using the Conditional Access Module (CAM), but also Free-To-Air services. Different CAM supports different encryption system. Contact your service provider or distributor to obtain the right kind of CAM. Only Free-To-Air services are available without CAM. This option displays a menu of CI card functions. Consult your service provider for more information on the functions available. You must obtain a "CI or CI+ CAM" from your service provider.

### Software Auto Update

If you set this option to [On], the unit updates a newer software automatically through the built-in digital tuner. If the software update is available from the broadcaster.



## [DISPLAY] Menu

### TV Aspect Ratio

Select a TV aspect ratio option according to your TV type.

---

#### [4:3 Letter Box]

Select when a standard 4:3 TV is connected. Displays theatrical images with masking bars above and below the picture.

---

#### [4:3 Pan Scan]

Select when a standard 4:3 TV is connected. Displays pictures cropped to fill your TV screen. Both sides of the picture are cut off.

---

#### [16:9 Original]

Select when a 16:9 wide TV is connected. The 4:3 picture is displayed with an original 4:3 aspect ratio, with black bars appearing at the left and right sides.

---

#### [16:9 Full]

Select when a 16:9 wide TV is connected. The 4:3 picture is adjusted horizontally (in a linear proportion) to fill the entire screen.

---



### NOTE

You cannot select [4:3 Letter Box] and [4:3 Pan Scan] option when the resolution is set to higher than 720p.

### Resolution

Sets the output resolution of the Component and HDMI video signal. Refer to page 19 and 97 for details about the resolution setting.

---

#### [Auto]

If the HDMI OUT jack is connected to TVs providing display information (EDID), this automatically selects the resolution best suited to the connected TV. If the COMPONENT VIDEO OUT only is connected, this changes the resolution to 1080i as default resolution.

---

#### [1080p]

Outputs 1080 lines of progressive video.

---

#### [1080i]

Outputs 1080 lines of interlaced video.

---

#### [720p]

Outputs 720 lines of progressive video.

---

#### [576p]

Outputs 576 lines of progressive video.

---

#### [576i]

Outputs 576 lines of interlaced video.

---

### 1080p Display Mode

When the resolution is set to 1080p, select [24 Hz] for smooth presentation of film material (1080p/24 Hz) with a HDMI-equipped display compatible with 1080p/24 Hz input.



### NOTE

- When you select [24 Hz], you may experience some picture disturbance when the video switches video and film material. In this case, select [50 Hz].
- Even when [1080p Display Mode] is set to [24 Hz], if your TV is not compatible with 1080p/24 Hz, the actual frame frequency of the video output will be 50 Hz or 60 Hz to match the video source format.

## HDMI Color Setting

Select the type of output from the HDMI OUT jack. For this setting, please refer to the manuals of your display device.

### [YCbCr]

Select when connecting to a HDMI display device.

### [RGB]

Select when connecting to a DVI display device.

## 3D Mode

Select the type of output mode for Blu-ray 3D disc playback. Refer to page 51-52 for more information about Blu-ray 3D disc.

### [Off]

Blu-ray 3D disc playback will output as 2D mode like a normal BD-ROM disc playback.

### [On]

Blu-ray 3D disc playback will output as 3D mode.

## Video Output Format

Select an option according to the TV connection type.

### [YPbPr]

When your TV is connected to the COMPONENT OUT jacks on the unit.

### [RGB]

When your TV is connected to the SCART (RGB signal) jack on the unit.



### NOTE

This function is available only when the [Resolution] is set to [576i].



## [LANGUAGE] Menu

### Display Menu

Select a language for the [Setup] menu and on-screen display.

### Disc Menu/Disc Audio/Disc Subtitle

Select the language you prefer for the audio track (disc audio), subtitles, and the disc menu.

#### [Original]

Refers to the original language in which the disc was recorded.

#### [Other]

Press ENTER (⊙) to select another language. Use number buttons then press ENTER (⊙) to enter the corresponding 4-digit number according to the language code list on page 90.

#### [Off] (Disc Subtitle only)

Turn off Subtitle.



### NOTE

Depending on the disc, your language setting may not work.

## DTV Audio

Digital channels sometimes provide multiple audio tracks, often in a different language or format (Dolby Digital, Dolby Digital+, AVC, Mpeg, etc.). You can set a default audio language with this setting. If provided by the broadcaster, you can also select a different audio language while viewing TV by pressing AUDIO repeatedly. (See "Selecting DTV audio language" on page 44)

## DTV Subtitle

Digital channels sometimes provide subtitles, often in a different language. You can set a preferred subtitle language with this setting, if DTV subtitles are provided by the broadcaster. Press SUBTITLE repeatedly to select a subtitle language while viewing digital TV. (See "Selecting DTV subtitle language" on page 45.)



## [AUDIO] Menu

Each disc has a variety of audio output options. Set the player's Audio options according to the type of audio system you use.



### NOTE

Since many factors affect the type of audio output, see "Audio Output Specifications" on page 95-96 for details.

## HDMI / Digital Output

Select the output sound format when a device equipped with a HDMI or Digital Audio input jack is connected to the HDMI OUT or DIGITAL AUDIO OUT jack on this player.

### [PCM Stereo]

Select if you connect this unit's HDMI OUT or DIGITAL AUDIO OUT jack to a device with two-channel digital stereo decoder.

### [PCM Multi-Ch] (HDMI only)

Select if you connect this unit's HDMI OUT jack to a device with multi-channel digital decoder.

### [DTS Re-Encode]

Select if you connect this unit's HDMI OUT or DIGITAL AUDIO OUT jack to a device with a DTS decoder.

## [Primary Pass-Thru]

Select if you connect this unit's DIGITAL AUDIO OUT and HDMI OUT jack to a device with LPCM, Dolby Digital, Dolby Digital Plus, Dolby TrueHD, DTS and DTS-HD decoder.



### NOTE

- When [HDMI] option is set to [PCM Multi-Ch], the audio may output as PCM Stereo if the PCM Multi-Ch information is not detected from HDMI device with EDID.
- If the [HDMI] or [Digital Output] option is set to [DTS re-encode], the DTS Re-encode audio is output for BD-ROM discs with secondary audio and the original audio is output for the other discs (like [Primary Pass-Thru]).

## Sampling Freq. (Digital Audio Output)

### [192 kHz]

Select this if your A/V Receiver or Amplifier is capable of handling 192 kHz signals.

### [96 kHz]

Select this if your A/V Receiver or Amplifier is not capable of handling 192 kHz signals. When this choice is made, this unit automatically converts any 192 kHz signals to 96 kHz so your system can decode them.

### [48 kHz]

Select this if your A/V Receiver or Amplifier is not capable of handling 192 kHz and 96 kHz signal. When this choice is made, this unit automatically converts any 192 kHz and 96 kHz signals to 48 kHz so your system can decode them.

Check the documentation for your A/V Receiver or Amplifier to verify its capabilities.

## DRC (Dynamic Range Control)

This function allows you to listen to a movie at a lower volume without losing clarity of sound.

### [Off]

Turns off this function.

### [On]

Compress the dynamic range of the Dolby Digital, Dolby Digital Plus or Dolby TrueHD audio output.

### [Auto]

The dynamic range of the Dolby TrueHD audio output is specified by itself. And the dynamic range of the Dolby Digital and Dolby Digital Plus are operated as same as the [On] mode.



### NOTE

The DRC setting can be changed only when a disc is not inserted or the unit is in complete stop mode.

## DTS Neo:6

If the player is connected to the multi-channel Audio Receiver by HDMI connection, set this option to enjoy the multi-channel surround sound with the 2-channel audio source.

### [Off]

Outputs the stereo sound via front speakers.

### [Music]

Outputs the multi-channel sounds that are optimized for listening to music.

### [Cinema]

Outputs the multi-channel sounds that are optimized for watching movie.



### NOTE

- This function is not available on an on-line service.
- Only the audio source with less than 48 kHz sampling frequency is available for this function.
- This function is available only when [HDMI] option is set to [PCM Multi-Ch].



## [LOCK] Menu

To access any features in the [LOCK] settings, you must enter the 4-digit security code you have created. If you have not entered a password yet, you are prompted to do so. Enter a 4-digit password twice, and press ENTER (⊙) to create a new password.

## Password

You can create, or change the password.

### [None]

Enter a 4-digit password twice, and press ENTER (⊙) to create a new password.

### [Change]

Enter the current password and press ENTER (⊙). Enter a 4-digit password twice, and press ENTER (⊙) to create a new password.

## If you forget your password

If you forget your password, you can clear it using the following steps:

1. Remove any disc that might be in the player.
2. Select [Password] option in the [Setup] menu.
3. Use Number buttons to enter "210499". The password is cleared.

**NOTE**

If you make a mistake before pressing ENTER (Ⓞ), press CLEAR. Then input the correct password.

**DTV Lock**

Allows you to set up specific programs and through blocking schemes. Also allows you to activate or disable all of the lock schemes previously set up. A password is required to gain access to the lock menu options. When the DTV Lock is set to [unlock]. (See "Setting the DTV Lock" on page 34.)

**DTV Rating**

You can set the rating to block out all the programs with rating above a specified level. (See "Adjusting DTV Rating" on pages 34.)

**DVD Rating**

Blocks playback of rated DVD based on their content. (Not all discs are rated.)

**[Rating 1-8]**

Rating one (1) has the most restrictions and rating eight (8) is the least restrictive.

**[Unlock]**

If you select [Unlock], parental control is not active and the disc plays in full.

**BD Rating**

Sets an age limit for BD-ROM playback. Use number buttons to input an age limit for BD-ROM viewing.

**[255]**

All BD-ROM can be played.

**[0-254]**

Prohibits play of BD-ROM with corresponding ratings recorded on them.

**NOTE**

The [BD rating] will be applied only for the BD disc that containing the Advanced Rating Control.

**Area Code**

Enter the code of the area whose standards were used to rate the DVD video disc, based on the list on page 89.





## [NETWORK] Menu

The [NETWORK] settings are needed to use the software update feature, BD Live, Home Link and NetCast features.

### Connection Setting

If your home network environment is ready to be connected to the player, the player needs to be set to the wired or wireless network connection for network communication. (See "Connecting to your Home Network" on pages 20-25.)

### Connection Status

If you want to check the network status on this player, select the [Connection Status] option and press ENTER (⊙) to check whether a connection to the network and the internet has been established.

### BD-LIVE connection

You can restrict Internet access when BD-LIVE functions are used.

#### [Permitted]

Internet access is permitted for all BD-LIVE contents.

#### [Partially permitted]

Internet access is permitted only for BD-LIVE contents which have content owner certificates. Internet access and AAC3 Online functions are prohibited for all BD-LIVE contents without a certificate.

#### [Prohibited]

Internet access is prohibited for all BD-LIVE contents.



## [OTHERS] Menu

### Time Setting

The clock must be set in order to use timer recording.

#### [Auto]

Select a programme that broadcasts a clock signal and the clock will be set automatically. If the time that has been automatically set is not correct when compared your local time, you can set additional time option.

#### [Manual]

If there is no channel that broadcasts a clock signal in your area, you can set the time and date manually. Use </> to select each field, and input correct time and date using ^/V, and press ENTER (⊙).

### DivX VOD

ABOUT DIVX VIDEO: DivX® is a digital video format created by DivX, Inc. This is an official DivX Certified device that plays DivX video. Visit [www.divx.com](http://www.divx.com) for more information and software tools to convert your files into DivX video.

ABOUT DIVX VIDEO-ON-DEMAND: This DivX Certified® device must be registered in order to play DivX Video-on-Demand (VOD) content. To generate the registration code, locate the DivX VOD section in the device setup menu. Go to [vod.divx.com](http://vod.divx.com) with this code to complete the registration process and learn more about DivX VOD.

**[Register]** - Displays the registration code of your player.

**[Deregister]** - Deactivate your player and display the deactivation code.

**NOTE**

All the downloaded videos from DivX VOD with the unit's registration code can only be played on the unit's USB device.

## Initialize

### [Factory Set]

You can reset the recorder to all its factory settings. Some options cannot be reset (Rating and Password). The [Setup Wizard] menu appears on the screen after the factory settings.

### [BD Storage Clear]

Initializes the BD contents from the connected USB storage.

**NOTE**

- If you reset the unit to its original factory settings using [Factory Set] option, you have to set the network settings activation again.
- The [Initialization] option is not available while recording or [Lock] in the [Setup] menu is set to [On].
- If you select [Factory Set] in the Setup menu, All the channels will be deleted.

## Software

### [Information]

Displays the current software version.

### [Update]

You can update the software by connecting the unit directly to the software update server (see page 93-94).

## Disclaimer Notice

Press ENTER (Ⓞ) to view the notice of Network Service Disclaimer on page 99.

## Auto Power Off

The screen saver appears when you leave the player in Stop mode for about five minutes. If you set this option to [On], the unit automatically turns itself off after the Screen Saver is displayed for 25 minutes. Set this option to [Off] to leave the screen saver until the unit is operated by the user.

## Power Save Mode

Selects whether this recorder is in power save mode when the power is turned off. This option is not available when a timer recording is set.

### [On]

The front panel display is off and only signals arriving at the antenna input are passed through when the recorder is turned off.

### [Off]

Turns off the [Power Save Mode] function.

# 4 Operation

## Using the Digital TV functions

You can watch and record the digital TV programmes or playback the recorded TV programmes you want to watch using this unit.

### Viewing the Digital TV

Viewing the Digital TV broadcasting on the TV screen.

**NOTE**

- DTV antenna connection is required. (page 14)
- DTV settings such as [Auto Tuning] in the [Setup] menu may be required. (page 32-33)

1. Press **POWER** to turn on the recorder.
2. Use **▲/▼/◀/▶** to select [DTV] on the HOME menu and press **ENTER** (⊙).

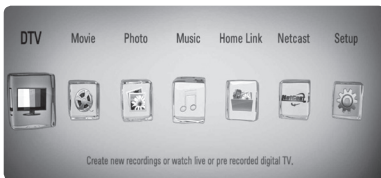

## Changing Digital TV programmes

Generally, press **PR (▲/▼)** to select the programme position, or entering a programme number using numerical buttons. If you want to change the programme on the programme list, follow the instruction as below.

1. While watching DTV, press **PR LIST**.



2. Use **▲/▼** to select a desired programme, and press **ENTER** (⊙).

Press red coloured button (**R**) to sort the programmes into alphabetical order. Press green coloured button (**G**) to sort the programmes into FTA - CAS Press yellow colored (**Y**) button to sort the programmes into number order.

3. Press **RETURN** (↵) to exit the programme list.

## Setting favourite programmes

1. While watching DTV, press PR LIST
2. Use  $\Delta/\nabla$  to select a programme you want to add on the Favourite List.
3. Press blue coloured (B) button to display [Select Favorite Group] menu.
4. Use  $\Delta/\nabla$  to select a group and press ENTER (⊙) to add the programme on the selected group.



4

Operation

5. On the Programme List menu, use  $\leftarrow/\rightarrow$  to move to the Favorite List menu.

The  $\odot$  mark appears for the favourite programmes on the Favorite List.

To cancel the favourite programmes from the Favorite List, select a programme with  $\odot$  mark, and press blue coloured (B) button.

## Viewing the programme information

You can view a description of the programme being broadcast.

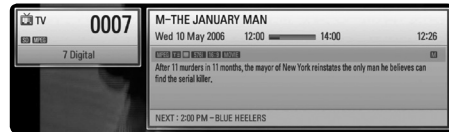

1. While watching DTV, press ENTER (⊙) to display the programme information.
2. Press ENTER (⊙) or (RETURN or EXIT) again to close the programme information.

## Selecting DTV audio language

Some digital programmes may broadcast several audio languages or encoding methods. You can select an audio languages or an encoding method when it is available.

1. While watching DTV, press INFO/DISPLAY  $\square$ .

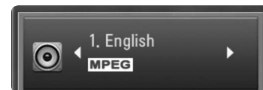

2. Use  $\leftarrow/\rightarrow$  to select an audio language or an encoding method, and press INFO/DISPLAY  $\square$ .

## Selecting DTV subtitle language

Some digital programmes may broadcast several subtitle languages. You can select a subtitle language when it is available.

1. While watching DTV, press SUBTITLE.



2. Use </> to select a subtitle language, and press ENTER (⊙).

### NOTE

You can find a programme that supports subtitle language on the programme information. For the programmes with subtitle, SUB icon appears on the programme information.

## Programme Guide (Digital program only)

The Programme Guide contains schedule and program information for digital programs. They also provide local over-the-air programs information including conventional digital programs. Use the Programme Guide to find programs easily and conveniently and to view schedule and descriptive program information for the programs.

### To Display the Programme Guide

Press the GUIDE button on your remote control.



### To Exit the Programme Guide

Press the RETURN (↵) button to return to the last program you tuned to.

### To change guide menu

The guide screen provides two search menus. Press blue colored (B) button when the Programme Guide is displayed.



Now/Next: The screen shows now and next programs.

8 Days: The screen shows programs within 8 days.

### To navigate through programs on the Guides

Use ^/V/</> on your remote control to navigate the guide screen.

You can move faster through programs by scrolling page-by-page with the PR ^/V buttons on the remote control. Each button stroke scrolls one page up or down.

### To tune to another current channel

Use ^/V/</> to select a current channel then press ENTER (⊙). You can watch the channel.

### To display the Full Information window

You can view the detail information for the highlighted program. Press INFO/DISPLAY (i) to display detail information window.

To exit the detail information window, press ENTER (⊙) again.

### To change date

When the Program Guide with 8 days is displayed, you can also change the date of the Program Guide by pressing the green colour button then use </> to select a date then press ENTER (Ⓞ).

After setting favorite channels from the PR list, you can use the yellow button to toggle between [All] and [Favorite] channel list.

### Timer Recording with Program Guide

You can set a timer record using program guide with 8 days.

1. Display Program Guide with 8 days.
2. Select a program then press red colour (R) button. The red timer icon will be displayed and the program will be memorized by the recorder. You can check the programming on the Timer Record List menu (see page. 47-49).
3. To release the timer recording, select the program then press red colour (R) button. The red timer icon disappears.

4

Operation

### Using the teletext (Viewing Teletext)

Many Digital TV programmes broadcast information via their text service, and this recorder has access to dedicated text programmes transmitted by the broadcasters.



1. Press TEXT while watching TV.
2. Use coloured (R/G/Y/B) button to select a page.  
You can also select a page by entering a three digit number with the numerical buttons.
3. Press TEXT or EXIT to exit the teletext screen.

### NOTE

Additionally, you now have four coloured buttons to navigate through the content of the page. The use of these coloured buttons will be displayed on the screen.

# Recording TV programmes

## When connected to external HDD, this function will be available.

You can record Digital TV programmes and store them on the HDD. Recording scrambled and FTA channels will be proceeded separately. In case of Scrambled channel, this channel will be recorded with encryption. Also, recorded scrambled channel is not available to copy or play on the other units.

## Normal Recording

1. Use PR (Λ/V) to select a programme you want to record.
2. Press ● REC to start recording.  
Press || to pause recording, press || again to resume recording.
3. Press ■ to stop recording. To stop recording, you must move to the programme being recorded before pressing ■.

### NOTE

- The TV screen turns black with stop mark caused by no signal. Scramble, rating lock recording is not available.
- During the recording, it is unable to change channel.
- Pay channel can not be recorded correctly if you don't insert CI or CI+ CAM. You should unlock parental rating of CI CAM if you want to use timer record correctly. When you record pay channel, recorded title can be divided in to several titles according to CAM authentication.
- Same of title can not be played well if title is recorded when CAM is not authenticated by this recorder.

## Timer Recording (Manual)

You can set the timer for a total of 32 programmes, up to 22-28 days in advance.

1. While watching TV, press TIMER REC.



2. Use Λ/V/</> to select the date to record, and press ENTER (⊙).



3. Select an item using </> and adjust it using Λ/V. You can use numbered buttons to change the setting. The adjustable items are listed below.

Start time	Sets the start time.
End time	Sets the end time.
Channel	Sets the programme position. (If you want to display more channels, press PR LIST)
Repeat	Choose a desired repeat mode. (Once, Daily, Weekly or Mon-Fri)

### NOTE

- The timer recording can be set from 3 minutes after the current time.
- Timer recording is not available on a USB device.
- You should unlock parental rating of CI or CAM if you want to use timer record correctly.

4. Press ENTER (⊙).
5. Select [OK] then press ENTER (⊙).

If you input the wrong information, an error message will appear and the timer recording cannot be made.

## Timer Recording (EPG)

You can also set the timer based on the information provided by the EPG.

1. While watching TV, press GUIDE.



2. Use </> to select date field, and select the date of recording schedule using  $\wedge/V$ .
3. Use </> to select programme field, and set the programme using  $\wedge/V$ .
4. Use </> to select the programme list, and select a programme you want to record using  $\wedge/V$ .
5. Press coloured (R) button.

For the successfully scheduled programme, a red bullet mark appears.

A red bullet mark may not appear for unavailable programme to record.

6. Press RETURN (↵) to return to the TV viewing.
7. Press TIMER REC, and check whether the schedule is registered properly or not.



## Canceling a timer recording

You can cancel a timer recording before the timer recording actually starts.

1. While watching TV, press TIMER REC.
2. Press the red coloured (R) button.
3. Use </>/ $\wedge/V$  to select a schedule you want to cancel.
4. Use  $\wedge/V$  to select [Timer Record List], and press the green coloured (G) button.



Select [No] and press ENTER (⊙) to cancel. Select [Yes] and press ENTER (⊙) to delete selected schedules (selected recording).

## Editing a timer recording

You can edit a pre-scheduled timer recording before the timer recording actually starts.

1. While watching TV, press TIMER REC.
2. Press the red coloured (R) button.
3. Press ENTER (⊙) to display the [Record setting] menu.



4. Follow the steps 3-5 from "Timer Recording (Manual)" on page 47 to complete the editing.



## Instant Timer Recording

You can set the recording time instantly to stop the recording automatically.

1. Use PR (Λ/V) to select a programme you want to record.
2. Press ● REC. to start recording.
3. While recording, press </> repeatedly to set the recording duration
4. Press ENTER (⊙).

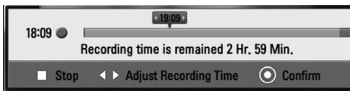

5. Press ■ to stop recording.

### NOTE

- The standard recording time is 3hours (MAX=6hours). Depending on the remaining capacity of HDD, the recording time is somewhat flexible .
- If the unit cannot catch the signal, the recording will be pause, actual recording time can be less than the time set on timer.
- You cannot record radio or blocked channels.
- The quality of recording can be different on the status of the broadcast signal.
- During the recording, Turning off by force can cause a serious problem on hard disk drive.
- If the unit cannot catch the signal, the recording will be pause, actual recording time can be less than the time set on timer.

## General Playback

### Playing Discs

1. Press ▲ (OPEN/CLOSE), and place a disc on the disc tray.

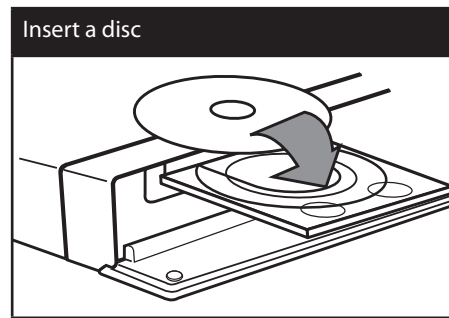

2. Press ▲ (OPEN/CLOSE) to close the disc tray.

For most Audio CD, BD-ROM and DVD-ROM discs, playback starts automatically.

3. Press HOME (🏠).



4. Select [Movie], [Photo] or [Music] using </>, and press ENTER (⊙).
5. Select the [Disc] using </>, and press ENTER (⊙).

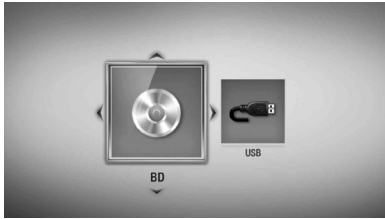

While navigating [Movie], [Photo] or [Music] menu, press green(G) colored button to change the device. (DISC or USB)

6. Select a file using  $\wedge/\vee/\lt;/\gt;$ , and press  $\blacktriangleright$  (PLAY) or ENTER (Ⓞ) to play the file.

### NOTE

- Playback functions described in this manual are not always available in every files and media. Some functions can be restricted depending on many factors.
- Depending on the BD-ROM titles, a USB device connection may be needed for proper playback.

4

Operation

### To stop playback

Press  $\blacksquare$  (STOP) during playback.

### To pause playback

Press  $\parallel$  (PAUSE) during playback.  
Press  $\blacktriangleright$  (PLAY) to resume playback.

### To play frame-by-frame

Press  $\parallel$  (PAUSE) while movie playback.  
Press  $\parallel$  (PAUSE) repeatedly to playback Frame-by-Frame.

### To scan forward or backward

Press  $\blacktriangleleft$  or  $\blacktriangleright$  to play fast forward or fast reverse during playback.  
You can change the various playback speeds by pressing  $\blacktriangleleft$  or  $\blacktriangleright$  repeatedly.

### To slow down the playing speed

While the playback is paused, press  $\blacktriangleright\blacktriangleright$  repeatedly to play various speeds of slow motion.

### To skip to the next/previous chapter/track/file

During playback, press  $\blacktriangleleft\blacktriangleleft$  or  $\blacktriangleright\blacktriangleright$  to go to the next chapter/track/file or to return to the beginning of the current chapter/track/file.  
Press  $\blacktriangleleft\blacktriangleleft$  twice briefly to step back to the previous chapter/track/file.

In the [Home Link] menu, there may be many types of media files in the current folder together. In this case, press  $\blacktriangleleft\blacktriangleleft$  or  $\blacktriangleright\blacktriangleright$  to go to the previous or next media files of the same type.

## Using the disc menu

**BD DVD AVCHD**

### To display the disc menu

The menu screen may be displayed first after loading a disc which contains a menu. If you want to display the disc menu during playback, press DISC MENU.

Use  $\wedge/\vee/\lt;/\gt$  buttons to navigate through menu items.

### To display the Pop-up menu

Some BD-ROM discs contain a Pop-up menu that appears during playback.

Press TITLE/POPOP during playback, and use  $\wedge/\vee/\lt;/\gt$  buttons to navigate through menu items.

## Resume playback

**BD DVD AVCHD MOVIE MOVIE-N**  
**ACD MUSIC MUSIC-N REC**

This unit remembers the point where you pressed the ■ (STOP) depending on the disc. If "■■■ (Resume Stop)" appears on the screen briefly, press ► (PLAY) to resume playback (from the scene point).

If you press ■ (STOP) twice or unload the disc, "■ (Complete Stop)" appears on the screen. The unit will clear the stopped point.

### NOTE

- The resume point may be cleared when a button is pressed (for example; ⏻ (POWER), ▲ (OPEN/CLOSE), etc).
- On BD-Video discs with BD-J, the resume playback function does not work.
- If you press ■ (STOP) once during BD-ROM interactive title playback, the unit will be in Complete Stop mode.

## Playing the recorded titles

1. While watching TV, press REC LIST to display the options menu or press REC LIST in Home menu.



2. Use  $\wedge/\vee/\lt;/\gt$  to select recording title.
3. Press ► or ENTER (⊙) to play the recording title.
4. Recorded title of CI+ channel has retention limit. This title cannot be played after retention limit.
5. Some of pay channels cannot be played.

## Searching the recorded titles

### REC

You can search for videos by entering search words of up to 60 characters.

1. While watching TV, press REC LIST to display the options menu.
2. Press SEARCH.
3. Use  $\wedge/\vee/\lt;/\gt$  to select a character then press ENTER (⊙) to confirm your selection on the virtual keyboard.

To enter a letter with an accent mark, select the letter from extended character set.



**[Clear]** – Clear all entered characters.

**[Space]** – Inserts a space at the cursor position.

**[<-]** – Deletes the previous character at the cursor position.

**[ABC / abc / #+--&]** – Change the keyboard menu settings to capital letters, small letters or symbols.

### NOTE

To enter a letter with an accent mark:

1. Select a letter using  $\wedge/\vee/</>$  on the keyboard menu.
2. Press INFO/DISPLAY to display the extended character set.
3. character set. Use  $</>$  to select a character then press ENTER (⊙).

4. When you finish entering the search words, Select [OK] and press ENTER (⊙) to display the related videos list.

## Sorting the recorded titles

### REC

1. While watching TV, press REC LIST to display the options menu.
2. Press blue coloured (B) button repeatedly to sorted by recorded time in recent order or title name in alphabetical order.

**[ABC order]** – by title name in alphabetical order.

**[Recent order]** – sorted by recorded date.

## Playing content contained in the external hard disk drive

1. Press HOME (🏠).



2. Select [Movie], [Photo] or [Music] using  $</>$ , and press ENTER (⊙).
3. Select the [USB] option using  $</>$ , and press ENTER (⊙).

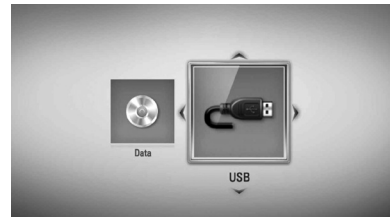

This step is needed only when a disc or a USB device is connected on this unit.

While navigating [Movie], [Photo] or [Music] menu, press green(G) colored button to change the device. (DISC or USB)

4. Select a file using  $</>/\wedge/\vee$ , and press PLAY or ENTER (⊙) to play the file.

### NOTE

- The file requirements are described on page 10.
- You can use various playback functions. Refer to pages 54-60.
- Recorded files are searchable only by searching on the [Record List].

## Playing Blu-ray 3D disc

This player can play the Blu-ray 3D discs which contains separate views for the left and right eyes.

### Preparation

In order to playback Blu-ray 3D title in stereoscopic 3D mode, you need to:

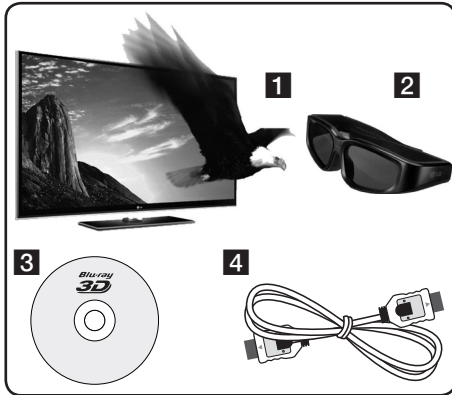

- 1** Check if your TV is 3D capable and has HDMI 1.4 input(s).
  - 2** Wear 3D glasses to enjoy the 3D experience if it is necessary.  
If you want to purchase additional 3D-ready glasses, contact the dealer that you purchased the 3D-ready TV from.
  - 3** check whether the BD-ROM title is the Blu-ray 3D disc or not (page 54).
  - 4** connect an HDMI cable (version 1.3 or higher) between the player's HDMI output and TV's HDMI input.
- 1.** Press HOME (🏠), and set the [3D Mode] option on the [Setup] menu to [On] (page 37).
  - 2.** Press ▲ (OPEN/CLOSE), and place a disc on the disc tray.

- 3.** Press ▲ (OPEN/CLOSE) to close the disc tray.  
The playback starts automatically.



The 3D icon appears on the screen when 3D content is in playback.

- 4.** Refer to the owner's manual of your 3D-ready TV for the further instruction.  
You may need to adjust the display settings and focus on your TV's setting for the improved 3D effect.

### CAUTION

- Watching a 3D content for a long period time may cause dizziness or tiredness.
- It is not recommended to watch a movie in 3D mode for infirm, child and pregnant woman.
- If you are experiencing headache, tiredness or dizziness while viewing contents in 3D, it is strongly recommended to stop the playback and rest until you feel normal.

### 3D available Blu-ray 3D Discs



The "Blu-ray 3D" logo labeled BD-ROM disc can be played on this player with 3D mode output. If your TV is not the Blu-ray 3D-ready TV\*, 2D mode output is available.



The "Blu-ray 3D ONLY" logo labeled BD-ROM disc can be played on this player with 3D mode output. The Blu-ray 3D ONLY disc playback is not available, if your TV or player are not the Blu-ray 3D-ready device.

\* 3D-ready TV refers to TVs that are compliant with "HDMI 1.4 3D mandatory format" standard.

#### NOTE

The "Blu-ray 3D" and "Blu-ray 3D ONLY" may not be printed on your BD-ROM disc, even if the disc contains 3D contents.

4

Operation

## Advanced Playback

### Repeat Playback



During playback, press REPEAT repeatedly to select a desired repeat mode.

#### BDs/DVDs

- A-** – Selected portion will be repeated continually.
- Chapter** – The current chapter will be played back repeatedly.
- Title** – The current title will be played back repeatedly.

To return to normal playback, press REPEAT repeatedly to select [Off].

#### Audio CDs/Music files

- Track** – The current track or file will be played back repeatedly.
- All** – All the tracks or files will be played back repeatedly.
- The tracks or files will be played back in random order.
- All** – All the tracks or files will be played back repeatedly in random order.
- A-B** – Selected portion will be repeated continually. (Audio CD only)

To return to normal playback, press CLEAR.

#### NOTE

- If you press once during Repeat Chapter/Track playback, the repeat playback cancels.
- This function may not work on some disc or title.

## Repeating a specific portion

**BD DVD AVCHD ACD**

This player can repeat a portion you have selected.

1. During playback, press REPEAT to select [A-] at the beginning of the portion you wish to repeat.
2. Press ENTER (Ⓞ) at the end of the portion. Your selected portion will be repeated continually.
3. To return to normal playback, press REPEAT repeatedly to select [Off].



### NOTE

- You cannot select a portion less than 3 seconds.
- This function may not work on some disc or title.

## Enlarge the playback image

**BD DVD AVCHD MOVIE MOVIE-N**  
**PHOTO REC**

1. During playback or pause mode, press ZOOM to display the [Zoom] menu.
2. Use red (R) or green (G) colored button to zoom out or in on the still image. You can move through the zoomed picture using  $\wedge/\vee/\lt;/\gt$  buttons.
3. To return to the normal picture size, press yellow (Y) colored button.
4. Press RETURN (↵) to exit the [Zoom] menu.

## Marker Search

**BD DVD AVCHD MOVIE MOVIE-N**

You can start playback from up to nine memorized points.

### To enter a marker

1. During playback, press MARKER at the desired point. The Marker icon appears on the TV screen briefly.
2. Repeat step 1 to add up to nine markers.

### To recall a marked scene

1. Press SEARCH and the search menu appears on the screen.
2. Press a number button to select a marker number that you want to recall. Playback starts from the marked scene.

### To delete a Marker

1. Press SEARCH and the search menu appears on the screen.

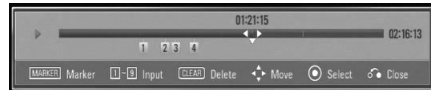

2. Press  $\vee$  to highlight a marker number. Use  $\lt;/\gt$  to select a marked scene that you want to delete.
3. Press CLEAR and the marked scene is erased from the search menu.



### NOTE

- This function may not work depending on discs, titles, server ability.
- All marked points are cleared if the title is in complete stop (■) mode, the title is changed or if you unload the disc.
- If the total length of the title is less than 10 seconds, this function is not available.

## Using the search menu

**BD DVD AVCHD MOVIE MOVIE-N**

Using search menu, you can easily find the point where you want to start playback.

### To search a point

1. During playback, press SEARCH to display the search menu.



2. Press </> to skip the playback 15 seconds forward or backward. You can select a point that you want to skip by pressing and holding </> button.



**NOTE**  
This function may not work in is file playback and on recording list.

### To start playback from a marked scene

1. Press SEARCH and the search menu appears on the screen.
2. Press V to highlight a marker number. Use </> to select a marked scene that you want to playback.
3. Press ENTER (⊙) to start playback from the marked scene.



- This function may not work depending on discs, titles, server ability.
- This function may not work on some [Home Link] content depending on the file type and ability of the DLNA server
- This function may not work in is file playback and on recording list.

## Changing content list view

**MOVIE MOVIE-N MUSIC MUSIC-N PHOTO REC**

On the [Movie], [Music], [Photo] or [Home Link] menu, you can change the content list view.

### Method 1

Press red (R) coloured button repeatedly.

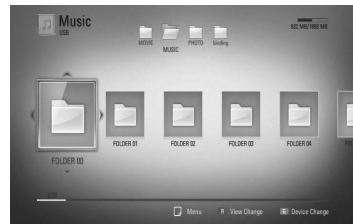

### Method 2

1. On the content list, press INFO/DISPLAY (ⓘ) to display the option menu.
2. Use ^/V to select the [View Change] option.
3. Press ENTER (⊙) to change the content list view.



## Viewing content information

**MOVIE** **MOVIE-N** **REC**

The player can display the content information.

1. Select a file using  $\wedge/V/</>$ .
2. Press INFO/DISPLAY (I) to display the option menu.
3. Select the [Information] option using  $\wedge/V$ , and press ENTER (O).

The file information appears on the screen.

During movie playback, you can display the file information by pressing TITLE/POPUP.



### NOTE

The information displayed on the screen may not be correct compared to the actual content information.

## Last Scene Memory

**BD** **DVD**

This unit memorizes the last scene from the last disc that is viewed. The last scene remains in memory even if you remove the disc from the unit or switch off the unit. If you load a disc that has the scene memorized, the scene is automatically recalled.



### NOTE

- Last Scene Memory function for a previous disc is erased once a different disc is played.
- This function may not work depending on the disc.
- On BD-Video discs with BD-J, the last scene memory function does not work.
- This unit does not memorize settings of a disc if you switch off the unit before commencing to play it.

## On-Screen display

You can display and adjust various information and settings concerning the content.

### Displaying content information on-screen

**BD** **DVD** **AVCHD** **MOVIE** **MOVIE-N**  
**REC**

1. During playback, press INFO/DISPLAY (I) to show various playback information.



- 1 Title** – current title number/total number of titles
- 2 Chapter** – current chapter number/total number of chapters
- 3 Time** – elapsed playing time/total playback time
- 4 Audio** – selected audio language or channel
- 5 Subtitle** – selected subtitle
- 6 Angle** – selected angle/total number of angles
- 7 TV Aspect Ratio** – selected TV aspect Ratio
- 8 Picture Mode** – selected picture mode

**9 Movie Information** – Select this option and press ENTER (⊙) to display movie information from Gracenote Media Database (BD/DVD only).

2. Select an option using  $\wedge/\vee$ .
3. Use  $\langle/\rangle$  to adjust the selected option value.
4. Press RETURN (↵) to exit the On-Screen display.

### ! NOTE

- If no button is pressed for a few seconds, the on-screen display disappears.
- A title number cannot be selected on some discs.
- Available items may differ depending on discs or titles.
- If BD interactive title is playing back, some setting information is displayed on the screen but prohibited to be changed.
- To use the [Movie Information] option, the player must be connected to the broadband internet for accessing the Gracenote Media Database.
- If the information from the Gracenote Media Database is either not correct or does not exist, please contact [www.gracenote.com](http://www.gracenote.com) for support.
- LG is a licensee of Gracenote technology and is not responsible or reliable for information from the Gracenote Media Database.
- The unit may not be able to display the music information depending on the network condition.

## Playing from selected time

**BD DVD AVCHD MOVIE MOVIE-N**  
**REC**

1. Press INFO/DISPLAY (ℹ) during playback. The time search box shows the elapsed playing time.
2. Select the [Time] option and then input the required start time in hours, minutes, and seconds from left to right.  
For example, to find a scene at 2 hours, 10 minutes, and 20 seconds, enter "21020".  
Press  $\langle/\rangle$  to skip the playback 60 seconds forward or backward.
3. Press ENTER (⊙) to start playback from selected time.

### ! NOTE

- This function may not work on some disc or titles.
- This function may not work on some [Home Link] content depending on the file type and ability of the DLNA server.

## Hearing different audio



1. During playback, press INFO/DISPLAY (i) to display the On-Screen display.
2. Use  $\wedge/\vee$  to select the [Audio] option.
3. Use  $\lt;/\gt$  to select desired audio language, audio track or audio channel.

### NOTE

- Some discs allow you to change audio selections only via the disc menu. In this case, press TITLE/POPUP or DISC MENU button and choose the appropriate audio from the selections on the disc menu.
- Immediately after you have switched sound, there may be a temporary discrepancy between the display and actual sound.
- On BD-ROM disc, the multi audio format (5.1CH or 7.1CH) is displayed with [MultiCH] in the on-screen display.

## Selecting a subtitle language



1. During playback, press INFO/DISPLAY (i) to display the On-Screen display.
2. Use  $\wedge/\vee$  to select the [Subtitle] option.
3. Use  $\lt;/\gt$  to select the desired subtitle language.
4. Press RETURN (↵) to exit the On-Screen display.

### NOTE

- Some discs allow you to change subtitle selections only via the disc menu. If this is the case, press TITLE/POPUP or DISC MENU button and choose the appropriate subtitle from the selections on the disc menu.

## Watching from a different angle



If the disc contains scenes recorded at different camera angles, you can change to a different camera angle during playback.

1. During playback, press INFO/DISPLAY (i) to display the On-Screen display.
2. Use  $\wedge/\vee$  to select the [Angle] option.
3. Use  $\lt;/\gt$  to select the desired angle.
4. Press RETURN (↵) to exit the On-Screen display.

## Changing the TV Aspect Ratio



You can change the TV aspect ratio setting during playback.

1. During playback, press INFO/DISPLAY (i) to display the On-Screen display.
2. Use  $\wedge/\vee$  to select the [TV Aspect Ratio] option.
3. Use  $\lt;/\gt$  to select desired option.
4. Press RETURN (↵) to exit the On-Screen display.

### NOTE

Even if you change the value of the [TV Aspect Ratio] option in On-Screen display, the [TV Aspect Ratio] option in the [Setup] menu is not changed.

## Changing the Picture Mode



You can change the [Picture mode] option during playback.

1. During playback, press INFO/DISPLAY (I) to display the On-Screen display.
2. Use  $\wedge/\vee$  to select the [Picture Mode] option.
3. Use  $\lt;/\gt$  to select desired option.
4. Press RETURN (↵) to exit the On-Screen display.

### Setting the [User setting] option

1. During playback, press INFO/DISPLAY (I) to display the On-Screen display.
2. Use  $\wedge/\vee$  to select the [Picture Mode] option.
3. Use  $\lt;/\gt$  to select the [User setting] option, and press ENTER (⊙).

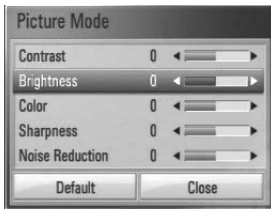

4. Use  $\wedge/\vee/\lt;/\gt$  to adjust the [Picture Mode] options.  
Select [Default] option then press ENTER (⊙) to reset the all video adjustments.
5. Use  $\wedge/\vee/\lt;/\gt$  to select the [Close] option, and press ENTER (⊙) to finish setting.

## Enjoying BD-LIVE

This unit allows you to enjoy functions such as picture-in-picture, secondary audio and Virtual packages, etc., with BD-Video supporting BONUSVIEW (BD-ROM version 2 Profile 1 version 1.1/ Final Standard Profile). Secondary video and audio can be played from a disc compatible with the picture-in-picture function. For the playback method, refer to the instructions in the disc.

In addition to the BONUSVIEW function, BD-Video supporting BD-LIVE (BD-ROM version 2 Profile 2) that has a network extension function allows you to enjoy more functions such as downloading new movie trailers by connecting this unit to the internet.

1. Check the network connection and settings (pages 20-25).
2. Insert a USB storage device to the USB port on the front panel.  
A USB storage device is needed to download bonus content.



3. Press HOME (🏠), and set the [BD-LIVE connection] option on the [Setup] menu (page 41).

Depending on the disc, the BD-LIVE function may not operate if [BD-LIVE connection] option is set to [Partially Permitted].

4. Insert a BD-ROM with BD-LIVE.

The operations may differ depending on the disc. Refer to the manual supplied with the disc.



### CAUTION

Do not extract the connected USB device while content is being downloaded or a Blu-ray disc is still in the disc tray. Doing so may damage the connected USB device and BD-LIVE features may not operate properly with the damaged USB device anymore. If the connected USB device seems damaged from such an action, you can format the connected USB device from the PC and reuse it with this unit.



### NOTE

- Some BD-LIVE contents may be restrictively accessed in some territories by contents provider's own decision.
- It may take up to several minutes to load and start enjoying BD-LIVE contents.

## Playing movie file and VR discs

You can play DVD-RW discs that are recorded in Video Recording (VR) format and movie files contained on a disc/USB device.

1. Press HOME (🏠).

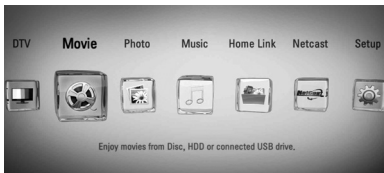

2. Select [Movie] using </>, and press ENTER (⊙).
3. Select [Disc] or [USB] option using </>, and press ENTER (⊙).



This step is needed only when a disc or a USB device is connected on this unit.

While navigating [Movie], [Photo] or [Music] menu, press green (G) colored button to change the device. (DISC, USB or HDD)

4. Select a file using ^/v/</>, and press ► (PLAY) or ENTER (⊙) to play the file.

### NOTE

- The file requirements are described on page 10.
- You can use various playback functions. Refer to pages 54-60.
- Unfinalized DVD VR format discs may not be played in this player.
- Some DVD-VR discs are made with CPRM data by DVD RECORDER. This unit cannot support these kinds of discs.

#### What is CPRM?

CPRM is a copy protection system (with scramble system) only allowing the recording of 'copy once' broadcast programs. CPRM stands for Content Protection for Recordable Media.

## Selecting a subtitle file

### MOVIE

If a movie file name and the subtitle file name are the same, subtitle file is played automatically when playing the movie file.

If the subtitle file name is different from the movie file name, you need to select the subtitle file on the [Movie] menu before playing the movie.

1. Use ^/v/</> to select the subtitle file you wish to play in the [Movie] menu.
2. Press ENTER (⊙).



3. Press ENTER (⊙) again to deselect the subtitle file. Selected subtitle file will be displayed when you play the movie file.

**NOTE**

If you press ■ (STOP) during playback, the subtitle selection is cancelled.

**Changing subtitle code page**

**MOVIE MOVIE-N**

If the subtitle is not displayed properly, you can change the subtitle code page to view the subtitle file properly.

1. During playback, press INFO/DISPLAY (i) to display the On-Screen display.
2. Use ^/V to select the [Code Page] option.
3. Use </> to select desired code option.

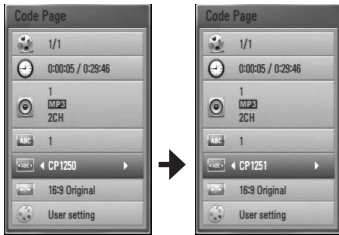

4. Press RETURN (↵) to exit the On-Screen display.

**Viewing a photo**

You can view photo files using this player.

1. Press HOME (🏠).



2. Select [Photo] using </>, and press ENTER (⊙).
3. Select [Disc] or [USB] option using </>, and press ENTER (⊙).

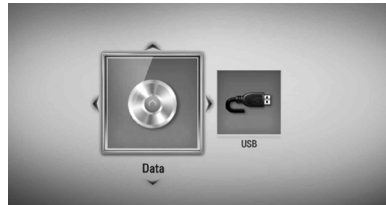

This step is needed only when a disc or a USB device is connected on this unit.

While navigating [Movie], [Photo] or [Music] menu, press green (G) colored button to change the device. (DISC or USB)

4. Select a file using ^/V/</>, and press ENTER (⊙) to view the photo in full screen.

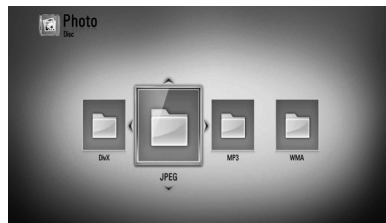

4

Operation

**To play a slide show**

Press ► (PLAY) to start the slide show.

**To stop a slide show**

Press ■ (STOP) during slide show.

**To pause a slide show**

Press || (PAUSE) during slide show.  
Press ► (PLAY) to re-start the slide show.

**To skip to the next/previous photo**

While viewing a photo in full screen, press < or > to go to the previous or next photo.

**NOTE**

- The file requirements are described on page 10.
- You can use various playback functions. Refer to pages 54-60.

4

Operation

**Options while viewing a photo**

You can use various options while viewing a photo in full screen.

1. While viewing a photo in full screen, press INFO/DISPLAY (ⓘ) to display the option menu.
2. Select an option using ▲/▼.

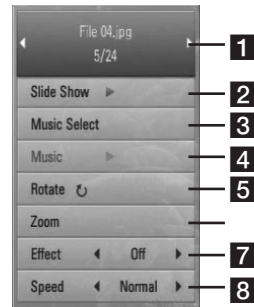

**1 Current photo/Total number of photos**  
– Use </> to view previous/next photo.

**2 Slide Show** – Press ENTER (Ⓢ) to start or pause slide show.

**3 Music Select** – Select the background music for the slide show (page 65).

**4 Music** – Press ENTER (Ⓢ) to start or pause background music.

**5 Rotate** – Press ENTER (Ⓢ) to rotate the photo clockwise.

**6 Zoom** – Press ENTER (Ⓢ) to display the [Zoom] menu.

**7 Effect** – Use </> to select a transition effect between photos in a slide show.

**8 Speed** – Use </> to select a delaying speed between photos in a slide show.

3. Press RETURN (↵) to exit the option menu.



## Listening to music during a slide show

You can display photo files while listening to music files.

1. Press HOME (🏠).



2. Select [Photo] or [Home Link] using </>, and press ENTER (⊙).
3. Select [Disc] or [USB] option using </>, and press ENTER (⊙).

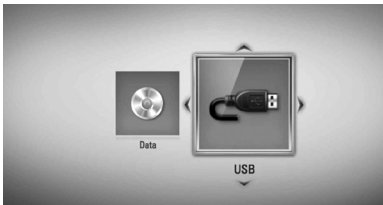

Selecting a server or a share folder is needed for [Home Link] menu.

4. Select a file using ^/v/</>, and press ENTER (⊙) to view the photo.
5. Press INFO/DISPLAY (ℹ) to display the option menu.
6. Use ^/v to select [Music Select] option, and press ENTER (⊙) to display the [Music Select] menu.

7. Use ^/v to select a device, and press ENTER (⊙).

Devices that you can select may differ depending on the location of the photo file you are displaying in full screen.

Photo location	Available Device
Disc	Disc, USB
USB	Disc, USB
Share Folder on your PC (CIFS)	CIFS
DLNA server	DLNA server

8. Use ^/v to select a file or a folder you wish to play.

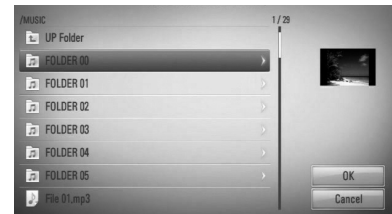

Select a folder and press ENTER (⊙) to display the lower directory.

Select [⏪] and press ENTER (⊙) to display the upper directory.

**NOTE**

When selecting music from [Home Link], folder selection is not available. Only file selection is available on the [Home Link].

9. Use > to select [OK], and press ENTER (⊙) to complete music selection.

## Listening to music

This player can play Audio CDs and music files.

1. Press HOME (🏠).



2. Select [Music] using </>, and press ENTER (⊙).
3. Select the [Disc] or [USB] option using </>, and press ENTER (⊙).

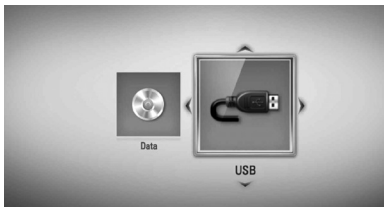

This step is needed only when a disc or a USB device is connected on this unit.

While navigating [Movie], [Photo] or [Music] menu, press green(G) colored button to change the device. (DISC or USB)

4. Select a music file or audio track using  $\wedge/\vee$ / $\leftarrow/\rightarrow$ , and press ENTER (⊙) to play the music.



### NOTE

- The file requirements are described on page 10.
- You can use various playback functions. Refer to pages 54-60.

## Audio CD Recording

You can record one desired track or all of the tracks in Audio CD to the USB storage device.

1. Press OPEN/CLOSE (▲), and place an Audio CD on the disc tray.  
Press OPEN/CLOSE (▲) to close the disc tray. The playback starts automatically.
2. Press INFO/DISPLAY (□) to display the option menu.
3. Use  $\wedge/\vee$  to select [CD Recording] option, and press ENTER (⊙) to display the [CD Recording] menu.
4. Use  $\wedge/\vee$  to select a track you wish to copy on the menu, and press ENTER (⊙).



Repeat this step to select tracks as many as you can.

Select All	Select all the tracks on an Audio CD.
Option	Selects an encoding option from the pop-up menu (128 kbps, 192 kbps, 320 kbps or Lossless).
Close	Cancels the recording and returns to the previous screen.

5. Use  $\wedge/V/</>$  to select [Start], and press ENTER (⊙).
6. Select the [USB] option using  $</>$ , and press ENTER (⊙).  
This step is needed only when a USB storage device is connected.
7. Use  $\wedge/V/</>$  to select a destination folder to be copied, and press ENTER (⊙).  
If you want to create a new folder, use  $\wedge/V/</>$  to select [New Folder] and press ENTER (⊙).  
Enter folder name using virtual keyboard, and press ENTER (⊙) while [OK] is selected.
8. Use  $\wedge/V/</>$  to select [OK], and press ENTER (⊙) to start Audio CD recording.  
If you want to stop in progressing Audio CD recording, press ENTER (⊙) while [Cancel] is highlighted.
9. A message appears when Audio CD recording is completed.  
Press ENTER (⊙) to check the audio file created in the destination folder.



**NOTE**

- The table below shows the average recording time from an audio track with 4 minutes of playback time to an audio file with 192kbps as an example.

Device \ Status	stop mode	while playback
USB	1.4 min.	2 min.

- All times in the above table are approximate.
- Actual recording time for USB storage device varies depending on the USB storage device's ability.
- Make sure that there is minimum of 50MB free space is needed when recording into the USB storage device.
- The length of the music should be longer than 20 seconds for the proper recording.
- Do not turn off this player or extract the connected USB storage device during Audio CD recording.

The making of unauthorized copies of copy-protected material, including computer programs, files, broadcasts and sound recordings, may be an infringement of copyrights and constitute a criminal offense.

This equipment should not be used for such purposes.

**Be responsible  
Respect copyrights**

## Viewing information from Gracenote Media Database

The player can access the Gracenote Media Database and loads the music information so that Track name, Artist Name, Genre and other text information can be displayed on the list.

### Audio CD

When you insert an Audio CD, the player starts playback automatically and load the music title from the Gracenote Media Database.

If there is no music information in the database, music titles will not be displayed on the screen.

### Music file

1. Select a music file using  $\wedge/V/</>$ .
2. Press INFO/DISPLAY (I) to display the option menu.
3. Select the [Information] option using  $\wedge/V$ , and press ENTER (C).

The player accesses Gracenote Media Database for the music information.

### BD/DVD/Movie file

While listening to music from the movie being played, press MUSIC ID to start loading the music information from the Gracenote Media Database.

## ! NOTE

- The player must be connected to the broadband internet for accessing the Gracenote Media Database.
- If the music information is not in the Gracenote Media Database, message appears on the screen.
- If the information from the Gracenote Media Database is either not correct or does not exist, please contact [www.gracenote.com](http://www.gracenote.com) for support.
- Depending on the cases, it will takes a few minutes to load music information from the Gracenote Media Database.
- Information may be displayed in broken letters, if the language you selected is not available on the Gracenote Media Database.
- This function is not available for NetCast on-line content and content in DLNA servers.
- LG is a licensee of Gracenote technology and is not responsible or reliable for information from the Gracenote Media Database.
- Audio CDs that users made for their only private purposes cannot be supported in this feature because they are not in the Gracenote Media Database.

# Playing content via your home network (Home Link)

The player can browse and play content on your PC and DLNA certified media servers connected on your home network.

## About DLNA

This Player is a DLNA Certified digital media player that can display and play movie, photo and music content from your DLNA-compatible digital media server (PC and Consumer Electronics).

The Digital Living Network Alliance (DLNA) is a cross-industry organization of consumer electronics, computing industry and mobile device companies. Digital Living provides consumers with easy sharing of digital media through a wired or wireless network in the home.

The DLNA certification logo makes it easy to find products that comply with the DLNA Interoperability Guidelines. This unit complies with DLNA Interoperability Guidelines v1.5.

When a PC running DLNA server software or other DLNA compatible device is connected to this player, some setting changes of software or other devices may be required. Please refer to the operating instructions for the software or device for more information.

## Accessing a DLNA media server

1. Check the network connection and settings (pages 20-25).
2. Press HOME (🏠).
3. Select [Home Link] using </>, and press ENTER (⊙).
4. Select a DLNA media server from the list using ▲/▼, and press ENTER (⊙).



If you want to rescan available media server, press the green (G) coloured button.

**NOTE**  
Depending on the media server, this player may need to get permission from the server.

5. Select a file using ▲/▼/</>, and press ENTER (⊙) to play the file.



4

Operation

**NOTE**

- The file requirements are described on page 10.
- You can use various playback functions. Refer to pages 54-60.
- Because the compatibility and available playback functions on the [Home Link] menu are tested on the bundle DLNA server (Nero MediaHome 4 Essentials) environment, file requirements and playback functions on the [Home Link] menu may differ depending on media servers.
- The file requirements on page 10 are not always compatible. There may have some restrictions by file features and media server's ability.
- The thumbnail of the unplayable files can be displayed in the [Home Link] menu, but those cannot be played on this player.
- If there is an unplayable music file in the [Home Link] menu, the player will skip the file and play the next file.
- Playing movie subtitle files is only possible on DLNA media server created by supplied Nero MediaHome 4 Essentials software on this player package.
- The subtitle file name and movie file name have to be the same and located in the same folder.
- The playback and operating quality of the [Home Link] function may be affected by your home network condition.
- The files from removable media such as USB drive, DVD-drive etc. on your media server may not be shared properly.

**About Nero MediaHome 4 Essentials**

Nero MediaHome 4 Essentials is a software for sharing movie, music and photo files stored on your computer to this player as a DLNA-compatible digital media server.

**NOTE**

- The Nero MediaHome 4 Essentials CD-ROM is designed for PCs and should not be inserted in this player or in any product other than a PC.
- The supplied Nero MediaHome 4 Essentials CD-ROM is a customized software edition only for sharing files and folders to this player.
- The supplied Nero MediaHome 4 Essentials software does not support the following functions: Transcoding, Remote UI, TV control, Internet services and Apple iTunes
- This manual explains operations with the English version of Nero MediaHome 4 Essentials as examples. Follow the explanation referring to the actual operations of your language version.

**Installing Nero MediaHome 4 Essentials**

Before you install Nero MediaHome 4 Essentials, check the system requirement shown below.

- Windows® XP (Service Pack 2 or higher), Windows Vista® (no Service Pack required), Windows® XP Media Center Edition 2005 (Service Pack 2 or higher), Windows Server® 2003
- Windows Vista® 64-bit edition (application runs in 32-bit mode)
- Hard drive space: 200 MB hard drive space for a typical installation of Nero MediaHome stand-alone
- 1.2 GHz Intel® Pentium® III or AMD Sempron™ 2200+ processors
- Memory: 256 MB RAM

- Graphics card with at least 32 MB video memory, minimum resolution of 800 x 600 pixels, and 16-bit colour settings
- Windows® Internet Explorer® 6.0 or higher
- DirectX® 9.0c revision 30 (August 2006) or higher
- Network environment: 100 Mb Ethernet, WLAN (IEEE 802.11b/g/n)

Start up your computer, and insert the Nero MediaHome 4 Essentials CD-ROM into your computer's CD-ROM drive. An installation wizard will walk you through the quick and uncomplicated installation process. To install Nero MediaHome 4 Essentials, proceed as follows:

1. Close all Microsoft Windows programs and exit any anti-virus software that may be running.
2. Insert the Nero MediaHome 4 Essentials CD-ROM into your computer's CD-ROM drive.
3. Click [Nero MediaHome 4 Essentials]. The installation is prepared and the installation wizard appears.
4. Click the [Next] button to display the serial number input screen. Click [Next] to go to the next step.
5. If you accept all conditions, click [I accept the License Conditions] check box and click [Next]. Installation is not possible without this agreement.
6. Click [Typical] and click [Next]. The installation process is started.
7. If you want to take part in the anonymous collection of data, select the check box and click the [Next] button.
8. Click the [Exit] button to complete the installation.

## Sharing files and folders

On your computer, you must share the folder that contains the movie, music and/or photo content to play them using [Home Link] features.

This part explains the procedure for selecting the shared folders on your computer.

1. Double-click the "Nero MediaHome 4 Essentials" icon on the desktop.
2. Click [Network] icon on the left and define your network name in the [Network name] field. The Network name you enter will be recognized by your player.
3. Click [Shares] icon on the left.
4. Click [Local Folders] tab on the [Shares] screen.
5. Click [Add] icon to open the [Browse Folder] window.
6. Select the folder containing the files you want to share. The selected folder is added to the list of shared folders.
7. Click [Start Server] icon to start the server.

### NOTE

- If the shared folders or files are not displayed on the player, click the folder on the [Local Folders] tab and click [Rescan Folder] at the [More] button.
- Visit [www.nero.com](http://www.nero.com) for more information and software tools

## Accessing a share folder from your PC

1. Start your PC that is connected on your local area network.
2. On your PC, share folders which contain movie, photo or music files.
3. On the player, check the network connection and settings (pages 20-25).
4. Press HOME (🏠).
5. Select [Home Link] using </>, and press ENTER (⊙).
6. Select a share folder from the list using ▲/▼, and press ENTER (⊙).



If you want to rescan available share folders, press the green (G) coloured button.

### NOTE

Depending on the share folder, this player may need to input network user ID and password for accessing the folder.

7. Select a file using ▲/▼/</>, and press ENTER (⊙) to play the file.

### NOTE

- The file requirements are described on page 10.
- You can use various playback functions. Refer to pages 54-60.
- The thumbnail of the unplayable files can be displayed in the [Home Link] menu, but those cannot be played on this player.
- If there is an unplayable music file in the [Home Link] menu, the player will skip the file and play the next file.
- The subtitle file name and movie file name have to be the same and located at the same folder.
- The playback and operating quality of the [Home Link] function may be affected by your home network condition.
- The files on a removable media such as USB drive, DVD-drive etc. on your PC may not be shared properly.
- You may experience connection problems depending on your PC's environment.

### PC requirements

- Windows® XP (Service Pack 2 or higher), Windows Vista® (no Service Pack required) Windows 7® (no Service Pack required)
- 1.2 GHz Intel® Pentium® III or AMD Sempron™ 2200+ processors
- Network environment: 100 Mb Ethernet, WLAN (IEEE 802.11 b/g/n)

### NOTE

If you use Windows® XP or Windows Vista®, visit link below for more information on file share settings.

**Windows® XP:**

<http://support.microsoft.com/kb/304040>

**Windows Vista®:**

<http://support.microsoft.com/kb/961498>



### Entering a network user ID and the password

Depending on your PC's environment, you may need to enter a network user ID and the password for accessing a shared folder.

1. The virtual keyboard appears automatically if the network user ID and the password are required.
2. Use  $\wedge/\vee/ </>$  to select a character then press ENTER (Ⓢ) to confirm your selection on the virtual keyboard.

To enter a letter with an accent mark, select the letter from the extended character set.

Example: Select "D" and then press INFO/DISPLAY (Ⓢ) to display the extended character set. Use  $</>$  to select "D" or "Đ" and then press ENTER (Ⓢ).



- [Clear]** – Clear all entered characters.
- [Space]** – Inserts a space at the cursor position.
- [<-]** – Deletes the previous character at the cursor position.
- [ABC / abc / #+=&]** – Change the keyboard menu settings to capital letters, small letters or symbols.

3. When you finish entering the network user ID and password, select [OK] using  $\wedge/\vee/ </>$  and press ENTER (Ⓢ) to access the folder. The network user ID and password will be remembered after accessing the folder for your convenience. If you do not want the network user ID and password to be remembered, press red (R) coloured button to un-tick the [Remember] check box before accessing the folder.

## Using the NetCast™ Entertainment Access

You can use various content services via Internet with the NetCast Entertainment Access feature.

1. Check the network connection and settings (pages 20-25).
2. Press HOME (🏠).
3. Select the [NetCast] using  $</>$ , and press ENTER (Ⓢ).
4. Select an option using  $</>$ , and press ENTER (Ⓢ).

- maxdome** – See page 74-75
- YouTube™** – See page 75-78
- Picasa™ Web Albums** – See page 78-80
- AccuWeather** – See page 81-82

5. While enjoying on-line content from NetCast, press blue (B) colored button to go to the NetCast Home screen.

**NOTE**

- Using NetCast features with wireless network connection may result in improper streaming speed due to interference from household devices that are using radio frequencies.
- The background image on the NetCast home indicates the weather of your favorite city in the AccuWeather feature.

## Playing maxdome videos

# maxdome

You can browse, search and watch movies & TV episodes from maxdome streamed over the Internet to your TV via your LG unit.

### Registration

You have to be signed up at maxdome before using the online video store to watch movies streamed over the Internet from maxdome.

1. To watch movies and TV episodes instantly from maxdome, you must be a maxdome member.

If you are already a member of maxdome, this step is not needed.

On your computer, visit:

**[www.maxdome.de/LG](http://www.maxdome.de/LG)**

Follow the instructions to become a maxdome member.

2. On the television screen, select the [maxdome] option in the [NetCast] menu using  $\triangleleft/\triangleright$ , and press ENTER (⊙).

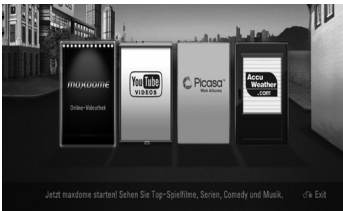

3. Select [Login] using  $\triangleleft/\triangleright$ , and press ENTER (⊙).

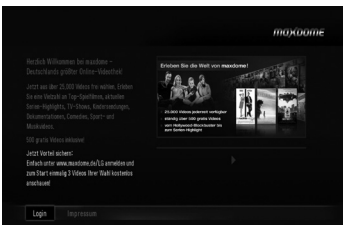

4. Enter your access data (E-mail and password) at [Benutzername] and [Passwort] fields using the virtual keyboard.



5. Press ENTER (⊙) while [Anmelden] button is highlighted.

### NOTE

- If you do not have a maxdome account, please visit the [www.maxdome.de/LG](http://www.maxdome.de/LG) to use the maxdome.

- If the playback of maxdome videos occur to pause, stop or buffer then take a look on your broadband speed.

We recommend a minimum connection speed of SD 1.5 Mbps, HD 6 Mbps. Sometimes your broadband speed varies based on your ISP's network conditions. Contact your ISP if you have problems maintaining a fast connection that is reliable, or if you want to increase your connection speed. Many ISPs offer a variety of broadband speed options.

Button	Operation
▶	Starts playing the movie
△/▽/◀/▶	Navigates on-screen displays.
⏸	To pause a video while it is playing. To resume playing a paused video, press ▶ again.
ENTER (⊙)	Displays the video quality indicator and progress bar on the screen.
■	Stops the video and displays related videos list.

### About maxdome menu

After logging in, you are ready to use the maxdome service.

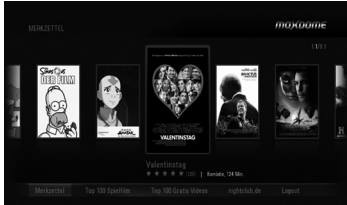

**Merkzettel** – Displays the movies you have added to your marked maxdome videos. You can buy, rent or remove videos from the list.

**Top 100 Spielfilm** – Displays the top 100 movies rented or purchased on the service.

**Top 100 Gratis Videos** – Displays the top 100 free movies on the service.

**Suche** – Search through all videos in the maxdome service.

**nightclub.de** – To use this tab, you should get a PIN from [www.verify-u.de](http://www.verify-u.de).

**Logout** - Press ENTER (⊙) while this option is selected and you will be logged out from your account in the maxdome service.

#### NOTE

- More than 25 000 videos can be found on the web site: [www.maxdome.de](http://www.maxdome.de). Insert your favorite videos easily on [Merkzettel] menu and see the contents easily on your TV or search directly on the tele vision screen for videos.

### Playing YouTube™ videos

You can browse, search and watch YouTube™ videos over the internet on your TV via your LG unit.

#### Watch YouTube™ videos on your TV

1. On the player, select the [YouTube™] option in the [NetCast] menu using </>, and press ENTER (⊙).
2. Press ^ to select the option menu bar.
3. Use </> to select an option and press ENTER (⊙) to search for videos.
4. Use </> to select a video and press ENTER (⊙) or ► (play) to play the video.

Button	Operation
► or ENTER (⊙)	Starts playback of the video with content detail.
INFO/ DISPLAY (Ⓛ)	Toggle between playback in full screen and playback screen with content detail.
	To pause a video while it is playing. To resume playing a paused video, press ► again.
■	Stops the video and displays related videos list.
⏮/⏭	Skip the playback forward or backward .

## 4

Operation

## About the YouTube™ menu

There are various options on the YouTube™ menu. Use  $\wedge/\vee/\lt;/\gt$  to select an option and press ENTER (⊙) to select the options as described below.

---

**Featured** – The featured videos list will be displayed.

---

**Recent Videos** – The most recently updated videos list will be displayed.

---

**Most Viewed** – The most viewed videos list will be displayed. The period option appears at the bottom of the screen.

---

**Top Rated** – The best rated videos list from YouTube™ server will be displayed. The period option appears at the bottom of the screen.

---

**Search** – The virtual keyboard will be displayed. See “Searching videos” on page 77 for more detail.

---

**History** – The videos list that you previously played on this unit will be displayed. Maximum of 25 videos can be stored.

---

**Favorites** – This option will only appear when the unit is in sign-in status. Displays the videos list that is arranged in the YouTube™ server with your account. Some videos may not appear on the [Favorites] list, even if the videos are arranged in the server.

---

**Sign in (Sign Out)** – Displays the virtual keyboard to sign in or returns to the sign-out status. See “Sign in with your YouTube™ account” on page 77-78 for more details.

---

**Local site** – Choose which country’s videos you would like to view. The countries listed on the [Local Site] menu may differ from those listed on the YouTube™ web site.

---

## NOTE

- The YouTube™ menu can display 5 videos in the videos list. Press green (G) or yellow (Y) buttons to display previous/next 5 videos.
- If you select the [Most Viewed] or [Top Rated] option in the YouTube™ menu, the period options appear at the bottom of the screen. Use  $\wedge/\vee/\lt;/\gt$  to select a period option and press ENTER (⊙) to display the videos list within the selected period.
- The videos list located using the player may be different from the when searching via a PC on PC.
- The playback of YouTube™ videos may be paused, stopped or buffering occurring often depending on your broadband speed. We recommend a minimum connection speed of 1.5 Mbps. For the best playback condition, a connection speed of 4.0 Mbps is required. Sometimes your broadband speed varies based on your ISP’s network conditions. Contact your ISP if you have problems maintaining a fast connection that is reliable, or if you want to increase your connection speed. Many ISPs offer a variety of broadband speed options.

## Using the virtual keyboard

On the virtual keyboard, there are two input modes for the entering a character. Press the yellow (Y) coloured button to toggle the display between keyboard mode and keypad mode.

### Keyboard Mode

Use  $\wedge/\vee/\lt;/\gt$  to select a letter on the screen, and press ENTER (⊙) to confirm your selection.



**[Cancel]** – Returns to the previous screen.



**[Space]** – Inserts a space at the cursor position.

**[Backspace]** – Deletes the previous character at the cursor position.

**[ABC / abc / #+==&]** – Changes the virtual keyboard settings to capital letters, small letters or symbols.

Press CLEAR to clear all entered characters.

To enter a letter with an accent mark:

1. Select a letter using **</>** on the virtual key board.
2. Press **INFO/DISPLAY** (  ) to display the extended character set.
3. Use **</>** to select a character then press **ENTER** (  ).

Available languages to enter on the keyboard mode are as follows: English, Spanish, Italian, French, German, Dutch, Portuguese, Swedish, Polish and Czech.

### Keypad Mode

This mode allows you to enter letters by pressing the buttons on the remote control. Press the buttons with the required letter once, twice, three or four times until the letter is displayed.



Button	Operation
CLEAR	Deletes the previous character at the cursor position.
REPEAT	Inserts a space at the cursor position.



Changes the character set of the remote control (#+==&, 123, ABC or abc)



### NOTE

The keypad mode is available only in the [YouTube™] and [Picasa™ Web Albums] features.

### Searching videos

You can search for videos by entering search words of up to 128 characters.

1. Use **</>** to select [Search] option from the menu and press **ENTER** (  ) to display the virtual keyboard.

Refer to “Using the virtual keyboard” on page 81 for using virtual keyboard.



When you are entering a character, maximum of 5 suggestion words will be displayed.

2. When you finish entering the search words, select [OK] and press **ENTER** (  ) to display the related video list.

### Sign in with your YouTube™ account

To watch videos from your [Favorites] video list on the YouTube™ server with your account, you need to sign in with your YouTube™ account.

1. Use **</>** to select [Sign In] option from the menu and press **ENTER** (  ) to display the virtual keyboard.



2. Use  $\wedge/V/</>$  to select a character then press ENTER (⊙) to confirm your selection on the virtual keyboard.  
Refer to "Using the virtual keyboard" on page 77-78 for using virtual keyboard.
3. When you finish entering the user name and the password, select [OK] and press ENTER (⊙) to sign in.
4. If you want to sign out, select the [Sign Out] from the YouTube™ menu and press ENTER (⊙).

This unit can automatically store up to 5 username which were previously signed-in. The username list appears when you select the [Sign In] option.

Select a stored username on the list and press ENTER (⊙) to display the keyboard menu with the selected username entered. You will then only need to enter the password to sign in.

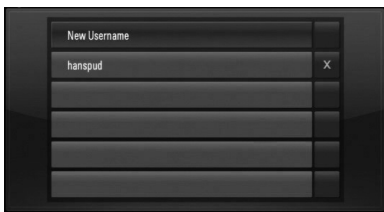

Select the [X] symbol and press ENTER (⊙) to delete the stored username.

## Viewing Picasa™ Web Albums



Enjoy photo albums from friends and family on the Picasa™ on-line service.

### View Picasa™ Web Albums on your TV

1. On the player, select the [Picasa™ Web Albums] option in the [NetCast] menu using  $</>$ , and press ENTER (⊙).  
Featured photos are displayed on the screen.
2. Use  $\wedge/V/</>$  to select a photo and press ENTER (⊙) to view the photo in full screen.

Button	Operation
▶	Starts a slide show.
INFO/ DISPLAY ⊞	Displays the photo option menu.
	Pauses a slide show. To resume slide show, press ▶ again.
■	Stops the slide show and return to the Picasa™ menu.
</>	Moves to the next or previous photo.

### Options while viewing a photo

You can use various options during viewing a photo in full screen.

1. While viewing a photo in full screen, press INFO/DISPLAY (⊞) to display the option menu.
2. Select an option using  $\wedge/V$ .

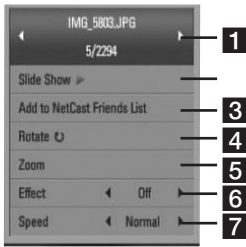

- 1 Current photo/Total number of photos** – Use </> to view previous/next photo.
- 2 Slide Show** – Press ENTER (⊙) to start or pause slide show.
- 3 Add to NetCast Friends List** – Add the current photo owner to my friend list.
- 4 Rotate** – Press ENTER (⊙) to rotate the photo clockwise.
- 5 Zoom** – Press ENTER (⊙) to display the [Zoom] menu.
- 6 Effect** – Use </> to select a transition effect between photos in a slide show.
- 7 Speed** – Use </> to select a delay time between photos in a slide show.

3. Press RETURN (↵) to exit the option menu.

### About the Picasa™ menu

There are various options on the Picasa™ menu. Use ^/V/</> to select an menu option and press ENTER (⊙) to select the options as described below.

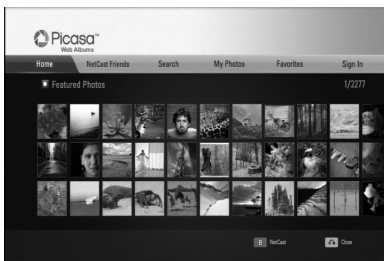

**Home** – The featured photo list will be displayed.

**NetCast Friends** – List of your friends will be displayed.

**Search** – Enter a search word to find related photos. The virtual keyboard will be displayed (page 80).

**My Photos** – Displays the photos organized in my Picasa™ Web Albums. This option is available only when the unit is in sign-in status.

**Favorites** – Displays up to 50 favorite web albums that are arranged in the Picasa™ web server with your account. This option is available only when the unit is in sign-in status.

**Sign in (Sign Out)** – Displays the virtual keyboard to sign in or returns to the sign-out status (page 80)



### NOTE

Photos displayed in [My Photos] and [Favorites] may differ from the photos from a web browser on PC.

4

Operation

### Adding friends

If you add your friends on the [NetCast Friends] menu, you can see the photos of your friend's public photos directly.

1. Select the [NetCast Friends] on the Picasa™ menu using ^/V/</>, and press ENTER (⊙).

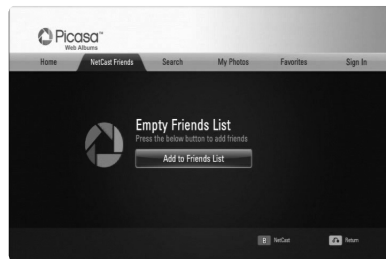

2. Press ENTER (⊙) to display the virtual keyboard.

- Enter a name using the virtual keyboard.  
Refer to "Using the virtual keyboard" on page 76-77 for using virtual keyboard.
- Select [OK] using  $\wedge/V/</>$ , and press ENTER (⊙) to display the web album of your friend.

### NOTE

- If you want to delete your friend from the list, press green (G) coloured button while the web album is selected.
- If you want to add more friends, press red (R) coloured button on the list.
- You can add more web albums of your friends up to 50.

## 4

### Operation

### Searching photos

You can enter a search word to find related photos.

- Select the [Search] on the Picasa™ menu using  $\wedge/V/</>$ , and press ENTER (⊙).
- Enter a search word using the virtual keyboard.  
Refer to "Using the virtual keyboard" on page 76-77 for using virtual keyboard.
- Select [OK] using  $\wedge/V/</>$ , and press ENTER (⊙) to display the search result.

### NOTE

The search result from the player may differ from the result when searched from a web browser on PC.

### Signing in with your account

To display photos in your web album on the screen, you need to sign in with your Picasa™ account.

- Select the [Sign In] on the Picasa™ menu using  $\wedge/V/</>$ , and press ENTER (⊙).

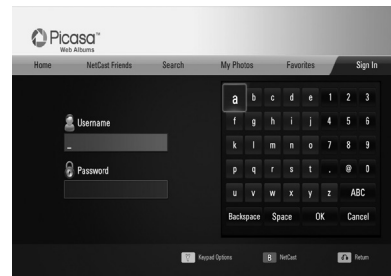

- Enter your user name using the virtual keyboard, and press ENTER (⊙) while [OK] is selected.

Refer to "Using the virtual keyboard" on page 76-77 for using the virtual keyboard.

- Enter the password using the virtual keyboard, and press ENTER (⊙) while [OK] is selected.

Your web album is displayed on the screen.

- If you want to sign out, select the [Sign Out] from the Picasa™ menu and press ENTER (⊙).

This unit can automatically store up to 5 usernames which were previously signed-in. The username list appears when you select the [Sign In] option.

Select a stored user name on the list and press ENTER (⊙) to display the virtual keyboard with the selected user name is entered. You will then only need to enter the password to sign in.

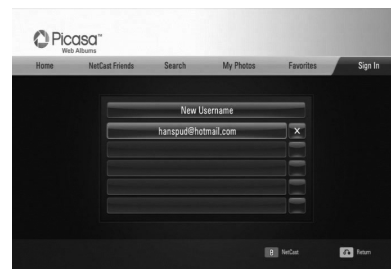

- Select the [X] symbol and press ENTER (⊙) to delete the stored user name.



## Using the AccuWeather



See on-line local and global weather forecasts from AccuWeather.com.

### Viewing weather information

1. On the player, select the [AccuWeather] option in the [NetCast] menu using </>, and press ENTER (⊙).

The city selection menu appears on the screen.



2. Press ENTER while [Add City to Favorite City List] is selected.
3. Select a region using ^/V, and press ENTER (⊙).

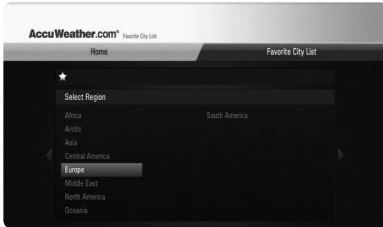

4. Select a country using ^/V/</>, and press ENTER (⊙).
5. Select a city using ^/V/</>, and press ENTER (⊙).

6. Use ^/V/</> to select [Home] and press ENTER (⊙) to display weather information of the selected city.



Press red (R) coloured button to toggle display between Fahrenheit or Celsius thermometer.

7. Use </> to select previous or next city, and press ENTER (⊙) to display the weather information.

This step works only when you add more than 1 city to the [Favorite city List].

### NOTE

- The weather information is not always correct.
- The weather information may be displayed in English, if your own language is not available on the AccuWeather service.

4

Operation

### Adding more cities

1. Use </> to select [Favorite City List] on the AccuWeather menu, and press ENTER (⊙).



2. Press ENTER (⊙) while [Add City to Favorite City List] is selected.

3. Select a region, country and city using  $\wedge/\vee/</>$  and ENTER (⊙).
4. Repeats step 2-3 to add up to 5 cities.  
Select the [X] symbol and press ENTER (⊙) to delete the stored favorite city.
5. Use  $\wedge/\vee$  to select a city from the [Favorite City List], and press ENTER (⊙) to display the weather information.

# 5

## Maintenance

### Notes on Discs

#### Handling Discs

Do not touch the playback side of the disc. Hold the disc by the edges so that fingerprints do not get on the surface. Never stick paper or tape on the disc.

#### Storing Discs

After playing, store the disc in its case. Do not expose the disc to direct sunlight or sources of heat and never leave it in a parked car exposed to direct sunlight.

#### Cleaning Discs

Fingerprints and dust on the disc can cause poor picture quality and sound distortion. Before playing, clean the disc with a clean cloth. Wipe the disc from the centre to out.

Do not use strong solvents such as alcohol, benzene, thinner, commercially available cleaners, or anti-static spray intended for older vinyl records.

### Handling the Unit

#### When shipping the unit

Please save the original shipping carton and packing materials. If you need to ship the unit, for maximum protection, re-pack the unit as it was originally packed at the factory.

#### Keeping the exterior surfaces clean

- Do not use volatile liquids such as insecticide spray near the unit.
- Wiping with strong pressure may damage the surface.
- Do not leave rubber or plastic products in contact with the unit for a long period of time.

#### Cleaning the unit

To clean the player, use a soft, dry cloth. If the surfaces are extremely dirty, use a soft cloth lightly moistened with a mild detergent solution. Do not use strong solvents such as alcohol, benzene, or thinner, as these might damage the surface of the unit.

#### Maintaining the Unit

The unit is a high-tech, precision device. If the optical pick-up lens and disc drive parts are dirty or worn, the picture quality could be diminished. For details, please contact your nearest authorized service centre.

# 6

## Troubleshooting

### General

Symptoms	Cause & Solution
The Power does not turned on.	<ul style="list-style-type: none"> <li>Plug the power cord into the wall outlet securely.</li> </ul>
The unit does not start playback.	<ul style="list-style-type: none"> <li>Insert a playable disc. (Check the disc type, color system, and regional code.)</li> <li>Place the disc with the playback side down.</li> <li>Place the disc on the disc tray correctly inside the guide.</li> <li>Clean the disc.</li> <li>Cancel the Rating function or change the rating level.</li> </ul>
The angle cannot be changed.	<ul style="list-style-type: none"> <li>Multi-angles are not recorded on the DVD Video being played.</li> </ul>
Cannot play movie, photo or audio files.	<ul style="list-style-type: none"> <li>The files are not recorded in a format that the unit can play.</li> <li>The unit does not support the codec of the movie file.</li> </ul>
The remote control does not work properly.	<ul style="list-style-type: none"> <li>The remote control is not pointed at the remote sensor of the unit.</li> <li>The remote control is too far from the unit.</li> <li>There is an obstacle in the path between the remote control and the unit.</li> <li>The batteries in the remote control are exhausted.</li> </ul>

## Picture

Symptoms	Cause & Solution
There is no picture.	<ul style="list-style-type: none"> <li>• Select the appropriate video input mode on the TV so the picture from the unit appears on the TV screen.</li> <li>• Connect the video connection securely.</li> <li>• Check the [HDMI Color Setting] in the [Setup] menu is set to the appropriate item that conforms to your video connection.</li> <li>• Your TV may not support the resolution you have set on the unit. Change the resolution to one that your TV accepts.</li> <li>• The player's HDMI OUT jack is connected to a DVI device that does not support copyright protection.</li> </ul>
Picture noise appears	<ul style="list-style-type: none"> <li>• You are playing a disc recorded in a colour system that is different from your TV.</li> <li>• Set the resolution to one that your TV accepts.</li> </ul>

## Sound

Symptoms	Cause & Solution
There is no sound or the sound is distorted.	<ul style="list-style-type: none"> <li>• Connect the audio connection securely.</li> <li>• The input source setting on the amplifier or the connection to the amplifier is incorrect.</li> <li>• The unit is in scan, slow motion, or pause mode.</li> <li>• The sound volume is low.</li> <li>• Check that the connected amplifier is compatible with the audio format output from the player.</li> <li>• The player's HDMI OUT jack is connected to a DVI device. The DVI jack does not accept audio signal.</li> <li>• Check the device connected to the player's HDMI OUT jack is compatible with the audio format output from the unit.</li> </ul>

## Network

Symptoms	Cause & Solution
BD-LIVE feature does not work.	<ul style="list-style-type: none"> <li>The connected USB storage may not have enough space. Connect the USB storage with at least 1GB free space.</li> <li>Ensure that the unit is correctly connected to the local area network and can access the internet (see pages 20-25).</li> <li>Your broadband speed may not be fast enough to use the BD-Live features. Contact your Internet Service Provider (ISP) and increase the broadband speed to suit the unit's requirements.</li> <li>The [BD-LIVE connection] option in the [Setup] menu is set to [Prohibited]. Set the option to [Permitted].</li> </ul>
Streaming video services (such as YouTube™, etc.) are often stop or "buffer" during playback.	<ul style="list-style-type: none"> <li>Your broadband service speed may not be fast enough to stream video services. Contact your Internet Service Provider (ISP) and increase the broadband speed is recommended.</li> </ul>
Shared folder or files from your PC or a media server are not displayed on the [My Media] menu.	<ul style="list-style-type: none"> <li>The firewall or anti-virus software on your media server is running. Turn off the firewall or anti-virus software running on your PC or media server.</li> <li>The unit is not connected to the local area network that your PC or the media server are connected.</li> </ul>
Cannot connect the player to the access point or wireless LAN router.	<ul style="list-style-type: none"> <li>The wireless communication may be interrupted from household devices that are using radio frequencies. Move the player away from them.</li> </ul>
Access point is not displayed on the "Access point name" list.	<ul style="list-style-type: none"> <li>The access point or wireless LAN router may not broadcast its SSID. Set your access point to broadcast its SSID through your computer.</li> </ul>

6

Troubleshooting

### Customer Support

You can update the unit using the latest software to enhance the products operation and/or add new features. To obtain the latest software for this unit (if updates have been made), please visit <http://lgservice.com> or contact LG Electronics customer care centre.

## Recording

Symptoms	Solution
Cannot record or does not record successfully.	<ul style="list-style-type: none"> <li>• Check the remaining space on the external HDD.</li> <li>• If your source is copy-protected, you cannot record it using this recorder.</li> <li>• If you set a DTV rating for the recorder and higher rated digital programs are received, the programme cannot be recorded. Change the DTV rating level in order to record it.</li> </ul>
Timer record does not record successfully.	<ul style="list-style-type: none"> <li>• Clock is not set to correct time.</li> <li>• The start time of the timer recording is past.</li> <li>• Two timer recordings may have overlapped, in which case only the earlier one will record completely.</li> <li>• When setting the recording programme, make sure you set the recorder's built-in tuner, not the TV's built-in tuner.</li> <li>• If the HDD is damaged, the recording may not complete successfully.</li> </ul>
Stereo Audio Record and/ Playback is not present.	<ul style="list-style-type: none"> <li>• TV is not Stereo-compatible.</li> <li>• Broadcast programme is not in stereo format.</li> </ul>
You cannot enter a timer programme when.	<ul style="list-style-type: none"> <li>• A recording is already underway.</li> <li>• The time you're trying to set has already passed.</li> <li>• There are already 32 timer programs set.</li> </ul>
If you can not record.	<ul style="list-style-type: none"> <li>• Make sure you have connected an external HDD.</li> <li>• Make sure that the first partition is NTFS.</li> <li>• Make sure that an external USB HDD supports USB 2.0.</li> <li>• Disconnect and then reconnect the unit, please record again.</li> </ul>
If two or more timer programs overlap.	<ul style="list-style-type: none"> <li>• The earlier programme takes priority.</li> <li>• The recorder can record 1 channels simultaneously but do not make overlapping timer recordings, if you do, the earlier programme takes priority.</li> </ul>

# 7

## Appendix

### Controlling a TV with the Supplied Remote Control

You can control your TV using the buttons below.



By pressing	You can
⏻ (TV POWER)	Turn the TV on or off.
AV/INPUT	Switch the TV's input source between the TV and other input sources.
PR ▲/▼	Scan up or down through memorized channels.
VOL +/-	Adjust the volume of the TV

#### ! NOTE

Depending on the unit being connected, you may not be able to control your TV using some of the buttons.

### Setting up the remote to control your TV

You can operate your TV with the supplied remote control.

If your TV is listed in the table below, set the appropriate manufacturer code.

1. While holding down ⏻ (TV POWER) button, press the manufacturer code for your TV with the numerical buttons (see the table below).

Manufacturer	Code Number
LG	1(Default), 2
Zenith	1, 3, 4
GoldStar	1, 2
Samsung	6, 7
Sony	8, 9
Hitachi	4

2. Release the ⏻ (TV POWER) button to complete setting.

Depending on your TV, some or all buttons may not function on the TV, even after entering the correct manufacturer code. When you replace the batteries in the remote, the code number you have set may be reset to the default setting. Set the appropriate code number again.



## Area Code List

Choose an area code from this list.

Area	Code	Area	Code	Area	Code	Area	Code
Afghanistan	AF	Fiji	FJ	Monaco	MC	Singapore	SG
Argentina	AR	Finland	FI	Mongolia	MN	Slovak Republic	SK
Australia	AU	France	FR	Morocco	MA	Slovenia	SI
Austria	AT	Germany	DE	Nepal	NP	South Africa	ZA
Belgium	BE	Great Britain	GB	Netherlands	NL	South Korea	KR
Bhutan	BT	Greece	GR	Netherlands		Spain	ES
Bolivia	BO	Greenland	GL	Antilles	AN	Sri Lanka	LK
Brazil	BR	Hong Kong	HK	New Zealand	NZ	Sweden	SE
Cambodia	KH	Hungary	HU	Nigeria	NG	Switzerland	CH
Canada	CA	India	IN	Norway	NO	Taiwan	TW
Chile	CL	Indonesia	ID	Oman	OM	Thailand	TH
China	CN	Israel	IL	Pakistan	PK	Turkey	TR
Colombia	CO	Italy	IT	Panama	PA	Uganda	UG
Congo	CG	Jamaica	JM	Paraguay	PY	Ukraine	UA
Costa Rica	CR	Japan	JP	Philippines	PH	United States	US
Croatia	HR	Kenya	KE	Poland	PL	Uruguay	UY
Czech Republic	CZ	Kuwait	KW	Portugal	PT	Uzbekistan	UZ
Denmark	DK	Libya	LY	Romania	RO	Vietnam	VN
Ecuador	EC	Luxembourg	LU	Russian Federation	RU	Zimbabwe	ZW
Egypt	EG	Malaysia	MY	Saudi Arabia	SA		
El Salvador	SV	Maldives	MV	Senegal	SN		
Ethiopia	ET	Mexico	MX				

## Language code List

Use this list to input your desired language for the following initial settings: [Disc Audio], [Disc Subtitle] and [Disc Menu].

Language	Code	Language	Code	Language	Code	Language	Code
Afar	6565	French	7082	Lithuanian	7684	Sindhi	8368
Afrikaans	6570	Frisian	7089	Macedonian	7775	Singhalese	8373
Albanian	8381	Galician	7176	Malagasy	7771	Slovak	8375
Ameharic	6577	Georgian	7565	Malay	7783	Slovenian	8376
Arabic	6582	German	6869	Malayalam	7776	Spanish	6983
Armenian	7289	Greek	6976	Maori	7773	Sudanese	8385
Assamese	6583	Greenlandic	7576	Marathi	7782	Swahili	8387
Aymara	6588	Guarani	7178	Moldavian	7779	Swedish	8386
Azerbaijani	6590	Gujarati	7185	Mongolian	7778	Tagalog	8476
Bashkir	6665	Hausa	7265	Nauru	7865	Tajik	8471
Basque	6985	Hebrew	7387	Nepali	7869	Tamil	8465
Bengali; Bangla	6678	Hindi	7273	Norwegian	7879	Telugu	8469
Bhutani	6890	Hungarian	7285	Oriya	7982	Thai	8472
Bihari	6672	Icelandic	7383	Panjabi	8065	Tonga	8479
Breton	6682	Indonesian	7378	Pashto, Pushto	8083	Turkish	8482
Bulgarian	6671	Interlingua	7365	Persian	7065	Turkmen	8475
Burmese	7789	Irish	7165	Polish	8076	Twi	8487
Byelorussian	6669	Italian	7384	Portuguese	8084	Ukrainian	8575
Chinese	9072	Japanese	7465	Quechua	8185	Urdu	8582
Croatian	7282	Kannada	7578	Rhaeto-Romance		Uzbek	8590
Czech	6783	Kashmiri	7583		8277	Vietnamese	8673
Danish	6865	Kazakh	7575	Rumanian	8279	Volapük	8679
Dutch	7876	Kirghiz	7589	Russian	8285	Welsh	6789
English	6978	Korean	7579	Samoan	8377	Wolof	8779
Esperanto	6979	Kurdish	7585	Sanskrit	8365	Xhosa	8872
Estonian	6984	Laothian	7679	Scots Gaelic	7168	Yiddish	7473
Faroese	7079	Latin	7665	Serbian	8382	Yoruba	8979
Fiji	7074	Latvian, Lettish	7686	Serbo-Croatian	8372	Zulu	9085
Finnish	7073	Lingala	7678	Shona	8378		

## Trademarks and Licenses



"Blu-ray Disc", "Blu-ray" and "Blu-ray disc" logo are trademarks of Blu-ray Disc Association.



"Blu-ray 3D" and "Blu-ray 3D" logo are trademarks of Blu-ray Disc Association.



"BD-LIVE" logo is a trademark of Blu-ray Disc Association.

"BONUSVIEW" is trademark of Blu-ray Disc Association.



Java and all Java-based trademarks and logos are trademarks or registered trademarks of Sun Microsystems, Inc. in the United States and other countries.



Manufactured under license from Dolby Laboratories. Dolby and the double-D symbol are trademarks of Dolby Laboratories.



HIGH DEFINITION MULTIMEDIA INTERFACE

HDMI, the HDMI logo and High-Definition Multimedia Interface are trademarks or registered trademarks of HDMI licensing LLC.



"DVD Logo" is a trademark of DVD Format/Logo Licensing Corporation.



DLNA®, the DLNA Logo and DLNA CERTIFIED® are trademarks, service marks, or certification marks of the Digital Living Network Alliance.



"AVCHD" and the "AVCHD" logo are trademarks of Panasonic Corporation and Sony Corporation.



YouTube™ is a trademark of Google Inc.



Picasa™ Web Albums is a trademark of Google Inc.



Manufactured under license under U.S. Patent #'s: 5,451,942; 5,956,674; 5,974,380; 5,978,762; 6,226,616; 6,487,535; 7,212,872; 7,333,929; 7,392,195; 7,272,567 & other U.S. and worldwide patents issued & pending. DTS is a registered trademark and the DTS logos, Symbol, DTS-HD and DTS-HD Master Audio are trademarks of DTS, Inc. © 1996-2008 DTS, Inc. All Rights Reserved.



DivX is a registered trademark of DivX, Inc., and is used under license.



The Wi-Fi CERTIFIED Logo is a certification mark of the Wi-Fi Alliance.

"x.v.Colour" is a trademark of Sony Corporation.

consumption system in stand-by mode is built. Therefore, the small amounts of electricity are consumed even though the power plug is inserted.



Gracenote®, Gracenote logo and logotype, and the "Powered by Gracenote" logo are either registered trademarks or trademarks of Gracenote, Inc. in the United States and/or other countries.

Music recognition technology and related data are provided by Gracenote®.

Portions of the content is copyright © Gracenote or its providers.

**Gracenote® End User License Agreement**

This application or device contains software from Gracenote, Inc. of Emeryville, California ("Gracenote"). The software from Gracenote (the "Gracenote Software") enables this application to perform disc and/or file identification and obtain music-related information, including name, artist, track, and title information ("Gracenote Data") from online servers or embedded databases (collectively, "Gracenote Servers") and to perform other functions. You may use Gracenote Data only by means of the intended End-User functions of this application or device.

You agree that you will use Gracenote Data, the Gracenote Software, and Gracenote Servers for your own personal non-commercial use only. You agree not to assign, copy, transfer or transmit the Gracenote Software or any Gracenote Data to any third party. YOU AGREE NOT TO USE OR EXPLOIT GRACENOTE DATA, THE GRACENOTE SOFTWARE, OR GRACENOTE SERVERS, EXCEPT AS EXPRESSLY PERMITTED HEREIN.

You agree that your non-exclusive license to use the Gracenote Data, the Gracenote Software, and Gracenote Servers will terminate if you violate these restrictions. If your license terminates, you agree to cease any and all use of the Gracenote Data, the Gracenote Software, and Gracenote Servers. Gracenote reserves all rights in Gracenote Data, the Gracenote Software, and the Gracenote Servers, including all ownership rights. Under no circumstances will Gracenote become liable for any payment to you for any information that you provide. You agree that Gracenote, Inc. may enforce its rights under this Agreement against you directly in its own name.

The Gracenote service uses a unique identifier to track queries for statistical purposes. The purpose of a randomly assigned numeric identifier is to allow the Gracenote service to count queries without knowing anything about who you are. For more information, see the web page for the Gracenote Privacy Policy for the Gracenote service.

The Gracenote Software and each item of Gracenote Data are licensed to you "AS IS." Gracenote makes no representations or warranties, express or implied, regarding the accuracy of any Gracenote Data from in the Gracenote Servers. Gracenote reserves the right to delete data from the Gracenote Servers or to change data categories for any cause that Gracenote deems sufficient. No warranty is made that the Gracenote Software or Gracenote Servers are error-free or that functioning of Gracenote Software or Gracenote Servers will be uninterrupted. Gracenote is not obligated to provide you with new enhanced or additional data types or categories that Gracenote may provide in the future and is free to discontinue its services at any time.

GRACENOTE DISCLAIMS ALL WARRANTIES EXPRESS OR IMPLIED, INCLUDING, BUT NOT LIMITED TO, IMPLIED WARRANTIES OF MERCHANTABILITY, FITNESS FOR A PARTICULAR PURPOSE, TITLE, AND NON-INFRINGEMENT. GRACENOTE DOES NOT WARRANT THE RESULTS THAT WILL BE OBTAINED BY YOUR USE OF THE GRACENOTE SOFTWARE OR ANY GRACENOTE SERVER. IN NO CASE WILL GRACENOTE BE LIABLE FOR ANY CONSEQUENTIAL OR INCIDENTAL DAMAGES OR FOR ANY LOST PROFITS OR LOST REVENUES.

© Gracenote, Inc. 2009

# Network Software Update

## Network update notification

From time to time, performance improvements and/or additional features or services may be made available to units that are connected to a broadband home network. If there is new software available and the unit is connected to a broadband home network, the player will inform you about the update as follows.

### Option 1:

1. The update menu will appear on the screen when you turn on the player.
2. Use </> to select a desired option and then press ENTER (Ⓢ).

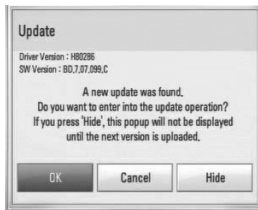

#### [OK]

Starts the software update.

#### [Cancel]

Exits the update menu and displays it next booting.

#### [Hide]

Exits the update menu and it does not appear until next software is uploaded in the update server.

### Option 2:

If the software update is available from the update server, the "Update" icon appears at the bottom of the Home menu. Press blue (B) coloured button to start the update procedure.

## Software Update

You can update the player using the latest software to enhance the products operation and/or add new features. You can update the software by connecting the unit directly to the software update server.



### CAUTION

- Before updating the software in your player, remove any disc and USB Device from the player.
- Before updating the software in your player, turn the player off and then turn it back on.
- **During the software update procedure, do not turn off the player or disconnect AC power, or do not press any button.**
- If you cancel the update, turn off the power and turn it on for stable performance.
- This unit cannot be updated to previous software version.

1. Check the network connection and settings (page 20-25).
2. Select [Software] option in the [Setup] menu then press ENTER (Ⓢ).

3. Select [Update] option, and press ENTER (↵).

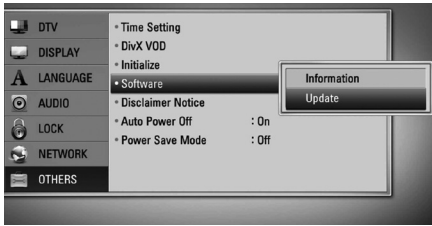

The player will check for the newest update.

**NOTE**

- Pressing ENTER while checking for the update will end the process.
- If there is no update available, the Message, "No update is found." appears. Press ENTER to return to the [Home Menu].

4. If newer version exists, the message "A new update was found. Do you want to download it?" appears.

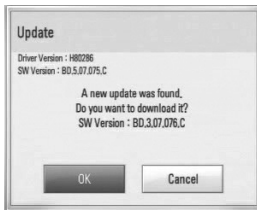

5. Select [OK] to download the update. (Selecting [Cancel] will end the update.)
6. The player starts downloading the newest update from the server. (Downloading will take several minutes depending on your home network condition)
7. When downloading is completed, the message, "Download is complete. Do you want to update?" appears.

8. Select [OK] to start updating. (Selecting [Cancel] will end the update and downloaded file will not be re-usable. To update software the next time, the software update procedure has to be started from the beginning again.)

**CAUTION**

Do not turn off the power during the software update.

**NOTE**

If the software includes the driver update, disc tray may open during the process.

9. When update is completed, the message, "Update is complete." will appear, and then power will turn off automatically after 5 seconds.
10. Turn the power back on. The system now operates with the new version.

**NOTE**

The Software Update function may not work properly depending on your internet environment. In this case, you can obtain the latest software from the authorized LG Electronics Service Centre then update your player. Refer to "Customer Support" on page 86.

## Audio Output Specifications

Jack/Setting Source	Analog 2CH Output	Digital Output (DIGITAL AUDIO OUT) *4		
		PCM Stereo	DTS Re-encode*3 *5	Primary Pass-Thru
Dolby Digital	PCM 2ch	PCM 2ch	DTS	Dolby Digital
Dolby Digital Plus	PCM 2ch	PCM 2ch	DTS	Dolby Digital
Dolby TrueHD	PCM 2ch	PCM 2ch	DTS	Dolby Digital
DTS	PCM 2ch	PCM 2ch	DTS	DTS
DTS-HD	PCM 2ch	PCM 2ch	DTS	DTS
Linear PCM 2ch	PCM 2ch	PCM 2ch	DTS	PCM 2ch
Linear PCM 5.1ch	PCM 2ch	PCM 2ch	DTS	PCM 2ch
Linear PCM 7.1ch	PCM 2ch	PCM 2ch	DTS	PCM 2ch

Jack/Setting Source	HDMI OUT			
	PCM Stereo	PCM Multi-Ch *3	DTS Re-encode*3 *5	Primary Pass-Thru *1 *2 *3
Dolby Digital	PCM 2ch	PCM 5.1ch	DTS	Dolby Digital
Dolby Digital Plus	PCM 2ch	PCM 7.1ch	DTS	Dolby Digital Plus
Dolby TrueHD	PCM 2ch	PCM 7.1ch	DTS	Dolby TrueHD
DTS	PCM 2ch	PCM 5.1ch	DTS	DTS
DTS-HD	PCM 2ch	PCM 7.1ch	DTS	DTS-HD
Linear PCM 2ch	PCM 2ch	PCM 2ch	DTS	Linear PCM 2ch
Linear PCM 5.1ch	PCM 2ch	PCM 5.1ch	DTS	Linear PCM 5.1ch
Linear PCM 7.1ch	PCM 2ch	PCM 7.1ch	DTS	Linear PCM 7.1ch

\*1 The secondary and interactive audio may not be included in the output bitstream if [Digital Output] or [HDMI] option is set to [Primary Pass-Thru]. (Except LPCM Codec : the output always includes interactive and secondary audio.)

\*2 This player automatically selects the HDMI audio according to the decoding capability of the connected HDMI device even though [HDMI] option is set to [Primary Pass-Thru].

\*3 The [PCM Multi-CH]/[Primary Pass-Thru] setting of the [HDMI] option and [DTS re-encode] setting of the [Digital Output] option cannot be set together. If you set them together, the [HDMI] or [Digital Output] option is set to [PCM Stereo] automatically.

\*4 On the PCM audio output, the sampling frequency of DIGITAL AUDIO OUT is limited to 96 kHz.

- \*5 If the [HDMI] or [Digital Output] option is set to [DTS re-encode], the audio output is limited to 48 kHz and 5.1Ch. If the [HDMI] or [Digital Output] option is set to [DTS re-encode], the DTS Re-encode audio is output for BD-ROM discs, and the original audio is output for the other discs (like [Primary Pass-Thru]).
- If [HDMI] option is set to [PCM Multi-CH] and [Digital Output] option is set to [Primary Pass-Thru] while playback Dolby Digital Plus or TrueHD audio, DIGITAL AUDIO OUT is limited to "PCM 2ch".
- If the HDMI connection is version 1.3 and Dolby Digital Plus/Dolby TrueHD is output from HDMI OUT jack, DIGITAL AUDIO OUT jack is limited to "PCM 2ch" (When the HDMI and DIGITAL AUDIO OUT are connected simultaneously).
- The audio is outputted as PCM 48 kHz/16 bit for MP3/WMA file and PCM 44.1 kHz/16 bit for Audio CD while playback.
- The Dolby TrueHD audio recorded on some Blu-ray discs consists of Dolby Digital and TrueHD audio. Dolby Digital audio is output through DIGITAL AUDIO OUT jacks and "DD" displays on the screen if TrueHD audio is not output (for example, when [HDMI] is set to [PCM Stereo] and [Digital Output] is set to [Primary Pass-Thru]).
- You must select a digital audio output and a maximum sampling frequency that your Amplifier (or AV receiver) accepts using [Digital Output], [HDMI] and [Sampling Freq.] options on the [Setup] menu (see page 38-39).
- With digital audio connection (DIGITAL AUDIO OUT or HDMI), Disc Menu button sounds of BD-ROM may not be heard if the [Digital Output] or [HDMI] option is set to [Primary Pass-Thru].
- If the audio format of the digital output does not match the capabilities of your receiver, the receiver will produce a strong, distorted sound or no sound at all.
- Multi-channel Digital Surround Sound via digital connection can only be obtained if your receiver is equipped with a Digital Multi-channel decoder.



# Video Output Resolution

## When the non-copy protected media is playing back

Resolution \ Video Out	HDMI OUT	COMPONENT VIDEO OUT	
		HDMI connected	HDMI disconnected
576i	576p	576i	
576p	576p	576p	
720p	720p	720p	
1080i	1080i	1080i	
1080p/24Hz	1080p / 24Hz	576i	1080i
1080p / 50Hz	1080p / 50Hz	576i	1080i

## When the copy protected media is playing back

Resolution \ Video Out	HDMI OUT	COMPONENT VIDEO OUT	
		HDMI connected	HDMI disconnected
576i	576p	576i	
576p	576p	576p	
720p	720p	576i	576p
1080i	1080i	576i	576p
1080p/24Hz	1080p / 24Hz	576i	576p
1080p / 50Hz	1080p / 50Hz	576i	576p

- This unit supports simultaneous output of all video out jacks.
- The 1080p video output frame rate may be automatically set to either 24Hz or 50Hz depending both on the capability and preference of the connected TV and based on the native video frame rate of the content on the BD-ROM disc.

### HDMI OUT connection

- For the 576i resolution setting, real output resolution of HDMI OUT will change to 576p.
- If you select a resolution manually and then connect the HDMI jack to TV and your TV does not accept it, the resolution setting is set to [Auto].
- If you select a resolution that your TV does not accept, the warning message will appear. After resolution change, if you cannot see the screen, please wait 20 seconds and the resolution will automatically revert back to the previous resolution.

### COMPONENT VIDEO OUT Connection

BD, DVD could prevent up-scaling on analogue output.

### VIDEO OUT connection

The resolution of the VIDEO OUT jack is always outputted at 576i resolution.

# Specifications

## General

<b>Power requirements:</b>	AC 200-240 V, 50/60 Hz
<b>Power consumption:</b>	45W
<b>Dimensions (W x H x D):</b>	Approx. 430 x 49 x 295 mm) without foot
<b>Net Weight (Approx.):</b>	2.8 kg
<b>Operating temperature:</b>	5 °C to 35 °C)
<b>Operating humidity:</b>	5 % to 90 %
<b>Television system:</b>	DVB-S, S2 and DVB-T Standard Compliant

## TV Recording

<b>Recording format:</b>	TS (Transport Stream format)
<b>Recordable media:</b>	USB 2.0 HDD

## Connectors

<b>VIDEO OUT:</b>	1.0 V (p-p), 75 Ω, sync negative, RCA jack x 1 / SCART x 1
<b>COMPONENT VIDEO OUT:</b>	(Y) 1.0 V (p-p), 75 Ω, sync negative, RCA jack x 1, (Pb)/(Pr) 0.7 V (p-p), 75 Ω, RCA jack x 2
<b>HDMI OUT (video/audio):</b>	19 pin (HDMI standard, Type A)
<b>ANALOGUE AUDIO OUT:</b>	2.0 Vrms (1 kHz, 0 dB), 600 Ω, RCA jack (L, R) x 1

<b>DIGITAL OUT (COAXIAL):</b>	0.5 V (p-p), 75 Ω, RCA jack x 1
<b>ANTENNA IN:</b>	Antenna input, 75 ohms
<b>ANTENNA OUT:</b>	Antenna output, 75 ohms
<b>RF ANTENNA IN:</b>	Antenna input, 75 ohms
<b>RF ANTENNA OUT:</b>	Antenna output, 75 ohms
<b>USB Port:</b>	4 pin (USB 2.0 standard)

## System

<b>Laser:</b>	Semiconductor laser,
<b>wavelength:</b>	405nm / 650 nm
<b>Signal system:</b>	Standard PAL colour TV system
<b>Frequency response:</b>	20 Hz to 20 kHz (48 kHz, 96 kHz, 192 kHz sampling)
<b>Signal-to-noise ratio:</b>	More than 100 dB (Analogue OUT connectors only)
<b>Harmonic distortion:</b>	Less than 0.008%
<b>Dynamic range:</b>	More than 95 dB
<b>LAN port:</b>	Ethernet jack x 1, 10BASE-T/100BASE-TX
<b>Wireless LAN (internal antenna):</b>	Integrated IEEE 802.11n (Draft 2.0) wireless networking access, compatible with 802.11b/g Wi-Fi networks.
<b>Bus Power Supply (USB):</b>	DC 5V --- 500mA

- Design and specifications are subject to change without notice.

## Important Information Relating to Network Services

PLEASE READ CAREFULLY. USE OF THE NETWORK SERVICES IS SUBJECT TO THE FOLLOWING TERMS AND CONDITIONS.

Use of the Network Services requires an Internet connection which is sold separately and for which you are solely responsible. The Network Services may be limited or restricted depending upon the quality, capabilities and technical limitations of your Internet service.

The Network Services belong to third parties and may be protected by copyright, patent, trademark and/or other intellectual property laws. The Network Services are provided solely for your personal and noncommercial use. Unless expressly authorized by the respective content owner or service provider, you shall not modify, copy, republish, upload, post, transmit, translate, sell, create derivative works, exploit, or distribute in any manner or medium any content or services accessible through this product.

LG IS NOT RESPONSIBLE FOR YOUR USE OF THE NETWORK SERVICES. THE NETWORK SERVICES ARE PROVIDED "AS IS," TO THE FULLEST EXTENT PERMISSIBLE BY LAW, LG MAKES NO REPRESENTATIONS OR WARRANTIES OF ANY KIND WHATSOEVER (i) FOR THE ACCURACY, VALIDITY, TIMELINESS, LEGALITY, OR COMPLETENESS OF ANY NETWORK SERVICE MADE AVAILABLE THROUGH THIS PRODUCT; OR (ii) THAT THE NETWORK SERVICES ARE FREE OF VIRUSES OR OTHER COMPONENTS THAT MAY INFECT, HARM, OR CAUSE DAMAGE TO THIS PRODUCT, YOUR COMPUTER, TELEVISION, OTHER EQUIPMENT, OR ANY OTHER PROPERTY. LG EXPRESSLY DISCLAIMS ANY IMPLIED WARRANTIES, INCLUDING BUT NOT LIMITED TO, WARRANTIES OF MERCHANTABILITY OR FITNESS FOR A PARTICULAR PURPOSE.

UNDER NO CIRCUMSTANCES AND UNDER NO LEGAL THEORY, WHETHER IN CONTRACT, TORT, STRICT LIABILITY OR OTHERWISE, SHALL LG BE LIABLE TO YOU OR ANY THIRD PARTY FOR ANY DIRECT, INDIRECT, INCIDENTAL, SPECIAL, STATUTORY, CONSEQUENTIAL OR OTHER DAMAGES OR ATTORNEY FEES OR EXPENSES RELATING TO OR ARISING OUT OF THE NETWORK SERVICES EVEN IF ADVISED OF THE POSSIBILITY OF SUCH DAMAGES OR IF SUCH DAMAGES COULD HAVE BEEN REASONABLY FORESEEN.

The Network Services may be terminated or interrupted at any time, and LG makes no representation or warranty that any Network Service will remain available for any period of time. Use of the Network Services may be subject to additional terms and conditions of the respective third party service provider. The Network Services are transmitted by third parties by means of networks and transmission facilities over which LG has no control. LG EXPRESSLY DISCLAIMS ANY RESPONSIBILITY OR LIABILITY FOR ANY INTERRUPTION OR SUSPENSION OF ANY NETWORK SERVICE.

LG shall be neither responsible nor liable for customer service related to the Network Services. Any question or request should be made directly to the respective Network Service providers.

"Network Service(s)" means the third party services accessible through this product including but not limited to all data, software, links, messages, video and other content found thereon or used in connection therewith.

"LG" means LG Electronics, Inc. its parent company and all of their respective subsidiaries, affiliates and related companies worldwide.

# Open source software notice

The following GPL executables and LGPL libraries used in this product are subject to the GPL2.0/LGPL2.1 License Agreements:

**GPL EXECUTABLES:** Linux kernel 2.6, bash, busybox, cramfs, dhcpcd, e2fsprogs, fdisk, mkdosfs, mtd-utils, net-tools, procps, samba-3.0.25b, sysutils, tcpdump, tftpd, tinylogin, unzip, utelnetd

**LGPL LIBRARIES:** uClibc, DirectFB, blowfish, cairo, ffmpeg, iconv, libusb, mpg123, Atk, cairo, directFB, glib, GnuTLS, gtk+, iconv, libintl, libgcrypt, libgpg-error, libsoup, pango, uClibc, webkit, gettext

**gSOAP Public License 1.3 LIBRARY:** gsoap

LG Electronics offers to provide source code to you on CD-ROM for a charge covering the cost of performing such distribution, such as the cost of media, shipping and handling upon e-mail request to LG Electronics at: [opensource@lge.com](mailto:opensource@lge.com)  
This offer is valid for a period of three(3) years from the date of the distribution of this product by LG Electronics.

You can obtain a copy of the GPL, LGPL licenses from <http://www.gnu.org/licenses/old-licenses/gpl-2.0.html> and <http://www.gnu.org/licenses/old-licenses/lgpl-2.1.html>.

Also you can obtain a copy of gSOAP public license from <http://www.cs.fsu.edu/~engelen/license.html>.

This software is based in part on the work of the Independent JPEG Group copyright © 1991 - 1998, Thomas G. Lane.

This product includes

- boost C++: software developed by <http://www.boost.org> distributed under the Boost Software License, Version 1.0
- c-ares : copyright © 1998 by the Massachusetts Institute of Technology
- curl: copyright © 1996 - 2008, Daniel Stenberg
- expat:
- copyright © 1998, 1999, 2000 Thai Open Source Software Center Ltd and Clark Cooper
- copyright © 2001-2007 Expat maintainers.
- fontconfig: copyright © 2001, 2003 Keith Packard
- ICU: copyright © 1995-2008 International Business Machines Corporation and others.

- libcurl: copyright © 1996 - 2008, Daniel Stenberg.
- libjpeg: This software is based in part on the work of the Independent JPEG Group copyright © 1991 - 1998,
- libmng: copyright © 2000-2007 Gerard Juyn, Glenn Randers-Pehrson
- libpng: copyright © 1998-2008 Glenn Randers-Pehrson
- libxml2 : copyright © 1998-2003 Daniel Veillard
- libxslt: copyright © 2001-2002 Daniel Veillard
- jpeg: This software is based in part on the work of the Independent JPEG Group copyright © 1991 - 1998, Thomas G. Lane.
- mng: copyright © 2000-2007 Gerard Juyn, Glenn Randers-Pehrson
- ntp : copyright © David L. Mills 1992-2006
- openssl:
- cryptographic software written by Eric Young.
- software written by Tim Hudson.
- software developed by the OpenSSL Project for use in the OpenSSL Toolkit. (<http://www.openssl.org>)
- pixman:
- copyright © 1987, 1988, 1989, 1998 The Open Group
- copyright © 1987, 1988, 1989 Digital Equipment Corporation
- copyright © 1999, 2004, 2008 Keith Packard
- copyright © 2000 SuSE, Inc.
- copyright © 2000 Keith Packard, member of The XFree86 Project, Inc.
- copyright © 2004, 2005, 2007, 2008 Red Hat, Inc.
- copyright © 2004 Nicholas Miell
- copyright © 2005 Lars Knoll & Zack Rusin, Trolltech
- copyright © 2005 Trolltech AS
- copyright © 2007 Luca Barbato
- copyright © 2008 Aaron Plattner, NVIDIA Corporation
- copyright © 2008 Rodrigo Kumpera
- copyright © 2008 André Tupinambá
- copyright © 2008 Mozilla Corporation
- copyright © 2008 Frederic Plourde
- tiff: copyright © 1987, 1993, 1994 The Regents of the University of California.
- png: copyright © 2004 Glenn Randers-Pehrson
- portmap : copyright © 1990 The Regents of the University of California
- ptmalloc : copyright © 2001-2006 Wolfram Gloger
- UnitTest++ : copyright © 2006 Noel Llopis and Charles Nicholson
- UPnP SDK: copyright © 2000-2003 Intel Corporation

- strace :  
copyright © 1991, 1992 Paul Kranenburg  
copyright © 1993 Branko Lankester  
copyright © 1993 Ulrich Pegelow  
copyright © 1995, 1996 Michael Elizabeth Chastain  
copyright © 1993, 1994, 1995, 1996 Rick Sladkey  
copyright © 1999,2000 Wichert Akkerman
- xml2 : copyright © 1998-2003 Daniel Veillard
- XML-RPC For C/C++:  
copyright © 2001 by First Peer, Inc. All rights reserved.  
copyright © 2001 by Eric Kidd. All rights reserved.
- xysst:  
Copyright © 2006-2008 Christophe Devine  
Copyright © 2009 Paul Bakker
- zlib: copyright © 1995-2002 Jean-loup Gailly and Mark Adler.

All rights reserved.

Permission is hereby granted, free of charge, to any person obtaining a copy of this software and associated documentation files (the "Software"), to deal in the Software without restriction, including without limitation the rights to use, copy, modify, merge, publish, distribute, sublicense, and/or sell copies of the Software, and to permit persons to whom the Software is furnished to do so, subject to the following conditions:

THE SOFTWARE IS PROVIDED "AS IS", WITHOUT WARRANTY OF ANY KIND, EXPRESS OR IMPLIED, INCLUDING BUT NOT LIMITED TO THE WARRANTIES OF MERCHANTABILITY, FITNESS FOR A PARTICULAR PURPOSE AND NONINFRINGEMENT. IN NO EVENT SHALL THE AUTHORS OR COPYRIGHT HOLDERS BE LIABLE FOR ANY CLAIM, DAMAGES OR OTHER LIABILITY, WHETHER IN AN ACTION OF CONTRACT, TORT OR OTHERWISE, ARISING FROM, OUT OF OR IN CONNECTION WITH THE SOFTWARE OR THE USE OR OTHER DEALINGS IN THE SOFTWARE.





