



**LG**

Life's Good

# OWNER'S MANUAL LCD TV / LED LCD TV

Please read this manual carefully before operating your set and retain it for future reference.



HDMI, the HDMI logo and High-Definition Multimedia Interface are trademarks or registered trademarks of HDMI Licensing LLC.

# CONTENTS

## PREPARATION

Accessories.....	A-1
------------------	-----

## EXTERNAL EQUIPMENT SETUP

Antenna Connection.....	1
Connecting with a Component cable .....	2
Connecting with a HDMI cable .....	3
Connecting with a HDMI to DVI cable .....	4
Usb setup .....	4
Connecting with a RCA cable .....	5
Connecting with a RF Cable .....	6
External stereo setup .....	6
Connecting with a D-sub 15 pin cable.....	7
Supported display resolution.....	8
Screen Setup for PC mode.....	9

## WATCHING TV / PROGRAMME CONTROL

Turning on the TV .....	13
Initializing Setup .....	13
Programme Selection.....	13
Volume Adjustment .....	13
Quick Menu .....	14
On Screen Menus Selection and adjustment ...	15
Auto programme tuning .....	16
Manual programme Tuning .....	17
Programme Edit .....	19
Selecting the Programme List.....	21
Favourite programme setup.....	22
Input List.....	23
Input Label .....	24
 .....	25
AV Mode.....	28
Initializing (Reset to original factory settings) .....	29
Key Lock.....	30

## TO USE A USB DEVICE

When connecting a USB device .....	31
Photo list.....	33
Music list.....	37
Movie list .....	40
DivX Registration Code.....	44
Deactivation.....	45

## PICTURE CONTROL

Picture Size (Aspect Ratio) Control .....	46
Energy Saving.....	48
Preset Picture Settings .....	49
Manual Picture Adjustment .....	50
Picture Improvement Technology.....	51
Expert picture control .....	52
Picture Reset.....	55
Power Indicator .....	56
Demo Mode.....	57
Mode Setting .....	58

## SOUND & LANGUAGE CONTROL

Auto Volume Leveler .....	59
Clear Voice II.....	60
Preset Sound Settings-Sound Mode .....	61
Sound Setting Adjustment -User Mode .....	62
Infinite Surround.....	63
Balance .....	64
TV Speakers On/ Off Setup .....	65
Audio Reset.....	66
I/II	
Stereo/Dual Reception .....	67
NICAM Reception .....	68
Speaker Sound Output Selection .....	68
On-Screen Menu Language Selection.....	69

# CONTENTS

## TIME SETTING

Clock Setup .....	70
Auto on/off time setting .....	71
Sleep Timer setting .....	71

## TELETEXT

Switch on/off .....	72
SIMPLE Text.....	72
TOP Text.....	72
FASTEXT .....	73
Special Teletext Functions .....	73

## APPENDIX

Troubleshooting.....	74
Maintenance.....	76
Product Specifications .....	77
IR Codes .....	79
External Control Device Setup.....	80



# PREPARATION

## ACCESSORIES

Ensure that the following accessories are included with your TV. If an accessory is missing, please contact the dealer where you purchased the TV.

■ Image shown may differ from your TV.

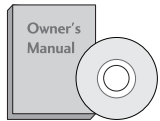

Owner's Manual

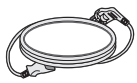

Power Cord  
(Except 32LV2\*\*\*)

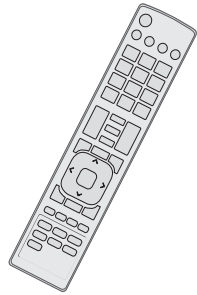

Remote Control

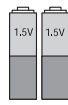

Batteries  
(AAA)

This item is not included for all models.



Polishing Cloth

Polishing cloth for use on the screen.

\* Lightly wipe any stains or fingerprints on the surface of the TV with the polishing cloth.

Do not use excessive force. This may cause scratching or discolouration.



1-screw for stand fixing  
(Only 26/32LK3\*\*, 32/42LK4\*\*,  
32LV2\*\*\*)

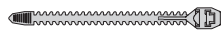

Cable Holder  
(Only 22LK3\*\*,  
19/22/26LV2\*\*\*)

Only 26/32LK3\*\*, 32/42LK4\*\*



x 8

M4 x 20  
Bolts for stand  
assembly

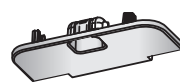

or

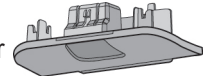

Protection cover

Only 22LK3\*\*

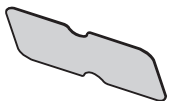

Protection cover

Only 19/22/26LV2\*\*\*



x 2

M4 x 16  
Bolts for stand  
assembly



AC/DC Adaptor

Only 32LV2\*\*\*



x 8

M4 x 14  
Bolts for stand  
assembly

Wall Mounting Bracket (Separate purchase)

LSW100B or LSW100BG

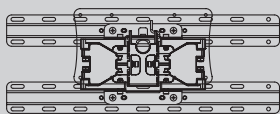

(19/22/26/32LV2\*\*\*,  
22/26/32LK3\*\*, 32LK4\*\*)

LSW200B or LSW200BG

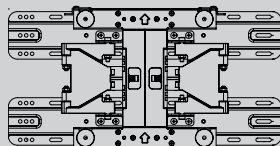

(42LK4\*\*)

# PREPARATION

## FRONT PANEL CONTROLS

### NOTE

- ▶ The energy consumed during use can be significantly reduced if the level of brightness of the picture is reduced, and this will reduce the overall running cost.

### CAUTION

- ▶ Do not step on the glass stand or subject it to any impact. It may break, causing possible injury from fragments of glass, or the TV may fall.
- ▶ Do not drag the TV. The floor or the product may be damaged.

■ Image shown may differ from your TV.

Only 22/26/32LK3\*\*

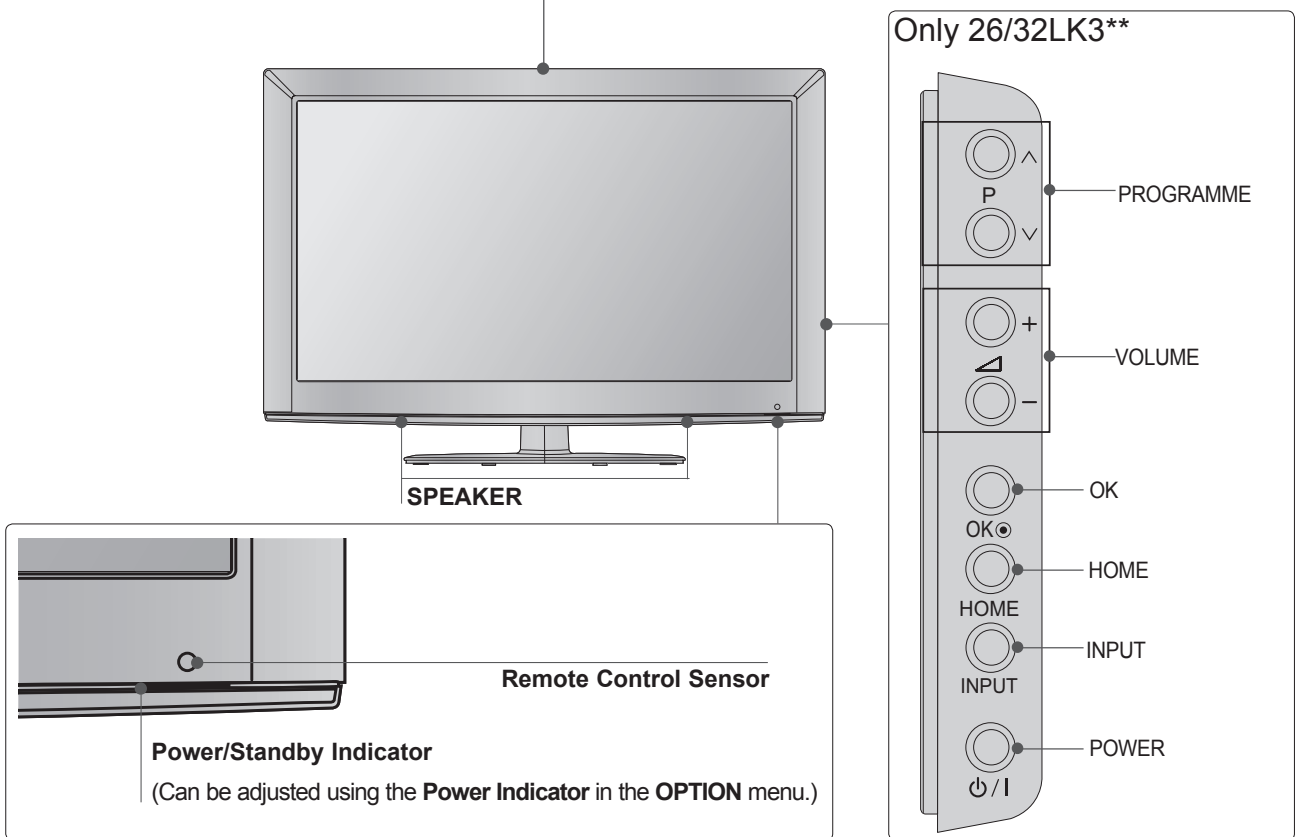
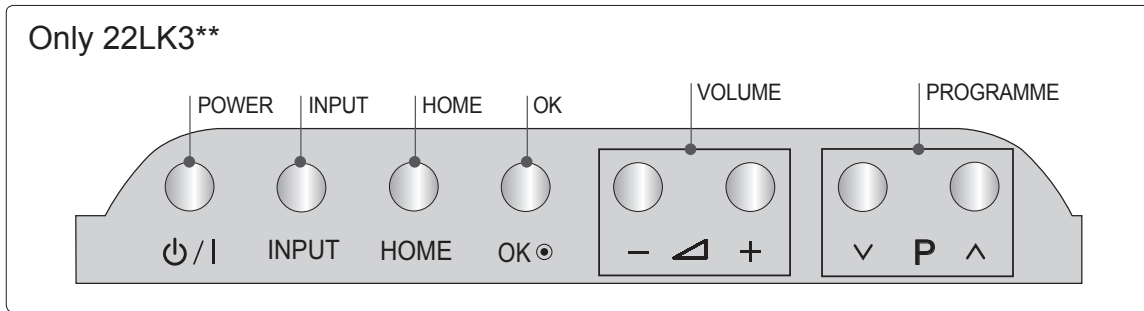

■ Image shown may differ from your TV.  
Only 32/42LK4\*\*

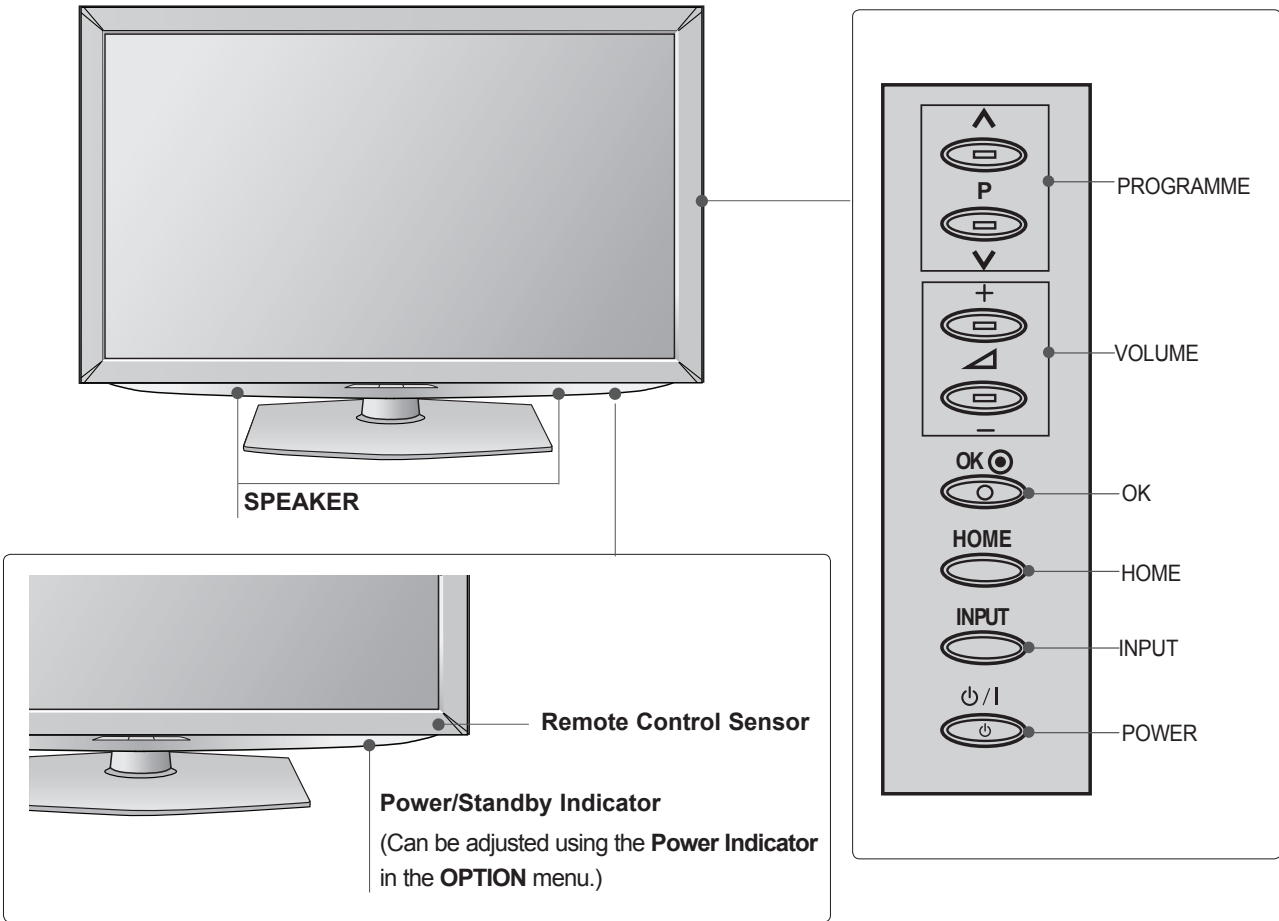

# PREPARATION

## FRONT PANEL CONTROLS

- Image shown may differ from your TV.  
Only 19/22/26/32LV2\*\*\*

PREPARATION

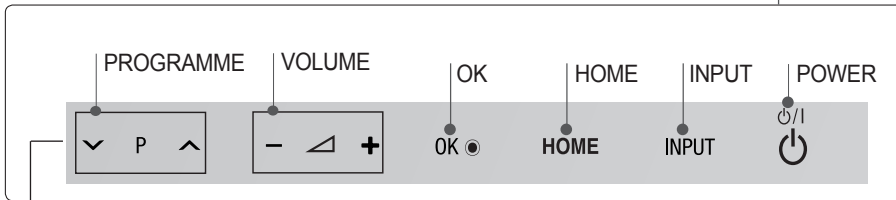
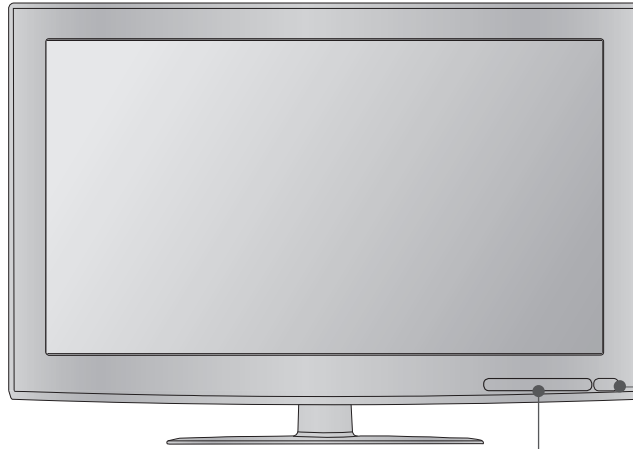

Touch Sensor

- You can use the desired button function by touching.

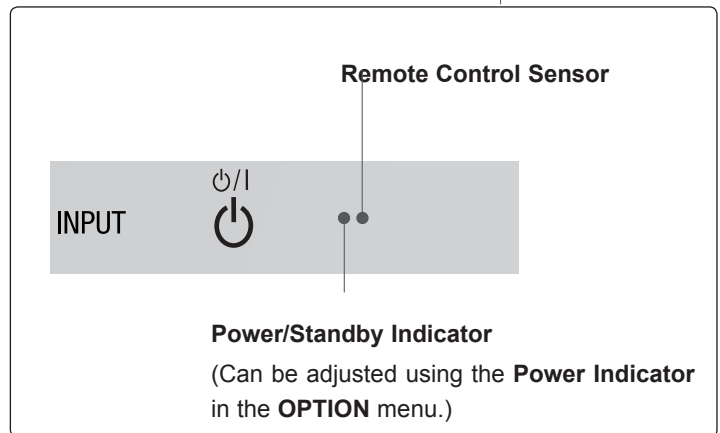

# BACK PANEL INFORMATION

■ Image shown may differ from your TV.

Only 22LK3\*\*

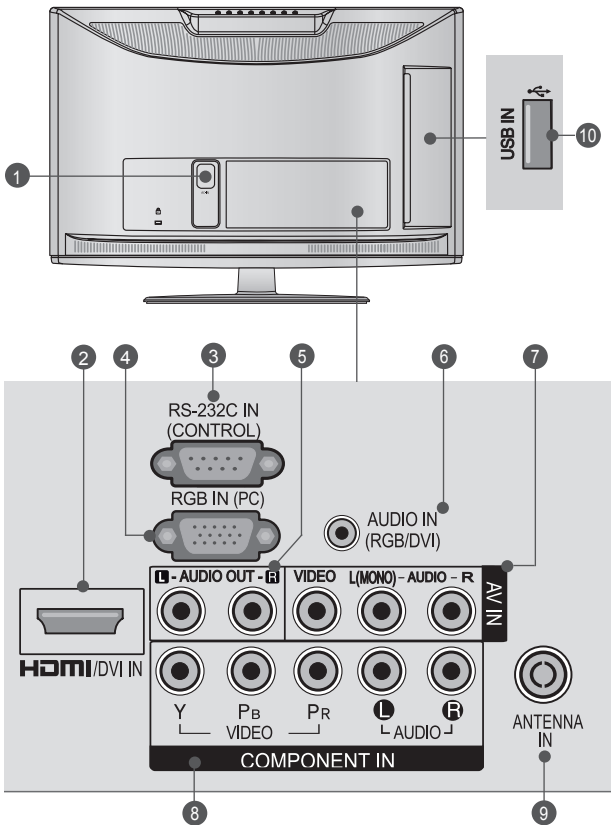

- 1 Power Cord Socket**  
This TV operates on an AC power. The voltage is indicated on the Specifications page. Never attempt to operate the TV on DC power.
- 2 HDMI Input**  
Connect an HDMI signal to HDMI IN. Or DVI(VIDEO)signal to HDMI/DVI port with DVI to HDMI cable.
- 3 RS-232C Input (CONTROL&SERVICE) Port**  
Connect to the RS-232C port on a PC. This port is used for Service or Hotel mode.
- 4 RGB Input**  
Connect the output from a PC.
- 5 Audio Output**  
Connect an external amplifier or add a subwoofer to your surround sound system.

Only 26/32LK3\*\*

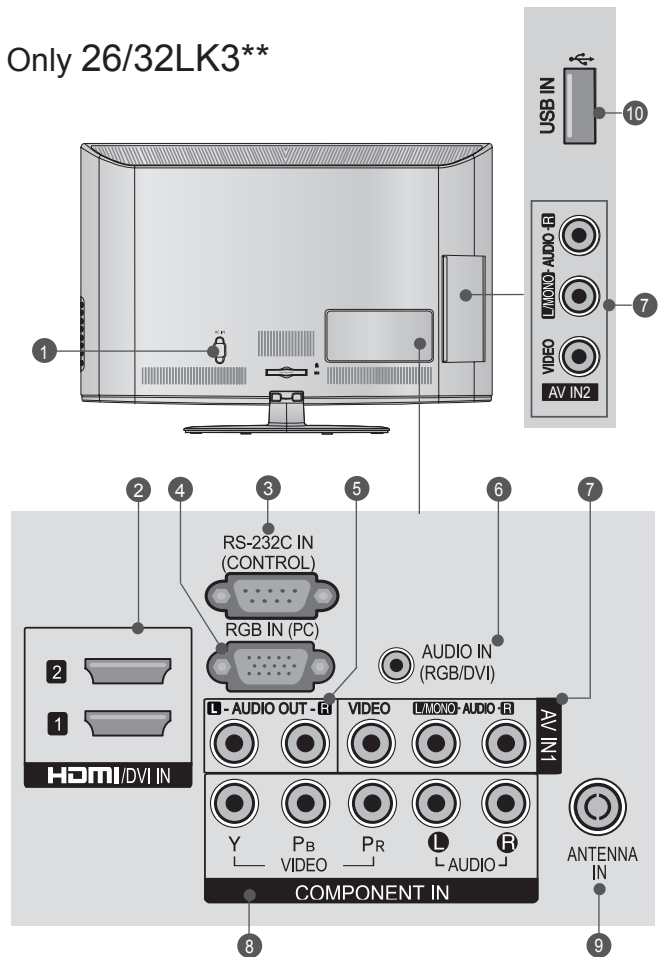

- 6 RGB/DVI Audio Input**  
Connect the audio from a PC.
- 7 Audio/Video Input**  
Connect audio/video output from an external device to these jacks.
- 8 Component Input**  
Connect a component video/audio device to these jacks.
- 9 Antenna Input**  
Connect RF antenna to this jack.
- 10 USB Input**  
Connect USB storage device to this jack.

# PREPARATION

## BACK PANEL INFORMATION

■ Image shown may differ from your TV.

Only 32/42LK4\*\*

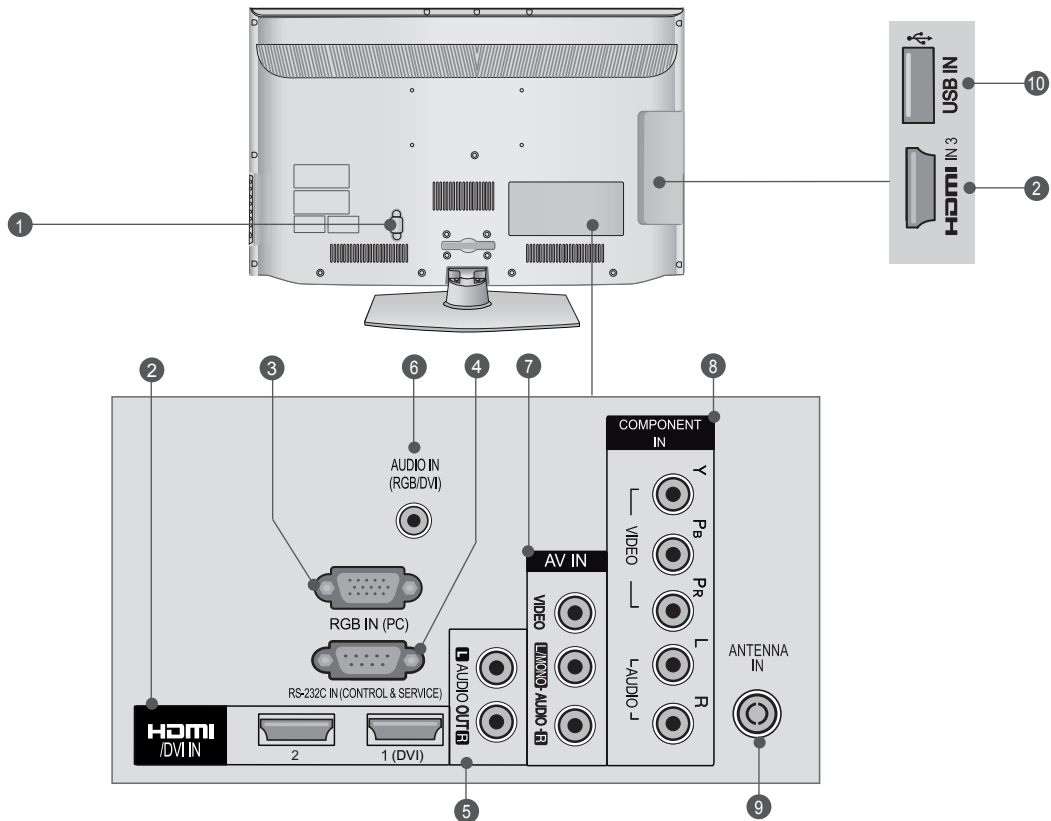

### 1 Power Cord Socket

This TV operates on an AC power. The voltage is indicated on the Specifications page. Never attempt to operate the TV on DC power.

### 2 HDMI Input

Connect an HDMI signal to HDMI IN.  
Or DVI(VIDEO)signal to HDMI/DVI port with DVI to HDMI cable.

### 3 RGB Input

Connect the output from a PC.

### 4 RS-232C Input (CONTROL&SERVICE) Port

Connect to the RS-232C port on a PC.  
This port is used for Service or Hotel mode.

### 5 Audio Output

Connect an external amplifier or add a subwoofer to your surround sound system.

### 6 RGB/DVI Audio Input

Connect the audio from a PC.

### 7 Audio/Video Input

Connect audio/video output from an external device to these jacks.

### 8 Component Input

Connect a component video/audio device to these jacks.

### 9 Antenna Input

Connect RF antenna to this jack.

### 10 USB Input

Connect USB storage device to this jack.

■ Image shown may differ from your TV.

Only 19/22/26LV2\*\*\*

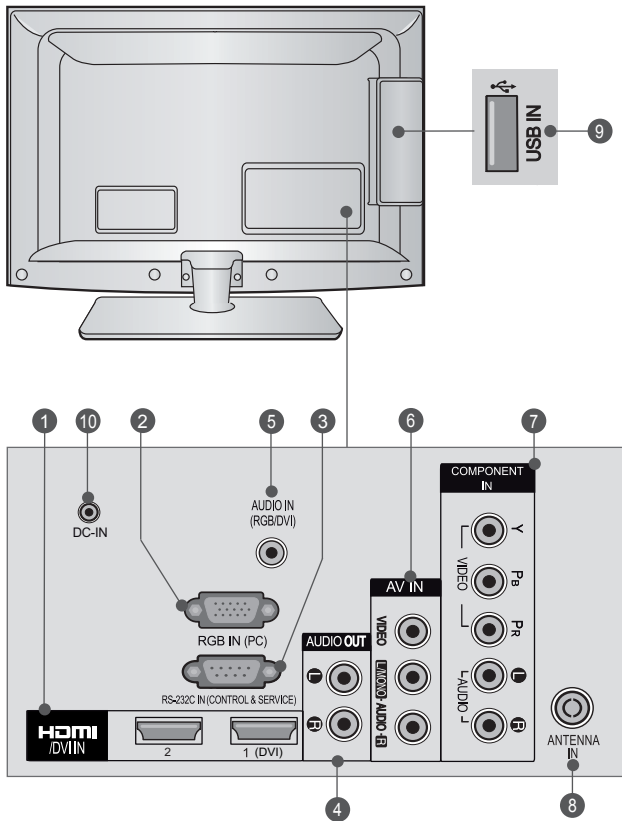

- ① **HDMI Input**  
Connect an HDMI signal to HDMI IN.  
Or DVI(VIDEO)signal to HDMI/DVI port with DVI to HDMI cable.
- ② **RGB Input**  
Connect the output from a PC.
- ③ **RS-232C Input (CONTROL&SERVICE) Port**  
Connect to the RS-232C port on a PC.  
This port is used for Service or Hotel mode.
- ④ **Audio Output**  
Connect an external amplifier or add a subwoofer to your surround sound system.
- ⑤ **RGB/DVI Audio Input**  
Connect the audio from a PC.

Only 32LV2\*\*\*

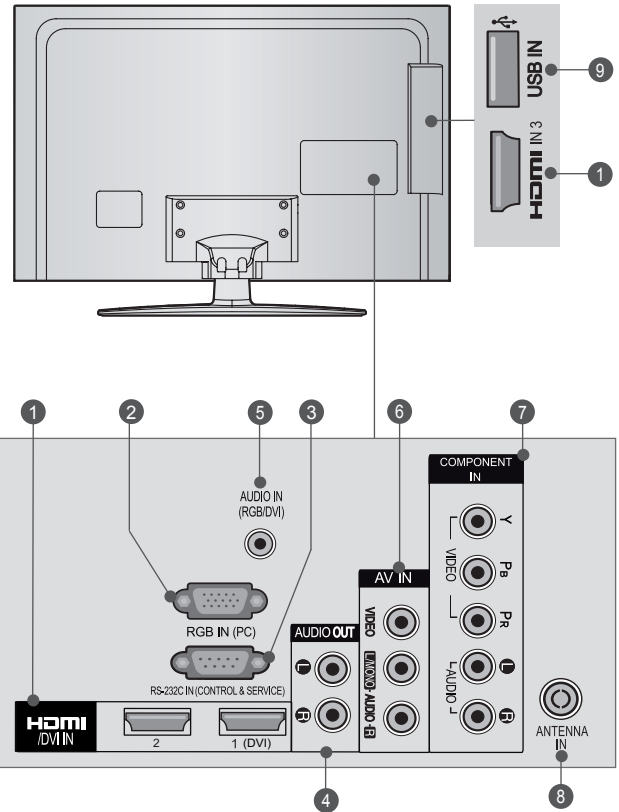

- ⑥ **Audio/Video Input**  
Connect audio/video output from an external device to these jacks.
- ⑦ **Component Input**  
Connect a component video/audio device to these jacks.
- ⑧ **Antenna Input**  
Connect RF antenna to this jack.
- ⑨ **USB Input**  
Connect USB storage device to this jack.
- ⑩ **DC ADAPTER PORT**  
Connect to the power cord socket.

# PREPARATION

## STAND INSTALLATION

- Image shown may differ from your TV.
- When assembling the desk type stand, check whether the bolt is fully tightened. (If not tightened fully, the product can tilt forward after the product installation.) If you tighten the bolt with excessive force, the bolt can deviate from abrasion of the tightening part of the bolt.

### Only 22LK3\*\*

- 1 Carefully place the TV screen side down on a cushioned surface to protect the screen from damage.

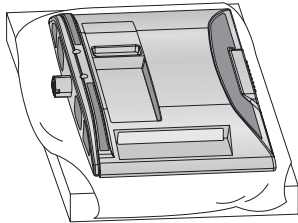

- 2 Assemble the TV as shown.

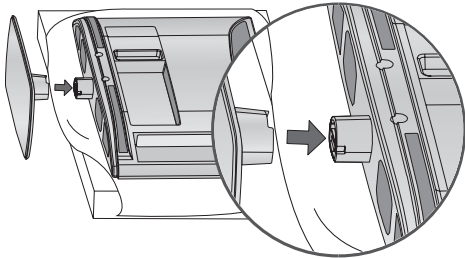

### Only 26/32LK3\*\*, 32/42LK4\*\*

- 1 Carefully place the TV screen side down on a cushioned surface to protect the screen from damage.

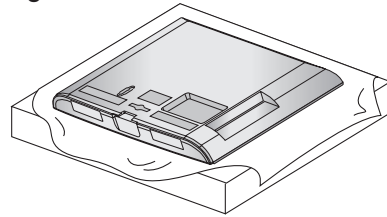

- 2 Assemble the parts of the **Stand Body** with the **Stand Base** of the TV

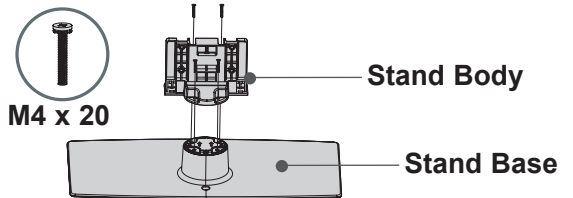

- 3 Assemble the TV as shown.

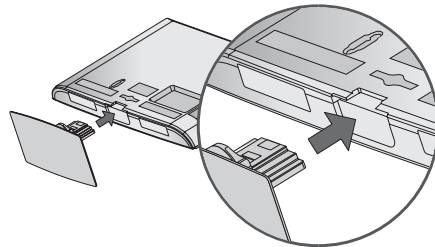

- 4 Fix the 4 bolts securely using the holes in the back of the TV.

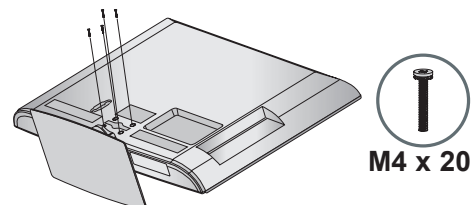



Only 19/22/26LV2\*\*\*

- 1 Carefully place the TV screen side down on a cushioned surface to protect the screen from damage.

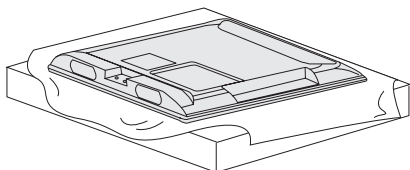

- 2 Assemble the parts of the **Stand Body** with the **Stand Base** of the TV

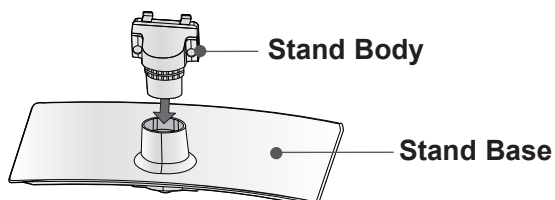

- 3 Assemble the TV as shown.

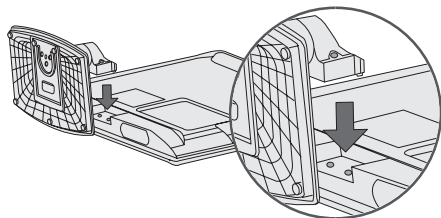

- 4 Fix the 2 bolts securely using the holes in the back of the TV.

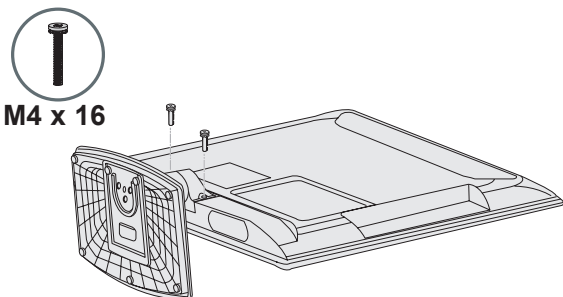

Only 32LV2\*\*\*

- 1 Carefully place the TV screen side down on a cushioned surface to protect the screen from damage.

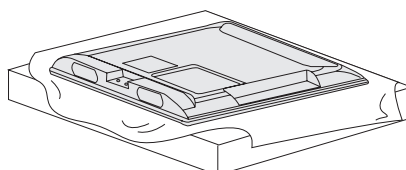

- 2 Assemble the parts of the **Stand Body** with the **Stand Base** of the TV

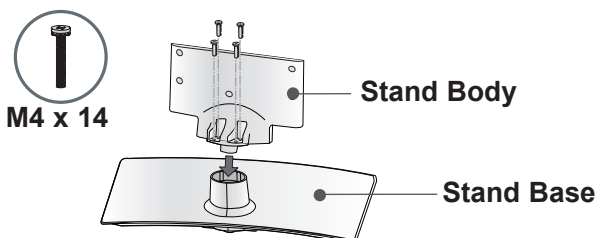

- 3 Assemble the TV as shown.

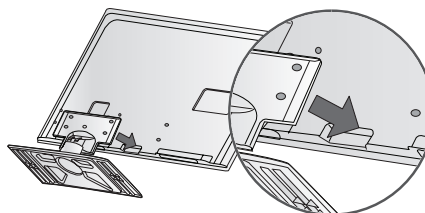

- 4 Fix the 4 bolts securely using the holes in the back of the TV.

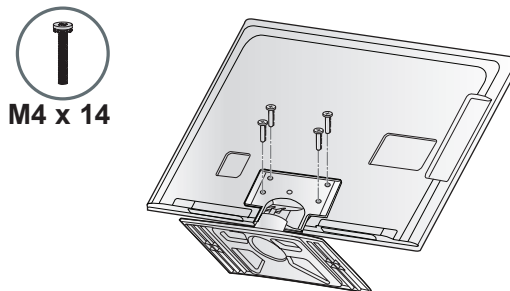

# PREPARATION

## BACK COVER FOR WIRE ARRANGEMENT

■ Image shown may differ from your TV.

### Only 22LK3\*\*

After Connecting the cables as necessary, install **CABLE HOLDER** as shown and bundle the cables.

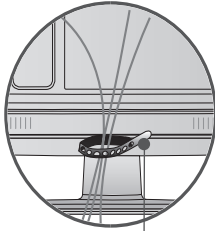
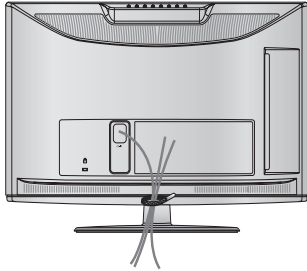

Cable Holder

### Only 19/22/26LV2\*\*\*

After Connecting the cables as necessary, install **CABLE HOLDER** as shown and bundle the cables.

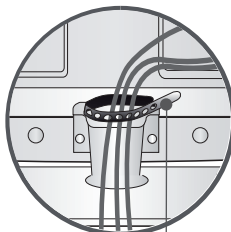
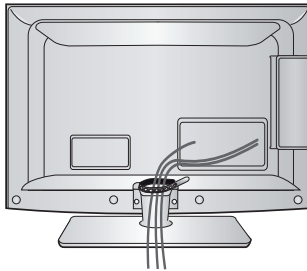

Cable Holder

### Only 32LV2\*\*\*

Gather and bind the cables with the **Cable Holder** on the TV back cover.

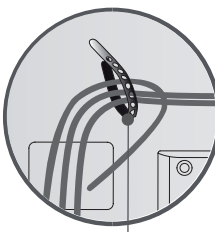
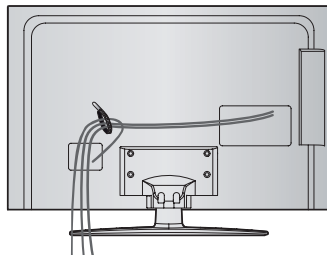

Cable Holder

### Only 26/32LK3\*\*, 32/42LK4\*\*

- 1 Connect the cables as necessary.  
To connect additional equipment, see the **External Equipment Setup** section.

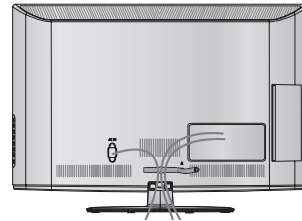

- 2 Open the **Cable Management Clip** as shown and manage the cables.

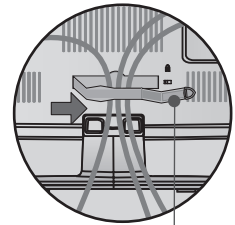
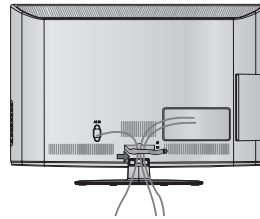

Cable Management Clip

- 3 Fit the **Cable Management Clip** as shown.

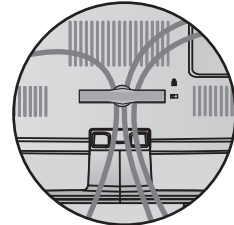
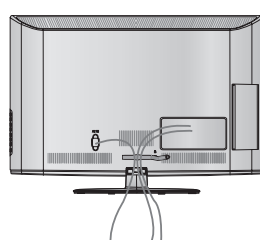

### NOTE

- ▶ Do not use the **Cable Management Clip** to lift the TV.
- If the TV is dropped, you may be injured or the TV may be damaged.

## NOT USING THE DESK-TYPE STAND

■ Image shown may differ from your TV.

When installing the wall-mounted unit, use the protection cover.

Only 22LK3\*\*

- 1 Carefully place the TV screen side down on a cushioned surface to protect the screen from damage.

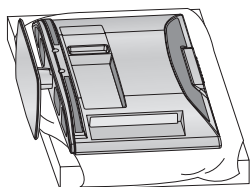

- 2 Loose the bolts from TV.

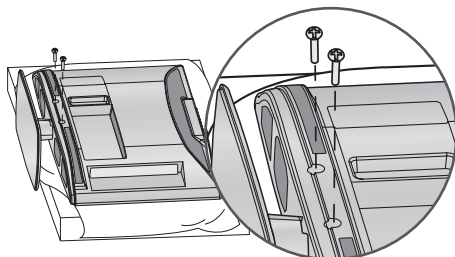

- 3 Detach the **Stand** from **TV**.

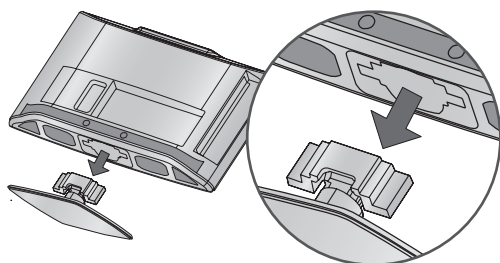

- 4 After removing the protection paper from the protection cover, adhere it to the TV as shown.

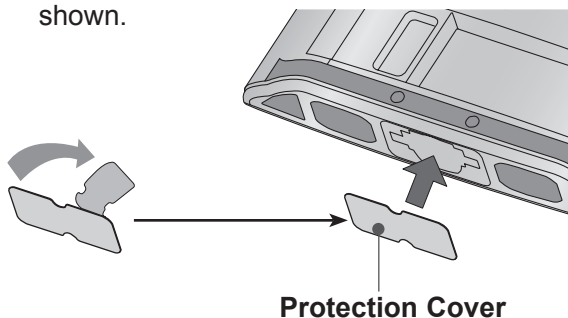

Only 26/32LK3\*\*, 32/42LK4\*\*

Insert the **Protection Cover** into the TV until clicking sound.

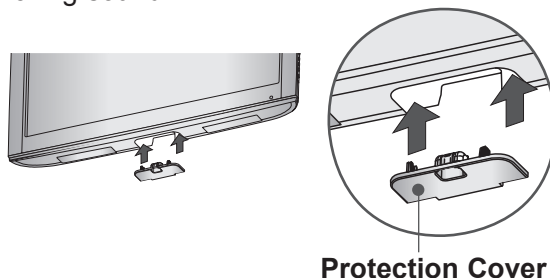

## SWIVEL STAND

(Only 26/32LK3\*\*, 32/42LK4\*\*)

- Image shown may differ from your TV.
- This feature is not available for all models.

After installing the TV, you can adjust the TV set manually to the left or right direction by 20 degrees to suit your viewing position.

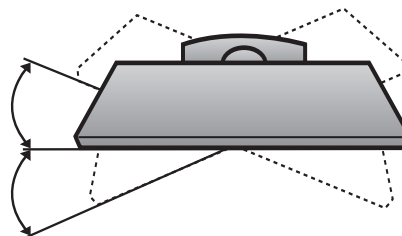

## POSITIONING YOUR DISPLAY

(Only 22LK3\*\*)

■ Image shown may differ from your TV.  
Adjust the position of the panel in various ways for maximum comfort.

- Tilt range

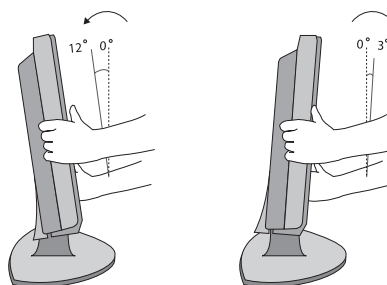

# PREPARATION

## ATTACHING THE TV TO A DESK (Only 26/32LK3\*\*, 32/42LK4\*\*, 32LV2\*\*\*)

- Image shown may differ from your TV.
- This feature is not available for all models.

The TV must be attached to desk so it cannot be pulled in a forward/backward direction, potentially causing injury or damaging the product. Use only an attached screw.

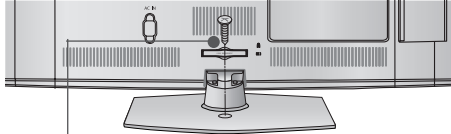

1-Screw (provided as parts of the product)

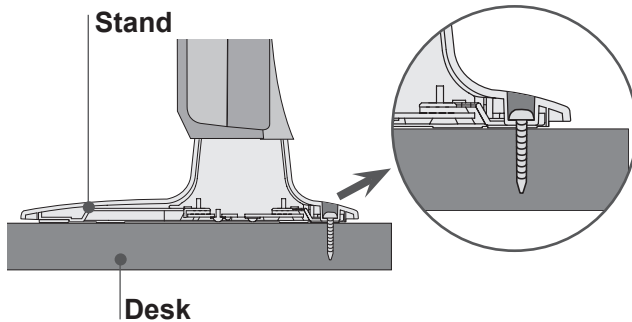

### ! WARNING

- ▶ To prevent TV from falling over, the TV should be securely attached to the floor/wall per installation instructions. Tipping, shaking, or rocking the machine may cause injury.

## CONNECTION OF TV

(Only 19/22/26LV2\*\*\*)

- Image shown may differ from your TV.

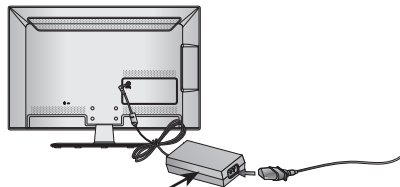

AC/DC Adaptor

- 1 Connect the antenna cable to the antenna input port on the TV.
- 2 Connect the AC/DC adapter plug to the power input jack on the TV.
- 3 Connect the power cord to the AC/DC adapter first, then plug the power cord into the wall power outlet.

## KENSINGTON SECURITY SYSTEM

- Image shown may differ from your TV.
- This feature is not available for all models.

The TV is equipped with a Kensington Security System connector on the back panel. Connect the Kensington Security System cable as shown below.

For the detailed installation and use of the Kensington Security System, refer to the user's guide provided with the Kensington Security System.

For further information, contact <http://www.kensington.com>, the internet homepage of the Kensington company. Kensington sells security systems for expensive electronic equipment such as notebook PCs and LCD projectors.

### ! NOTE

- ▶ The Kensington Security System is an optional accessory.
- ▶ If the TV feels cold to the touch, there may be a small "flicker" when when it is turned on. This is normal, there is nothing wrong with TV.
- ▶ Some minute dot defects may be visible on the screen, appearing as tiny red, green, or blue spots. However, they have no adverse effect on the monitor's performance.
- ▶ Avoid touching the screen or holding your finger(s) against it for long periods of time. Doing so may produce some temporary distortion effects on the screen.

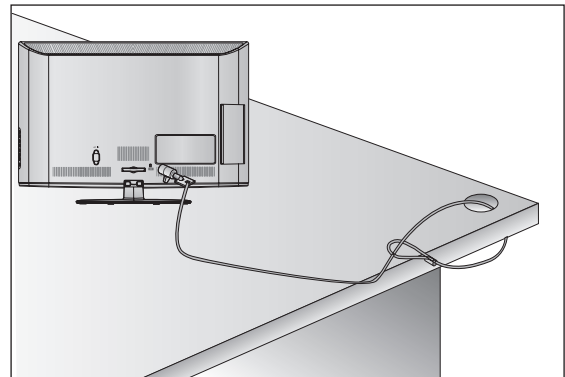

## CAREFUL INSTALLATION ADVICE

- You should purchase necessary components to fix the TV safely and secure to the wall from the market.
- Position the TV close to the wall to avoid the possibility of it falling when pushed.
- The instructions shown below are a safer way to set up the TV, by fixing it to the wall, avoiding the possibility of it falling forwards if pulled. This will prevent the TV from falling forward and causing injury. This will also prevent the TV from damage. Ensure that children do not climb or hang from the TV.

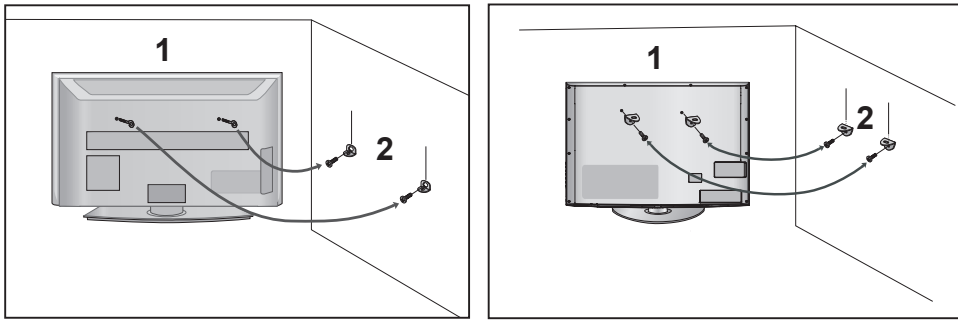

- 1 Use the eye-bolts or TV brackets/bolts to fix the product to the wall as shown in the picture.  
(If your TV has bolts in the eye-bolts, loosen then bolts.)  
\* Insert the eye-bolts or TV brackets/bolts and tighten them securely in the upper holes.
- 2 Secure the wall brackets with the bolts on the wall. Match the height of the bracket that is mounted on the wall.

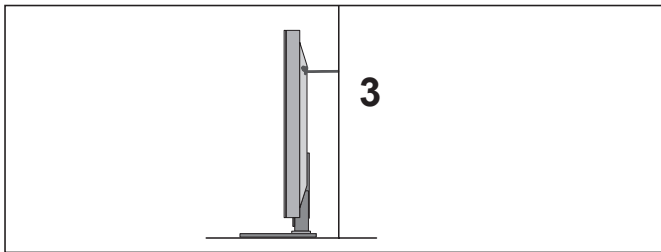

- 3 Use a sturdy rope to tie the product for alignment. It is safer to tie the rope so it becomes horizontal between the wall and the product.

### NOTE

- ▶ When moving the TV undo the cords first.
- ▶ Use a platform or cabinet strong and large enough to support the size and weight of the TV.
- ▶ To use the TV safely make sure that the height of the bracket on the wall and on the TV is the same.

# PREPARATION

## EARTHING

Ensure that you connect the earth wire to prevent possible electric shock. If grounding methods are not possible, have a qualified electrician install a separate circuit breaker.

Do not try to earth the TV by connecting it to telephone wires, lightning rods or gas pipes.

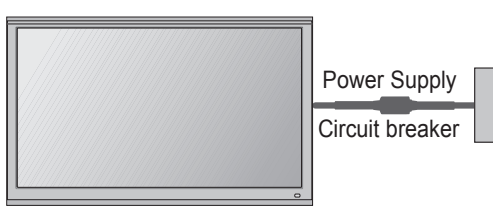

- The TV can be installed in various ways such as on a wall, or on a desktop etc.
- The TV is designed to be mounted horizontally.

## DESKTOP PEDESTAL INSTALLATION

For adequate ventilation allow a clearande of 10 cm (4 Inches) all around the TV.

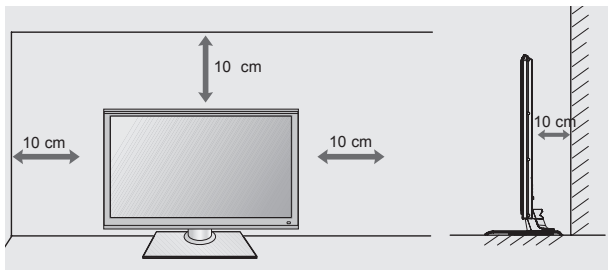

## WALL MOUNT : HORIZONTAL INSTALLATION

- We recommend the use of a LG Brand wall mounting bracket when mounting the TV to a wall.
- We recommend that you purchase a wall mounting bracket which supports VESA standard.
- LG recommends that wall mounting be performed by a qualified professional installer.

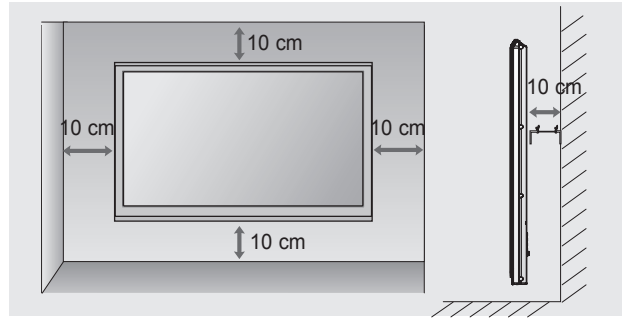

### NOTE

- ▶ Should Install wall mount on a solid wall perpendicular to the floor.
- ▶ Should use a special wall mount, if you want to install it to ceiling or slanted wall.
- ▶ The surface that wall mount is to be mounted on should be of sufficient strength to support the weight of TV set; e.g. concrete, natural rock, brick and hollow block.
- ▶ Installing screw type and length depends on the wall mount used. Further information, refer to the instructions included with the mount.
- ▶ LG is not liable for any accidents or damage to property or TV due to incorrect installation:
  - Where a non-compliant VESA wall mount is used.
  - I Incorrect fastening of screws to surface which may cause TV to fall and cause personal injury
  - Not following the recommended Installation method.

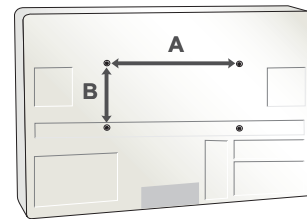

Model	VESA (A * B)	Standard Screw	Quantity
22LK3**	100 * 100	M4	4
26LK3**	200 * 100	M4	4
32LK3**	200 * 100	M4	4
32LK4**	200 * 100	M4	4
42LK4**	200 * 200	M6	4
19LV2***	100 * 100	M4	4
22LV2***	100 * 100	M4	4
26LV2***	100 * 100	M4	4
32LV2***	200 * 100	M4	4

# REMOTE CONTROL KEY FUNCTION

When using the remote control, aim it at the remote control sensor on the TV.

■ Image shown may differ from your TV.



**POWER** Switches the TV on from standby or off to standby.

**ENERGY SAVING** Adjust the power saving mode of the TV.

**AV MODE** It helps you select and set images and sounds when connecting AV devices.(▶ p.28)

**INPUT** External input mode rotate in regular sequence. Switches the TV on from standby.

**TV** Selects TV channel.

**0 to 9 number button** Selects a programme.  
Selects numbered items in a menu.

**LIST** Displays the programme table.

**Q.VIEW** Returns to the previously viewed programme.

**VOLUME UP /DOWN** Adjusts the volume.

**MARK** Check and un-check programmes in the USB menu.

**FAV** Displays the selected favourite programme.

**RATIO** Selects your desired picture format.

**MUTE** Switches the sound on or off.

**PAGE UP/ DOWN** Move from one full set of screen information to the next one.

**Programme UP/DOWN** Selects a programme.

**Coloured buttons** These buttons are used for teletext (on **TELETEXT** models only), **Programme edit**.

**TELETEXT BUTTONS** These buttons are used for teletext. For further details, see the 'Teletext' section.(▶ p.72)



# PREPARATION

■ Image shown may differ from your TV.



**XSTUDIO** Controls the USB menu.

**Home** Selects a menu.  
Clears all on-screen displays and returns to TV viewing from any menu.

**Q. MENU** Select the desired quick menu source.(▶ p.14)

**THUMBSTICK** Allows you to navigate the on-screen menus and adjust the system settings to your preference (Up/Down/Left/Right)

**OK** Accepts your selection or displays the current mode.

**BACK** Allows the user to move return one step in an interactive application, EPG or other user interaction function.

**SIMPLINK** See a list of AV devices connected to TV. When you toggle this button, the Simplink menu appears at the screen.(▶ p.25)

**EXIT** Clears all on-screen displays and returns to TV viewing from any menu.

**SIMPLINK / USB Menu control buttons** Controls SIMPLINK or USB menu.

## Installing Batteries

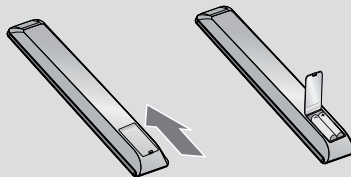

- Open the battery compartment cover on the back and install the batteries matching correct polarity (+ with +, - with -).
- Install two 1.5 V AAA batteries. Do not mix old or used batteries with new ones.
- Close cover.
- To remove the batteries, perform the installation actions in reverse



# EXTERNAL EQUIPMENT SETUP

- To prevent damage do not connect to the mains outlet until all connections are made between the devices.

## ANTENNA CONNECTION

- For optimum picture quality, adjust antenna direction.
- An antenna cable and converter are not supplied.

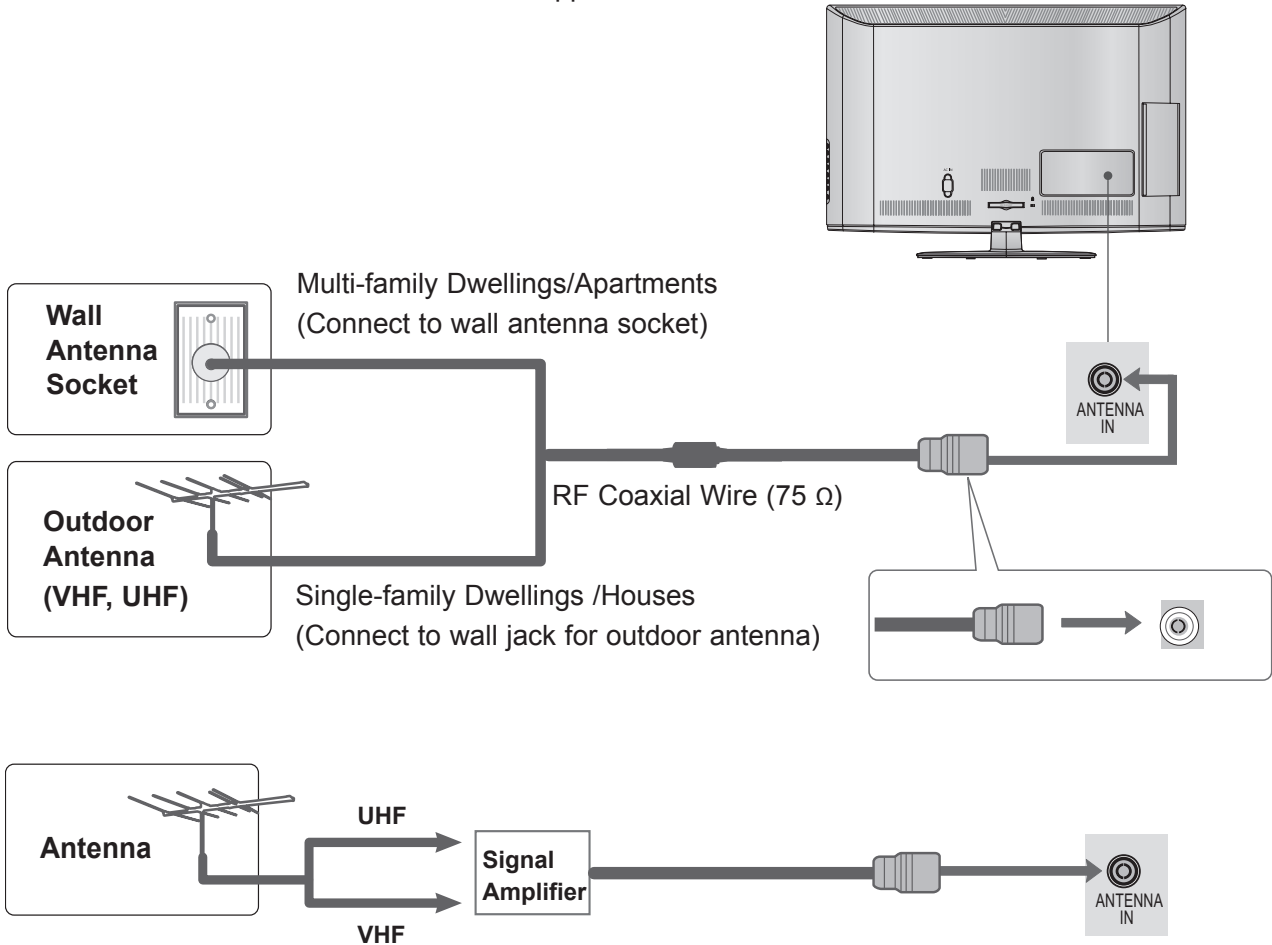

- In poor signal areas, to achieve better picture quality it may be necessary to install a signal amplifier to the antenna as shown above.
- If signal needs to be split for two TVs, use an antenna signal splitter for connection.

# EXTERNAL EQUIPMENT SETUP

- To avoid damaging any equipment, never plug in any power cord until you have finished connecting all equipment.
- This section on EXTERNAL EQUIPMENT SETUP mainly uses diagrams for the 26/32LK3\*\* models.
- Image shown may differ from your TV.

## CONNECTING WITH A COMPONENT CABLE

- 1 Connect the video outputs (Y, PB, PR) of the external equipment (digital set-top box, DVD, etc.) to the **COMPONENT IN VIDEO** jacks on the TV.
- 2 Connect the audio outputs (Y, PB, PR) of the external equipment (digital set-top box, DVD, etc.) to the **COMPONENT IN AUDIO** jacks on the TV.
- 3 Turn on the external equipment.  
(Refer to the external equipment's manual for operating instructions.)
- 4 Select **Component** input source using the **INPUT** button on the remote control.

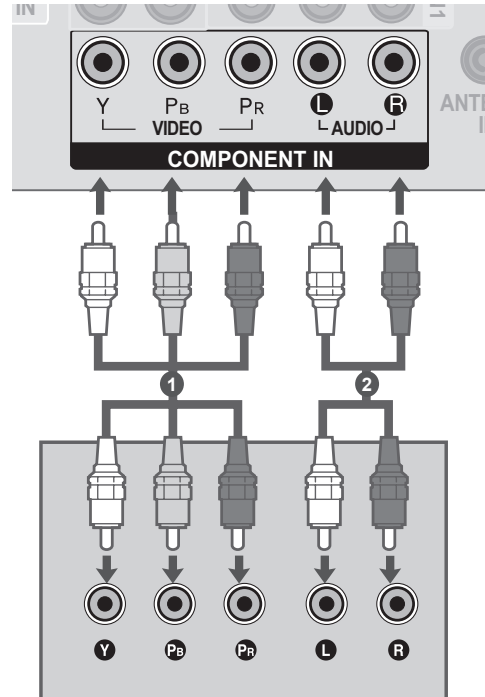

EXTERNAL EQUIPMENT SETUP

Signal	Component	HDMI
480i/576i	○	X
480p/576p	○	○
720p/1080i	○	○
1080p	○ (50/60Hz only)	○ (24Hz/30Hz/50Hz/60Hz)

### Component Input ports

To achieve better picture quality, connect a DVD player to the component input ports as shown below.

Component ports on the TV	Y	P <sub>B</sub>	P <sub>R</sub>
Video output ports on DVD player	Y	P <sub>B</sub>	P <sub>R</sub>
	Y	B-Y	R-Y
	Y	Cb	Cr
	Y	Pb	Pr

# CONNECTING WITH A HDMI CABLE

- 1 Connect the HDMI output of the external equipment (digital set-top box, DVD, etc.) to **HDMI/DVI IN 1**, **HDMI/DVI IN 2** (Except 22LK3\*\*) or **HDMI IN 3** (Only 32/42LK4\*\*, 32LV2\*\*\*) jack on the TV.
- 2 Turn on the external equipment.
- 3 Select **HDMI1**, **HDMI2** (Except for 22LK3\*\*) or **HDMI3** (Only 32/42LK4\*\*, 32LV2\*\*\*) input source using the **INPUT** button on the remote control.

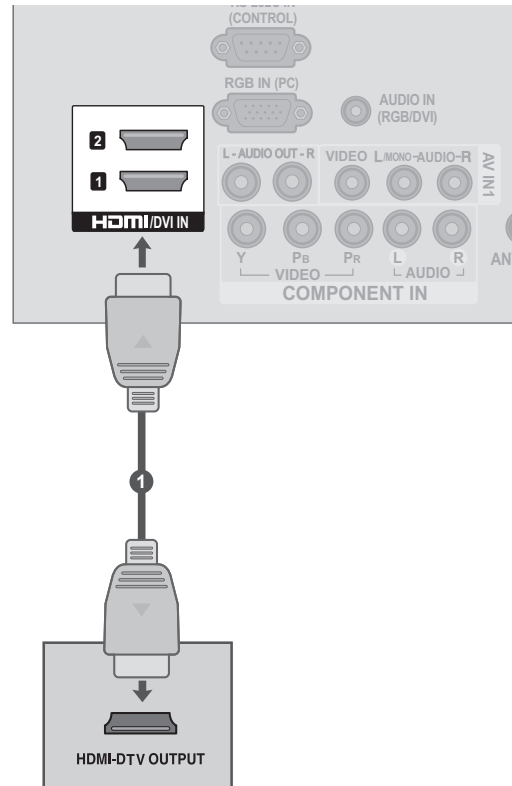

## NOTE

- ▶ Check that your HDMI cable is High Speed HDMI Cable.  
If the HDMI cables are not High Speed HDMI Cable, flickering or no screen display can result.  
Please use the High Speed HDMI Cable.
- ▶ HDMI mode supports PCM audio format only.
- ▶ Audio format was reset to Dolby/DTS/Bitstream in DVD Player or STB, it should be changed to PCM.
- ▶ We recommend using under 10m of the HDMI cable. When using over the length, connect an amplifier or repeater.
- ▶ If the DVD does not support Auto HDMI, you must set the output resolution appropriately.

# EXTERNAL EQUIPMENT SETUP

## CONNECTING WITH A HDMI TO DVI CABLE

- 1 Connect the digital set-top box or the DVI output of the PC to **HDMI/DVI IN 1** jack on the TV.
- 2 Connect the audio output of the digital set-top box or the PC audio output to the **AUDIO IN (RGB/DVI)** jack on the TV.
- 3 Turn on the digital set-top box or the PC and the TV.  
(Refer to the digital set-top box or the PC manual for operating instructions.)
- 4 Select **HDMI1** input source using the **INPUT** button on the remote control.

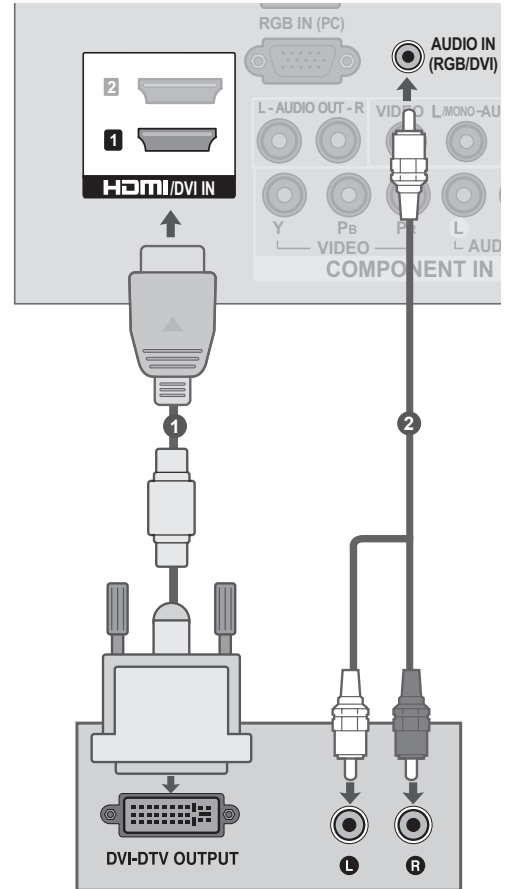

## USB SETUP

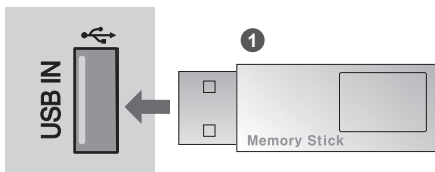

- 1 Connect the USB device to the **USB IN** jack on the TV.
- 2 After connecting the **USB IN** jack, you use the **USB** function. (▶ p.31)

# CONNECTING WITH A RCA CABLE

- 1 Connect the **AUDIO/VIDEO** jacks between TV and VCR or external equipment. Match the jack colours (Video = yellow, Audio Left = white, and Audio Right = red)
- 2 Insert a video tape into the VCR and press **PLAY** on the VCR. (Refer to the VCR owner's manual.)  
Or, Operate the corresponding external equipment.  
(Refer to external equipment operating guide.)
- 3 Select **AV1** input source using the **INPUT** button on the remote control.  
If connected to **AV IN2**, select **AV2** input source.

## ! NOTE

- ▶ If you have a mono VCR, connect the audio cable from the VCR to the **AUDIO L/MONO** jack of the TV.

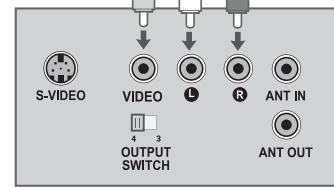
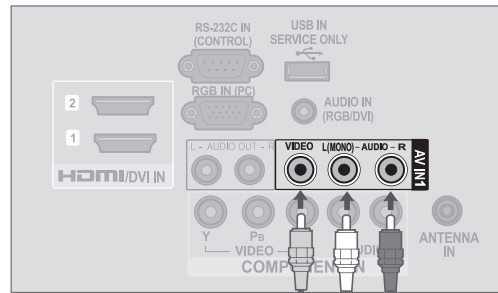

or

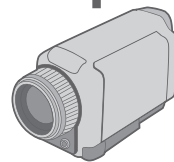
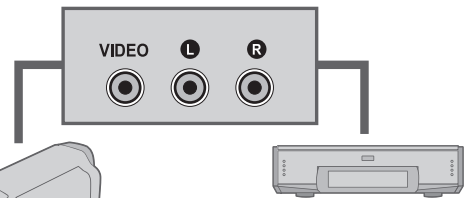

Camcorder

Video Game Set

# EXTERNAL EQUIPMENT SETUP

## CONNECTING WITH A RF CABLE

- To avoid picture noise (interference), allow adequate distance between the VCR and TV.

- 1 Connect the **ANT OUT** socket of the VCR to the **ANTENNA IN** socket on the TV.
- 2 Connect the antenna cable to the **ANT IN** socket of the VCR.
- 3 Press the **PLAY** button on the VCR and match the appropriate programme between the TV and VCR for viewing.

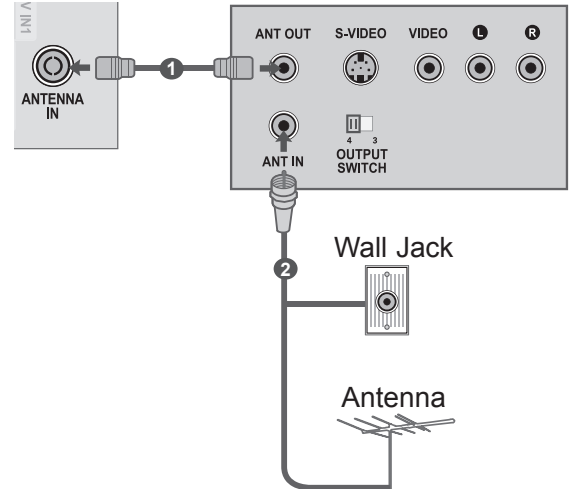

## EXTERNAL STEREO SETUP

Use to connected either an external amplifier, or add a subwoofer to your surround sound system.

- 1 Connect the input jack of the stereo amplifier to the **AUDIO OUT** jacks on the TV.
- 2 Set up your speakers through your analog stereo amplifier, according to the instructions provided with the amplifier.

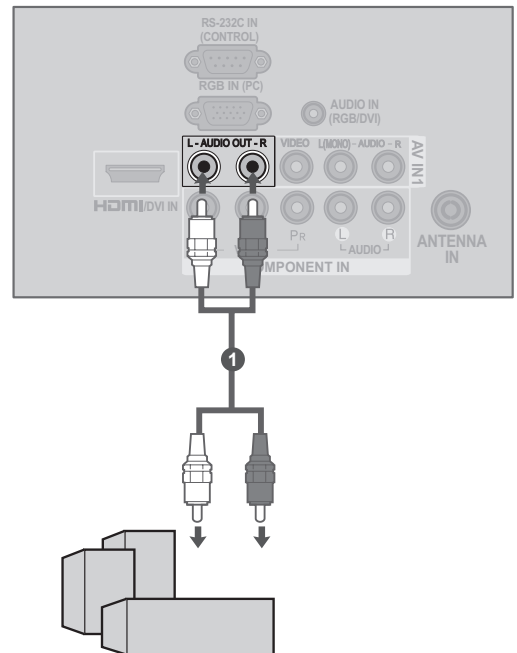

### ! NOTE

- ▶ When connecting with external audio equipments, such as amplifiers or speakers, please turn the TV speakers off. (▶ 65)

# CONNECTING WITH A D-SUB 15 PIN CABLE

This TV provides Plug and Play capability, meaning that the PC adjusts automatically to the TV's settings.

- 1 Connect the RGB output of the PC to the **RGB IN (PC)** jack on the TV.
- 2 Connect the PC audio output to the **AUDIO IN (RGB/DVI)** jack on the TV.
- 3 Turn on the PC and the TV.
- 4 Select **RGB** input source using the **INPUT** button on the remote control.

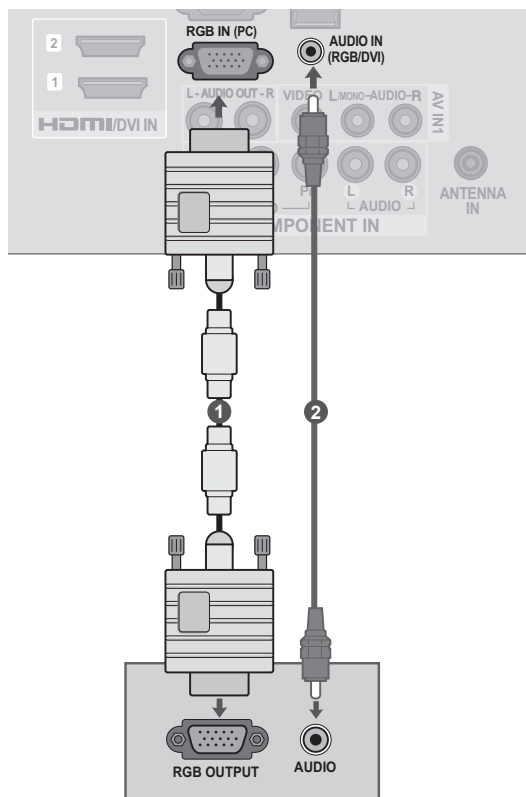

# EXTERNAL EQUIPMENT SETUP

## SUPPORTED DISPLAY RESOLUTION

### RGB-PC mode

Resolution	Horizontal Frequency(kHz)	Vertical Frequency(Hz)
640x350	31.468	70.09
720x400	31.469	70.09
640x480	31.469	59.94
800x600	37.879	60.317
1024x768	48.363	60.004
1280x768	47.776	59.87
1360x768	47.720	59.799
1280x1024	63.668	59.895
1920x1080	66.587	59.934

only 32/42LK4\*\*, 22LV2\*\*\*

### HDMI/DTV mode

Resolution	Horizontal Frequency(kHz)	Vertical Frequency(Hz)
720x480	31.47	59.94
720x480	31.50	60.00
720x576	31.25	50.00
1280x720	44.96	59.94
1280x720	45.00	60.00
1280x720	37.50	50.00
1920x1080	33.72	59.94
1920x1080	33.75	60.00
1920x1080	28.125	50.00
1920x1080	67.432	59.94
1920x1080	67.50	60.00
1920x1080	56.25	50.00
1920x1080	27.00	24.00
1920x1080	33.75	30.00

### NOTE

- ▶ Avoid keeping a fixed image on the TV 's screen for prolonged periods of time. The fixed image may become permanently imprinted on the screen; use a screen saver when possible.
- ▶ There may be interference relating to resolution, vertical pattern, contrast or brightness in PC mode. Change the PC mode to another resolution or change the refresh rate to another rate or adjust the brightness and contrast on the menu until the picture is clear. If the refresh rate of the PC graphic card can not be changed, change the PC graphic card or consult the manufacturer of the PC graphic card.
- ▶ The synchronization input waveform for Horizontal and Vertical frequencies are separate.
- ▶ We recommend using 1920x1080, 60 Hz(Only 32/42LK4\*\*, 22LV2\*\*\*), 1360x768, 60 Hz(Only 32/42LK3\*\*, 19/26/32LV2\*\*\*)) for the PC mode, this should provide the best picture quality.
- ▶ If the resolution of PC is over SXGA, there will be no picture on the TV.(Only HD Models)
- ▶ Connect the audio cable from the PC to the Audio input on the TV.(Audio cables are not included with the TV).
- ▶ you use too long an RGB-PC cable, there may be interference on the screen. We recommend using under 5m of the cable. This provides the best picture quality.











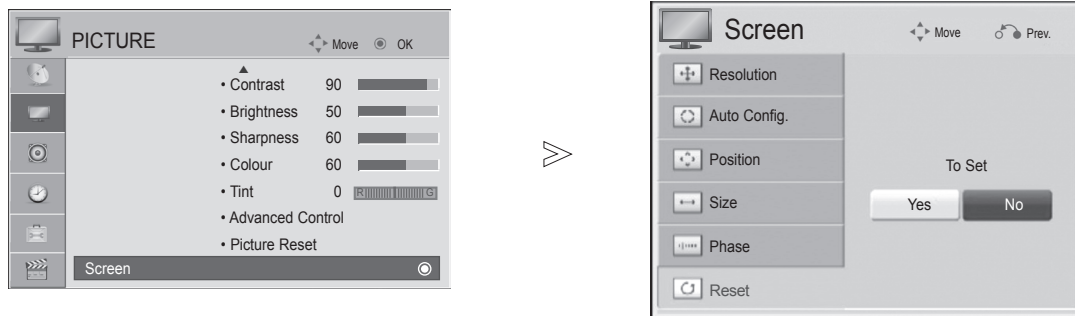

# SCREEN SETUP FOR PC MODE

## SCREEN RESET

Returns Position, Size and Phase to the factory default settings.

This function works in the following mode: Component(Except 480i, 576i), RGB.



- 1   Select **PICTURE**.
- 2   Select **Screen**.
- 3   Select **Reset**.
- 4   Select **Yes**.
- 5  Run **Reset**.

- Press the **Home/EXIT** button to return to normal TV viewing.
- Press the **BACK** button to move to the previous menu screen.

# EXTERNAL EQUIPMENT SETUP





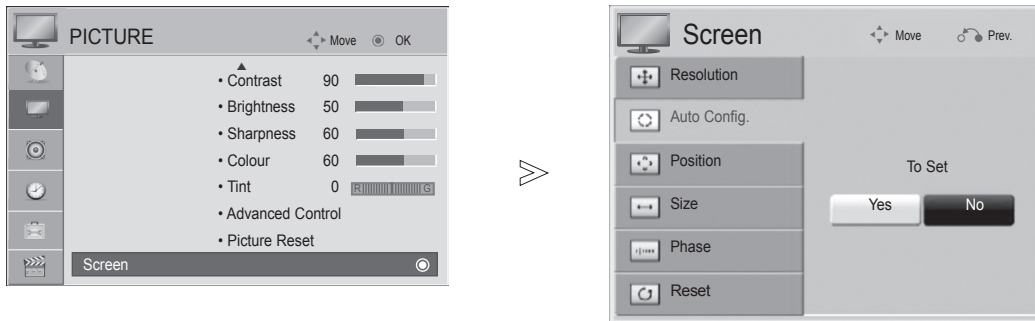

## AUTO CONFIGURE (RGB [PC] MODE ONLY)

Automatically adjust the picture position and minimizes image instability. After adjustment, if the image is still not correct, your TV is functioning properly but needs further adjustment.

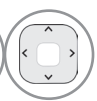
### Auto configure

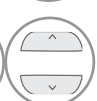
This function is for automatic adjustment of the screen position, size and phase. The displayed image will be unstable for a few seconds while the auto configuration is in progress.

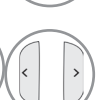

- 1   Select **PICTURE**.
- 2   Select **Screen**.
- 3   Select **Auto Config..**
- 4   Select **Yes**.
- 5  Run **Auto Config..**

- If the position of the image is still not correct, try Auto adjustment again.
- If picture needs to be adjusted again after Auto adjustment in RGB (PC), you can adjust the **Position, Size or Phase**.







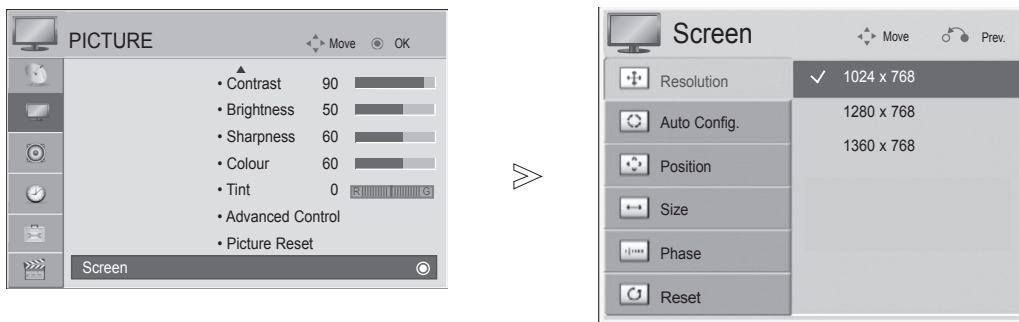

- Press the **Home/EXIT** button to return to normal TV viewing.
- Press the **BACK** button to move to the previous menu screen.

## SELECTING RESOLUTION

To view a normal picture, match the resolution of RGB mode at TV and selection at PC.

This function works in the following mode: RGB[PC] (1024x768, 1280x768, 1360x768)



- 1   Select **PICTURE**.
- 2   Select **Screen**.
- 3   Select **Resolution**.
- 4   Select the desired resolution.
- 5 

- Press the **Home/EXIT** button to return to normal TV viewing.
- Press the **BACK** button to move to the previous menu screen.

# EXTERNAL EQUIPMENT SETUP









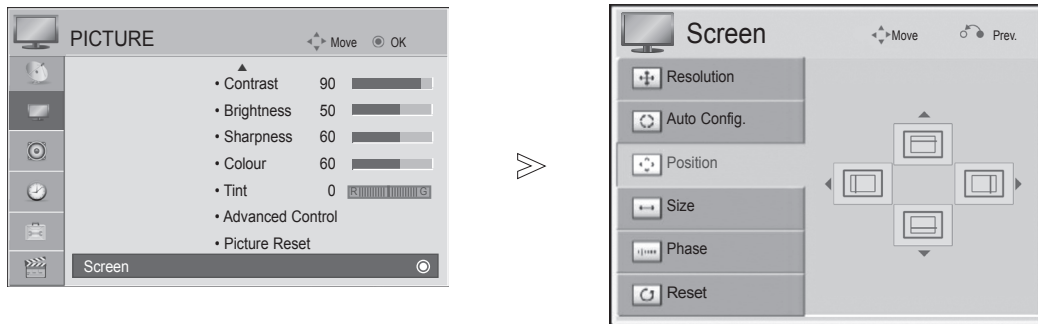

## ADJUSTMENT FOR SCREEN POSITION, SIZE, PHASE

If the picture is not clear after auto adjustment and especially if characters are still trembling, adjust the picture phase manually.

**Position** operates in Component(except 480i, 576i), RGB mode.

**Size, Phase** operate only in RGB mode.



- 1   Select **PICTURE**.
- 2   Select **Screen**.
- 3   Select **Position, Size or Phase**.
- 4     Make appropriate adjustments.
- 5 

- Press the **Home/EXIT** button to return to normal TV viewing.
- Press the **BACK** button to move to the previous menu screen.

# WATCHING TV / PROGRAMME CONTROL

## TURNING ON THE TV

- When your TV is turned on, you will be able to use its features.

- 
- 1 Firstly, connect the power cord correctly.  
At this stage, the TV switches to standby mode.
  - 2 In standby mode to turn TV on, press the  $\odot / I$ , **INPUT** or **PΛV** button on the TV or press the **POWER**, **INPUT**, **PΛV** or **NUMBER** button on the remote control and the TV will switch on.
- 

## INITIALIZING SETUP

- 
- 1 If the OSD (On Screen Display) is displayed on the screen after turning on the TV, you can adjust the **Language**, **Mode Setting**, **Auto Tuning**.

**Note:**

- a. If you close without completing the initial setting, the Initial Setting menu can be displayed again.
  - b. "Store Demo" mode is only for shop display and not for general customer use.
  - c. "Home Use" mode is the optimal setting for home environments, and is the TV's default mode.
  - d. "Store Demo" mode is the optimal setting for store environments. If a user modifies image quality data, "Store Demo" mode initializes the product to the image quality set by us after a certain period of time.
  - e. The mode (Home Use, Store Demo) can be changed by executing Mode Setting in the **OPTION** menu.
- 

## PROGRAMME SELECTION

- 
- 1 Press the **PΛV** or **NUMBER** buttons to select a programme number.
- 

## VOLUME ADJUSTMENT

- 
- 1 Press the  $\triangle +$  or  $-$  button to adjust the volume.

.....  
If you wish to switch the sound off, press the **MUTE** button.

.....  
You can cancel this function by pressing the **MUTE**,  $\triangle +$ ,  $-$  or **AV MODE** button.

---

# WATCHING TV / PROGRAMME CONTROL

## QUICK MENU

Your TV's OSD (On Screen Display) may differ slightly from that shown in this manual.

Q.Menu (Quick Menu) is a menu of features which users might use frequently.

- **Aspect Ratio**: Selects your desired picture format.  
For Zoom Setting, select 16:9, Original, 4:3, 14:9, Zoom and Cinema Zoom in Ratio Menu. After completing Zoom Setting, the display goes back to Q.Menu.
- **Clear Voice II** : By differentiating the human sound range from others, it helps users listen to human voices better
- **Picture Mode** : Selects your desired Picture Mode.
- **Sound Mode** : It is a feature to automatically set the sound combination which it deems the best for the images being watched. Selects your desired Sound Mode.
- **Audio** : Selects the sound output.
- **Sleep Timer** : Sets the sleep timer.
- **Favourite** : Selects the favourite programme.
- **USB Device** : Selects "Eject" in order to eject USB device.

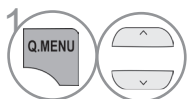
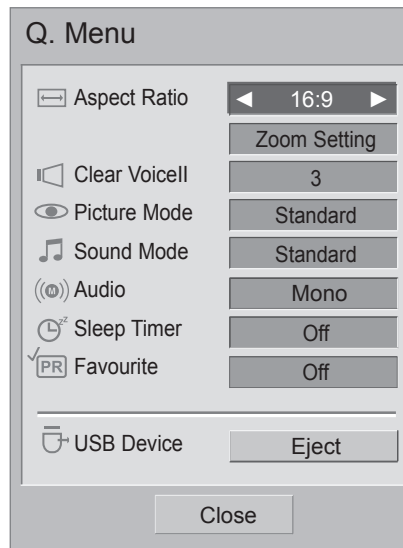

1 Display each menu.



2 Select your desired Source.







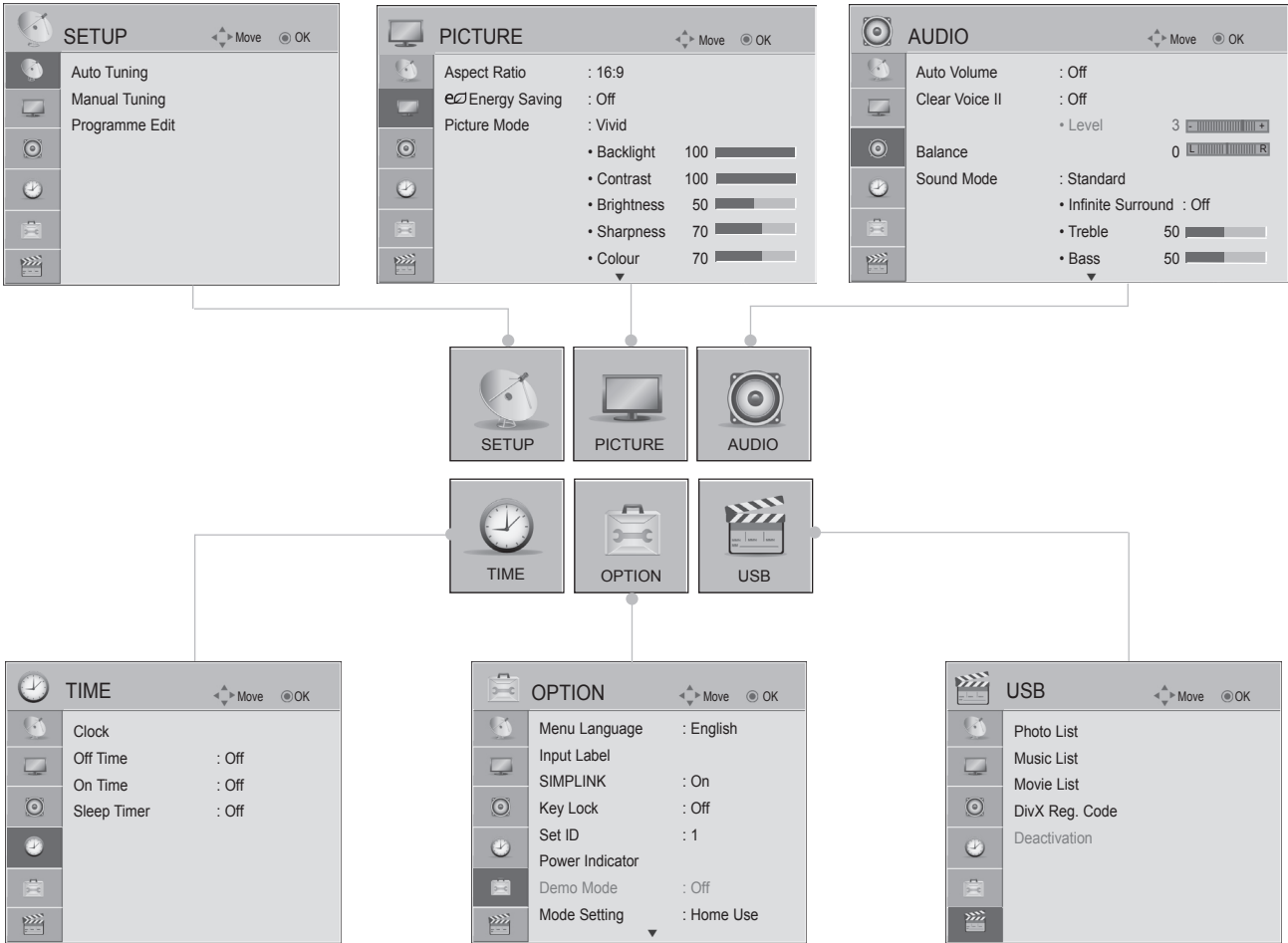

- Press the **Q.MENU** button to return to normal TV viewing.

# ON SCREEN MENUS SELECTION AND ADJUSTMENT

Your TV's OSD (On Screen Display) may differ slightly from that shown in this manual.

■ Image shown may differ from your TV.



- 1   Display each menu.
- 2   Select a menu item.
- 3  Move to the pop up menu.

- Press the **Home/EXIT** button to return to normal TV viewing.
- Press the **BACK** button to move to the previous menu screen.





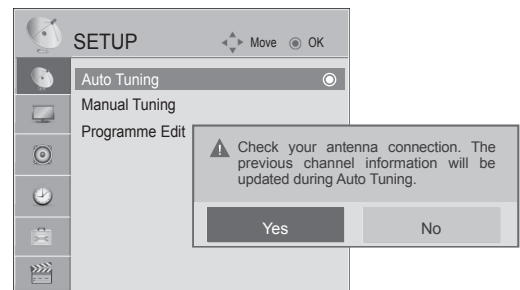
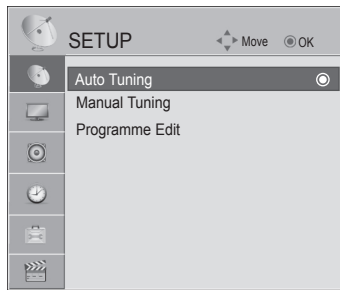

# WATCHING TV / PROGRAMME CONTROL

## AUTO PROGRAMME TUNING

Use this to automatically find and store all available programmes.

When you start auto programming, all previously stored service information will be deleted.



- 1   Select **SETUP**.
- 2   Select **Auto Tuning**.
- 3   Select **Yes**.
- 4  Run **Auto tuning**.

• If you wish to keep on auto tuning select Yes using the < > button. Then, press the OK button. Otherwise select No.

- Press the **Home/EXIT** button to return to normal TV viewing.
- Press the **BACK** button to move to the previous menu screen.



# MANUAL PROGRAMME TUNING

Manual Tuning lets you manually tune and arrange the stations in whatever order you desire.

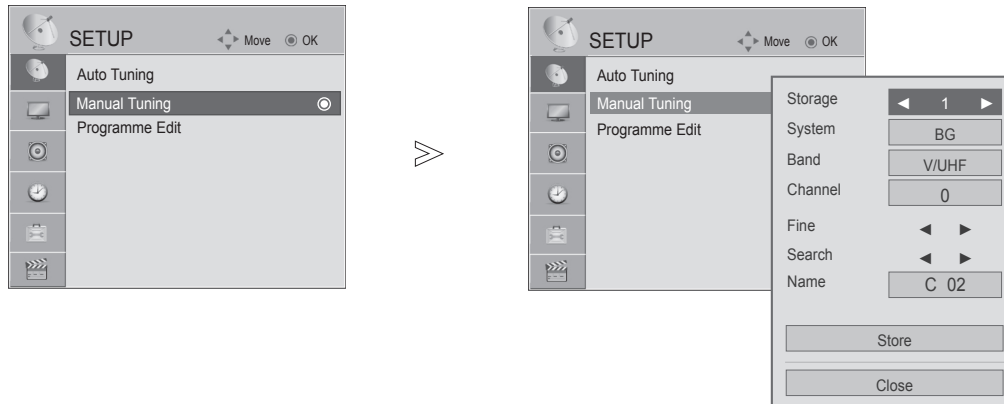

- 1 Select **SETUP**.
- 2 Select **Manual Tuning**.
- 3 or Make appropriate adjustments.
- 4 Select **TV system**.

- 5 Select **V/UHF** or **Cable**.
- 6 or Select the desired channel number.
- 7 Commence searching.
- 8 Select **Store**.

- Press the **Home/EXIT** button to return to normal TV viewing.
- Press the **BACK** button to move to the previous menu screen.

- **BG** : PAL B/G, SECAM B/G (Europe / East Europe / Asia / NewZealand / M.East / Africa / Australia)
- **I** : PAL I/II (U.K. / Ireland / Hong Kong / South Africa)
- **DK** : PAL D/K, SECAM D/K (East Europe / China / Africa / CIS)
- **M** : NTSC-M (USA / Korea / Philippines), PAL-M(South America)
- To store another channel, repeat steps 3 to 8.

# WATCHING TV / PROGRAMME CONTROL

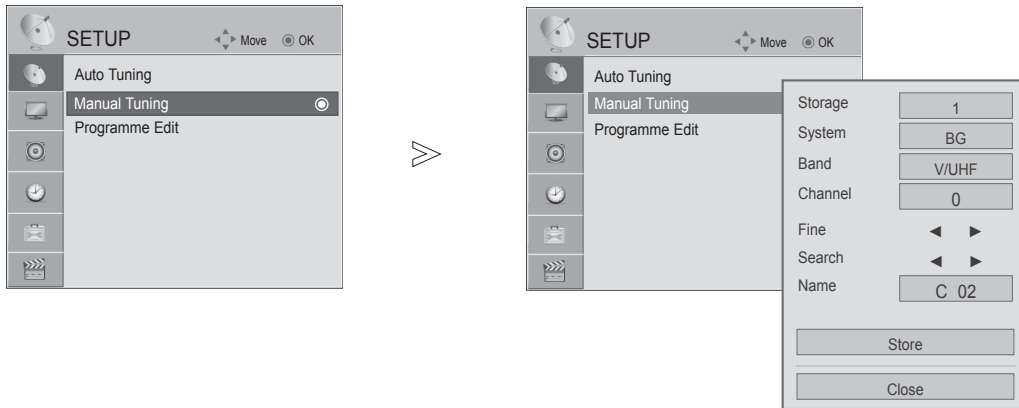

## ■ Assigning a station name

You can assign a station name with five characters to each programme number.

- 1 Select **SETUP**.
- 2 Select **Manual Tuning**.
- 3 Select **Name**.

- Select the position and make your choice of the second character, and so on.  
You can use an the alphabet **A** to **Z**, the number **0** to **9**, **+/-**, and blank.
- 4 Select the character.
  - 5 Select **Store**.
  - 6 Confirm.

## ■ Fine Tuning

Normally fine tuning is only necessary if reception is poor.

- 1 Select **SETUP**.
- 2 Select **Manual Tuning**.
- 3 Select **Fine**.
- 4 Fine tune for the best picture and sound.
- 5 Select **Store**.
- 6 Confirm.

- Press the **Home/EXIT** button to return to normal TV viewing.
- Press the **BACK** button to move to the previous menu screen.





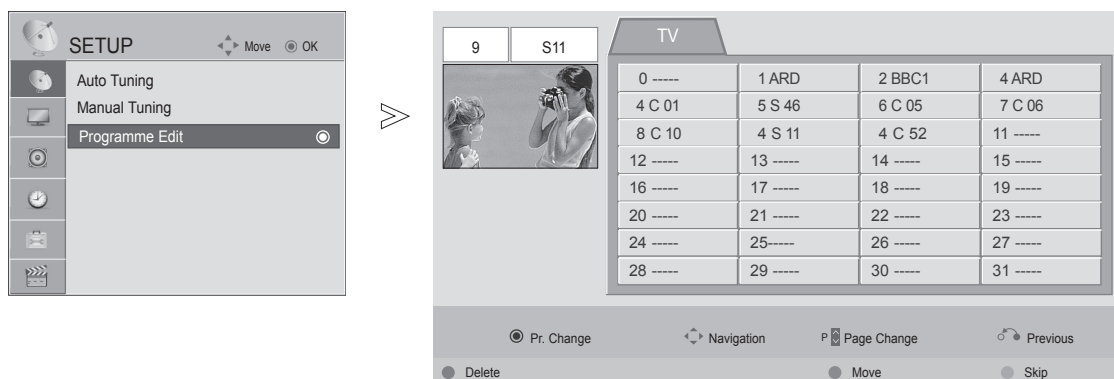

## PROGRAMME EDIT

When a programme number is skipped, it means that you will be unable to select it using **P** ^ v button during TV viewing.

If you wish to select the skipped programme, directly enter the programme number with the **NUMBER** buttons or select it in the Programme edit menu.

This function enables you to skip the stored programmes.



- 1   Select **SETUP**.
- 2   Select **Programme Edit**.
- 3  Enter the **Programme Edit**.
- 4  Select a programme to be stored or skipped.

- Press the **Home/EXIT** button to return to normal TV viewing.
- Press the **BACK** button to move to the previous menu screen.

# WATCHING TV / PROGRAMME CONTROL

This function enables you to delete or skip the stored programmes.  
You can also move some channels and use other programme numbers.

## ■ Deleting a programme

1  Select a programme number to be deleted.

2  Turn the deleted programme number to RED.

3  Release the deleted programme.

• The selected programme is deleted, all the following programmes are shifted up one.

## ■ Moving a programme

1  Select a programme number to be moved.

2   Turn the moved programme number to YELLOW.

3  Release the moved programme.

## ■ Skipping a programme number

1  Select a programme number to be skipped.

2  Turn the skipped programme number to BLUE.

3  Release the skipped programme.

• When a programme number is skipped it means that you will be unable to select it using the **P**  $\wedge$   $\vee$  button during normal TV viewing.  
• If you wish to select a skipped programme, directly enter the programme number with the NUMBER buttons or select it in the programme edit.

# SELECTING THE PROGRAMME LIST

You can check which programmes are stored in the memory by displaying the programme list.



## ■ Displaying programme LIST



Display the **Programme List**.

- You may find some blue programmes. These have been set up to be skipped by auto programming or in the programme edit mode.
- Some programmes with the channel number shown in the programme list indicate there is no station name assigned.

## ■ Selecting a programme in the programme list



Select a programme.



Switch to the chosen programme number.

## ■ Paging through a programme list



Turn the pages.



Return to normal TV viewing.

# WATCHING TV / PROGRAMME CONTROL

## FAVOURITE PROGRAMME SETUP

### ■ Selecting favourite programme

Favorite programmes is a convenient feature that lets you quickly scan up to programmes of your choice without having to wait for the TV to scan through all the in-between programmes.

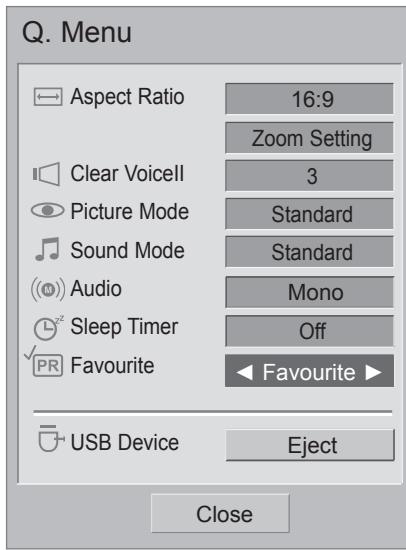

- 1 Select your desired programme.
- 2 Select **Favourite**.
- 3 Select **Favourite**.
- 4 Return to TV viewing.

• This will automatically include the selected programme into your favourite programme list.

### ■ Displaying the favourite programme list

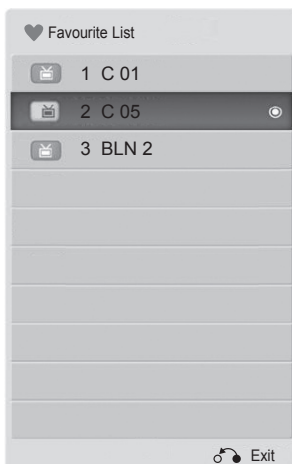

- 1 Display the Favourite Programme List.

# INPUT LIST

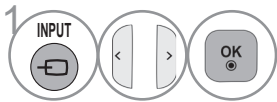
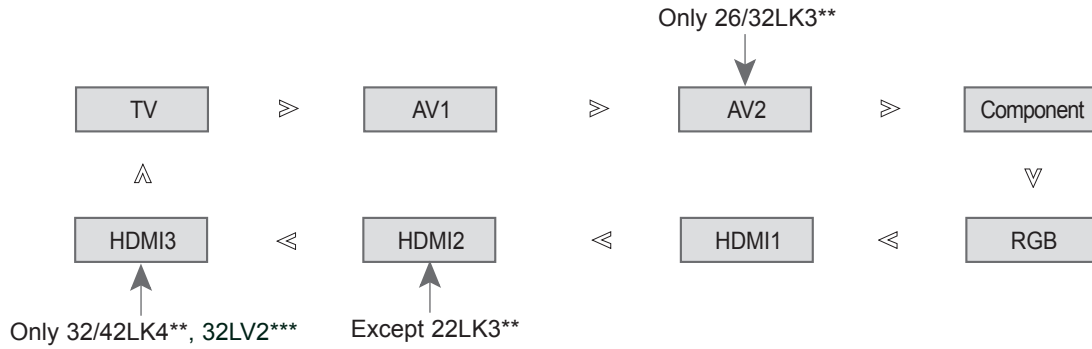

Select the input source.





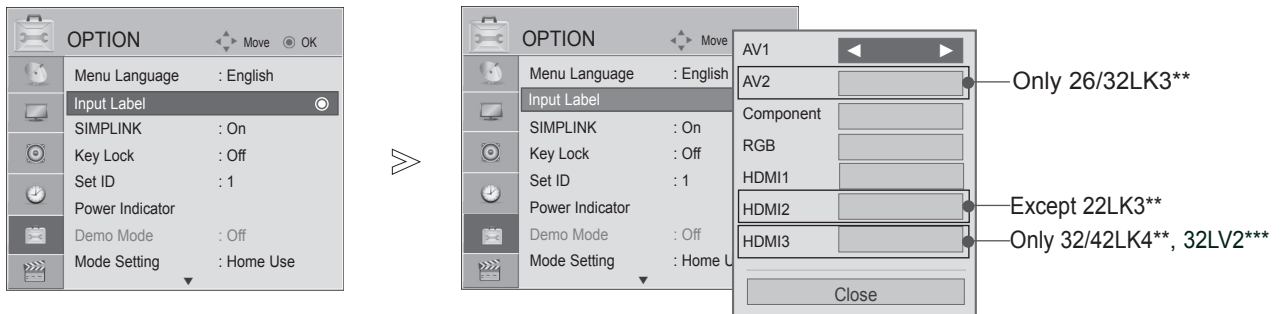

- **TV** : Select it when watching the TV.
- **AV** : Select it when watching the VCR or external equipment.
- **Component** : Select it when using DVD or Digital set-top box depends on connector.
- **RGB** : Select it when using PC depends on connector.
- **HDMI** : Select it when using DVD or Digital set-top box depend on connector.

# WATCHING TV / PROGRAMME CONTROL

## INPUT LABEL

Selects a label for each input source.



- 1   Select **OPTION**.
- 2   Select **Input Label**.
- 3   Select the source.
- 4  Select the label.

- Press the **Home/EXIT** button to return to normal TV viewing.
- Press the **BACK** button to move to the previous menu screen.





This function operates only with devices with the SIMPLINK logo.





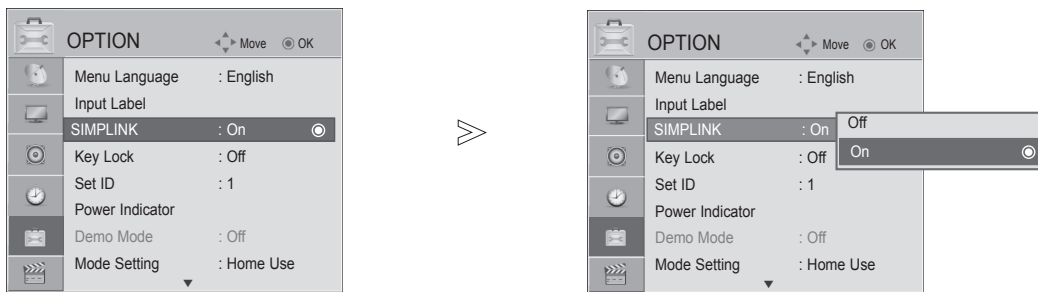

Please check the SIMPLINK logo.

The product might not function properly when using it with other products with HDMI-CEC function.

This allows you to control and play other AV devices connected to the display through HDMI cable without additional cables and settings.

If you do not require the **SIMPLINK** menu, select “**Off**”.



- 1   Select **OPTION**.
- 2   Select **SIMPLINK**.
- 3   Select **On** or **Off**.
- 4  Save.

- Press the **Home/EXIT** button to return to normal TV viewing.
- Press the **BACK** button to move to the previous menu screen.

### NOTE

- ▶ Connect the HDMI/DVI IN or HDMI IN terminal of the TV to the rear terminal and Side terminal (HDMI terminal) of the SIMPLINK device with the HDMI cable.
- ▶ When you switch the Input source using the INPUT button on the remote control, you can stop the operation of a device controlled by SIMPLINK.

# WATCHING TV / PROGRAMME CONTROL

## SIMPLINK FUNCTIONS

### Disc playback

Control connected AV devices by pressing the  $\wedge / \vee / \langle / \rangle$  , OK,  $\blacktriangleright$  ,  $\blacksquare$ , II,  $\blacktriangleleft$  and  $\blacktriangleright$  buttons.

### Direct Play

After connecting AV devices to the TV, you can directly control the devices and play media without additional settings.

### Select AV device

Enables you to select one of the AV devices connected to the TV and operate it.

### Power off all devices

When you switch off the TV, all connected devices are turned off.

### Switch audio-out

Offers an easy way to switch audio-out.

### Sync Power on

When the equipment with Simplink function connected HDMI terminal starts to play, The TV will change automatically to turn on mode.

**\* A device, which is connected to the TV through an HDMI cable but does not support SIMPLINK, does not provide this function.**

Note: To operate SIMPLINK, an High Speed HDMI Cable with \*CEC function should be used. (\*CEC: Consumer Electronics Control).

## SIMPLINK MENU

Press the  $\wedge$   $\vee$   $\langle$   $\rangle$  button and then OK button to select the desired SIMPLINK source.

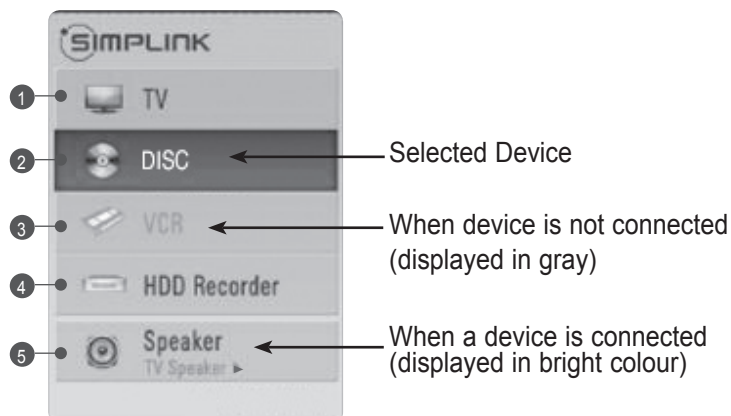

- ① **TV viewing** : Switch to the previous TV programme regardless of the current mode.
- ② **DISC playback** : Select and play connected discs.  
When multiple discs are available, the titles of discs are conveniently displayed at the bottom of the screen.
- ③ **VCR playback** : Play and control the connected VCR.
- ④ **HDD Recordings playback** : Play and control recordings stored in HDD.
- ⑤ **Audio Out to Home theater/Audio Out to TV**: Select Home theater or TV speaker for Audio Out.

# WATCHING TV / PROGRAMME CONTROL

## AV MODE

You can select the optimal images and sounds when connecting AV devices to external input.

- Off** Disables the AV MODE.
- Cinema** Optimizes video and audio for watching movies.
- Sport** Optimizes video and audio for watching sports events.
- Game** Optimizes video and audio for playing games.

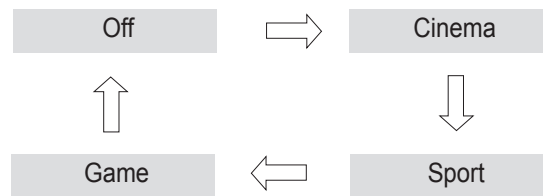

1 Press the **AV MODE** button repeatedly to select the desired source.







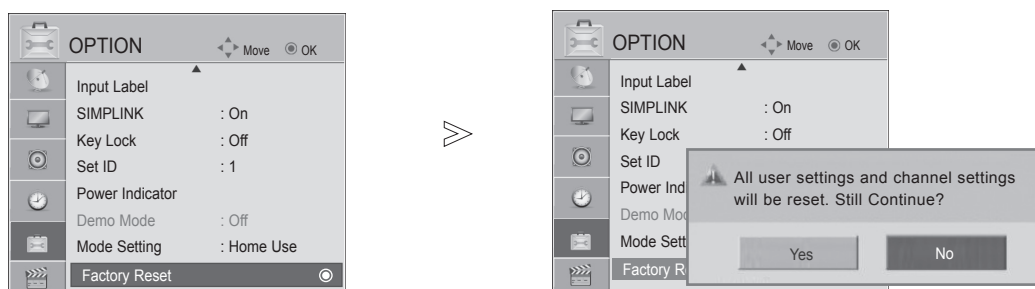

- If you select **Cinema** in AV mode, **Cinema** will be selected both for **Picture Mode** and **Sound Mode** in **PICTURE** menu and **AUDIO** menu respectively.
- If you select “**Off**” in **AV mode**, the picture and image which you initially set will be selected.

## INITIALIZING (RESET TO ORIGINAL FACTORY SETTINGS)

Use to quickly reset all the menu options to their original factory preset values.  
This function deletes all TV programmes.  
When the **Factory Reset** is completed, you must restart the Initializing setup.



- 1   Select **OPTION**.
- 2   Select **Initial Setting**
- 3   Select **Yes**.
- 4  Start Initial Reset.

- Press the **Home/EXIT** button to return to normal TV viewing.
- Press the **BACK** button to move to the previous menu screen.





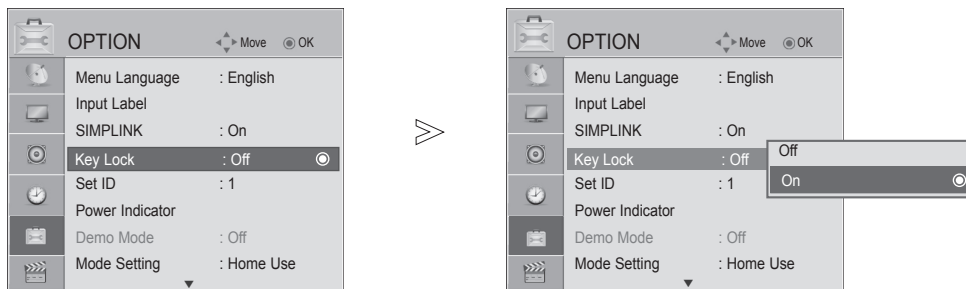

# WATCHING TV / PROGRAMME CONTROL

## KEY LOCK

The TV can be set so that the remote control is required to control it.

This feature can be used to prevent unauthorized viewing.



- 1   Select **OPTION**.
- 2   Select **Key Lock**.
- 3   Select **On** or **Off**.
- 4  Save.

- In **Key Lock 'On'**, if the TV is turned off, to turn on the TV, press the **INPUT**, P $\wedge$ V button on the TV or **POWER INPUT**, P $\wedge$ V or **NUMBER** buttons on the remote control then the set will be turned on.
- With the **Key Lock On**, the display '  **Key Lock On** ' appears on the screen if any button on the front panel is pressed while viewing the TV.

- Press the **Home/EXIT** button to return to normal TV viewing.
- Press the **BACK** button to move to the previous menu screen.

# TO USE A USB DEVICE

## WHEN CONNECTING A USB DEVICE

When you connect a USB device, this pop up menu is displayed, automatically.  
“POP UP MENU” will not be displayed while the OSD including Menu is activated.  
In USB device, you can not add a new folder or delete the existing folder.

■ Image shown may differ from your TV.

- 1 Connect the USB device to the **USB IN** jack on the TV.

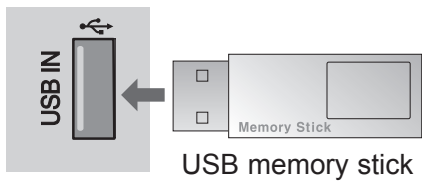

• This TV Supports on JPEG and MP3 and SD DivX.

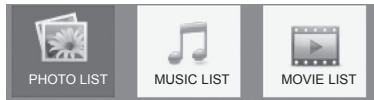

- 2 Select **PHOTO LIST**, **MUSIC LIST** or **MOVIE LIST**.



- 3

### WHEN REMOVING THE USB DEVICE

Select the USB Eject menu before removing the USB device.

- 1   Select **Eject**.
- 2 

# TO USE A USB DEVICE

## PRECAUTIONS WHEN USING THE USB DEVICE

- ▶ Only a USB storage device is recognizable.
- ▶ If the USB storage device is connected through a USB hub, the device is not recognizable.
- ▶ A USB storage device using an automatic recognition programme may not be recognized.
- ▶ A USB storage device which uses its own driver may not be recognized.
- ▶ The recognition speed of a USB storage device may depend on each device.
- ▶ Please do not turn off the TV or unplug the USB device when the connected USB storage device is working. When such device is suddenly separated or unplugged, the stored files or the USB storage device may be damaged.
- ▶ Please do not connect the USB storage device which was artificially maneuvered on the PC. The device may cause the product to malfunction or fail to be played. Never forget to use only a USB storage device which has normal music files or image files.
- ▶ Please use only a USB storage device which was formatted as a FAT16, FAT32, NTFS file system provided with the Windows operating system. In case of a storage device formatted as a different utility programme which is not supported by Windows, it may not be recognized.  
Data in a USB storage device cannot be deleted in the NTFS file system.
- ▶ Please connect power to a USB storage device which requires an external power supply. If not, the device may not be recognized.
- ▶ Please connect a USB storage device with cable is offered by USB maker. If connected with cable is not offered by USB maker or an excessively long cable, the device may not be recognized.
- ▶ Some USB storage devices may not be supported or operated smoothly.
- ▶ Maximum of 999 files and 200 folders can be recognized.
- ▶ Data in a USB storage device cannot be aligned.
- ▶ Up to 128 English characters can be recognized as a file name.
- ▶ Please back up the important file because a data of USB device may be damaged. Data management is consumer's responsibility and in consequence the manufactures does not cover the product bearing data damage.
- ▶ If the USB is connected in Standby Mode, specific hard disk will automatically be loaded when the TV is turned on.
- ▶ The recommended capacity is 1 TB or less for a USB external hard disk and 32 GB or less for USB memory.
- ▶ TV need more time to detect if the storage size is bigger. If the USB memory is connected in Standby Mode, power on time would be longer than without memory.
- ▶ Any device with more than the recommended capacity may not work properly.
- ▶ If a USB external hard disk with a "Energy Saving" function does not work, turn the hard disk off and on again to make it work properly.



# PHOTO LIST

You can view photo files on USB storage device.

The On Screen Display may be different from your TV. Images are an example to assist with the TV operation. When you are watching the photo by the Photo List function, you can not change the picture mode.

PHOTO(\*.JPEG) supporting file  
 Baseline: Max 4800 x no limit  
 Min 64 X 64

- Not support to progressive jpeg.
- You can play JPEG files only.
- Only baseline scan is supported among JPEG (SOF0, SOF1 only).
- Non-supported files are displayed in the form of bitmap.

## SCREEN COMPONENTS

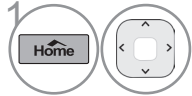

1 Select **USB**.

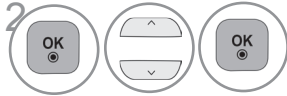

2 Select **Photo List**.

- 1 Moves to upper level folder
- 2 Current page/Total pages
- 3 Total number of marked photos
- 4 Corresponding buttons on the remote control



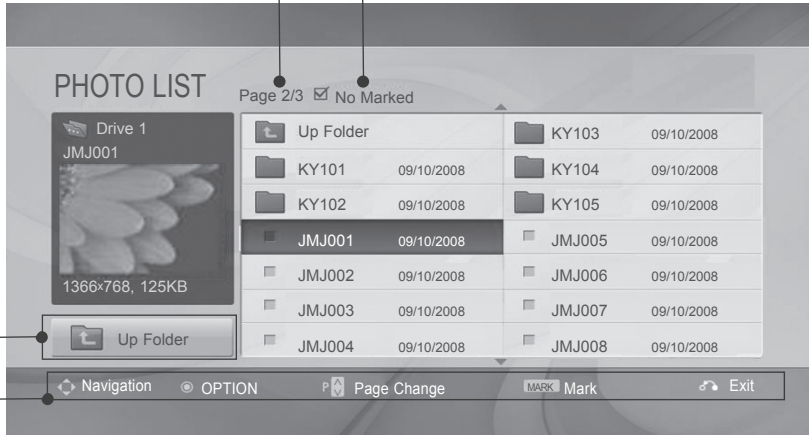



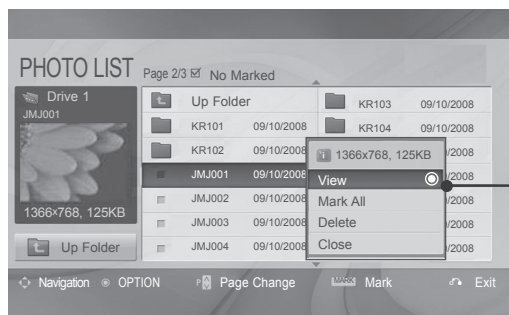
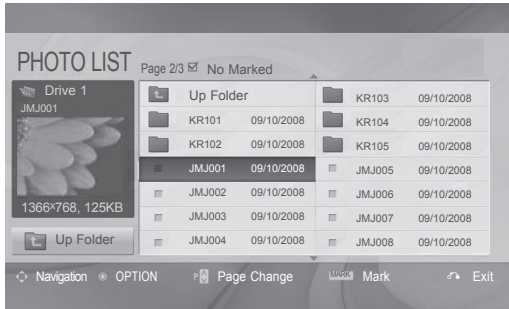

The screenshot shows a 'PHOTO LIST' screen. At the top, it says 'Page 2/3' and 'No Marked'. Below this is a grid of folders and files. A folder named 'JMJO01' is selected. The bottom navigation bar includes buttons for 'Navigation', 'OPTION', 'Page Change', 'MARK Mark', and 'Exit'.

# TO USE A USB DEVICE

## PHOTO SELECTION AND POPUP MENU



- ▶ **View** : Display the selected item.
- ▶ **Mark All** : Mark all photos on the screen.
- ▶ **Unmark All** : Deselect all marked photos.
- ▶ **Delete** : Delete the selected photo item.
- ▶ **Close** : Close the pop-up menu.

- 1  Select the target folder or drive.
- 2   Select the desired photos.
- 3  Show the PopUp menu.
- 4   Select the desired PopUp menu.

- Use the **P**  $\wedge$  **v** button to navigation in the photo page.
- Use the **MARK** button to mark or unmark a photo. When one or more photos are marked, you can view each marked photo or a slide show of the marked photos. If no photos are marked, you can view every individual photo in the folder or a slide show of all photos in the folder.





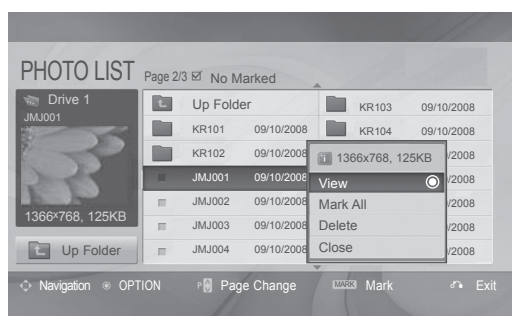
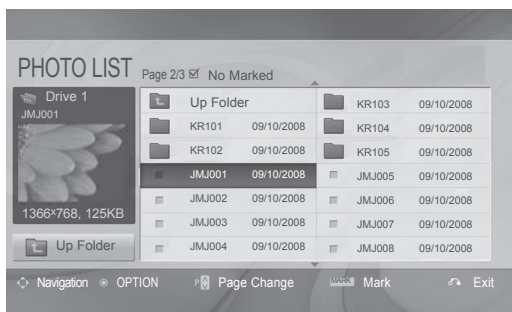

• Press the **BACK** button to return to normal TV viewing.

## SET UP THE MENU IN FULL-SIZED SCREEN



You can change the settings to display photos stored on a USB device, on a full-sized screen. Detailed operations are available on full-sized photo view screen.



The aspect ratio of a photo may change the size of the photo displayed on the screen in full size. Press the **BACK** button to move to the previous menu screen.

- 1  Select the target folder or drive.
- 2   Select the desired photos.
- 3  Show the PopUp menu.
- 4  Select **View**.
- 5  The selected photo is displayed in full size.



# TO USE A USB DEVICE

6  Select the **Slideshow**, **BGM**,  (**Rotate**), **Delete** or **Hide**.



- Use < > button to select the previous or next photo.
- Use < > button to select and control the menu on the full-sized screen.

TO USE A USB DEVICE

- ▶ **Slideshow** : When no picture is selected, all photos in the current folder are displayed during slide show. If some photos are selected, those photos are displayed in a slide show.
  - Set the time interval of the slide show in **Option**.
- ▶ **BGM** (Background Music) : Listen to music while viewing photos in full size.
  - Set the Music Folder for BGM in Options before using this function.
- ▶  (**Rotate**) : Rotate photos.
  - Rotates the photo 90°, 180°, 270°, 360° clockwise.
- ▶ **Delete** : Delete photos.
- ▶ **Option** : Set values for **Slide Speed** and **Music Folder**.
  - Use ^ v < > button and **OK** button to set values. Then go to  and press **OK** to save the settings.
  - You cannot change **Music Folder** while BGM is playing.
- ▶ **Hide** : Hide the menu on the full-sized screen.
  - To see the menu again on the full-sized screen, press **OK** button to display.

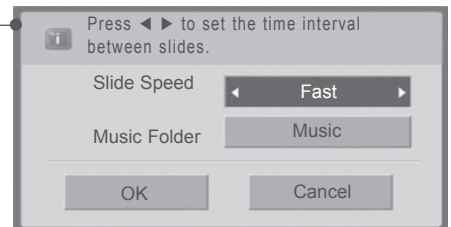

# MUSIC LIST



Purchased music files(\*.MP3) may contain copyright restrictions. Playback of these files may not be supported by this model.



Music file on your USB device can be played by this unit.

The On Screen Display may be different from your TV. Images are an example to assist with the TV operation.

MUSIC (\*.MP3) supporting file  
 Bit rate : 32 k to 320kbps  
 Sampling rate MPEG1 layer 3 : 32 k to 48 kHz

## SCREEN COMPONENTS

**1**   Select **USB**.

**2**    Select **Music List**.



The screenshot shows a 'MUSIC LIST' interface. At the top, it says 'Page 2/3' and 'No Marked'. Below this is a table with columns for 'Title' and 'Duration'. The table contains several entries, including 'Up Folder', 'Favorite Music', 'Favorite Music No.2', 'Velvet Goldmine (OST vers2)', 'Good Bye (Original Ver.)', and 'Urban Nite (Feat.Amin.J)'. A 'Music' player preview is visible on the left side of the screen, showing a music note icon and a progress bar from 00:00 to 01:34. At the bottom of the screen, there is a navigation bar with buttons for 'Navigation', 'OPTION', 'Page Change', 'MARK', 'Mark', and 'Exit'. A box labeled '1' highlights the 'Up Folder' button in the table. A box labeled '2' highlights the 'OK' button above the table. A box labeled '3' highlights the 'No Marked' text. A box labeled '4' highlights the 'OPTION' button in the navigation bar.

- ① Moves to upper level folder
- ② Current page/Total pages
- ③ Total number of marked music title
- ④ Corresponding buttons on the remote control

# TO USE A USB DEVICE

## MUSIC SELECTION AND POPUP MENU

As shown, up to 6 music titles are listed per page.

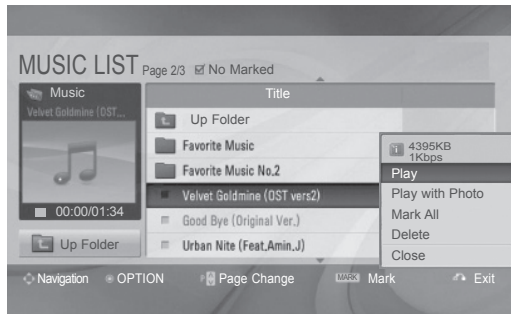
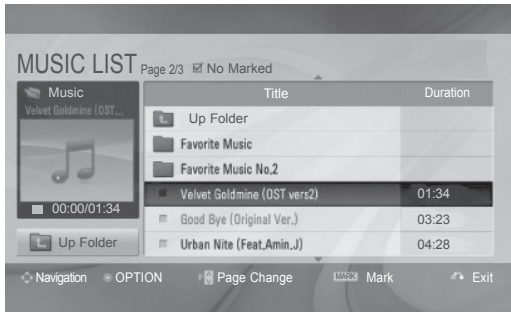

► **Play** (During stop) : Play the selected music titles.

Once a music finishes playing, the next selected one will be played. When there are no selected music titles to play, the next one in the current folder will be played.

► **Play Marked** : Play the selected music titles. Once a music finishes playing, the next selected one will be played automatically.

► **Stop Play** (During playback) : Stop the playing music titles.







► **Play with Photo** : Start playing the selected music titles and then move to the Photo List.

► **Mark All** : Mark all music titles in the folder.

► **Unmark All** : Deselect all marked music titles.

► **Delete** : Delete the selected music titles.

► **Close** : Close the pop-up menu.

- 1  Select the target folder or drive.
- 2   Select the desired music title.
- 3  Show the PopUp menu.
- 4   Select the desired PopUp menu.







- Use the **P**  $\wedge$   $\vee$  button to navigate up/down in the music page.
- Use **MARK** button to mark or unmark a music. When one or more music files are marked, the marked music title will be played in sequence. For example, if you want to listen to only one music repeatedly, just mark the music only and play it. If no music is marked, all the music in the folder will be played in sequence.

• Press the **BACK** button to return to normal TV viewing.

- If you don't press any button for a while during the playing, the play information box (as shown in the below) will float as a screen saver.
- The 'Screen Saver'?  
Screen saver is to prevent screen pixel damage due to an fixed image remaining on the screen for a extended period of time.



## ! NOTE

- ▶ When a music file is played,  is displayed behind the title.
- ▶ A damaged or corrupted music does not play but displays 00:00 in playtime.
- ▶ A music downloaded from a paid service with copyright protection does not start but displays inappropriate information in playtime.
- ▶ If you press OK, , screen saver is stopped.
- ▶ This TV can not play music files less than 32 Kbytes.
- ▶ The PLAY(▶), Pause(II), , ,  buttons on the remote control are also available in this mode.
- ▶ You can use the  button to select the next music and the  button to select the previous music.

# TO USE A USB DEVICE

## MOVIE LIST

The movie list is activated once USB is detected. It is used when playing movie files on TV.  
 Displays the movies in the USB folder and supports Play.  
 Allows playback of all movies in the folder and user desired files.  
 Editing such as delete and add is not allowed.  
 It is a movie list that displays folder information and DivX file.  
 Supports up to four drives.

MOVIE(\*.avi/\*.DivX) supporting file

Video format : MPEG1 , MPEG2, MPEG4 (Doesn't support Microsoft MPEG4-V2, V3), DivX 3.xx , DivX 4.xx, DivX 5.xx , DivX VOD ( DRM ) , XviD, DivX 6.xx(Playback)

Audio format : Mpeg, Mp3, PCM, Dolby Digital, AC3.

Sampling frequency : 32 k to 48 kHz

Bit rate : 32 k to 320 kbps

Subtitle format : \*.smi/ \*.srt/ \*.sub(MicroDVD, SubViewer 2.0)/ \*.ass/ \*.ssa/\*.txt(DVD Subtitle System)

- Time information in an external subtitle file should be arranged in ascending order to be played.
- A DivX movie file and its subtitle file must be located in the same folder.
- A video file name and its subtitle file name must be identical for it to be displayed.
- If the video and audio structure of recorded file is not interleaved, either video or audio is outputted.
- Playing a video via a USB connection that does not support high speed may not work properly.
- USB storage devices below USB 2.0 are supported as well. But they may not work properly in the movie list
- DivX may not be played depending on its types or recording methods.
- **Max bitrate of playable DivX is 6 Mbps.**
- Maximum FPS (Frame Per Second) can be reached only at SD level. FPS is 25 FPS (720\*576) or 30 FPS (720\*480) depending on Resolution.
- Files of 25 FPS or 30 FPS of higher may not be played properly.
- If the file is recorded with GMC, the unit supports only 1 point of recorded level.  
 (GMC is the acronym for Global Motion Compensation, a technique used to compensate MPEG Video files.)
- Use the left/right ( < / > ) keys to move to a specific frame forward or backward while playing a movie.  
 (The left/right ( < / > ) keys may not work properly for some files while playing a movie.)

Extension name	Video Decoder	Audio Codec	Resolution
mpg, mpeg, mpe, vob, dat	MPEG1, MPEG2	AC3,MPEG,MP3,PCM	
Avi, DivX, m4v	MPEG 4-SP, MPEG4-ASP, DivX 3.xx,DivX 4.xx, DivX 5.xx, DivX 6.xx(Playback),Xvid	AC3,MPEG,MP3,PCM	720x576@25p 720x480@30p



# SCREEN COMPONENTS

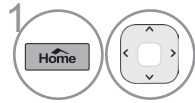

Select **USB**.

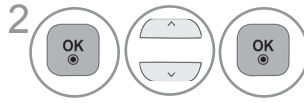

Select **Movie List**.

- ❶ Moves to upper level folder
- ❷ Current page/Total pages
- ❸ Total number of marked movie title
- ❹ Corresponding buttons on the remote control

The screenshot shows a 'MOVIE LIST' screen with the following elements:

- ❶** Points to the 'Up Folder' button at the bottom left of the movie preview area.
- ❷** Points to the 'Page 2/3' indicator at the top right of the list.
- ❸** Points to the 'No Marked' checkbox at the top right of the list.
- ❹** Points to the 'OPTION' button at the bottom center of the screen.

Title	Duration
Up Folder	
Favorite Music	
The Aviator_(2004)_5CH_AC3_2CD	
Apple_(1992).Dvdrip	01:34:45
The Incredibles [REPACK_AC3_5.1c-CiM	01:15:30
The Incredibles [REPACK_AC3_5.1c-CiM	01:30:20

TO USE A USB DEVICE





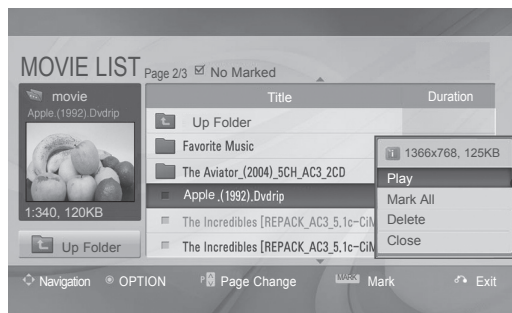
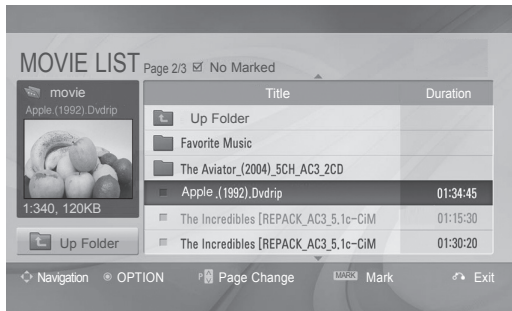

# TO USE A USB DEVICE

## MOVIE SELECTION AND POPUP MENU



- ▶ **Play** : Play the selected movie titles. DivX Play is executed while screen changes.
- ▶ **Play Marked** : Play the selected movie titles. Once a movie finishes playing, the next selected one will be played automatically.
- ▶ **Mark All I** : Mark all movie titles in the folder.
- ▶ **Unmark All I** : Deselect all marked movie titles.
- ▶ **Delete** : Delete the selected movie titles.
- ▶ **Close** : Close the pop-up menu.

TO USE A USB DEVICE

- 1  Select the target folder or drive.
- 2   Select the desired movie title
- 3  Show the PopUp menu.
- 4   Select the desired PopUp menu.

• In the case of files not supported, a message regarding non-supported file is displayed.

• Press the **BACK** button to return to normal TV viewing.

## DIVX AUDIO LANGUAGE & SUBTITLE LANGUAGE



Subtitle Language	Support Language
Latin1	French, Spanish, Catalan Basque, Portuguese, Italian, Albanian, Rhaeto-Romanic, Dutch, German, Danish, Swedish, Norwegian, Finnish, Faroese, Icelandic, Irish, Scottish, English
Latin2	Czech, Hungarian, Polish, Romanian, Croatian, Slovak, Slovenian, Sorbian
Latin4	Estonian, the Baltic languages Latvian(Lettish) and Lithuanian, Greenlandic and Lappish
Latin5	English, Turkish
Cyrillic	Bulgarian, Byelorussian, Macedonian, Russian, Serbian and pre-1990 (no ghe with upturn) Ukrainian
Greek	English, modern Greek
Hebrew	English, modern Hebrew
Chinese	Chinese
Thai	Thai
Arabic	English, Arabic



1 Select the desired PopUp menu.



2 Select **Picture Size, Subtitle Language, Audio Language, Subtitle, Language, Sync** or **Position**

• When DivX is playing, if you press the **RED** button, this message is displayed.

- Press the **Home/EXIT** button to return to normal TV viewing.
- Press the **BACK** button to move to the previous menu screen.

## USING THE REMOTE CONTROL

◀◀ / ▶▶	<p>When playing, repeatedly, press the <b>REW</b>(◀◀) button to speed up ◀◀ -&gt; ◀◀◀◀ -&gt; ◀◀◀◀◀◀ -&gt; ◀◀◀◀◀◀◀◀ -&gt; ◀◀◀◀◀◀◀◀◀◀◀◀ .</p> <p>repeatedly, press the <b>FF</b>(▶▶) button to speed up ▶▶ -&gt; ▶▶▶▶ -&gt; ▶▶▶▶▶▶ -&gt; ▶▶▶▶▶▶▶▶ -&gt; ▶▶▶▶▶▶▶▶▶▶ .</p> <ul style="list-style-type: none"> <li>■ Pressing these buttons repeatedly increases the fast forward/reverse speed.</li> </ul>
	<p>During playback, press the <b>Pause</b>(  ) button.</p> <ul style="list-style-type: none"> <li>■ Still screen is displayed.</li> </ul>
<>	<ul style="list-style-type: none"> <li>■ When using the &lt; or &gt; button during playback a cursor indicating the position can be viewed on the screen.</li> </ul>
<b>PLAY</b> (▶)	<p>Press the <b>PLAY</b>(▶) button to return to normal playback.</p>

# TO USE A USB DEVICE

## DIVX REGISTRATION CODE

Confirm the DivX registration code number of the TV. Using the registration number, movies can be rented or purchased at [www.divx.com/vod](http://www.divx.com/vod).

With a DivX registration code from other TV, playback of rented or purchased DivX file is not allowed. (Only DivX files matched with the registration code of the purchased TV are playable.)

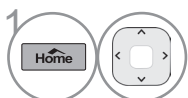
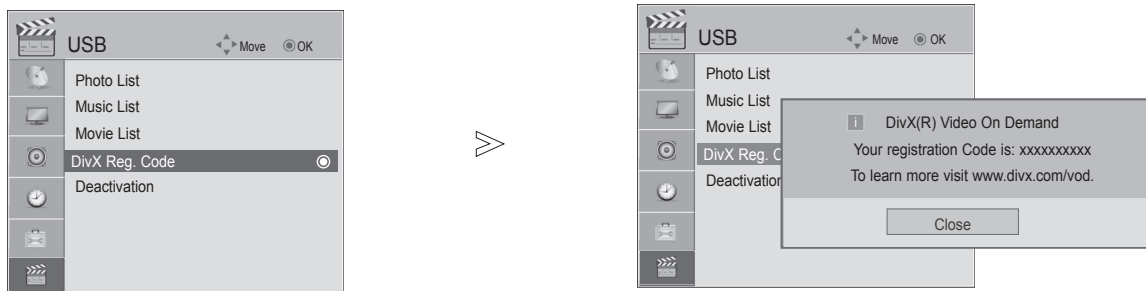

Select **USB**.

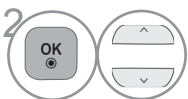

Select **DivX Reg. Code**.



Display DivX Reg. Code.

- Press the **Home/EXIT** button to return to normal TV viewing.
- Press the **BACK** button to move to the previous menu screen.



Manufactured under license from Dolby Laboratories. "Dolby" and the double-D symbol are trademarks of Dolby Laboratories.



**ABOUT DIVX VIDEO:** DivX® is a digital video format created by DivX, Inc. This is an official DivX Certified® device that plays DivX video. Visit [www.divx.com](http://www.divx.com) for more information and software tools to convert your files into DivX video.

**ABOUT DIVX VIDEO-ON-DEMAND:** This DivX Certified® device must be registered in order to play purchased DivX Video-on-Demand (VOD) movies. To obtain your registration code, locate the DivX VOD section in your device setup menu. Go to [vod.divx.com](http://vod.divx.com) for more information on how to complete your registration.

"DivX Certified® to play DivX® video, including premium content"

DivX®, DivX Certified® and associated logos are trademarks of DivX, Inc. and are used under license.

Covered by one or more of the following U.S. patents : 7,295,673; 7,460,668; 7,515,710; 7,519,274

### NOTE

Supported movie file

Resolution : under 720 x 480(720x576) WxH pixels.

Frame rate : under 30 frames/sec





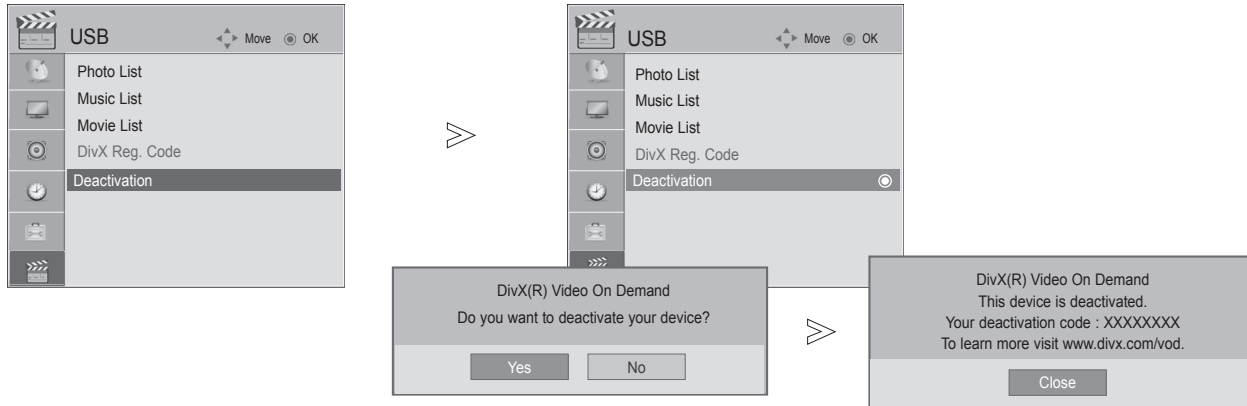

- ▶ Video Codec : MPEG1, MPEG2, MPEG4(Doesn't support Microsoft MPEG4-V2, V3), DivX3.xx, DivX4.xx, DivX5.xx, DivX VOD(DRM), XviD, DivX 6.xx(Playback).
- ▶ When loading, some buttons may not work.
- ▶ If you use the DivX registration code of another device, the rented or purchased DivX file cannot be played. Therefore always use the DivX registration code assigned to this product.

# DEACTIVATION

Delete the existing authentication information to receive a new DivX user authentication for TV.

Once this function is executed, a DivX user authentication is required again to see DivX DRM files.



-   Select **USB**.
-   Select **Deactivation**.
-   Select **Yes**.
- 

- Press the **Home/EXIT** button to return to normal TV viewing.
- Press the **BACK** button to move to the previous menu screen.



# PICTURE CONTROL

## PICTURE SIZE (ASPECT RATIO) CONTROL

You can watch the screen in various picture formats; **16:9**, **Just Scan**, **Original**, **4:3**, **14:9**, **Zoom** and **Cinema Zoom1**.

If a fixed image is displayed on the screen for a long time, that fixed image may become imprinted on the screen and remain visible.

1   Select **Aspect Ratio**.

2   Select the desired picture format.

• You can also adjust **Aspect Ratio** in the **PICTURE** or **Q.Menu** menu.

### • 16:9

The following selection will allow you to adjust the picture horizontally, in linear proportion, to fill the entire screen (useful for viewing 4:3 formatted DVDs).



### • Just Scan

Following Selection will lead to you view the picture of best quality without loss of original picture in high resolution image.

Note : If there is noise in original Picture, You can see the noise at the edge.

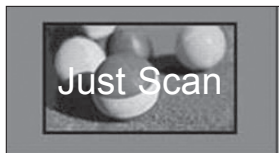

### • Original

When your TV receives a wide screen signal it will automatically change to the picture format broadcast.



### • 4:3

The following selection will allow you to view a picture with an original 4:3 aspect ratio, gray bars will appear on both the left and right of the screen.



• **14:9**

You can view a picture format of 14:9 or a general TV programme in the 14:9 mode. The 14:9 screen is viewed in the same way as in 4:3, but is magnified to the left and right.

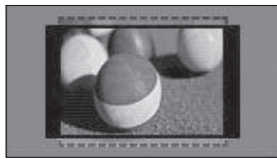

• **Cinema Zoom1**

Choose Cinema Zoom1 when you want to enlarge the picture in correct proportion.

Note: When enlarging or reducing the picture, the image may become distorted.

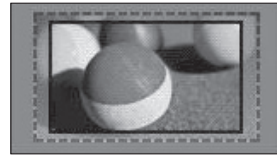

• **Zoom**

The following selection will allow you to view the picture without any alteration, while filling the entire screen. However, the top and bottom of the picture will be cropped.

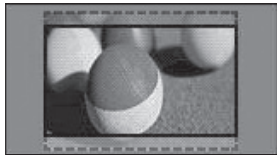

**! NOTE**

- ▶ You can only select **4:3**, **16:9 (Wide)** in RGB mode only.
- ▶ In HDMI/Component (over 720p) mode, **Just Scan** is available.

# PICTURE CONTROL





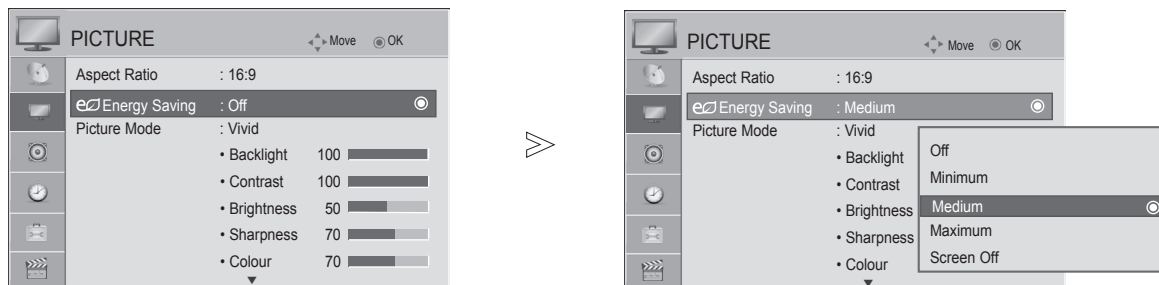

## e ENERGY SAVING

It reduces the plasma display's power consumption.

The default factory setting complies with the Energy Star requirements and is adjusted to the comfortable level to be viewed at home.

You can increase the brightness of your screen by adjusting the Energy Saving level or by setting the Picture Mode.



- 1   Select **PICTURE**.
- 2   Select **e ENERGY SAVING**.
- 3   Select **Off, Minimum, Medium, Maximum** or **Screen Off**.
- 4 

- When selecting Screen Off, the screen will be turned off after 3 seconds. In this case, if you want turn the screen on, press any key on the set or the remote control or play the USB.
- If you adjust “**Energy Saving-Minimum, Medium, Maximum**”, **Backlight** feature will not work.
- You can also adjust **Energy Saving** button.

- Press the **Home/EXIT** button to return to normal TV viewing.
- Press the **BACK** button to move to the previous menu screen.







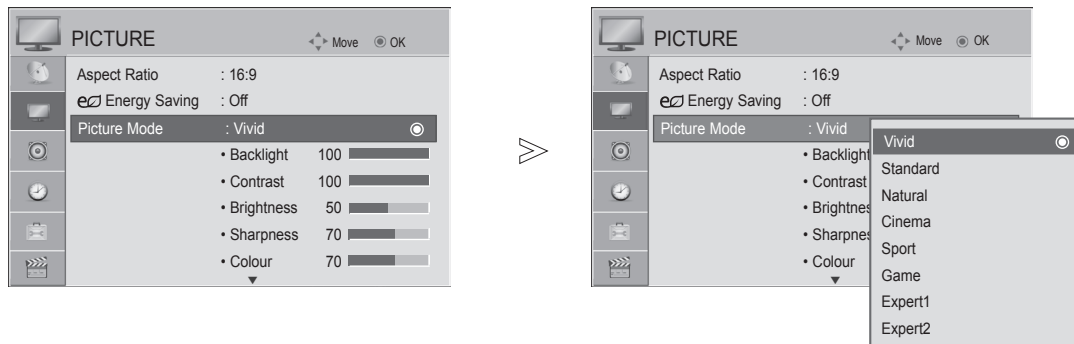

# PRESET PICTURE SETTINGS

## PICTURE MODE-PRESET

<b>Vivid</b>	Strengthen the contrast, brightness, colour and sharpness for vivid picture.
<b>Standard</b>	The most general screen display status.
<b>Natural</b>	The most natural screen display status.
<b>Cinema</b>	Optimizes video for watching movies.
<b>Sport</b>	Optimizes video for watching sports events.
<b>Game</b>	Optimizes video for playing games.



- 1   Select **PICTURE**.
- 2   Select **Picture Mode**.
- 3   Select **Vivid, Standard, Natural, Cinema, Sport or Game**.
- 4 

- **Picture Mode** adjusts the TV for the best picture appearance. Select the preset value in the **Picture Mode** menu based on the programme category.
- You can also adjust **Picture Mode** in the **Q. Menu**.

- Press the **Home/EXIT** button to return to normal TV viewing.
- Press the **BACK** button to move to the previous menu screen.

# PICTURE CONTROL

## MANUAL PICTURE ADJUSTMENT

### PICTURE MODE-USER OPTION

#### Backlight

To control the brightness of the screen, adjust the brightness of LCD panel.  
Adjusting the backlight when setting the brightness of the set is recommended.

#### Contrast

Adjusts the signal level between black and white in the picture.

#### Brightness

Adjusts the base level of the signal in the picture.

#### Sharpness

Adjusts the level of crispness in the edges between the light and dark areas of the picture.  
The lower the level, the softer the image.









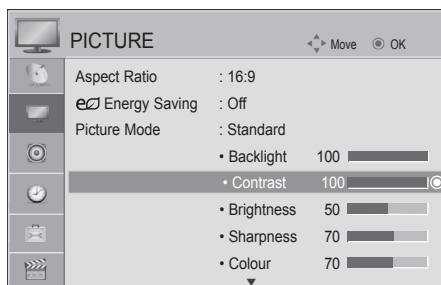

#### Colour

Adjusts intensity of all colours.

#### Tint

Adjusts the balance between red and green levels.



-   Select **PICTURE**.
-   Select **Picture Mode**.
-   Select **Vivid, Standard, Natural, Cinema, Sport or Game**.
-   Select **Backlight, Contrast, Brightness, Sharpness, Colour or Tint**.
-   Make appropriate adjustments.

#### • Benefits of using Backlight

- The electricity consumption is reduced by up to 60 %.
- The black brightness is reduced. (As the black has greater depth, you can enjoy a better quality definition.)
- You can adjust brightness with maintaining original signal resolution.

- Press the **Home/EXIT** button to return to normal TV viewing.
- Press the **BACK** button to move to the previous menu screen.

### ! NOTE

- ▶ You cannot adjust colour, sharpness and tint in the RGB-PC mode.

# PICTURE IMPROVEMENT TECHNOLOGY

You can calibrate the screen for each Picture Mode or set the video value according to the special video screen.

you can set the video value differently for each input.

To reset to the factory default screen after making adjustment to each video mode, execute the “Picture Reset” function for each Picture Mode.

■ Image shown may differ from your TV.

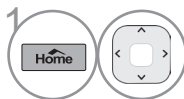
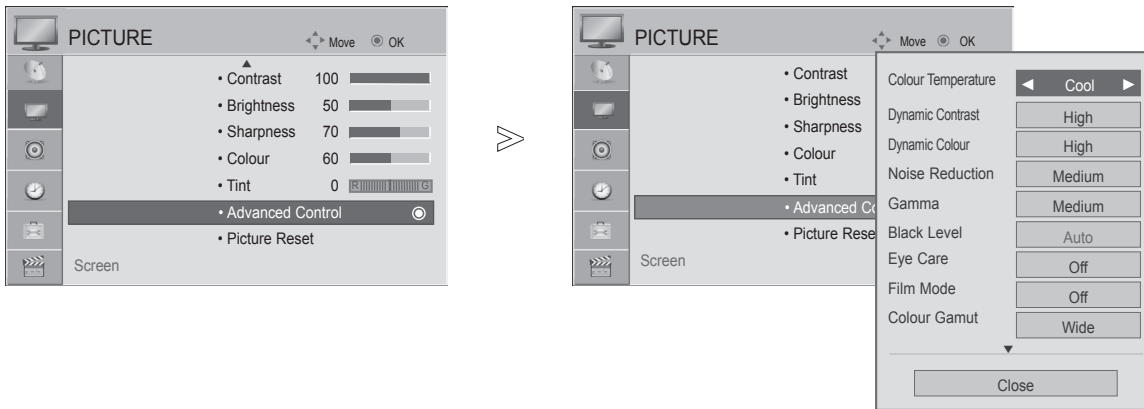

1 Select **PICTURE**.

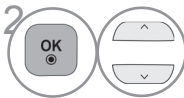

2 Select **Advanced Control**.

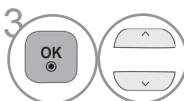

3 Select **Colour Temperature, Dynamic Contrast, Dynamic Colour, Noise Reduction, Gamma, Black Level, Eye Care, Film Mode, Colour Gamut, Edge Enhancer or OPC. (Refer to p.53 to 54).**



4 Select your desired Source.

- Press the **Home/EXIT** button to return to normal TV viewing.
- Press the **BACK** button to move to the previous menu screen.







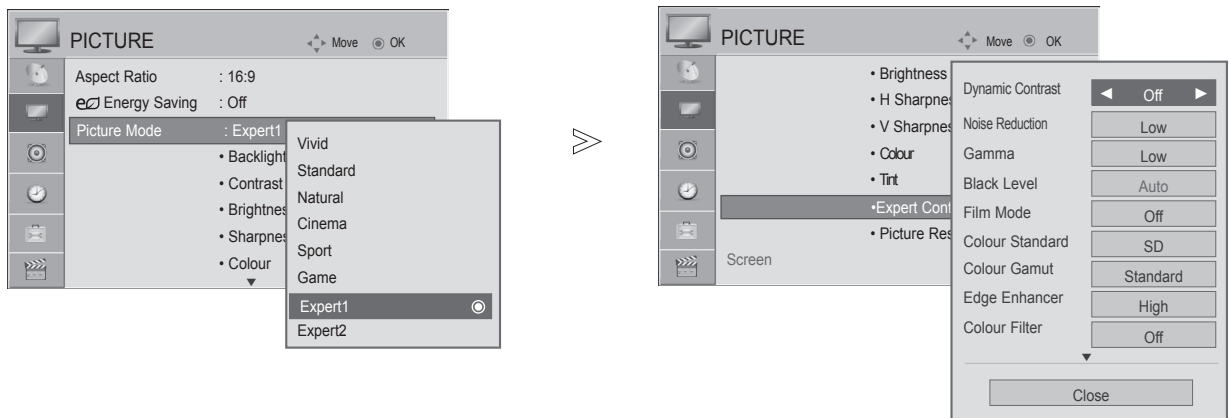

# PICTURE CONTROL

## EXPERT PICTURE CONTROL

By segmenting categories, **Expert1** and **Expert2** provide more categories which users can set as they see fit, offering the optimal picture quality for users.

As the detail item for video quality experts to adjust the video precisely using specific videos, this may not be effective for general videos.



-   Select **PICTURE**.
-   Select **Picture Mode**.
-   Select **Expert1** or **Expert2**
-   Select **Expert Control**
-   Select your desired Source.
-  Make appropriate adjustments.

- Press the **Home/EXIT** button to return to normal TV viewing.
- Press the **BACK** button to move to the previous menu screen.

- This feature is not available for all models.

Colour Temperature (Warm/Medium/Cool)	<ul style="list-style-type: none"> <li>■ Choose one of three automatic colour adjustments. Set to warm to enhance hotter colours such as red, or set to cool to make picture bluish</li> </ul>
Dynamic Contrast (Off/Low/Medium/High)	<ul style="list-style-type: none"> <li>■ Adjusts the contrast to keep it at the best level according to the brightness of the screen. The picture is improved by making bright parts brighter and dark parts darker.</li> </ul>
Dynamic Colour (Off/Low/High )	<ul style="list-style-type: none"> <li>■ Adjusts screen colours so that they look livelier, richer and clearer. This feature enhances hue, saturation and luminance so that red, blue, green and white look more vivid.</li> </ul>
Noise Reduction (Off/Low/Medium/High)	<ul style="list-style-type: none"> <li>■ Reduces screen noise without compromising video quality.</li> </ul>
Gamma (Low/Medium/High)	<ul style="list-style-type: none"> <li>■ You can adjust brightness of dark area and middle gray level area of the picture. <ul style="list-style-type: none"> <li>• <b>Low</b> : Make brighter and middle gray level area of the picture brighter.</li> <li>• <b>Medium</b>: Express original picture levels.</li> <li>• <b>High</b>: Make dark and middle gray level area of the picture darker.</li> </ul> </li> </ul>
Black Level (Low/High)	<ul style="list-style-type: none"> <li>• <b>Low</b> : The picture of the screen gets darker.</li> <li>• <b>High</b> : The picture of the screen gets brighter.</li> <li>• <b>Auto</b> : Realizing the black level of the screen and set it to High or Low automatically. <ul style="list-style-type: none"> <li>■ Set black level of the screen to proper level.</li> <li>■ This function enables to select 'Low' or 'High' in the following mode: AV(NTSC-M), HDMI or Component. Otherwise, 'Black level' is set to 'Auto'.</li> </ul> </li> </ul>
Eye Care (On/Off)	<ul style="list-style-type: none"> <li>* This feature is not available for all models.</li> <li>■ Adjust the brightness of the screen to prevent the screen from being too bright. Dims extremely bright pictures.</li> <li>■ This feature is disable in “<b>Picture Mode-Vivid, Cinema, Intelligent Sensor</b>”.</li> </ul>
Film Mode (On/Off)	<ul style="list-style-type: none"> <li>■ You can watch a cinema-like video by eliminating judder effect.</li> <li>■ Use this function when you watch movies.</li> <li>■ This function can work when TruMotion is off.</li> </ul>





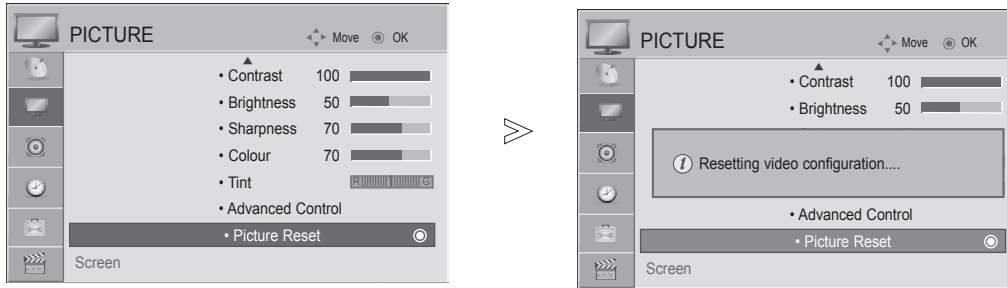

# PICTURE CONTROL

Colour Gamut (Wide/Standard)	<ul style="list-style-type: none"> <li>• <b>Standard</b> : Mode to reproduce original colour according to the standard of input signal independent of the display characteristics.</li> <li>• <b>Wide</b>: Mode to use and set the rich colour area of the display.</li> </ul>
Edge Enhancer (Off/Low/High)	<ul style="list-style-type: none"> <li>■ Shows clearer and distinctive yet natural corners of the video.</li> </ul>
OPC (On/Off)	<p>* This feature is not available for all models.</p> <ul style="list-style-type: none"> <li>■ As the technology to reduce the power consumption while keeping the same brightness, this has the effect of reducing power consumption, improvement in contrast.</li> </ul>
Colour Standard (SD/HD)	<ul style="list-style-type: none"> <li>■ Converts the colour of a different video to HD colour. This function is set for SD video (BT-601) and HD video (BT-709) colour format.</li> <li>■ This feature is enabled in "Picture Mode - Expert1/2".</li> </ul>
Colour Filter (Off/Red/Green/Blue)	<ul style="list-style-type: none"> <li>■ This is the function to filter the specific colours of the video. You can use the RGB filter to set colour saturation and hue accurately.</li> <li>■ This feature is enabled in "Picture Mode - Expert1/2".</li> </ul>
White Balance (Medium/Warm/Cool)	<ul style="list-style-type: none"> <li>■ This is the function to adjust the overall colour of the screen to the feeling you want.</li> <li>• Red/Green/Blue Contrast, Red/Green/Blue Brightness: The adjustment range is -50 to +50.</li> <li>■ This feature is enabled in "Picture Mode - Expert1/2"..</li> </ul>
Colour Management System	<ul style="list-style-type: none"> <li>■ As the tool used by the experts to make adjustments by using the test patterns, this does not affect other colours but can be used to selectively adjust the 6 colour areas (Red/Green/Blue/Cyan/Magenta/Yellow). Colour difference may not be distinctive even when you make the adjustments for the general video.</li> <li>■ Adjusts Red/Green/Blue/Yellow/Cyan/Magenta.               <ul style="list-style-type: none"> <li>• Red/Green/Blue/Yellow/Cyan, Magenta Colour : The adjustment range is -30 to +30.</li> <li>• Red/Green/Blue/Yellow/Cyan/Magenta Tint : The adjustment range is -30 to +30.</li> </ul> </li> <li>■ This feature is disable in RGB-PC mode.</li> <li>■ This feature is enabled in "Picture Mode - Expert1/2".</li> </ul>

# PICTURE RESET

Settings of the selected picture modes return to the default factory settings.



- 1   Select **PICTURE**.
- 2   Select **Picture Reset**.
- 3   Select **Yes**.
- 4  Initialize the adjusted value.

- Press the **Home/EXIT** button to return to normal TV viewing.
- Press the **BACK** button to move to the previous menu screen.

# PICTURE CONTROL

## POWER INDICATOR

Adjust the power/standby indicator light on the front of the TV.





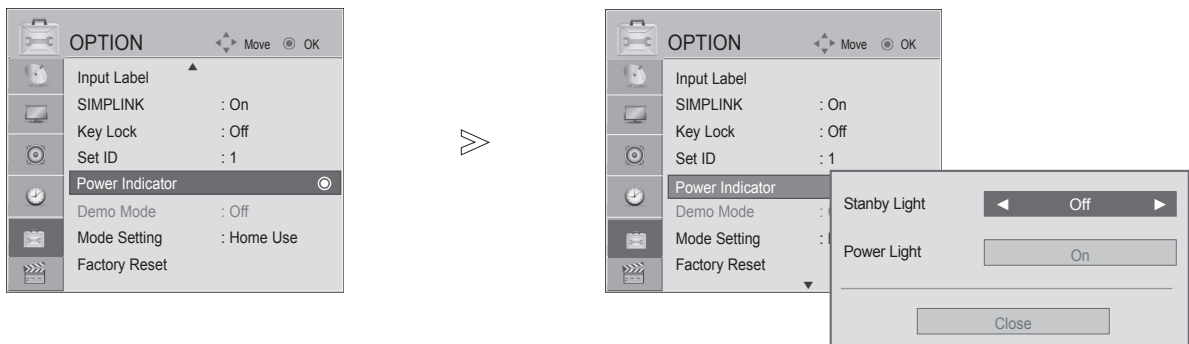

### Standby Light

Determines whether to set the indicator light on the front of the TV to On or Off in standby mode.

### Power Light

Determines whether to set the indicator light on the front of the TV to On or Off when the power turns on.



- 1   Select **OPTION**.
- 2   Select **Power Indicator**.
- 3   Select **Standby Light** or **Power Light**.
- 4  Select your desired Source.

- Press the **Home/EXIT** button to return to normal TV viewing.
- Press the **BACK** button to move to the previous menu screen.



# DEMO MODE







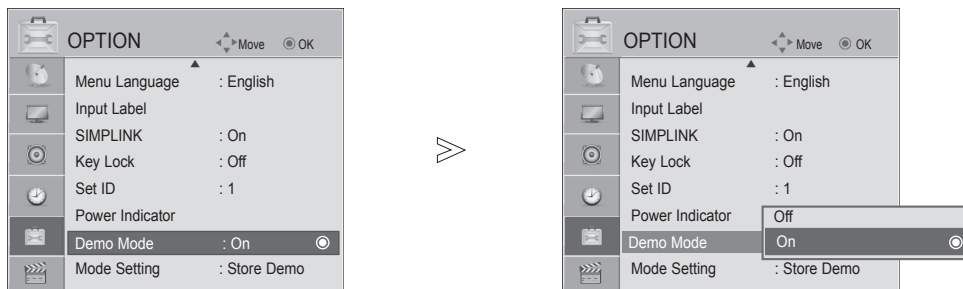

It is not possible to use **Demo Mode** in **Home Use** mode.

In **Store Demo**, **Demo Mode** is automatically set to On.

Once **Demo Mode** is set to Off in **Store Demo**, **Demo Mode** does not run and only the screen is reset.

The screen is reset automatically after 5 minutes in Demo Mode.



-   Select **OPTION**.
-   Select **Demo Mode**.
-   Select **On** or **Off**  
To stop the Demo Mode, press any button.
-  Return to TV viewing.  
If you want to stop the demo, press any button.  
(except **MUTE**,  + , - button)





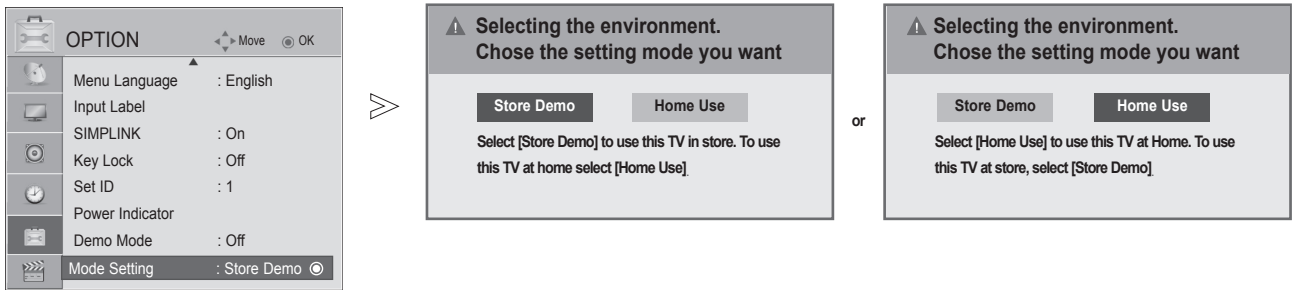

- Press the **Home/EXIT** button to return to normal TV viewing.
- Press the **BACK** button to move to the previous menu screen.

# PICTURE CONTROL

## MODE SETTING

We recommend setting the TV to “**Home Use**” mode for the best picture in your home environment. “**Store Demo**” mode is an optimal setting for displaying at stores.



- 1   Select **OPTION**.
- 2   Select **Mode Setting**.
- 3   Select **Store Demo** or **Home Use**.
- 4  Save.

- Press the **Home/EXIT** button to return to normal TV viewing.
- Press the **BACK** button to move to the previous menu screen.





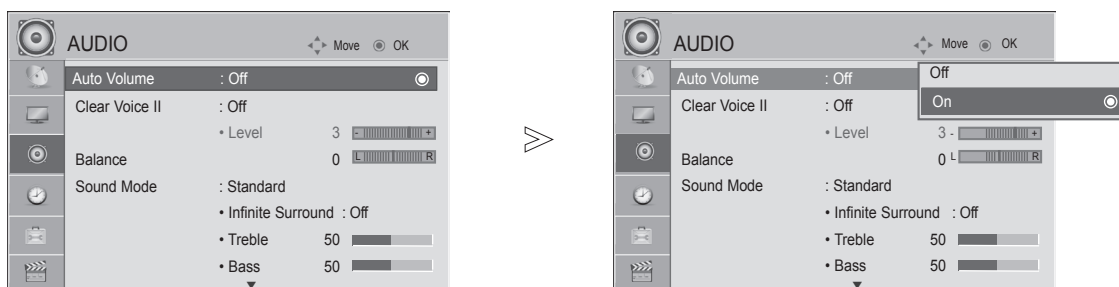

# SOUND & LANGUAGE CONTROL

## AUTO VOLUME LEVELER

Auto Volume automatically remains on the same level of volume if you change programmes.

Because each broadcasting station has its own signal conditions, volume adjustment may be needed every time the channel is changed. This feature allows users to enjoy stable volume levels by making automatic adjustments for each programme.



- 1   Select **AUDIO**.
- 2   Select **Auto Volume**.
- 3   Select **On** or **Off**.
- 4 

- Press the **Home/EXIT** button to return to normal TV viewing.
- Press the **BACK** button to move to the previous menu screen.

# SOUND & LANGUAGE CONTROL

## CLEAR VOICE II

By differentiating the human sound range from others, it helps users listen to human voices better.

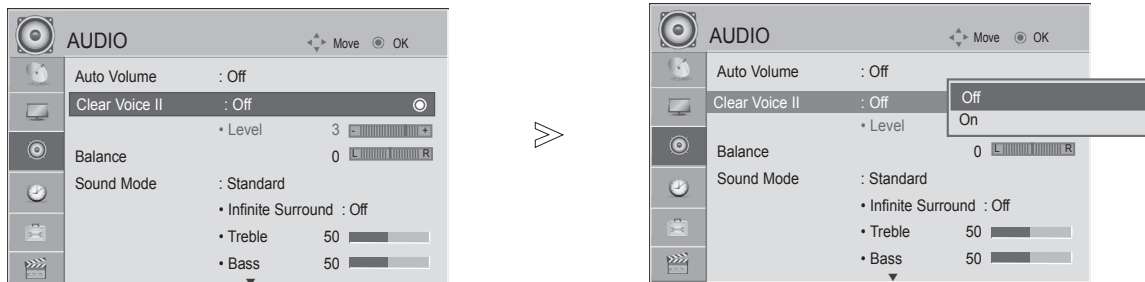

1   Select **AUDIO**.

2   Select **Clear Voice II**.



3   Select **On** or **Off**.

• If you select “**On**” for **Clear Voice II**, **Infinite Surround** feature will not work.

## ADJUSTMENT FOR CLEAR VOICE LEVEL WITH SELECTING ON

4   Select **Level**.

• Select levels from ‘-6’ to ‘+6’.

5   Make desired adjustment.

- Press the **Home/EXIT** button to return to normal TV viewing.
- Press the **BACK** button to move to the previous menu screen.

# PRESET SOUND SETTINGS-SOUND MODE

You can select your preferred sound setting; Standard, Music, Cinema, Sport or Game and you can also adjust the Treble, Bass.

Sound Mode lets you enjoy the best sound without any Special adjustment as the TV sets the appropriate sound options based on the programme content.

**Standard, Music, Cinema, Sport** and **Game** are preset for optimum sound quality at the factory.

- Standard** Offers standard-quality sound.
- Music** Optimizes sound for listening to music.
- Cinema** Optimizes sound for watching movies.
- Sport** Optimizes sound for watching sports events.
- Game** Optimizes sound for playing games.

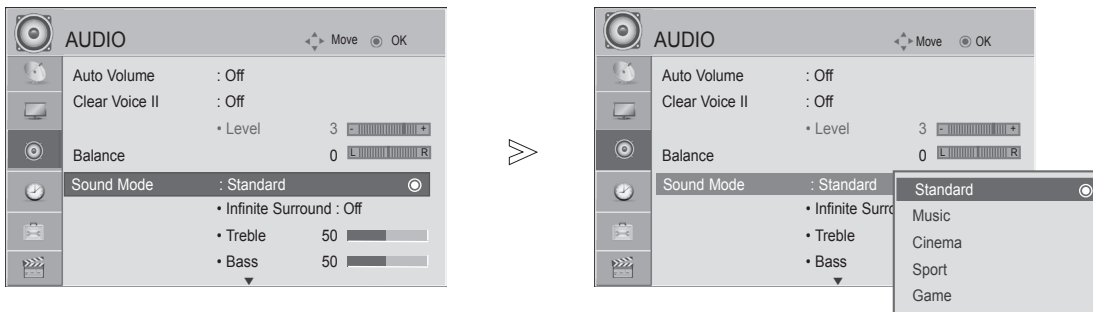

1   Select **AUDIO**.

2   Select **Sound Mode**.

3   Select **Standard, Music, Cinema, Sport** or **Game**.

4 

• You can also adjust **Sound Mode** in the **Q. Menu**.









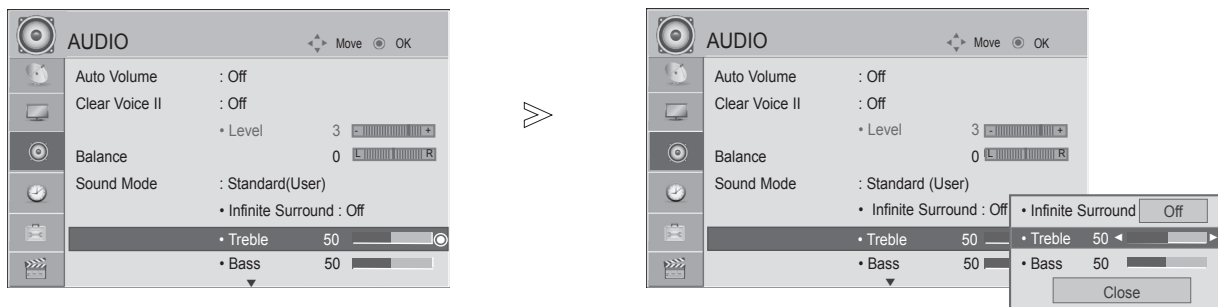

- Press the **Home/EXIT** button to return to normal TV viewing.
- Press the **BACK** button to move to the previous menu screen.

# SOUND & LANGUAGE CONTROL

## SOUND SETTING ADJUSTMENT -USER MODE

Adjusting the audio equalizer









- 1   Select **AUDIO**.
- 2   Select **Sound Mode**.
- 3   Select **Standard, Music, Cinema, Sport** or **Game**.
- 4   Select **Treble** or **Bass**.
- 5   Set the desired sound level.
- 6 

- Press the **Home/EXIT** button to return to normal TV viewing.
- Press the **BACK** button to move to the previous menu screen.

# INFINITE SURROUND

Select this option to sound realistic.



- 1   Select **AUDIO**.
- 2   Select **Infinite Surround**.
- 3   Select **On** or **Off**.
- 4 

• **Infinite Surround** : Infinite Surround is a patented LG proprietary sound processing technology that strives immersive 5.1 surround sound impression with front two loudspeakers.





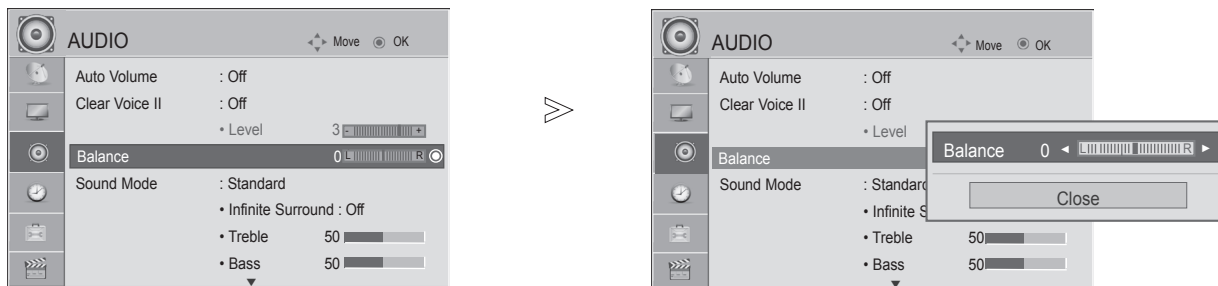

- Press the **Home/EXIT** button to return to normal TV viewing.
- Press the **BACK** button to move to the previous menu screen.

# SOUND & LANGUAGE CONTROL

## BALANCE

You can adjust the sound balance of the speakers to preferred levels.



- 1   Select **AUDIO**.
- 2   Select **Balance**.
- 3   Make desired adjustment.

- Press the **Home/EXIT** button to return to normal TV viewing.
- Press the **BACK** button to move to the previous menu screen.







# TV SPEAKERS ON/ OFF SETUP

You can adjust the TV internal speaker status.

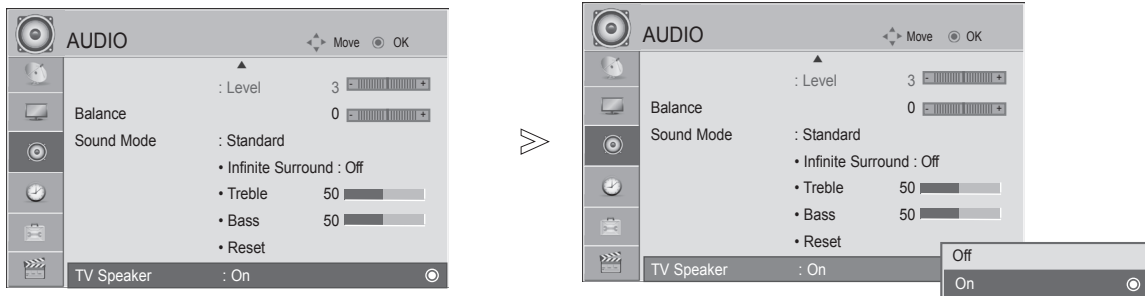
In **AV**, **COMPONENT**, **RGB** and **HDMI** with HDMI to DVI cable, the TV speaker can be operational even when there is no video signal.

If you wish to use an external Hi-Fi system, turn off the TV's internal speakers.



- 1   Select **AUDIO**.
- 2   Select **TV Speaker**.
- 3   Select **On** or **Off**.
- 4 

- Press the **Home/EXIT** button to return to normal TV viewing.
- Press the **BACK** button to move to the previous menu screen.

## NOTE





- ▶ When the TV speaker is turned off while the Simplink home theater is operating, the sound output automatically switches to the Home theater speaker, but when the TV speaker is turned on, the sound output the TV speaker.

# SOUND & LANGUAGE CONTROL

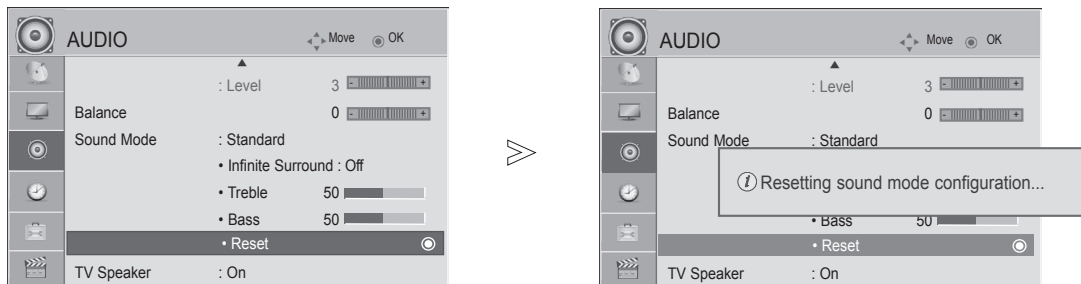
## AUDIO RESET

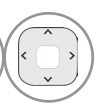
Settings of the selected Sound Mode return to the default factory settings.



- 1   Select **AUDIO**.
- 2   Select **Reset**.
- 3  Initialize the adjusted value.

- Press the **Home/EXIT** button to return to normal TV viewing.
- Press the **BACK** button to move to the previous menu screen.

# I/II

## STEREO/DUAL RECEPTION

When a programme is selected, the sound information for the station appears with the programme number and station name.

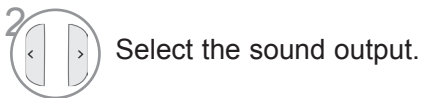

---

Broadcast	On Screen Display
Mono	MONO
Stereo	STEREO
Dual	DUAL I, DUAL II, DUAL I+II

### ■ Mono sound selection

If the stereo signal is weak in stereo reception, you can switch to mono. In mono reception, the clarity of sound is improved.

### ■ Language selection for dual language broadcast

If a programme can be received in two languages (dual language), you can switch to DUAL I, DUAL II or DUAL I+II.

- DUAL I** Sends the primary broadcast language to the loudspeakers.
- DUAL II** Sends the secondary broadcast language to the loudspeakers.
- DUAL I+II** Sends a separate language to each loudspeaker.

# SOUND & LANGUAGE CONTROL

## NICAM RECEPTION

If the TV is equipped with a receiver for NICAM reception, high quality NICAM (Near Instantaneous Companding Audio Multiplex) digital sound can be received.

Sound output can be selected according to the type of broadcast received.

- 
- ① When **NICAM mono** is received, you can select **NICAM MONO** or **FM MONO**.

---

  - ② When **NICAM stereo** is received, you can select **NICAM STEREO** or **FM MONO**.  
If the stereo signal is weak, switch to **FM MONO**.

---

  - ③ When **NICAM dual** is received, you can select **NICAM DUAL I**, **NICAM DUAL II** or **NICAM DUAL I+II** or **FM MONO**.
- 

## SPEAKER SOUND OUTPUT SELECTION

In AV, Component, RGB and HDMI mode, you can select output sound for the left and right loudspeakers.

Select the sound output.

**L+R:** Audio signal from audio L input is sent to the left loudspeaker and audio signal from audio R input is sent to the right loudspeaker.

**L+L:** Audio signal from audio L input is sent to left and right loudspeakers.

**R+R:** Audio signal from audio R input is sent to left and right loudspeakers.

# ON-SCREEN MENU LANGUAGE SELECTION

The installation guide menu appears on the TV screen when it is switched on for the first time.

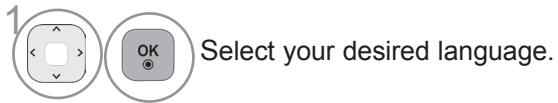

\* If you want to change Language/ Country selection

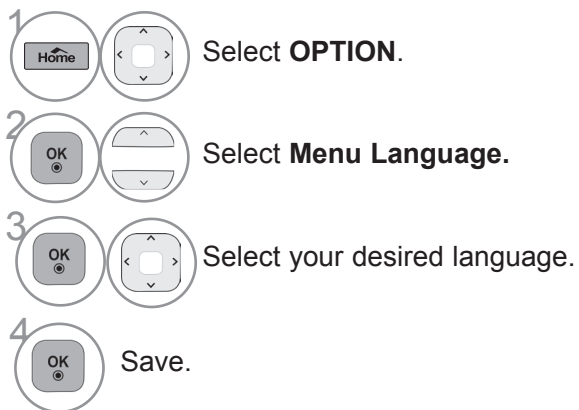

- Press the **Home/EXIT** button to return to normal TV viewing.
- Press the **BACK** button to move to the previous menu screen.

## ! NOTE

- ▶ If you do not finish the set-up **Installation Setup** by pressing **BACK** or if you time out on the OSD (On Screen Display) the installation menu will continuously appear until the set up is completed whenever the TV is switched on.



# TIME SETTING

## CLOCK SETUP

You must set the time correctly before using on/off timer function.

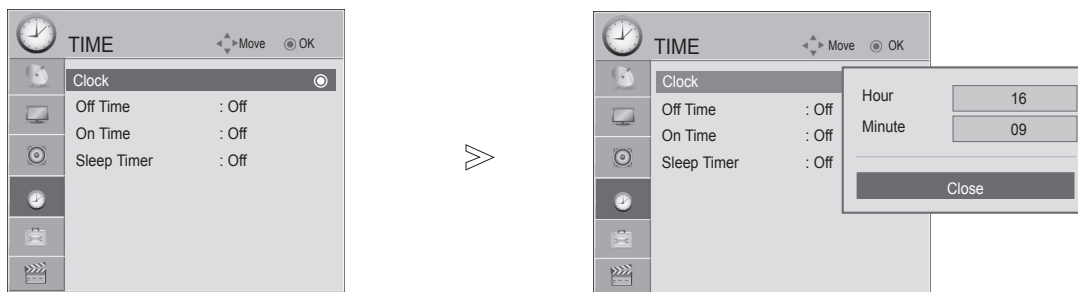
If current time setting is erased by a power failure or the TV is unplugged, reset the clock.

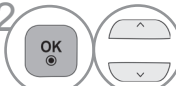

-  Select **TIME**.
-  Select **Clock**.
-  Select **Hour** or **Minute**.
-  Set the **Hour** or **Minute**.

- Press the **Home/EXIT** button to return to normal TV viewing.
- Press the **BACK** button to move to the previous menu screen.

## AUTO ON/OFF TIME SETTING

The Off time function automatically switches the TV to standby at a preset time.

Two hours after the TV is switched on by the on time function it will automatically switch back to standby mode unless a button has been pressed.

The Off time function overrides the On timer function if both are set to the same time.

The TV must be in standby mode for the On timer to work.

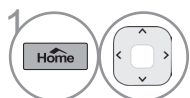
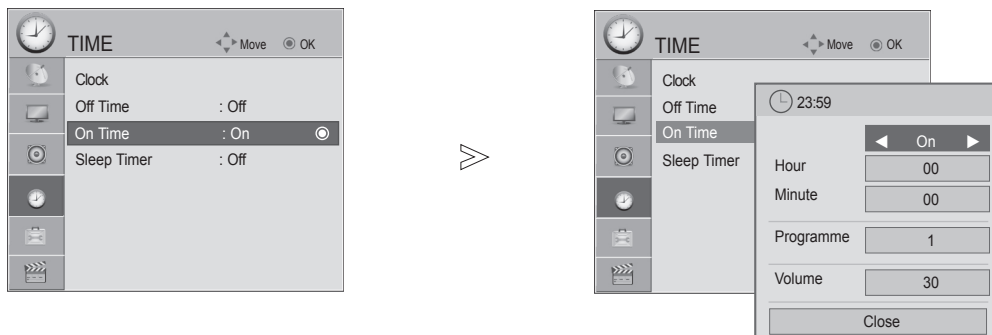

Select **TIME**.

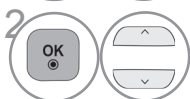

Select **Off Time** or **On Time**.

When the **On Time** is selected



Select **Hour, Minute, Programme or Volume**.



Set the hour, Minute, Programme, Volume.

- Press the **Home/EXIT** button to return to normal TV viewing.
- Press the **BACK** button to move to the previous menu screen.

## SLEEP TIMER SETTING

You do not have to remember to switch the TV off before you go to sleep.

The sleep timer automatically switches the TV to standby after the preset time has elapsed.

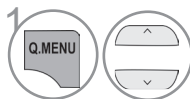

Select **Sleep Timer**.



Select **Off, 10, 20, 30, 60, 90, 120, 180 or 240 min.**

- When you switch the TV off, the preset sleep timer is cancelled.
- You can also adjust **Sleep Timer** in the **TIME** menu.

# TELETEXT

## This feature is not available in all countries.

Teletext is a free service broadcast by most TV stations which gives up-to-the-minute information on news, weather, television programmes, share prices and many other topics.

The teletext decoder of this TV can support the SIMPLE, TOP and FASTEXT systems. SIMPLE (standard teletext) consists of a number of pages which are selected by directly entering the corresponding page number. TOP and FASTEXT are more modern methods allowing quick and easy selection of teletext information.

## SWITCH ON/OFF

Press the **TEXT** button to switch to teletext. The initial page or last page viewed appears on the screen.

Two page numbers, TV station name, date and time are displayed on the screen headline. The first page number indicates your selection, while the second shows the current page displayed.

Press the **TEXT** button to switch off teletext. The previous mode reappears.

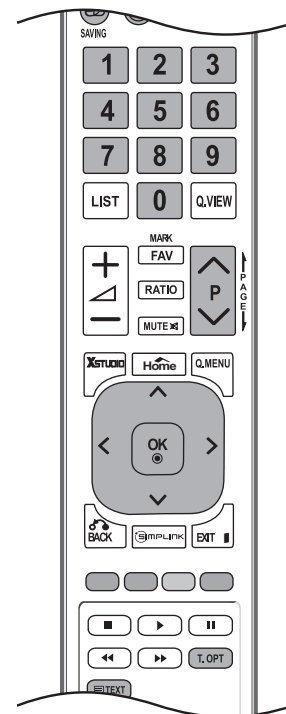

## SIMPLE TEXT

### ■ Page selection

- 1 Enter the desired page number as a three digit number with the NUMBER buttons. If during selection you press a wrong number, you must complete the three digit number and then re-enter the correct page number.
- 2 The **P**  $\wedge$  **v** button can be used to select the preceding or following page.

## TOP TEXT

The user guide displays four fields-red, green, yellow and blue at the bottom of the screen. The yellow field denotes the next group and the blue field indicates the next block.

### ■ Block / group / page selection

- 1 With the blue button you can progress from block to block.
- 2 Use the yellow button to proceed to the next group with automatic overflow to the next block.
- 3 With the green button you can proceed to the next existing page with automatic overflow to the next group.
- 4 Alternatively the **P**  $\wedge$  button can be used.  
The red button returns to the previous selection. Alternatively the **P** **v** button can be used.

### ■ Direct page selection

As with SIMPLE teletext mode, you can select a page by entering it as a three digit number using the NUMBER buttons in TOP mode.



# FASTTEXT

The teletext pages are colour coded along the bottom of the screen and are selected by pressing the corresponding coloured button.

## ■ Page selection

- 1 Press the **T.OPT** button and then use  $\wedge \vee$  button to select  menu. Display the index page.
- 2 You can select the pages which are colour coded along the bottom line with corresponding coloured buttons.
- 3 AS with SIMPLE teletext mode, you can select a page by entering its three digit page number with the NUMBER buttons in FASTTEXT mode.
- 4 The **P** $\wedge \vee$  button can be used to select the preceding or following page.

# SPECIAL TELETEXT FUNCTIONS

- Press the **T. OPT** button and then use  $\wedge \vee$  button to select the **Text Option** menu.



## ■ Index

Select the each index page.



## ■ Time

When viewing a TV programme, select this menu to display the time at the top right hand corner of the screen.

In the teletext mode, press this button to select a sub page number. The sub page number is displayed at the bottom of the screen. To hold or change the sub page, press the RED/GREEN, < > or NUMBER buttons.



## ■ Hold

Stops the automatic page change which will occur if a teletext page consists of 2 or more sub pages. The number of sub pages and the sub page displayed is, usually, shown on the screen below the time. When this menu is selected the stop symbol is displayed at the top left-hand corner of the screen and the automatic page change is inactive.



## ■ Reveal

Select this menu to display concealed information, such as solutions to riddles or puzzles.



## ■ Update

Displays the TV picture on the screen while waiting for a new teletext page. The display will appear at the top left hand corner of the screen. When the updated page is available then display will change to the page number. Select this menu again to view the updated teletext page.

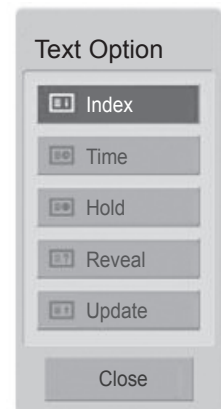

# APPENDIX

## TROUBLESHOOTING

The TV does not operate properly.	
The remote control does not work	<ul style="list-style-type: none"> <li>■ Check to see if there is any object between the TV and the remote control causing an obstruction. Ensure you are pointing the remote control directly at the TV.</li> <li>■ Ensure that the batteries are installed with correct polarity (+ to +, - to -).</li> <li>■ Install new batteries.</li> </ul>
Power is suddenly turned off	<ul style="list-style-type: none"> <li>■ Is the sleep timer set?</li> <li>■ Check the power control settings. Has the Power supply been interrupted.</li> <li>■ If the TV is switched on and there is no input signal, it will switch off automatically after 15 minutes.</li> </ul>

The video function does not work.	
No picture & No sound	<ul style="list-style-type: none"> <li>■ Try another channel. The problem may be with the broadcast.</li> <li>■ Is the power cord inserted correctly into the mains?</li> <li>■ Check your antenna direction and/or location.</li> <li>■ Test the mains outlet by plugging another TV into the same outlet.</li> </ul>
Picture appears slowly after switching on	<ul style="list-style-type: none"> <li>■ This is normal, the image is muted during the TV startup process. Please contact your service centre, if the picture has not appeared after five minutes.</li> </ul>
No or poor colour or poor picture	<ul style="list-style-type: none"> <li>■ Adjust Colour in menu option.</li> <li>■ Allow a sufficient distance between the TV and the VCR.</li> <li>■ Try another channel. The problem may be with the broadcast.</li> <li>■ Are the video cables installed properly?</li> <li>■ Activate any function to restore the brightness of the picture.</li> </ul>
Horizontal/vertical bars or picture shaking	<ul style="list-style-type: none"> <li>■ Check for local interference such as an electrical appliance or power tool.</li> </ul>
Poor reception on some channels	<ul style="list-style-type: none"> <li>■ Station or cable channel experiencing problems, tune to another station.</li> <li>■ Station signal is weak, reposition the antenna to receive weaker stations.</li> <li>■ Check for sources of possible interference.</li> </ul>
Lines or streaks in pictures	<ul style="list-style-type: none"> <li>■ Check antenna (Change the position of the antenna).</li> </ul>
No picture when connecting HDMI	<ul style="list-style-type: none"> <li>■ Check that your HDMI cable is High Speed HDMI Cable. If the HDMI cables are not High Speed HDMI Cable, flickering or no screen display can result. Please use the High Speed HDMI Cable.</li> </ul>

**The audio function does not work.**

Picture OK & No sound	<ul style="list-style-type: none"> <li>■ Check whether the TV is switched on.</li> <li>■ Press the <math>\triangleleft</math> + or - button.</li> <li>■ Sound muted? Press MUTE button.</li> <li>■ Try another channel. The problem may be with the broadcast.</li> <li>■ Are the audio cables installed properly?</li> </ul>
No output from one of the speakers	<ul style="list-style-type: none"> <li>■ Adjust <b>Balance</b> in menu option.</li> </ul>
Unusual sound from inside the TV	<ul style="list-style-type: none"> <li>■ A change in ambient humidity or temperature may result in an unusual noise when the TV is switched on or off and does not indicate a fault with the TV.</li> </ul>
No sound when connecting HDMI or USB	<ul style="list-style-type: none"> <li>■ Check HDMI cable is High Speed HDMI Cable.</li> <li>■ Check USB cable over version 2.0.</li> </ul>

**There is a problem in PC mode. (Only PC mode applied)**

The signal is out of range (Invalid format)	<ul style="list-style-type: none"> <li>■ Adjust resolution, horizontal frequency, or vertical frequency.</li> <li>■ Check the input source.</li> </ul>
Vertical bar or stripe on background & Horizontal Noise & Incorrect position	<ul style="list-style-type: none"> <li>■ Use Auto configure or adjust size, phase, or H/V position. (Option)</li> </ul>
Screen colour is unstable or single colour	<ul style="list-style-type: none"> <li>■ Check the signal cable.</li> <li>■ Reinstall the PC video card.</li> </ul>

**There is a problem with PICTURE settings.**

When the user changes the picture settings, the TV automatically converts back to the initial settings after a certain period of time.	<ul style="list-style-type: none"> <li>■ It means that the TV is currently set to <b>Store Demo</b> mode. To switch to <b>Home use</b> mode you should do the followings: From the TV Menu, choose <b>OPTION</b> -&gt; Choose <b>Mode Setting</b> -&gt; Choose <b>Home use</b>. Now, you have completed switching to the <b>Home use</b> mode.</li> </ul>
--	---

# APPENDIX

## MAINTENANCE

Early malfunctions can be prevented. Careful and regular cleaning can prolong the life of your new TV.

Caution: Be sure to switch the power off and unplug the power cord before you begin any cleaning.

### CLEANING THE SCREEN

- 1 A good way to keep the dust off your screen for a while is to wet a soft cloth in a mixture of lukewarm water and a little fabric softener or dish washing detergent. Wring the cloth until it is almost dry, and then use it to wipe the screen.
- 2 Ensure there is no excess water on the screen. Allow any water or dampness to evaporate before switching on.

### CLEANING THE CABINET

- To remove dirt or dust, wipe the cabinet with a soft, dry, lint-free cloth.
- Do not to use a wet cloth.

### EXTENDED ABSENCE

#### **⚠ CAUTION**

- ▶ If you expect to leave your TV dormant for prolonged periods (such as a holiday), unplug the power cord to protect against possible damage from lightning or power surges.

# PRODUCT SPECIFICATIONS

MODELS		22LK3**	26LK3**
		22LK310-TA 22LK311-TB	26LK310-TA 26LK311-TB
Dimensions (Width x Height x Depth)	with stand	526.0 mm x 377.0 mm x 165.0 mm	663.0 mm x 484.0 mm x 207.0 mm
	without stand	526.0 mm x 331.0 mm x 65.0 mm	663.0 mm x 423.0 mm x 79.9 mm
Weight	with stand	4.3 kg	7.6 kg
	without stand	4.0 kg	6.5 kg
Power requirement		AC 100-240 V~ 50 / 60 Hz	AC 100-240 V~ 50 / 60 Hz
MODELS		32LK3**	
		32LK310-TA 32LK311-TB	
Dimensions (Width x Height x Depth)	with stand	800.0 mm x 565.0 mm x 207.0 mm	
	without stand	800.0 mm x 509.0 mm x 73.8 mm	
Weight	with stand	9.6 kg	
	without stand	8.6 kg	
Power requirement		AC 100-240 V~ 50 / 60 Hz	
MODELS		32LK4**	42LK4**
		32LK410-TB	42LK410-TB
Dimensions (Width x Height x Depth)	with stand	799.0 mm x 555.0 mm x 207.0 mm	1023.0 mm x 685.0 mm x 261.0 mm
	without stand	799.0 mm x 516.0 mm x 73.5 mm	1023.0 mm x 644.0 mm x 76.6 mm
Weight	with stand	9.6 kg	15.4 kg
	without stand	8.6 kg	13.7 kg
Power requirement		AC 100-240 V~ 50 / 60 Hz	AC 100-240 V~ 50 / 60 Hz
Television System		PAL/SECAM B/G/D/K, PAL I/II, NTSC-M	
Programme Coverage		VHF: NZ1 to E21, UHF: E21 to E69, CATV: S1 to S20, HYPER: S21 to S47	
External Antenna Impedance		75 Ω	
Environment condition	Operating Temperature	0 °C to 40 °	
	Operating Humidity	Less than 80 %	
	Storage Temperature	-20 °C to 60 °C	
	Storage Humidity	Less than 85 %	
Supported movie files		Refer to p. 40	

■ The specifications shown above may be changed without prior notice for quality improvement.

# APPENDIX

MODELS		19LV2***	22LV2***
		19LV2130-TD	22LV2130-TD
Dimensions (Width x Height x Depth)	with stand	455.0 mm x 355.0 mm x 144.9 mm	471.0 mm x 366.0 mm x 144.9 mm
	without stand	455.0 mm x 313.0 mm x 40.9mm	471.0 mm x 316.0 mm x 40.9 mm
Weight	with stand	2.7 kg	3.4 kg
	without stand	2.5 kg	3.2 kg
Power requirement		AC 100-240V~50/60Hz	AC 100-240V~50/60Hz
MODELS		26LV2***	32LV2***
		26LV2130-TD	32LV2130-TD
Dimensions (Width x Height x Depth)	with stand	636.0 mm x 475.0 mm x 169.0 mm	777.0 mm x 552.0 mm x 216.0 mm
	without stand	636.0 mm x 414.0 mm x 40.9 mm	777.0 mm x 501.0 mm x 35.4 mm
Weight	with stand	5.4 kg	11.5 kg
	without stand	5.0 kg	10.7 kg
Power requirement		AC 100-240V~50/60Hz	AC 100-240V~50/60Hz
Television System		PAL/SECAM B/G/D/K, PAL I/II, NTSC-M	
Programme Coverage		VHF: NZ1 to E21, UHF: E21 to E69, CATV: S1 to S20, HYPER: S21 to S47	
External Antenna Impedance		75 Ω	
Environment condition	Operating Temperature	0 °C to 40 °C (32 °F to 104 °F)	
	Operating Humidity	Less than 80 %	
	Storage Temperature	-20 °C to 60 °C (-4 °F to 140 °F)	
	Storage Humidity	Less than 85 %	
Supported movie files		Refer to p. 40	

- The specifications shown above may be changed without prior notice for quality improvement.

# IR CODES

\*This feature is not available for all models.

Code (Hexa)	Function	Note
08	⏻ POWER	R/C BUTTON
95	Energy Saving	R/C BUTTON
0B	INPUT	R/C BUTTON
0F	TV	R/C BUTTON
45	Q.MENU	R/C BUTTON
43	Home	R/C BUTTON
7C	<b>XSTUDIO</b>	R/C BUTTON
40	Up (▲)	R/C BUTTON
41	Down (▼)	R/C BUTTON
07	Left (◀)	R/C BUTTON
06	Right (▶)	R/C BUTTON
44	OK (⊙)	R/C BUTTON
28	BACK (↶)	R/C BUTTON
30	AV MODE	R/C BUTTON
02	△+	R/C BUTTON
03	△-	R/C BUTTON
1E	FAV ( MARK )	R/C BUTTON
79	RATIO	R/C BUTTON
09	MUTE	R/C BUTTON
00	P ▲	R/C BUTTON
01	P ▼	R/C BUTTON
10 to 19	Number Key 0 to 9	R/C BUTTON
53	LIST	R/C BUTTON
1A	Q.VIEW	R/C BUTTON
72	RED Key	R/C BUTTON
71	GREEN Key	R/C BUTTON
63	YELLOW Key	R/C BUTTON
61	BLUE Key	R/C BUTTON
20	TEXT	R/C BUTTON
21	T.OPT(T.Option)	R/C BUTTON
7E	 SIMPLINK	R/C BUTTON
5B	EXIT	R/C BUTTON
B1	■	R/C BUTTON
B0	▶	R/C BUTTON
BA	⏸ Pause	R/C BUTTON
8F	◀◀ Rew	R/C BUTTON
8E	▶▶ FF	R/C BUTTON

# APPENDIX

## EXTERNAL CONTROL DEVICE SETUP

### RS-232C SETUP

Connect the RS-232C (serial port) input jack to an external control device (such as a computer or an A/V control system) to control the product's functions externally.

Connect the serial port of the control device to the RS-232C jack on the product back panel.

**Note:**

RS-232C connection cables are not supplied with the product.

In USB, it doesn't support RS-232C function.

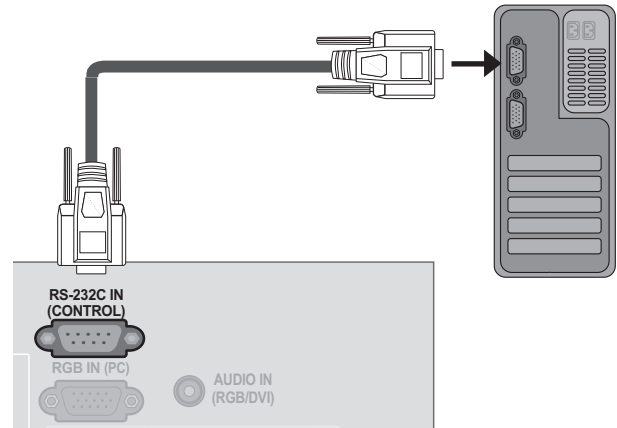

### TYPE OF CONNECTOR; D-SUB 9-PIN MALE

No.	Pin Name
1	No connection
2	RXD (Receive data)
3	TXD (Transmit data)
4	DTR (DTE side ready)
5	GND
6	DSR (DCE side ready)
7	RTS (Ready to send)
8	CTS (Clear to send)
9	No Connection

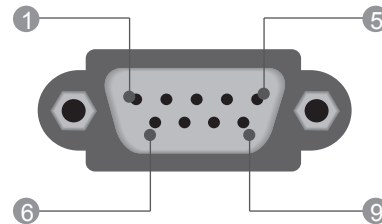

### RS-232C CONFIGURATIONS

7-Wire Configurations (Standard RS-232C cable)			
	PC	TV	
RXD	2 ● ——— ●	3	TXD
TXD	3 ● ——— ●	2	RXD
GND	5 ● ——— ●	5	GND
DTR	4 ● ——— ●	6	DSR
DSR	6 ● ——— ●	4	DTR
RTS	7 ● ——— ●	8	CTS
CTS	8 ● ——— ●	7	RTS
	D-Sub 9	D-Sub 9	

3-Wire Configurations (Not standard)			
	PC	TV	
RXD	2 ● ——— ●	3	TXD
TXD	3 ● ——— ●	2	RXD
GND	5 ● ——— ●	5	GND
DTR	4	6	DTR
DSR	6	4	DSR
RTS	7	7	RTS
CTS	8	8	CTS
	D-Sub 9	D-Sub 9	



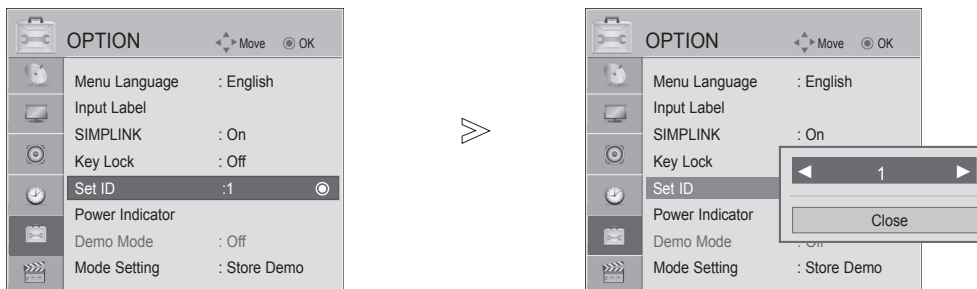

## SET ID

Use this function to specify a set ID number.  
Refer to 'Real Data Mapping'. ► p.85



1   Select **OPTION**.

2   Select **Set ID**.

3   Adjust **Set ID** to choose the desired TV ID number.  
The adjustment range of SET ID is 1 to 99.

• Press **BACK** to move to the previous menu screen.

# APPENDIX

## COMMUNICATION PARAMETERS

- Baud rate : 9600 bps (UART)
- Data length : 8 bits
- Parity : None
- Stop bit : 1 bit
- Communication code : ASCII code
- Use a crossed (reverse) cable.

### Command Reference List

	COMMAND 1	COMMAND 2	DATA (Hexadecimal)		COMMAND 1	COMMAND 2	DATA (Hexadecimal)
01. Power	k	a	00 to 01	14. Colour Temperature	k	u	00 to 64
02. Aspect Ratio	k	c	Refer to p. 83	15. Treble	k	r	00 to 64
03. Screen Mute	k	d	Refer to p. 83	16. Bass	k	s	00 to 64
04. Volume Mute	k	e	00 to 01	17. Abnormal Status	k	z	FF
05. Volume Control	k	f	00 to 64	18. Control Back Light	m	g	Refer to p. 85
06. Contrast	k	g	00 to 64	19. Auto Configure	j	u	01
07. Brightness	k	h	00 to 64	20. Eneregy Saving	j	q	Refer to p. 85
08. Colour	k	i	00 to 64	21. Tune Command	m	a	Refer to p. 85
09. Tint	k	j	00 to 64	22. Channel Skip	m	b	00 to 01
10. Sharpness	k	k	00 to 64	23. Key	m	c	Refer to p. 85
11. OSD Select	k	l	00 to 01	24. Input select (Main)	x	b	Refer to p. 85
12. Remote Control Lock / Key Lock Mode	k	m	00 to 01				
13. Balance	k	t	00 to 64				

### Transmission / Receiving Protocol

#### Transmission

[Command1][Command2][ ][Set ID][ ][Data][Cr]

- \* [Command 1] : First command to control the set.  
(j, k, m or x)
- \* [Command 2] : Second command to control the set.
- \* [Set ID] : You can adjust the set ID to choose desired TV ID number in Setup menu. Adjustment range is 1 to 99. When selecting Set ID '0', every connected TV is controlled. Set ID is indicated as decimal (1 to 99) on menu and as Hexa decimal (0x0 to 0x63) on transmission/receiving protocol.
- \* [DATA] : To transmit command data. Transmit 'FF' data to read status of command.
- \* [Cr] : Carriage Return  
ASCII code '0x0D'
- \* [ ] : ASCII code 'space (0x20)'

#### OK Acknowledgement

[Command2][ ][Set ID][ ][OK][Data][x]

- \* The TV transmits ACK (acknowledgement) based on this format when receiving normal data. At this time, if the data is data read mode, it indicates present status data. If the data is data write mode, it returns the data of the PC computer.

#### Error Acknowledgement

[Command2][ ][Set ID][ ][NG][Data][x]

- TV transmits ACK(acknowledgement) based on this format when receiving abnormal data form non-viable functions or communication errors.
- [Command 2] : use as command.
- [Set ID]: use the small character, if set ID is 10, TV will send the '0', 'a'
- [Data]: use the small character, if data is 0xab, TV will send the 'a', 'b'.
- [NG]: use the large character.

### 01. Power (Command: k a)

- ▶ To control Power On/Off of the TV.

#### Transmission

[k][a][ ][Set ID][ ][Data][Cr]

Data 00 : Power Off      01 : Power On

#### Acknowledgement

[a][ ][Set ID][ ][OK/NG][Data][x]

- ▶ To show Power On/Off.

#### Transmission

[k][a][ ][Set ID][ ][FF][Cr]

#### Acknowledgement

[a][ ][Set ID][ ][OK/NG][Data][x]

\* If there is the time delay between command and ack message during power on sequence, It should be described like "Note: In this model, TV will send the Acknowledge after power on processing completion. There might be a time delay between command and acknowledge."

### 02. Aspect Ratio (Command: k c) (Main Picture Size)

- ▶ To adjust the screen format. (Main picture format)  
You can also adjust the screen format using the **Aspect Ratio** in the PICTURE menu.

#### Transmission

[k][c][ ][Set ID][ ][Data][Cr]

Data 01 : Normal screen (4:3)      Data 06 : Original  
02 : Wide screen (16:9)      07 : 14 : 9  
04 : Zoom      09 : Just Scan  
10 to 1F : Cinema Zoom 1 to 16

#### Acknowledgement

[c][ ][Set ID][ ][OK/NG][Data][x]

- \* Using the RGB-PC, Component or HDMI input, you select either 16:9 or 4:3 screen aspect ratio.
- \* In HDMI/Component (over 720p) mode, Just Scan is available.

### 03. Screen Mute (Command: k d)

- ▶ To select screen mute on/off.

#### Transmission

[k][d][ ][Set ID][ ][Data][Cr]

Data 00 : Screen mute off (Picture on)  
Video Mute off

Data 01 : Screen mute on (Picture off)

Data 10 : Video Mute on

#### Acknowledgement

[d][ ][Set ID][ ][OK/NG][Data][x]

### 04. Volume Mute (Command: k e)

- ▶ To control volume mute on/off.  
You can also adjust mute using the MUTE button on remote control.

#### Transmission

[k][e][ ][Set ID][ ][Data][Cr]

Data 00 : Volume mute on (Volume off)

01 : Volume mute off (Volume on)

#### Acknowledgement

[e][ ][Set ID][ ][OK/NG][Data][x]

### 05. Volume Control (Command: k f)

- ▶ To adjust volume.  
You can also adjust volume with the VOLUME buttons on remote control.

#### Transmission

[k][f][ ][Set ID][ ][Data][Cr]

Data Min : 00 to Max : 64

\* Refer to 'Real data mapping 1'. See page 85.

#### Acknowledgement

[f][ ][Set ID][ ][OK/NG][Data][x]

### 06. Contrast (Command: k g)

- ▶ To adjust screen contrast.  
You can also adjust contrast in the PICTURE menu.

#### Transmission

[k][g][ ][Set ID][ ][Data][Cr]

Data Min : 00 to Max : 64

\* Refer to 'Real data mapping 1'. See page 85.

#### Acknowledgement

[g][ ][Set ID][ ][OK/NG][Data][x]

### 07. Brightness (Command: k h)

- ▶ To adjust screen brightness.  
You can also adjust brightness in the PICTURE menu.

#### Transmission

[k][h][ ][Set ID][ ][Data][Cr]

Data Min : 00 to Max : 64

\* Refer to 'Real data mapping 1'. See page 85.

#### Acknowledgement

[h][ ][Set ID][ ][OK/NG][Data][x]

### 08. Colour (Command: k i)

- ▶ To adjust the screen colour.  
You can also adjust colour in the PICTURE menu.

#### Transmission

[k][i][ ][Set ID][ ][Data][Cr]

Data Min : 00 to Max : 64

\* Refer to 'Real data mapping 1'. See page 85

#### Acknowledgement

[i][ ][Set ID][ ][OK/NG][Data][x]

# APPENDIX

## 09. Tint (Command: k j)

- ▶ To adjust the screen tint.  
You can also adjust tint in the PICTURE menu.

### Transmission

[k][j][ ][Set ID][ ][Data][Cr]

Data Red : 00 to Green : 64

\* Refer to 'Real data mapping 1'. See page 85.

### Acknowledgement

[j][ ][Set ID][ ][OK/NG][Data][x]

## 10. Sharpness (Command: k k)

- ▶ To adjust the screen sharpness.  
You can also adjust sharpness in the PICTURE menu.

### Transmission

[k][k][ ][Set ID][ ][Data][Cr]

Data Min : 00 to Max : 64

\* Refer to 'Real data mapping 1'. See page 85.

### Acknowledgement

[k][ ][Set ID][ ][OK/NG][Data][x]

## 11. OSD Select (Command: k l)

- ▶ To select OSD (On Screen Display) on/off when  
controlling remotely.

### Transmission

[k][l][ ][Set ID][ ][Data][Cr]

Data 00 : OSD off 01 : OSD on

### Acknowledgement

[l][ ][Set ID][ ][OK/NG][Data][x]

## 12. Remote control lock / Key Lock Mode (Command: k m)

- ▶ To lock the remote control and the front panel controls  
on the set.

### Transmission

[k][m][ ][Set ID][ ][Data][Cr]

Data 00 : Lock off 01 : Lock on

### Acknowledgement

[m][ ][Set ID][ ][OK/NG][Data][x]

\* When main power is on/off, remote control lock is released.

\* In the standby mode, if key lock is on, TV will not turn on by power on key of IR & Local Key.

## 13. Balance (Command: k t)

- ▶ To adjust balance.  
You can also adjust balance. in the AUDIO menu.

### Transmission

[k][t][ ][Set ID][ ][Data][Cr]

Data Min : 00 to Max : 64

\* Refer to 'Real data mapping 1'. See page 85.

### Acknowledgement

[t][ ][Set ID][ ][OK/NG][Data][x]

## 14. Colour Temperature (Command: k u)

- ▶ To adjust colour temperature.  
You can also adjust Colour Temperature in the  
PICTURE menu.

### Transmission

[k][u][ ][Set ID][ ][Data][Cr]

Data 00: Medium 01: Cool 02: Warm

### Acknowledgement

[u][ ][Set ID][ ][OK/NG][Data][x]

## 15. Treble (Command: k r)

- ▶ To adjust Treble.

### Transmission

[k][r][ ][Set ID][ ][Data][Cr]

Data Min : 00 to Max : 64

\* Refer to 'Real data mapping 1'. See page 85

### Acknowledgement

[r][ ][Set ID][ ][OK/NG][Data][x]

## 16. Bass (Command: k s)

- ▶ To adjust bass

### Transmission

[k][s][ ][Set ID][ ][Data][Cr]

Data Min: 00 to Max: 64

\* Refer to 'Real data mapping 1'. See page 85.

### Acknowledgement

[s][ ][Set ID][ ][OK/NG][Data][x]

## 17. Abnormal State (Command: k z)

- ▶ To recognize an abnormal state.

### Transmission

[k][z][ ][Set ID][ ][Data][Cr]

### Acknowledgement

[z][ ][Set ID][ ][OK/NG][Data][x]

Data FF: Read

Data 00: Normal (Power on and signal exist)

Data 01: No signal (Power on)

Data 02: Turn the TV off by remote control

Data 03: Turn the TV off by sleep time function

Data 04: Turn the TV off by RS-232C function

Data 05: 5V down

Data 06: AC down

Data 07: Turn the TV off by Fan Alarm function (option)

Data 08: Turn the TV off by Off time function

Data 09: Turn the TV off by Auto off function

Data a: Turn the TV off by AV board detection.

\* This function is "read only".

### 18. Control Back Light (Command: m g)

► To Control the back light.

#### Transmission

[m][g][ ][Set ID][ ][Data][Cr]

Data : data Min: 00 to Max: 64

(\* transmit by Hexadecimal code)

#### Acknowledgement

[q][ ][Set ID][ ][OK/NG][Data][x]

### 19 . Auto Configure (Command: j u)

► To adjust picture position and minimize image shaking automatically. It works only in RGB (PC) mode.

#### Transmission

[j][u][ ][Set ID][ ][Data][Cr]

Data 01: To set

#### Acknowledgement

[u][ ][Set ID][ ][OK/NG][Data][x]

### 20. Energy Saving (Command: j q)

► To reduce the power consumption of the TV.

#### Transmission

[j][q][ ][Set ID][ ][Data][Cr]

Data Min: 00H to Max: 05H

Data 00 : Off

01 : Minimum

02 : Medium

03 : Maximum

05 : Screen Off

#### Acknowledgement

[q][ ][Set ID][ ][OK/NG][Data][x]

### 21. Tune Command/ Channel Tuning (Command: m a)

► Tune Channel to following Physical number.

#### Transmission

[m][a][ ][Set ID][ ][Data0][ ][Data1][ ][Data2][Cr]

Data0: 00

Data1: Min: 00 to Max: C7

\* Refer to 'Real data mapping 1' See page 85.

Data2: 00

#### Acknowledgement

[a][ ][Set ID][OK][ ][Data0][Data1][x]

[a][ ][Set ID][NG][ ][Data0][x]

### 22. Channel Skip(Command: m b)

► To set skip status for the current Programme.

#### Transmission

[m][b][ ][Set ID][ ][Data][Cr]

Data 00 : Skip 01 : Add

#### Acknowledgement

[b][ ][Set ID][ ][OK/NG][Data][x]

### 23. Key (Command: m c)

► To send IR remote key code.

#### Transmission

[m][c][ ][Set ID][ ][Data][Cr]

Data: Key code - Refer to page 79.

#### Acknowledgement

[c][ ][Set ID][ ][OK/NG][Data][x]

### 24. Input select (Command: x b) (Main Picture Input)

► To select input source for TV.

#### Transmission

[x][b][ ][Set ID][ ][Data][Cr]

Data : Structure

MSB				LSB			
0	0	0	0	0	0	0	0
└ External Input ┘				└ Input Number ┘			

External Input				Data
0	0	0	1	Analogue
0	0	1	0	AV
0	1	0	0	Component
0	1	1	0	RGB-PC
1	0	0	1	HDMI

INPUT Number				Data
0	0	0	0	Input1
0	0	0	1	Input2
0	0	1	0	Input3
0	0	1	1	Input4

#### Acknowledgement

[b][ ][Set ID][ ][OK /NG][Data][x]

#### \* Real data mapping 1

00 : Step 0  
:  
A : Step 10  
:  
F : Step 15  
10 : Step 16  
:  
64 : Step 100  
:  
6E : Step 110  
:  
73 : Step 115  
74 : Step 116  
:  
C7 : Step 199  
:  
FE : Step 254  
FF : Step 255



Record the model number and serial number of the TV.  
Refer to the label on the back cover and quote this information to your dealer when requiring any service.

Model : \_\_\_\_\_

Serial No. : \_\_\_\_\_