



ENGLISH

OWNER'S MANUAL

DVD MINI Hi-Fi System

Please read this manual carefully before operating your set and retain it for future reference.

MODELS

MDT355 (MDT355, MDS355V/W)

MDD65 (MDD65, MDS65V)

MDD105 (MDD105, MDS105V)

MDD265 (MDD265, MDS265V)

P/NO : MFL63266281

1 Safety Information



CAUTION: TO REDUCE THE RISK OF ELECTRIC SHOCK DO NOT REMOVE COVER (OR BACK) NO USER-SERVICEABLE PARTS INSIDE REFER SERVICING TO QUALIFIED SERVICE PERSONNEL.



This lightning flash with arrowhead symbol within an equilateral triangle is intended to alert the user to the presence of uninsulated dangerous voltage within the product's enclosure that may be of sufficient magnitude to constitute a risk of electric shock to persons.



The exclamation point within an equilateral triangle is intended to alert the user to the presence of important operating and maintenance (servicing) instructions in the literature accompanying the product.

WARNING: TO PREVENT FIRE OR ELECTRIC SHOCK HAZARD, DO NOT EXPOSE THIS PRODUCT TO RAIN OR MOISTURE.

WARNING: Do not install this equipment in a confined space such as a book case or similar unit.

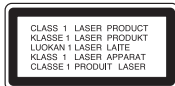

CAUTION: This product employs a Laser System. To ensure proper use of this product, please read this owner's manual carefully and retain it for future reference. Shall the unit require maintenance, contact an authorized service centre.

Use of controls, adjustments or the performance of procedures other than those specified herein may result in hazardous radiation exposure.

To prevent direct exposure to laser beam, do not try to open the enclosure. Visible laser radiation when open. DO NOT STARE INTO BEAM.

CAUTION: The apparatus shall not be exposed to water (dripping or splashing) and no objects filled with liquids, such as vases, shall be placed on the apparatus.

CAUTION concerning the Power Cord
Most appliances recommend they be placed upon a dedicated circuit;

That is, a single outlet circuit which powers only that appliance and has no additional outlets or branch circuits. Check the specification page of this owner's manual to be certain. Do not overload wall outlets. Overloaded wall outlets, loose or damaged wall outlets, extension cords, frayed power cords, or damaged or cracked wire insulation are dangerous. Any of these conditions could result in electric shock or fire. Periodically examine the cord of your appliance, and if its appearance indicates damage or deterioration, unplug it, discontinue use of the appliance, and have the cord replaced with an exact replacement part by an authorized service centre. Protect the power cord from physical or mechanical abuse, such as being twisted, kinked, pinched, closed in a door, or walked upon. Pay particular attention to plugs, wall outlets, and the point where the cord exits the appliance. To disconnect power from the mains, pull out the mains cord plug. When installing the product, ensure that the plug is easily accessible.

CAUTION: Do not block any ventilation openings. Install in accordance with the manufacturer's instructions.

Slots and openings in the cabinet are provided for ventilation and to ensure reliable operation of the product and to protect it from overheating. The openings should be never be blocked by placing the product on a bed, sofa, rug or other similar surface. This product should not be placed in a built-in installation such as a bookcase or rack unless proper ventilation is provided or the manufacturer's instruction have been adhered to.

This device is equipped with a portable battery or accumulator.

Safe way to remove the battery or the battery from the equipment:

Remove the old battery pack, follow the steps in reverse order than the assembly. To prevent contamination of the environment and bring on possible threat to human and animal health, the old battery or the battery put in the appropriate container at designated collection points. Do not dispose of batteries or battery together with other waste. It is recommended that you use local, free reimbursement system batteries and accumulators.

The battery shall not be exposed to excessive heat such as sunshine, fire or the like.

You have to set the disc format option to [Mastered] in order to make the discs compatible with the LG players when formatting rewritable discs. When setting the option to Live File System, you cannot use it on LG players.

(Mastered/ Live File System : Disc format system for Windows Vista)

Copyrights

It is forbidden by law to copy, broadcast, show, broadcast via cable, play in public, or rent copyrighted material without permission. This product features the copy protection function developed by Macrovision. Copy protection signals are recorded on some discs. When recording and playing the pictures of these discs picture noise will appear. This product incorporates copyright protection technology that is protected by U.S. patents and other intellectual property rights. Use of this copyright protection technology must be authorized by Macrovision, and is intended for home and other limited viewing uses only unless otherwise

authorized by Macrovision. Reverse engineering or disassembly is prohibited.

CONSUMERS SHOULD NOTE THAT NOT ALL HIGH DEFINITION TELEVISION SETS ARE FULLY COMPATIBLE WITH THIS PRODUCT AND MAY CAUSE ARTIFACTS TO BE DISPLAYED IN THE PICTURE. IN CASE OF 525 OR 625 PROGRESSIVE SCAN PICTURE PROBLEMS, IT IS RECOMMENDED THAT THE USER SWITCH THE CONNECTION TO THE 'STANDARD DEFINITION 'OUTPUT. IF THERE ARE QUESTIONS REGARDING OUR TV SET COMPATIBILITY WITH THIS MODEL 525p AND 625p UNIT, PLEASE CONTACT OUR CUSTOMER SERVICE CENTER.

Disposal of your old appliance



1. When this crossed-out wheeled bin symbol is attached to a product it means the product is covered by the European Directive 2002/96/EC.
2. All electrical and electronic products should be disposed of separately from the municipal waste stream via designated collection facilities appointed by the government or the local authorities.
3. The correct disposal of your old appliance will help prevent potential negative consequences for the environment and human health.
4. For more detailed information about disposal of your old appliance, please contact your city office, waste disposal service or the shop where you purchased the product.

Contents



1 Safety Information

2 CAUTION

2 Preparation

- 6 Unique Features
 - 6 AUTO DJ
 - 6 USB Direct Recording

6 Accessories

- 7 Introduction
 - 7 Playable Discs
 - 7 About the  Symbol Display
 - 7 Symbol Used in this Manual
 - 7 Regional Codes
 - 8 Playable file Requirement

9 Remote control

11 Rear panel

12 Front panel

3 Installation

- 14 Attaching the speakers to the unit
 - 14 MDT355 (2.1 channel)
 - 14 MDD65/ MDD105/MDD265 (2 channel)

15 Antenna Connection

- 16 Connections to Your TV
 - 16 Component Video Connection
 - 17 Video Connection
- 17 Optional Equipment Connection
 - 17 AUX In Connection
 - 18 USB Connection
- 19 Adjust the Setup settings
 - 19 OSD Initial language settings - Optional
 - 19 To display and exit the Setup Menu
 - 20 LANGUAGE
 - 20 DISPLAY
 - 21 AUDIO
 - 22 LOCK (Parental Control)
 - 23 OTHERS

4 Operation

- 24 Basic Operations
 - 24 Disc/ USB Operations
 - 25 TAPE Operation
- 26 Other Operations
 - 26 Displaying Disc Information on-screen
 - 26 To display the DVD Menu
 - 26 To display the DVD title
 - 26 Selecting a subtitle language
 - 26 1.5 times speed playback
 - 27 Starting play from selected time
 - 27 Last Scene Memory

27	Changing the character set to display DivX® subtitle correctly - optional	35	Synchronized Recording from CD to Tape
27	Creating your own program	36	Recording to USB
28	Viewing a PHOTO file	5	
28	Viewing a PHOTO file as a slide show	Maintenance	
29	Setting the Clock	<hr/>	
29	Using your player as an alarm clock	37	Notes on Discs
30	Sleep Timer Setting	37	Handling the Unit
30	Dimmer	6	
30	DEMO	Troubleshooting	
30	Turning off the sound temporarily	<hr/>	
30	Screen Saver	38	Troubleshooting
30	System Select - Optional	7	
30	Displaying file information (ID3 TAG)	Appendix	
31	AUTO DJ playback	<hr/>	
31	VOCAL FADER	39	Language Codes
32	Radio Operations	40	Area Codes
32	Listening to the radio	41	Trademarks and Licenses
32	Presetting the Radio Stations	41	Specifications
33	Improving poor FM reception	<hr/>	
33	Deleting all the saved station	6	
34	Sound adjustment	<hr/>	
34	Setting the surround mode	7	
34	Setting the USER EQ	<hr/>	
35	Advanced Operations	<hr/>	
35	Listening to music from your external device	<hr/>	
35	Recording to TAPE	<hr/>	
35	Pausing recording	<hr/>	

1

2

3

4

5

6

7

2 Preparation

2

Preparation

Unique Features

AUTO DJ

Auto DJ blends the end of one song into the beginning of another for seamless playback.

USB Direct Recording

Records music to your USB device.

Accessories

Please check and identify the supplied accessories.

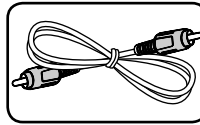

Video cable (1)

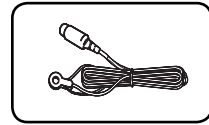

FM antenna (1)

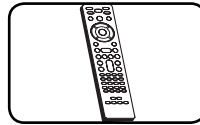

Remote control (1)

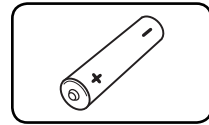

Battery (1)

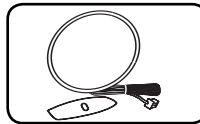

AM antenna (1)

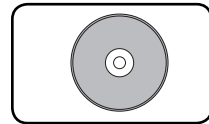

Karaoke Disc (1)/
(optional)

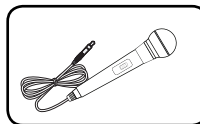

Microphone (1)/
(optional)

Introduction

Playable Discs

This unit plays DVD±R/RW and CD-R/RW that contains audio titles, DivX, MP3, WMA and/or JPEG files. Some DVD±RW/DVD±R or CD-RW/CD-R cannot be played on this unit due to the recording quality or physical condition of the disc, or the characteristics of the recording device and authoring software.



DVD-VIDEO (8 cm / 12 cm disc)
Discs such as movies that can be purchased or rented.



DVD±R (8 cm / 12 cm disc)
Video mode and finalized only



DVD-RW (8 cm / 12 cm disc)
Video mode and finalized only



DVD+R: Video mode only
Supports the double layer disc also



DVD+RW (8 cm / 12 cm disc)
Video mode and finalized only



Audio CD: Music CDs or CD-R/CD-RW in music CD format that can be purchased.

About the Symbol Display

" " may appear on your TV display during operation and indicates that the function explained in this owner's manual is not available on that disc.

Symbol Used in this Manual

All discs and file listed below	ALL
MP3 files	MP3
DVD and finalized DVD±R/RW	DVD
WMA files	WMA
DivX files	DivX
Audio CDs	ACD
JPG files	JPG

Regional Codes

This unit has a regional code printed on the rear of the unit. This unit can play only DVD discs labelled same as the rear of the unit or "ALL".

- Most DVD discs have a globe with one or more numbers in it clearly visible on the cover. This number must match your unit's regional code or the disc cannot play.
- If you try to play a DVD with a different regional code from your unit, the message "Check Regional Code" appears on the TV screen.



NOTE

Indicates special notes and operating features.



TIP

Indicates tip and hints for making the task easier.



CAUTION

Indicates cautions for preventing possible damages from abuse.

Playable file Requirement

MP3/ WMA music file requirement

MP3/ WMA file compatibility with this unit is limited as follows :

- Sampling frequency : between 32 to 48 kHz (MP3), between 32 to 48 kHz (WMA)
- Bit rate : between 32 to 320 kbps (MP3), 40 to 192 kbps (WMA)
- Maximum files : Under 999
- File extensions : ".mp3"/ ".wma"
- CD-ROM file format : ISO 9660/ JOLIET
- We recommend that you use Easy-CD Creator, which creates an ISO 9660 file system.
- **Customers should note that permission is required in order to download MP3 / WMA files and music from the Internet. Our company has no right to grant such permission. Permission should always be sought from the copyright owner.**

Photo file requirement

Photo file compatibility with this unit is limited as follows :

- Max pixel in width :
Normal : 5120 x 3840
Progressive JPEG : 2048 x 1536
- Maximum files : Under 999
- Some discs may not operate due to a different recording format or the condition of disc.
- File extensions: ".jpg"
- CD-ROM file format : ISO9660 LEVEL 1/ JOLIET

DivX file requirement

DivX file compatibility with this unit is limited as follows :

- Available resolution:
up to 800 x 600 (W x H) pixels.
- The file name of the DivX subtitle should be entered 45 characters or less.
- If there is a code impossible to express in the DivX file, it may be displayed as a " _ " mark on the display.
- Frame rate : less than 30 fps.
- If the video and audio structure of recorded files are not interleaved, either video or audio is output.
- Playable DivX file : ".avi", ".mpg", ".mpeg", ".divx"
- Playable Subtitle format : SubRip (*.srt/ *.txt), SAMI (*.smi), SubStation Alpha (*.ssa/ *.txt), MicroDVD (*.sub/ *.txt), SubViewer 2.0 (*.sub/ *.txt), Vobsub (*.sub)
- Playable Codec format : "DIVX3.xx", "DIVX4.xx", "DIVX5.xx", "MP4V3", "3IVX".
- Playable Audio format : "AC3", "PCM", "MP3", "WMA".
- Sampling frequency : between 32 to 48 kHz (MP3), between 32 to 48 kHz (WMA)
- Bit rate : between 32 to 320 kbps (MP3), 40 to 192 kbps (WMA)
- For Discs formatted in Live file system, you can not use it on this unit.
- If the name of movie file is different from that of the subtitle file, during playback of a DivX file, subtitle may not be display.
- If you play a DivX file differ from DivX spec, it may not operate normally.

Remote control

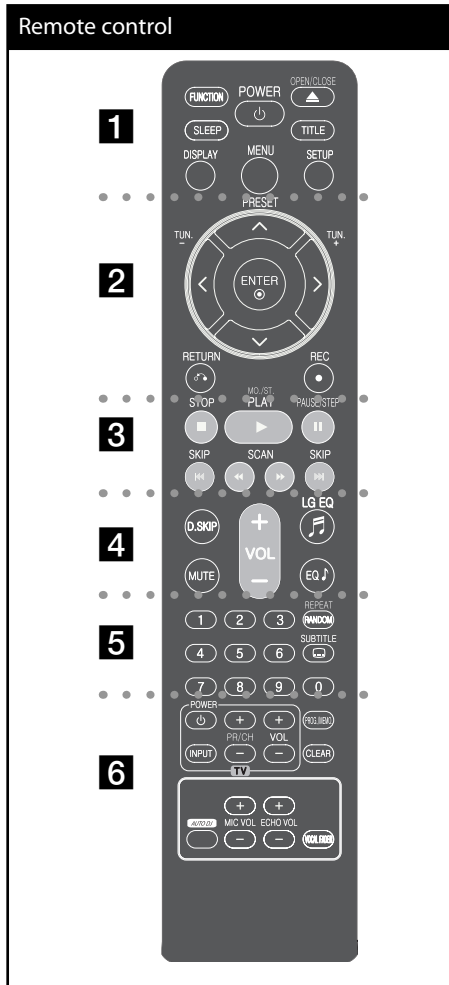

..... **1**

FUNCTION : Selects the function.

SLEEP : Sets the system to turn off automatically at a specified time.

(Dimmer : The display window will be darkened by half.)

POWER : Switches the unit ON or OFF.

OPEN/CLOSE : Opens and closes the disc tray.

TITLE : If the current DVD title has a menu, the title menu appears on the screen. Otherwise, the disc menu may appear.

DISPLAY : Accesses On-Screen Display.

MENU : Accesses the menu on a DVD disc.

SETUP : Accesses or removes setup menu.

..... **2**

PRESET (\wedge/\vee) : Selects programme of Radio.

TUN. $-/+(<>)$: Tunes in the desired radio station.

$\wedge/\vee/</>$ (up/ down/ left/ right): Used to navigate on-screen displays.

ENTER : Acknowledges menu selection.

RETURN (\curvearrowright) : Moving back wards in the menu.

REC (\bullet) : Recording.

..... **3**

STOP (\blacksquare) : Stops playback or recording.

PLAY (\blacktriangleright), **MO./ST.** : Starts playback. Selects Mono/ Stereo.

PAUSE/STEP (\parallel) : Pauses playback.

SKIP ($\blacktriangleleft\blacktriangleleft/\blacktriangleright\blacktriangleright$) : Goes to next or previous chapter/ track/ file.

SCAN ($\blacktriangleleft\blacktriangleright$) : Searches backward or forward.

2

Preparation

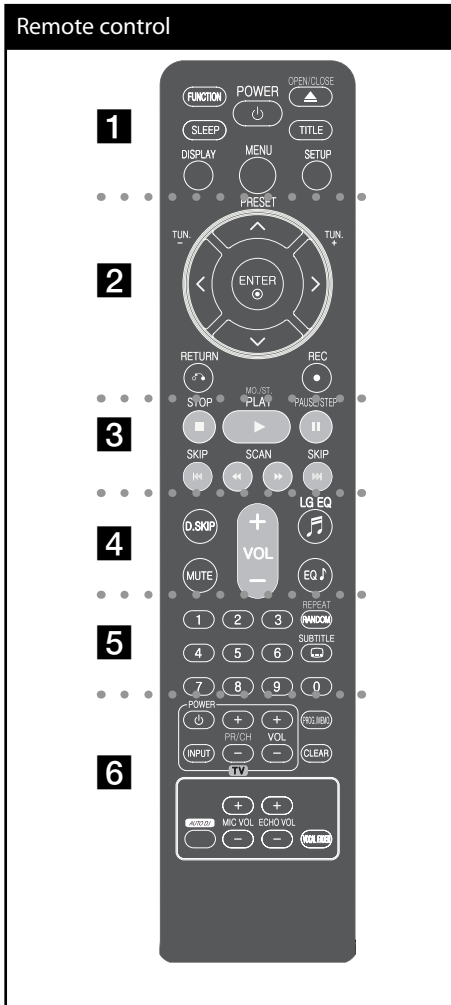

..... 4

- D.SKIP** : Chooses a desired disc.
- MUTE** : Mutes the sound.
- VOL (+/-)** (Volume) : Volume control.
- LG EQ/ EQ** (Equalizer effect) : You can choose sound impressions.

..... 5

0 to 9 numerical buttons : Selects numbered options in a menu.

REPEAT/ RANDOM : Selects a play mode. (Repeat/Random)

SUBTITLE : During playback, press **SUBTITLE** repeatedly to select a desired subtitle language .

..... 6

TV Control buttons : Controls the TV. (LG TV only)

Controlling the TV.

You can control the sound level, input source, and power switching of LG TVs as well. Hold **POWER** (TV) and press **PR/CH** (+/-) button repeatedly until the TV turns on or off.

PROG./MEMO. : Accesses Program menu.

CLEAR : Removes a track number on the Program List.

AUTO DJ : Selects the AUTO DJ mode.

MIC VOL(+/-) : Adjusts microphone volume.

ECHO VOL(+/-) : Adjusts echo volume.

VOCAL FADER: You can enjoy the function as karaoke, by reducing singer vocal of music in the various source.

! NOTE

- **Put the battery into the remote control.**
Make sure for the + (plus) and - (minus) on the battery to be matched on the remote control.
- This manual explains the operation based on remote control.

Rear panel

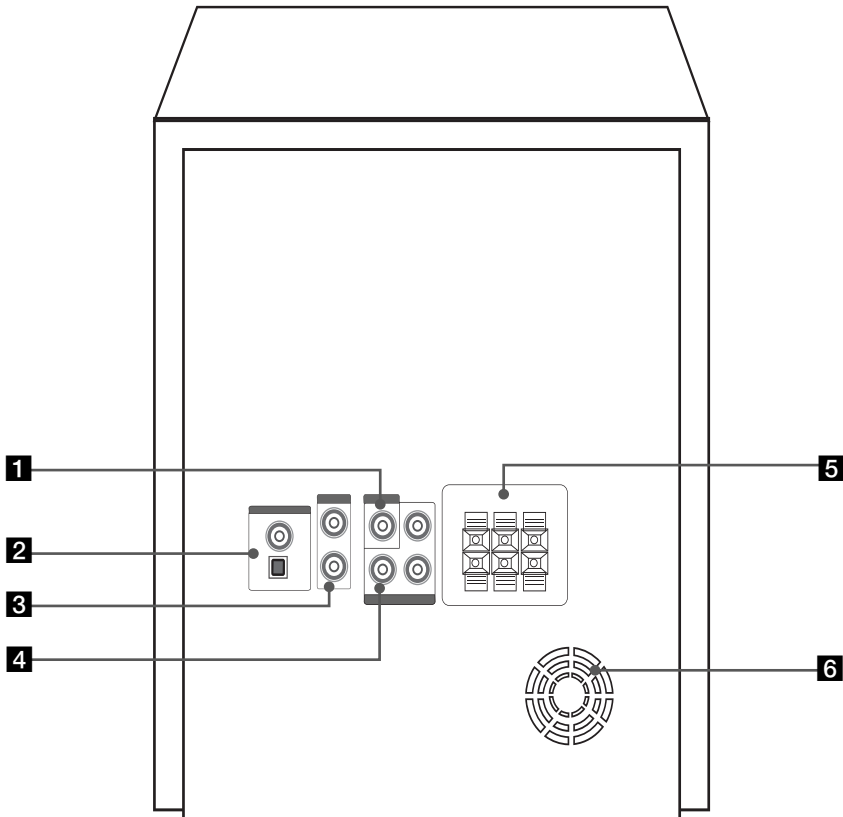

- 1** VIDEO OUT connector
- 2** ANTENNA (FM, AM (optional))
- 3** AUX IN connector
- 4** OUT PUT (COMPONENT VIDEO OUT (PROGRESSIVE SCAN)) connector
- 5** SPEAKERS terminal

MDT 355 Speaker terminal



MDD65/ MDD105/MDD265 Speaker terminal



- 6** Cooling fan

Front panel

2

Preparation

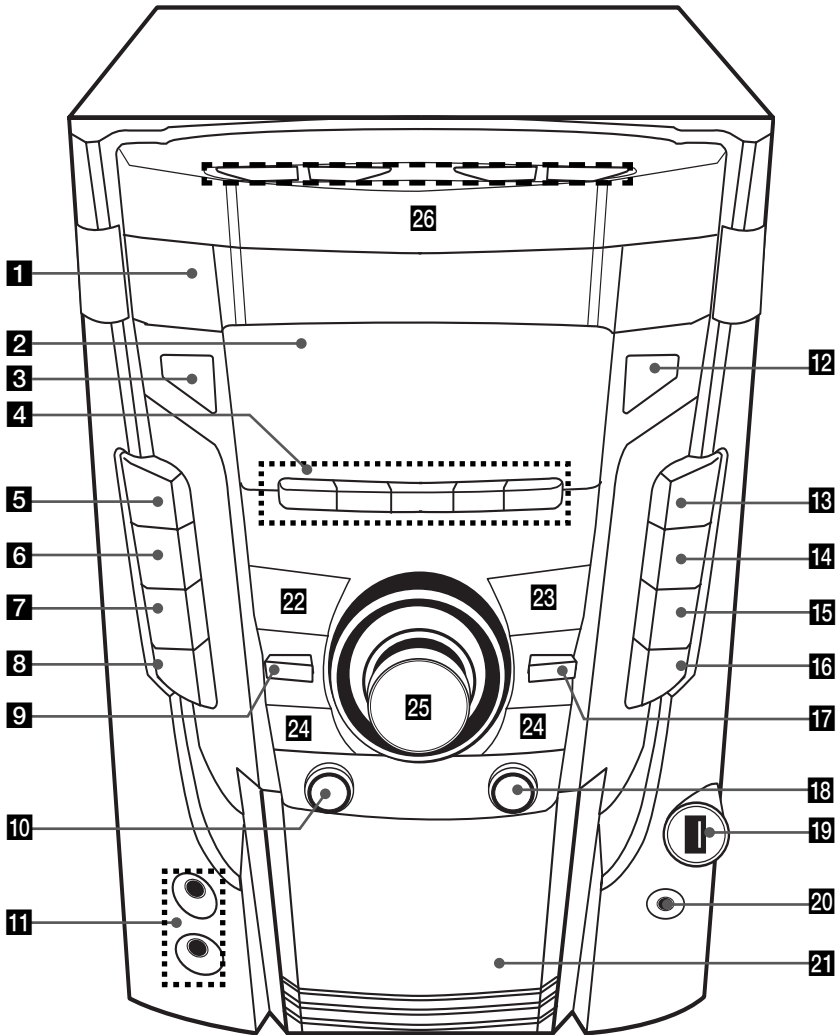

1 Disc tray**2 Display window****3**  (Power ON/ OFF)**4 USB/DEMO**

Selects the USB or DEMO function.

DVD/CD

Selects the DVD/CD function.

TUNER

Selects the TUNER function.

TAPE

Selects the TAPE function.

AUX

Selects the AUX function.

5 6 EQ/ LG EQ

You can choose sound impressions.

7 USER EQ

Controls sound register.

8 BASS BLAST/

Reinforces the treble, bass and surround effect.

MP3 OPT.

This function is optimized for compressible MP3 file. It improves the treble sound.

9 SET/ CD II

Pauses or confirms the setting.

10 AUTO DJ

Selects the AUTO DJ mode.

11 MIC 1,2**12 OPEN/CLOSE****13 CD SYNC./**

From CD to TAPE Synchronized Recording Starts playback.

REVERSE MODE (TAPE only)

Selects the REVERSE MODE function.

14 CLOCK

For setting the clock and checking the time.

15 TIMER

Uses your player as an alarm clock.

16 DISC SKIP

Chooses a desired CD.

17 STOP**18 R (Record)**

Recording.

19 USB port**20 Headphone jack**

A warning that excessive sound pressure from earphones and headphones can cause hearing loss.

21 Cassette door**22 PRESET -/ <**

- TAPE reverse play
- Selects preset numbers

23 PRESET + / >

- CD play, TAPE forward play
- Selects preset numbers

24 |<< (-)TUNING(+) >>|

- Searches backward or forward.
- Skips to the previous/ next track.
- Selects the radio station.

25 Volume knob

Volume control.

26 ECHO VOL. (Λ/V)

Adjusts microphone echo volume.

MIC VOL. (Λ/V)

Adjusts microphone volume.

3 Installation

Attaching the speakers to the unit

3
Installation

To connect the cable to the unit, press each plastic finger pad to open the connection terminals on the unit. Insert the wire and release the finger pad.

Connect the black end of each wire to the terminals marked - (minus) and the other end to the terminals marked + (plus).

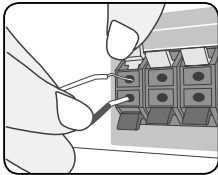

Connect the other end of each wire to the correct speaker according to the color coding

MDT355 (2.1 channel)

Color	Speaker	Position
Orange	Sub woofer	Any front position
Red	Front	Front right
White	Front	Front left

MDD65/ MDD105/MDD265 (2 channel)

Color	Speaker	Position
Red	Front	Front right
White	Front	Front left



CAUTION

- Be careful to make sure children do not put their hands or any objects into the *speaker duct.
*Speaker duct: A hall for plentiful bass sound on speaker cabinet (enclosure)
- The speakers contain magnet parts, so color irregularity may occur on the TV screen or PC monitor screen. Please use the speakers far away from either TV screen or PC monitor.

Antenna Connection

Connect the supplied FM (F) /AM (optional) (A) antenna for listening to the radio.

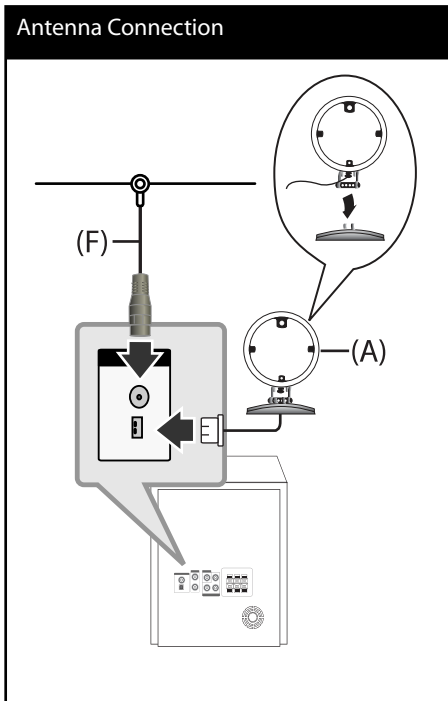

NOTE

- To prevent noise pickup, keep the AM (optional) Loop antenna away from the unit and other components.
- Be sure to fully extend the FM wire antenna. After connecting the FM wire antenna, keep it as horizontal as possible.

Connections to Your TV

Make one of the following connections, depending on the capabilities of your existing equipment.

NOTE

- Depending on your TV and other equipment you wish to connect, there are various ways you could connect the unit. Use only one of the connections described in this manual.
- Please refer to the manuals of your TV, Stereo System or other devices as necessary to make the best connections.
- Make sure the unit is connected directly to the TV. Tune the TV to the correct video input channel.
- Do not connect your unit via your VCR. The image could be distorted by the copy protection system.

Component Video Connection

Connect the COMPONENT VIDEO OUTPUT (PROGRESSIVE SCAN) jacks on the unit to the corresponding input jacks on the TV using component cables.

You can hear the sound through the system's speakers.

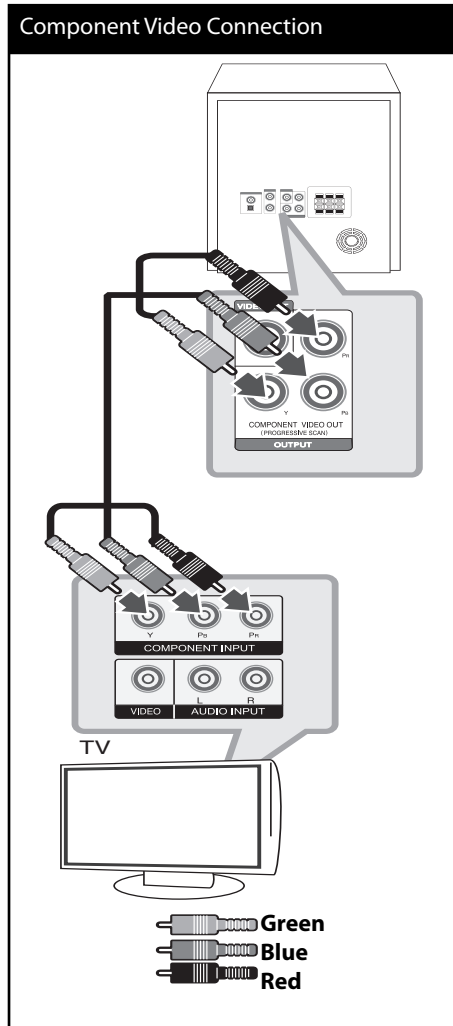

NOTE

If your TV accepts progressive format signals, you must use this connection and set [Progressive Scan] in [Display] setup to [On] (See page 20).

Video Connection

Connect the VIDEO OUT jack on the unit to the video in jack on the TV using a video cable.

You can hear the sound through the system's speakers.

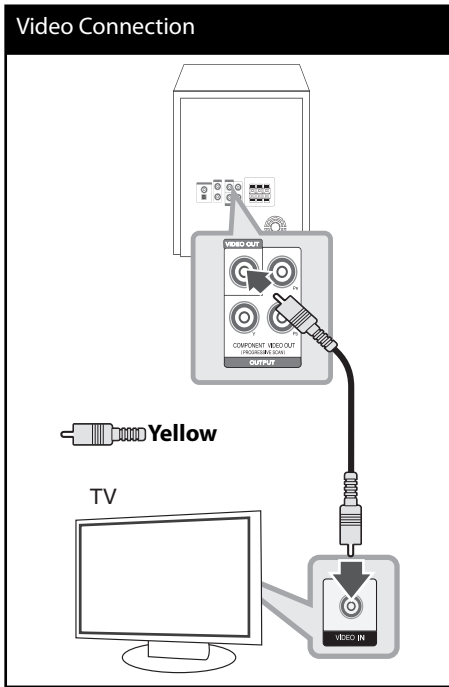

Optional Equipment Connection

AUX In Connection

Connect an Output of auxiliary device to the AUX (L/R) INPUT Connector.

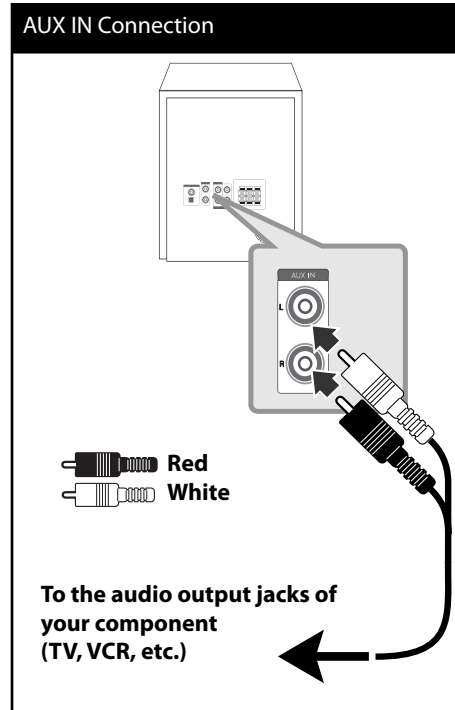

NOTE

If your TV has only one output for audio (mono), connect it to the left (white) audio jack on the unit.

USB Connection

Connect the USB port of USB Memory (or MP3 player, etc.) to the USB port on the front of the unit.

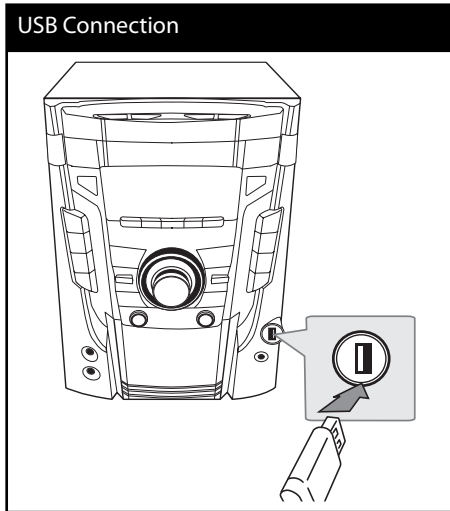

USB device requirement

- Devices which require additional program installation connected to a computer, are not supported.
- Do not extract the USB device while in operation.
- For a large capacity USB, it may take longer than a few minute to be searched.
- To prevent data loss, back up all data.
- If you use a USB extension cable or USB hub, the USB device is not recognized.
- Using NTFS file system is not supported. (Only FAT(16/ 32) file system is supported.)
- This unit is not supported when the total number of files is 1, 000 or more.
- External HDD, Card readers, Locked devices, or hard type usb devices are not supported.
- The USB port on this unit cannot be connected to a PC. The unit can not be used as a storage device.

Removing the USB Device from the unit

1. Choose a different function mode.
2. Remove the USB device from the unit.

Compatible USB Devices

- MP3 Player : Flash type MP3 player.
- USB Flash Drive : Devices that support USB 2.0 or USB 1.1.
- The USB function of this unit does not support some USB devices.

Adjust the Setup settings

By using the Setup menu, you can make various adjustments to items such as picture and sound.

You can also set a language for the subtitles and the Setup menu, among other things. For details on each Setup menu item.

OSD Initial language settings - Optional

When using this unit for the first time, the initial language setup menu appears on your TV screen. You must complete initial language selection before using the unit. English will be selected as the initial language.

1. Press **POWER** to turn the unit on.
The language setup menu will appear on the screen.
2. Use **^ V < >** to select a language then press **ENTER**.
The confirm menu will appear.
3. Use **< >** to select [Enter] then press **ENTER** to finish the language setup.

To display and exit the Setup Menu

1. Select the DVD/CD or USB function by pressing **FUNCTION**.
2. Press **SETUP**.
Displays the [SETUP] Menu.
3. Press **SETUP** or **RETURN** to exit in the [SETUP] Menu.

About help menu for Setup

Menu	Buttons	Operation
▲/▼ Move	^ V	Moving to another menu.
◀ Prev.	<	Moving to previous level.
▶ Select	>	Moving to next level or selecting menu.
↶ Close	RETURN	To exit the [Setup] menu.
⊙ ENTER	ENTER	To confirm menu.

LANGUAGE

Menu Language

Select a language for the Setup menu and then on screen display.

Disc Audio / Disc Subtitle / Disc Menu

Select the language you prefer for the audio track (disc audio), subtitles, and the disc menu.

[Original]

Refers to the original language in which the disc was recorded.

[Other]

To select another language, press numeric buttons and then **ENTER** to enter the corresponding 4-digit number according to the language code list on the page 39. If you enter the wrong language code, press **CLEAR**.

[Off (for Disc Subtitle)]

Turn off Subtitle.

DISPLAY

TV Aspect

Select which screen aspect to use based on the shape of your TV screen.

[4:3]

Select when a standard 4:3 TV is connected.

[16:9]

Select when a 16:9 wide TV is connected.

Display Mode

The Display Mode setting works only when the TV Aspect mode is set to 4:3.

[Letterbox]

This displays a wide screen picture with black bands at the top and bottom of the screen.

[Panscan]

This fills the entire 4:3 screen, cropping the picture as necessary.

Progressive Scan (For Component Video connections)

Selects whether the COMPONENT VIDEO(PROGRESSIVE SCAN) OUTPUT jacks output progressive signal. If your TV accepts progressive format signals, you will enjoy accurate color reproduction and high quality image by selecting [On]. If your TV does not accept progressive format signals, select [Off]. If you set Progressive Scan to [On] in error, you must reset the unit. First, remove the disc from the unit. Next, press and hold **STOP** for about five seconds. The video output will be restored to the standard setting, and a picture will be visible on your TV.

AUDIO

2.1 Speaker Setup (MDT355)

Make the following settings for the built-in 2.1 channel surrounds decoder.

1. Press **SETUP**.
2. Use \wedge \vee to select AUDIO menu and then press \triangleright .
3. Use \wedge \vee to select [2.1 Speaker setup] menu and then press **ENTER**.
4. Press **ENTER**
The [2.1 Speaker setup] appears.



5. Use \langle \triangleright to select the desired speaker.
6. Adjust options using \wedge \vee \langle \triangleright buttons.
7. Press **ENTER** to confirm your selection.
Return to the previous menu.

Speaker selection

Select a speaker that you want to adjust.



NOTE

Certain speaker settings are prohibited by the Dolby Digital licensing agreement.

Volume – Press \langle \triangleright to adjust the output level of the selected speaker.

Test – Press \langle \triangleright to test the signals of each speaker. Adjust the volume to match the volume of test signals memorized in the system.

DRC (Dynamic Range Control)

Make the sound clear when the volume is turned down (Dolby Digital only). Set to [On] for this effect.

Vocal

Select [On] to mix karaoke channels into normal stereo.

This function is effective for multi-channel karaoke DVDs only.

LOCK (Parental Control)

Initial Setting of the Area Code

When you use this unit for the first time, you have to set the Area Code as shown below.

1. Select the [Lock] menu and then press **>**.
2. Press **>**.
To access the [Lock] options, you must input the password you have created. Input a password and press **ENTER**. Enter it again and press **ENTER** to verify. If you make a mistake before pressing **ENTER**, press **CLEAR**.
3. Select the first character using **^** **v** buttons.
4. Press **>** and select the second character using **^** **v** buttons.
5. Press **ENTER** to confirm your Area code selection.

Rating

Blocks playback of rated DVDs based on their contents. Not all discs are rated.

1. Select [Rating] on the [Lock] menu then press **>**.
2. Input a password and press **ENTER**.
3. Select a rating from 1 to 8 using the **^** **v** buttons.

[Rating 1-8]

Rating one (1) has the most restrictions and rating eight (8) is the least restrictive.

[Unlock]

If you select unlock, parental control is not active and the disc plays in full.

4. Press **ENTER** to confirm your rating selection.

Password

You can enter or change password.

1. Select [Password] on the [Lock] menu and then press **>**.
2. Input a password and press **ENTER**.

To change the password, press **ENTER** when the [Change] option is highlighted. Input a password and press **ENTER**. Enter it again and press **ENTER** to verify.

3. Press **SETUP** to exit the menu.



NOTE

If you forget your password, you can clear it using the following steps:

1. Press **SETUP** to display the Setup menu.
2. Input the 6-digit number "210499" and press **ENTER**. The password is cleared.

Area Code

Enter the code of the area whose standards were used to rate the DVD video disc, based on the list on page 40.

1. Select [Area Code] on the [Lock] menu then press **>**.
2. Input a password and press **ENTER**.
3. Select the first character using **^** **v** buttons.
4. Press **>** and select the second character using **^** **v** buttons.
5. Press **ENTER** to confirm your Area code selection.

OTHERS

DivX(R) Registration

ABOUT DIVX VIDEO: DivX® is a digital video format created by DivX, Inc. This is an official DivX Certified device that plays DivX video. Visit www.divx.com for more information and software tools to convert your files into DivX video.

ABOUT DIVX VIDEO-ON-DEMAND: This DivX Certified® device must be registered in order to play DivX Video-on-Demand (VOD) content. To generate the registration code, locate the DivX VOD section in the device setup menu. Go to vod.divx.com with this code to complete the registration process and learn more about DivX VOD.

NOTE

All the downloaded videos from DivX® VOD can only be played back on this unit.

NOTE

- DVD, DVD Karaoke discs with more than 2 tracks are available discs for this function.
- When you watch movies, "off" the Semi Karaoke at the SETUP menu or enjoy it without connecting the MIC if the fanfare or score appears during changing a chapter.
- This function operate on the DVD/CD mode.
- The Semi Karaoke function is available only when a microphone is connected.

Semi Karaoke - optional

When a chapter/ title/ track is fully finished, this function shows the score in the screen with a fanfare sound.

[On]

When you finished singing a score will appear on the screen.

[Off]

Fanfare and score do not appear on the screen.

4 Operation

Basic Operations

Disc/ USB Operations

1. Insert the disc by using the **OPEN/CLOSE** or connect the USB device to the USB port.
2. Select the **DVD/CD** or **USB** function by pressing **FUNCTION**.
3. Select a file (or track/ title) you want to play by pressing **▲ ▼ < >**.

! **NOTE**

- When playing a disc or USB Flash Drive containing with DivX, MP3/WMA and JPEG files together, you can select menu of files which you would like to play by pressing **MENU**.
- For the most Audio CD and DVD-ROM discs, playback starts automatically.
- The unit plays only music file contained in the USB storage device or disc automatically. (except for folder)

To	Do this
Stop	Press ■ .
Playback	Press ▶ .
Pause	Press PAUSE .
Frame-by-Frame playback	Press PAUSE/STEP repeatedly to play title Frame-by-Frame. (DVD, DivX only)

Skipping to the next/ previous chapter/ track/ file	During playback, press ⏮ or ⏭ to go to the next chapter track/file or to return to the beginning of the current chapter track/file. Press ⏮ twice briefly to step back to the previous chapter track/ file.
Locating a point quickly by playing a file in fast forward or fast reverse	During playback, press ⏩ or ⏪ repeatedly to select the required scan speed. To return to normal speed, press PLAY .
Playing repeatedly or randomly	Press REPEAT/RANDOM repeatedly, and the current title, chapter or track will be played back repeatedly or randomly. - Random play mode : only music files.
Slowing down the playing speed	In the pause mode, press ⏩ or ⏪ to select the required speed. (DVD only)

4
Operation

TAPE Operation

Listening to cassette tapes

Cassette tapes can be played back in this unit.

1. Open the tape door by pressing **▲ PUSH EJECT**.
2. Insert the tape.
3. Close the tape door.
4. Select the TAPE function by pressing **TAPE** on the unit or **FUNCTION** on the remote control.

To	Do this
Stop	Press ■
Playback	Press ▶ on the remote control or < PRESET - / PRESET +> on the unit.
Change direction	Press ▶ repeatedly on the remote control or < PRESET - / PRESET +> on the unit.
Searching for a section within a track	After pressing ◀◀/▶▶ during playback, press ▶ at a point you want.
Reverse mode	You can set the tape to play one side ⇄ , both sides one time ⇆ , or both sides repeatedly ↔ , by pressing REVERSE MODE on the unit one or more times.

Other Operations

Displaying Disc Information on-screen

You can display various information about the disc loaded on-screen.

1. Press **DISPLAY** to show various playback information.
The displayed items differ depending on the disc type or playing status.
2. You can select an item by pressing \wedge \vee and change or select the setting by pressing $<$ $>$.

 1/11 Title – Current title number/ total number of titles.

 13/18 Chapter – Current chapter number/ total number of chapters.

 0:03:24 Time – Elapsed playing time.

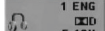
 1 ENG 5.1CH Audio – Selected audio language or channel.

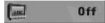
 Off Subtitle – Selected subtitle.

 1/1 Angle – Selected angle/total number of angles.

 BYPASS Sound – Selected sound mode



NOTE

If any button is not pressed for a few seconds, the onscreen display disappears.

To display the DVD Menu **DVD**

When you play a DVD which contains several menu, you can select the menu you want using the Menu.

1. Press **MENU**.
The disc's menu appears.
2. Select the menu by using \wedge \vee $<$ $>$.
3. Press **PLAY** to confirm.

To display the DVD title **DVD**

When you play a DVD which contains several title, you can select the title you want using the Menu.

1. Press **TITLE**.
The disc's title appears.
2. Select the menu by pressing \wedge \vee $<$ $>$.
3. Press **PLAY** to confirm.



Selecting a subtitle language

DVD **DivX**

During playback, press **SUBTITLE**() repeatedly to select a desired subtitle language.

1.5 times speed playback **DVD**

The 1.5 speed allows you to watch the pictures and listen to the sound quicker than playing at a normal speed.

1. During playback, press **PLAY**() to play at 1.5 times speed. "▶X1.5" appears on the screen.
2. Press **PLAY**() again to exit.

Starting play from selected time **DVD** **DivX**

To start playing at any chosen time on the file or title.

1. Press **DISPLAY** during playback.
2. Press **Λ V** to select the time clock icon and “--:--:--” appears.
3. Input the required start time in hours, minutes, and seconds from left to right. If you enter the wrong numbers, press **CLEAR** to remove the numbers you entered. Then input the correct numbers.
For example, to find a scene at 1 hour, 10 minutes, and 20 seconds, enter “11020” by using numerical buttons.
4. Press **ENTER** to confirm. Playback starts from the selected time.

Last Scene Memory **DVD**

This unit memorizes last scene from the last disc that is viewed. The last scene remains in memory even if you remove the disc from the unit or switch off the unit. If you load a disc that has the scene memorized, the scene is automatically recalled.

Changing the character set to display DivX® subtitle correctly **DivX** - optional

If the subtitle does not display properly during playback press and hold **SUBTITLE** for about 3 seconds then press **SUBTITLE** to select another language code until the subtitle is displayed properly and then press **ENTER**.

Creating your own program

MP3 **WMA** **ACD**

You can play the contents of a disc in the order you want by arranging the order of the songs on the disc. The program is cleared when the disc is removed.

1. Select a desired music file then press **PROG./MEMO.** or select “**↵→**” and then press **ENTER** to add the music file to the program list.
2. To add all music file on the disc, select “**↵→**” and then press **ENTER**.
3. Select a music file from the program list then press **ENTER** to start programmed playback.
4. To clear a music file from the program list, select the music you want to clear then press **CLEAR** or select “**↵**” icon and then press **ENTER**. To clear all music file from the program list, select “**↵**” then press **ENTER**.

Viewing a PHOTO file **JPG**



This unit can play discs with photo files.

1. Select the DVD/CD or USB function by pressing **FUNCTION**.
2. Press \wedge \vee to select a folder, and then press **ENTER**.
A list of files in the folder appears.
If you are in a file list and want to return to the previous folder list, use the \wedge \vee buttons on the remote to highlight **...** and press **ENTER**.
3. If you want to view a particular file, press \wedge \vee to highlight a file and press **ENTER** or **PLAY**. While viewing a file, you can press **STOP** to move to the previous menu (JPEG menu)

Viewing a PHOTO file as a slide show **JPG**

1. Highlight the file (not folder) which you like beginning slide show.
2. Use \wedge \vee $<$ $>$ to highlight the Speed. Then, use $<$ $>$ to select the (3s/ 5s/ 8s) option you want to use and then press **ENTER**.
3. Use \wedge \vee $<$ $>$ to highlight the (Slide Show) then press **ENTER**.

About help menu for slide show.

Menu	Buttons	Operation
$\blacktriangle/\blacktriangledown$	\wedge/\vee	Rotating the picture.
$\blacktriangleleft/\blacktriangleright$ Prev./ Next	$</>$	Moving to another file.
 Close	RETURN	Returning to the menu.
 Hide	ENTER	Hiding the help menu.

Setting the Clock

1. Turn the power on.
2. Press **CLOCK** for at least 2 seconds.
3. Choose from either, by using |<< or >>|.
 - AM 12:00 (for an AM and PM display) or
 - 0:00 (for a 24 hour display)
4. Press **SET** for confirm your selection.
5. Select the hours by using |<< or >>|.
6. Press **SET**.
7. Select the minutes, by using |<< or >>|.
8. Press **SET**.

Using your player as an alarm clock

1. Turn the power on.
2. Press **TIMER**. Each functions flashes.
3. Press **SET** when the function you want to be woken by is showing.
 - If you choose TUNER, "PLAY" and "REC" flashes in the display window alternately.
4. "ON TIME" will be displayed. This is where you set the time you want the alarm to start. Use the |<< or >>| to change the hours and minutes and **SET** to save.
5. The "OFF TIME" will be displayed. This is where you set the time you want the function to stop.
6. Use the |<< or >>| to change the hours and minutes and press **SET** to save.
7. You will be shown the volume (VOL) you want to be woken by. Use the |<< or >>| to change the volume and **SET** to save. The clock icon "🕒" shows that the alarm is set.
8. Press **TIMER** button 2times. You can check the setting status.

4

Operation

! NOTE

- If you set the clock time, you can check the time by pressing **CLOCK** even when the player is turned off.
- If you set the clock time and alarm, you can check the alarm icon "🕒" by pressing **CLOCK** even when the player is turned off.
- If you set the clock time and alarm, you can check the alarm icon "🕒" and setting information by pressing **TIMER** even when the unit is turned off.
- If you do not setup the clock time, you cannot use the **TIMER** function.

Sleep Timer Setting

Press **SLEEP** one or more times to select delay time between 10 and 180 minutes, after which the unit turn off.

To cancel the sleep function, press **SLEEP** repeatedly until "SLEEP 10" appears, and then press **SLEEP** once again while "SLEEP 10" is displayed.



NOTE

You can check the remaining time before the Unit turns off.

Press **SLEEP** The remaining time appears in the display window.

System Select - Optional

You must select the appropriate system mode for your TV system. If "NO DISC" appears in the display window, press and hold

PAUSE/STEP (II) for more than five seconds to be able to select a system. (AUTO/ PAL/ NTSC)

Displaying file information (ID3 TAG)

While playing an MP3 file containing file information, you can display the information by pressing **DISPLAY**.

4

Operation

Dimmer

Press **SLEEP** once. The display window will be darkened by half. To cancel it, press **SLEEP** repeatedly until dim off.

DEMO

Press **DEMO** once. In power off state to demonstrate the function on display window.

Turning off the sound temporarily

Press **MUTE** to mute your unit.

You can mute your unit in order, for example, to answer the telephone, appears the "M" in the display window.

Screen Saver

The screen saver appears when you leave the unit in Stop mode for about five minutes.

AUTO DJ playback

MP3 WMA ACD

Auto DJ blends the end of one song into the beginning of another for seamless playback. It equalizes volume across tracks for uninterrupted playback.

Press **AUTO DJ** on the remote control or unit repeatedly, the display changes as follows. order, (AUTO DJ RANDOM) ->(AUTO DJ SEQUENTIAL) -> (AUTO DJ OFF).

Mode	Display Window	Description
OFF	- (AUTO DJ OFF)	-
RANDOM	- (AUTO DJ RANDOM)	The music is played randomly on this mode.
REPEAT	- (AUTO DJ SEQUENTIAL)	The music is played repeatedly on this mode.



NOTE

- Searching for a section within a track or playing repeatedly or randomly is not supported on the AUTO DJ mode.
- If you switch to other functions or stop the music by pressing **STOP** twice on the unit(or **■** on the remote control) on AUTO DJ mode, AUTO DJ function will be disable.
- AUTO DJ function is not supported in the music file whose length is less than 60 seconds.
- All musics are repeated continuously until the user deactivates the AUTO DJ function.
- During the AUTO DJ operation, SCAN function is not available.
- During recording AUTO DJ function is not available.
- If you change a disc while the AUTO DJ function is activated the function is deactivated.

4

Operation

VOCAL FADER

You can enjoy the function as karaoke, by reducing singer vocal of music in the various source. (MP3/ WMA/ CD/ etc.)

Press the **VOCAL FADER**, and "FADE ON" will appear in display window.

To cancel it, press **VOCAL FADER** again.

The quality of the VOCAL FADER may be different depending on the recording conditions of music files.



NOTE

- This function is available to use only when a microphone is connected.
- It is not available on the MONO source.

Radio Operations

Be sure that both FM and AM (optional) aerials are connected. (Refer to the page 15)

Listening to the radio

1. Press **FUNCTION** on the remote control or **TUNER** on the unit until FM or AM (optional) (MW) appears in the display window. The last received station is tuned in.
2. Press and hold **TUNING (-/+)** on the unit or **TUN.(-/+)** on the remote control for about two seconds until the frequency indication starts to change, then release. Scanning stops when the unit tunes in a station.

or

Press **TUNING (-/+)** on the unit or **TUN.(-/+)** on the remote control repeatedly.

3. Adjust the volume by rotating VOL. on the front panel or by pressing **VOL (-/+)** on the remote control repeatedly.

Presetting the Radio Stations

You can preset 50 stations for FM and AM (optional) (MW).

Before tuning, make sure that you have turned down the volume.

1. Press **FUNCTION** on the remote control or **TUNER** on the unit until FM or AM (optional) (MW) appears in the display window.
2. Select the desired frequency by using **TUNING (-/+)** on the unit or pressing **TUN.(-/+)** on the remote control.
3. Press **PROG./MEMO**. preset number will flash in the display window.
4. Press **PRESET (-/+)** to select the preset number you want.
5. Press **PROG./MEMO**. The station is stored.
6. Repeat the steps 2 to 5 to store other stations.

Improving poor FM reception

Press **PLAY (▶) (MO./ST.)** on the remote control. This will change the tuner from stereo to mono and usually improve the reception

Deleting all the saved station

1. Press and hold **PROG./MEMO.** for two seconds.
"ERASE ALL" will flash up on the unit display.
2. Press **PROG./MEMO.** to erase of the saved radio stations.

Sound adjustment

Setting the surround mode

This system has a number of pre-set surround sound fields. You can select a desired sound mode by using **LG EQ/EQ**

You can change the **LG EQ/EQ** using < > arrow key while the sound effect information is displayed on.

The displayed items for the equalizer maybe different depending on sound sources and effects.

On Display	Description
NATURAL	You can enjoy comfortable and natural sound
Local Specialization equalizer	Regionally optimized sound effect. (DANGDUT/ ARABIC/ PERSIAN/ INDIA/ REGUETON/ MERENGUE/ SAMBA/ SALSA)
AUTO EQ	Sets the sound equalizer on the mode that is the most similar to the genre which is included in the MP3 ID3 tag of song files.
POP CLASSIC JAZZ ROCK	This program lends an enthusiastic atmosphere to the sound, giving you the feeling you are at an actual rock pop, jazz or classic concert.
MP3 - OPT	This function is optimized for compressible MP3 file. It improves the treble sound.
BASS BLAST	Reinforces the treble, bass and surround sound effect.

On Display	Description
VIRTUAL	You can enjoy more virtual surround sound.
BYPASS	You can enjoy the sound with out equalizer effect.



NOTE

- In some of surround modes, some speakers, there's no sound or low sound. It depends on the mode of surround and the source of audio, it is not defective.
- You may need to reset the surround mode, after switching the input, sometimes even after the sound track changed.
- You can not choose the VIRTUAL option, when the MIC is connected to the unit.

Setting the USER EQ

You can listen to music with the desired sound effect by adjusting the BASS, MIDDLE and TREBLE.

1. Press **USER EQ**.
"USER EQ" is displayed.
2. Press **SET** to enter the **USER EQ**.
3. Select the BASS, MIDDLE or TREBLE sound effect you want by using < (-)PRESET(+)> on the unit.
4. Press |<< (-)TUNING(+) >>| on the unit to select the sound level you want.
5. To finish the setting, press **SET**.

Advanced Operations

Listening to music from your external device

The unit can be used to play the music from many types of external devices.
(Refer to the page 17)

1. Connect the external device to the AUX IN connector on the unit.
2. Turn the power on by pressing **⏻/I** (Power)
3. Select the AUX function by pressing **FUNCTION**.
4. Turn on the external device on and start it playing.

Recording to TAPE

You can record a various sound source to TAPE.

1. Open the tape deck and then insert a blank tape.
2. Select a function in which you want to record.
3. Playback a sound source first.
4. Press **R** on the unit or **● REC** on the remote control.
> The display changed in the following order, "USB REC" <-> "TAPE REC"
5. Press the **R** on the unit or **● REC** on the remote control button once more when "TAPE REC" is displayed.
> Recording starts.
6. To stop recording, press **STOP** on the unit or **■** on the remote control.

Pausing recording

During TAPE recording, press **R** on the unit or **● REC** on the remote control to pause recording. Press it again to restart recording.

Synchronized Recording from CD to Tape

1. Open the tape deck and then insert a blank tape.
2. Close the door and insert a CD.
> Audio CD only
3. Select **CD** function.
4. Press **CD SYNC** on a stop status to move to CD synchronizing mode.
> The synchronized recording is started automatically after about 7 seconds.
5. To stop, press **STOP** on the unit or **■** on the remote control.

Recording to USB

You can record a various sound source to USB.

1. Connect the USB device to the unit.
2. Select a function in which you want to record Playback a sound source first.
3. Press **R** on the unit or **● REC** on the remote control.
> The display is changed in the following order, "USB REC" <-> "TAPE REC"
4. Press the **R** on the unit or **● REC** on the remote control button once more when "USB REC" is displayed.
> Recording starts.

[One tracks/ files recording]

You can record to USB after playing the file you want.

[All tracks/ files recording]

Record to USB in stop.

[Program list recording]

After marking desired file(s) and you can record it to USB. (AUDIO CD Only)

5. To stop recording, press **STOP** on the unit or **■** on the remote control.

The making of unauthorized copies of copy-protected material, including computer programs, files, broadcasts and sound recordings, may be an infringement of copyrights and constitute a criminal offense. This equipment should not be used for such purposes.

**Be responsible
Respect copyrights.**



NOTE

- You can check the recording percentage rate for the USB record on the screen during the recording. (Audio CD or MP3/ WMA CD only)
- During recording MP3/WMA, there is no sound.
- When you stop recording during playback, the file that has been recorded at that time will be stored. (Audio CD only)
- Do not remove the USB device or turn off the unit during USB recording. It will result in, an incomplete file being made and may not deleted be on a PC.
- Recording through microphones is not available.
- If USB recording does not work, messages like "NO USB", "ERROR", "USB FULL" or "NO REC" will be displayed on the display window.
- Multi card reader device or external HDD can not be used for USB recording.
- A file is recorded up to 128 Mbyte (about 2 hours) maximum when you record for a long term.
- USB record is not possible from CD-G discs.
- You may not record more than 999 files.
- **It'll be stored as follows**

AUDIO CD	MP3/ WMA	The other source
<ul style="list-style-type: none"> ■ CD_REC TRK_001 TRK_002 : : 	<ul style="list-style-type: none"> ■ FILE_REC 001_ABC(File name) 002_DEF(File name) : : 	<ul style="list-style-type: none"> ■ EXT_REC AUD_001 AUD_002 : :

5 Maintenance

Notes on Discs

Handling Discs



Never stick paper or tape on the disc.

Storing Discs

After playing, store the disc in its case. Do not expose the disc to direct sunlight or sources of heat and never leave it in a parked car exposed to direct sunlight.

Cleaning Discs

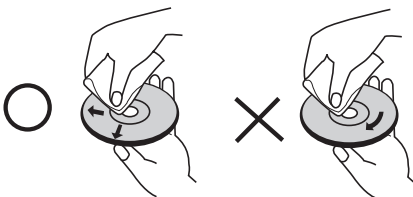

Do not use strong solvents such as alcohol, benzene, thinner, commercially available cleaners, or anti-static spray intended for older vinyl records.

Handling the Unit

When shipping the unit

Please save the original shipping carton and packing materials. If you need to ship the unit, for maximum protection, re-pack the unit as it was originally packed at the factory.

Keeping the exterior surfaces clean

Do not use volatile liquids such as insecticide spray near the unit. Wiping with strong pressure may damage the surface. Do not leave rubber or plastic products in contact with the unit for a long period of time.

Cleaning the unit

To clean the player, use a soft, dry cloth. If the surfaces are extremely dirty, use a soft cloth lightly moistened with a mild detergent solution. Do not use strong solvents such as alcohol, benzene, or thinner, as these might damage the surface of the unit.

Maintaining the Unit

The unit is a high-tech, precision device. If the optical pick-up lens and disc drive parts are dirty or worn, the picture quality could be diminished. For details, please contact your nearest authorized service center.

6

Troubleshooting

Troublushooting

PROBLEM	CAUSE	CORRECTION
No power	The power cord is disconnected.	Plug the power cord into the wall outlet securely.
No picture	The TV is not set to receive the DVD signal.	Select the appropriate video input mode on the TV so the picture from the unit appears on the TV screen.
	The video cables are not connected securely.	Connect the video cables securely to both the TV and unit.
There is little or no sound	Equipment connected via the audio cable is not set to receive DVD signal output.	Select the correct input mode of the unit so you can hear the sound from the unit.
	The audio cables are not connected to the speakers or unit securely.	Connect the audio cables into the connection terminals correctly.
	The audio cables are damaged.	Replace with a new audio cable.
A DVD/CD will not play	No disc is inserted.	Insert a disc.
	An unplayable disc is inserted.	Insert a playable disc (check the disc type, colour system and regional code).
	The disc is inserted upside down.	Place the disc with the label or printed side facing upwards.
	There is a parental lock which prevents the playback of DVDs with a certain rating.	Enter your password or change the rating level.
Humming noise heard while a DVD or CD is playing	The disc is dirty.	Clean the disc using a soft cloth with outward strokes.
	The unit is located too close to the TV, causing feedback.	Move unit and audio components further away from your TV.
Radio stations can't be tuned in properly	The antenna is positioned or connected poorly.	Check the antenna connection and adjust its position. Attach an external aerial if necessary.
	The signal strength of the radio station is too weak.	Tune to the station manually.
	No stations have been preset or preset stations have been cleared (when tuning by scanning preset channels).	Preset some radio stations, see page 32 for details.
The remote control doesn't work well / at all	The remote is not pointed directly at the unit.	Point the remote directly at the unit.
	The remote is too far from the unit.	Use the remote within 23 feet (7 m) of the unit.
	There is an obstacle in the path between the remote control and the unit.	Remove the obstacle.
	The battery in the remote control are flat.	Replace the battery with new ones.

7

Appendix

Language Codes

Use this list to input your desired language for the following initial settings: Disc Audio, Disc Subtitle, Disc Menu.

Language	Code	Language	Code	Language	Code	Language	Code
Afar	6565	French	7082	Lithuanian	7684	Singhalese	8373
Afrikaans	6570	Frisian	7089	Macedonian	7775	Slovak	8375
Albanian	8381	Galician	7176	Malagasy	7771	Slovenian	8376
Ameharic	6577	Georgian	7565	Malay	7783	Spanish	6983
Arabic	6582	German	6869	Malayalam	7776	Sudanese	8385
Armenian	7289	Greek	6976	Maori	7773	Swahili	8387
Assamese	6583	Greenlandic	7576	Marathi	7782	Swedish	8386
Aymara	6588	Guarani	7178	Moldavian	7779	Tagalog	8476
Azerbaijani	6590	Gujarati	7185	Mongolian	7778	Tajik	8471
Bashkir	6665	Hausa	7265	Nauru	7865	Tamil	8465
Basque	6985	Hebrew	7387	Nepali	7869	Telugu	8469
Bengali; Bangla	6678	Hindi	7273	Norwegian	7879	Thai	8472
Bhutani	6890	Hungarian	7285	Oriya	7982	Tonga	8479
Bihari	6672	Icelandic	7383	Panjabi	8065	Turkish	8482
Breton	6682	Indonesian	7378	Pashto, Pushto	8083	Turkmen	8475
Bulgarian	6671	Interlingua	7365	Persian	7065	Twi	8487
Burmese	7789	Irish	7165	Polish	8076	Ukrainian	8575
Byelorussian	6669	Italian	7384	Portuguese	8084	Urdu	8582
Chinese	9072	Javanese	7487	Quechua	8185	Uzbek	8590
Croatian	7282	Kannada	7578	Rhaeto-Romance	8277	Vietnamese	8673
Czech	6783	Kashmiri	7583	Rumanian	8279	Volapük	8679
Danish	6865	Kazakh	7575	Russian	8285	Welsh	6789
Dutch	7876	Kirghiz	7589	Samoan	8377	Wolof	8779
English	6978	Korean	7579	Sanskrit	8365	Xhosa	8872
Esperanto	6979	Kurdish	7585	Scots Gaelic	7168	Yiddish	7473
Estonian	6984	Laothian	7679	Serbian	8382	Yoruba	8979
Faroese	7079	Latin	7665	Serbo-Croatian	8372	Zulu	9085
Fiji	7074	Latvian, Lettish	7686	Shona	8378		
Finnish	7073	Lingala	7678	Sindhi	8368		

Area Codes

Choose a area code from this list.

Area	Code	Area	Code	Area	Code
Afghanistan	AF	Greenland	GL	Paraguay	PY
Argentina	AR	Hong Kong	HK	Philippines	PH
Australia	AU	Hungary	HU	Poland	PL
Austria	AT	India	IN	Portugal	PT
Belgium	BE	Indonesia	ID	Romania	RO
Bhutan	BT	Israel	IL	Russian Federation	RU
Bolivia	BO	Italy	IT	Saudi Arabia	SA
Brazil	BR	Jamaica	JM	Senegal	SN
Cambodia	KH	Japan	JP	Singapore	SG
Canada	CA	Kenya	KE	Slovak Republic	SK
Chile	CL	Kuwait	KW	Slovenia	SI
China	CN	Libya	LY	South Africa	ZA
Colombia	CO	Luxembourg	LU	South Korea	KR
Congo	CG	Malaysia	MY	Spain	ES
Costa Rica	CR	Maldives	MV	Sri Lanka	LK
Croatia	HR	Mexico	MX	Sweden	SE
Czech Republic	CZ	Monaco	MC	Switzerland	CH
Denmark	DK	Mongolia	MN	Taiwan	TW
Ecuador	EC	Morocco	MA	Thailand	TH
Egypt	EG	Nepal	NP	Turkey	TR
El Salvador	SV	Netherlands	NL	Uganda	UG
Ethiopia	ET	Netherlands Antilles	AN	Ukraine	UA
Fiji	FJ	New Zealand	NZ	United States	US
Finland	FI	Nigeria	NG	Uruguay	UY
France	FR	Norway	NO	Uzbekistan	UZ
Germany	DE	Oman	OM	Vietnam	VN
Great Britain	GB	Pakistan	PK	Zimbabwe	ZW
Greece	GR	Panama	PA		

Trademarks and Licenses



Dolby, Pro Logic, and the double-D symbol are registered trademarks of Dolby Laboratories.



"DVD Logo" is a trademark of DVD Format/Logo Licensing Corporation.



DivX is a registered trademark of DivX, Inc., and is used under license.

Specifications

General

- Power supply:
Refer to main label
- Power consumption:
Refer to main label
- Dimensions (W x H x D):
(272 X 336 X 352) mm
- Net Weight (Approx.):
MDT355: 5.5 Kg
MDD65 : 5.2 kg
MDD105 : 5.3 kg
MDD265 : 5.4 kg
- Operating temperature:
5 °C to 35 °C,
- Operation status:
Horizontal
- Operating humidity:
5 % to 85 %
- Bus Power supply (USB):
5 V $\overline{\text{---}}$ 500 mA
- Bus Version
USB 2.0 or USB 1.1

Inputs/ Outputs

- VIDEO OUT:
1.0 V (p-p), 75 Ω , sync negative, RCA jack x 1
- COMPONENT VIDEO OUT:
(Y) 1.0 V (p-p), 75 Ω , sync negative, RCA jack x 1,
(Pb)/(Pr) 0.7 V (p-p), 75 Ω , RCA jack x 2
- AUX. IN:
0.6 V (RCA jack x 2)

Tuner

- FM Tuning Range:
87.5 to 108.0 MHz or 87.50 to 108.00 MHz
- AM Tuning Range:
522 to 1 620 kHz or 520 to 1 710 kHz or
522 to 1 710 kHz

Amplifier

- OUTPUT POWER:
Front (MDT355) : 100 W x 2 (4 Ω)
Subwoofer (MDT355) : 150 W (3 Ω)

Front (MDD265): 130 W x 2 (4 Ω)

Front (MDD105): 50 W x 2 (4 Ω)

Front (MDD65): 30 W x 2 (4 Ω)

- T.H.D
0.5 %
- Frequency Response
140 to 20000 Hz
- Signal-to-noise ratio
75dB

DVD/CD player

- Frequency response (audio)
100 to 18000 Hz
- Signal-to-noise ratio (audio)
More than 75 dB (1 kHz)
- Signal-to-noise ratio (video)
More than 55 dB (1 kHz)
- Dynamic range (audio)
More than 80 dB

Speakers

- Front speaker (MDS355V)
Type: 2 Way 2 speaker
Impedance : 4 Ω
Rated Input Power: 100 W
Max. Input power: 200 W
Net Dimensions
(W x H x D): (222 x 337 x 250) mm
Net Weight: 3.4 kg
- Passive Subwoofer (MDS355W)
Type: 1 Way 1 speaker
Impedance: 3 Ω
Rated Input Power: 150 W
Max. Input power: 300 W
Net Dimensions
(W x H x D): (272 x 337 x 309) mm
Net Weight: 5.4 kg
- Front speaker (MDS65V)
Type: 2 Way 2 speaker
Impedance : 4 Ω
Rated Input Power: 30 W
Max. Input power: 60 W
Net Dimensions
(W x H x D): (202 x 337 x 237) mm
Net Weight: 2.47 kg
- Front speaker (MDS105V)
Type: 2 Way 2 speaker
Impedance : 4 Ω
Rated Input Power: 50 W
Max. Input power: 100 W
Net Dimensions
(W x H x D): (202 x 337 x 237) mm
Net Weight: 2.57 kg
- Front speaker (MDS265V)
Type: 2 Way 2 speaker
Impedance : 4 Ω
Rated Input Power: 130 W
Max. Input power: 260 W
Net Dimensions
(W x H x D): (222 x 337 x 270) mm
Net Weight: 3.2 kg

Designs and specifications are subject to change without prior notice.



	Телефон	Режим работы	Интернет
Россия	8-800-200-7676	Круглосуточно	http://www.lg.com
Беларусь	8-820-0071-1111		
Латвия	8-0003-271		
Литва	8-800-30-800		
Эстония	800-9990		
Украина	0-800-303-000	8:00 - 21:00 (Пн.-Пят.) 9:00 - 18:00 (Суб., Вс.)	http://www.lg.com
Казахстан	8-8000-805-805	9:00 - 18:00 (Пн.-Пят.) 9:00 - 18:00 (Суб.)	
	2255 (для мобильных телефонов)		
Кыргызстан	8-0000-710-005	Круглосуточно	
Узбекистан			

MADE IN CHINA