

LAC-M0510R_ENG



Car CD/MP3 Receiver

***OWNER'S MANUAL
MODEL : LAC-M0510R***



Before connecting, operating or adjusting this product,
please read this instruction booklet carefully and completely.



Table of Contents

INTRODUCTION

Table of Contents	2
Safety Precautions	3
Before Use.	4-5
Front Panel.	6

PREPARATION

Installation	7
Connections.	8-9

OPERATION

Basic Operation	10-11
Turning the unit on.	10
Turning the unit off.	10
Selecting a source.	10
Adjusting the volume	10
Checking the clock.	10
SOUND Adjustment	11
RDS Operation.	12-13
RDS Display Options.	12
RDS AF/REG FUNCTION	12
LOCAL/DX selection in EON-TA mode	12
PROGRAM TYPE FUNCTION	12
RDS MODE Adjustment.	13

Radio Operation	14
Listening the radio stations	14
Auto Search Memory	14
Storing and recalling broadcast frequencies	14
Operation with Audio CD, MP3	15-16
Playing an Audio CD and MP3 Disc	15

REFERENCE

Troubleshooting	17
Specifications	



Disposal of your old appliance

1. When this crossed-out wheeled bin symbol is attached to a product it means the product is covered by the European Directive 2002/96/EC.
2. All electrical and electronic products should be disposed of separately from the municipal waste stream via designated collection facilities appointed by the government or the local authorities.
3. The correct disposal of your old appliance will help prevent potential negative consequences for the environment and human health.
4. For more detailed information about disposal of your old appliance, please contact your city office, waste disposal service or the shop where you purchased the product.

Safety Precautions



CAUTION

RISK OF ELECTRIC SHOCK DO NOT OPEN



Warning: To reduce the risk of electric shock, do not remove the cover or back of this product. There are no user-serviceable parts inside. Refer servicing to qualified service personnel.



Warning: To reduce the risk of fire or electric shock, do not expose this product to dripping or splashing water, rain, or moisture.



Warning: Due to high temperature outside of the unit, please use the unit only installed in a car.

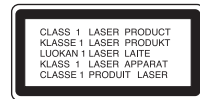

Caution: Protect this product from moisture.



Caution: If the battery is disconnected or discharged, the preset memory will be erased and must be reprogrammed.

CAUTION:

This unit employs a Laser System.

To ensure proper use of this product, please read this owner's manual carefully and retain for future reference should the unit require maintenance, contact an authorized service location (see service procedure).

Use of controls, adjustments, or the performance of procedures other than those specified herein may result in hazardous radiation exposure.

To prevent direct exposure to laser beam, do not try to open the enclosure. Visible laser radiation when open. DO NOT STARE INTO BEAM.

INTRODUCTION



Before Use

To ensure proper use of this product, please read this owner's manual carefully and retain for future reference.

Symbol Used in this Manual



The lightning flash symbol alerts you to the presence of dangerous voltage within the product enclosure that may constitute a risk of electric shock.



Indicates hazards likely to cause harm to the unit itself or other material damage.

NOTE

Indicates special notes and operating features.

TIP

Indicates tips and hints for making the task easier.

Handling the Unit

- This unit is designed to be operated on a 12 volt DC negative ground electrical system only.
- When replacing the fuse, be sure to use the fuse whose amperage rating is identical. Use of a fuse with higher amperage may cause serious damage to the unit.
- Periodically wipe the contacts on the back of the front panel with a cotton swab moistened with alcohol.

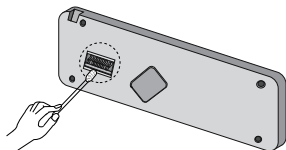

Notes on Discs

Handling Discs

Do not touch the playback side of the disc. Hold the disc by the edges so that fingerprints do not get on the surface. Never stick paper or tape on the disc.



Storing Discs

After playing, store the disc in its case. Do not expose the disc to direct sunlight or sources of heat and never leave it in a parked car exposed to direct sunlight.

Cleaning Discs

Fingerprints and dust on the disc can cause poor picture quality and sound distortion. Before playing, clean the disc with a clean cloth. Wipe the disc from the center out.

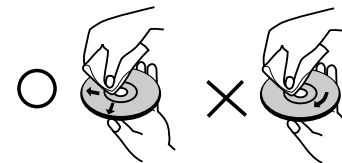

Do not use strong solvents such as alcohol, benzene, thinner, commercially available cleaners, or anti-static spray intended for older vinyl records.

This unit cannot be operated by 8cm disc (using 12cm disc only).

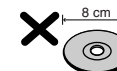

Before Use



Protecting your unit from theft

The front panel can be detached from the head unit and stored in the protective case provided to discourage theft.

1. Press **RELEASE** (▲) to open the front panel.

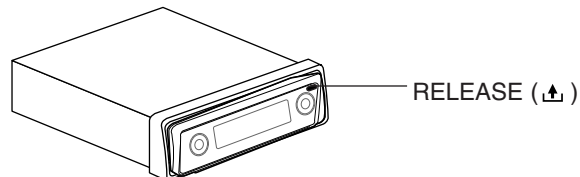

2. Grip the left side of the front panel and pull it gently outward.
Take care not to grip it tightly or to drop it.

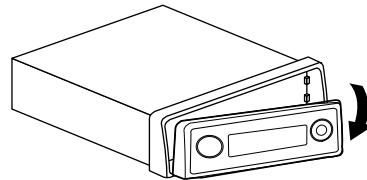

3. Put the front panel into the protective case provided for safe keeping.

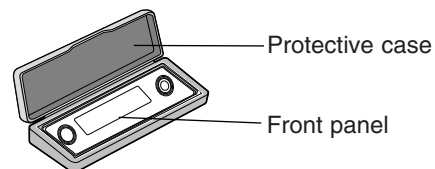

Attaching the front panel

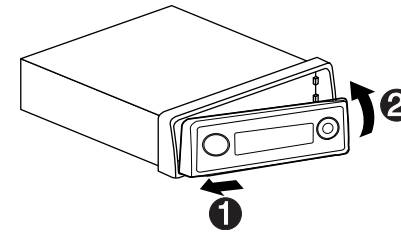

Align the left side of the panel with the stopper, and then push the right side of the panel into the unit until it clicks.

Front Panel

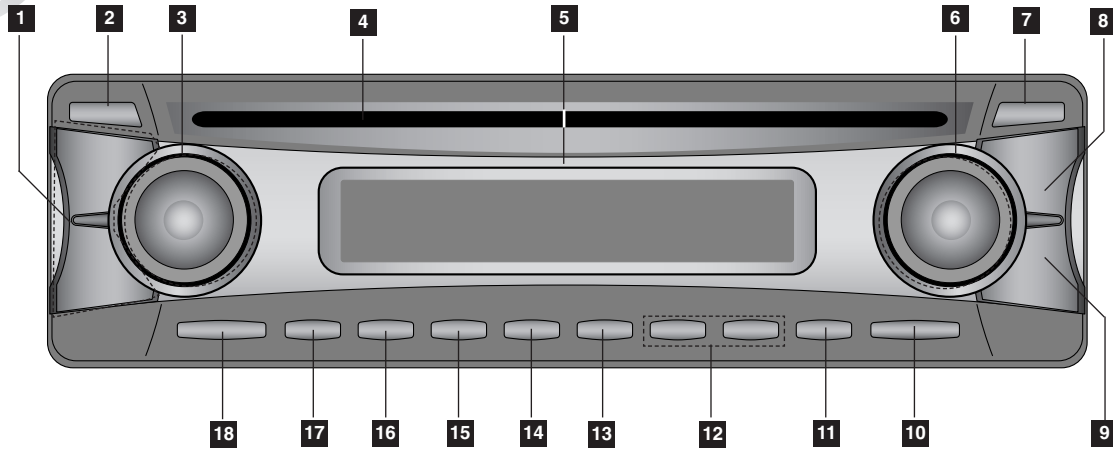

1 • VOLUME (VOL-/+) button

• CONTROL UP/DOWN button

2 EJECT (▲) button

3 • CD SKIP/SEARCH (◀/▶) button

• SEEK/TUNE (-/+) button

4 CD disc slot

5 DISPLAY WINDOW

6 • PTY/TA button

• ALTERNATIVE FREQUENCIES/REGIONAL (AF/REG) button

• DISPLAY (DISP) button

7 RELEASE (⏏) button

8 FUNCTION (FUNC) button

9 EQUALIZER/XDSS (EQ/XDSS) button

10 SELECTION (SEL.) button

11 AUTO STORE/PRESET SCAN (AS/PS) button

12 MP3 TRACK +/-10 button

13 SHUFFLE (SHF) button

14 REPEAT (RPT) button

15 INTRO SCAN (SCAN) button

16 CD PLAY/PAUSE (▶/⏏) button

17 BAND button

18 PWR/MUTE button

12, **13**, **14**, **15**, **16** Preset Station buttons. (1-6)

Installation



Basic Installation

Before installing, make sure that the ignition-switch is set to OFF and remove the terminal of the car battery to avoid short-circuiting.

1. Remove the existing receiver unit.
2. Make the necessary connections.
3. Install the installation sleeve.
4. Install the unit in to the installation sleeve.

Removing existing receiver unit

If there is already an installation sleeve for the receiver unit in the dashboard, it must be removed.

When removing the unit from the installation sleeve

If you need to remove the unit from the installation sleeve, proceed as follows.

1. Remove the rear supporter from the unit.
2. Remove the front panel and trim ring from the unit.
3. Insert the lever **A** into the hole on one side of the unit. Do the same operation on the other side and pull out the unit from the installation sleeve.

ISO-DIN Installation

1. Slide the unit into ISO-DIN frame.
2. Install screws removed from old unit.
3. Slide the unit and frame into dash opening.
4. Install dash panel or adapter plate.
5. Install trim ring to the unit.
6. Install faceplate by fitting right edge into position then pushing left edge closed.

Bend the claws according to the thickness of the dashboard

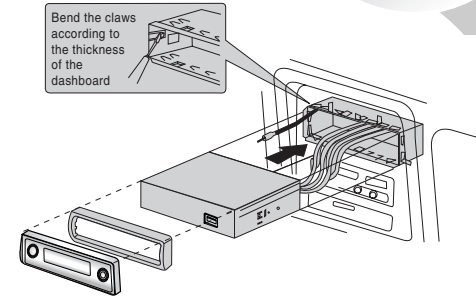

PREPARATION

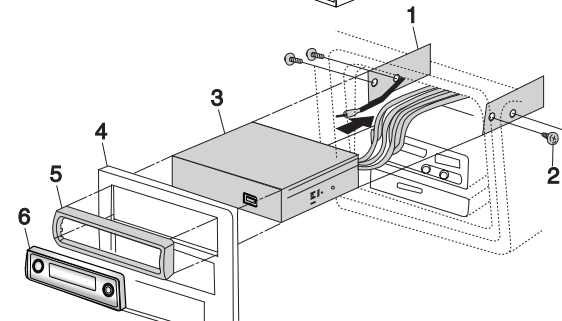
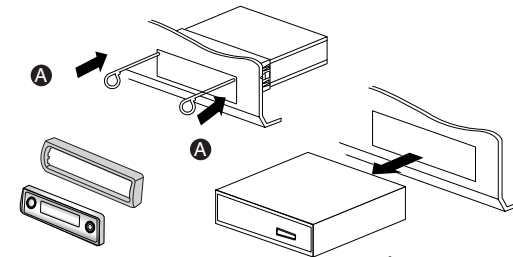



Connections

Connecting to Car

Before connecting, make sure that ignition switch is set to OFF, and remove the ⊖ terminal of the battery to avoid short circuits.

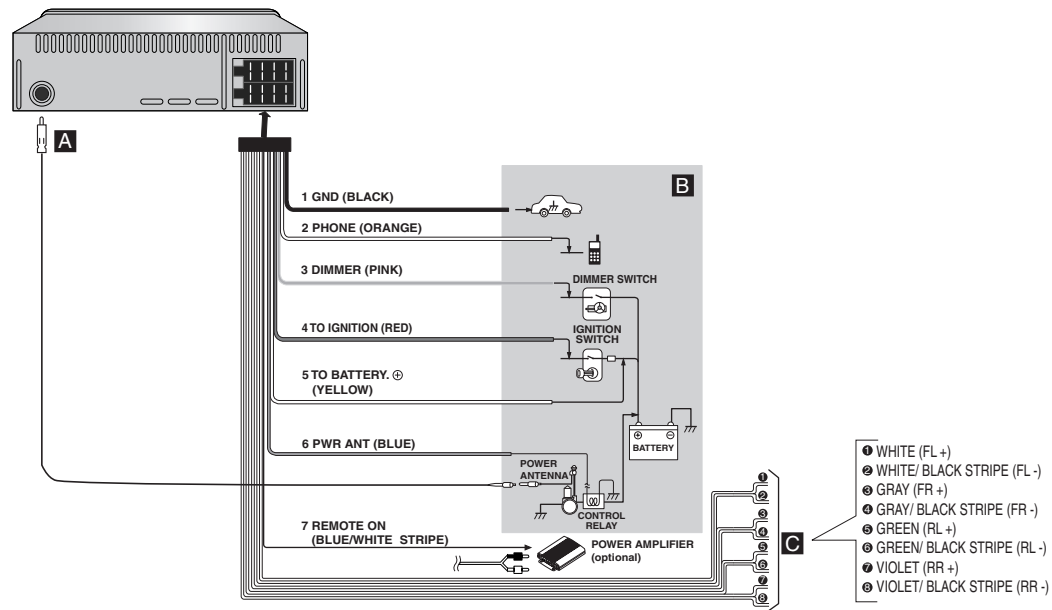

Connections

Connecting to Car

A From antenna

B To the wiring of vehicle **Colors of leads**

- 1 BLACK :** This lead is for connection to the Ground.
- 2 ORANGE :** This lead is for connection to the phone line.
- 3 PINK :** This lead is for connection to the Dimmer line
- 4 RED :** This lead is for connection to the terminal from which the power is supplied when the ignition switch is set to ACC.
- 5 YELLOW :** This lead is for connection to the Battery (back-up) terminal from which the power is always supplied.
- 6 BLUE :** This lead is for connection to the power antenna.
- 7 BLUE/WHITE STRIPE :** This lead is for connection to the amplifier remote on.

C Speaker Connections

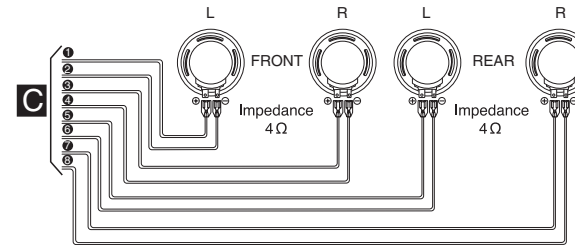

PREPARATION



Basic Operation

Turning the unit on

Press **PWR/MUTE** or any other button on the front panel.

Turning the unit off

Press **PWR/MUTE** on the front panel for more than 1.2 second to turn the unit off.

Selecting a source

You can select a source you want to listen to.

Press **FUNC.** to select a source.

Press **FUNC.** repeatedly to switch between the following sources:

Tuner → CD → Tuner...

NOTE

- When you turn off, the unit is memorized automatically the current volume level before you turn off. Whenever you turn on the unit, it will operate at the memorized volume level.

Adjusting the volume

Use **VOLUME** to adjust the sound level.

Press **VOLUME (VOL+/-)** button on the front panel to increase or decrease the volume.

Checking the clock

You can see the clock pressing **DISP** for more than 1 second.

NOTES

- If the unit is received the RDS broadcasting with CT (Clock Time) information, the clock will be shown automatically in the display window.
- Unless, "NO CLOCK" appears in the display window.

Basic Operation



SOUND Adjustment

Using the EQ (Equalizer)

The equalizer lets you adjust the equalization to match the acoustic characteristics of the car's interior as desired. There are 3 stored equalizer curves which you can easily recall at any time.

Here is a list of the equalizer curves:

- EQ POP : Reproduces pop music acoustics.
- EQ CLASSIC : Reproduces orchestral music acoustics.
- EQ ROCK : Reproduces rock music acoustics.

1. Press **EQ/XDSS** on the front panel to select the equalizer.
2. Press **EQ/XDSS** repeatedly to choose between the following Equalizer settings.
POP → CLASSIC → ROCK → JAZZ → VOCAL
→ FLAT (NO display) → POP...

MUTE

1. Press **PWR/MUTE** to cut the sound.
2. To cancel it press **PWR/MUTE** again.

SELECTION (SEL) Button

1. Press the **SELECTION (SEL.)** button repeatedly to select the mode you want to adjust from volume, bass, treble, balance and fader. The mode indicator lights up in the following order.

→ VOL → BAS → TRB → BAL → FAD]

2. Press CONTROL UP (**VOL+**) or DOWN (**VOL-**) to adjust the sound quality.

	Turn right	Turn left
VOL	Increase the volume level.	Decrease the volume level.
BAS	Increase the bass level.	Decrease the bass level.
TRB	Increase the Treble level.	Decrease the Treble level.
BAL	Decrease the level of the left speaker(s).	Decrease the level of the right speaker(s).
FAD	Decrease the level of the front speaker(s).	Decrease the level of the rear speaker(s).

NOTE

The unit cannot adjust the bass and treble in the **EQ/XDSS** mode.

XDSS (Extreme Dynamic Sound System)

Press and hold the **EQ/XDSS** button to reinforce treble, bass and surround effect.



RDS Operation

RDS Display Options

In normal RDS operation the display will indicate the station name. Pressing **DISP** on the front panel enables you to cycle through the various data types in the sequence:

(CT→FREQUENCY→PTY→RT→PS)

- **CT** (Time controlled by the channel)
- **PTY** (Program type recognition)
- **RT** (Radio text recognition)
- **PS** (Program Service name)
- **PI** (Program Identification)
- **AF** (Alternative Frequencies for the actual program)
- **TP** (Traffic Program Identification)
- **TA** (Traffic Announcement Identification)
- **EON** (Enhanced Other Networks)

NOTES

- RDS is only available for FM reception.

RDS AF/REG FUNCTION

To switch on or off the AF function (Network-Tracking), shortly press the '**AF**' button. To switch on or off the REG function (Regional Network Tracking), press the '**AF**' button longer than 2 seconds.

LOCAL/DX selection in EON-TA mode

In the EON-TA mode, press the TA button for more than 2 seconds, causes only local and strong stations to be received. When TA button is pressed for more than 2 seconds, it receives all stations, including distant and weak ones. It is recommended to set TA button to the local position to receive local stations with good sound quality.

PROGRAM TYPE FUNCTION

To select a certain program type out of the reception band, following procedure can be operated.

1. Press **BAND** to select in FM mode.
2. After, pressing **PTY** button one by one activated as selecting each mode.
music group→speech group→search off
3. Press one of the **PRESET (1-6)** button shortly. Each time this button is pressed, the display mode changes as follow.

No	Music group
1.	Pop M, Rock M
2.	Easy M, Light M.
3.	Classics, Other M
4.	Jazz, Country
5.	Nation M, Oldies
6.	Folk M
No	Speech group
1.	News, Affairs, Info
2.	Sport, Educate, Drama
3.	Culture, Science, Varied
4.	Weather, Finance, Children
5.	Social, Religion, Phone In
6.	Travel, Leisure, Document

RDS Operation



RDS MODE Adjustment

1. Press the **SEL.** button for more than 2 seconds it is activated selecting mode.
2. After, pressing **SEL.** button one by one activated as selecting each mode.
3. Press **CONTROL UP (VOL+)** or **DOWN (VOL-)** to select the indicator.

TA SEEK mode

When the newly tuned station does not receive TP information for 5 sec, the receiver retunes to next station which has no same PI as the last station's, but has the TP information.

TA ALARM mode

When a newly tuned station has no TP information for 5 sec, double beep sound is output.

PI SOUND mode

If the sound of a station with different PI is heard once in a while, the receiver mutes the sound after 1 second.

PI MUTE mode

If the situation described above is occurred, the receiver mutes the sound right now.

RETUNE L mode

The waiting time for starting TA search or PI search is selectable. Retune time is set to 90 seconds.

RETUNE S mode

The waiting time for starting TA search or PI search is selectable. Retune time is set to 30 seconds.

BEEP 2ND mode

The beep is only generated when key is pressed long (1 sec)

BEEP ALL mode

The beep is generated when every key is pressed.



Radio Operation

Listening the radio stations

1. Press **PWR/MUTE** button to turn the unit on.
 - When you select a source the unit is turned on.
2. Press **FUNC.** button to select the tuner.
3. Press **BAND** button to select a band.
 - Press **BAND** button until the desired band is displayed, FM1, FM2, FM3, MW(AM).
4. To perform seek tuning, press the ◀/▶ with quick presses.
 - The tuner will scan the frequencies until a broadcast strong enough for good reception is found.
 - You can cancel seek tuning by pressing either the ◀/▶ with quick presses.
5. To perform manual tuning, press and hold the ◀/▶ for 1 second. And then press the ◀/▶ with quick presses.
 - The frequencies move up or down step by step.

NOTES

- When the selected frequency is being broadcast in stereo, “((ST))” indicator will light.

Auto Search Memory

This function lets you automatically store the six strongest broadcast frequencies.

1. Press **FUNC.** button to select the tuner.
2. Press **AS/PS** button on the front panel for about 1 second.
 - The scanning starts from the currently displayed frequency to higher frequencies and stops when 6 stations have been preset or the receivable frequencies have been scanned once.

NOTES

- The presetting is not performed if there is no station to be tuned in.
- When the automatic presetting is performed, the previous preset stations are automatically erased.
- To stop the automatic presetting, press **BAND** or **AS/PS** button.

To scan the preset stations

Press **AS/PS** button on the front panel.

To stop the scanning, press **AS/PS** button.

To tune in the preset stations

Press **BAND** to select the desired band and press the desired number buttons (1-6).

The number of the preset station button is displayed and the preset station is received.

Storing and recalling broadcast frequencies

You can easily store up to six broadcast frequencies for later recall with the touch of a button.

1. Select the desired frequency
2. Press one of the **preset station** buttons (1 - 6) for more than 1 seconds. The number of the pressed preset station button is displayed.
3. Repeat steps 1 and 2 to preset other stations.

NOTES

- As F1, F2, F3 have the same frequency range, up to 18 station can be preset for FM.
- When a station is preset on the preset station button on which another station of the same band has already been preset, the previously preset station is automatically erased.

Operation with Audio CD, MP3 Disc



Playing an Audio CD and MP3 Disc

CD **MP3**

The unit can play MP3 formatted recordings on CD-ROM, CD-R or CD-RW discs.

Before playing MP3 recordings, read the notes on MP3 Recordings on page 18.

Pause **CD** **MP3**

1. Press **PLAY/PAUSE (▶/⏸)** during playback.
2. To return to playback, press **PLAY/PAUSE (▶/⏸)** again.

Moving to another Track **CD** **MP3**

- Press the **⏪ / ▶** briefly during playback to go to the next track or to return to the beginning of the current track.
- Press the **⏪** twice briefly to step back to the previous track. (If playing times is in less then 3 seconds and then this function is not operated.)

Search **CD**

Press and hold the **⏪ / ▶** for about 1 second during playback and then release at the point you want.

OPERATION



Operation with Audio CD, MP3 Disc

Repeat

1. Press **RPT** during playback. **CD** **MP3**
The "RPT" appears in the display window.
(It is played repeatedly the whole music within disc)
2. Press **RPT** again.
The "RPT" disappears in the display window.
(The repeat mode is cancelled.)

Random

1. Press **SHF** during playback. **CD** **MP3**
The "SHF" appears in the display window.
(It is played redomly the whole music within disc)
2. Press **SHF** again.
The "SHF" disappears in the display window.
(The random playback is cancelled.)

NOTE

- During random playback, if you press **◀** button, you won't go back to the previous track.

MP3 TRACK -10/+10

During playback, press the -10 button to go back to the previous 10th track, and press +10 button to go forward to the next 10th track.

Intro scan

1. Press **SCAN**. **CD** **MP3**
The "SCAN" appears in the display window.
(It is played first 10 seconds of the whole music within disc)
2. Press **SCAN** again.
The "SCAN" disappears in the display window.
(The intro scan is cancelled.)

ID 3 TAG **MP3**

When playing a disc containing information, you can see the information (ID3 TAG, Title, Artist and Album) in the display window. If there is no information "NO TEXT" will be shown in the display window.

Press twice the **DISP** button during MP3 file playback.

Troubleshooting



Symptom	Cause	Correction
Power doesn't turn on. The unit doesn't operate.	<ul style="list-style-type: none">Leads and connector are incorrectly connected.The fuse is blown.Noise and other factors are causing the built-in microprocessor to operate incorrectly.	<ul style="list-style-type: none">Confirm once more that all connections are correct.Rectify the reason for the fuse blowing, then replace the fuse. Be very sure to install the correct fuse with the same rate.Turn the unit off and then on.
Playback is not possible.	<ul style="list-style-type: none">The disc is dirty.The loaded disc is a type this unit cannot play.	<ul style="list-style-type: none">Clean disc.Check what type the disc is.
No sound are heard. The volume level will not rise.	<ul style="list-style-type: none">Cables are not connected correctly.	<ul style="list-style-type: none">Connect the cables correctly.
There's no sound.	<ul style="list-style-type: none">The volume level is low.	<ul style="list-style-type: none">Adjust the volume.
There's audio skipping.	<ul style="list-style-type: none">This unit is not firmly secured.	<ul style="list-style-type: none">Secure this unit firmly.

REFERENCE

Specifications

MP3 Disc compatibility with this unit is limited as follows:

1. Sampling Frequency / 8 - 48kHz (MP3)
2. Bit rate / within 8 - 320kbps (include VBR) (MP3)
3. CD-R/CD-RW physical format should be "ISO 9660"
4. If you record MP3 files using the software which cannot create a FILE SYSTEM, for example "Direct-CD" etc., it is impossible to playback MP3 files. We recommend that you use "Easy-CD Creator" which creates an ISO9660 file system.

Customers should also note that permission is required in order to download MP3 files and music from the Internet. Our company has no right to grant such permission. Permission should always be sought from the copyright owner.

General

Output Power50W x 4CH(Max.)
Power SourceDC 12 V
Speaker impedance4 Ω
Ground SystemNegative type
Dimensions (W x H x D)182 x 51 x 173 mm (Without Front Panel)
Net Weight (approx.)1.8 kg

FM tuner

Frequency Range87.5-107.9MHz or
87.5-108 MHz or 65-74 MHz, 87.5-108 MHz
S/N Ratio55 dB
Distortion1.0%
Usable sensitivity12 dB μ V

MW(AM) tuner

Frequency Range520-1720kHz or 522-1620 kHz
S/N Ratio45 dB
Distortion1.0%
Usable sensitivity32 dB μ V

CD

Frequency Response40 - 20000 Hz
S/N Ratio70 dB
Distortion0.15%

- Design and specifications are subject to change without notice.

P/NO : 3834RR0029K