



**LG**

Life's Good

OWNER'S MANUAL

# Video Conference System

Please read this manual carefully before operating your set and retain it for future reference.

MODEL  
RVF1000

## 1

# Safety Information



## CAUTION

**RISK OF ELECTRIC SHOCK  
DO NOT OPEN**



**CAUTION:** TO REDUCE THE RISK OF ELECTRIC SHOCK  
DO NOT REMOVE COVER (OR BACK)  
NO USER-SERVICEABLE PARTS INSIDE  
REFER SERVICING TO QUALIFIED SERVICE PERSONNEL.



This lightning flash with arrowhead symbol within an equilateral triangle is intended to alert the user to the presence of uninsulated dangerous voltage within the product's enclosure that may be of sufficient magnitude to constitute a risk of electric shock to persons.



The exclamation point within an equilateral triangle is intended to alert the user to the presence of important operating and maintenance (servicing) instructions in the literature accompanying the product.

**FCC WARNING:** This equipment may generate or use radio frequency energy. Changes or modifications to this equipment may cause harmful interference unless the modifications are expressly approved in the instruction manual. The user could lose the authority to operate this equipment if an unauthorized change or modification is made.

### REGULATORY INFORMATION: FCC Part 15

This equipment has been tested and found to comply with the limits for a Class A digital device, pursuant to Part 15 of the FCC Rules. These limits are designed to provide reasonable protection against harmful interference when the equipment is operated in a commercial environment.

This equipment generates, uses, and can radiate radio frequency energy and, if not installed and used in accordance with the instruction manual, may cause harmful interference to radio communications.

Operation of this equipment in a residential area is likely to cause harmful interference in which case the user will be required to correct the interference at his own expense.

- A suitable conduit entries, knock-outs or glands shall be provided in the cable entries of this product in the end user.
- Caution: Danger of explosion if battery is incorrectly replaced. Replaced only with the same or equivalent type recommended by the manufacturer. Dispose of used batteries according to the manufacturer's instructions.
- Holes in metal, through which insulated wires pass, shall have smooth well rounded surfaces or shall be provided with brushings.

This Class A digital apparatus complies with Canadian ICES-003.  
Cet appareil numérique de la classe A est conforme à la norme NMB-003 du Canada.

**Warning:** Do not install this equipment in a confined space such as a bookcase or similar unit.

**Warning:** Wiring methods shall be in accordance with the National Electric Code, ANSI/NFPA 70.

**Warning:** This is a class A product. In a domestic environment this product may cause radio interference in which case the user may be required to take adequate measures.

**Warning:** To reduce a risk of fire or electric shock, do not expose this product to rain or moisture.

**Caution:** This installation should be made by a qualified service person and should conform to all local codes.

**Caution:** To avoid electrical shock, do not open the cabinet. Refer servicing to qualified personnel only.

**Caution:** The apparatus should not be exposed to water (dripping or splashing) and no objects filled with liquids, such as vases, should be placed on the apparatus.

To disconnect power from mains, pull out the mains cord plug. When installing the product, ensure that the plug is easily accessible.



LG Electronics hereby declares that this/these product(s) is/are in compliance with the essential requirements and other relevant provisions of Directive 2004/108/EC, 2006/95/EC, and 2009/125/EC.

European representative :

LG Electronics Service Europe B.V. Veluwezoom 15,  
1327

AE Almere. The Netherlands  
(Tel : +31-(0)36-547-8888)

### Disposal of your old appliance



1. When this crossed-out wheeled bin symbol is attached to a product it means the product is covered by the European Directive 2002/96/EC.
  2. All electrical and electronic products should be disposed of separately from the municipal waste stream via designated collection facilities appointed by the government or the local authorities.
  3. The correct disposal of your old appliance will help prevent potential negative consequences for the environment and human health.
  4. For more detailed information about disposal of your old appliance, please contact your city office, waste disposal service or the shop where you purchased the product.
- EEE Compliance with Directive. (for Turkey only)
  - The equipment complies with requirements of the Technical Regulation, in terms of restrictions for the use of certain dangerous substances in electrical and electronic equipment. (for Ukraine only)

### Safety way to remove the battery or the battery from the equipment:

Remove the old battery or battery pack, follow the steps in reverse order than the assembly. To prevent contamination of the environment and bring on possible threat to human and animal health, the old battery or the battery put it in the appropriate container at designated collection points. Do not dispose of batteries or battery together with other waste. It is recommended that you use local, free reimbursement systems batteries and accumulators. The battery shall not be exposed to excessive heat such as sunshine, fire or the lile.

### Disposal of waste batteries/accumulators



1. When this crossed-out wheeled bin symbol is attached to batteries/accumulators of Your product it means they are covered by European Directive 2006/66/EC.
2. This symbol may be combined with chemical symbols for mercury(Hg), cadmium(Cd) or lead(Pb) if the battery Contains more that 0.0005% of mercury, 0.002% of cadmium or 0.004% of lead.
3. All batteries/accumulators should be disposed separately from the municipal waste stream via designated collection facilities appointed by the government or the local authorities.
4. The correct disposal of Your old batteries/accumulators will help to prevent potential negative consequences for the environment, animal and human health.
5. For more detailed information about disposal of Your old batteries/accumulators, please contact Your city office, waste disposal service or the shop where You purchased the product.

## IMPORTANT SAFETY INSTRUCTIONS

1. Read these instructions.
2. Keep these instructions.
3. Heed all warnings.
4. Follow all instructions.
5. Do not use this apparatus near water.
6. Clean only with dry cloth.
7. Do not block any ventilation openings. Install in accordance with the manufacturer's instructions.
8. Do not install near any heat sources such as radiators, heat registers, stoves, or other apparatus (including amplifiers) that produce heat.
9. Do not defeat the safety purpose of the polarized or grounding-type plug. A polarized plug has two blades with one wider than the other. A grounding type plug has two blades and a third grounding prong. The wide blade or the third prong are provided for your safety. If the provided plug does not fit into your outlet, consult an electrician for replacement of the obsolete outlet.
10. Protect the power cord from being walked on or pinched particularly at plugs, convenience receptacles, and the point where they exit from the apparatus.
11. Only use attachments/accessories specified by the manufacturer.
12. Use only with the cart, stand, tripod, bracket, or table specified by the manufacturer, or sold with the apparatus. When a cart is used, use caution when moving the cart/apparatus combination to avoid injury from tip-over.



13. Unplug this apparatus during lightning storms or when unused for long periods of time.
14. Refer all servicing to qualified service personnel. Servicing is required when the apparatus has been damaged in any way, such as power-supply cord or plug is damaged, liquid has been spilled or objects have fallen into the apparatus, the apparatus has been exposed to rain or moisture, does not operate normally, or has been dropped.

## Safety Warnings and Cautions

The following are warnings and cautions for the safety of the users and for the prevention of any property damage. Please read the following carefully.

### WARNING

- Turn off the system before installation. Do not plug in several electric devices to the same outlet.
  - This may cause over heating, fire, or electric shock.
- Do not place any liquid container on the system, such as water, coffee, or other beverage.
  - If liquid is poured into the system, it can cause a system breakdown or fire.
- Prevent the power cable from being severely bent or having pressure exerted on it by a heavy object.
  - This may cause fire.
- Dust around the system on a regular basis. When cleaning the system, always use a dry cloth. Do not use a wet cloth or other organic solvents.
  - This may damage the surface of the system and can cause a system breakdown or electric shock.
- Avoid placing the system near moisture, dust, or soot.
  - This can cause fire or electric shock.
- When pulling the power cable from the plug, do so gently. Do not touch the plug with wet hands and avoid using the plug if the holes in the outlet are too loose.
  - This may cause fire or electric shock.
- Do not attempt to disassemble, repair, or modify the system on your own. It is extremely dangerous due to the high voltage running through the system.
  - This may cause fire, electric shock, or serious injury.
- Check for any danger signs such as a wet floor, a loosened or damaged power cable, or an unstable surface. If you encounter any problems, ask your dealer for assistance.
  - This may cause fire or electric shock.
- Keep at least 15 cm between the back of the system and the wall for the cables connected to the system, otherwise they may be bent, damaged, or cut.
  - This may cause fire, electric shock, or injury.
- Install the system in a cool place without direct sunlight and always maintain room temperature. Avoid candlelight and heat generating devices such as heaters. Keep the system away from places where many people pass.
  - This may cause fire.
- Install the system on a plain surface with sufficient air ventilation. Do not place the system on an elevated surface.
  - This may cause system breakdown or serious injury.
- The power outlet must be placed on the ground, and the voltage range must be within 10 % of the voltage rate. Do not use the same outlet with a hair dryer, iron, refrigerator, or any heating appliances.
  - This may cause fire, over heating or electric shock.

## CAUTION

Please beware of the following precautions before installing the VCS.

- Avoid positioning the product in any place where the unit may come into contact with moisture, dust, or soot.
- Avoid placing in direct sunlight or near heating appliances.
- Keep the product away from electric sparks or magnetic substances.
- Avoid temperature extremes. (Recommended operating temperature is between 0 °C and 40 °C)
- Do not place any conductive material through the ventilation grills.
- Keep the system turned off before installation.
- Ensure enough space is left for cable connections.
- Place the system on a solid surface with sufficient air ventilation. Avoid any surface that vibrates.
- Placing the system near electronic devices such as a radio may cause the product to breakdown.
- Do not disassemble the product without seeking assistance from LG Electronics.
- Do not place any heavy object on the system.
- Prevent any substances from being inserted into the system.
  - This may cause system breakdown.
- Install the system in a place with sufficient air ventilation.
  - Keep at least 15 cm between the back of the system and the wall.
- Do not install the system in a place with high magnetic, electric wave, or wireless devices such as a radio.
  - Do not install the system in a place with magnetic objects, electric frequencies, or vibration.
- Do not place any heavy object on the system.
  - This may cause system breakdown.
- Install the system on a stable, level surface.
  - The system may not operate properly.
- Install the system in a place with appropriate moisture and temperature levels.
  - Avoid installing the system in a place with high (over 40 °C) or low (under 0 °C) temperature.
- The system can be damaged from a strong impact or vibration. Avoid throwing objects within the vicinity of the system.
- Avoid direct sunlight or any heating appliances.
  - Recommended operating temperature is over 0 °C (32 °F).
- Ventilate the air inside the system operation room, and tighten the system cover firmly.
  - System breakdown may be caused by an inappropriate environment. It is recommended to use AVR (Automatic Voltage Regulator) for a stable power supply. It is recommended to coil the core-ferrite around the connector of the system to avoid electromagnetic interference.
- The outlet must be placed on the ground.
- If there is strange sound or smell, unplug the power cable immediately and contact the service center.
  - This may cause fire or electric shock.
- In order to maintain stable system performance, have your system checked regularly by the service center.
  - LG Electronics is not held responsible for system breakdown caused by user mishandling.
  - There is a risk of explosion if a battery is replaced by an incorrect type. Dispose of used batteries according to the instructions.
- Do not overturn the product during use.

# Contents

## 1

### Safety Information

---

- 3 IMPORTANT SAFETY INSTRUCTIONS
- 4 Safety Warnings and Cautions

## 2

### Preparation

---

- 8 Introduction
  - 8 What is the VCS System?
  - 8 Features
  - 9 Unpacking
- 10 Codec Unit Overview
- 11 HD Camera Overview
- 12 Remote Control
  - 12 Battery Installation

## 3

### Installation

---

- 13 Connections
  - 13 Precautions
  - 13 Connection Overview
  - 14 HDMI Connection
  - 15 HD Camera Connection
  - 16 PC Connection
  - 17 Connecting to a Network
  - 18 Connecting a Headphone
  - 18 Connecting a Microphone
  - 19 Connecting Power
  - 19 System Connection Check
- 20 Initial Settings
- 23 Main Screen Overview
- 24 System Configuration Menu
- 25 User Settings
  - 25 General
  - 26 Audio
  - 27 Video
  - 28 Date Time
- 29 Admin Settings
  - 29 Call Settings
  - 33 Network Settings
  - 37 System Settings

- 38 System Information
- 38     System Status
- 38     Audio/Video
- 39     Network Utility
- 39     Server Status

## 4 Operation

---

- 40 Before Using the System
- 40 Placing a Call
  - 40     Placing a Call Manually
  - 41     Placing a Call from the Call History
  - 41     Placing a Call from the Directory
  - 42     Placing a Call using the Speed Dial
- 42 Answering or Rejecting a Call
- 42 Managing a Call
  - 42     Ending a Call
  - 42     Hiding or Showing User Interface Elements
  - 42     Managing Audio
  - 43     Managing Video Layout
  - 43     Sharing Content
  - 43     Viewing Call Information
  - 44     Get the Snapshot
- 44 Managing the Directory
  - 44     Adding an Entry to the Directory
  - 45     Editing or Deleting an Entry from the Directory
  - 46     Copying an Entry from the Call History
  - 46     Copying an Entry from the Corporate Contact
  - 46     Deleting an Entry from the Call History
  - 47     Sorting and Searching
  - 47     Placing a Call when the Device is Registered in Gatekeeper Server
  - 47     Making a Call when the Device is Registered in SIP Server
  - 47     Using Far End Camera Control
  - 47     Using Far End Camera Preset
  - 48     Using SnapShot
- 48 Using the Web Service
  - 48     Upgrading your System Software
  - 49     Uploading the Certification File
  - 49     Importing or Exporting the Address Book

## 5 Appendix

---

- 50 Troubleshooting
- 52 Open Source Software Notice
- 53 Specifications

# 2 Preparation

## Introduction

### What is the VCS System?

The LG video conference system is designed to be used for video conferencing that enables people in different places to have a meeting by seeing, listening and speaking to each other on a screen.

Through this device, not only can executives or managers have a meeting and communicate with customers, subcontractors and coworkers in real time but decisions can be made and information can be exchanged virtually and immediately, saving travel time, cost and energy.

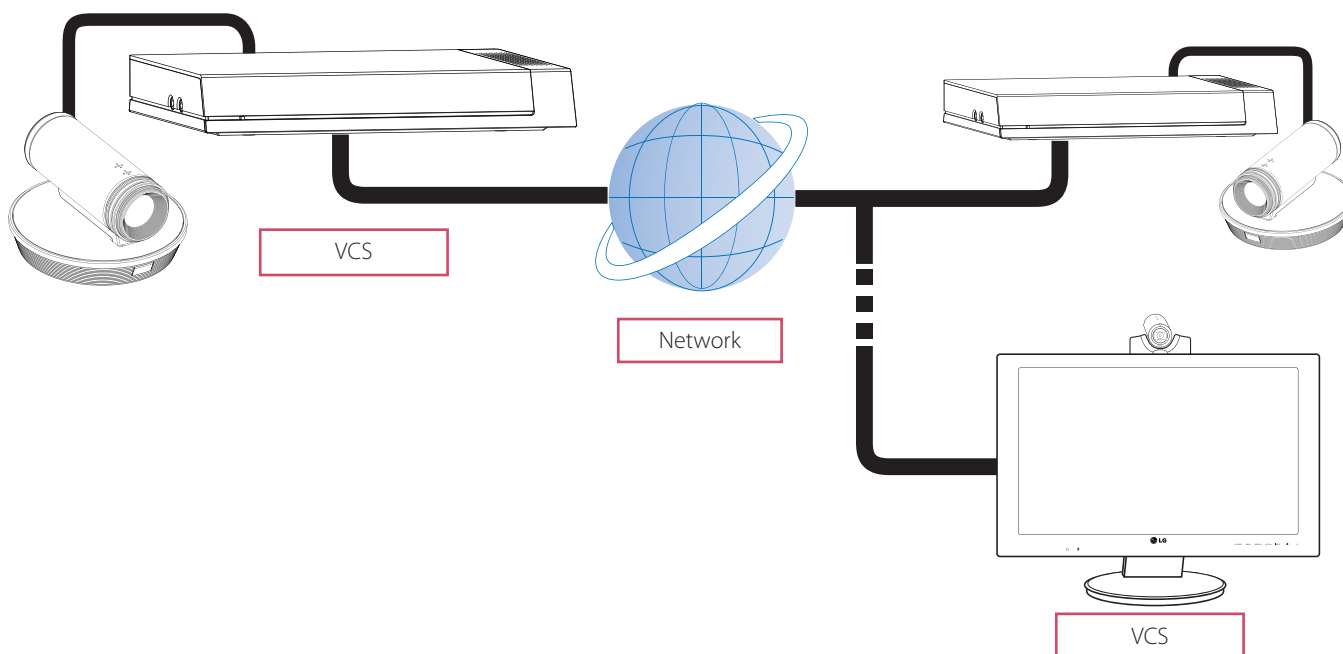

### Features

- Convenient and easy graphical user interface
- H.323 / SIP network International Standard codec
- HD video quality – 1 280 X 720 (30 fps)
- Editable screen layouts
- Graphic presentation using Content Sharing Technology (Share Document/Audio/Video)
- Administrator password and H235 codec (Advanced Encryption Standard) for security
- One-touch call connecting using speed dial
- Create graphical directory using snapshot and groups can be specified
- Easy phonebook search function
- 720p high-definition camera
- Natural sounding conversation using full duplex mode
- Built-in speaker
- Electret Condenser Microphone



## Unpacking

Check your product box for the following items. If there are any missing accessories, contact the local dealer where you purchased your product. The illustrations in this manual may differ from the actual product and item.

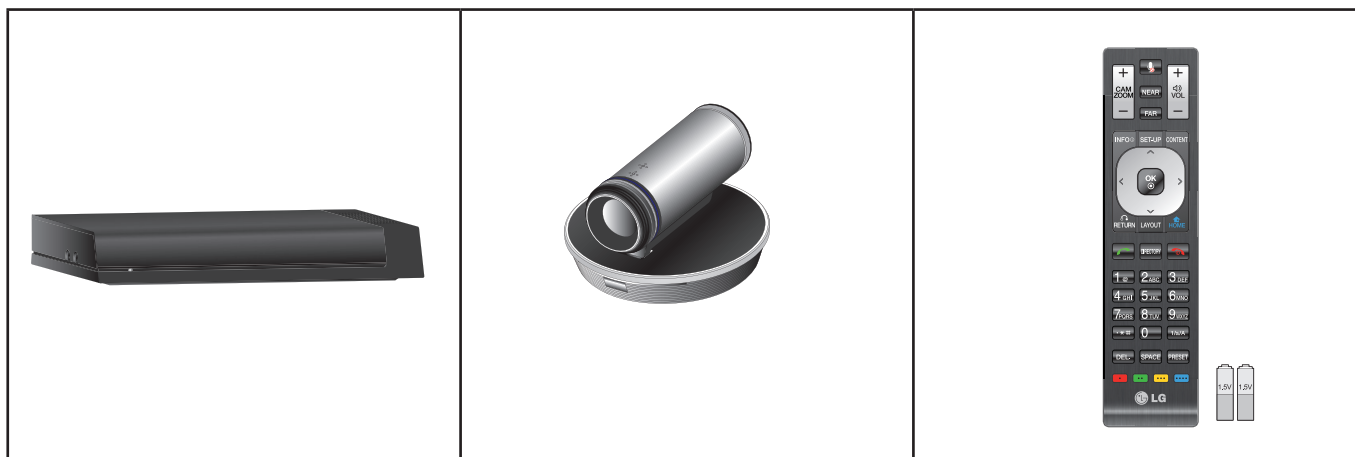

Codec Unit

HD Camera

Remote Control and Batteries

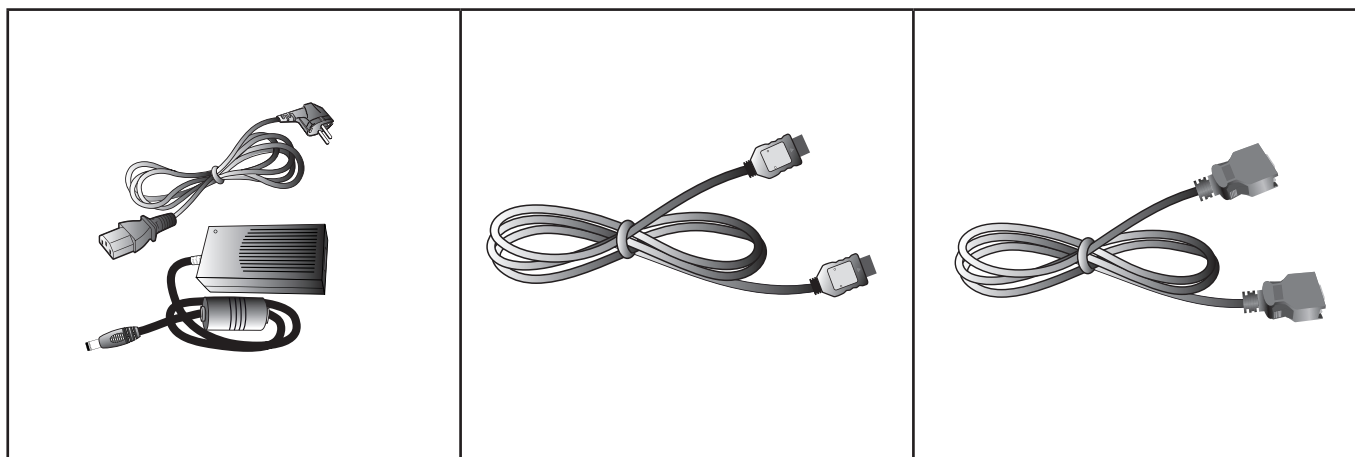

Power Adapter

HDMI Cable

Camera Connection Cable

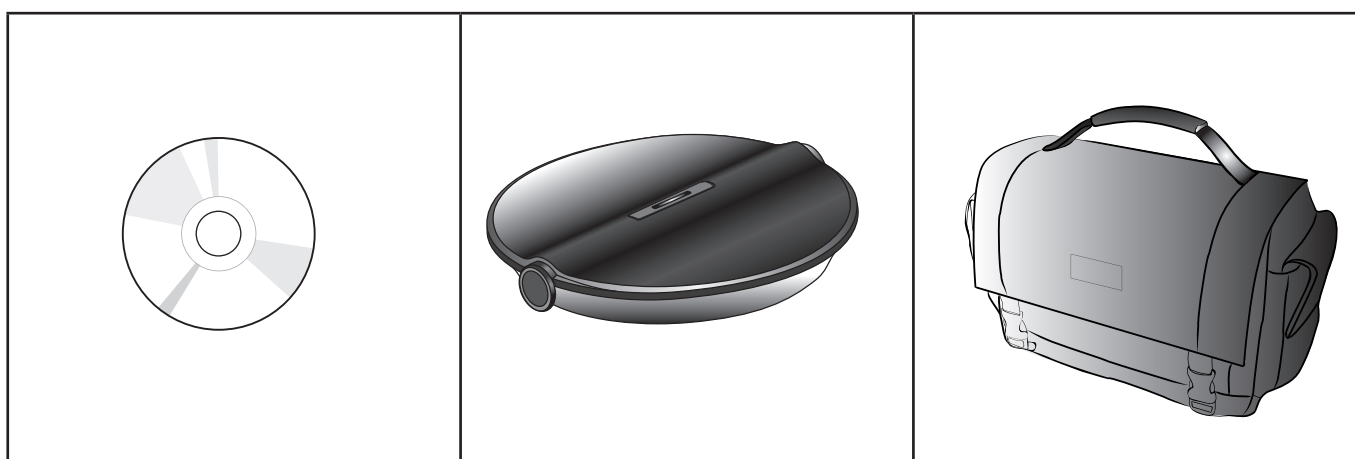

Owner's Manual CD

MicPod

Carrying Case

## Codec Unit Overview

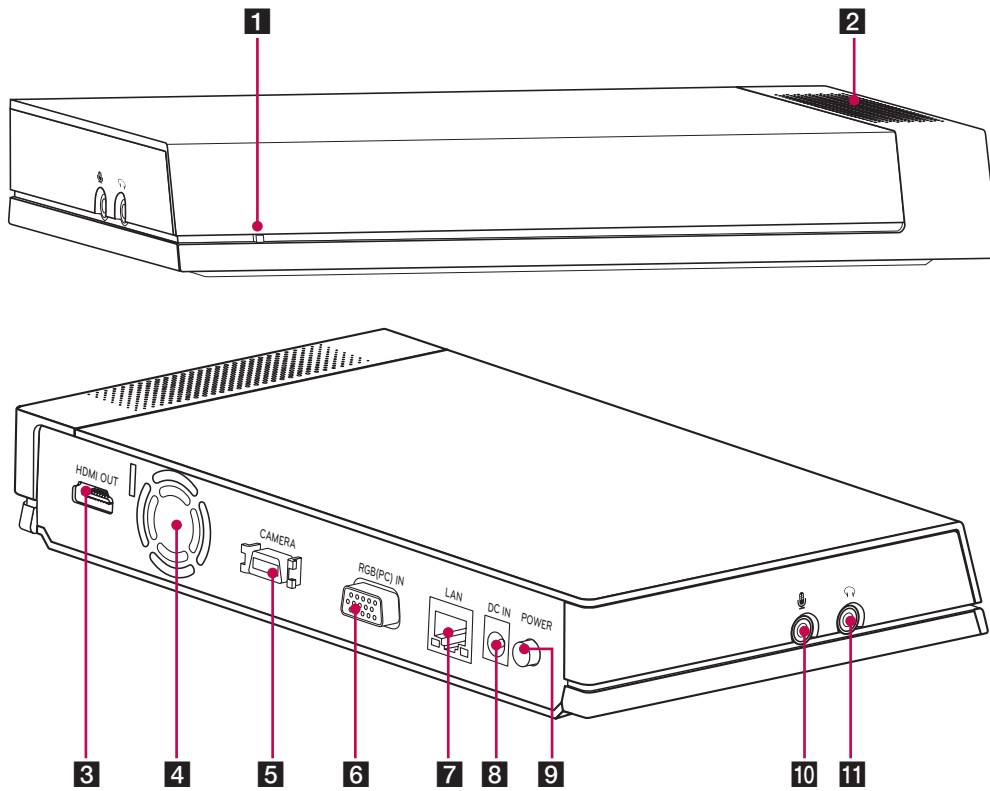

- 1** Power indicator: Lights when the unit turns on.
- 2** Built-in speaker.
- 3** HDMI port: Connects the VCS and the display device with an HDMI cable.
- 4** Cooling fan.
- 5** Camera connection port: Connects the HD camera.
- 6** RGB(PC) IN port: Connects the PC with a D-sub cable for presentation.
- 7** LAN port: Connects to a network via a hub with RJ-45 connector.
- 8** Power input jack: Connects to a DC 12 V power supply using proper cables.
- 9** Power button: Turns the unit on or off. You must turn the unit on using the Power button after connecting the power cable. You can use this button to reset the system.
- 10** MIC jack: Connects a microphone.
- 11** AUDIO jack: Connects a headphone.

## HD Camera Overview

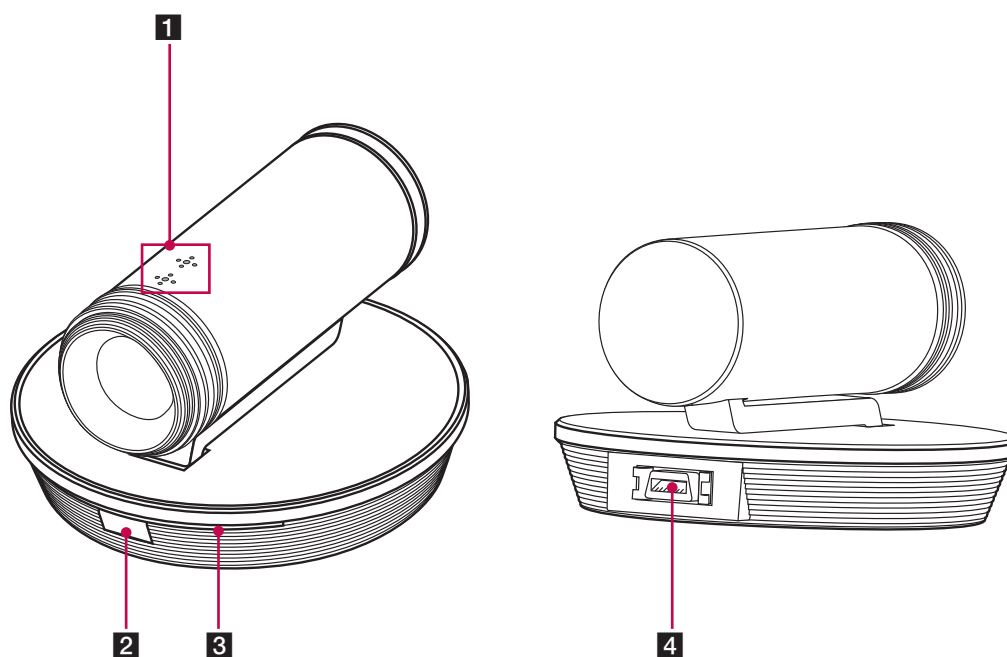

- 1** Internal microphone
- 2** Remote sensor: Point the remote control here.
- 3** Camera activation indicator: Lights when the camera is connected to the codec unit and activates correctly.
- 4** CAMERA IN port: Connects the codec unit and the HD camera with the supplied camera connection cable.

## Remote Control

This remote control provides wireless control of all video conference system functions and enables you to navigate the user interface, place and receive calls and control the far end of the camera connected to the system.



Button	Description
	Use this button to zoom in or zoom out of the far end camera.
	Use this button to mute microphones of the near end system.
	Displays the system or call information.
	Use this button to select the video input source (camera or PC) of the near camera.
	Use this button to return to the previous condition.
	Use this button to return to the main screen.
	Displays the directory menu.
	Use these buttons to input text or numbers. <ul style="list-style-type: none"> <li>1/a/A: Change the input type among the number, lower case and upper case.</li> <li>DEL.: Delete a character before the cursor position.</li> <li>SPACE: Insert a space at the cursor position.</li> </ul>

Button	Description
	Use this button to adjust the volume of the system in a call.
	Use this button to select the near or far end camera.
	Displays the system setup menu.
	<ul style="list-style-type: none"> <li>Arrow buttons: Navigate the menu options. Use this button to Pan/Tilt control for far end camera.</li> <li>OK: Confirms menu selections.</li> </ul>
	Use this button to change the screen layout.
	Use this button when the system receives a call or manually make a call.
	Use this button when you want to hang up the call.
	Use this button to set the far end camera preset.
	Function buttons. Each button function changes as the condition of the menu and system operation refers to the each screen for more details.

### Battery Installation

Open the battery cover, replace batteries (1.5 V AAA) matching ⊕ and ⊖ ends to the label inside the compartment and then close the battery cover.



#### CAUTION

Do not mix old and new batteries as this may damage the remote control.

# 3 Installation

## Connections

### Precautions

Before setting up the this system, ensure that the monitor, the computer system and other attached devices are turned off.

### Connection Overview

The illustration below shows the connections of the system. For specific information of each connection, refer to the next pages.

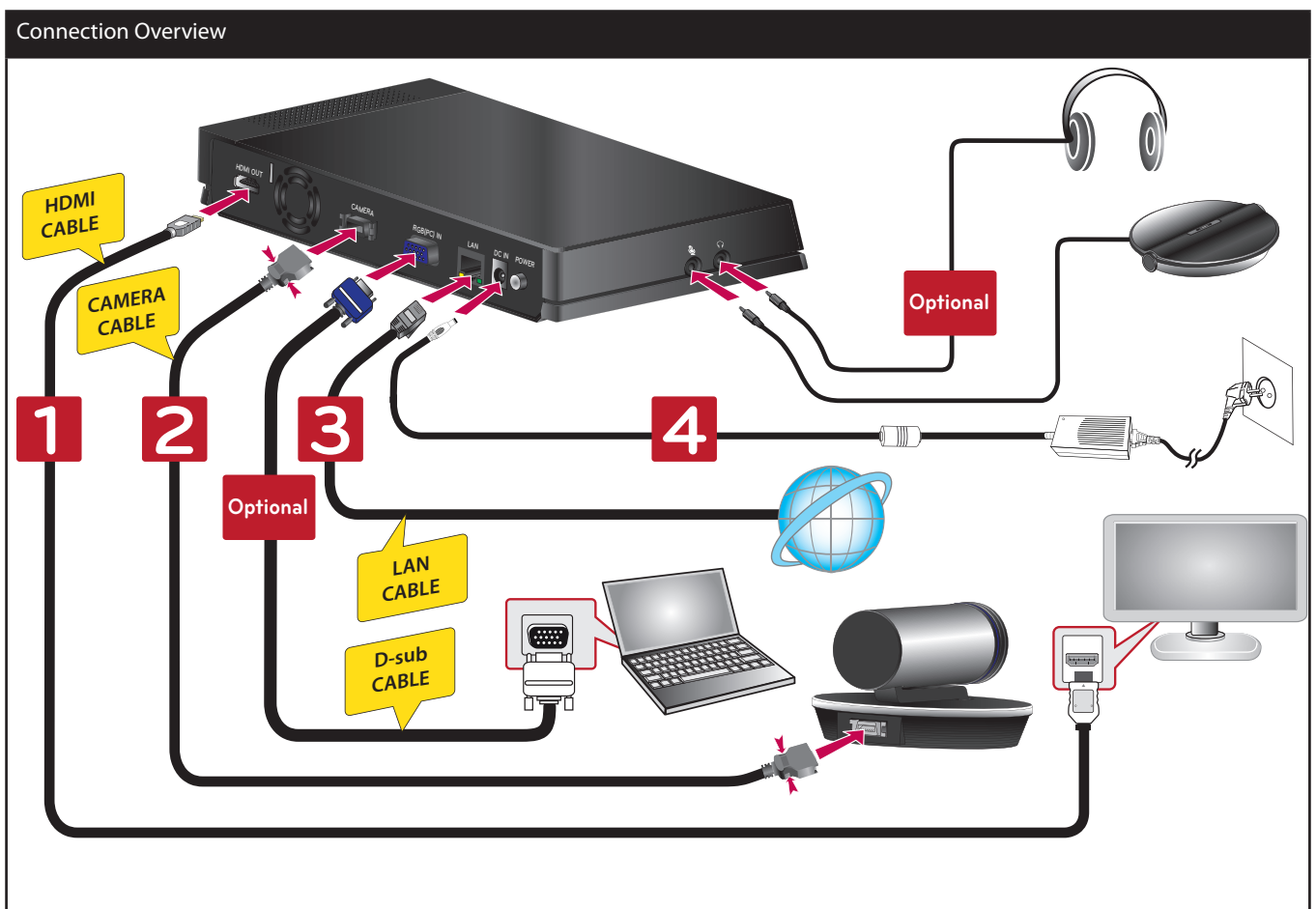

## HDMI Connection

Transmits the digital video and audio signals from the system to your monitor with the HDMI cable as shown in the following illustrations.

HDMI Cable Connection

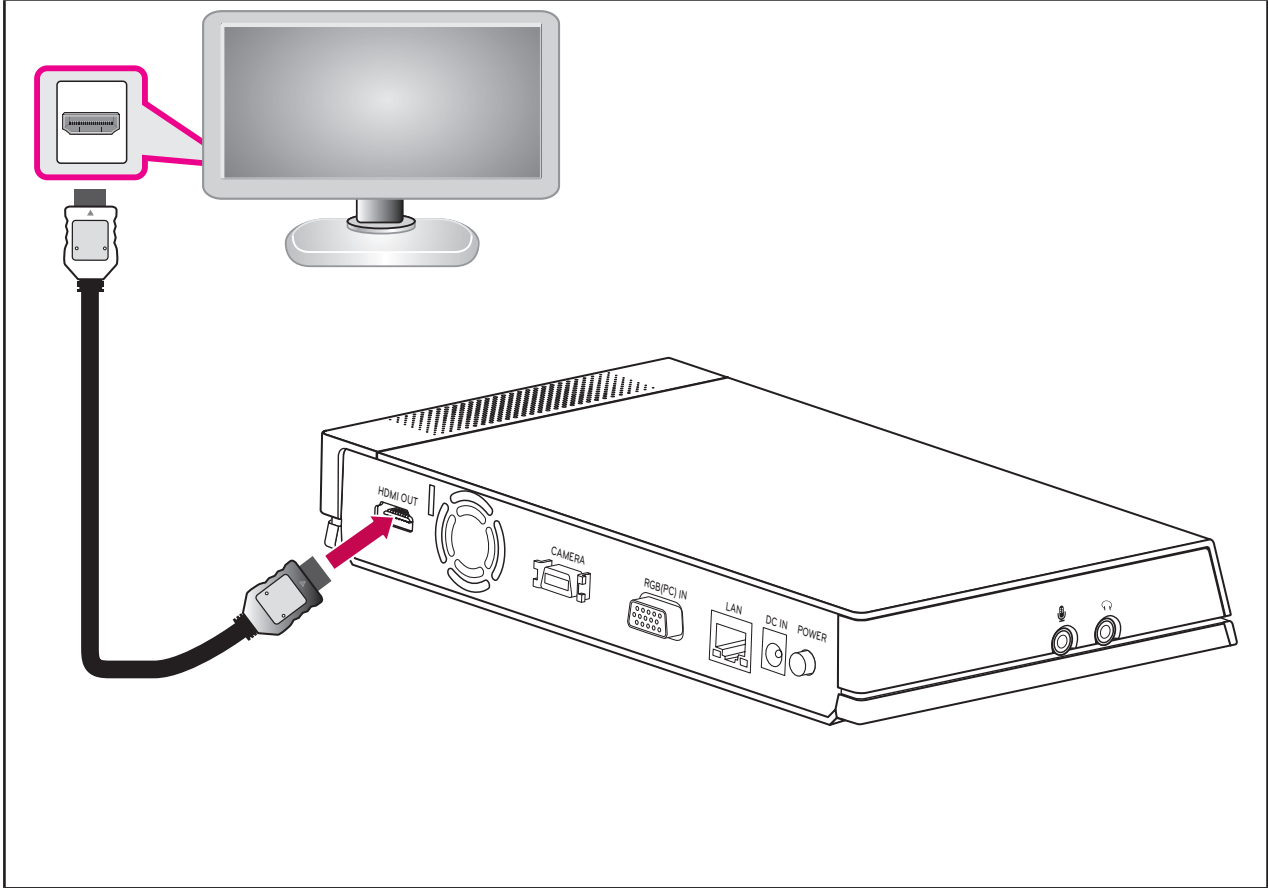

### ! NOTE

- It is recommended to use the monitor with the 1280X720 mode for the best image quality.
- If you connect the codec unit to the HDMI TV and use the speaker of the TV, the distance between the camera and the TV should be more than 1 meter.
- The recommended distance between the camera and the user is about 1 m to 2 m.
- If you connect the Codec unit to the DVI port of monitor (TV) using HDMI to DVI converter, you should hear the audio through built-in speaker or headphone because DVI does not support audio interface. Please go to Setup > User > Audio > Audio Out and change Audio Out to "Built-In Speaker" or "Headset Out".
- If you use the HDMI TV or monitor as a audio output and want to get the high-quality sound, you should run the Audio Out Test for HDMI at the [System Info > Audio/Video] menu.

## HD Camera Connection

Connect the HD camera to the camera jack of the codec unit with the supplied camera connection cable as shown in the following illustrations.

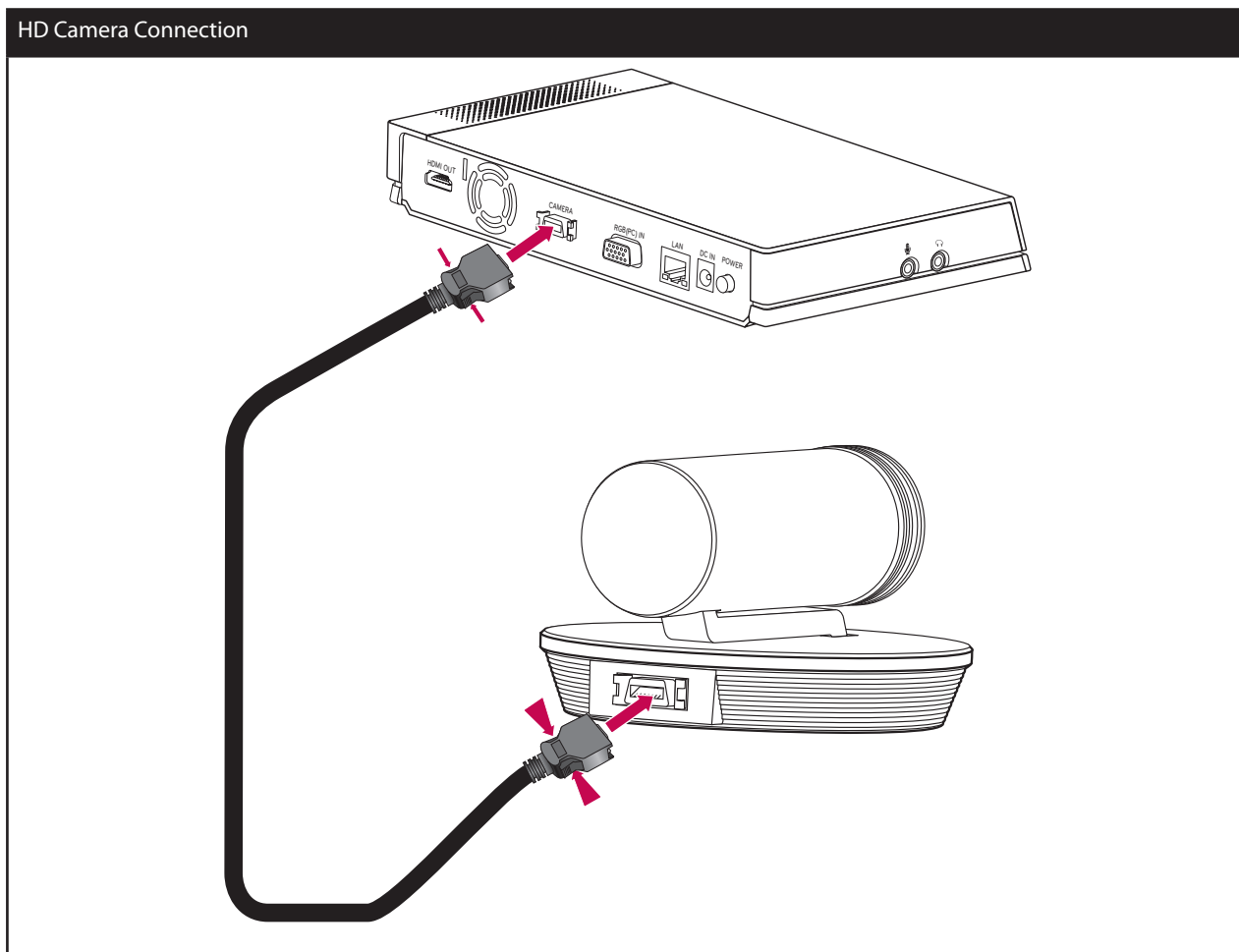

### NOTE

- After connection is completed, adjust the angle of the camera to suit your view.
- If you use the built-in speaker of the codec unit, the distance between the camera and the codec unit should be more than 1 meter.
- The recommended distance between the camera and the user is about 1 m to 2 m.

## PC Connection

Transmits an analog video signal from your PC to codec unit. Connect the PC and the codec unit with the optional D-sub 15-pin signal cable as shown in the following illustrations. You can give a presentation to the far-end user with this connection.

PC Connection

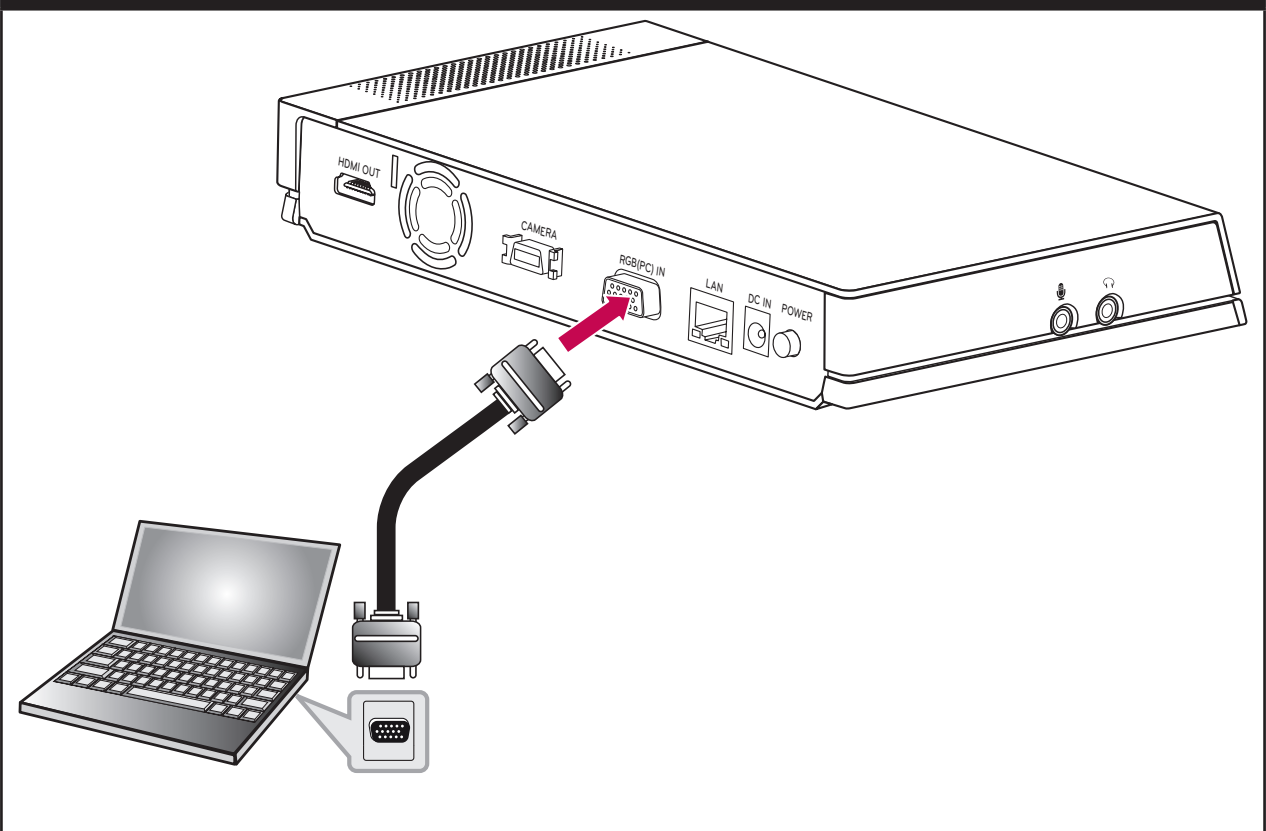



## Connecting to a Network

Connect the codec unit's LAN port to the corresponding port on your router or network using the optional LAN or Ethernet cable with RJ-45 connector.

### Network Connection

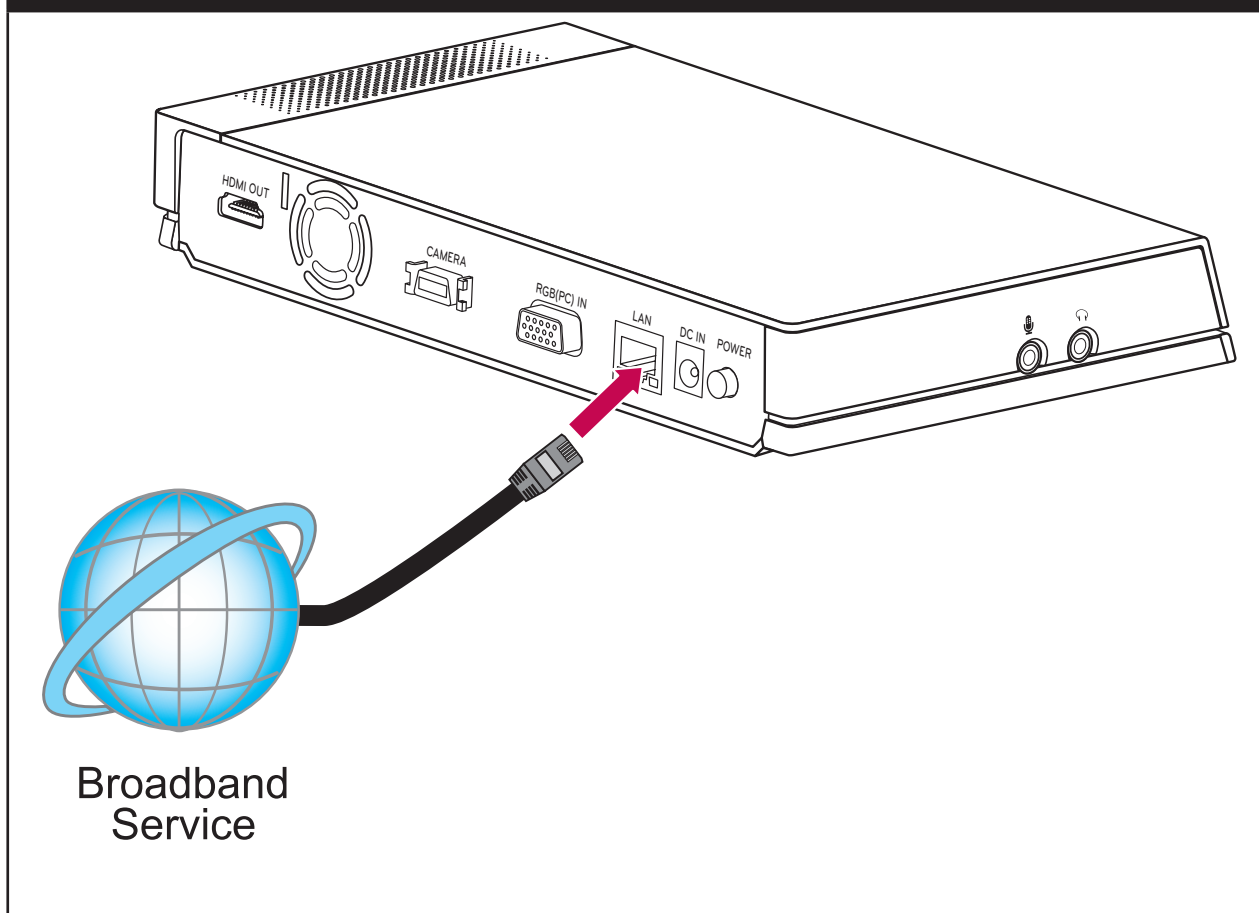

### ! NOTE

When plugging or unplugging the LAN cable, hold the plug portion of the cable. When unplugging, you should hold the lock of the plug portion.

## Connecting a Headphone

Connect a headphone cable to the headphone port of the codec unit as shown in the following illustrations.

Headphone Connection

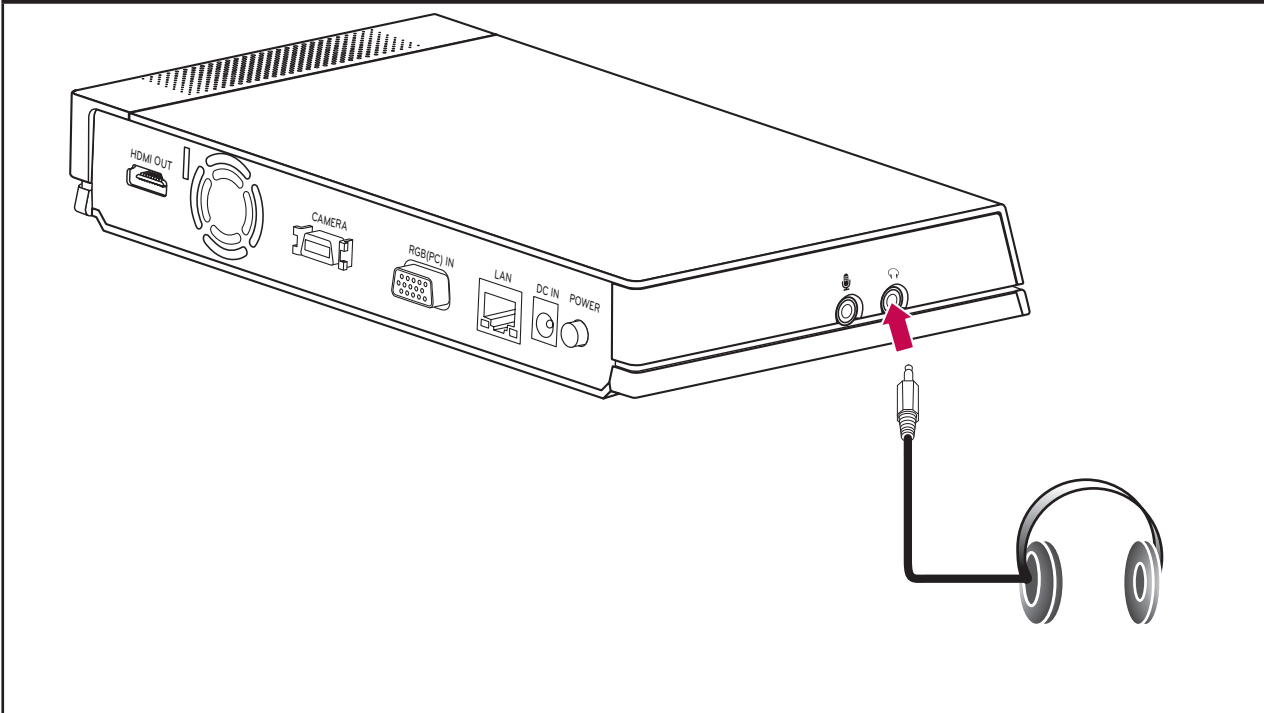

## Connecting a Microphone

Connect a microphone to the MIC port of the codec unit as shown in the following illustrations.

Microphone Connection

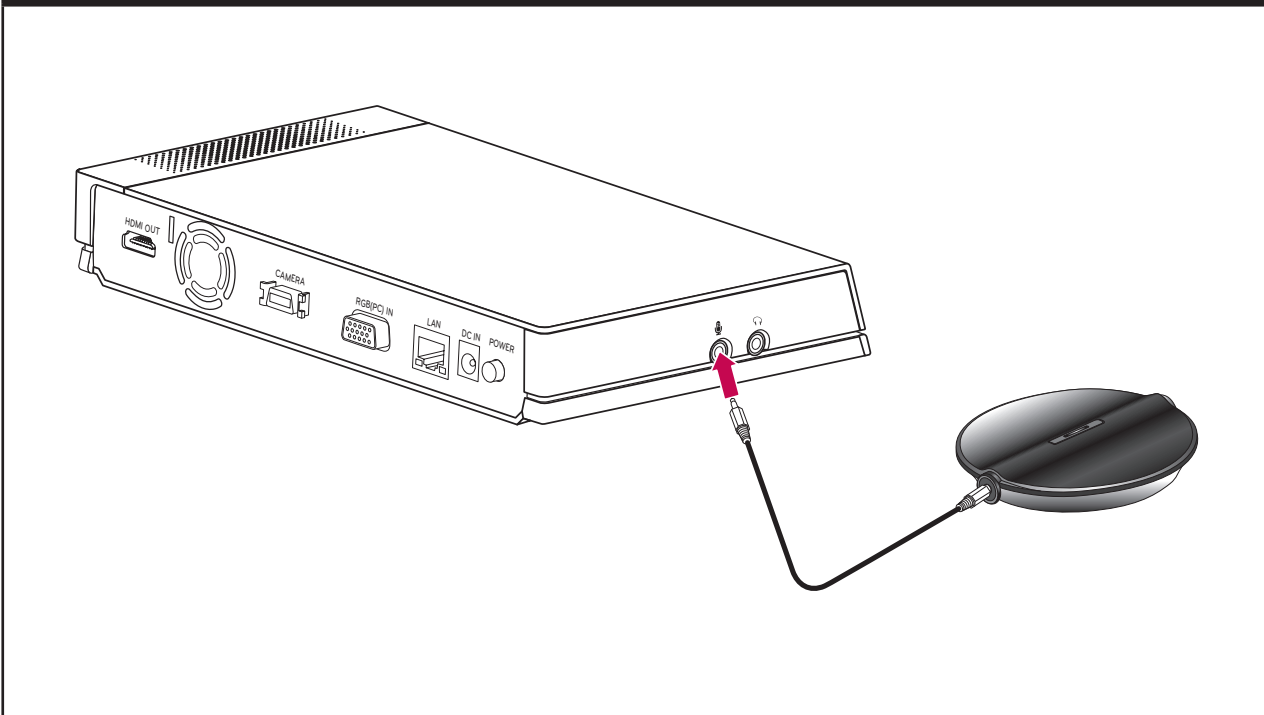

### NOTE

The recommended distance between the microphone and the user is about 1 m to 2 m.

## Connecting Power

Connect the power cable as shown in the following illustrations.

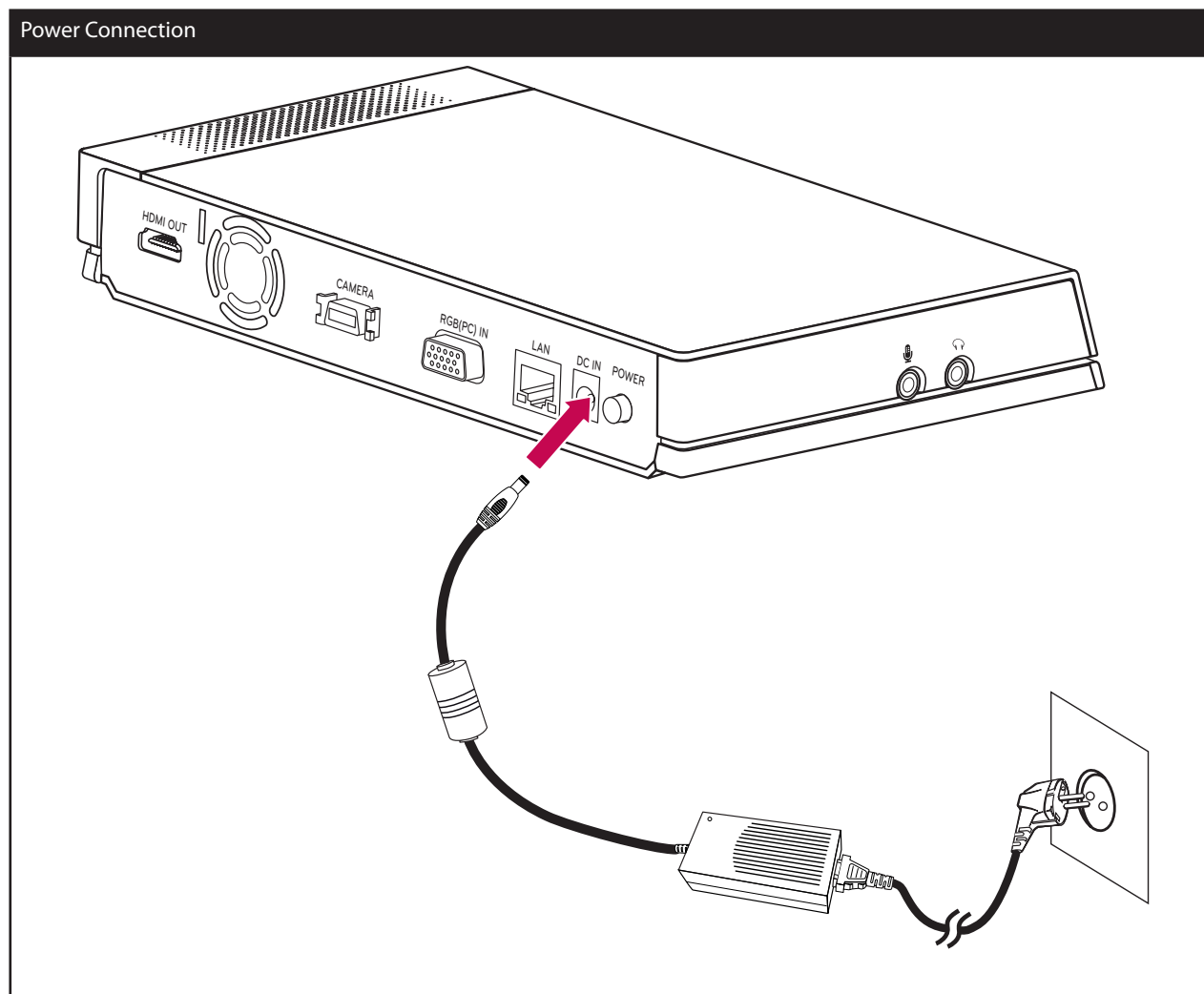

### CAUTION

You must use a supported adapter. If you connect another adapter not offered with the system, you may cause a malfunction, failure or fire.

## System Connection Check

After all of the connections are completed, follow the steps below to check the system operation.

1. Turn on the monitor.
2. Press POWER on the rear of the codec unit.  
System booting will commence. When the booting is completed, the initial configuration menu will be displayed.  
If it is not displayed, check the device connections and make sure the connections are correctly set.  
Now, you can use the system. Do the next configuration.



### NOTE

Video out of the system is 720p by default. If the monitor (TV) does not support 720p, press the blue  button 5 times. The system reboots automatically in 480p.

## Initial Settings

When you access the VCS for the first time, the initial setting screen appears. Select a language and customize the basic settings.

1. Insert two AAA batteries matching ⊕ and ⊖ correctly into the remote controller.
2. Turn on the unit. System booting will commence. The logo image will be displayed during the system booting.
3. When the booting is complete the initial configuration menu will be displayed.
4. Select the language for the text displayed on the screen.

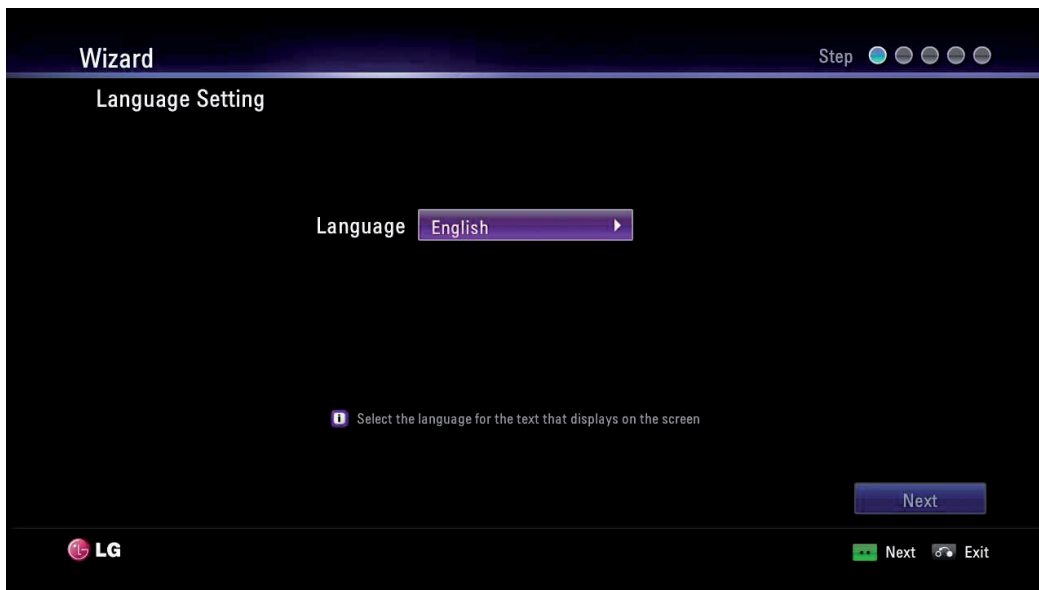

- 4-1. Press **OK** or **[>]**. The language list is displayed.
- 4-2. Select the language using **[^]** or **[v]** and press **OK**.
- 4-3. Select [Next] and press **OK** to go to the next step or press **[••]**.
5. Select the wizard option.

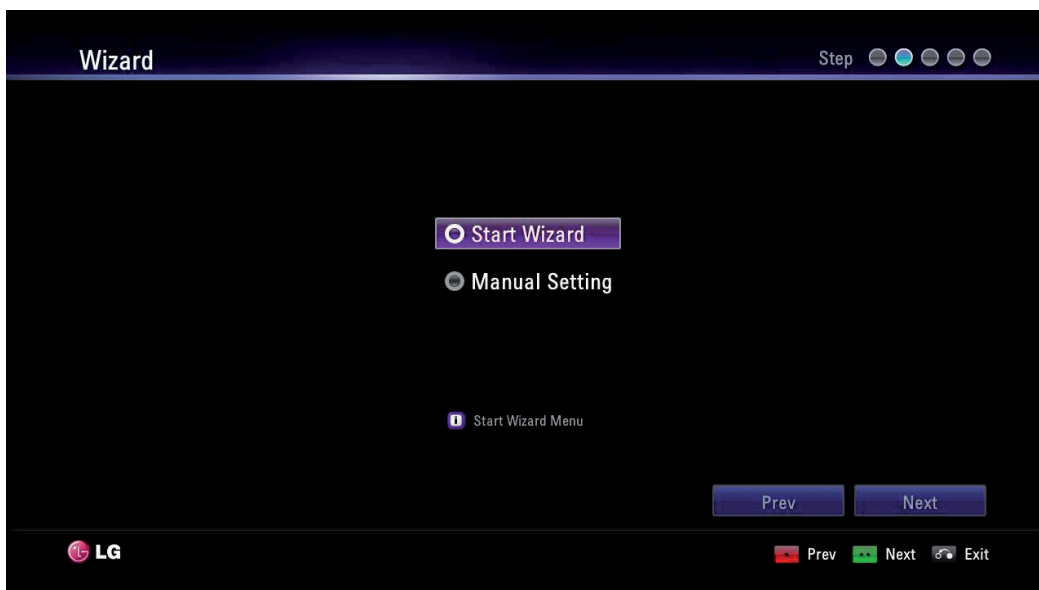

5-1. Select one of the below options.

- Start Wizard: Select this option when you want to set the configuration with wizard. If you select this option, follow next steps.



**NOTE**

It is recommended that you use the Start Wizard option rather than the Manual Setting option.

- Manual Setting: Skip the wizard configuration and display the main setup window. You can set the system configuration manually.



**NOTE**

If you setup incorrectly in Manual Setting, you may not be able to connect to calls.

5-2. Select [Next] and press **OK** to go to the next step or press .

6. Select the time zone.

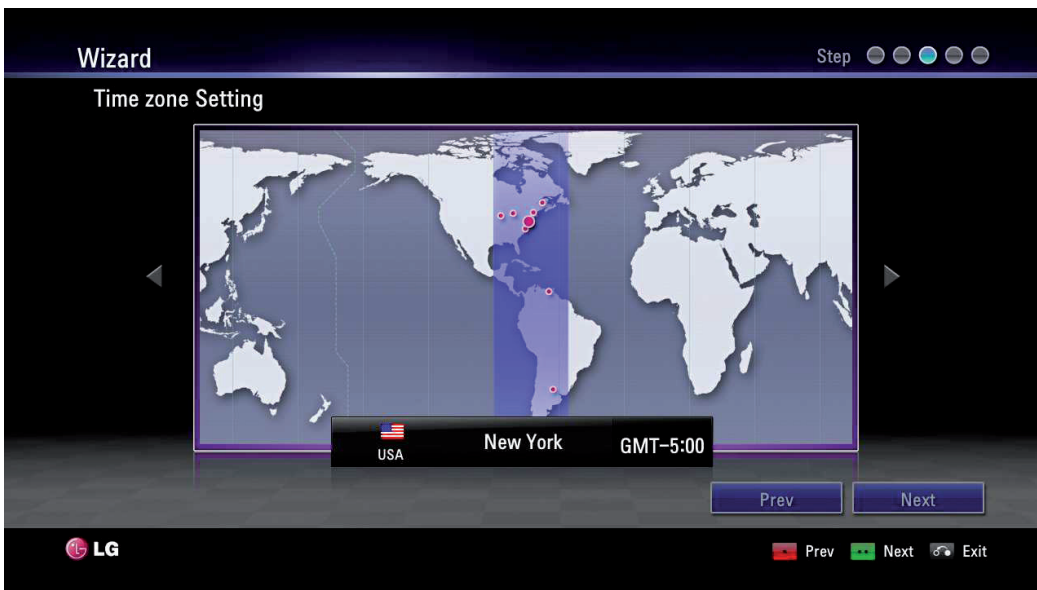

6-1. Use  or  to select the time zone and press **OK**.



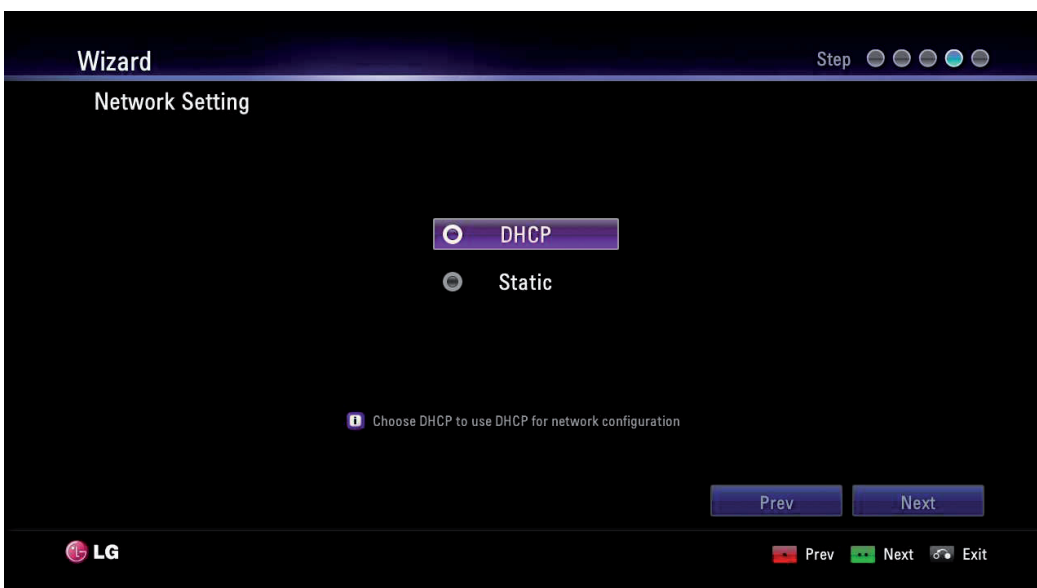

6-2. Use  or  to select the country where the device is located and press **OK**.

6-3. Select [Next] and press **OK** to go to the next step or press .

7. Select the one of the network setting options.



- DHCP: Select this option when a DHCP server is installed on the network to allow IP address assignment. With this setting, the IP address is assigned automatically.

- 7-1. Select this option and press . The IP address information window is displayed.
- 7-2. Select [Next] and press **OK** to go to the next step or press .
- Static: Select this option when you set the network configuration manually.
  - 7-1. Select this option and press .
  - 7-2. Set the below options.
    - IP Address: Enter the static IP address of the device.
    - Subnet Mask: Enter the subnet mask IP address.
    - Gateway: Enter the gateway IP address.
    - DNS Server: Enter the IP address to configure DNS servers.
  - 7-3. Select [Next] and press **OK** to go to the next step or press .
- 8. Enter a descriptive name for the system.

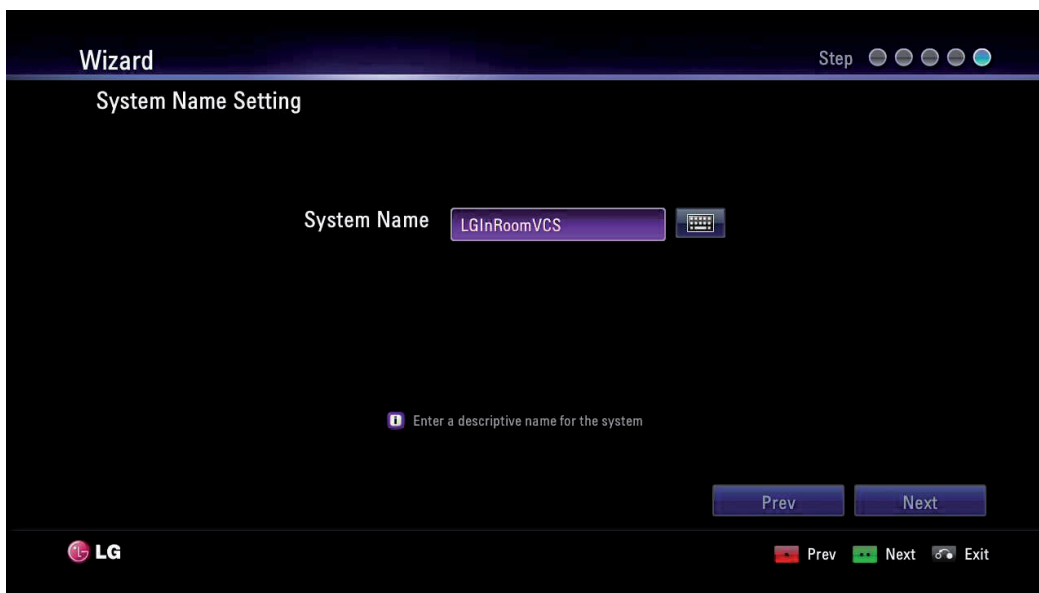

#### When using the remote control

- 8-1. Press **OK** to edit the system name.
- 8-2. Enter the system name using the Remote control buttons and press **OK** to confirm it.
  - DEL.: Deletes the previous character at the cursor position.
  - SPACE: Inserts space at the cursor position.
  - 1/a/A: Changes the input type to numbers, small letters or capital letters.
  - Numbers/[.\*#]: Select the numbers, small letters or capital letters as selected input type. Press the button repeatedly to select the character or symbol as you want.
- 8-3. Select [Next] and press **OK** to go to the next step or press .

#### When using the virtual keyboard.

- 8-1. Select the virtual keyboard icon and press **OK**. The virtual keyboard input menu displayed.
- 8-2. Use the arrow buttons to select a letter and **OK** to confirm your selection.
  - ◀: Moves cursor to left.
  - ▶: Moves cursor to right.
  - Clear: Deletes the previous character at the cursor position.
  - Clear All: Clear all the entered characters, numbers and symbols.
  - Space: Inserts space at the cursor position.
  - a/A/?!: Changes the virtual keyboard settings to small letters, capital letters or symbols.
  - OK: Confirm and exit the menu.
  - Cancel: Returns to the previous screen.
- 8-3. Select [Next] and press **OK** to go to the next step or press .
- 9. The Wizard finish message is displayed, press **OK** to start VCS. The VCS main screen will be displayed.

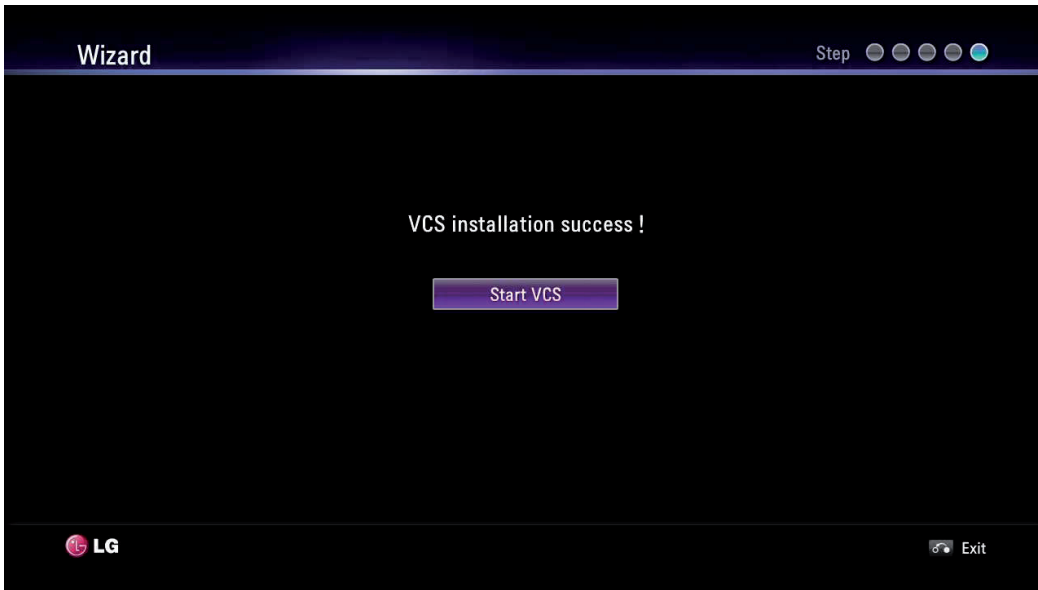







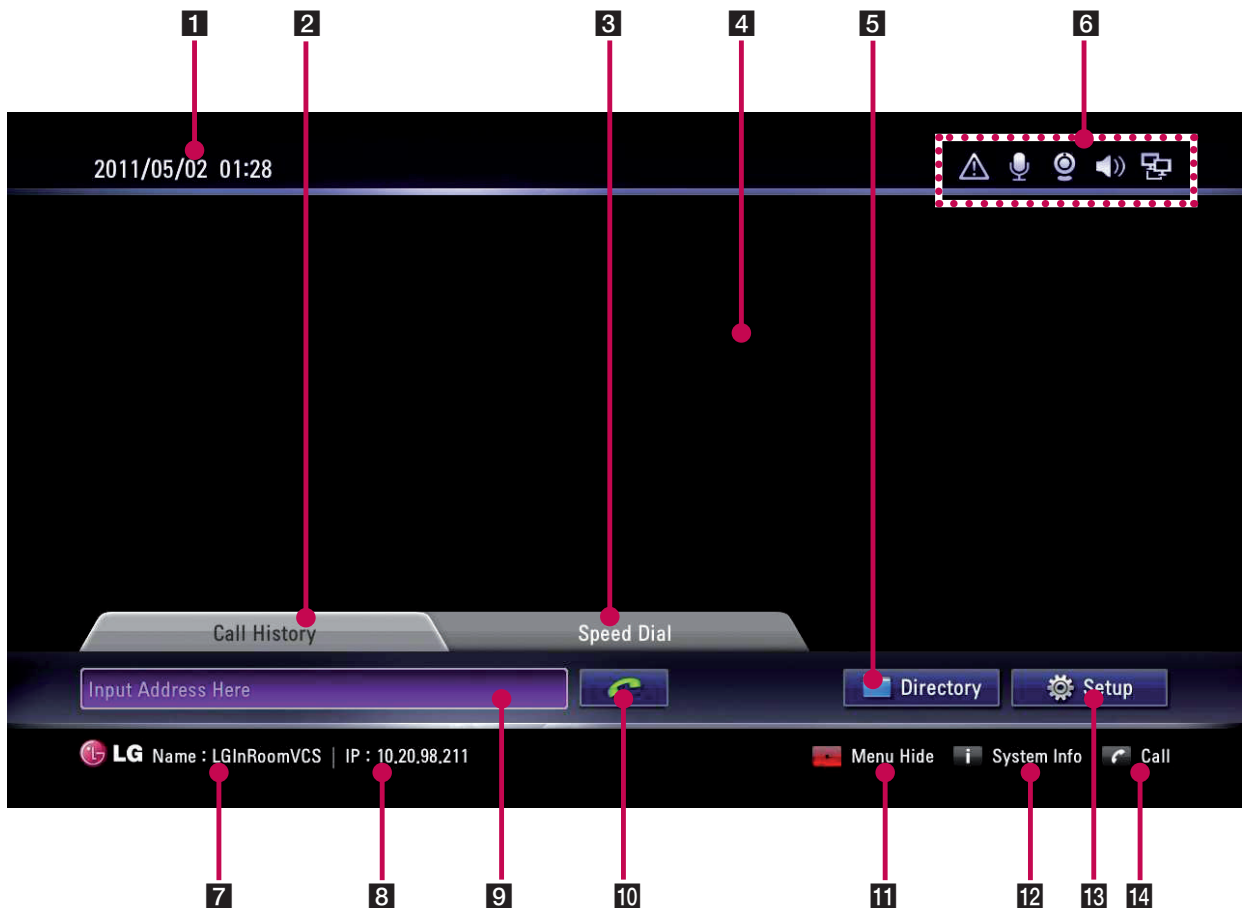

**NOTE**

- Additionally, refer to the on-screen instructions for each option's setting.
- If you want to move to the previous option settings, select Previous and press **OK** or press .

## Main Screen Overview



- 1 Current Date and Time: Displays the current date and time.
- 2 Call History: You can make a call by selecting a number from a list of recently dialed numbers.
- 3 Speed Dial: You can see a list of recently saved speed dial number. You can make a call by pressing a number button of remote controller and selecting a number from list.
- 4 Local Video Area: Displays the current input video of the local camera.
- 5 Directory: Enter the directory tab to see your My Contact and Call History lists.
- 6 Status Icons

Activated	Deactivated	Description
	Not displayed	Displays the server status.
		Displays the Microphone on or off condition.
		Displays the camera status.
		Displays the speaker status.
		Displays the network status

- 7 System Name: Displays the current system name.
- 8 IP Address: Displays the current IP address of the unit.
- 9 Text Input Field: Enter the dial numbers or IP address manually.
- 10 Call Button: Use this button when you want to make a call.
- 11 Menu Hide: You can hide the user interface elements and you can show the user interface element other remote key.
- 12 System Info: You can display system status, Audio/Video, Network Utility and Server Status.
- 13 Setup: You can enter setup menu so you can change system status.
- 14 Call: You can make a call from text input field address.

## System Configuration Menu

The features and options of the VCS system are configured through the setup menu.

1. On the main screen, press **SET-UP** to access the Setup Menu.  
Use the below buttons on the remote control to navigate the menu options.
  - Arrow buttons: Use these buttons to select the menu options or adjust the options value.
  - OK: Select the option or confirm the setting.
  - RETURN: Return to the previous menu or level.
2. Press **SET-UP** to exit the setup menu.



## User Settings

### General



- System Name: Enter a system name using up to 127 characters. The inputted system name is displayed on the main screen.
  1. Press **OK**.
  2. Edit the system name using the virtual keyboard or remote control.
  3. Press **OK** to confirm the setting.
- Call Mode: Select a call mode.
  - Audio+Video: When you make a call with audio and video.
  - Audio Only: Select this option when you want to call with audio only.
- Answer Type: Select the answer type for the incoming call.
  - Auto answer : The system automatically answers the incoming call.
  - Manual: You must manually answer incoming calls.
  - Do not disturb me : When the system Do Not Disturb feature is enabled, the system displays the main screen. Callers hear a busy signal and missed calls appear in the Call History. Consider using this feature, for example, if you are using the meeting room for a purpose other than a video conference and do not wish to be disturbed by incoming calls.
- Screen Saver: When your system is idle during the selected time, it will be activated and the LG logo will be displayed on the monitor. An incoming call or pressing any button on the remote control automatically invokes the system.
- Language: Select a language for the setup menu and information display.

## Audio

Adjust settings for audio input and output devices connected to the system.



- Microphone: Select the audio input to use for the active microphone.
  - Auto: The system selects the audio input automatically.
  - Camera: Audio input can be activated with internal microphone of the HD camera only.
  - Ext. Microphone: Audio input can be activated with external microphone device only.
- Ext. Microphone Gain: Adjusts the volume level of the external microphone.
  1. Press **OK** and adjust volume level using the left or right arrow button.
  2. Press **OK** to confirm it.
- Echo Control: Select echo function to ON or OFF.
  - On: Select when you want to turn on the echo cancellation.
  - Off: Select when you want to turn off the echo cancellation.
- Audio Out: Select the location for audio output during calls.
  - Auto: The system selects the audio output automatically. If you select this option, basically the unit selects the built-in speaker of the codec unit. If you connect through the headset jack, audio is output via the connected headset device. If you want to listen through HDMI, you must set HDMI in the audio out.
  - HDMI: Audio is output via the connected HDMI device.
  - Built-In Speaker: Audio is output via the built-in speaker of the codec unit.
  - Headset Out: Audio is output via the connected headset device.
- RingTone: Select the volume level of the ring tones.
  - Off: The ring tone volume is off.
  - Small: The ring tone volume is set to small.
  - Middle: The ring tone volume is set to middle.
  - Loud: The ring tone volume is set to loud.

## Video

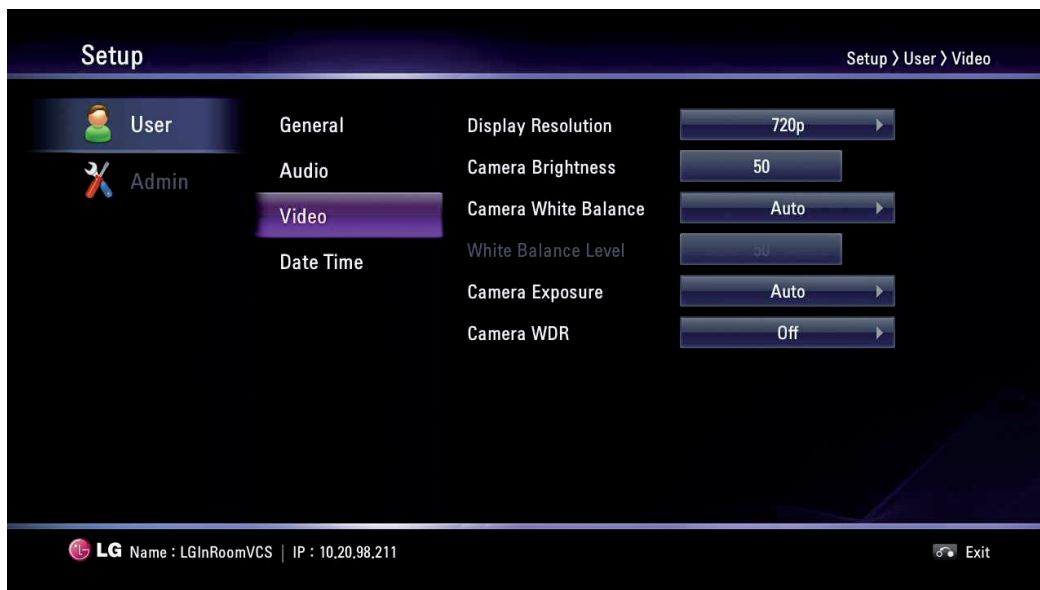

- Display Resolution: Select the display resolution of the connected monitor. If you change the resolution, the confirmation window is displayed and then press **OK** to reboot the system. You can set the system to 720p or 480p. The default is 720p.
- Camera Brightness: Select the brightness level for the camera. Camera brightness refers to the received amount of light through the lens of the camera. You can improve dim scenes by manually adjusting the camera brightness.
  1. Press **OK** and adjust brightness using the left or right arrow button.
  2. Press **OK** to confirm the setting.
- Camera Whitebalance: Select the Whitebalance activation mode. Adjust the white balance when video color appears to be unbalanced. White balance is affected by the type of light source.
  - Auto: The whitebalance function is activated automatically.
  - Manual: Adjust the white balance level on the Whitebalance level menu.
- Whitebalance Level: Set the white balance level. This option is activated when you set to manual in the [Camera Whitebalance] setting menu.
  1. Press **OK** and adjust white balance using the left or right arrow button.
  2. Press **OK** to confirm the setting.
- Camera Exposure: Selects the Exposure Menu to match your lighting conditions.
  - Auto: The system selects the Auto Exposure Menu to match your lighting conditions. If flickering occurs, try another setting.
- Camera WDR: WDR (Wide dynamic range) feature can be very helpful to cope with very challenging lighting conditions. It is capable of capturing both of the dark part and bright part and combining the differences into a scene to generate a highly realistic image as original scene.
  - On: Select when you want to activate the WDR function.
  - Off: Not used.

## Date Time

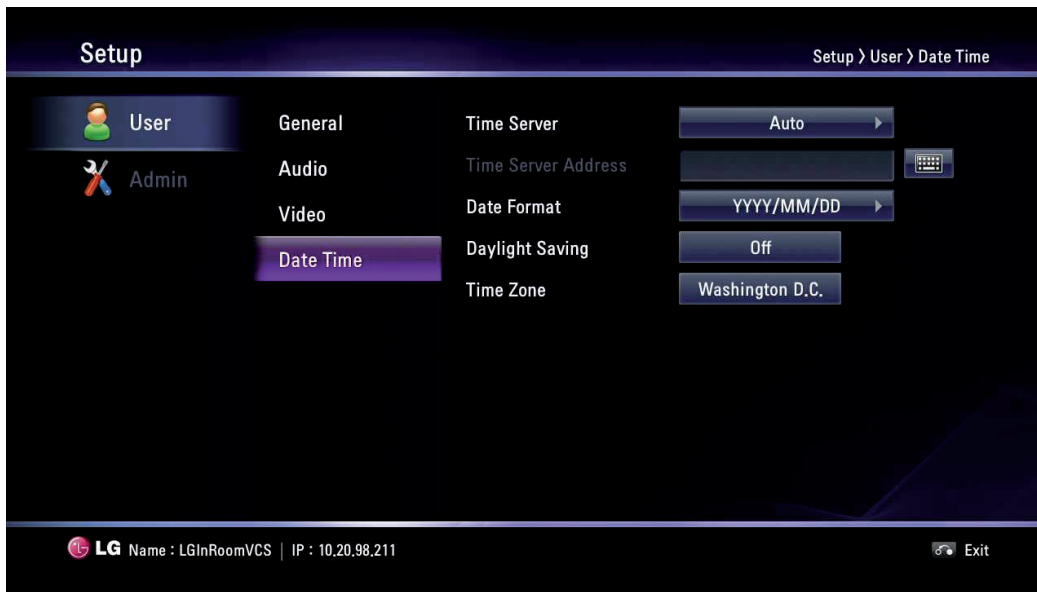

- Time Server: Select time setting method.
  - Auto: Set the time server automatically.
  - Manual: Set the time server manually. Usable NTP servers are shown below.

NTP Server	IP address
time.nist.gov	192.43.244.18
time-a.nist.gov	129.6.15.28
time-b.nist.gov	129.6.15.29
ntp.nasa.gov	198.123.30.132
clock.isc.org	204.152.184.72
time.bora.net	203.248.240.140

- Time Server Address: Enter the IP address or hostname of the time server. This option is activated when you set to manual in the [Time Server] setting menu.
- Date Format: Select the display format for date.
- Daylight Saving: Set the daylight-savings time.
  1. Press **OK** and then the daylight-savings time setting menu will be displayed.
  2. Mark up to set the daylight-savings function.
  3. Set the daylight-savings start time.
  4. Set the daylight-savings end time.
  5. Press **OK** to confirm the setting. After setting, the daylight-savings option is set to On.
- Time Zone: Select the time zone for your system.

## Admin Settings

If you select this, the password input window is displayed.

To change the administrator settings, you should input the password. The default administrator password is "1234". Enter the password to display the administrator sub-menu options.

## Call Settings

### General



- Maximum Call Time: Enter the Maximum Call Time from 1 minute to 99999 minutes. After the entered minutes, the system will lose the call automatically.
- Maximum Bandwidth: Select the maximum amount of network bandwidth to use for video call.
- Outgoing Protocol: Select the protocol to use when attempting to outgoing Call. You can choose H.323, SIP, or Auto. If you select H.323 or SIP, you can make a call selected value. If the far site user does not enable the same protocol, you can't connect to the far site. If you selected Auto, you are able to connect moderately with the far site setting. (H.323 is tried before the SIP. If H.323 does not connect, a SIP call is attempted automatically.)
- SIP Transport Protocol: Select the transport protocol to use during sip outgoing call. You can choose TCP, UDP, or Auto. If you select TCP or UDP, you can make a SIP call with the selected value. If the far site user does not enable the same transport protocol, you can't connect to the far site. If you select Auto, you are able to connect moderately with the far site.

### H.323

This unit supports the H.323 protocol for placing and receiving video and voice calls. This is used when a gatekeeper function is attempted.



- H.323 Name: Enter the name of the device used when making calls with H.323 with the alphabet, numbers and special characters.
- E.164 Name: Enter the name of the device used when making calls with E.164. This name is used when users register in the gatekeeper server. If the device is registered on gatekeeper server, the far site user can call this name.
- Security: H.235 128-bit AES security in H.323 calls. When enabled, the system automatically encrypts calls to other systems that have AES encryption enabled. When set to AES, calls connect, are encrypted only if the far end supports AES encryption. If the far end user does not support AES encryption, calls are not encrypted.
- Use Gatekeeper: Set to On when you use the gatekeeper function. This unit supports the H.460 protocol for firewall and NAT traversal of H.323 calls. You must have an H.460 server configured in your environment for this feature to function properly. If you set to On, the H.460 NAT, Gatekeeper Address and Gatekeeper Port options are enabled to set it.
- H.460 NAT: Set to On when you use the H.460 standard for NAT and firewall traversal.
- GateKeeper Address: Enter the IP address of the primary H.323 gatekeeper.
- GateKeeper Port: Enter the port number of the primary H.323 gatekeeper.

#### ! NOTE

You can check the registered status in the Server Status menu of the system information window.

## SIP

This part is used when users attempt to use a SIP server.



- SIP Name: Enter the name of the device used when making calls with SIP. The SIP name can be used with alphanumeric. If you enter other characters except letters, numbers, ",", "-" and "\_", you cannot connect a SIP call.
- Use SIP Server: Set to On when you use the SIP server. If you set to On, the username, password, TLS, register server address, register server port, proxy server address and proxy server port options are enabled to set it.
- User Name: Enter the SIP server authorization username.
- Password: Enter the SIP server authorization password.
- TLS: When users call, TLS gives safe information about any message. If you set to On, the register server port and proxy server port options are set to 5061 automatically.
- Register Server Address: Enter the hostname or IP address of the SIP register server.
- Register Server Port: Enter the IP port number of the SIP register server.
- Proxy Server Address: Enter the hostname or IP address of the SIP proxy server.
- Proxy server Port: Enter the IP port number of the SIP proxy server.

## QoS

You can specify network Quality of Service (QoS) settings.



- Dynamic Bandwidth: Adjusts the bandwidth automatically for the best video bandwidth available.
  - On: Dynamic bandwidth function is used.
  - Off: Not used.
- IP QoS Type: Select the type of TCP/IP Quality of Service (QoS) that your network uses.
  - None: Not used.
  - DiffServ: Set to DiffServ (differentiated services) type of Service (QoS) for audio, video and data packets.
  - IntServ: Set to IntServ (integrated services) type of Service (QoS) for audio, video and data packets of the Service (ToS) preference. If you select this option, the IntServToS option is enabled to set it.
- IntServToS: Select IP Type of Services. This helps a router select a router path when multiple paths are available.



## Network Settings

### IP

You must set the IP address for the call.

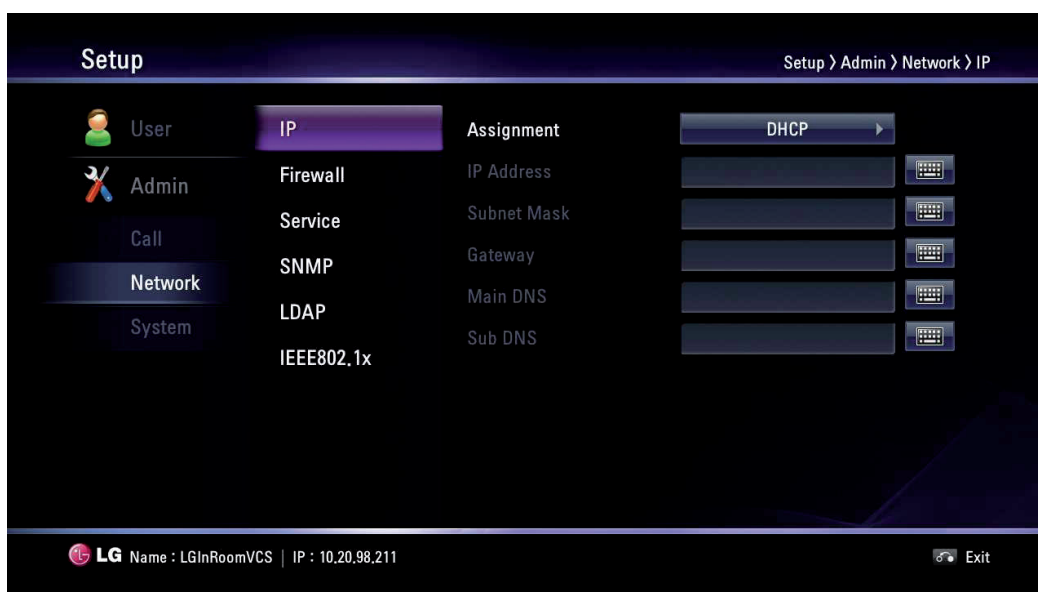

- Assignment: Set to STATIC or DHCP for your network configuration.
  - DHCP: Select this option when a DHCP server is installed on the network to allow IP address assignment. With this setting, the IP address is assigned automatically. If you set to this, the IP address, subnet mask, gateway, main DNS and sub DNS options are dimmed.
  - STATIC: Select this option when you set the network configuration manually.
- IP Address: Enter the static IP address of the device.
- Subnet Mask: Enter the subnet mask IP address.
- Gateway: Enter the default gateway IP address.
- Main DNS: Enter the Primary domain name server that translates the hostnames into IP address.
- Sub DNS: Enter the sub DNS server address that backups the main DNS.

### Firewall

This function is used when users try to bypass the firewall.

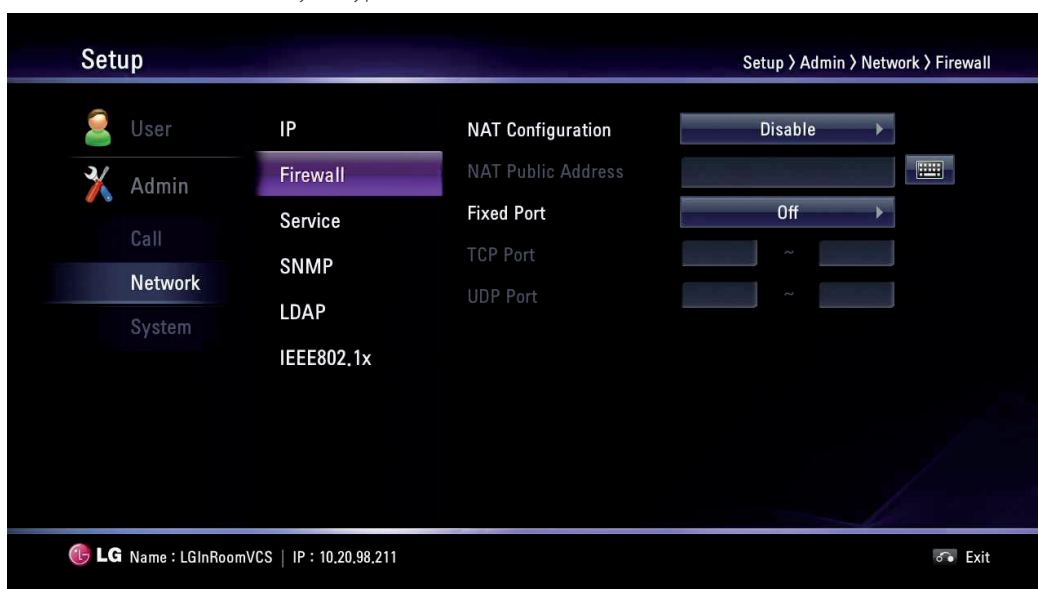

- NAT Configuration:
  - Disable: Not used with this function.

- Enable: Select when using the static NAT server to traverse your firewall. If you select this option, the NAT Public Address option is enabled.
- NAT Public Address: Enter the public IP address or hostname of the system.
- Fixed Port: You can fix the TCP and UDP port range. If you set to On, the TCP port and UDP port options are enabled.
- TCP Port: Enter the lowest/highest number in the reserved range of the TCP port numbers.
- UDP Port: Enter the lowest/highest number in the reserved range of the UDP port numbers.

## Service



- Web Server: If you set to On, you can connect to this device using the web browser.
- Telnet: If you set to On, you can connect to this device using the telnet.
- SSH: If you set to On, you can connect to this device using the SSH.

## SNMP



- SNMP: Allows administrators to manage the system remotely using SNMP.
  - Disable: Not used with this function.
  - Enable: Selects when SNMP is allowed access to this device. If you select this option, the Trap Host and Community options are enabled.
- Trap Host 1 to 3: Specifies the IP address of the computer you intend to use as your network management station and to which SNMP traps will be sent.

- Community: Specifies the SNMP management community in which you want to enable this system (e.g. lgecommunity or public).

## LDAP

LDAP is the ability to read registered address books in the LDAP server. If you connect to an LDAP server, you can confirm in corporate contact tab in directory.



- LDAP:
  - Disable: Not used with this function.
  - Enable: Selects when the LDAP server allows access to this device.
- Hostname: Enter the host name or IP address of your LDAP server.
- User: Enter the username of your LDAP server.
- Password: Enter the password your LDAP server.
- Base: Enter the base Distinguished Name (DN) used to query your LDAP server.
- Filter: Enter filter strings that you use to specify a subset of data items in an LDAP data type.

## IEEE802.1x

Specifies whether 802.1X network access is enabled. This systems support the following authentication protocols:

- EAP-MD5
- EAP-PEAP
- EAP-TTLS

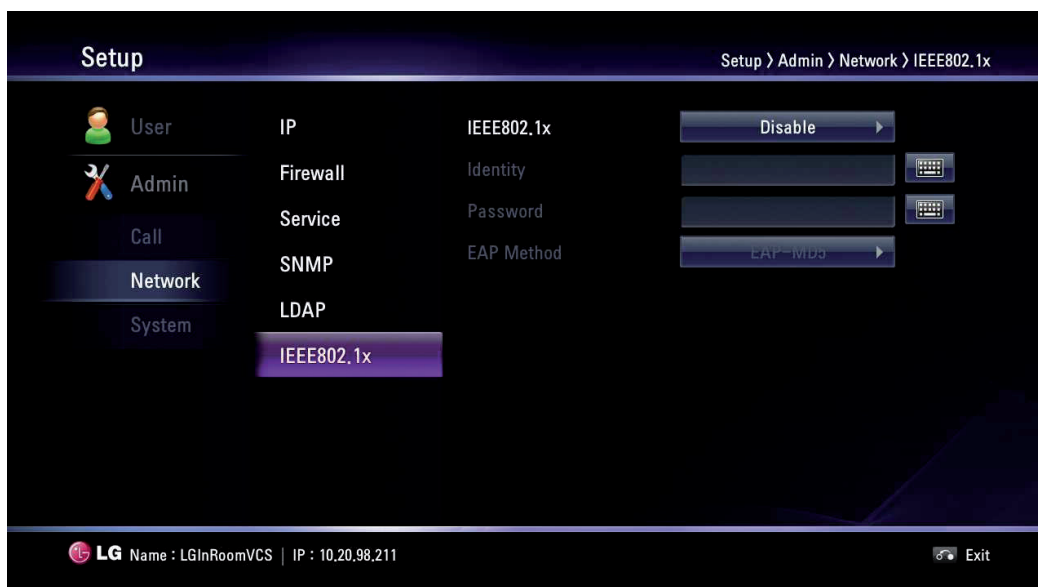

- IEEE802.1x:
  - Disable: Not used with this function.
  - Enable: Select this option to 802.1x user authentication. If you select this option, identity, password and EAP method options are enabled.
- Identity: Enter the identity name given to you by your IT administrator. This specifies the system's identity used for 802.1X authentication.
- Password: Enter the password given to you by your IT administrator. This specifies the system's password used for 802.1X authentication.
- EAP Method: Select the EAP method.



## NOTE

### When User Use EAP-MD5

If you use EAP-MD5, you do not need to upload any files in the web service.

### When User Use EAP-TTLS

1. If you use EAP-TTLS, you must receive ca.pem, client.pem, client.key from the 802.1x network manager.
2. Upload the ca.pem, client.pem, client.key files to the web service of your system as shown in the picture below.

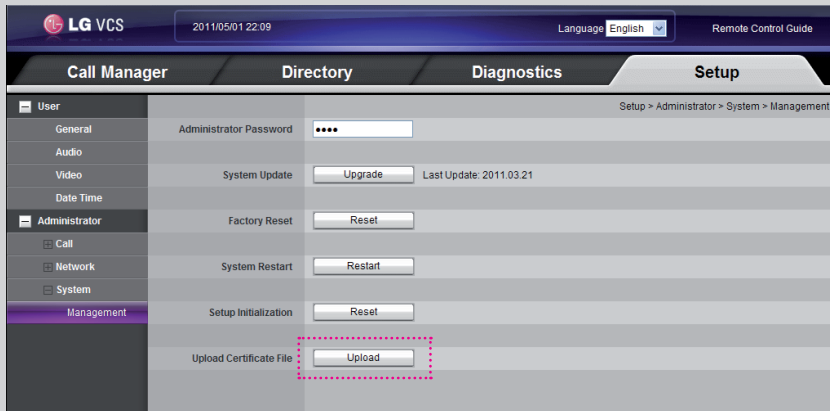

### When User Use EAP-PEAP

1. If you use EAP-PEAP, you must receive a ca.pem file from the 802.1x network manager.
2. Upload the ca.pem file to the web service of your system as shown in the picture below.

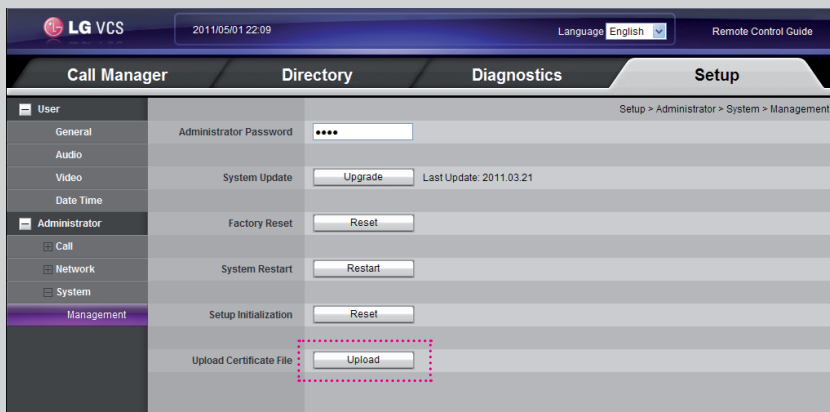

### After Setting 802.1x

1. When you finish these settings, confirm that you can see your IP on the main screen.
2. Perform a ping test in the system info > Network utility > Command.
3. You can now attempt to call other VCS systems.

## System Settings

### Management

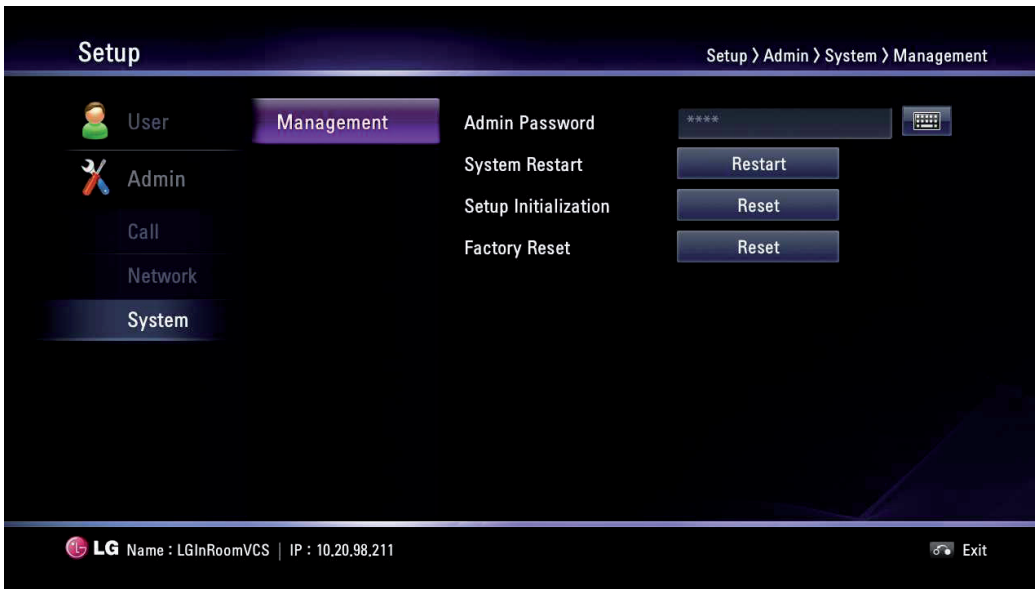

- Admin Password: Change the password of the administrator if you want. The password is case-sensitive.
- System Restart: To restart the system, do the below steps.
  1. Select Restart and press **OK**. The warning window is displayed.
  2. Select [OK] and press **OK**. The system will be restarted.
- Setup Initialization: You can initialize the configuration of the setup menu.
  1. Select Reset and press **OK**. The warning window is displayed.
  2. Select [OK] and press **OK**. The system will be initialized and restarted.
- Factory Reset: You can reset the system to its original factory settings.
  1. Select Reset and press **OK**. The warning window is displayed.
  2. Select [OK] and press **OK**. The system will be reset to factory default and

#### **NOTE**

If you select the [Factory Reset] option, the saved address in the directory will be deleted.

## System Information

After the configuration setup, you can view the condition of the system.  
Press **INFO** to display the information window.

### System Status

You can view the information of the current system status and configuration.

The screenshot shows the 'System Info' window with the 'System Status' tab selected. The left sidebar contains buttons for 'System Status', 'Audio/Video', 'Network Utility', and 'Server Status'. The main area displays the following system information:

System Type	Codec Phone
System Version	Main:6508M-20110321 /DSP:6508M-20110321/CAMERA:0,13
Model	RVF1000
Serial Number	010KVXF344370
Physical Address	e8:5b:5b:ac:7a:fa
Network Status	connected
Network Speed	100Mb/s (full-duplex)
Network	DHCP
System Name	LGIInRoomVCS
IP Address	10.20.98.211
Subnet Mask	255.255.254.0
Gateway	10.20.98.1
DNS Server	165.244.106.110

### Audio/Video

You can check the audio/video condition.

The screenshot shows the 'System Info' window with the 'Audio/Video' tab selected. The left sidebar contains buttons for 'System Status', 'Audio/Video', 'Network Utility', and 'Server Status'. The main area displays the following audio/video settings:

Display Type	HDMI
Display Resolution	1280x720
Input Video	Camera
Input Video Resolution	1280x720
Microphone	Auto
Microphone Detected	Camera
Audio Out	Auto
Audio Out Detected	Built-In Speaker
Audio Out Test	<input type="button" value="HDMI"/>
	<input type="button" value="Start"/>

#### How to Test the Audio Output

1. Select the Audio Out Test option using the arrow button.
2. Press **OK** and select the audio output option among the HDMI, Built-In Speaker or Headset Out option.
3. Press **OK** and select [Start].
4. Press **OK** again to test the audio output. You will hear three beeps sound, then exit the test. If you cannot hear the beeps, check the volume level or connection.

## NOTE

If you use the HDMI TV or monitor as an audio output and want to get the high-quality sound, you should run the Audio Out Test for HDMI at the [System Info > Audio/Video] menu.

## Network Utility

You can troubleshoot network connection issues with your system using the ping and traceroute utilities in Network Utility.

1. Select the IP Address field.
2. Press **OK** to enter a value. If necessary, use **1/a/A** to change the method of text entry for text fields or select the keyboard icon to display the virtual keyboard. After entering a value, hide the keyboard (if you used it to enter the value) and press **OK** to exit the field.
3. Select the option of the command menu.
  - Ping: The ping command tests responsiveness between two devices.
  - Traceroute: The traceroute command tests responsiveness and traces the path of a packet from one device to the other.
4. Press Start and press **OK** to test it.



## Server Status

You can view the server status.

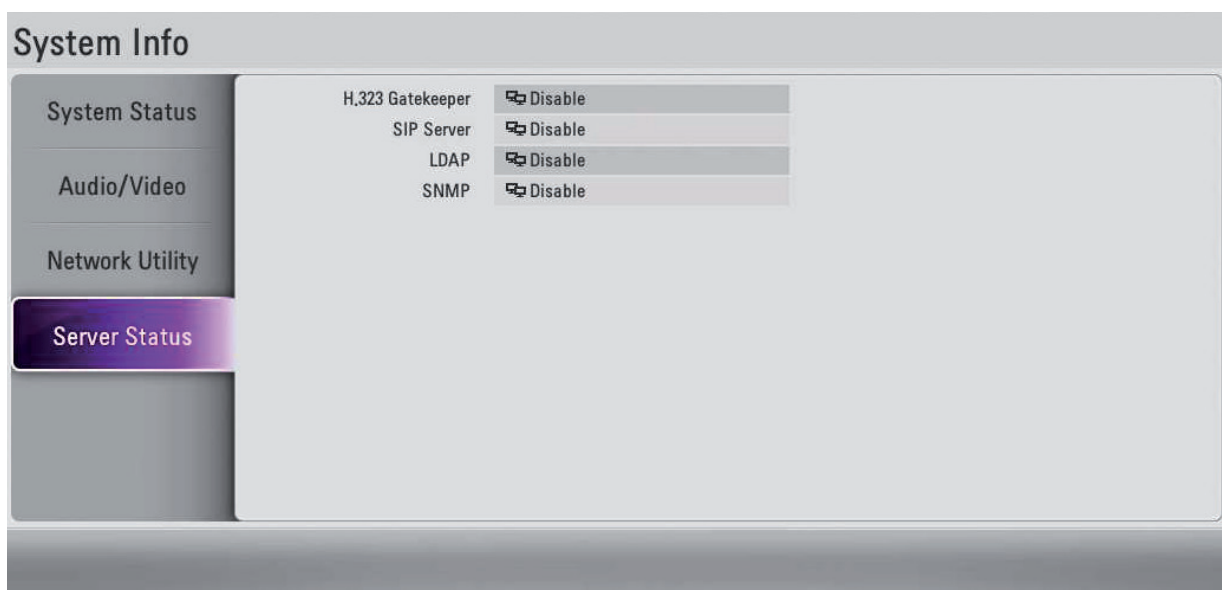

# 4 Operation

## Before Using the System

- Before using the LG VCS device, make sure the connections are correct and verify that a proper power supply is used.
- Check the connections of the LG VCS device for the correct conditions.
- Check that the LG VCS device is connected to the network and power is supplied.
- Before using the VCS, make sure the network settings are correct.
- Before placing a call, examine the near end video image from the connected camera to your system. If the image flickers, colors appear unbalanced or the image appears too dark, you may need to adjust the room lighting or camera brightness and white balance and check the Camera Exposure menu.

## Placing a Call

You can place a call from your system to another VCS system. Begin a call in one of the following ways:

### Placing a Call Manually

You can place a call by entering the IP address manually.

1. Select the Text input field and press **OK**.

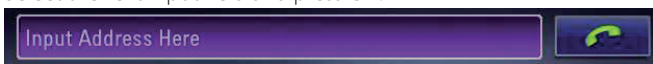

2. Enter an IP address or dial numbers.  
Use **T/A/A** to change the method of text entry for text input field.



3. After entering a value, press **OK**.  is selected automatically.
4. Press **OK** again to place a call. The call status dialog box is displayed.

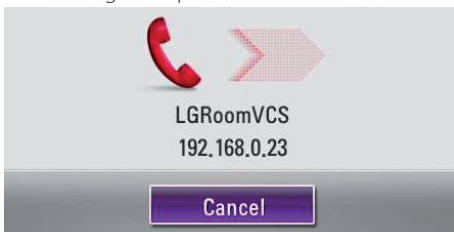

The call status dialog box shows the number or IP address that you are attempting to call and the status of the call.



### NOTE

- If you cancel the call, press **OK** during the dialing.
- If the system does not answer the call within about 120 seconds, your system will be disconnected automatically.
- Check the IP address of the system before you place a call. If you do not set the IP address correctly or set the wrong IP address, you can not make a call.

## Placing a Call from the Call History

The list of the Call History stores up to 10 recently dialed phone numbers. The oldest entry in the list is automatically removed when the system receives a call or places a call after the maximum number of entries has been reached. The last call placed always appears first on the list.

1. From the main screen, press the upper arrow button. The Call History tab is expanded.

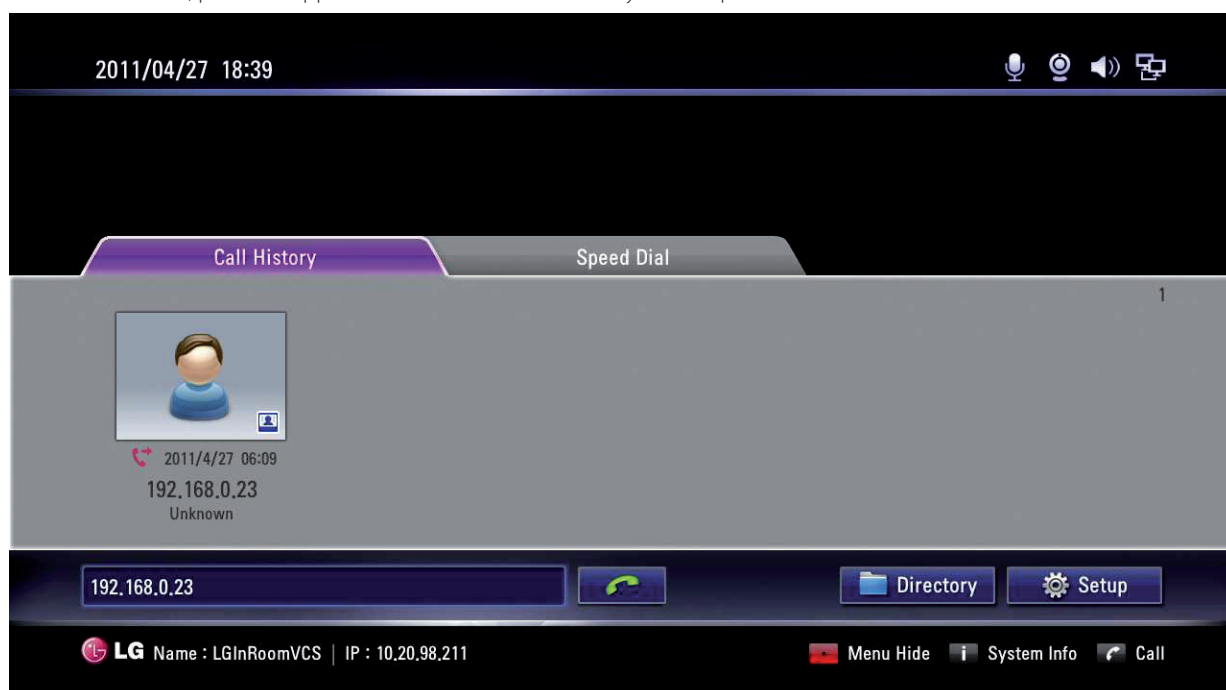

2. Use the left  or right  button to select an entry.
3. Press **OK** to place a call. The call status dialog box is displayed.

### NOTE

To cancel the call, press **OK** during the dialing.

## Placing a Call from the Directory

The directory stores a list of names and numbers from which you can place calls. To place a call from the directory, follow these steps:

1. From the main screen, press **DIRECTORY** on the remote control or select [Directory] on the main screen and press **OK** to access the directory.
2. Use the arrow buttons to select the entry that you wish to dial.
3. Press **OK** to place the call. The call status dialog box is displayed.

### NOTE

Refer to the Directory setting section for more details.

## Placing a Call using the Speed Dial

If you set a speed dial number, you can place a call quickly and easily. Press and hold the registered number button for a while until the call status dialog box appears.

## Answering or Rejecting a Call

You can configure your system to automatically answer incoming calls by setting preferences in [User > General > Answer Type] menu as follows:

- Auto Answer: If you select this option, the system automatically answers the first incoming call.
- Manual: If you select this option, you must manually answer incoming calls. If your system is configured for answering calls manually, choose one of the following options when an incoming call arrives:
  - Select [Pick up] and press **OK** to accept the call.
  - Select [Reject] and press **OK** to reject the call.
- Do not disturb me: If you select this option, you can block the all of the call from the other system. The "Do not disturb" message is displayed in the middle of the top of the main screen. Missed calls appear in the Call History list. Consider using this feature, for example, if you are using the meeting room for a purpose other than a video conference and do not wish to be disturbed by incoming calls.

### ! NOTE

If you call to another system with the "Do not disturb" function is enabled, the warning window is displayed and the call is disconnected automatically.

## Managing a Call

During a call, you can view information about the status of the call and the identity of the connected caller.

### Ending a Call

You can end a call using  on the remote control.

Press  when you want to end a call.

### Hiding or Showing User Interface Elements

To hide or show the user interface elements at any time during a call, press .

### Managing Audio

You can adjust the volume of the audio and mute the active microphone.



#### Adjusting Volume

To adjust the volume in a call, use [VOL + / -] on the remote control. If the volume is set to "0", audio output is muted and Mute icon  appears in the main screen.

### ! NOTE

- If the camera is too close to the TV, Echo Performance can be bad condition.
- If you use the built-in speaker of the codec box and the camera is too close to the codec box, Echo Performance can be bad condition.

## Muting the Active Microphone

Press  on the remote control. When the active microphone is muted in a call, the microphone symbol  changes to the muted microphone  icon.

## Managing Video Layout

During a call, video from the connected caller appears in your monitor. You can change the screen layout of near and far end video.

### Understanding Screen Layouts



Typically, screen layouts appear as the following types:

- A far end participant or a presentation appears on the left window.
- Your site (the near end participant) appears on the right window.

### Changing the Screen Layout

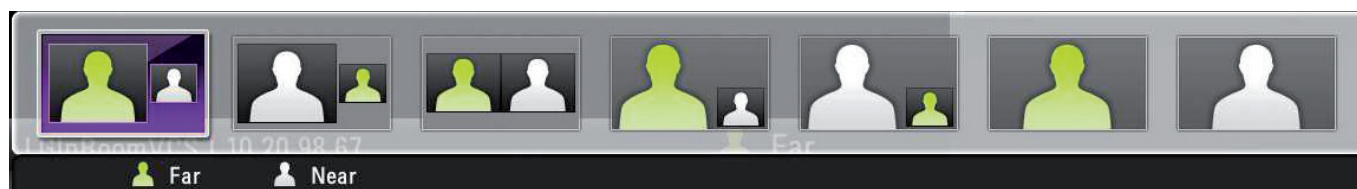
1. During a call, press **LAYOUT** button to display the layout select window.



2. Selects the screen layout using left  or right  button.
3. Press **OK** to confirm.

## Sharing Content

During a call, you can share digital content.

1. Connect the PC to the system with D-sub cable (see page 16).
2. Let out the video out correctly on your PC (e.g. Fn(Function) + F7 or Dual monitor setting)
3. Press **CONTENT**. The "Video source is changing..." message will be displayed on the screen. The PC screen is displayed on the near-end video window.
4. If you press **CONTENT** again, it returns to the camera screen.



### NOTE

This unit supports 640x480, 800x600, 1024x768 and 1280x768 resolutions for PC output resolutions.

## Viewing Call Information

You can view the call information.

1. During a call, press **INFO**.  
The current call information window is displayed on the screen.
  - Call Protocol: Shows the call protocol.
  - Resolution: Shows the resolution, in pixels, of the video image transmitted or received.
  - Video Frame Rate: Shows the video frame rate in frames per second.
  - Video/Audio Codec: Shows the Video/Audio codec used to compress and decompress the Video/Audio.
  - Video Packet loss/Audio Packet loss: Shows the number of packets of data that fail to reach their destination. Packet loss can be caused by a number of factors, including signal degradation over the network medium, oversaturated network links, corrupted packets rejected in-transit, faulty networking hardware, maligned system drivers or network applications, or normal routing routines.
  - Video/Audio jitter: Shows the variation, in milliseconds, in the time between packets arriving, caused by network congestion, timing drift, or route changes.
  - Video/Audio BW: Shows the amount of Video/Audio data transferred per second in kilobits.
  - Cumulative: Shows the up to date count of packets lost in the call.
  - Percentage: Shows packet loss as a percentage of the total packets sent.

- Press **RETURN** to exit.

**NOTE**

Call information automatically refreshes every 5 seconds.

## Get the Snapshot

During a call, you can get a snapshot of the current video image. It will be displayed in the entry of the Call History list.

Press  to take a snapshot.

## Managing the Directory

If you have access to the local directory, you can add, remove or edit entries.

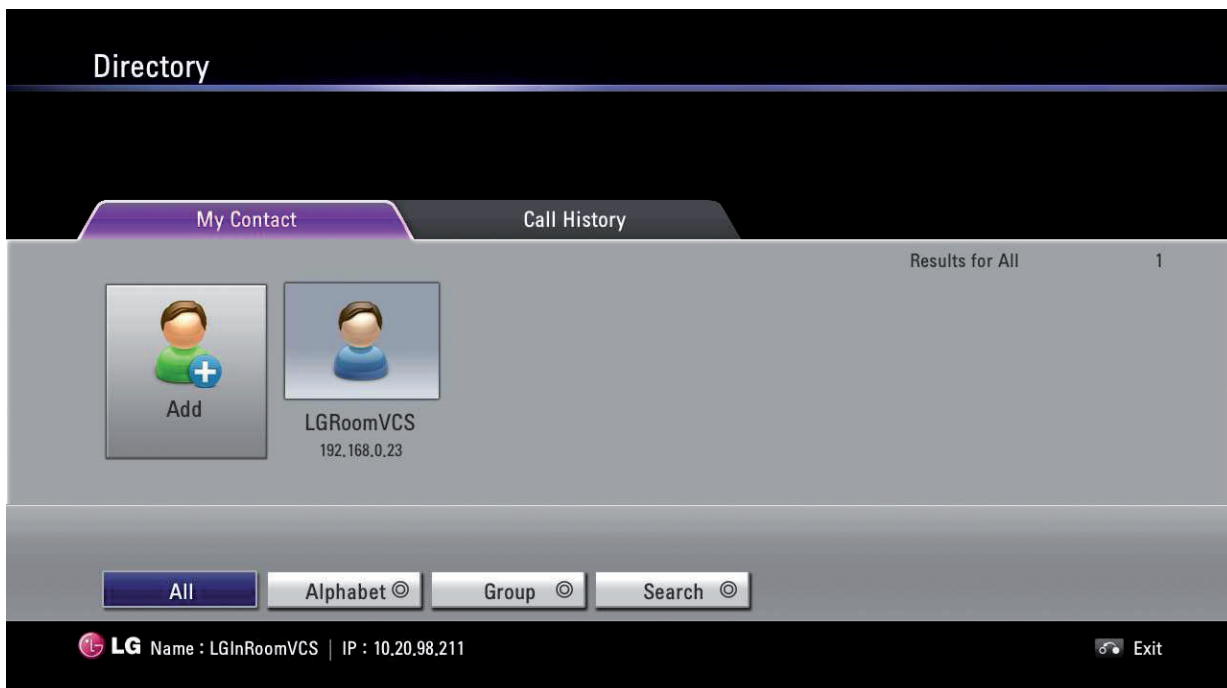

## Adding an Entry to the Directory

You can create up to 1000 entries in the directory. To add an entry in the directory, follow these steps:

- From the main screen, press **DIRECTORY** on the remote control or select [Directory] button the main screen and press **OK** to access the directory.
- Select the My Contact tab using the arrow buttons.
- Use the arrow buttons to select [Add] and press **OK** or press . The Add to Directory window is displayed.

4. Use the arrow buttons to select the Name field. Press **OK** to enter a value.  
If necessary, use **1/a/A** to change the method of text entry for text fields or select the keyboard icon to display the virtual keyboard. After entering a value, hide the keyboard (if you used it to enter the value) and press **OK** to exit the field.
5. Use the arrow buttons to select the Address field. Press **OK** to enter a value.  
If necessary, use **1/a/A** to change the method of text entry for text fields or select the keyboard icon to displayed the virtual keyboard. After entering a value, hide the keyboard (if you used it to enter the value) and press **OK** to exit the field.
6. Use the arrow buttons to select the Group item and press **OK**. Select a group and press **OK**.



#### NOTE

If you make a new group, do the following steps.

- 6-1. Select [+New] and press **OK**. The new group window is displayed.
- 6-2. Enter the new group name and press **OK**. Select **OK** of the window and press **OK** to confirm it.

7. You can confirm saved entry in Speed Dial.  
If you want to remove a saved Speed Dial number, you can remove by selecting in the Edit to directory.
  - 7-1. From the main screen, press **DIRECTORY** on the remote control or select [Directory] on the main screen and press **OK** to access the directory.
  - 7-2. Select the My Contact tab using the arrow buttons.
  - 7-3. Use the arrow buttons to move a modifying list and press **...**.
  - 7-4. Use the arrow buttons to select the Speed Dial item and press **OK**. Select a number to delete on the list and press **OK**.
  - 7-5. You will see a pop-up window, then press **OK**.
8. Use the arrow buttons to select a Call Type item and press **OK**.  
Select a call type and press **OK**.
9. When you have completed the settings, select **OK** and press **OK** the remote control.

## Editing or Deleting an Entry from the Directory

1. From the main screen, press **DIRECTORY** on the remote control or select [Directory] on the main screen and press **OK** to access the directory.
2. Select the My Contact tab using the arrow buttons.
3. Select the entry you wish to edit and press **...**.  
The Edit Directory window is displayed. If you delete the entry, select entry and press **.....** or **[DEL.]**. The Delete Contact window is displayed and you select [OK] and press **OK** on the remote controller.

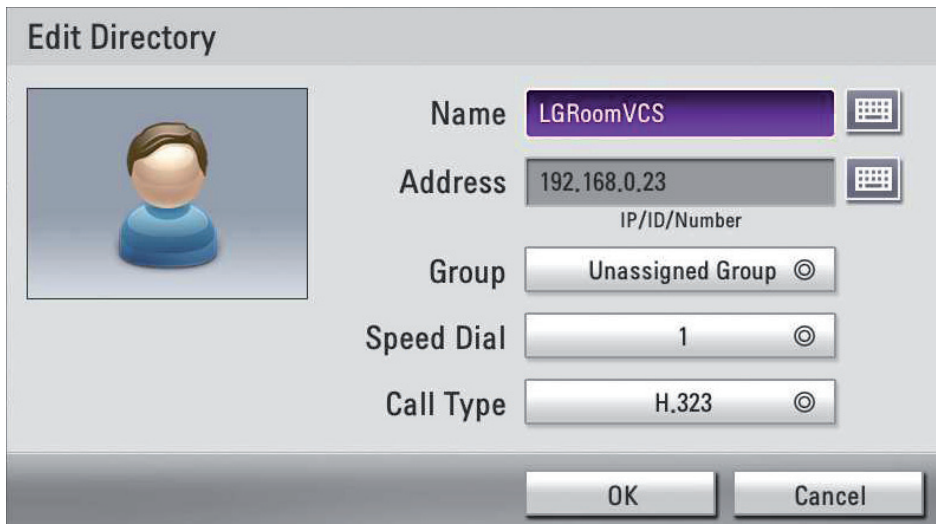

4. Modify values in the Edit Directory Entry dialog.

### Copying an Entry from the Call History

You can copy an entry from the Call History list to the My Contact list.

1. From the main screen, press **DIRECTORY** or press the arrow up button on the remote control or select [Directory] on the main screen and press **OK** to access the directory.
2. Select the Call History tab.
3. Select the entry you wish to copy to the My Contact tab.
4. Press **...**. The Add to Directory window is displayed.
5. Select [OK] of the Add to Directory window. If you want to edit the item, change the value before you save it.
6. Press **OK** on the remote control.

### Copying an Entry from the Corporate Contact

When LDAP is enabled, Corporate Contact is displayed in the Directory.

1. Enter Corporate Contact tab and select an entry and press **...**.
2. Copy to My Contact window is displayed. Select [OK].
3. Press **OK** on the remote controller.

### Deleting an Entry from the Call History

1. Enter the Call History.
2. Select the entry you wish to delete and press **....** or [DEL].
3. The Delete History window is displayed.

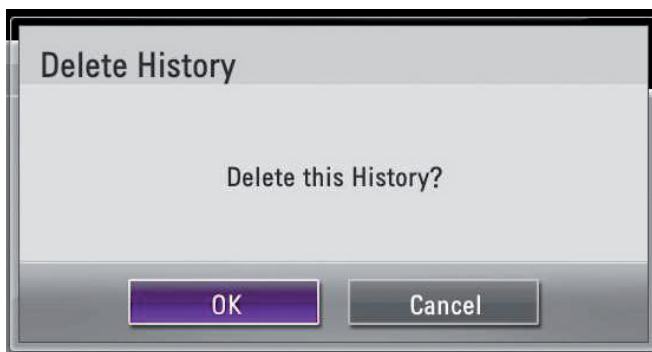

4. Select [OK] and press **OK** on the remote control.

## Sorting and Searching

Basically, directories are sorted in the following order: special characters, numbers, characters.



- All: All entries are displayed.
- Alphabet: If the first letter of a name in the entries is included in the selected alphabet button, the entries are displayed.
- Group: If entries are included in the selected group button, the entries are displayed.
- Search: If the letter or special character in the name is included in the written character on the search field, the entry is displayed.

## Placing a Call when the Device is Registered in Gatekeeper Server

You can place a call by entering the registered far site name in gatekeeper server.

1. You must confirm registered far site name in gatekeeper server.
2. Select the text input field and press **OK**.
3. Enter a registered far site name. Use **1/a/A** to change the method of text entry for text input field.
4. After entering a value, press **OK**.  is selected automatically.
5. Press **OK** again to place a call. The call status dialog box is displayed.



### NOTE

- If you want to cancel the call, press **OK** while dialing.
- If you do not answer the call in 2 minutes, the system will disconnect the call automatically.

## Making a Call when the Device is Registered in SIP Server

1. You must confirm registered far site name in SIP server.
2. Select the Text input field and press **OK**.
3. Enter an registered far site name. Use **1/a/A** to change the method of text entry for text input field.
4. After entering a value, press **OK**.  is selected automatically.
5. Press **OK** again to place a call. The call status dialog box is displayed.



### NOTE

- If you want to cancel the call, press **OK** while dialing.
- If you do not answer the call in 2 minutes, the system will disconnect the call automatically.



## Using Far End Camera Control

If the far site camera has the PTZ function, you can control the far site camera during the call.

1. Connect to the far site.
2. Press **FAR** on the remote control.
3. You can control far site camera by pressing **CAM ZOOM +**, **CAM ZOOM -** and Arrow buttons.

## Using Far End Camera Preset

If the far site camera has the PTZ function or another video source, you can use the preset function.

1. Connect to the far site.
2. Press **PRESET** on the remote control.
3. Press  on remote control and select a video source.
4. Move the cursor to the number you want to save.
5. Press  on the remote control.
6. Control the far site camera to the location as you want.
7. Press . Then you will be able to save the location at that number.

- You can control the far site camera to the saved location by selecting the saved number.

## Using SnapShot

You can save entry on directory with the far site user screen picture.

- Connect to the far site.
- Press  on the remote control.  
"Snapshot of Far side is saved" is displayed on the screen.

### NOTE

- You can confirm this snapshot information in the Call History.
- You can save entry with this snapshot information in the My Contact list.

## Using the Web Service

You can perform the same configuration from the web interface that is available from the unit. The web interface contains additional features that cannot be configured on the unit. You can also update the system, upload certification, import or export address book in the web service.

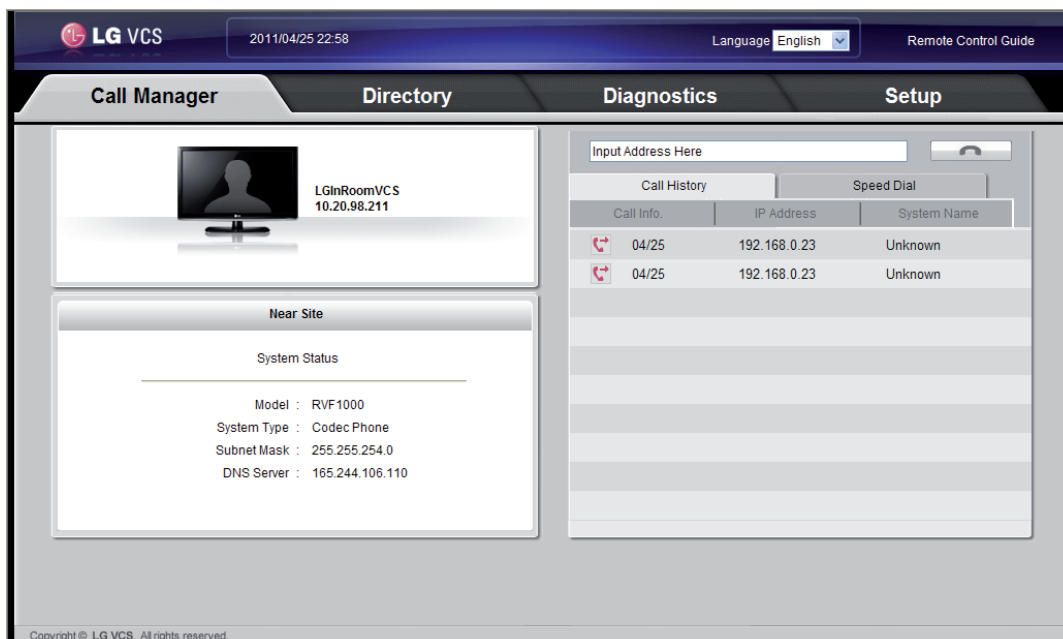

## Upgrading your System Software

To upgrade the software for your system, follow these steps:

- Start the web browser.  
The recommended browser is Internet Explorer with Windows.
- In the Address Box, enter "HTTP://" and the IP Address of the VCS.  
You can use the Host Name that you entered in the DDNS setup menu of the VCS.
- Press ENTER on the keyboard and then the LG VCS web viewer will be displayed.
- Select the [Setup] tab and enter the Administrator setup menu.
- Select the [Management] option.
- Click [Upgrade] of the [System Update] option.
- Click [Browse].
- Find and open the firmware file.
- Click [OK]. The system upgrade status bar is displayed.
- After upgrading is complete, a confirmation window will be displayed.



Click [OK] and the system will be rebooted.

## Uploading the Certification File

1. Follow steps 1-5 described in “Upgrading your System Software”.
2. Click [Upload] of the [Upload Certificate] option.
3. Click [Browse].
4. Find and open the certificate file.
5. Click [OK].

## Importing or Exporting the Address Book

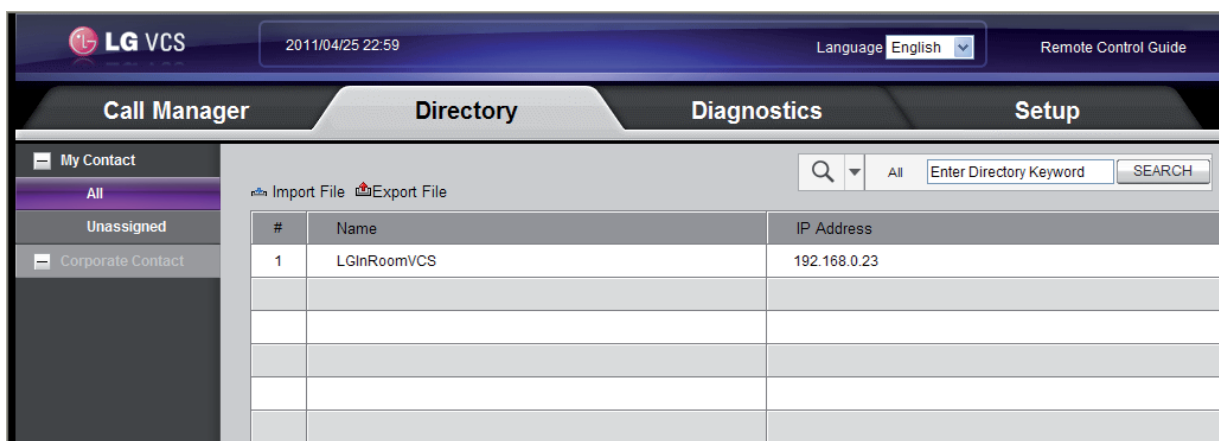

### Exporting the Address Book

1. Follow steps 1-3 described in “Upgrading your System Software”.
2. Select the [Directory] tab.
3. Click the [Export File] menu. The exporting window is displayed.
4. Click [Save].
5. Select the folder and modify the export file name.
6. Click [Save].

### Importing the Address Book

1. Follow steps 1-3 described in “Upgrading your System Software”.
2. Select the [Directory] tab.
3. Click the [Import File] menu. The Import CSV File window is displayed.
4. Find and open the address book file and then click [OK]. The imported address will be added and you can see the added address on the list.

# 5 Appendix

## Troubleshooting

Symptoms	Resolutions
The system power does not turn on.	Check the power cable is connected correctly.
	Check the input voltage is correct.
	Check the main power switch is turned on.
	If the system power does not turn on even if the power cable is connected correctly, please contact the service center.
The system power is turned on but no video data is displayed on the monitor.	Check the input mode of the monitor.
	Unplug the power cable and plug in again.
The subject is not clear enough to see.	Adjust the camera brightness and white balance in User > Video tab
The remote control is not working.	Check the batteries.
	Make sure that the battery polarity are connected with (+) and (-) matched correctly.
	Check the remote control contains two AAA batteries that are in good working condition.
	Verify whether objects are obstructing the sensor on the front of the camera.
	Check that the camera cable is connected correctly on device when you use the remote control. You can confirm camera connection status as camera icon in main screen
The image is not visible.	Check that the camera cable is connected correctly on device. You can confirm camera connection status as camera icon in main screen.
The sound is not audible.	Muffled audio reception from the far side may be caused by highly reverberant rooms.
	If you are experiencing poor audio reception, add more sound absorbency to the room and speak in close proximity to the microphone.
	Ensure both ends are not muted. Verify that the audio out cables are properly connected to the monitor and that any external speaker systems are powered and configured correctly. Also check your Audio Out setting on your audio device (headset, HDMI, built-in speaker).
	Make sure your Audio Out preference in User > Audio for your sound device. If you are unable to hear the ringer when an incoming call arrives, adjust the ring tone preference in User > Audio
The system does not work with the remote control.	Reboot the system that is not responding to commands from the remote control.
Video or audio are poor.	After connecting to a call, if audio or video do not display normally, users can attempt to connect after the codec box is set to low bandwidth.

You hear a distinct echo.	<p><b>If You Use HDMI TV or Monitor</b></p> <ul style="list-style-type: none"> <li>Adjust the volume of the HDMI TV or monitor so that it is not too loud.</li> <li>Adjust that camera or Mic location is not too close to the HDMI TV or monitor (approximately 1 m or more).</li> <li>Run the Audio out test at the [System info &gt; Audio/Video] menu.</li> </ul> <p><b>If You Use the Built-in Speaker</b></p> <ul style="list-style-type: none"> <li>Adjust the volume of the codec (built-in speaker) sound not too large.</li> <li>Adjust the camera or Mic location so that it is not too close to the codec box with the built-in speaker (approximately 1 m or more).</li> </ul> <p><b>If You Use External Speakers</b></p> <ul style="list-style-type: none"> <li>Adjust the volume of the external speakers so that they are not too loud.</li> <li>Adjust that camera or Mic location is not too close on External speaker (approximately 1 m or more).</li> </ul>
You cannot make a call.	<p>If a call does not successfully connect, verify that you have dialed a working number and that the far end destination is powered on and available. Verify that the network is ready and available. Network status is indicated at all times on the main screen.</p> <p>You can confirm that you can connect from your local IP to remote site IP by using the ping function in the Network utility.</p> <p>You confirm that you are using proper call protocol (H.323 or SIP). If you set H.323 or SIP about outgoing protocol, the far site device must be set to the same protocol like near site.</p> <p>If you can't solve this problem, please contact the service center.</p>
Severe freezes and broken video during call.	<ul style="list-style-type: none"> <li>Try to call using lower video bitrate (e.g. Setup &gt; Admin &gt; Call &gt; General &gt; Maximum Bandwidth (default 1024 kbps)).</li> <li>Check with each site's IP operators that your video UDP traffic is NOT being blocked by IPS (Intrusion Protection System).</li> <li>Check the remote user's VCS video capability. <ul style="list-style-type: none"> <li>What video resolution is supported: HD 720p, SD 720x480</li> <li>What video codec is supported: H.264, H.263</li> </ul> </li> </ul>
Can't see the PC screen after I press [CONTENT].	<ul style="list-style-type: none"> <li>Check that the D-sub cable is connected properly between the PC and the VCS system.</li> <li>Check that the PC's video out resolution is properly selected (e.g. 640x480, 800x600, 1024x768 and 1280x768).</li> <li>Make sure that you let out the video out correctly on your PC (e.g. Fn + F7 or dual monitor setting).</li> </ul>
The PC screen is shifted after [CONTENT] has been pressed.	<p>Check that the D-sub cable is connected properly between the PC and the VCS system.</p> <ul style="list-style-type: none"> <li>Change the D-sub cable.</li> </ul>
I can't access the web server.	<ul style="list-style-type: none"> <li>Check your VCS device's network accessibility. <ol style="list-style-type: none"> <li>Check the IP address, subnet, and gateway for typos when using a static IP.</li> <li>Check that the IP address is correctly shown on the OSD using DHCP IP.</li> <li>Connect a different PC to the same network and try to ping to your VCS IP address (e.g. ping 10.177.217.22).</li> </ol> </li> <li>Try to disable / enable the web server menu via Setup. <ol style="list-style-type: none"> <li>Go to Setup &gt; Admin &gt; Network &gt; Service &gt; Web Server.</li> <li>Set Off and exit from setup.</li> <li>Go back to the Web Server setting, set to On and return to the main screen or try to turn the power off then back on again.</li> </ol> </li> </ul>
The remote user is not able to hear your voice.	<ul style="list-style-type: none"> <li>Check microphone status (see page 24).</li> <li>If you select Ext. Microphone in Setup &gt; User &gt; Audio option, check that the Ext. Microphone is connected properly.</li> </ul>
The current input video of the local camera displays the flickering image.	<p>Use Camera Exposure function to match your lighting conditions in [User&gt;Video&gt; Camera Exposure] menu.</p>

## Open Source Software Notice

The following GPL executables and LGPL libraries used in this product are subject to the GPL2.0/ LGPL2.1 License Agreements:

GPL EXECUTABLES: Linux kernel 2.6, bash, busybox, dhcpcd, mtd-utils, net-tools, procps, sysutils, openldap, openssh, lighttpd, php, sqlite, net-snmp-5.2.5.1

LGPL LIBRARIES: uClibc, DirectFB, iconv, cairo, gnutls, libcrypto, libgpg-err, libusb.

<http://www.gnu.org/licenses/old-licenses/gpl-2.0.html> and <http://www.gnu.org/licenses/oldlicenses/lgpl-2.1.html>.

Also you can obtain a copy of gSOAP public license from <http://www.cs.fsu.edu/~engelen/license.html>.

This software is based in part on the work of the Independent JPEG Group copyright © 1991 - 1998, Thomas G. Lane.

This product includes

- Freetype library : copyright © 2003 The FreeType Project ([www.freetype.org](http://www.freetype.org)).
- Libpng library : copyright © 2004 Glenn Randers-Pehrson
- Zlib compression library: Copyright © 1995-2002 Jean-loup Gailly and Mark Adler.
- Expat library : copyright © 2006 expat maintainers.
- OpenSSL library :
  - cryptographic software written by Eric Young ([eay@cryptsoft.com](mailto:eay@cryptsoft.com)).
  - software written by Tim Hudson ([tjh@cryptsoft.com](mailto:tjh@cryptsoft.com)).
  - software developed by the OpenSSL Project for use in the OpenSSL Toolkit. (<http://www.openssl.org>)
- libcurl library : Copyright © 1996 - 2008, Daniel Stenberg, [daniel@haxx.se](mailto:daniel@haxx.se)
- Libpcap

This product includes other open source software.

- Copyright © David L. Mills 1992-2006
- Copyright © 1998-2003 Daniel Veillard.
- Copyright © 1998, 1999 Thai Open Source Software Center Ltd.
- Copyright © 1990 The Regents of the University of California.
- Copyright © 1998-2005 The OpenSSL Project.
- Copyright © 1991, 1992 Paul Kranenburg <[pk@cs.few.eur.nl](mailto:pk@cs.few.eur.nl)>
- Copyright © 1993 Branko Lankester <[branko@hacktic.nl](mailto:branko@hacktic.nl)>
- Copyright © 1993 Ulrich Pegelow <[pegelow@moorea.uni-muenster.de](mailto:pegelow@moorea.uni-muenster.de)>
- Copyright © 1995, 1996 Michael Elizabeth Chastain <[mec@duracef.shout.net](mailto:mec@duracef.shout.net)>
- Copyright © 1993, 1994, 1995, 1996 Rick Sladkey <[jrs@world.std.com](mailto:jrs@world.std.com)>
- Copyright © 1999, 2000 Wichert Akkerman <[wakkerma@debian.org](mailto:wakkerma@debian.org)>

All rights reserved.

Permission is hereby granted, free of charge, to any person obtaining a copy of this software and associated documentation files (the "Software"), to deal in the Software without restriction, including without limitation the rights to use, copy, modify, merge, publish, distribute, sublicense, and/or sell copies of the Software, and to permit persons to whom the Software is furnished to do so, subject to the following conditions:

THE SOFTWARE IS PROVIDED "AS IS", WITHOUT WARRANTY OF ANY KIND, EXPRESS OR IMPLIED, INCLUDING BUT NOT LIMITED TO THE WARRANTIES OF MERCHANTABILITY, FITNESS FOR A PARTICULAR PURPOSE AND NONINFRINGEMENT. IN NO EVENT SHALL THE AUTHORS OR COPYRIGHT HOLDERS BE LIABLE FOR ANY CLAIM, DAMAGES OR OTHER LIABILITY, WHETHER IN AN ACTION OF CONTRACT, TORT OR OTHERWISE, ARISING FROM, OUT OF OR IN CONNECTION WITH THE SOFTWARE OR THE USE OR OTHER DEALINGS IN THE SOFTWARE.

## Specifications

ITEM		Specification
System	In/Out Port	Audio Input (1 x Headset In)
		Audio Output (1 x Headset Output)
		Camera Input (1 x HD Camera, Microphone In)
		D-Sub Video In (1 x VGA )
		HDMI Video Out (1 x HDMI - 480P, 720P)
		LAN Port :1 x RJ-45, 10/100 Mbps
		Power (1 x DC Input - 12 V, 5 A)
Communications		H.323, SIP
Camera	Camera	Wide-angle lens with 65.4 degree field of view
		Fixed focus with range from 400 mm to infinity
	Image Device	6.08 mm Color CMOS
	Effective Pixels	1 M Pixels
	Lens	4.0 mm Fixed lens
	Resolution	1280 x720p @ 30 fps
	Extra Functions	Built-in IR Receiver
	Microphone	Built-in Microphone
Power	DC 5 V	
MicPod	Microphone Type	Electret condenser microphone, omni directional type
	Operating Temperature	-40 °C to 85 °C
	Sensitivity	-30 dB ± 3
	SNR	58 dB ( 1 kHz at 1 Pa )
	Frequency Range	50 Hz to 22 kHz
	Cable Spec	Thickness : 2 mm, Length : 5 meters
	Case Type	Cylinder type
	Case Diameter	103.4 mm (Maximum 106.70 mm)
	Case Thickness	19.50 mm
	Case Total Weight	130 g
Video Stream	Resolution	Progressive Scan
		30 Frame/Sec
		Maximum resolutions 720p
	Standards	H.263, H.264

Audio	Features	Built-in Ring tone
		Full duplex for natural conversations
		Echo cancellation for echo-free calls
		Automatic noise reduction
		Automatic gain control
Standards	G.711, G.722, G.722.1, G.722.1C, G.728, G.729	
Speaker	2 Watt (Mono)	
Other Supported Standards		H.323, H.224, H.281 H.225, H.245, H.241, H.460
		SIP (RFC 3261), RFC 3262, RFC 3264, RFC 4566, RFC 3407, RFC 2976, RFC 3311, RFC 4028, RFC 2190, RFC 2833, RFC 3984, RFC 4587, RFC 5459
User Interface & Features		Easy User Interface
		Graphical User Interface Call Manager
		Snapshot / Thumbnail display
		Multiple languages supported
		Do Not Disturb mode
Security		Secure password authentication
		Ability to disable HTTP services
		H.235 (AES) encryption support including strict compliance
		SNMP security alerts
		Ability to disable HTTP, SSH and Telnet services
		TLS support
		IEEE 802.1x support
Intelligent Network Features	Network	Far-End Camera Control (H.224/H.281)
		AES (FIPS197, H.235)
		NAT / Firewall Client (H.460.17/18/19)
	QOS	IP Precedence
		DiffServ (Differentiated Service)
		Lost Packet Recovery
		Dynamic bandwidth allocation
Directory and Address Book		Up to 1000 local directory entries
		Save, Remove Redial List features
		Missed call notification
		LDAP support / H.350 compliant
System Management		Web-based system management
		Network Time Protocol (NTP)
		Firmware Upgrade via Web

Power		AC Voltage 100-240 V, 50/60 Hz, 1.5 A via external power supply
Environmental Data	Operating Temperature	0 °C (32 °F) to 40 °C (104 °F)
	Operating Humidity	15 % to 85 %, non-condensing
	Storage Temperature	-20 °C (-4 °F) to 60 °C (140 °F)
	Storage Humidity	10 % to 90 %, non-condensing
Camera Dimensions	Width	106 mm
	Depth (φ)	106 mm
	Height	64 mm (folded), 90 mm
	Weight	270 g
Codec Dimensions	Width	142 mm
	Depth	220 mm
	Height	37 mm
	Weight	630 g

