



**MODEL:** GC-309BV  
GC-309BUU  
GC-309BVS  
GC-379BA  
GC-379BUU

---

## **REFRIGERATOR OPERATION MANUAL**

Please read the manual carefully before using the refrigerator. After reading the manual, please keep it for reference when necessary.

# CONTENT

NAME OF PARTS .....	2
MOVEMENT & TRANSPORTATION.....	3
EARTH CONNECTION .....	3
INSTALLATION.....	4
SAFETY GUARDS.....	5
HOW TO USE.....	7
BEST WAYS TO STORE FOOD.....	9
WAYS TO DISASSEMBLE SPARE PARTS.....	11
TO REVERSE THE DOORS(OPTION).....	12-13
CLEANING THE REFRIGERATOR.....	14
DOES THE REFRIGERATOR HAVE A MALFUNCTION.....	15
THIS IS NOT A MALFUNCTION.....	16
APPENDIX.....	17

# NAME OF PARTS

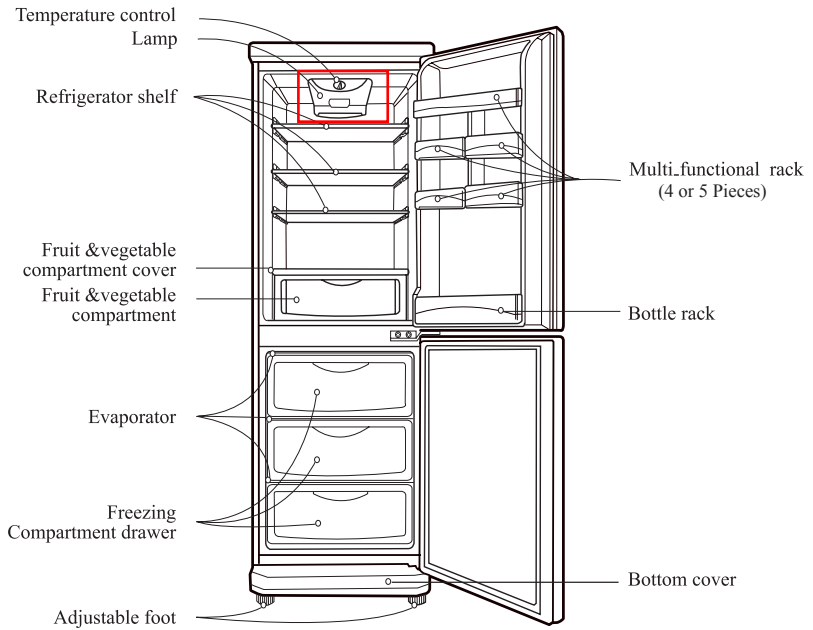

Note: The figure is only for reference

## MOVEMENT & TRANSPORTATION

### ● BEFORE TRANSPORTATION

1. Remove all the food from the refrigerator, secure the spare parts such as the shelves by adhesive tape.
2. Fasten the adjustable foot to the  direction.

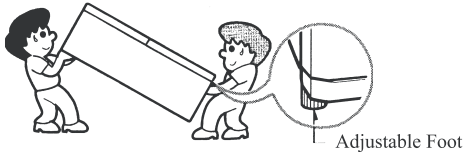

### ● DURING TRANSPORTATION

1. Hold tightly the adjustable foot at the bottom of the refrigerator and the upper handle at the back.
2. During transportation, please note that the refrigerator should not be tilted.
3. When transporting to a more distant place, the refrigerator should be placed vertically on the vehicle. (Otherwise problem will exist)

Note: Please fasten the adjustable foot to the  direction before transportation, otherwise the floor will be scraped or the foot will be blocked from moving.

## EARTH CONNECTION

- Note:
1. The earth wire of this electrical appliance has been connected to the power plug, please do not change the power plug on your own.
  2. Plug your refrigerator into a standard 220V household outlet, make sure the socket is properly earthed.
  3. If you receive an electrical shock by touching any part of the refrigerator, you should stop using the refrigerator immediately and contact the specified maintenance service unit or the retail shop of this product at once.

### ACCESSIBILITY OF SUPPLY PLUG

The refrigerator-freezer should be so positioned that the supply plug is accessible for quick disconnection when accident happens.

### POWER CORD REPLACEMENT

If the supply cord is damaged, it must be replaced by a special cord or assembly from the manufacturer or its service agent.

# INSTALLATION

## Installing on a firm and flat surface

- Unstable installation is the main reason of vibration and noise.
- When the refrigerator is installed unstably, it can be stabilised by adjusting the adjustable foot.
- Slightly rising the front part of the refrigerator allow you to close the door very easily.
- When installed on a carpet or floor, please put a firm mat under the refrigerator otherwise the bottom part will change colour.

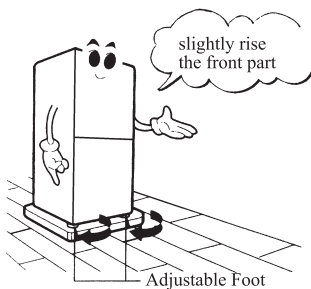

## Keep an appropriate distance between the wall

- To ensure proper air circulation around the fridge-freezer, please maintain sufficient space on both the sides as well as top and maintain at least 2 inches (5 cm) from the rear wall.
- A small gap will restrict the operation of the refrigerator, which may result in an increase in power.

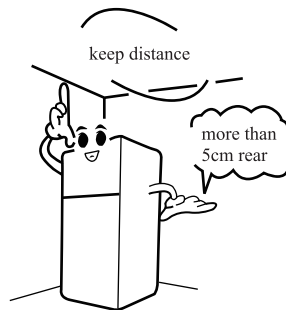

## Installing in a less humid environment

- Do not install the refrigerator in a humid place or where water can easily be splashed.
- If the refrigerator is installed in a humid environment, it will go moldy. This will lower insulation property and cause electricity leakage.

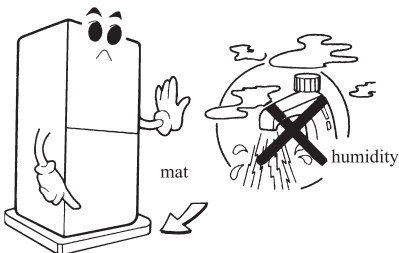

## Avoid installing near heat and gas

- High temperature will lower the refrigeration and increase the power consumption.
- Installing near gas or smoke will change the surface colour of the refrigerator.

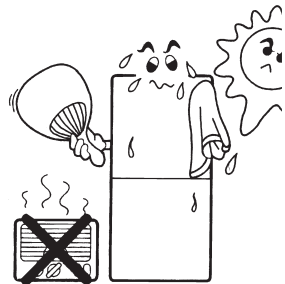

# SAFETY GUARDS

● **Please use the exclusive power socket.**

- If the refrigerator uses the same power socket as other electrical appliances, the socket could be overloaded abnormally and fire may be resulted, which may cause a fire.



● **Please unplug the refrigerator before changing the light bulb.**

- Changing the light bulb as the refrigerator is operating may cause an electric shock.



● **Please note that the back of the refrigerator should not touch the power plug.**

- The power plug being pressed could be easily damaged and this may cause fire or electric shock.

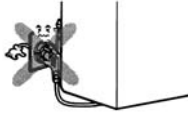

● **Please do not put heavy things on top of the refrigerator.**

- When you open the door, the heavy things could easily fall down and hurt you.



● **Please unplug the refrigerator first before cleaning. Do not do this with wet hands.**

- This may probably cause electric shock.



● **Please do not climb on the door.**

- The refrigerator could be turned over and hurt small children.

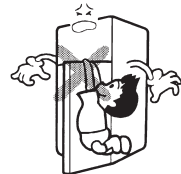

● **Please do not store flammable things like ether, benzene, alcohol and liquefied gas in the refrigerator.**

- Flammable things like ether, benzene, alcohol and liquefied gas may cause fire.

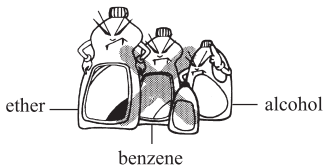

● **Please do not store medicine or academic information in the refrigerator.**

- Things which require strict temperature control should not be stored in the refrigerator, otherwise they will go bad or produce accidental effect.



# SAFETY GUARDS

- Please keep away from fire.  
- Can cause fire.

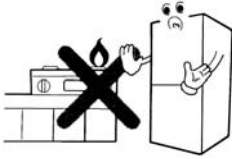

- In case of a gas leak, please do not touch the refrigerator and the power socket, you should open the windows and the door for ventilation.  
- As a spark may cause an explosion and lead to fire.



- Please do not place water container such as vases, glasses, cosmetic or medicine on top of the refrigerator.  
- Liquid spilt over the refrigerator will reduce the insulation effect, and may cause an electric shock or fire.



- Please do not store bottles in the freezing compartment.  
- As bottles in the freezing compartment, liquid inside will be frozen and the bottle will break.



- Please do not install in a humid place or where water can easily be splashed.  
- This will reduce the insulation effect and may cause an electric shock.

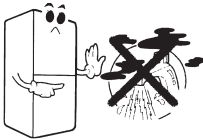

- Please unplug the refrigerator if it is not to be used for a long time.  
- Reduced insulation may cause an electric shock or fire.



- During transportation, please hold the adjustable feet at the bottom of the refrigerator and the upper handle at the back.  
- Otherwise, the refrigerator may fall down.

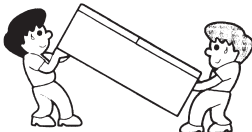

- When the refrigerator is unplugged, please wait for five minutes before you plug it again.  
- Otherwise the compressor will be overloaded.

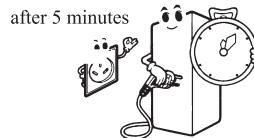

# HOW TO USE

## Initial operation

- Clean the inner part of the refrigerator before using.
- Do not put foods into the refrigerator until it has been plugged in for 3 hours.

## Temperature control

- The thermostat used for controlling the temperature inside the refrigerator is located on the top of the refrigerator.
- The figure on the thermostat does not stand for a practical value. The smaller the figure is, the higher the temperature inside the refrigerator is.
- Temperature control

Position	Function
0	Stop
1-2	Warm
3-4	Normal
5-6	Cold
7	Quick freezing

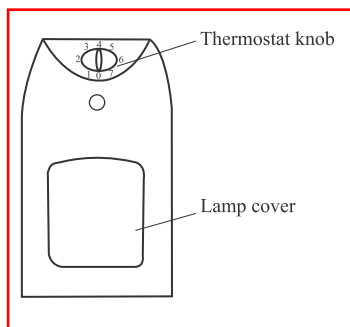

## \* Power failure

If power failure is known in advance, please

- Turn the thermostat to "7" two hours before power failure.
- Place more ice cubes in the refrigerator compartment.
- Do not place anymore food in the refrigerator.
- Do not open the door more than necessary.

## Note

- Power failure leads to the rising of the freezing compartment's temperature, this may shorten the storage of foods and decline the quality.
- If the power supply is off for too long, be sure to get rid of any water or ice underside the drawer of the freezing compartment before reconnection of the power supply, so as to avoid the foods and the ice freezing together.



# HOW TO USE

## Defrost

As the refrigerator operates, the moisture from foods or in the air may be frosted on to the inner part of the refrigerator and the surface of evaporator. Too thick frost will affect the operation of the refrigerator, so regularly defrosting is necessary. Usually, defrosting is necessary when the thickness reaches 5 mm.

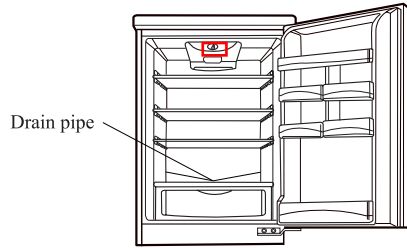

### ● Refrigerator compartment

Defrosts automatically, moisture on the inner side runs into the drip tray through the drain pipe. The heat generated by compressor evaporates the water automatically.

### Note:

- keep the drain pipe straight so that water can in pour into the drip tray. When it's blocked,take out the drain cover,clean it and then replace it.

## Freezing compartment

Before defrosting—turn the thermostat knob to "0",open the door,take out foods and drawers in the freezing compartment,foods may be put into refrigerator compartment temporarily.

Defrosting—remove the frost on the inner side of the freezing compartment and on the surface of the evaporator with the ice scraper,then wipe off the water with a dry cloth.

After defrost—turn the thermostat knob to the former position.

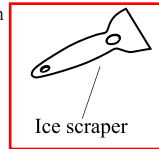

## Ice making

- Fill the ice tray with water to 4/5 of its capacity and place it into the freezing compartment,turn the thermostat knob to "6".
- Twist the both sides of the ice tray so as to remove the ice cubes easily.

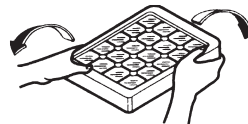

# BEST WAYS TO STORE FOOD

## Refrigerator compartment

The refrigerator compartment is used to store foods that are not required to be frozen, the storage life is shorter.

The following foods storage position is provided for your reference.

- ①②③ position: egg、 butter etc.
- ④⑤ position: cheese、 can、 sauce etc.
- ⑥ position: beverage、 bottled food etc.
- ⑦ position: can、 sweetmeat etc.
- ⑧ position: bread、 can、 milk etc.
- ⑨ position: acid milk、 sausage、 meat、 fish etc.
- ⑩ position: vegetable、 fruit etc.

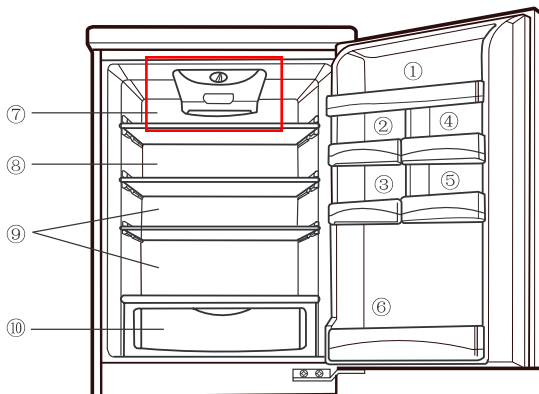

## Freezing compartment

The freezing compartment is used to store frozen foods, the storage life is longer.

# BEST WAYS TO STORE FOOD

## Storing the food

- **Store foods which are easily frozen on the outer position of the refrigerator shelf.**

- If foods which are easily frozen or contain a lot water are stored on the inner part of the refrigerator shelf, it will be frozen owing to low temperature.

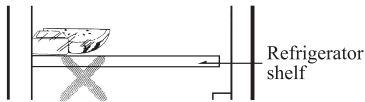

- **Store the foods or other things after cleaning and wiping.**

- Store vegetables and fruits after cleaning and wiping. Packed food like bottle should be stored after wiping to avoid polluting the other foods.



- **Storing the heated food after cooling.**

- Storing the heated food directly in the refrigerator will affect the other foods inside and will also waste the power.

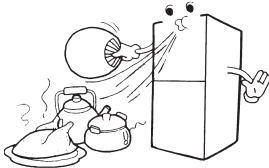

- **In the low temperature mode, do not store the food which can easily be rotten for a long time.**



- **Store food after packing or putting into tight container.**

- Packing the food before storing can prevent drying. This can also reduce odour when storing the food for a longer time.

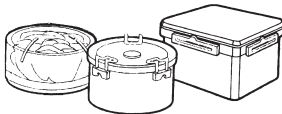

- **Do not store bottles in the Freezing Compartment.**

- If bottles are stored in the Freezing compartment, the liquid inside will be frozen and break the bottle.  
- The volume of liquid such as juice or water should not exceed 80% of the container's volume.



# WAYS TO DISASSEMBLE SPARE PARTS

## Refrigerator shelf

Slightly rise the front part of the shelf, then pull outward.

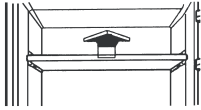

## Refrigerating compartment door rack

Grasp both sides, lift upward and then pull outward.

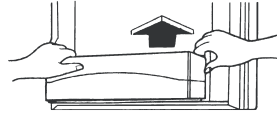

## Freezing compartment drawer

Pull outward. Rise it slightly and then take it out.

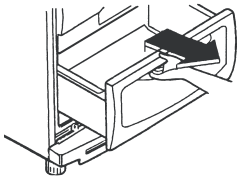

## Bottom cover

Remove the two screws which hold the bottom cover, grasp the both sides and then pull outward.

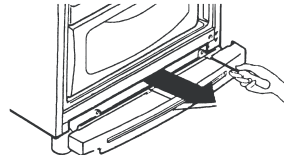

## Lamp

- Lamp data:240V/15W

- Replacement:

1. Unplug the refrigerator.
2. Press the backside of the lamp cover (shown as arrow ①), and pull outward.
3. Remove the faulty lamp and install a new one.
4. Reload the lamp cover.

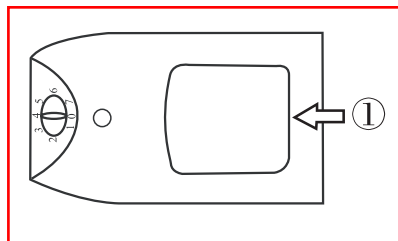

## To Reverse the Doors(Option)

Your fridge-freezer is designed with reversible doors,so that they may open from either the left of right hand side to suit your kitchen design.

### Precaution

1. Before reversing the door,first of all,you should take out food and accessories like shelves or trays which are not fixed the fridge-freezer.
2. Use Torque Wrench or Spanner to fix or remove the bolt.
3. Do not lay the fridge-freezer down. This will cause problem.
4. Be careful not to drop the doors in disassembling or assembling.
5. To avoid the two doors dropping and result in physical injure,at least two persons are require to change the door opening type.

### How to Reverse the Doors

First please operate as the following steps (Figure A):

1. Disassemble the Hinge Middle (1);
2. Remove the Refrigerator Door (2) and the Freezer Door (3) (cooperate with another person);
3. Remove the Top Cover (4);
4. Remove the pin of Hinge Upper Right and assemble it on Hinge Upper Left (5);
5. Remove the Cap Hinge and install it on the corresponding on the right side(6),install the Top Cover(7).
6. Remove the pin of Hinge Lower Right and assemble it on Hinge Lower Left (8);
7. Remove the Cap on the left of the Hinge Middle and install it on the corresponding position(9) on the right side ;
8. Remove the Cap of door and install it on the corresponding position (10) on the right side ;
9. Remove the right limit on the Refrigerator Door and the Freezer Door (11).Take out the spare left limit from the bag with user manual included and install it on the corresponding position of the Refrigerator Door and the Freezer Door.
10. Remove the bush (12) on the corresponding position of the Refrigerator Door and Freezer Door .
11. Install the Refrigerator Door (13) and the Freezer Door (14) (cooperate with another person), fix the Hinge Middle on the left(15).

Then please operate as the following steps (Figure B):

12. Remove the caps on the handle of the Refrigerator Door and the Freezer Door , disassemble the handle;
13. Remove the caps on the Refrigerator Door and the Freezer Door(5).
14. Fix the handles on the other side (7),install the caps on the corresponding locations(8,9);
15. For a Refrigerator with a vertical handle ,please replace the handle to the opposite position.

### Note

Reversing the doors is not covered by the warranty.

# To Reverse the Doors(Optional)

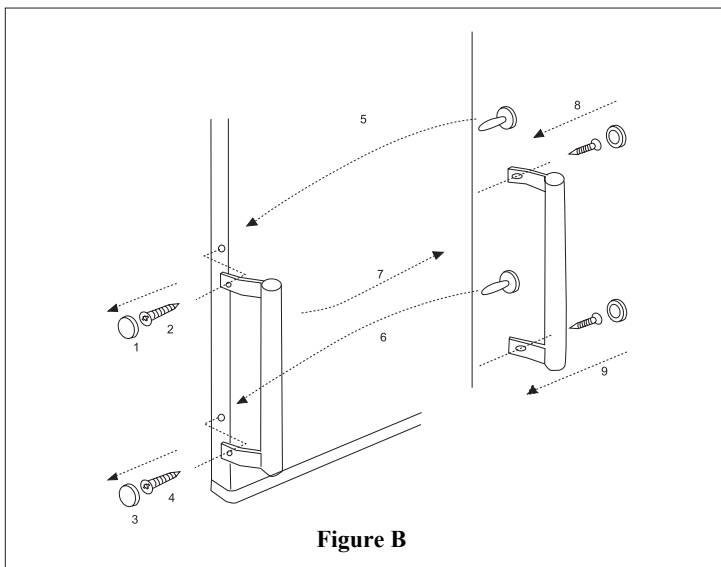
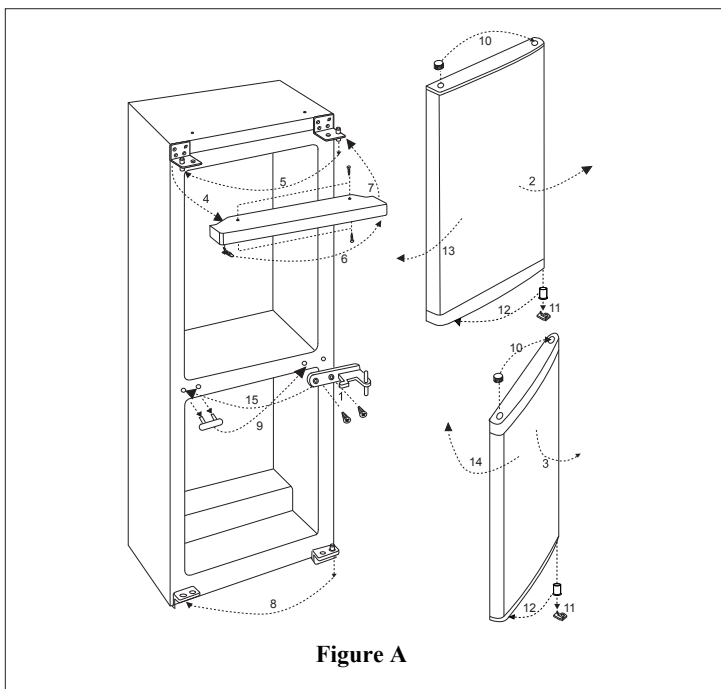

# CLEANING THE REFRIGERATOR

## Before cleaning

- Unplug the refrigerator first to ensure safety.



## Cleaning

### ● Shelf and door rack

- These can easily become dirty. The inside of the refrigerator must be kept clean.



### ● Surface of refrigerator

- Clean it with a soft cloth using a soapy cleanser, then dry with a clean cloth.

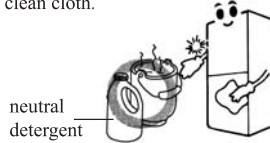

### ● Magnetic door seal

- If the door seal is dirty or covered in juice for a long time, the effectiveness of magnetic door seal will be reduced.
- Regular cleaning is necessary.



### ● Fruit & Vegetable Compartment

- Water can accumulate in this area. Too much water will rot the food, therefore the compartment should be taken out and cleaned regularly.



### ● Do not shower the refrigerator with water

- This will reduce the insulation and cause an electrical shock.



### ● Please do not clean the refrigerator with the following things:

- Cleaning powder, petrol benzene, hydrochloric, boiling water and brush etc. as they will damage the surface of refrigerator. Therefore please do not use them.





### After cleaning please check whether:

- If the wire is damaged.
- If the power plug is not overheating.
- If the power plug is inserted properly.



## DOES THE REFRIGERATOR HAVE A MALFUNCTION?

If the refrigerator still does not work properly after checking the following tasks, please unplug the refrigerator and immediately contact the specified maintenance service unit or the retail shop of this product.

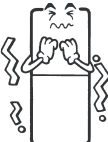
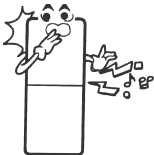
Situation	Please check
<p><b>The refrigerator does not operate</b></p> 	<ul style="list-style-type: none"> <li>➡ Is there a power failure?</li> <li>➡ Is the power plug inserted into the socket?</li> <li>➡ Is it 220-240 V?</li> <li>➡ Does the thermostat knob turn to position "0"?</li> </ul>
<p><b>Inefficient cooling</b></p> 	<ul style="list-style-type: none"> <li>➡ Is the temperature control in the refrigerator compartment turned to too low mode?</li> <li>➡ Is there any direct sunshine or heaters near by?</li> <li>➡ Have you put some heated goods directly into the refrigerator?</li> <li>➡ Have you stored too much food?</li> <li>➡ Have you frequently opened the door of the refrigerator?</li> <li>➡ Have you kept an appropriate distance between the refrigerator and the wall?</li> </ul>
<p><b>Food stored in the refrigerator compartment becomes frozen</b></p> 	<ul style="list-style-type: none"> <li>➡ Is the temperature control in the refrigerator compartment turned to too high mode?</li> <li>➡ Have you put the foods against the inner side?</li> </ul>
<p><b>Too much noise, abnormal sound</b></p> 	<ul style="list-style-type: none"> <li>➡ Is the floor level and hard enough?.</li> <li>➡ Is the back of refrigerator too close to the wall?</li> </ul> <p><b>Note:</b></p> <ul style="list-style-type: none"> <li>➡ The sound may be louder when the refrigerator starts to work or turn off the power.</li> <li>➡ Installing on the floor may produce sound.</li> </ul>



# THIS IS NOT A MALFUNCTION

## ● The refrigerator dew forming on the surface.

- If the refrigerator is installed in a humid environment or if it is raining, there can be dew forming on the surface of the refrigerator. This is because moisture in the air touches the surface of the refrigerator.
- Please wipe it with a clean soft cloth.

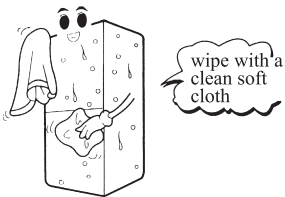

## ● You hear a sound like flowing water.

- It is the sound produced when the compressor stops operating.
- It is the sound of flowing refrigerant in the freezing system.
- Sound can be produced by the contraction and expansion of the parts due to temperature changes inside the refrigerator.

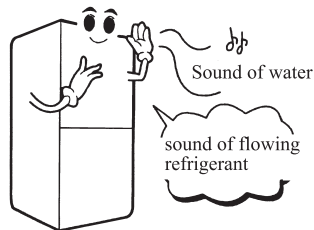

## ● The surface of refrigerator is warm.

- A high temperature pipe which prevents dewing is installed inside the refrigerator when the refrigerator begins to operate or when it is summer, the surface will become warm. Please do not worry because this is a normal effect.

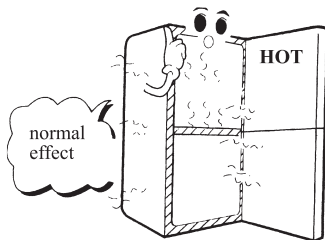

## ● The inner side of refrigerator compartment has dew forming.

- This is because the refrigerator is installed in a humid environment or the door is opened too long.
- Foods with a high water content are not packed well before storing.

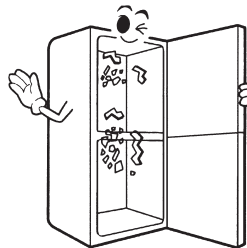

# APPENDIX

Appendix		GC-309BV GC-309BUU GC-309BVS	GC-379BA GC-379BUU
Drawer	Freezing compartment	3pieces	
Shelf	Refrigerating compartment	3pieces	
Wine rack		1piece	
Bottom cover		1piece	
Fruit & vegetable compartment		1piece	
Ice tray		1piece	
Ice scraper		1piece	
Operation manual		1piece	

## Disposal of your old appliance



1. When this crossed-out wheeled bin symbol is attached to a product it means the product is covered by the European Directive 2002/96/EC.
2. All electrical and electronic products should be disposed of separately from the municipal waste stream via designated collection facilities appointed by the government or the local authorities.
3. The correct disposal of your old appliance will help prevent potential negative consequences for the environment and human health.
4. For more detailed information about disposal of your old appliance, please contact your city office, waste disposal service or the shop where you purchased the product.

Information of fluorinated greenhouse gases used as refrigerant of this refrigerator.

Chemical name	Composition of Gases	Total GWP (kg CO <sub>2</sub> -eq)
R-134a	100% HFC-134a	1300

# Warranty Certificate

## For offer a 24-month warranty for this apparatus

During the 24-month warranty period, we will repair your apparatus at no cost to you or make available spare parts to your dealer free, if this apparatus fails due to manufacturing or material defects. Further claims are excluded. We are not liable for damages due to acts of providence or damages occurring during transport. The buyer assumes shipping and packaging costs. **Your warranty conditions on the rear also apply!**

Type of apparatus : \_\_\_\_\_

Serial number :

Name of buyer : \_\_\_\_\_

Purchase date : \_\_\_\_\_

Dealer's stamp and signature

## Warranty conditions for refrigerator

1. The warranty period begins on the purchase date and is valid for 24 months. Begin of warranty period is proven if, the buyer submits purchase receipt together with the warranty card, filled in and signed by the seller. The serial number of the product must agree with the number entered onto the warranty card.
2. During the warranty period, we will correct any defects at no cost to you, if it can be proven that these are attributed to manufacturing or material defects.
3. Damages due to incorrect handling, non-compliance with instructions for use and normal wear are not covered by this warranty. Also, the warranty does not cover wear parts or easily broken parts (for example, viewing glass, light bulbs). The buyer is responsible for any damages during transport as well as shipping and packaging costs.
4. We decide whether to make repairs, exchange or replace parts. Exchanged or replaced parts are our property. The original warranty period is not prolonged if a refrigerator is repaired or certain parts are replaced.
5. The warranty is nullified if any person intervenes in the apparatus that are not authorised by LG Electronics, if the apparatus is used for commercial purposes.
6. Always keep the original packaging, so that if the apparatus requires servicing, it can be transported without damaging it.
7. If a repair is covered by this warranty, always contact your dealer or an authorised service centre.
8. Further claims are excluded. If parts of these provisions are invalid, they apply in the sense of the wording. The validity of the other provisions is not effected.