

OWNER'S MANUAL

AIR CONDITIONER

Please read this manual carefully before operating your set and retain it for future reference.

TYPE : WALL MOUNTED

Indoor Unit

R18AWN-NC11

R24AWN-NC11

R28AWN-NC11

Outdoor Unit

R18AWN-UC11

R24AWN-UC11

R28AWN-UC11

TIPS FOR SAVING ENERGY

Here are some tips that will help you minimize the power consumption when you use the air conditioner. You can use your air conditioner more efficiently by referring to the instructions below:

- Do not cool excessively indoors. This may be harmful for your health and may consume more electricity.
- Block sunlight with blinds or curtains while you are operating the air conditioner.
- Keep doors or windows closed tightly while you are operating the air conditioner.
- Adjust the direction of the air flow vertically or horizontally to circulate indoor air.
- Speed up the fan to cool or warm indoor air quickly, in a short period of time.
- Open windows regularly for ventilation as the indoor air quality may deteriorate if the air conditioner is used for many hours.
- Clean the air filter once every 2 weeks. Dust and impurities collected in the air filter may block the air flow or weaken the cooling / dehumidifying functions.

For your records

Staple your receipt to this page in case you need it to prove the date of purchase or for warranty purposes. Write the model number and the serial number here:

Model number : _____

Serial number : _____

You can find them on a label on the side of each unit.

Dealer's name : _____

Date of purchase : _____

IMPORTANT SAFETY INSTRUCTIONS

READ ALL INSTRUCTIONS BEFORE USING THE APPLIANCE.

Always comply with the following precautions to avoid dangerous situations and ensure peak performance of your product

WARNING

It can result in serious injury or death when the directions are ignored

CAUTION

It can result in minor injury or product damage when the directions are ignored

WARNING

- Installation or repairs made by unqualified persons can result in hazards to you and others.
- Installation **MUST** conform with local building codes or, in the absence of local codes, with the Nation Electrical Code NFPA 70/ANSI C1-1003 or current edition and Canadian Electrical Code Part1 CSA C.22.1.
- The information contained in the manual is intended for use by a qualified service technician familiar with safety procedures and equipped with the proper tools and test instruments.
- Failure to carefully read and follow all instructions in this manual can result in equipment malfunction, property damage, personal injury and/or death.

Installation

- Use a standard circuit breaker and fuse conforming with the rating of the air conditioner. Failure to do so may result in electric shock or product failure.
- Contact an authorized service center when you install or relocate the air conditioner. Failure to do so may result in serious injury or product failure.
- Always use a power plug and socket with a ground terminal. Failure to do so may result in electric shock or product failure
- Install the panel and the cover of the control box safely. Failure to do so may result in explosion or fire.
- Install a dedicated electric outlet and circuit breaker before you use the air conditioner. Failure to do so may result in electric shock or product failure.
- Use a standard circuit breaker and fuse conforming with the rating of the air conditioner. Failure to do so may result in electric shock or product failure.
- Do not modify or extend the power cable. If the power cable or cord has scratches or skin peeled off or deteriorated then it must be replaced. It may result in fire or electric shock.
- Be cautious when you unpack or install the air conditioner. Failure to do so may result in serious injury or product failure.
- Contact an authorized service center when you install or relocate the air conditioner. Failure to do so may result in serious injury or product failure.
- Do not install the air conditioner on an unstable surface or where there may be a danger of it falling. It may result in death, serious injury, or product failure.

Operation

- Do not let the air conditioner run for a long time when the humidity is very high or when a door or window has been left open. Failure to do so may result in product failure.
- Make sure that the power cord is not pulled or damaged while the air conditioner is operating. Failure to do so may result in fire, electric shock, or product failure.
- Do not place any objects on the power cord. It may result in electric shock or product failure.
- Do not turn on or off the air conditioner by plugging in or unplugging the power plug. It may result in fire or electric shock.
- Do not touch, operate or repair the air conditioner with wet hands. It may result in electric shock or product failure.
- Do not place a heater or other heating appliances near the power cable. It may result in fire, electric shock, or product failure.
- Do not allow water to run into the air conditioner. It may result in explosion or fire.
- Do not leave flammable substances such as gasoline, benzene and thinner near the air conditioner. It may result in explosion or fire.
- Do not use the air conditioner for an extended period of time in a small place without ventilation. Ventilate the place regularly. Failure to do so may result in explosion or fire.
- When there is a gas leak, ventilate sufficiently before using the air conditioner again. Failure to do so may result in explosion or fire.
- Unplug the power plug if there is a noise, smell or smoke coming from the air conditioner. Failure to do so may result in explosion or fire.
- Stop operating and close the window in storm or hurricane. If possible remove the product from the window before hurricane arrives
- Do not touch the electrostatic filter after opening the front grille. Failure to do so may result in electric shock or product failure.
- Contact an authorized service center when the air conditioner is submerged into water due to flooding. Failure to do so may result in explosion or fire.
- Be cautious water could not enter the product
- Make sure to ventilate sufficiently when this air conditioner and a heating appliance such as a heater are used simultaneously. Failure to do so may result in fire, serious injury, or product failure.
- Turn the main power off and unplug the power plug when you clean or repair the air conditioner. Failure to do so may result in death, serious injury, or product failure.
- Unplug the power plug when the air conditioner is not used for an extended period of time. Failure to do so may result in product failure.
- Do not place any objects on the air conditioner. It may result in product failure.

 **CAUTION****Installation**

- Make sure to check if there is a refrigerant leak after you install or repair the air conditioner. Failure to do so may result in product failure.
- Install the drain hose properly for smooth drainage of condensed water. Failure to do so may result in product failure.
- Keep level even when installing the product.
- Install the air conditioner where the noise from the outdoor unit or the exhaust gas will not inconvenience the neighbors. Failure to do so may result in conflict between neighbors.
- When transporting the equipment, there should be at least 2 or more people, or a forklift. It may result in serious injury.
- Do not install the air conditioner where it will be exposed to sea wind (salt spray) directly. It may result in product failure.

Operation

- Do not expose people, animals or plants to the cold or hot wind from the air conditioner. It may result in serious injury.
- Do not use the product for special purposes, such as preserving foods, works of art, etc. It is a consumer air conditioner, not a precision refrigeration system. It may result in death, fire or electric shock.
- Do not block the inlet or outlet of air flow. It may result in explosion or product failure.
- Do not use strong cleaning agents or solvents when you clean the air conditioner, or spray water. Use a smooth cloth. It may result in serious injury or product failure.
- Never touch the metal parts of the air conditioner when you remove the air filter. It may result in serious injury or product failure.
- Do not place any objects on the air conditioner. It may result in product failure.
- Always insert the filter securely after cleaning. Clean the filter every two weeks or more often if necessary.
- Do not insert hands or other objects through the air inlet or outlet while the air conditioner is operating. It may result in electric shock.
- Do not drink the water drained from the air conditioner. It may result in serious health complications.
- Use a sturdy stool or ladder when you clean, maintain or repair the air conditioner at a height. Failure to do so may result in serious injury or product failure.
- Do not mix the batteries for the remote control with other types of batteries or mix new batteries with used batteries. Failure to do so may result in product failure.
- Do not recharge or disassemble the batteries. Failure to do so may result in explosion, fire or serious injury.
- Stop using the remote control if there is a battery fluid leak. If your cloth or skin is exposed to the battery fluid from a leak, wash it off with clean water. Failure to do so may result in serious injury.
- If you swallow the battery fluid from a leak, wash out the inside of your mouth thoroughly and then consult a doctor. Failure to do so may result in serious health complications.

TABLE OF CONTENTS

2 TIPS FOR SAVING ENERGY

3 IMPORTANT SAFETY INSTRUCTIONS

7 BEFORE USE

- 7 Components
- 8 Using the remote control
- 9 How to insert the Batteries
- 9 Wireless Remote Controller Maintenance

10 OPERATING INSTRUCTION

- 10 Operation Mode
- 11 Auto Changeover Operation
- 11 Healthy Dehumidification Operation
- 12 Air Circulation Operation
- 12 Auto Clean Operation
- 12 PLASMA Purification Operation
- 13 Energy-Saving Cooling Mode
- 13 Display lamp on/off function
- 13 Setting the Current Time
- 14 Timer Setting
- 14 To cancel the timer setting
- 14 Sleep Mode Operation
- 15 Horizontal Vane Control
- 15 Vertical Louver Control
- 16 Jet Cool/Heat Operation

17 MAINTENANCE

- 18 Cleaning the air filter
- 18 Cleaning the anti-allergy filter and triple filter
- 18 Cleaning the plasma filter
- 19 Forced operation
- 19 Auto Restart Function

20 TROUBLESHOOTING

- 20 Self-diagnosis function
- 20 Before requesting service

BEFORE USE

Components

Indoor unit

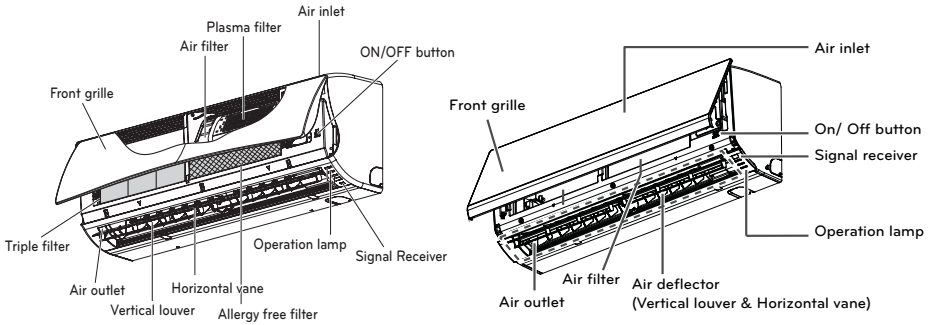

* The feature can be changed according a type of model.

! NOTE

The number of operation lamps and their locations may vary, depending on the model of the air conditioner.

Outdoor unit

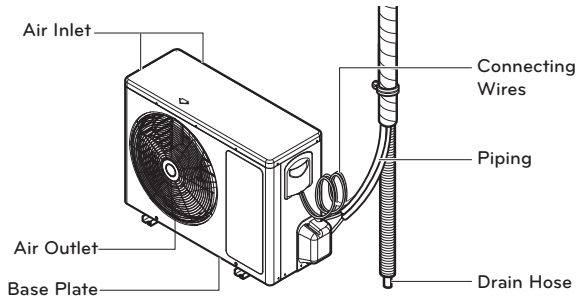

* The feature can be changed according a type of model.

Using the remote control

You can operate the air conditioner more conveniently with the remote control. You will find the buttons for the additional functions under the cover of the remote control.

Wireless remote control

The controls will look like the following.

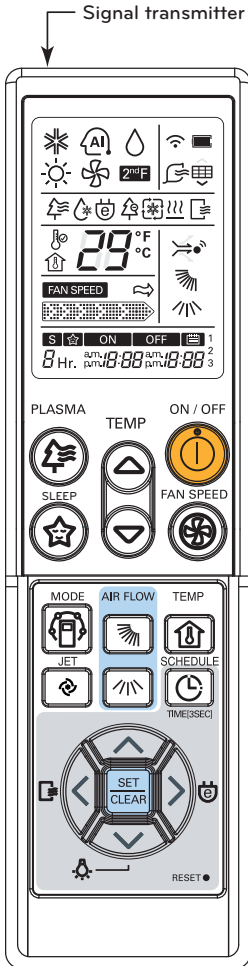

| Control panel | Display screen | Description |
|---------------|-----------------|--|
| | - | On/Off button: Used to turn off/on the unit. |
| | | Plasma button*: Used to start or stop the plasma-purification. |
| | /hr | Sleep mode auto button* : Sets the sleep mode auto operation. |
| | 29 °C | Temperature adjustment buttons: Adjusts the room temperature when cooling and heating. |
| | | Indoor fan speed button: Adjusts the fan speed. |
| | | Operation mode selection button*: Selects the operation mode. Cooling operation (❄️) / Auto operation or auto changeover (AI) / Dehumidifying operation (💧) / Heating operation (🔥) / Air circulation (🌀) |
| | | Jet cooling/heating button*: Warms up or cools down the indoor temperature within a short period of time. |
| | | Air flow direction button: Adjusts the air flow direction vertically. |
| | | Temperature display button: Displays the room temperature. |
| | AM 12:00 ON OFF | Timer button: Sets the current time and the start / end time. |
| | | Navigation and functions button*: Adjusts the time and sets the special functions. : Auto clean / : Operates energy saving cooling |
| | - | Set/clear button: Sets or cancels functions. |
| | - | Reset button : Resets the remote control settings. |

- Some functions may not be supported, depending on the model.

How to insert the Batteries

- 1 Remove the battery cover by pulling it according to the arrow direction.
- 2 Insert new batteries making sure that the (+) and (-) of battery are installed correctly.
- 3 Reattach the cover by sliding it back into position.

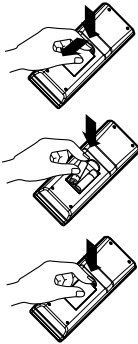

! NOTE

- Always use/replace both batteries of same type.
- If the system is not to be used for a long time, remove the batteries to save their working life.
- If the display screen of remote controller starts, fading replace both of the batteries.
- Use 2 AAA(1.5 volt) batteries.

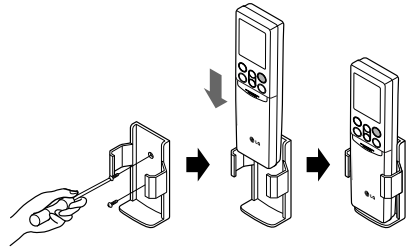

! NOTE

- Remote controller should never be exposed to direct sunlight.
- Signal transmitter & receiver should always be clean for proper communication. Use a soft cloth to clean them.
- In case some other appliances also get operated with remote control, change their position or consult your serviceman.

Operating method

- 1 The signal receiver is inside the unit.
- 2 Aim the remote controller towards the unit to operate it. There should not be any blockage in between.

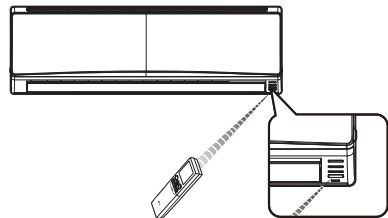

Wireless Remote Controller Maintenance

- 1 Choose a suitable place where its safe & easy to reach.
- 2 Fix the holder to wall etc with the supplied screws firmly.
- 3 Slide the remote controller inside the holder.

OPERATING INSTRUCTION

Operation Mode

- 1 Press the ON/OFF BUTTON to turn the unit on. The unit will respond with a beep.
- 2 Open the cover of the remote controller and press the operation mode button. Each time the button is pressed, the operation mode is shifted in the direction of the arrow.

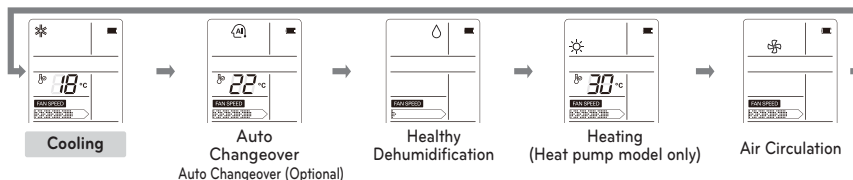

- 2 For cooling or heating operation set the desired indoor temperature by pressing the ROOM TEMPERATURE SETTING BUTTONS.
For cooling the temperature can be set within 18°C~30°C and for heating the temperature range is 16°C~30°C.
- 4 Set the fan speed with the remote controller. You can select the fan speed in six steps : low, medium-low, medium, medium-high, high and natural wind by pressing the INDOOR FAN SPEED SELECTION BUTTON.
Each time the button is pressed, the fan speed mode is shifted in the direction of the arrow.

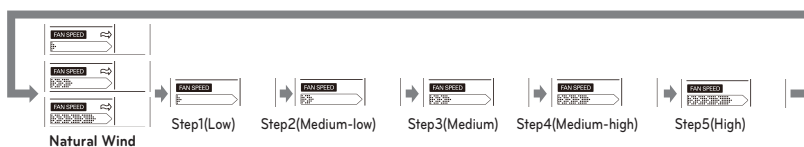

Natural wind

For fresher feeling, press the INDOOR FAN SPEED SELECTION BUTTON and set to Natural wind mode.

In this mode, the wind blows like a natural breeze by automatically changing fan speed.

Auto Changeover Operation

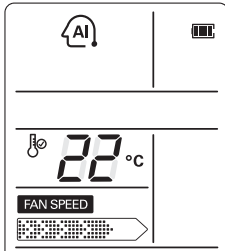

This operation is basically heating or cooling function of the air conditioner. But during this operation the controller changes the operation mode automatically to keep the temperature within $\pm 2^{\circ}\text{C}$ with respect to the setting temperature.

Healthy Dehumidification Operation

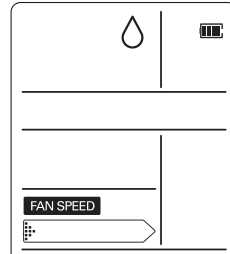

During Healthy Dehumidification Operation

- If you select the dehumidification mode on the OPERATION MODE SELECTION BUTTON, the product starts to run the dehumidification function. It automatically sets the room temperature and air-flow volume to the best condition for dehumidification, based on the sensed current room temperature. In this case, however, the setting temperature is not displayed on the remote controller and you are not able to control the room temperature either.
- During the healthy dehumidification function, the fan speed is automatically set according to the optimization algorithm responding to the current room temperature status, so that the room condition is kept healthy and comfortable even in the very humid season.

Air Circulation Operation

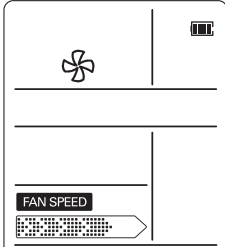

This operation circulates the air without cooling or heating. It can be activated by pressing the OPERATION MODE SELECTION BUTTON. Once the air circulation is activated you can select the fan speed by pressing the INDOOR FAN SPEED SELECTION BUTTON.

! NOTE

During this operation, 'Cooling' lamp lights up.

Auto Clean Operation

During Auto Clean Operation, moistures left in indoor units after cooling operation or healthy dehumidification operation can be removed.

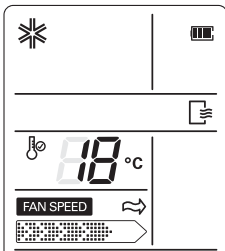

Select Auto Clean Operation by the function setting button().

Now whenever the unit is turned off, the indoor fan is still running for about 30 minutes internally without cooling or dehumidification operation.

This function dries up any remains of moisture & cleans the unit internally. If you push the Auto Clean button again, this function is cancelled.

! NOTE

During Auto Clean function, only ON/OFF button, Plasma button, Auto Clean button is used. During this operation, 'Cooling' lamp lights up.

PLASMA Purification Operation

Plasma filter is a technology developed by LG to get rid of microscopic contaminants in the intake air by generating a plasma of high charge electrons. This plasma kills and destroys the contaminants completely to provide clean and hygienic air.

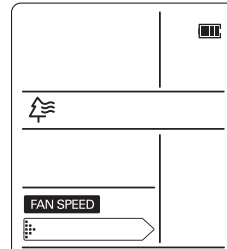

Plasma purification operation can be started by pressing the PLASMA BUTTON on the remote controller. Repeating it will deactivate the operation.

! NOTE

- This features can be used in any operation mode and fan speed by pressing the plasma button.
- Separate plasma purification operation is possible in stop condition. It is cancelled by pressing plasma button or on/off button.

Energy-Saving Cooling Mode

Energy-saving cooling mode can save energy in cooling operation, because it can operate efficiently by setting body-adaptation time according to the change of time and temperature and adjusting desired temperature automatically.

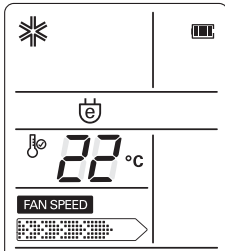

- 1 Press the ON/OFF BUTTON to start the unit.
- 2 Open the cover of the remote controller. Select cooling operation.
- 3 Press the energy-saving cooling mode button.
- 4 To cancel the energy-saving cooling mode, press the Energy-Saving Cooling ModE button again and unit will operate in previous mode(Cooling mode).

Display lamp on/off function

You can turn on/off the display lamp of the indoor unit.

- 1 Press  to turn on/off the lamp on the front grill.

Setting the Current Time

- 1 Press the TIMER BUTTON For 3 seconds.

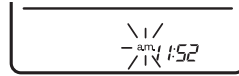





- 2 Press the TIMER SETTING BUTTONS until the desired time is set.
 - The order of a.m. and p.m. -> hour -> minute is repeated whenever you press the < > button.
 - By pressing the ^v button, you can set the current time.
- 3 Press the SET/CLEAR button.

! NOTE

Check the indicator for a.m. and p.m.

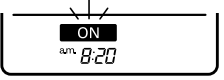
Timer Setting

| Description | Button on the Remote Controller | Indication on the LCD Display |
|--|---|--|
| Press the Timer button once to set on the Reserved 'On' (Press the Timer button twice to set the Reserved 'Off') |  |  |
| Press the Time Setting buttons until the desired time is set. - The order of a.m. and p.m. → hour → minute is repeated whenever you press the < > button. - By pressing the ^ v button, you can set the desired time. |  |  |
| Press the SET/CLEAR BUTTON (Press the SET/CLEAR BUTTON once more to cancel) |  |  |

To cancel the timer setting

- If you wish to cancel all timer setting, press the SET/CLEAR button.
- In order to cancel the timer settings individually, press the Timer button to select Reserved 'On' or Reserved 'Off'. And then press the Set/Clear button aiming the remote controller at the signal receiver. (the timer lamp on the display will go off)

Sleep Mode Operation

Press the SLEEP MODE AUTO BUTTON to set the time when you want the unit to stop automatically. The timer is programmed in one-hour increments by pressing the SLEEP MODE AUTO BUTTON 1 to 7 times. The sleep mode is available for 1 to 7 hours.

NOTE

The sleep mode will operate indoor fan at super low speed in cooling mode and at low speed in heating mode for pleasant sleep.

In cooling mode or healthy dehumidification mode:

The setting temperature will rise automatically two times by 1°C over next consecutive 30 minutes (Maximum 2°C) for a comfortable sleep. This will be the final setting temperature as long as sleep mode is functioning.

Horizontal Vane Control

The Horizontal Vane can be adjusted by using the remote controller.

- 1 Press the ON/OFF button to start the unit.
- 2 Press the vertical airflow direction button. Each time the button is pressed, the air-flow direction is changed in the direction of the arrow.



- ※ Press the Vertical Airflow Direction button once more during Auto Swing at the direction of airflow you want.

Vertical Louver Control

The Vertical Louvers can be adjusted by using the remote controller.

- 1 Press the ON/OFF button to start the unit.
- 2 Press the horizontal airflow direction button. Each time the button is pressed, the airflow direction is changed in the direction of the arrow.



- ※ Press the Horizontal Airflow Direction button once more during Full Auto Swing at the direction of airflow you want.

! NOTE

Manually moving the Horizontal Vane or Vertical Louvers by hand could damage the mechanism. When the unit is shut off, the Horizontal Vane and Vertical Louvers will close the air outlet vent of the product.

Jet Cool/Heat Operation

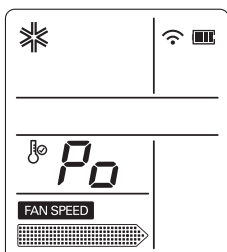

Jet cool function can be used to cool the room quickly in hot summer. When this function is turned on, the air conditioner runs in cooling operation mode with super high fan speed and 18°C setting temperature for 30 minutes for fast and effective cooling.

Similarly, jet heat function (available only in some models) warms up the room quickly by operating at super high fan speed and 30°C setting temperature for 30 minutes.

You can activate this operation by pressing the JET COOL BUTTON.

To change from jet cool mode to high fan speed cooling mode, press the JET COOL BUTTON or INDOOR FAN SPEED SELECTOR BUTTON or the ROOM TEMPERATURE SETTING BUTTON again .

! NOTE

- Jet Cool/Heat operation cannot be activated during Air Circulation operation and auto changeover operation.
- In case of Cooling only model , Jet Cool cannot be activated during Heating.
- In case of Inverter you can use jet heat function by pressing JET COOL BUTTON for heating operation.

MAINTENANCE

Clean the product regularly to maintain optimal performance and to prevent possible breakdown.

* This may not be provided, depending on the model.

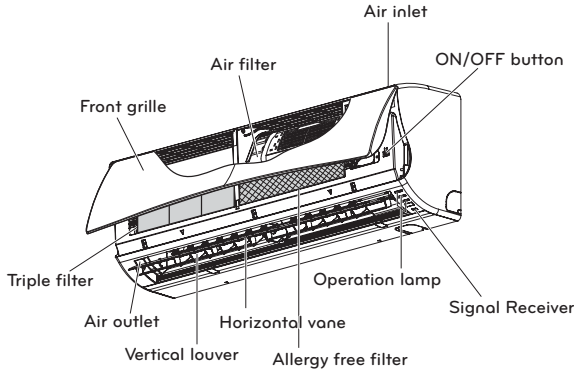

* The feature can be changed according a type of model.

| Item | Cleaning interval | Cleaning method |
|-------------------------------------|-------------------|--|
| Air filter | 2 weeks | See "Cleaning air filter." |
| Anti-allergy filter / Triple filter | 3 months | See "Cleaning anti-allergy filter and triple Filter." |
| Plasma filter* | 3 months | See "Cleaning the plasma filter." |
| Indoor unit surface | Regularly | Use a soft, dry cloth. Do not use bleach or abrasives. |
| Outdoor unit | Regularly | Use steam to clean the heat exchanger coils and the panel vents (consult with technician). |

CAUTION

- Turn off the power and unplug the power cord before you perform any maintenance; otherwise it may cause electric shock.
- Never use water that is hotter than 40°C when you clean the filters. It may cause deformation or discoloration.
- Never use volatile substances when you clean the filters. They may damage the surface of the product.

NOTE

- The location and shape of the filters may differ, depending on the model.
- Make sure to clean the heat exchanger coils of the outdoor unit regularly, as dirt collected in the coils may decrease the operational efficiency or increase energy costs.

Cleaning the air filter

Clean the air filter once every 2 weeks or more if necessary.

- 1 Turn off the power and unplug the power cord.
- 2 Open the front cover.
 - Lift up both sides of the cover slightly.

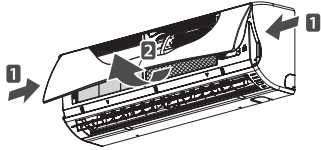

* The feature can be changed according a type of model.

- 3 Hold the knob of the air filter, lift it up slightly and remove it from the unit.

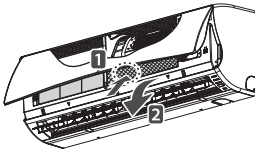

* The feature can be changed according a type of model.

- 4 Clean the filter with a vacuum cleaner or with warm water.
 - If dirt is difficult to remove, wash the filter in lukewarm water with detergent.
- 5 Dry the filter in the shade.

Cleaning the anti-allergy filter and triple filter

- 1 Turn off the power and unplug the power cord.
- 2 Open the front cover and remove the air filter (see "Cleaning air filter").
- 3 Pull out the anti-allergy filter and the triple filter.

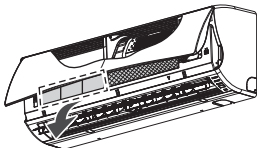

* The feature can be changed according a type of model.

- 4 Dry the filter in direct sunlight for 2 hours.

! NOTE

The location and shape of the filters may differ, depending on the model.

Cleaning the plasma filter

- 1 Turn off the power and unplug the power cord.
- 2 Open the front cover and remove the air filter (see "Cleaning air filter").
- 3 Remove the plasma filter in 10 seconds.

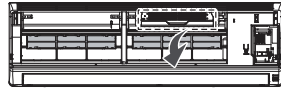

* The feature can be changed according a type of model.

- 4 Use a vacuum cleaner to remove any dirt.
 - If dirt is difficult to remove, wash the filter with lukewarm water.
- 5 Dry the filter in the shade.

! NOTE

- The location of the filters may differ, depending on the model.
- The plasma filter may not be included in some models.
- The feature can be changed according a type of model.

Forced operation

Forced operation is used when the remote controller can't be used. The operation will be started if the ON/OFF button is pressed. If you want to stop the operation, re-press the button.

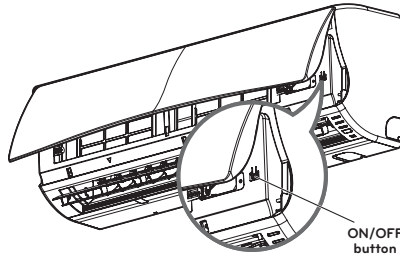

| | Cooling Model | Heat pump Model | | |
|---------------------|---------------|--------------------------------------|--|-----------------------------------|
| | | Room Temp. $\geq 24^{\circ}\text{C}$ | $21^{\circ}\text{C} \leq \text{Room Temp.} < 24^{\circ}\text{C}$ | Room Temp. $< 21^{\circ}\text{C}$ |
| Operating mode | Cooling | Cooling | Healthy Dehumidification | Heating |
| Indoor FAN Speed | High | High | High | High |
| Setting Temperature | 22°C | 22°C | 23°C | 24°C |

Test operation

During the TEST OPERATION, the unit operates in cooling mode at high speed fan, regardless of room temperature and resets in 18 minutes. During test operation, if remote controller signal is received, the unit operates as remote controller sets. If you want to use this operation, Press and hold the ON/OFF button for 3~5 seconds, then the buzzer sound 1 'beep'. If you want to stop the operation, re-press the button.

Auto Restart Function

This function is useful in the situation of power failure. When power regains after a failure this feature restore the previous operating condition and the air conditioner will run in the same settings.

! NOTE

This feature is enabled by factory default setting, but you can disable it by pressing the ON/OFF button for 6 seconds. The unit will beep twice and the lamp will blink 6 times. To enable it, press the button again for 6 seconds. The unit will beep twice and the blue lamp will blink 4 times.

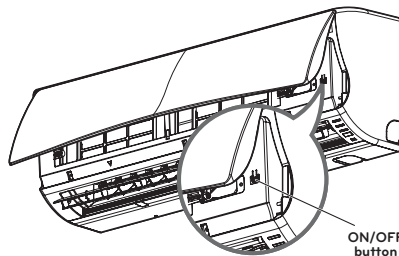

TROUBLESHOOTING

Self-diagnosis function

This product has a built-in self-diagnosis function. If an error occurs, the lamp of the indoor unit will blink in 2 second intervals. If this occurs, contact your local dealer or service center.

Before requesting service

Please check the following before you contact the service center. If the problem persists, contact your local service center.

| Case | Symptoms | Corrective action | Ref. Page |
|---|---|---|-----------|
| Abnormal operating conditions. | There is a burning smell and a strange noise coming from the unit. | Turn off the air conditioner, unplug the power cord and contact the installer who performed the installation. | - |
| | Circuit breaker has frequently been turned off during operation. | Turn off the air conditioner, unplug the power cord and contact the installer who performed the installation. | - |
| | Water leaks from the indoor unit even when the humidity level is low. | Consult the installer who performed the installation. | - |
| The air-conditioner does not start. | Is the air conditioner connected to power? | Check, power cord is plugged or not. | - |
| | Battery setting is wrong in the remote controller. | Is the battery inserted in Remote controller? Is the battery inserted with the correct terminal (+)(-)? Even if you check the upper lists, the air-conditioner does not operate. Please replace new batteries. | 9 |
| The air-conditioner stops during operation. | The air conditioner is suddenly turn off. | The timer function could be operated. If the timer function would operate, the air-conditioner can be turn off. Check the timer setting is correct. | 14 |
| | A power failure has occurred during operation. | There is the Auto Restart Function. It is a default setting. This function can turn on the unit automatically when the power is restored. if you live in frequent power failure area, this function would be useful. | 19 |

| Case | Symptoms | Corrective action | Ref. Page |
|---|---|---|-----------|
| The air conditioner does not generate cool air or warm air. | Air circulation mode is selected. | In the air circulation operation. Air blows from the air conditioner without cooling or heating the indoor air. Switch the air circulation mode to the cooling or heating operation. | 12 |
| | Setting temperature is inappropriate. | If room temperature is close to the set temperature, the conditioning ability of air-conditioner will be slow down fan speed to save energy. Check out that the desired temperature has been set. | 10 |
| | Cool or warm air is escaping from the room. | Close all unnecessary openings such as doors, windows or fireplace dampers. | - |
| | The air filter is blocked by dust or something. | Clean the air filter every 2 weeks. See "Cleaning Air Filter" for more information. | 18 |
| | Room air does not circulate properly. | Make sure that there are no curtains, blinds or furniture blocking in front of the air conditioner. | - |
| The air conditioner does not generate cool air. | There is a heating source inside. | Avoid using a heat generator such as an electric oven or a gas burner while the air conditioner is being operated. | - |
| | Outside temperature is too high. | The cooling effect may not be sufficient. | - |
| The air conditioner does not generate warm air. | When the heating mode is started. Vane is almost closed and air flow does not come out. Even though outdoor unit is already begin to operate. | This symptom is normal. Please wait until the unit is preparing warm air. This function prepare to blow warm air. | - |
| | Defrosting mode is being done in the outdoor unit. | In heating mode, ice/frost is built up on the coils when the outside temperature fall down. This function remove a layer of frost on the coil. Please wait until this operation is completed. It takes about 15 mins. | - |
| | Outside temperature is too low. | The heating effect may not be sufficient. | - |

| Case | Symptoms | Corrective action | Ref. Page |
|---|--|---|-----------|
| Unable to adjust fan speed/set temperature | It is not able to adjust fan-speed. | In jet or dehumidification modes, you cannot adjust the fan speed. If you want to adjust the fan speed, change to another mode. | 16 |
| | It is not able to adjust Room Temperature. | In air circulation, dehumidifying or jet operation mode, you cannot adjust the temperature. If you want to adjust the Temperature, change to another mode. | 11,16 |
| Indoor unit is still operating even when the power is being turned off. | Auto-Clean mode is being operated. This function is to remove the rest of moisture indoor unit. | Please, wait until the end of functions. It will be inhibit a fungal growth. If you do not want this feature, you can turn off to press . | 12 |
| Mist is discharged from the air outlet of the indoor unit. | The cooled air from the air conditioner makes mist. | When the room temperature is down, this phenomenon will disappear. | - |
| Water leaks from the outdoor unit. | In the heating operations, condensed water drop from the heat exchanger. | This symptom need to install drain hose under the base pan. Contact the installer. | - |
| Operating noise or vibration. | <ul style="list-style-type: none"> Clicking sound Clicking sound can be heard either when the unit starts or stops due to movement of reversing valve. Creaking sound The plastic parts of the indoor unit make sound of shrinks and expands due to a sudden temperature change. The water flowing sound, Blowing sound The flow of refrigerant through the air conditioner is switching, noise can be heard. | These are normal symptoms. After a moment, it will be silent. | - |
| The indoor unit gives out odor. | The air smells bad because a musty or cigarettes odor may be absorbed into the indoor unit and discharged with airflow. | <ul style="list-style-type: none"> If the smell does not disappear, you need to wash filter or heat exchanger. Contact the installer. | - |

