



SXS REFRIGERATOR

User's Guide

Please read this guide thoroughly before operating and keep it handy for reference at all times.



Table of contents

| | | | |
|---|--|-------------------|----|
| Introduction | Entry | 3 | |
| | Important safety instruction | 3 | |
| | Important safety instruction | 4 | |
| | Identification of parts | 10 | |
| Installation | Where to install | 11 | |
| | How to replace the water purification filter(Only applies to internal type filter model) | 12 | |
| | Door removal | 13 | |
| | Door replacement | 14 | |
| | Feed water pipe installation | 14 | |
| | when the freezer door is lower than the refrigerator door | 15 | |
| when the refrigerator door is lower than the freezer door | 15 | | |
| Operation | Starting | 16 | |
| | Adjusting the temperatures and functions | 16 | |
| | Refreshment center (Applicable to some models only) | 21 | |
| | Shelf(Applicable to some models only) | 22 | |
| | Wine holder(Applicable to some models only) | 22 | |
| | Egg box(Applicable to some models only) | 22 | |
| | Humidity control in the vegetable compartment | 23 | |
| | Convert into a vegetable or meat compartment(Applicable to some models only) | 23 | |
| | Deodorizer(Applicable to some models only) | 23 | |
| | Miracle Zone Temperature Transition Corner (Applicable to some models only) | 24 | |
| | Temperature Change at Miracle Zone (Applicable to some models only) | 24 | |
| | Miracle Zone (Applicable to some models only) | 24 | |
| | Suggestion on food storage | Location of foods | 25 |
| | | Storing foods | 26 |
| Care and maintenance | How to dismantle parts | 27 | |
| | General information | 29 | |
| | Cleaning | 29 | |
| | Trouble shooting | 30 | |
| | When replacing PANEL | 35 | |

Entry

The model and serial numbers are found on the inner case or back of refrigerator compartment of this unit. These numbers are unique to this unit and not available to others. You should record requested information here and retain this guide as a permanent record of your purchase. Staple your receipt here.

Date of purchase : _____
 Dealer purchased from : _____
 Dealer address : _____
 Dealer phone no. : _____
 Model no. : _____
 Serial no. : _____

Important safety instruction

Before it is used, this refrigerator must be properly installed and located in accordance with the installation instructions in this document.

When moving your appliance away from the wall, be careful not to roll over the power cord or to damage it in any way.

After your refrigerator is in operation, do not touch the cold surfaces in the freezer compartment, particularly when your hands are damp or wet. Skin could adhere to these extremely cold surfaces.

Unplug the power cord from the power outlet for cleaning or other requirements. Never touch it with wet hands because you can get an electric shock or be hurt.

Never place glass products in the freezer because they may be broken due to expansion when their contents are frozen.

Never allow your hands within the ice storage bin of the automatic ice maker. You could be hurt by the operation of the automatic ice maker.

The appliance is not intended for use by young children or infirm persons without supervision.

If possible, connect the refrigerator to its own individual electrical outlet to prevent it and other appliances or household lights from causing an overload that could cause a power outage.

The refrigerator-freezer should be so positioned that the supply plug is accessible for quick disconnection when accident happens.

If the supply cord is damaged, it must be replaced by the manufacturer or its service agent or a similarly qualified person in order to avoid a hazard.



Don't use an extension cord

**Accessibility of Supply Plug
Supply Cord Replacement**

⚠ Important safety instruction

BASIC SAFETY PRECAUTIONS

This guide contains many important safety messages. Always read and obey all safety messages.

⚠ This is the safety alert symbol. It alerts you to safety messages that inform you of hazards that can kill or hurt you or others or cause damage to the product. All safety messages will be preceded by the safety alert symbol and the hazard signal word DANGER, WARNING, or CAUTION. These words mean:

⚠ **DANGER** You will be killed or seriously injured if you don't follow instructions.

⚠ **WARNING** You can be killed or seriously injured if you don't follow instructions.

⚠ **CAUTION** Indicates an imminently hazardous situation which, if not avoided, may result in minor or moderate injury, or product damage only.

All safety messages will identify the hazard, tell you how to reduce the chance of injury, and tell you what can happen if the instructions are not followed.

⚠ WARNING

To reduce the risk of fire, electric shock, or injury to persons when using your product, basic safety precautions should be followed, including the following. Read all instructions before using this appliance.

1. When connecting the power

The dedicated outlet should be used.

- Using several devices at one outlet may cause fire.
- The electric leakage breaker may damage food and the dispenser may be leaked.

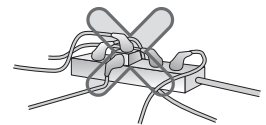

Do not allow the power plug to face upward or to be squeezed at the back of the refrigerator.

Water may be flown into or the plug may be damaged, which causes fire or electric shock.

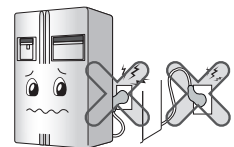

Do not allow the power cord bent or pressed by the heavy object to be damaged.

It may damage the power cord to cause fire or electric shock.



Do not extend or modify the length of the power plug. It causes electric shock or fire by the electric damage of the power cord or others.

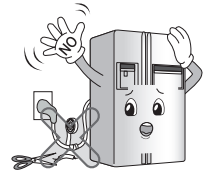

Unplug the power plug when cleaning, handling or replacing the interior lamp of the refrigerator.

- It may cause electric shock or injury.
- When replacing the interior lamp of the refrigerator, make sure that the rubber ring for preventing the electric spark within the socket is not taken off.

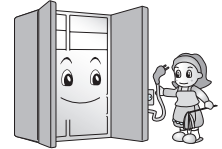

Do not pull out the cord or touch the power plug with wet hands.

- It may cause electric shock or injury.

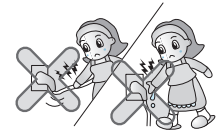

Remove water or dust from the power plug and insert it with the ends of the pins securely connected.

Dust, water or unstable connection may fire or electric shock.

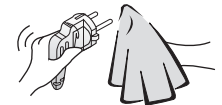

Make sure of grounding.

The incorrect grounding may cause breakdown and electric shock.

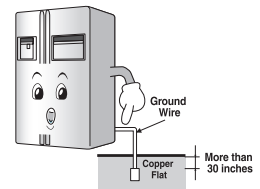

When the power cord or the power plug is damaged or the holes of the outlet are loosed, do not use them.

It may cause electric shock or short circuit to make fire.

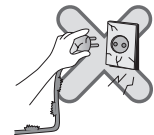

2. When using the refrigerator

Do not place the heavy object or the dangerous object (container with liquid) on the refrigerator.

It may be dropped to cause injury, fire or electric shock when opening or closing the door.



Do not install the refrigerator in the wet place or the place which water or rain splashes.

Deterioration of insulation of electric parts may cause electric leakage.

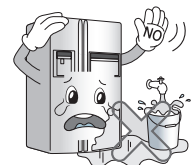

2. When using the refrigerator

Do not cling to the door or the shelves of the door or the home bar of the freezer or the cool chamber.

It may make the refrigerator fallen down or damage the hands. Especially, do not allow the children to do the above.

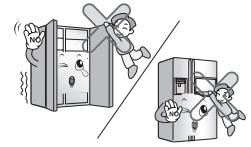

Do not use or store inflammable materials ether, benzene, alcohol, medicine, LP gas, spray or cosmetics near or in the refrigerator.

It may cause explosion or fire.

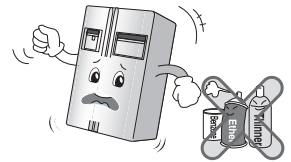

Do not place the lit candle within the refrigerator to deodorize.

It may cause explosion or fire.

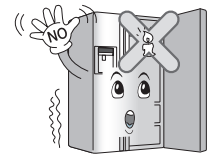

Do not insert the hands into the ice bucket or the ice dispenser.

(only for the model with the dispenser).

Operating the ice maker may cause injury.



Do not store the medicine or the academic materials at the refrigerator.

When the material with the strict temperature control is stored, it may be deteriorated or it may make an unexpected reaction to cause any risk.

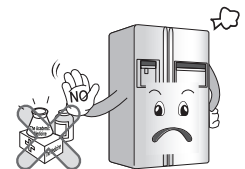

Do not use the combustibile spray near the refrigerator.

It may cause fire.

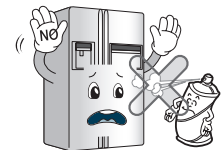

Avoid the heating devices.

It may cause fire.

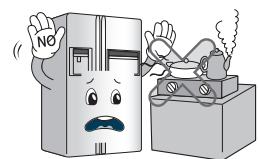

Do not place flower vase, cup, cosmetics, medicine or any container with water on the refrigerator .
It may cause fire, electric shock or injury by dropping down.

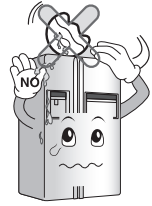

Use the submerged refrigerator after checking it.
It may cause electric shock or fire.

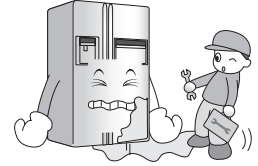

When gas is leaked, do not touch the refrigerator or the outlet and ventilate the room immediately.

- The explosion by spark may cause fire or burn.
- Because this refrigerator uses natural gas (R600a) as the environment-friendly refrigerant, even a small amount (80~90g) is combustible. When the gas is leaked by the severe damage during delivering, installing or using the refrigerator, any spark may cause fire or burn. (Only for the model with the R600a.)

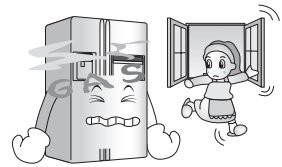

Do not spray water at the outside or the inside of the refrigerator or do not clean it with benzene or thinner.
Deterioration of insulation of electric parts may cause electric shock or fire.

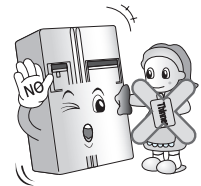

When any strange smell or smoke is detected from the refrigerator, disconnect the power plug immediately and contact to the service center.
It may cause fire.



Do not allow any person except the qualified engineer to disassemble, repair or alter the refrigerator.
It may cause injury, electric shock or fire.

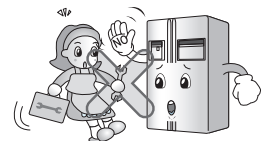

Do not use the refrigerator for non-domestic purpose (storing medicine or testing material, using at the ship, etc. .)

It may cause an unexpected risk such as fire, electric shock, deterioration of stored material or chemical reaction.

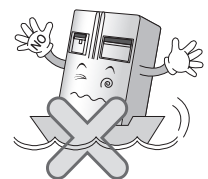

2. When using the refrigerator

When disposing the refrigerator, remove the packing materials from the door.

It may cause to lock out the child.



Install the refrigerator on the solid and level floor.

Installing it on the unstable place may cause death by falling down the refrigerator when opening or closing the door.

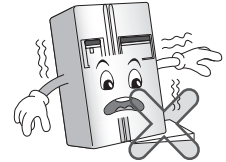

Do not insert the hands or the metal stick into the exit of cool air, the cover, the bottom of the refrigerator, the heatproof grill (exhaust hole) at the backside.

It may cause electric shock or injury.

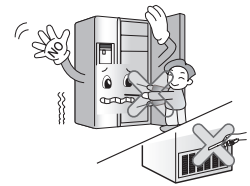

When you want to dispose the refrigerator, contact to the down-block office.

When you want to dispose the large living waste such as electric home appliance and furniture, you'd better contact the local down-block office.

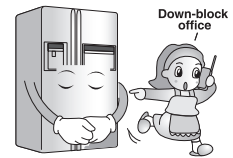

CAUTION

Violating this direction may cause injury or damage house or furniture. Always be careful, please.

Do not touch food or containers at the freezer with wet hands.

It may cause frostbite.

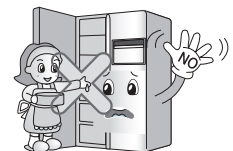

Do not put ice in thin crystal cup or ceramic ware.

It may break cup or ceramic ware to cause injury.

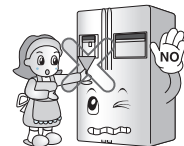

When the electricity is off, remove ice from the ice bucket (only for the model with the dispenser).

The long-time power failure may thaw ice to damage the floor. When the long-time power failure is expected, remove ice from the ice bucket.

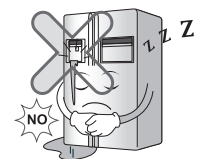

Supply the automatic ice maker with drinkable water only (only for the model with the dispenser).
Otherwise, it may cause any risk.

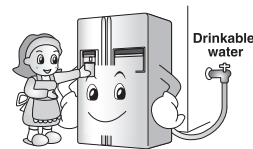

Wait for 5 minutes or longer when reconnecting the plug.
It may cause the operation of the freezer to fail.

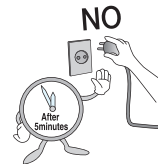

Do not put bottle in the freezer.
It may freeze the contents to break the bottle to cause injury.



Pull out the power plug not by grasping the cord but the plug of its end.
It may cause electric shock or short circuit to fire.



Do not install the refrigerator in the wet place or the place which water or rain splashes.
Deterioration of insulation of electric parts may cause electric leakage.

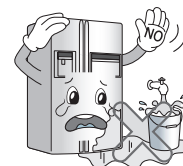

Do not insert the hands into the bottom of the refrigerator.
The iron plate of the bottom may cause injury.



Carry the refrigerator with the handle bar at the bottom of the front and the top of the rear.
Otherwise, your hands may be slipped to cause injury.

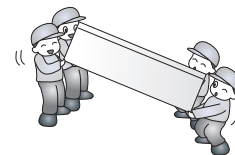

Because opening or closing the door of the refrigerator may cause injury to the person around it, be careful, please.

Opening or closing the door may cause feet or hands to be caught in the chink in door or the child to be get hurt by the corner.

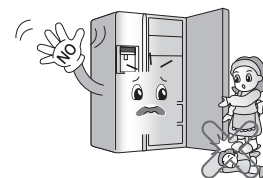

Do not put any living animal in the refrigerator.

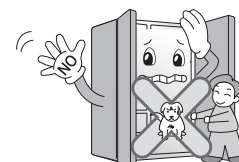

CAUTION

This appliance is not intended for use by persons (including children) with reduced physical, sensory or mental capabilities, or lack of experience and knowledge, unless they have been given supervision or instruction concerning use of the appliance by a person responsible for their safety.

Children should be supervised to ensure that they do not play with the appliance.

Child entrapment warning**DANGER** : Risk of child entrapment.

Before you throw away your old refrigerator or freezer:

Take off the doors but leave the shelves in place so that children may not easily climb inside.

The appliance is not intended for use by young children or infirm persons without supervision.

Young children should be supervised to ensure that they do not play with the appliance.

Don't store

Don't store or use gasoline or other flammable vapor and liquids in the vicinity of this or any other appliance.

Grounding (Earthing)

In the event of an electric short circuit, grounding (earthing) reduces the risk of electric shock by providing an escape wire for the electric current.

In order to prevent possible electric shock, this appliance must be grounded properly. Use of the grounding plug can result in an electric shock. Consult a qualified electrician or service person if the grounding instructions are not completely understood, or if you have doubts on whether the appliance is properly grounded.

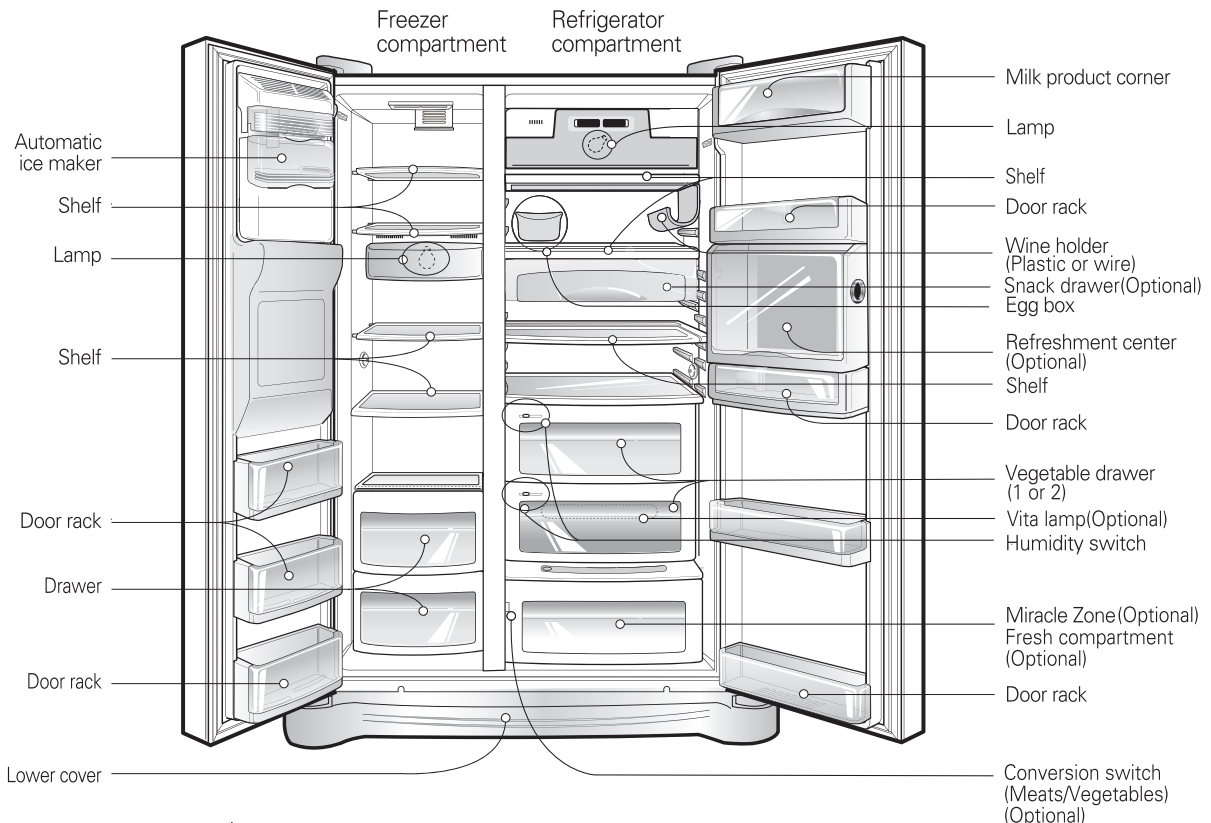
Identification of parts**NOTE**

- If you found some parts missing from your unit, they may be parts only used in other models.

Where to Install

Select a good location

1. Place your appliance where it is easy to use.
2. Avoid placing the unit near heat sources, direct sunlight or moisture.
3. To ensure proper air circulation around the fridge -freezer, please maintain sufficient space on both the sides as well as top and maintain at least 2 inches (5 cm) from the rear wall.
4. To avoid vibrations, the appliance must be leveled.
5. Don't install the appliance below 5°C. It may cause affect the performance.

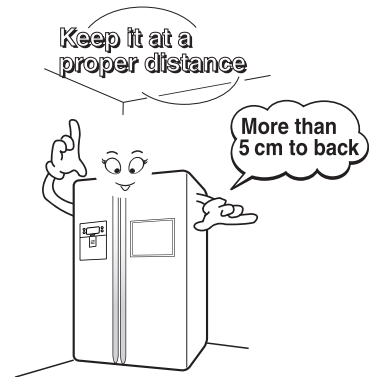

Disposal of the old appliance

This appliance contains fluid (refrigerant, lubricant) and is made of parts and materials which are reusable and/or recyclable.

All the important materials should be sent to the collection center of waste material and can be reused after rework (recycling). For take back, please contact with the local agency.

How to replace the water purification filter (Only applies to internal type filter model.)

Because the water purification filter removes any residual chloride or odor, replace it every 6 months.

1. Separate the shelf and lamp cover.

After locking the feed valve next to the water facet, separate the refrigerator shelf (A) and lamp cover (B).

Insert the tool into the marked area (①) and push the tool to disconnect.

Use the tool with the flat tip such as (-) screw driver.

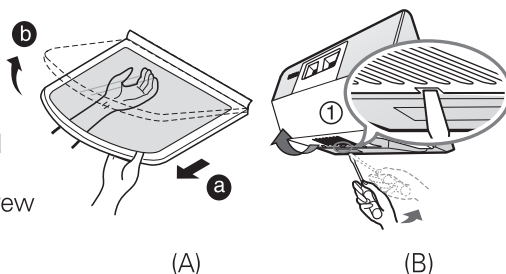

2. Separate the water purification filter.

When first purchased

- Turn the filter replacement cap in counterclockwise direction (①) for 90°.
- Pull the cap (②) out.
- If you are not using the filter, keep the replacement filter in a safe place because you need it.

When replacing during use

- Turn the filter to replace in counterclockwise direction (①) for 90°.
- After aligning the directed line and the loosening label line (②), pull downward (③).
- Put a water bowl slightly larger than the water bowl because water can drip when you separate the water purification filter.

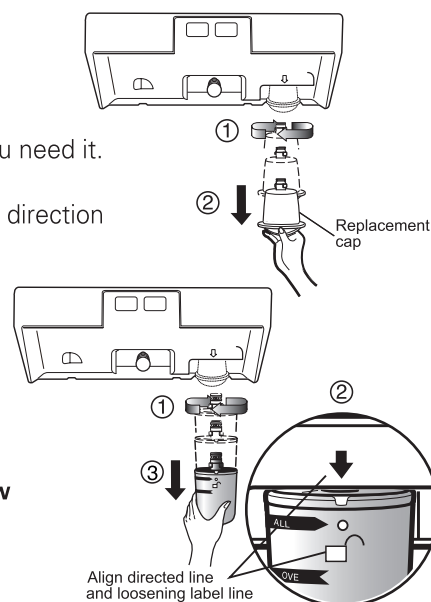

3. Attach an installation date sticker on the new filter and take off the cap.

Ex) When installed in October, attach the '10 OCT' sticker.

- When purchased for the first time, store the separated red cap in the replacement cap.

4. Insert a new filter.

- Align the filter to the directed line on the control box (①) and insert it upward (②).
- Turn clockwise (③) for 90°.
- Check whether the directed line and the lock indicated line are aligned (④).

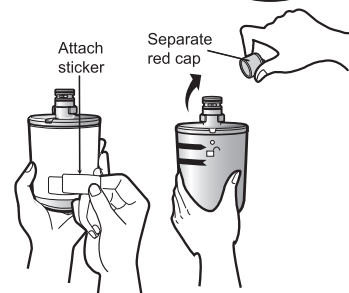

5. Return the lamp cover and shelf back to their original location.

- After returning the lamp cover and refrigerator shelf back to their original locations, loosen the feed valve.
- When you install and replace the filter for the first time, it is good to let the water flow for about 3 minutes (or 1 liter).

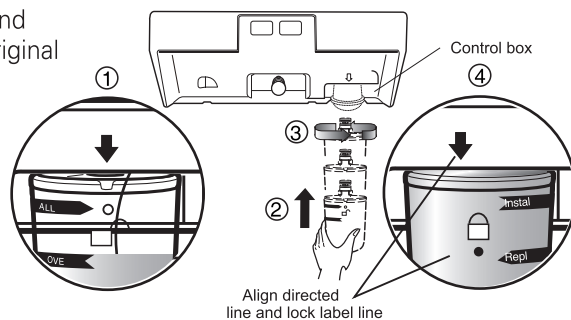

WARNING

Door removal

Electric Shock Hazard

Disconnect electrical supply to refrigerator before installing. Failure to do so could result in death or serious injury.

If your access door is too narrow for the refrigerator to pass through, remove the refrigerator door and pass the refrigerator laterally.

Remove the lower cover by lifting upward, and remove clip ①, and then pull up the feed water tube while pressing area ① shown in the figure to the right.

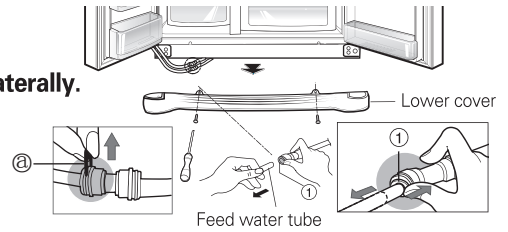

Remove lower cover and then feed water tube

NOTE

- If a tube end is deformed or abraded, cut the part away.

Remove the freezer compartment door

1) Removing the hinge cover by loosening the screws. Separate all connection wires except for the earth line after.

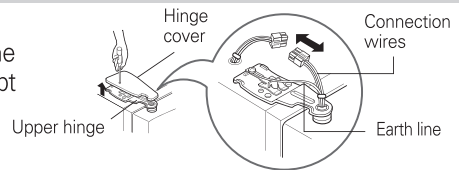

2) Remove the keeper by rotating it counter clockwise (①) and then lifting the upper hinge up (②).

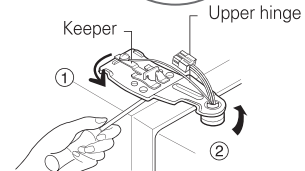

CAUTION

- When removing the upper hinge, be careful that the door does not fall forwards .

3) Remove the freezer compartment door by lifting it upward. This time, the door should be lifted enough for the feed water pipe tube to be completely pulled out.

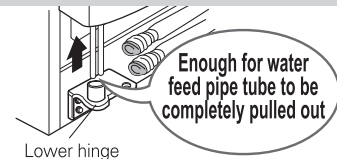

NOTE

- Move the freezer compartment door passing through the access door and lay it down, but be careful not to damage the feed water pipe tube.

Remove the refrigerator door

1) Loosen the hinge cover screws and remove the cover. Remove connection wire, if any, except for the earth line.

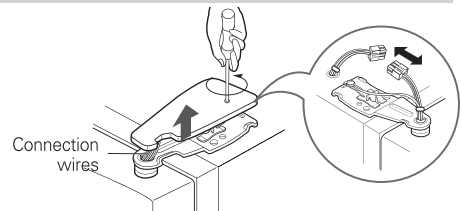

2) Remove keeper by rotating it clockwise (①) and then remove the upper hinge by lifting it up (②).

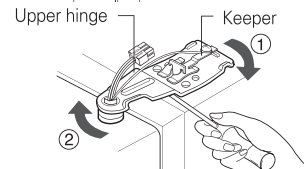

3) Remove the refrigerator compartment door by lifting it up.

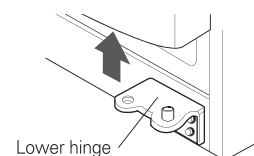

Pass the refrigerator

Pass the refrigerator laterally through the access door as shown in the right figure.

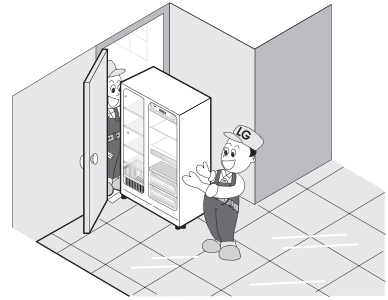
**Door replacement**

Mount them in the reverse sequence of removal after they pass through the access door.

Feed water pipe installation**Before installation**

- Automatic ice maker operation needs water pressure of 147~834 kPa (1.5~8.5 kgf/cm²) (That is, an instant paper cup (180 cc) will be fully filled within 3 sec.).
- If water pressure does not reach the rating 147 kPa (1.5 kgf/cm²) or below, it is necessary to purchase a separate pressure pump for normal automatic icing and cool water feed.
- Keep the total length of the feed water pipe tube within 8 m and be careful for the tube not be bent. If the tube is 8 m or longer it may cause trouble in water feed owing to the drain water pressure.
- Install the feed water pipe tube at a place free from heat.

! WARNING

- Connect to potable water supply only.
- Refer to instructions with water filter kit for installation.

When the freezer door is lower than the refrigerator door

Insert the transparent sheet supplied with the product when the freezer door is lower than the refrigerator door.

- Separate the door with the lower height, use the (+) type screwdriver to unscrew the screw at the bottom hinge as shown at Figure ①, insert the transparent sheet between the bottom hinge and the bottom bracket, and then fix it with the screw as shown at Figure ②.
- Insert more transparent sheets enough to align the height. (4 sheets are supplied in total.)

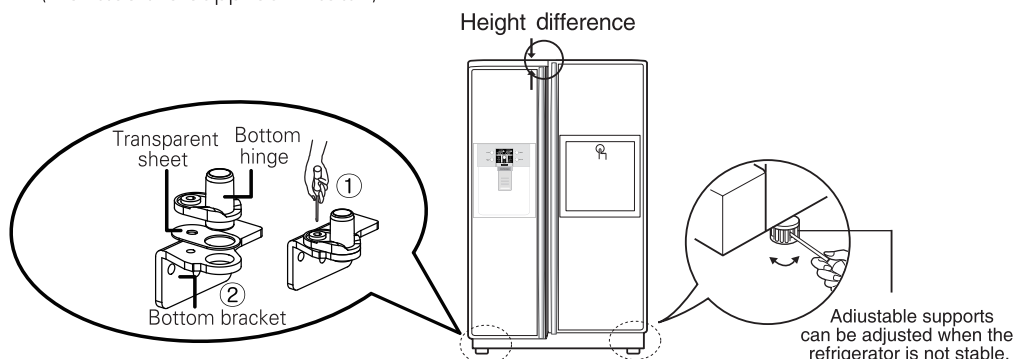

When the refrigerator door is lower than the freezer door

Make adjustments when the refrigerator door is lower than the freezer door while using the refrigerator.

1. Use the wide side of the adjustment tool ③ to rotate the tightening nut ① in clockwise direction to loosen it.
2. Use the narrow side of the adjustment tool ③ to rotate the adjustment hinge pin ② in either clockwise or counterclockwise direction to level the height of the refrigerator to that of the freezer.
3. After leveling the height of the door, rotate the tightening nut in counterclockwise direction to tighten it all the way.

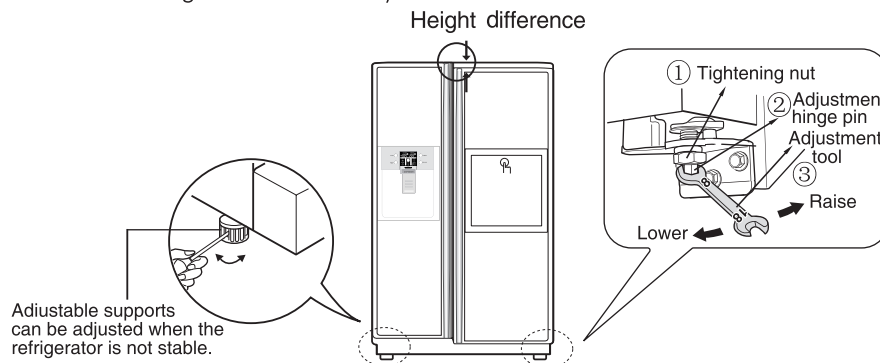

CAUTION

After leveling the door height

Next

Do not adjust the height excessively. You can lose the hinge pin. (Height adjustable range: Maximum of 5mm)

The refrigerator doors will close smoothly by heightening the front side by adjusting the height adjusting screw. If the doors do not close correctly, performance may be

1. Wipe off all dust accumulated during shipping and clean your appliance thoroughly.
2. Install accessories such as the ice cube box, cover evaporating tray, etc., in their proper places. They are packed together to prevent possible damage during shipping.
3. Connect the power supply cord (or plug) to the outlet. Don't double up with other appliances on the same outlet.

Starting

When your refrigerator is first installed, allow it to stabilize at normal operating temperatures for 2-3 hours prior to filling it with fresh or frozen foods. If operation is interrupted, wait 5 minutes before restarting.

Adjusting the temperatures and functions

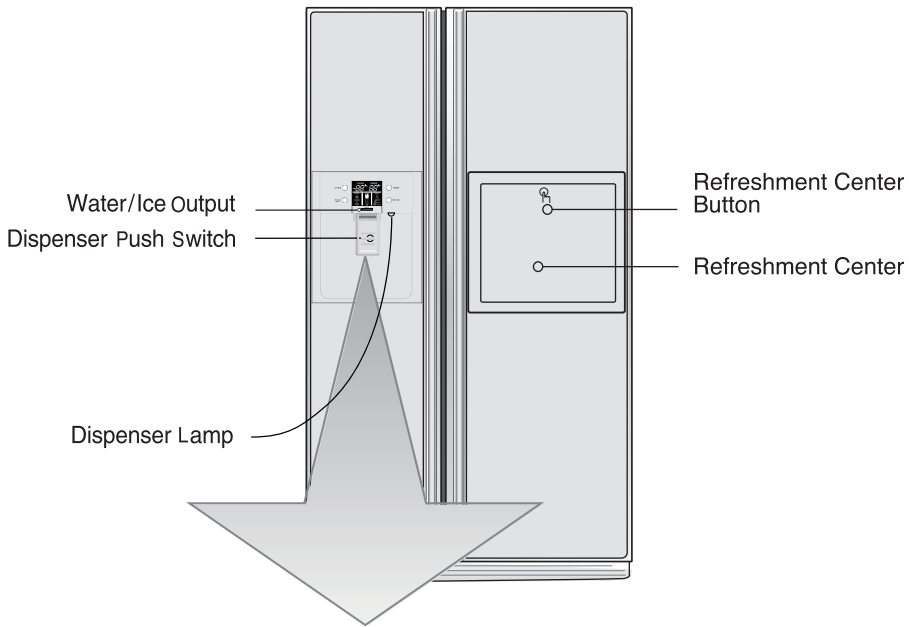

| Optional | Function display board |
|----------------------------|---|
| <p>Type-1 (LED)</p> | <p>FRZ. TEMP. REF. TEMP. -19 °C 3 °C -19 °F 3 °F</p> <p>EXPRESS FRZ. DISPENSER LIGHT CHILD LOCK FILTER STATUS CHILD LOCK 35SECS HOLD 35SECS MONTH</p> <p>DISPENSER</p> <p>Display Power Saving Mode</p> |
| <p>Type-2 (LCD)</p> | <p>FRZ. TEMP. REF. TEMP. -19 °C 3 °C -19 °F 3 °F</p> <p>EXPRESS FRZ. DISPENSER LIGHT CHILD LOCK FILTER STATUS CHILD LOCK 35SECS HOLD 35SECS MONTH</p> <p>DISPENSER</p> |

NOTE

- Your model may not include every option.

Display Power Saving Mode (LED)

This function places the display into power saving mode until the next time the door is opened.

Press the FREEZER and EXPRESS FRZ. buttons simultaneously and hold them for 5 seconds until the Ding sounds. All LED will then turn ON, then OFF. When the power saving mode is activated, the display will remain off until the next time the door is opened. Then, it will come on whenever a door is opened or a button is pressed and remain on for 20 seconds after the last door opening or button selection. To deactivate the power saving mode, press the FREEZER and EXPRESS FRZ. buttons simultaneously and hold them for 5 seconds until the Ding sounds.

You can adjust temperature of and freezer room and refrigerator room.

How to adjust the temperature in the freezer compartment

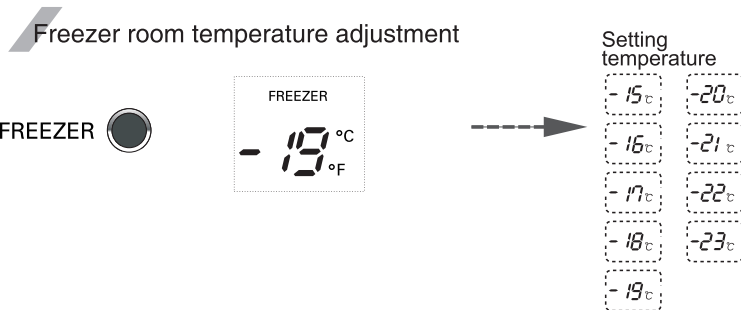

※ Whenever pressing (FREEZER) button, setting is repeated in the order of (-19°C → -20°C → ... → -23°C → -15°C → ... → -19°C).

How to adjust the temperature in the refrigerator compartment

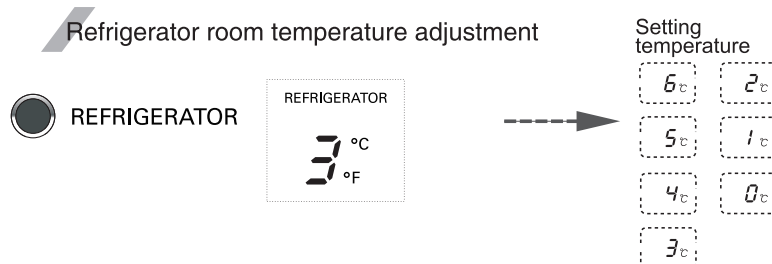

※ Whenever pressing (REFRIGERATOR) button, setting is repeated in the order of (3°C → 2°C → ... → 0°C → 6°C → ... → 3°C).

- The actual inner temperature varies depending on the food status, as the indicated seeing temperature is a target temperature, not actual temperature within refrigerator.
- Refrigeration function is weak in the initial time, Please adjust temperature as above after using refrigerator for minimum 2-3 days.

When ice maker does not operate smoothly

Ice is lumped together

- When ice is lumped together, take the ice lumps out of the ice storage bin, break them into small pieces, and then place them into the ice storage bin again.
- When the ice maker produces too small or lumped together ice, the amount of water supplied to the ice maker need to be adjusted. Contact the service center.
- ✧ If ice is not used frequently, it may lump together.

Power failure

- The ice in ice storage bin may melt and the melt water may flow to the freezer compartment. Take the ice storage bin out and discard all the ice, dry it and the freezer compartment. Then replace back the ice storage bin.

The unit is newly installed

- It takes about 12 hours for a newly installed refrigerator to make ice in the freezer compartment.

Express freezer

Please select this function for prompt freezer.

- OFF → ON → OFF is repeated whenever pressing EXPRESS FRZ. CHILD LOCK 3SECS button.
- The arrow mark graphic remains at the On status after flickering 4 times when selecting Special Refrigeration On.

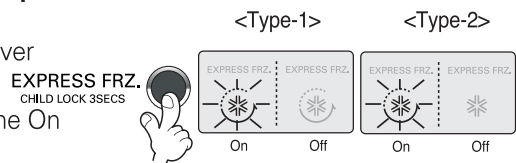

- Prompt freezer function automatically turns off after a fixed time passes.

Lock

This button stops operation of different button.

- Locking or Release is repeated whenever the EXPRESS FRZ. CHILD LOCK 3SECS button is pressed more than 3 seconds.
- When you use the EXPRESS FRZ. CHILD LOCK 3SECS button, you cannot use any other button, until you unlock the unit. When you press the other button when the unit is locked, the Lock button will flash 3 times to notify the current Lock condition.

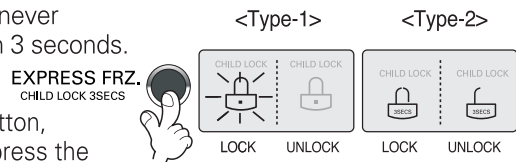

- There is a replacement indicator light for the water filter cartridge on the dispenser.

Filter condition (filter replacement cycle) display function

- The water filter should be replaced every six months.
- The filter light comes on to let you know when to replace filter.

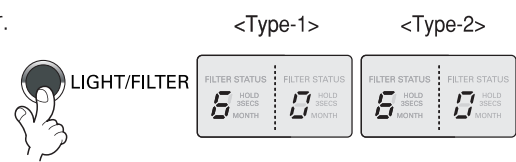

- After replacing the filter, press and hold the filter button more than 3 seconds to reset the indicator.
- Please contact with the local service center if you need to replace filter.

Dispenser light

This button turn the dispenser light in the dispenser on an off.

- The dispenser light function is turned ON or OFF by pressing LIGHT/FILTER button.

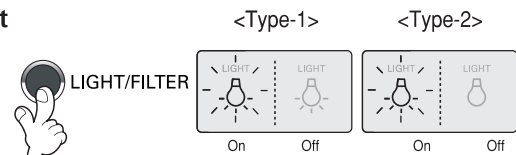

How to use dispenser

- Select one among crushed ice, water, and cubed ice and slightly press the push switch with a glass or other container.

Water

Light the water indicating lamp by pressing the selection button.

- Water will be dispensed by pressing the push switch with a glass.

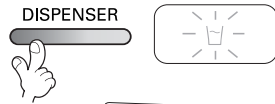

Cubed ice

Light the cubed ice indicating lamp by pressing the selection button.

- Cubed ice will be dispensed by pressing the push switch with a glass.

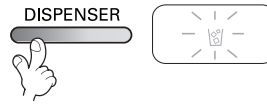

Crushed ice

Light the crushed ice indicating lamp by pressing the selection button.

- Crushed ice will be dispensed by pressing the push switch with a glass.

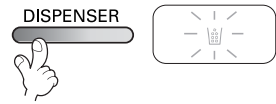

! CAUTION

- The distance between the cup and icemaker outlet should not be too big when collecting ice in order to avoid the ice dropping out of the cup.
- Hold your cup in place for a couple of seconds after dispensing ice or water so the last few drops go in to your cup instead of the floor.

Automatic icemaker

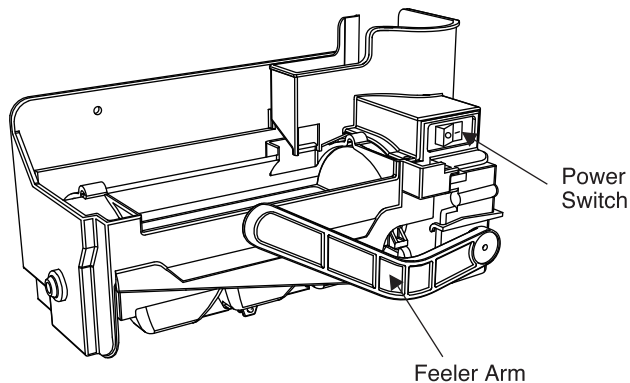

- The automatic icemaker can automatically make 6 cubes at a time, 50~60 pieces per day. This quantity may vary by circumstance, including ambient temperature, door opening, freezer load, etc.
- Icemaking stops when the ice storage bin is full.
- If you don't want to use the automatic icemaker, turn the icemaker switch to OFF. If you want to use automatic icemaker again, change the switch to ON.

NOTE

- It is normal that a noise is produced when ice drops into the ice storage bin.

! WARNING

- Do not insert your hands in to the Icemaker in operation. It may cause to injure you.

The other functions

Door open warning

- 3 times of warning sounds at the interval of 30 seconds if a minute passes with the door of refrigerator and the hombar door opened or completely closed.
- Please contact with the local service center if warning continue to sound even after closing the door.

Diagnosis (failure detection) function

- Diagnosis function automatically detects failure when failure is found in product during the use of refrigerator.
- If failure occurs at product, it does not operate though pressing any button and normal indication is not done. In this case, do not turn power off but immediately contact with the local service center. A lot of time are need for service engineer to detect the failed part if turning it off.

Water is cooled while stored in the water tank in the freezer compartment, and then sent to the dispenser.

Ice is made in the automatic ice maker and sent to the dispenser divided into crushed or cubed form ice.

NOTE

- It is normal that the water is not very cold at first. If you want colder water, add ice into the glass.

How ice/cold water is supplied

CAUTION

Throw away the ice (about 20 pieces) and water (about 7 glasses) first made after refrigerator installation.

The first ice and water may include particles or odor from the feed water pipe or feed water box. This is necessary in case that the refrigerator has not been used for a long time.

Keep children away from the dispenser.

Children may push switch incorrectly bad or damage lamps.

Be careful that food is not block the ice passage.

If foods are placed at the entrance of ice passage, ice may not be dispensed. The ice passage may also be covered with ice powder if splinter ice is used only. This time, remove the ice powder accumulated.

Never store beverage cans or other foods in ice storage bin for the purpose of rapid cooling.

Such actions may damage the automatic ice maker.

Never use thin crystal glass or crockery to collect ice.

Such glasses or containers may be broken.

Put ice first into a glass before filling water or other beverages.

Water may be splashed if ice is added to existing liquid in a glass.

Never touch a hand or other tools on ice outlet.

Touch may cause a part breakage or hand injury.

Never remove the ice maker cover.

Sometimes level the surface so that the ice storage bin is fully filled with ice.

Ice is piled up just near the ice maker. So, such status may be considered, by the ice maker, that the ice storage bin is fully filled and ice making operation may stop.

If discolored ice is dispensed, immediately contact service center, stopping use.

Never use too narrow or deep glass.

Ice may be jammed in ice passage and, thus, the refrigerator may be failed.

Keep the glass at a proper distance from ice outlet.

A glass too close to the outlet may hinder ice from coming out.

If power is cut for long time, please remove the ice in ice storage bin.

When power is cut for long time, the ice in ice storage bin may melt and the melt water may flow out of the refrigeration. And then it may damage the floor. So please remove all the ice in ice storage bin before power is cut off or going out for long time.

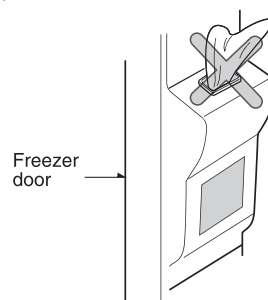

Refreshment center(Applicable to some models only)

How to use

Open the refreshment center door.

- You can access the refreshment center without opening refrigerator door and thus saving electricity.
- Inner lamp is lit in refrigerator compartment when the refreshment center door opens. Thus it is easy to identify the contents.

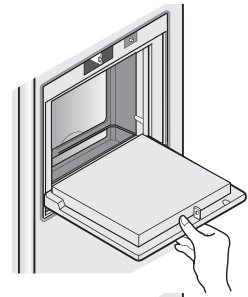

Use the refreshment center door as a stand

- Never use the refreshment center door as a chopping board and take care not to damage it with sharp tools.
- Never rest your arms or severely press on it.

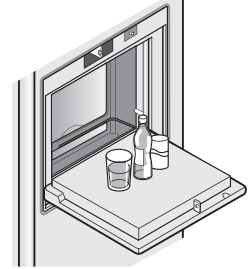

Never take out the inner refreshment center cover

- The refreshment center can not function normally without the cover.

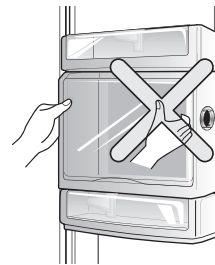

Never place heavy items on the refreshment center door or allow children to hang it on.

- Not only can the refreshment center door may be damaged, but also children may be hurt.

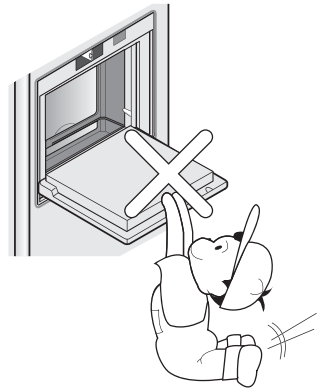

Folding Shelf

Shelf (Applicable to some models only)

You can store taller items such as a gallon container or bottles by simply pushing in front half of shelf underneath back half of shelf. Pull toward you to return to a full shelf.

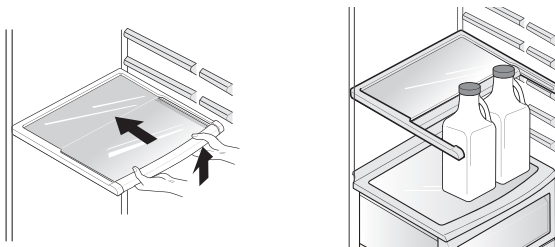

Wine holder adjustment (Type 1)

Wine holder (Applicable to some models only)

Bottles can be stored laterally with this wine corner. This can be attached to any shelf.

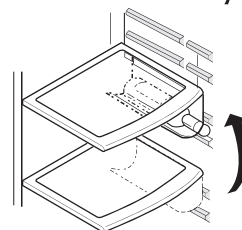

In case of inserting the wine holder :
Pull the wine holder downward as in ② after inserting it into the side anchoring part of the shelf as in ① by catching it upward as in ①.

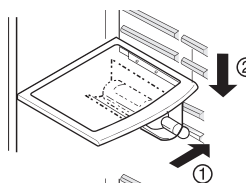

In case of separating the wine holder :
Pull the wine holder inward as in ④ after holding it upward as in ③ by catching it.

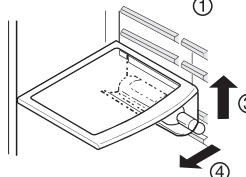

(Type 2)

Bottles can be stored laterally with this wine rack.

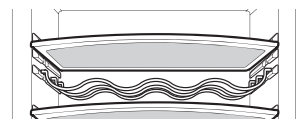

Egg box (Applicable to some models only)

You can move the egg box to wherever you want.

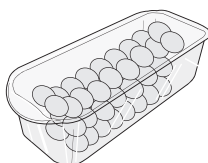

[Type-1]

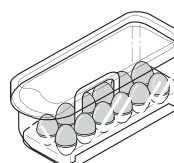

[Type-2]

CAUTION

- Never use the egg box as an ice storage bin. It can be broken.
- Never store the egg box in the freezer compartment or fresh compartment.

Humidity control in the vegetable compartment

The humidity can be controlled by adjusting the humidity control switch to the left/right when storing vegetables or fruits.

High humidity

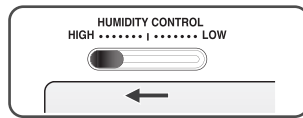

Low humidity

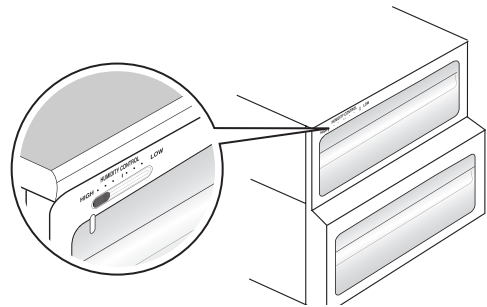
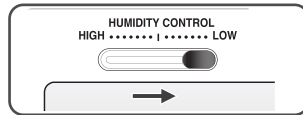

Convert into a vegetable or meat compartment (Applicable to some models only)

- The bottom drawer in the refrigerator can be converted into a vegetable or meat compartment



Vegetable compartment

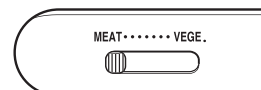

Meat compartment

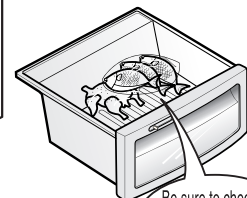
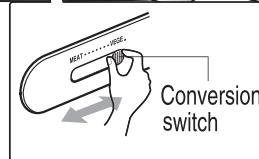

Be sure to check the conversion switch before storing foods

The meat compartment maintains the temperature at a lower point than the refrigerator compartment so that meat or fish can be stored fresh longer.

NOTE

- Vegetables or fruits are frozen if the conversion switch is set to meats compartment. So, be sure to check it before storing foods.

Deodorizer (Applicable to some models only)

This system efficiently absorbs strong odors by using the optical catalyst. This system does not have any effect on stored food.

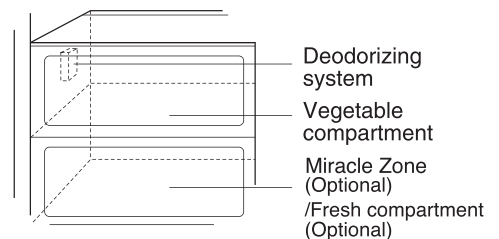

Deodorizing system

Vegetable compartment

Miracle Zone (Optional)

/Fresh compartment (Optional)

How to use the deodorizing system

- Since it is already installed onto the cool air intake duct from the refrigerator compartment, you need no separate installation.
- Please use closed containers to store food with pungent odors. Otherwise, this odor can be absorbed by other food in the compartment.

Miracle Zone Temperature Transition Corner (Applicable to some models only)

By pressing the button, store vegetables, fruits or other types of food such as meat to be defrosted, raw fish, etc.



Temperature Change at Miracle Zone (Applicable to some models only)

Method to Use

You can select optimum temperature range depending on types of foods stored.

- 3-step of temperature selection including -3°C, -1°C and 4°C is available. Vegetables/fruits and cold storage foods requiring humidity maintenance and meats/fishes can be more freshly stored depending on type of foods stored.

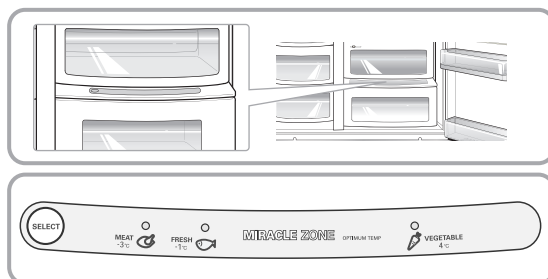

- When using the Miracle Zone as storage room of meats, storing vegetables or fruits may be frozen
- When using the Miracle Zone as storage room of meats, keeping meats or fishes may be spoiled and thus meats or fishes must be kept at the F-room.
- If opening a door of the R-room, lamp turns on in the selected status and lamp turns off if closing it.
- (Vegetable/Fruit) → (Cold storage while maintaining humidity) → (Meat) is sequentially repeated whenever pressing the "Selection" button.

Miracle Zone (Applicable to some models only)

When removing Miracle Zone

- First, remove the vegetable bin.
- After lifting the Miracle Zone case slightly ①, reach inside and pull it outward ② .

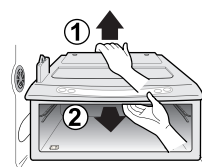





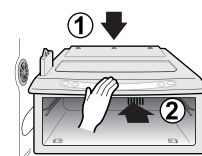

When installing Miracle Zone

- Fit the Miracle Zone case on to the ledge ① and gently slide it in ② .
- When forced, the connecting parts can be damaged.

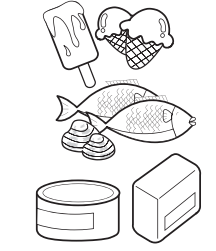

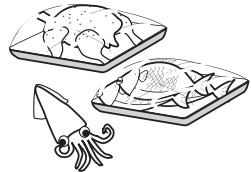
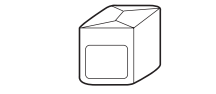
Location of foods

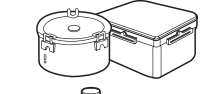
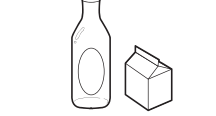
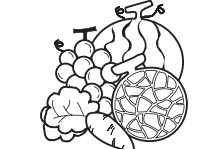
(Refer to identification of parts)

| | | |
|--|---|---|
| Wine holder | Store wine. | |
| Snack drawer | Store small foods such as bread, snacks, etc.. |  |
| Freezer compartment shelf | Store various frozen foods such as meat, fish, ice cream, frozen snacks, etc.. |  |
| Freezer compartment door rack | <ul style="list-style-type: none"> ▪ Store small packed frozen food. ▪ Temperature is likely to increase as door opens. So, do not store long-term food such ice cream, etc.. |  |
| Freezer compartment drawer | <ul style="list-style-type: none"> ▪ Store meat, fish, chicken, etc.. after wrapping them with thin foil. ▪ Store dry. |  |
| Milk product corner | Store milk products such as butter, cheese, etc.. |  |
| Egg box | Place this egg box in the proper location. |  |
| Refreshment center | Store foods of frequent use such as beverage, etc.. |  |
| Refrigerator compartment shelf | Store side dishes or other foods at a proper distance. |  |
| Refrigerator compartment door rack | Store small packed food or beverages such as milk, juice, beer, etc.. |  |
| Vegetable drawer | Store vegetables or fruits. |  |
| Vegetable drawer /meat drawer conversion corner | <p>Store vegetable, fruits, meat to thaw, raw fish, etc.. setting the conversion switch as necessary.</p> <p>Be sure to check the conversion switch setting before storing foods.</p> |  |

Storing foods

Freezer compartment

- Store fresh food in the refrigerator compartment. How food is frozen and thawed is an important factor in maintaining its freshness and flavor.
 - Do not store food which goes bad easily at low temperatures, such as bananas, and melons.
 - Allow hot food to cool prior to storing, placing hot food in the refrigerator could spoil other food, and lead to higher energy consumption.
 - When storing the food, cover it with vinyl wrap or store in a container with a lid. This prevents moisture from evaporating, and helps food to keep its taste and nutrients.
 - Do not block air vents with food. Smooth circulation of chilled air keeps refrigerator temperatures even.
 - Do not open the door frequently. Opening the door lets warm air enter the refrigerator, and cause temperatures to rise.
 - Never keep too much food in door rack because they may push against by inner racks so that the door cannot be fully closed.
- Do not store bottles in the freezer compartment - they may break when frozen.
 - Do not refreeze food that has been thawed. This causes loss of taste and nutrient.
 - When storing frozen food like ice cream for a long period, place it on the freezer shelf, not in the door rack.
 - Do not touch the cold foods or containers- especially made of metallic -, with wet hands and place glass products in the freezer compartment.



CAUTION

- That's why you may have chilblains and they may be broken when their inner matters are frozen, causing personal injury.

Refrigerator compartment

- Avoid placing moist food in top refrigerator shelves, it could freeze from direct contact with chilled air.
- Always clean food prior to refrigeration. Vegetables and fruits should be washed and wiped, and packed food should be wiped, to prevent adjacent food from spoiling.
- When storing eggs in their storage rack or box, ensure that they are fresh, and always store them in an upright position, which keeps them fresh longer.

NOTE

- If you keep the refrigerator in a hot and humid place, frequent opening of the door or storing a lot of vegetables in it may cause dew to form which has no effect on its performance. Remove the dew with dust cloth free from care.

How to dismantle parts

NOTE

- Dismantling is done in the reverse sequence of assembly.
Be sure to unplug the power plug before dismantling and assembly.
Never apply severe force to dismantle parts. Parts may be damaged.

Freezer compartment lamp

Separate the lamp by pulling it out ③ while slightly pressing ① and rotating ② the lamp cover. Turn the bulb counterclockwise. Use a 40-watt bulb (max.) which can be purchased at a service center.

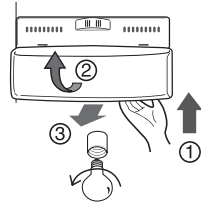

Freezer compartment shelf

To remove a shelf, push the shelf to the left ①, lift the left part of the shelf a bit ②, lift the right part up ③, and take it out.

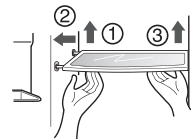

Door rack

Lift the door rack holding both sides ① and pull it out ② direction.

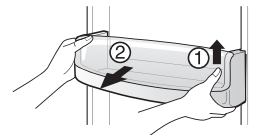

Ice storage bin

Hold the top and bottom sides of the ice box by two hands as shown in the right figure, hold the bottom of the ice box ①, lift it up lightly, and then take out it slowly by the direction ②.

- Do not dismantle the ice storage bin unless it is necessary.
- Use both hands to remove the ice bin to avoid dropping it.

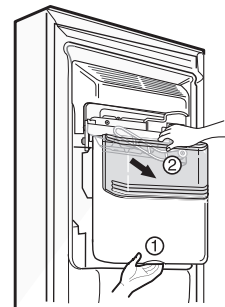

After dispenser is used

The water collector has no self-draining function. It should be cleaned regularly.

Pull out the water collector cover ① and dry it with a cloth. Pull the water collector ② fully to the front, then pull it out. Clean the collector with a dry cloth.



Lamp in refrigerator compartment

Insert the tool into the marked area ① and push the tool to disconnect.
Use the tool with the flat tip such as (-) screw driver.
Turn the bulb counterclockwise. Max. 40 W bulb for refrigerator is used and can be purchased at a service center.

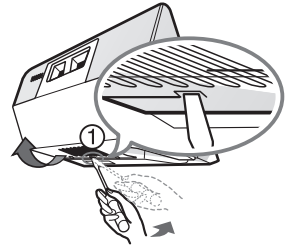

Refreshment center

- Separate the door rack(①) to upward.
- Separate cover of the refreshment center (②) to upward.
- The door rack(③) can be removed by pulling it upwards.

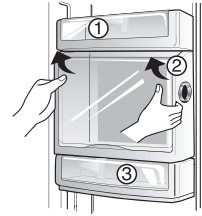

NOTE

- Be sure to remove parts from the refrigerator door when removing the vegetable compartment, snack drawer and refreshment center cover.

Vegetable compartment cover

- To remove the vegetable compartment cover, pull out the vegetable compartment a bit to the front ①, lift the front part of the vegetable compartment cover as shown by ②, and take it out.

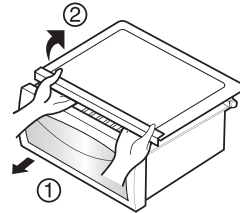

General information

Vacation time

During average length vacations, you will probably find it best to leave the refrigerator in operation. Place freezable items in freezer for longer life.

When you plan not to operate, remove all food, disconnect the power cord, clean the interior thoroughly, and leave each door OPEN to prevent odor formation.

Power failure

Most power failures that are corrected in an hour or two will not affect your refrigerator temperatures.

However, you should minimize the number of door openings while the power is off.

If you move

Remove or securely fasten down all loose items inside the refrigerator.

To avoid damaging the height adjusting screws, turn them all the way into the base.

Anti condensation pipe

The outside wall of the refrigerator cabinet may sometimes get warm, especially just after installation.

Don't be alarmed. This is due to the anti-condensation pipe, which pumps hot refrigerator to prevent "sweating" on the outer cabinet wall.

Cleaning

It is important that your refrigerator be kept clean to prevent undesirable odors. Spilled food should be wiped up immediately, since it may acidify and stain plastic surfaces if allowed to settle.

Exterior

Use a lukewarm solution of mild soap or detergent to clean the durable finish of your refrigerator.

Wipe with a clean damp cloth and then dry.

Interior

Regular cleaning is recommended. Wash all compartments a baking soda solution or a mild detergent and warm water. Rinse and dry.

After cleaning

Please verify that the power cord is not damaged, power plug is not overheated, or power plug is well inserted into the power consent.

WARNING

Always remove power cord from the wall outlet prior to cleaning in the vicinity of electrical parts (lamps, switches, controls, etc.).

Wipe up excess moisture with a sponge or cloth to prevent water or liquid from getting into any electrical part and causing an electric shock.

Never use metallic scouring pads, brushes, coarse abrasive cleaners, strong alkaline solutions, flammable or toxic cleaning liquids on any surface.

Do not touch frozen surfaces with wet or damp hands, because damp object will stick or adhere to extremely cold surfaces.

Trouble shooting

Before calling for service, review this list. It may save you both time and expense. This list includes common occurrences that are not the result of defective workmanship or materials in this appliance.

| Occurrence | Possible cause | Solution |
|---|---|--|
| Runing of refrigerator | | |
| Refrigerator compressor does not run. | Refrigerator control is off. | Set refrigerator control. See setting the controls. |
| | Refrigerator is in defrost cycle. | This is normal for a fully automatic defrosting refrigerator. The defrost cycle occurs periodically. |
| | Plug at wall outlet is disconnected. | Make sure plug is tightly pushed into outlet. |
| | Power outage. Check house lights. | Call local electric company. |
| Refrigerator runs too much or too long | Refrigerator is larger than the previous one you owned. | This is normal. Larger, more efficient units run longer in these conditions. |
| | Room or outside weather is hot. | It is normal for the refrigerator to work longer under these conditions. |
| | Refrigerator has recently been disconnected for a period of time. | It takes some hours for the refrigerator to cool down completely. |
| | Large amounts of warm or hot food may have been stored recently. | Warm food will cause the refrigerator to run longer until the desired temperature is reached. |
| | Doors are opened too frequently or too long. | Warm air entering the refrigerator causes it to run longer. Open the door less often. |
| | Refrigerator or freezer door may be slightly open. | Make sure the refrigerator is level. Keep food and containers from blocking door. See problem section. OPENING/CLOSING of doors. |
| | Refrigerator control is set too cold. | Set the refrigerator control to a warmer setting until the refrigerator temperature is satisfactory. |
| | Refrigerator or freezer gasket is dirty, worn, cracked, or poorly fitted. | Clean or change gasket. Leaks in the door seal will cause refrigerator to run longer in order to maintain desired temperatures. |
| | Thermostat is keeping the refrigerator at a constant temperature. | This is normal. Refrigerator goes on and off to keep the temperature constant. |

| Occurrence | Possible cause | Solution |
|---|---|--|
| Refrigerator compressor does not run. | Thermostat is keeping the refrigerator at a constant temperature. | This is normal. The refrigerator goes on and off to keep the temperature constant. |
| Temperatures are too cold | | |
| Temperature in the freezer is too cold but the refrigerator temperature is satisfactory. | Freezer control is set too cold | Set the freezer control to a warmer setting until the freezer temperature is satisfactory. |
| Temperature in the refrigerator is too cold and the freezer temperature is satisfactory. | Refrigerator control is set too cold. | Set the refrigerator control to a warmer setting |
| Food stored in drawers freezes. | Refrigerator control is set too cold. | See above solution. |
| Meat stored in fresh meat drawer freezes. | Meat should be stored at a temperature just below the freezing point of water (32 F, 0 C) for maximum fresh storage time. | It is normal for ice crystals to form due to the moisture content of meat. |
| Temperatures are too warm | | |
| Temperatures in the refrigerator or freezer are too warm. | Freezer control is set too warm. | Set the freezer or refrigerator control to a colder setting until the freezer or refrigerator temperature is satisfactory. |
| | Refrigerator control is set too warm. Refrigerator control has some effect on freezer temperature. | Set the freezer or refrigerator control to a colder setting until the freezer or refrigerator temperature is satisfactory. |
| | Doors are opened too frequently or too long. | Warm air enters the refrigerator/ freezer whenever the door is opened. Open the door less often. |
| | Door is slightly open. | Close the door completely. |
| | Large amounts of warm or hot food may have been stored recently. | Wait until the refrigerator or freezer has a chance to reach its selected temperature. |
| | Refrigerator has recently been disconnected for a period of time. | A refrigerator requires some hours to cool down completely. |
| Temperature in the refrigerator is too warm but the freezer temperature is satisfactory. | Refrigerator control is set too warm. | Set the refrigerator control to a colder setting. |

| Occurrence | Possible cause | Solution |
|--|---|---|
| Sound and noise | | |
| Louder sound levels when refrigerator is on. | Today's refrigerators have increased storage capacity and maintain more even temperatures. | It is normal for sound levels to be higher. |
| Louder sound levels when compressor comes on. | Refrigerator operates at higher pressures during the start of the ON cycle. | This is normal. The sound will level off as the refrigerator continues to run. |
| Vibrating or rattling noise. | Floor is uneven or weak. Refrigerator rocks on the floor when it is moved slightly. | Be sure floor is level and solid and can adequately support refrigerator. |
| | Items placed on the top of the refrigerator are vibrating. | Remove items. |
| | Dishes are vibrating on the shelves in the refrigerator. | It is normal for dishes to vibrate slightly. Move dishes slightly. Make sure refrigerator is level and firmly set on floor. |
| | Refrigerator is touching wall or cabinets. | Move refrigerator so that it does not touch the wall or refrigerator. |
| Water/Moisture /Ice inside refrigerator | | |
| Moisture collects on the inside walls of the refrigerator. | The weather is hot and humid which increases the rate of frost buildup and internal sweating. | This is normal. |
| | Door is slightly open. | See problem section opening/closing of doors. |
| | Door is opened too often or too long. | Open the door less often. |
| Water/Moisture /Ice outside refrigerator | | |
| Moisture forms on the outside of the refrigerator or between doors. | Weather is humid. | This is normal in humid weather. When humidity is lower, the moisture should disappear. |
| | Door is slightly open, causing cold air from the inside the refrigerator to meet warm air from the outside. | This time, close the door completely. |

| Occurrence | Possible cause | Solution |
|---|---|--|
| Odors in refrigerator | | |
| | Interior needs to be cleaned. | Clean interior with sponge, warm water and baking soda. |
| | Food with strong odor is in the refrigerator. | Cover food completely. |
| | Some containers and wrapping materials produce odors. | Use a different container or brand of wrapping materials. |
| Opening/Closing of doors/Drawers | | |
| Door(s) will not close. | Food package is keeping door open. | Move packages that keep door from closing. |
| Door(s) will not close. | Door was closed too hard, causing other door to open slightly. | Close both doors gently. |
| | Refrigerator is not level. It rocks on the floor when it is moved slightly. | Adjust the height adjusting screw. |
| | Floor is uneven or weak. Refrigerator rocks on the floor when it is moved slightly. | Be sure floor is level and can adequately support refrigerator. Contact carpenter to correct sagging or sloping floor. |
| | Refrigerator is touching wall or cabinets. | Move refrigerator.. |
| Drawers are difficult to move. | Food is touching shelf on top of the drawer | Keep less food in drawer. |
| | Track that drawer slides on is dirty. | Clean drawer and track. |
| Dispenser | | |
| Dispenser will not dispense ice | Ice storage bin is empty. | When the first supply of ice is dropped into the bin, the dispenser should operate. |
| | Freezer temperature is set too warm. | Turn the freezer control to a higher setting so that ice cubes will be made. When the first supply of ice is made, the dispenser should operate. |
| | Household water line valve is not open. | Open household water line valve and allow sufficient time for ice to be made. When ice is made, dispenser should operate. |
| | Refrigerator or freezer door is not closed. | Be sure both doors are closed. |

| Occurrence | Possible cause | Solution |
|--|--|--|
| Dispenser will not dispense ice. | Ice has melted and frozen around auger due to infrequent use, temperature fluctuations and/or power outages. | Remove ice storage bin, and thaw and the contents. Clean bin, wipe dry and replace in proper position. When new ice is made, dispenser should operate. |
| Ice dispenser is jammed. | Ice cubes are jammed between the ice maker arm and back of the bin. | Remove the ice cubes that are jamming the dispenser. |
| | Ice cubes are frozen together. | Use the dispenser often so that cubes do not freeze together. |
| | Ice cubes that have been purchased or made in some other way have been used in the dispenser. | Only the ice cubes made by the ice maker should be used with the dispenser. |
| Dispenser will not dispense water. | Household water line valve is not open. See problem "Ice maker is not making any ice." | Open household water line valve. |
| | Refrigerator or freezer door is not closed. | Be sure both doors are closed. |
| Water has an odd taste and/or odor. | Water has been in the tank for too long. | Draw and discard 7 glasses of water to freshen the supply. Draw and discard an additional 7 glasses to completely rinse out tank. |
| | Unit not properly connected to cold water line. | Connect unit to cold water line which supplies water to kitchen faucet. |
| Sound of ice dropping | This sound is normally made when automatically made ice is dropped into ice storage bin. Volume may vary according to refrigerator's location. | |
| Sound of water supply | This sound is normally made when ice maker is supplied with water after dropping the automatically made ice. | |
| Other | Please thoroughly read 'Automatic ice maker and dispenser' in this manual. | |

When replacing PANEL

(Be sure to read before replacing panel.)

When replacing panels (A,B,C),contact a qualified service representative to perform this operation,and follow these important steps.

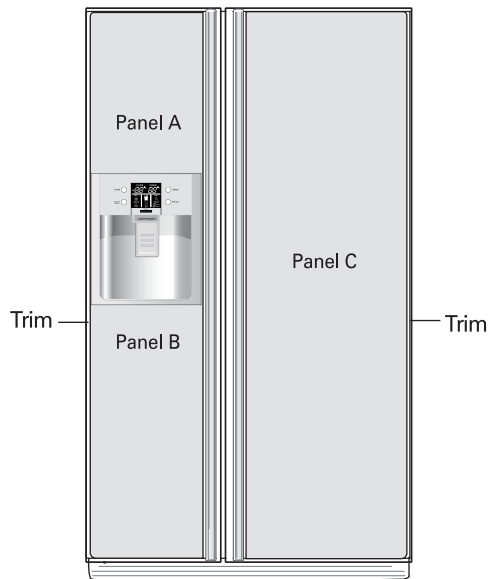

CAUTION

1. Avoid damaging the Panel. If damaged,it may cause personal injury.
2. When using glass as a material for panel,tempered glass must be use. Ordinary glass may cause personal injury if broken.
3. The total weight of the Panels(A,B,C)to be replaced should not weight more than 15kg. If it overweight,the hinge strength may be decreased, resulting in door Sagging etc.
4. The thickness of the Panel in the Trim assembly is 3.2~3.5mm.
5. Size of Panel(Width×Height)
 - Panel (A) : 381.5 mm×477mm
 - Panel (B) : 381.5 mm×785 mm
 - Panel (C) : 497.5 mm×1661.5 mm

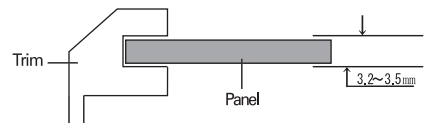

 **Caution to use refrigerator**

In changing glass of the door,glass on the front door can be broken, resulting personal injury .So handle with care.

When replacing PANEL

(Be sure to read before replacing panel.)

When replacing panels (A,B,C,D),contact a qualified service representative to perform this operation,and follow these important steps.

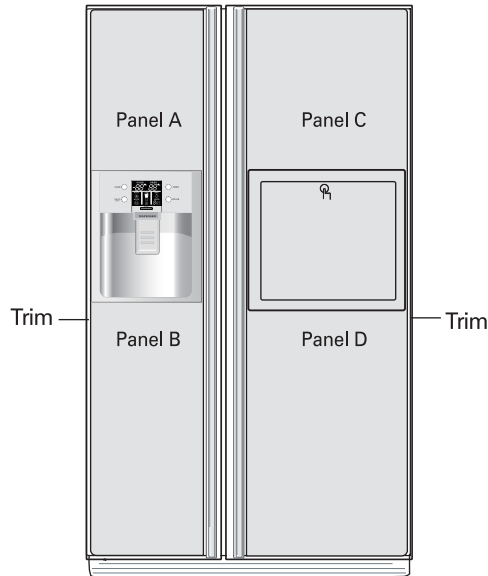

CAUTION

1. Avoid damaging the Panel. If damaged,it may cause personal injury.
2. When using glass as a material for panel,tempered glass must be use. Ordinary glass may cause personal injury if broken.
3. The total weight of the Panels(A,B,C,D)to be replaced should not weight more than 15kg. If it overweight,the hinge strength may be decreased, resulting in door Sagging etc.
4. The thickness of the Panel in the Trim assembly is 3.2~3.5mm.
5. Size of Panel(Width×Height)
 - Panel (A) : 381.5 mm×477mm
 - Panel (B) : 381.5 mm×785 mm
 - Panel (C) : 497.5 mm×477 mm
 - Panel (D) : 497.5 mm×785 mm

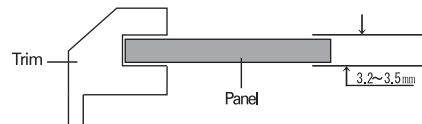

 Caution to use refrigerator

In changing glass of the door,glass on the front door can be broken, resulting personal injury .So handle with care.

