



ENGLISH

РУССКИЙ

УКРАЇНЬСЬКА

# OWNER'S MANUAL

# REFRIGERATOR

Please read this manual carefully before operating your set and retain it for future reference.

# CONTENT

NAME OF PARTS .....	3
MOVEMENT & TRANSPORTATION .....	4
EARTH CONNECTION .....	4
INSTALLATION .....	5
SAFETY GUARDS .....	6-7
HOW TO USE .....	8-9
BEST WAYS TO STORE FOOD .....	10-11
WAYS TO DISASSEMBLE SPARE PARTS .....	12
TO REVERSE THE DOORS (OPTIONAL) .....	13
CLEANING THE REFRIGERATOR .....	14
DOES THE REFRIGERATOR HAVE A MALFUNCTION .....	15
THIS IS NOT A MALFUNCTION .....	16
DISPOSAL OF YOUR OLD APPLIANCE .....	17

The working life of this set is 7 years since the date of delivery to consumer.

# NAME OF PARTS

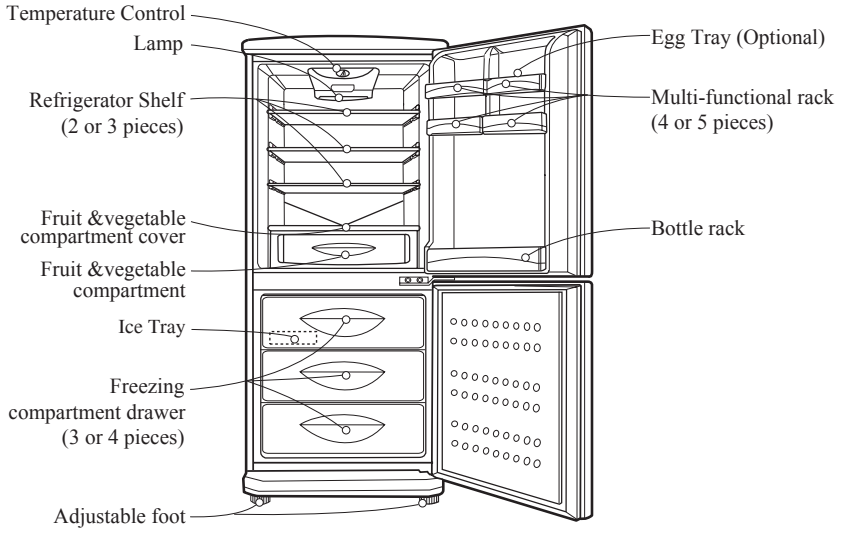

**Note**

If you find some parts missing from your unit, they may be parts only used in other models.

## MOVEMENT & TRANSPORTATION

### ● BEFORE TRANSPORTATION

- 1.Remove all the food from the refrigerator, secure the spare parts such as the shelves by adhesive tape.
- 2.Fasten the adjustable foot to the  direction.

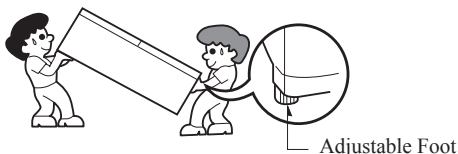

### ● DURING TRANSPORTATION

1. Hold tightly the adjustable foot at the bottom of the refrigerator and the upper handle at the back.
2. During transportation, please note that the refrigerator should not be tilted.
3. When transporting to a more distant place, the refrigerator should be placed vertically on the vehicle. (Otherwise problem will exist)

Note: Please fasten the adjustable foot to the  direction before transportation, otherwise the floor will be scraped or the foot will be blocked from moving.

## EARTH CONNECTION

- Note:
- 1.The earth wire of this electrical appliance has been connected to the power plug ,please do not change the power plug on your own.
  - 2.Plug your refrigerator into a standard 220V-240V household outlet,make sure the socket is properly earthed.
  - 3.If you receive an electrical shock by touching any part of the refrigerator,you should stop using the refrigerator immediately and contact the specified maintenance service unit or the retail shop of this product at once.

### ACCESSIBILITY OF SUPPLY PLUG

The refrigerator-freezer should be positioned that the supply plug is accessible for quick disconnection when accident happens.

### POWER CORD REPLACEMENT

If the supply cord is damaged,it must be replaced by a special cord or assembly from the manufacturer or its service agent.

# INSTALLATION

## Installing on a firm and flat surface

- Unstable installation is the main reason of vibration and noise.
- When the refrigerator is installed unstably, it can be stabilized by adjusting the adjustable foot.
- Slightly rising the front part of the refrigerator allow you to close the door very easily.
- When installed on a carpet or floor, please put a firm mat under the refrigerator otherwise the bottom part will change colour.

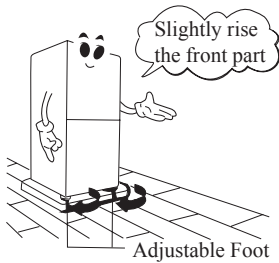

## Keep an appropriate distance between the wall

- To ensure proper air circulation around the fridge-freezer, please maintain sufficient space on both the sides as well as top and maintain at least 2 inches (5 cm) from the rear wall.
- A smaller gap will restrict the operation of the refrigerator, which may result in an increase in power.

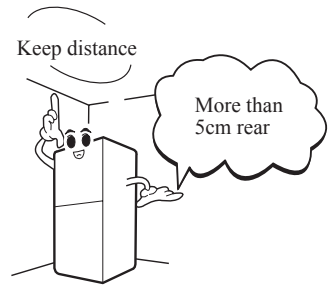

## Installing in a less humid environment

- Do not install the refrigerator in a humid place or where water can easily be splashed.
- If the refrigerator is installed in a humid environment, it will go moldy. This will lower insulation property and cause electricity leakage.

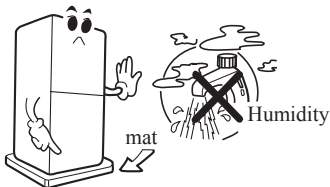

## Avoid installing near heat and gas

- High temperature will lower the refrigeration and increase the power consumption.
- Installing near gas or smoke will change the surface colour of the refrigerator.

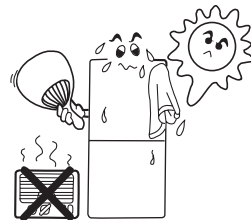

# SAFETY GUARDS

- **Please use the exclusive power socket.**

- If the refrigerator uses the same power socket as other electrical appliances, the socket could be overloaded abnormally and fire may be resulted, which may cause a fire.



- **Please note that the back of the refrigerator should not touch the power plug.**

- The power plug being pressed could be easily damaged and this may cause fire or electric shock.

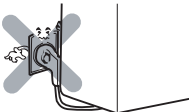

- **Please unplug the refrigerator first before cleaning. Do not do this with wet hands.**

- This may probably cause electric shock.

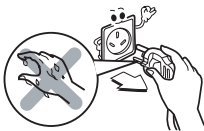

- **Please do not store flammable things like ether, benzene, alcohol and liquefied gas in the refrigerator.**

- Flammable things like ether, benzene, alcohol and liquefied gas may cause fire.



- **Please unplug the refrigerator before changing the light bulb.**

- Changing the light bulb as the refrigerator is operating may cause an electric shock.



- **Please do not put heavy things on top of the refrigerator.**

- When you open the door, the heavy things could easily fall down and hurt you.



- **Please do not climb on the door.**

- The refrigerator could be turned over and hurt small children.

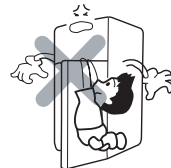

- **Please do not store medicine or academic information in the refrigerator.**

- Things which require strict temperature control should not be stored in the refrigerator, otherwise they will go bad or produce accidental effect.

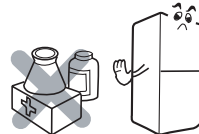

# SAFETY GUARDS

- **Please keep away from fire.**

- Can cause fire.

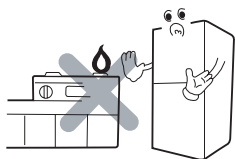

- **Please do not place water container such as vases, glasses, cosmetic or medicine on top of the refrigerator.**

- Liquid spilt over the refrigerator will reduce the insulation effect, and may cause an electric shock or fire.



- **Please do not install in a humid place or where water can easily be splashed.**

- This will reduce the insulation effect and may cause an electric shock.

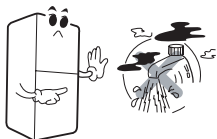

- **During transportation, please hold the adjustable feet at the bottom of the refrigerator and the upper handle at the back.**

- Otherwise, the refrigerator may fall down.

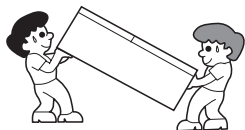

- **In case of a gas leak, please do not touch the refrigerator and the power socket, you should open the windows and the door for ventilation.**

- As a spark may cause an explosion and lead to fire.



- **Please do not store bottles in the freezing compartment.**

- As bottles in the freezing compartment, liquid inside will be frozen and the bottle will break.



- **Please unplug the refrigerator if it is not to be used for a long time.**

- Reduced insulation may cause an electric shock or fire.



- **When the refrigerator is unplugged, please wait for five minutes before you plug it again.**

- Otherwise the compressor will be overloaded.

after 5 minutes

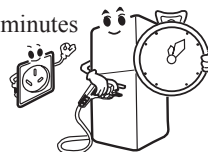

## ⚠ CAUTION

This appliance is not intended for use by persons (including children) with reduced physical, sensory or mental capabilities, or lack of experience and knowledge, unless they have been given supervision or instruction concerning use of the appliance by a person responsible for their safety.

Children should be supervised to ensure that they do not play with the appliance.

# HOW TO USE

## Initial operation

- Clean the inner part of the refrigerator before using.
- Do not put foods into the refrigerator until it has been plugged in for 3 hours.

## Temperature control

- The thermostat used for controlling the temperature inside the refrigerator is located on the top of the refrigerator.
- The figure on the thermostat does not stand for a practical value. The smaller the figure is, the higher the temperature inside the refrigerator is.
- Temperature control

Position	Function
0	Stop
1-2	Warm
3-4	Normal
5-6	Cold
7	Quick freezing

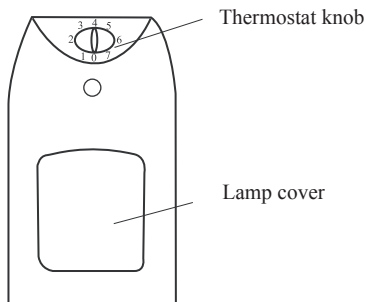

## \* Power failure

If power failure is known in advance, please

- Turn the thermostat to "7" two hours before power failure.
- Place more ice cubes in the refrigerator compartment.
- Do not place anymore food in the refrigerator.
- Do not open the door more than necessary.

## Note

- Power failure leads to the rising of the freezing compartment's temperature, this may shorten the storage of foods and decline the quality.
- If the power supply is off for too long, be sure to get rid of any water or ice underside the drawer of the freezing compartment before reconnection of the power supply, so as to avoid the foods and the ice freezing together.



# HOW TO USE

## Defrost

As the refrigerator operates, the moisture from foods or in the air may be frosted on to the inner part of the refrigerator and the surface of evaporator. Too thick frost will affect the operation of the refrigerator, so regularly defrosting is necessary. Usually, defrosting is necessary when the thickness reaches 5 mm.

### ● Refrigerator compartment

Defrosts automatically, moisture on the inner side runs into the drip tray through the drain pipe. The heat generated by compressor evaporates the water automatically.

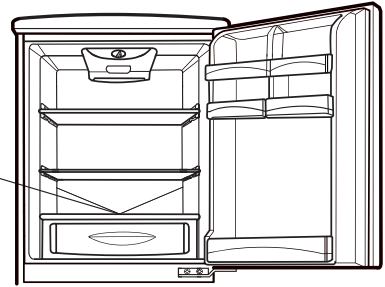

Drain pipe

### Note:

- keep the drain pipe straight so that water can in pour into the drip tray. When it's blocked, take out the drain cover, clean it and then replace it.

## Freezing compartment

Before defrosting—turn the thermostat knob to "0", open the door, take out foods and drawers in the freezing compartment, foods may be put into refrigerator compartment temporarily.

Defrosting—remove the frost on the inner side of the freezing compartment and on the surface of the evaporator with the ice scraper, then wipe off the water with a dry cloth.

After defrost—turn the thermostat knob to the former position.



Ice scraper

## Ice making

● Fill the ice tray with water to 4/5 of its capacity and place it into the freezing compartment, turn the thermostat knob to "6".

● Twist the both sides of the ice tray so as to remove the ice cubes easily.

**Tip:** To remove ice cubes easily, run water on the tray before twisting.

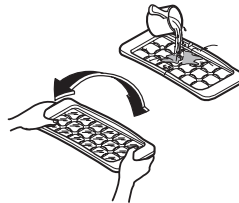

# BEST WAYS TO STORE FOOD

## Refrigerator compartment

The refrigerator compartment is used to store foods that are not required to be frozen, the storage life is shorter.

The following foods storage position is provided for your reference.

- ①② position: egg, butter etc.
- ③④ position: cheese, can, sauce etc.
- ⑤ position: beverage, bottled food etc.
- ⑥ position: can, sweetmeat etc.
- ⑦ position: bread, can, milk etc.
- ⑧ position: acid milk, sausage, meat, fish etc.
- ⑨ position: vegetable, fruit etc.

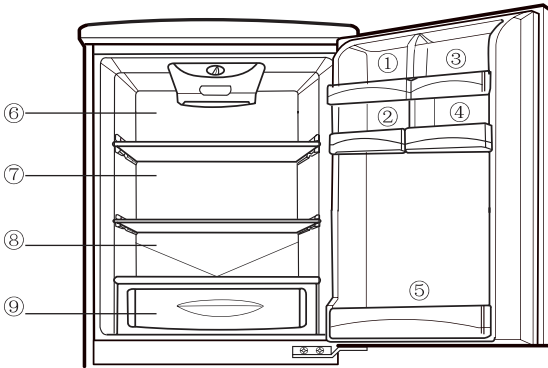

## Freezing compartment

Store frozen food or need frozen food in the freezer compartment, those food have a long storage period.

- 1. Food applicable to freezing: meat, frozen meat, sausage, fowl, venison, fish, bread, cake and so on.
- 2. Food unable to be frozen: egg, acidophilus milk, mayonnaise, lettuce, radish, capsicum, onion and so on.

# BEST WAYS TO STORE FOOD

## Storing the food

- **Store foods which are easily frozen on the outer position of the refrigerator shelf.**

- If foods which are easily frozen or contain a lot water are stored on the inner part of the refrigerator shelf, it will be frozen owing to low temperature.

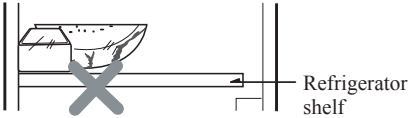

- **Store the foods or other things after cleaning and wiping.**

- Store vegetables and fruits after cleaning and wiping. Packed food like bottle should be stored after wiping to avoid polluting the other foods.



- **Storing the heated food after cooling.**

- Storing the heated food directly in the refrigerator will affect the other foods inside and will also waste the power.

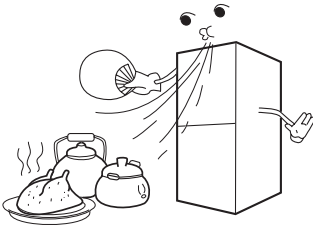

- **In the low temperature mode, do not store the food which can easily be rotten for a long time.**

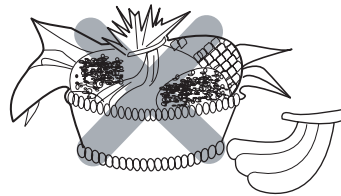

- **Store food after packing or putting into tight container.**

- Packing the food before storing can prevent drying. This can also reduce odour when storing the food for a longer time.

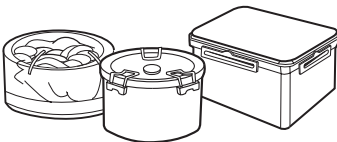

- **Do not store bottles in the Freezing Compartment.**

- If bottles are stored in the Freezing compartment, the liquid inside will be frozen and break the bottle.  
- The volume of liquid such as juice or water should not exceed 80% of the container's volume.



## WAYS TO DISASSEMBLE SPARE PARTS

### Refrigerator shelf

Slightly rise the front part of the shelf, then pull outward.

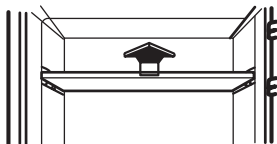

### Refrigerating compartment door rack

Grasp both sides, lift upward and then pull outward.

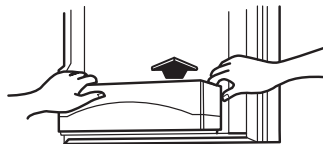

### Freezing compartment drawer

Pull outward. Rise it slightly and then take it out.

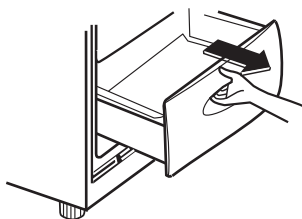

### Bottom cover

Remove the two screws which hold the bottom cover, grasp the both sides and then pull outward.

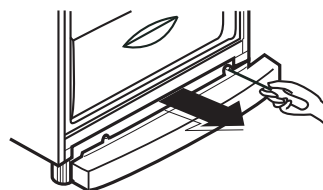

### Lamp

- Lamp data: 240V/15W

- Replacement:

1. Unplug the refrigerator.
2. Press the backside of the lamp cover (shown as arrow ) , and pull outward.
3. Remove the faulty lamp and install a new one.
4. Reload the lamp cover.

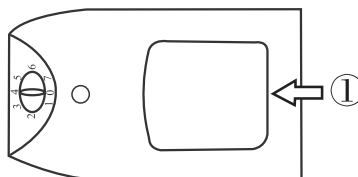

## TO REVERSE THE DOORS (OPTIONAL)

**Note: To avoid the two doors dropping and result in physical injury, at least two persons are required to change the door opening type.**

If you need to replace the door opening type because of the room or some other reasons, please operate as the following steps.

1. Disassemble the Hinge Middle(1);
2. Remove the Refrigerator Door (2) and the Freezer Door (3) (cooperate with another person);
3. Remove the Top Cover (4);
4. Remove the pin of Hinge Upper Right and assemble it on Hinge Upper Left (5);
5. Remove the Cap Hinge and install it on the corresponding on the right side (6), install the Top Cover (7);
6. Take out the spare Hinge Lower Left from the material bag and replace it on the corresponding position. Remove the Pin from the Hinge Lower Right to the Hinge Lower Left (8);
7. Remove the Cap on the left of the Hinge Middle and install it on the corresponding position (9) on the right side;
8. Remove the Right limit on the refrigerator door and the Freezer door (10). And install it on the refrigerator door and the Freezer door.
9. Remove the cap hinge and bush on refrigerator door and Freezer door respectively, assemble them on the corresponding position on the other side (11).
10. Install Refrigerator door (13) and Freezer door (14) (cooperate with another person), then fix the hinge middle on the left side(15).

### NOTE

Reversing the doors is not covered by the warranty.

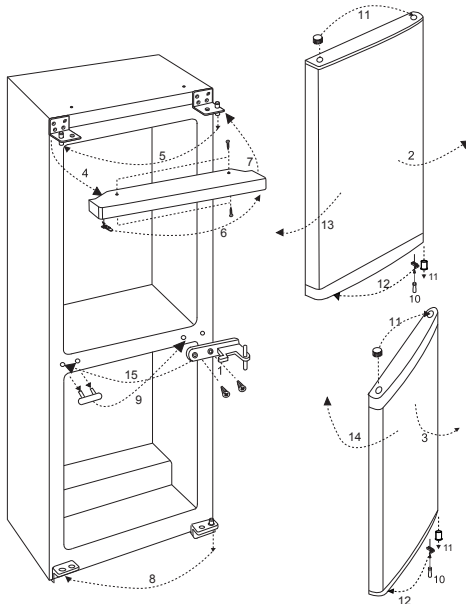

# CLEANING THE REFRIGERATOR

## Before cleaning

- Unplug the refrigerator first to ensure safety.



## Cleaning

### ● Shelf and door rack

- These can easily become dirty. The inside of the refrigerator must be kept clean.



### ● Magnetic door seal

- If the door seal is dirty or covered in juice for a long time, the effectiveness of magnetic door seal will be reduced.
- Regular cleaning is necessary.

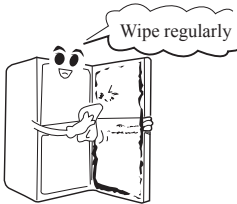

### ● Do not shower the refrigerator with water

- This will reduce the insulation and cause an electrical shock.



## After cleaning please check whether:

- If the wire is damaged.
- If the power plug is not overheating.
- If the power plug is inserted properly.



### ● Surface of refrigerator

- Clean it with a soft cloth using a soapy cleanser, then dry with a clean cloth.

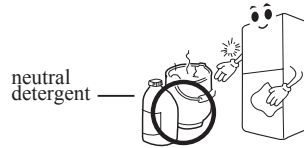

### ● Fruit & Vegetable Compartment

- Water can accumulate in this area. Too much water will rot the food, therefore the compartment should be taken out and cleaned regularly.



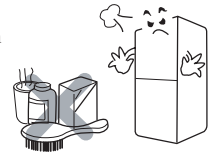

### ● Please do not clean the refrigerator with the following things:

- Cleaning powder, petrol benzene, hydrochloric, boiling water and brush etc. as they will damage the surface of refrigerator. Therefore please do not use them.



# DOES THE REFRIGERATOR HAVE A MALFUNCTION?

If the refrigerator still does not work properly after checking the following tasks, please unplug the refrigerator and immediately contact the specified maintenance service unit or the retail shop of this product.

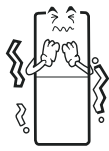
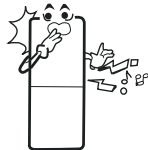
Situation	Please check
<p><b>The refrigerator does not operate</b></p> 	<ul style="list-style-type: none"> <li>➡ Is there a power failure?</li> <li>➡ Is the power plug inserted into the socket?</li> <li>➡ Is it 220V-240V?</li> <li>➡ Does the thermostat knob turn to position "0"?</li> </ul>
<p><b>Inefficient cooling</b></p> 	<ul style="list-style-type: none"> <li>➡ Is the temperature control in the refrigerator compartment turned to too low mode?</li> <li>➡ Is there any direct sunshine or heaters near by?</li> <li>➡ Have you put some heated goods directly into the refrigerator?</li> <li>➡ Have you stored too much food?</li> <li>➡ Have you frequently opened the door of the refrigerator?</li> <li>➡ Have you kept an appropriate distance between the refrigerator and the wall?</li> </ul>
<p><b>Food stored in the refrigerator compartment becomes frozen</b></p> 	<ul style="list-style-type: none"> <li>➡ Is the temperature control in the refrigerator compartment turned to too high mode?</li> <li>➡ Have you put the foods against the inner side?</li> </ul>
<p><b>Too much noise, abnormal sound</b></p> 	<ul style="list-style-type: none"> <li>➡ Is the floor level and hard enough?</li> <li>➡ Is the back of refrigerator too close to the wall?</li> <li>➡ Have you put other things on the top of the refrigerator?</li> </ul> <p><b>Note:</b></p> <ul style="list-style-type: none"> <li>➡ The sound may be louder when the refrigerator starts to work or turn off the power.</li> <li>➡ Installing on the floor may produce sound.</li> </ul>

# THIS IS NOT A MALFUNCTION

- **The refrigerator dew forming on the surface.**

- If the refrigerator is installed in a humid environment or if it is raining, there can be dew forming on the surface of the refrigerator. This is because moisture in the air touches the surface of the refrigerator.
- Please wipe it with a clean soft cloth.

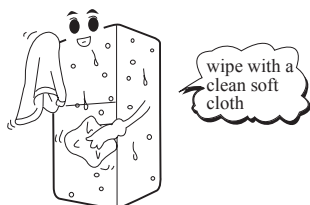

- **You hear a sound like flowing water.**

- It is the sound produced when the compressor stops operating.
- It is the sound of flowing refrigerant in the freezing system.
- Sound can be produced by the contraction and expansion of the parts due to temperature changes inside the refrigerator.

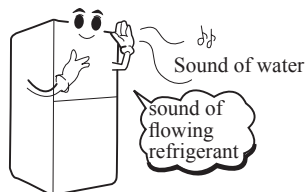

- **The surface of refrigerator is warm.**

- A high temperature pipe which prevents dewing is installed inside the refrigerator when the refrigerator begins to operate or when it is summer, the surface will become warm. Please do not worry because this is a normal effect.

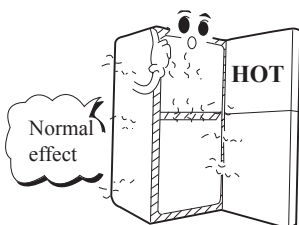

- **The inner side of refrigerator compartment has dew forming.**

- This is because the refrigerator is installed in a humid environment or the door is opened too long.
- Foods with a high water content are not packed well before storing.

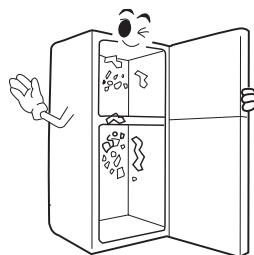



# DISPOSAL OF YOUR OLD APPLIANCE



## Disposal of your old appliance

1. When this crossed-out wheeled bin symbol is attached to a product it means the product is covered by the European Directive 2002/96/EC.
2. All electrical and electronic products should be disposed of separately from the municipal waste stream via designated collection facilities appointed by the government or the local authorities.
3. The correct disposal of your old appliance will help prevent potential negative consequences for the environment and human health.
4. For more detailed information about disposal of your old appliance, please contact your city office, waste disposal service or the shop where you purchased the product.

- Information of fluorinated greenhouse gases used as refrigerant of this refrigerator.

Chemical name	Composition of Gases	Total GWP (kg CO <sub>2</sub> -eq)
R-134a	100% HFC-134a	1300