



OWNER'S MANUAL

LED LCD MONITOR TV

Please read this manual carefully before operating your set and retain it for future reference.

LED LCD MONITOR TV MODELS

M2080D	M2080DF	M2080DB	M2080DN
M2280D	M2280DF	M2280DB	M2280DN
M2380D	M2380DF	M2380DB	M2380DN
M2780D	M2780DF		M2780DN

CONTENTS

PREPARATION

FRONT PANEL CONTROLS	4
BACK PANEL INFORMATION	6
STAND INSTALLATION	8
DETACHING STAND	11
DETACHING STAND BODY	14
WALL MOUNT : HORIZONTAL INSTALLATION	15
DESKTOP PEDESTAL INSTALLATION	16
POSITIONING YOUR DISPLAY	17
SWIVEL STAND(Only M2780D / M2780DF)....	17
LOCATION	17
KENSINGTON SECURITY SYSTEM	18

EXTERNAL EQUIPMENT SETUP

ANTENNA CONNECTION	19
HD RECEIVER SETUP	20
DVD SETUP	23
VCR SETUP	26
INSERTION OF CI MODULE	29
DIGITAL AUDIO OUT SETUP	30
USB SETUP	31
HEADPHONE SETUP	32
OTHER A/V SOURCE SETUP	33
PC SETUP	34
BACK COVER FOR WIRE ARRANGEMENT ..	37
SUPPORTED DISPLAY RESOLUTION	38

WATCHING TV / PROGRAMME CONTROL

REMOTE CONTROL KEY FUNCTIONS.....	40
TURNING ON THE TV	42
PROGRAMME SELECTION.....	42
VOLUME ADJUSTMENT	42
QUICK MENU	43
ON SCREEN MENUS SELECTION AND ADJUSTMENT	44
AUTO PROGRAMME TUNING	45
CABLE DTV SETTING (IN CABLE MODE ONLY).....	50
MANUAL PROGRAMME TUNING (IN DIGITAL MODE).....	51

MANUAL PROGRAMME TUNING (IN ANALOGUE MODE).....	53
PROGRAMME EDIT	55
IN DTV/RADIO MODE	56
IN TV MODE	56
SOFTWARE UPDATE	58
DIAGNOSTICS	60
CI [COMMON INTERFACE] INFORMATION ..	61
SELECTING THE PROGRAMME LIST.....	62
FAVOURITE PROGRAMME SETUP.....	63
INPUT LIST	64

EPG (ELECTRONIC PROGRAMME GUIDE)(IN DIGITAL MODE)

Switch on/off EPG	65
Select a programme.....	65
Button Function in NOW/NEXT Guide Mode ...	66
Button Function in 8 Day Guide Mode	66
Button Function in Date Change Mode	67
Button Function in Extended Description Box ..	67
Button Function in Record/Remind Setting Mode.....	68
Button Function in Schedule List Mode	68

PICTURE CONTROL

PICTURE SIZE (ASPECT RATIO) CONTROL.....	69
PICTURE WIZARD	71
ENERGY SAVING.....	72
PRESET PICTURE SETTINGS.....	73
MANUAL PICTURE ADJUSTMENT	74
PICTURE IMPROVEMENT TECHNOLOGY ...	75
EXPERT PICTURE CONTROL	76
PICTURE RESET	79
SCREEN SETUP FOR PC MODE	80

SOUND CONTROL

AUTO VOLUME LEVELER.....	85
CLEAR VOICE II	86
BALANCE.....	87
PRESET SOUND SETTINGS-SOUND MODE....	88
PRESET SOUND SETTINGS-USER MODE ...	89
Surround X	89

AUDIO RESET	90
DIGITAL AUDIO OUT	91
TV SPEAKERS ON / OFF SETUP	92
DTV AUDIO SETTING (IN DIGITAL MODE ONLY)	93
I/II	
Stereo/Dual Reception (In Analogue Mode Only)	94
NICAM Reception (In Analogue Mode Only)	95
Speaker Sound Output Selection	95

TIME SETTING

CLOCK SETUP	96
AUTO ON/OFF TIME SETTING	97
SLEEP TIMER SETTING	98
AUTOMATIC STNADBY SETTING	98

OPTION SETTING

ON-SCREEN MENU LANGUAGE / COUNTRY SELECTION	99
LANGUAGE SELECTION (IN DIGITAL MODE ONLY)	100
AUDIO DESCRIPTION (IN DIGITAL MODE ONLY)	101
DATA SERVICE	102
INPUT LABEL	103
POWER INDICATOR	104
DEMO MODE	105
MODE SETTING	106
INITIALIZING(RESET TO ORIGINAL FACTORY SETTINGS)	107

PARENTAL CONTROL / RATINGS

SET PASSWORD & LOCK SYSTEM	108
BLOCK PROGRAMME	109
PARENTAL CONTROL (IN DIGITAL MODE ONLY)	110
INPUT BLOCK	111
KEY LOCK	112

TO USE A USB DEVICE

WHEN CONNECTING A USB DEVICE	113
PHOTO LIST	115
MUSIC LIST	121
MOVIE LIST	125
DIVX REGISTRATION CODE	132
DEACTIVATION	133

TELETEXT

SWITCH ON/OFF	134
SIMPLE TEXT	134
TOP TEXT	134
FASTTEXT	135
SPECIAL TELETEXT FUNCTION	135

DIGITAL TELETEXT

TELETEXT WITHIN DIGITAL SERVICE	136
TELETEXT IN DIGITAL SERVICE	136

APPENDIX

TROUBLESHOOTING	137
MAINTENANCE	141
PRODUCT SPECIFICATIONS	142
IR CODES	146
EXTERNAL CONTROL DEVICE SETUP	
RS-232C Setup	147
Type of Connector; D-Sub 9-Pin Male ...	147
RS-232C Configurations	147
Set ID	148
Communication Parameters	149

PREPARATION

FRONT PANEL CONTROLS

- This is a simplified representation of the front panel. The image shown may be somewhat different from your set.

PREPARATION

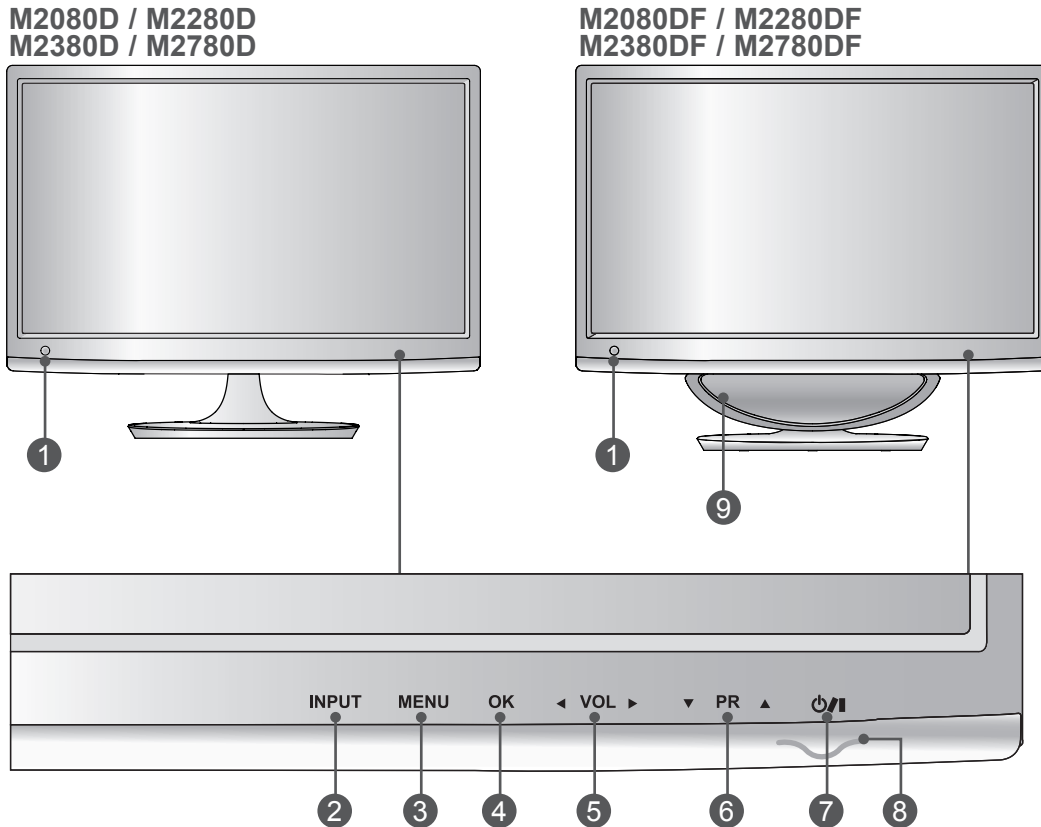

- 1 IR receiver (Remote controller receiver)
- 2 INPUT Button
- 3 MENU Button
- 4 OK Button
- 5 VOLUME Button
- 6 PROGRAMME Button
- 7 Power Button
- 8 Power Indicator
Illuminates blue when the set is switched on.
Note: You can adjust Power indicator in the OPTION menu.
- 9 WOOFER

FRONT PANEL CONTROLS

■ This is a simplified representation of the front panel. The image shown may be somewhat different from your set.

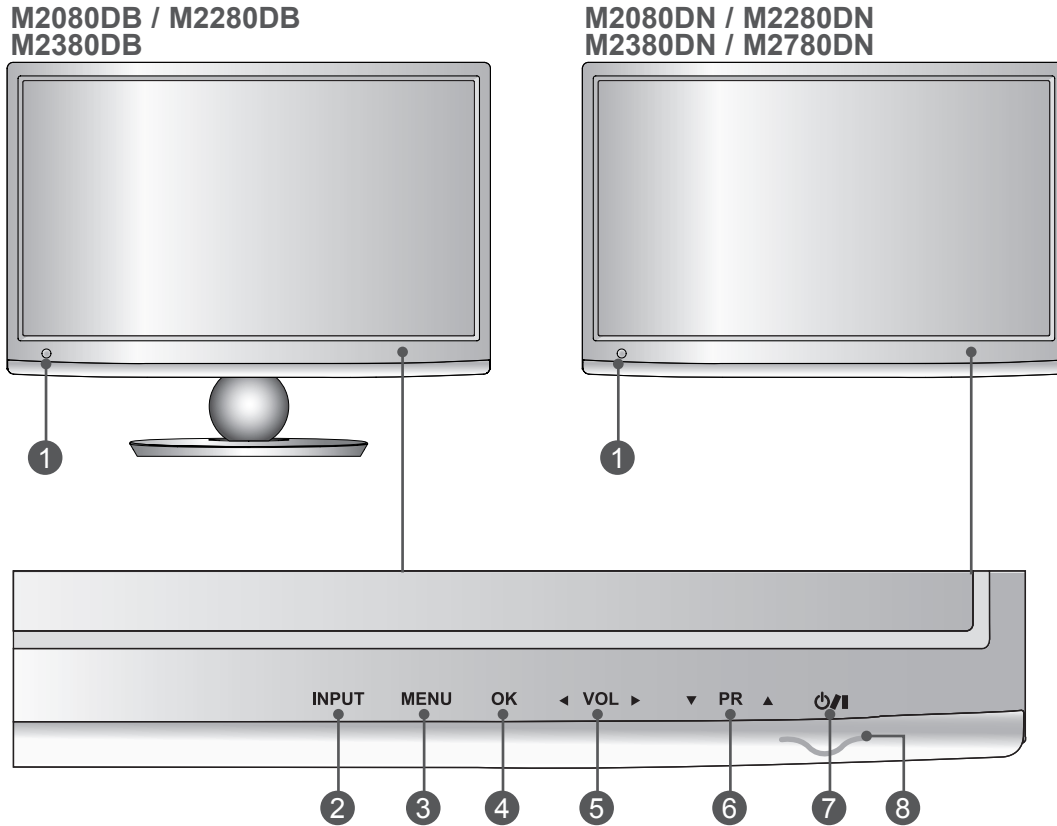

- ① IR receiver (Remote controller receiver)
- ② INPUT Button
- ③ MENU Button
- ④ OK Button
- ⑤ VOLUME Button
- ⑥ PROGRAMME Button
- ⑦ Power Button
- ⑧ Power Indicator

Illuminates blue when the set is switched on.

Note: You can adjust Power indicator in the OPTION menu.

PREPARATION

BACK PANEL INFORMATION

- This is a simplified representation of the back panel. The image shown may be somewhat different from your set.

M2080D / M2280D
M2380D / M2780D

M2080DF / M2280DF
M2380DF / M2780DF

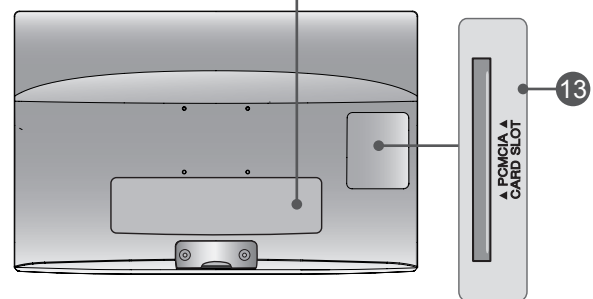
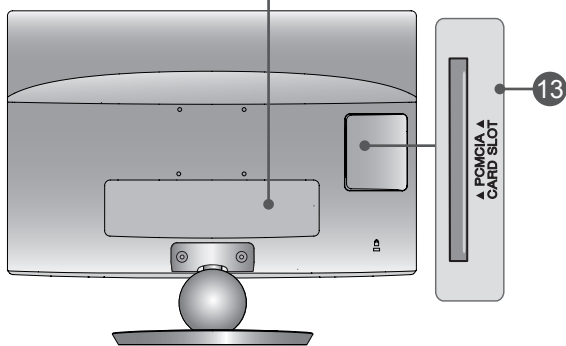
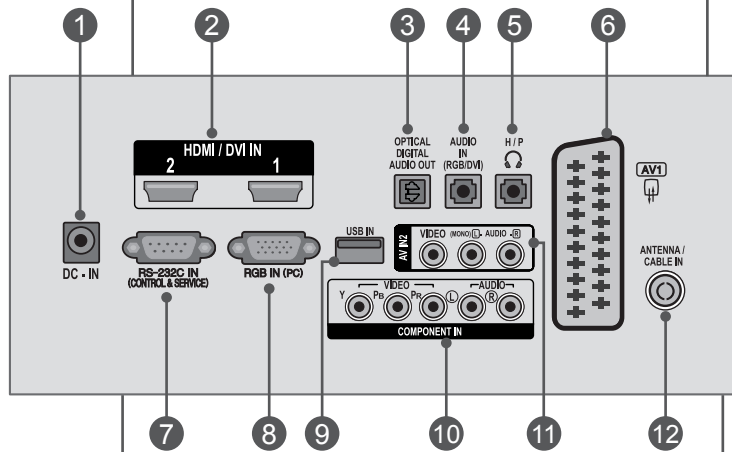
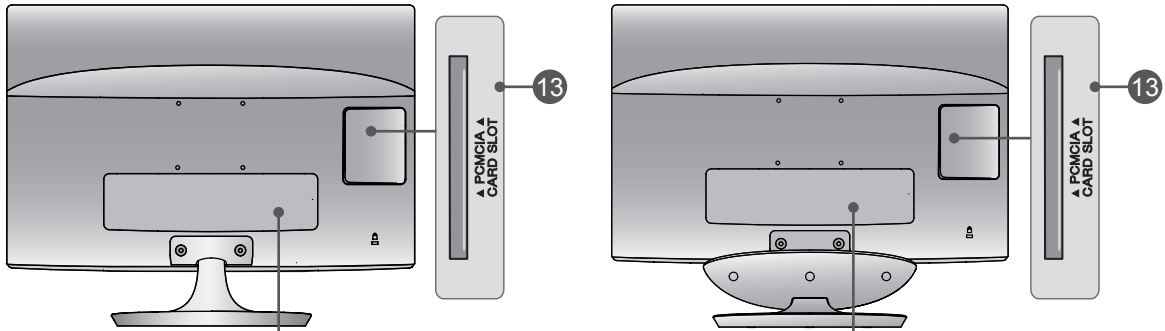

M2080DB / M2280DB
M2380DB

M2080DN / M2280DN
M2380DN / M2780DN

BACK PANEL INFORMATION

- 1 DC ADAPTER PORT**
Connect to the power cord socket.
- 2 HDMI / DVI INPUT**
Connect a HDMI signal to HDMI IN.
Or DVI (VIDEO) signal to HDMI IN with DVI to HDMI cable.
- 3 OPTICAL DIGITAL AUDIO OUT**
Connect digital audio to various types of equipment. Connect to a Digital Audio Component.
Use an Optical audio cable.
- 4 RGB/DVI AUDIO INPUT**
Connect the audio from a PC.
- 5 HEADPHONE SOCKET**
Plug the headphone into the headphone socket.
- 6 Euro Scart Socket (AV1)**
Connect scart socket input or output from an external device to these jacks.
- 7 RS-232C IN (CONTROL & SERVICE) PORT**
Connect to the RS-232C port on a PC.
This port is used for Service or Hotel mode.
- 8 RGB INPUT (PC)**
Connect the output from a PC.
- 9 USB Input**
- 10 COMPONENT INPUT**
Connect a component video/audio device to these jacks.
- 11 AV2 (AUDIO/VIDEO) INPUT**
Connect audio/video output from an external device to these jacks.
- 12 ANTENNA / CABLE INPUT**
Connect over-the-air signals to this jack.
- 13 PCMCIA (PERSONAL COMPUTER MEMORY CARD INTERNATIONAL ASSOCIATION) CARD SLOT**
Insert the CI Module to PCMCIA CARD SLOT.
(This feature is not available in all countries.)

PREPARATION

M2080D/M2280D/M2380D/M2780D

STAND INSTALLATION

■ The image shown may be somewhat different from your set.

1 Carefully place the product screen side down on a cushioned surface that will protect product and screen from damage.

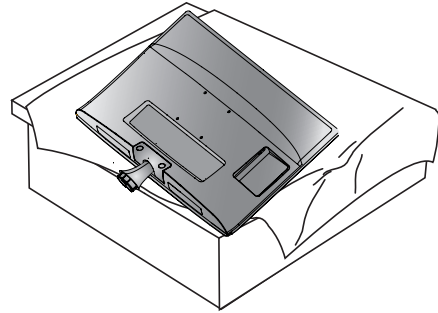

2 Insert the **Stand Base** into the product.

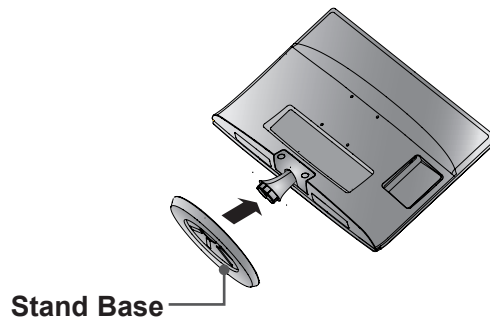

3 Use a **Coin** on the bottom of the stand base and turn the screw clockwise to tighten.

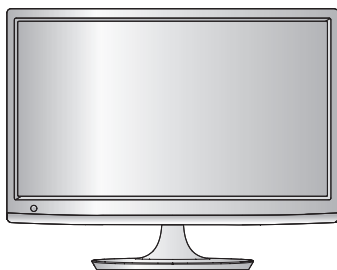
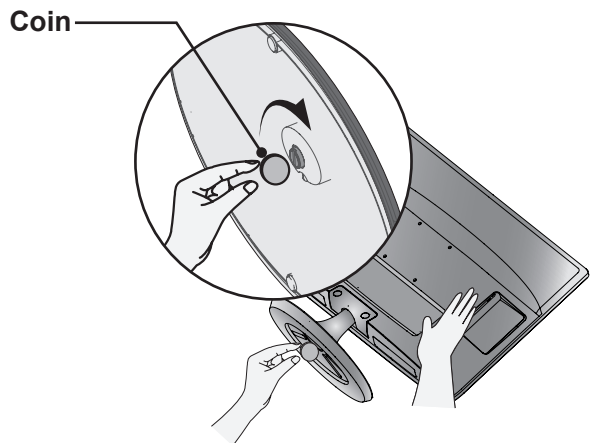

STAND INSTALLATION

■ The image shown may be somewhat different from your set.

- 1 Carefully place the product screen side down on a cushioned surface that will protect product and screen from damage.

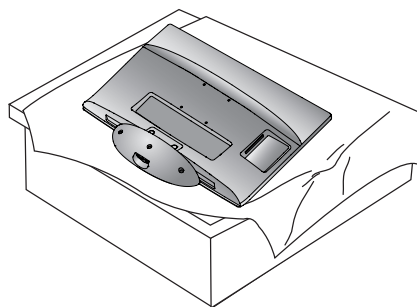

- 2 Insert the **Stand Base** into the product.

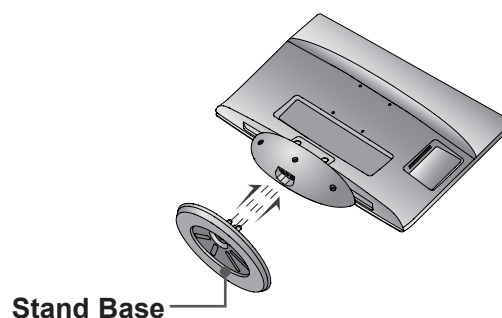

- 3 Use a **Coin** on the bottom of the stand base and turn the screw clockwise to tighten.

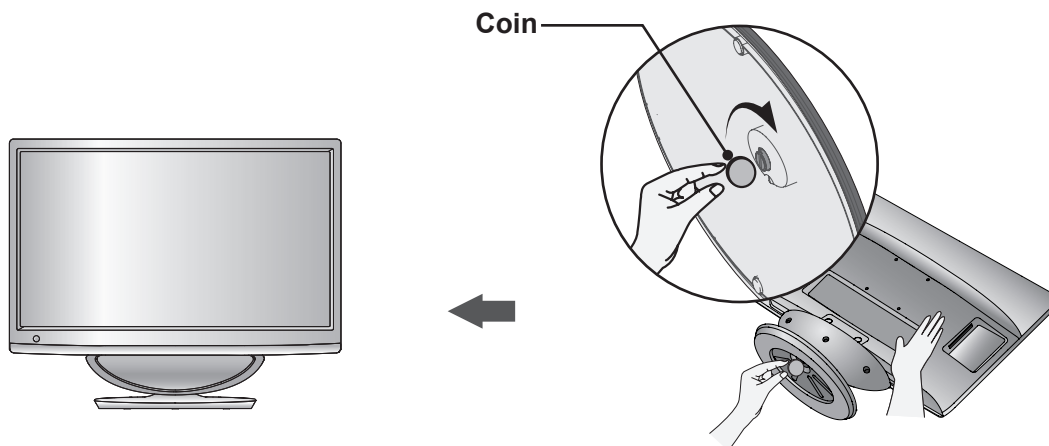

PREPARATION

M2080DB/M2280DB/M2380DB

STAND INSTALLATION

■ The image shown may be somewhat different from your set.

1 Carefully place the product screen side down on a cushioned surface that will protect product and screen from damage.

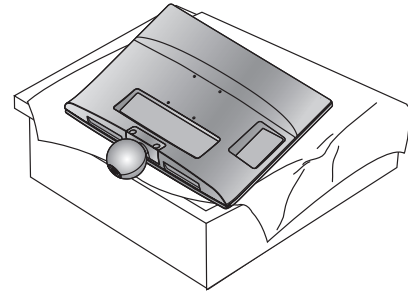

2 Insert the **Stand Base** into the product.

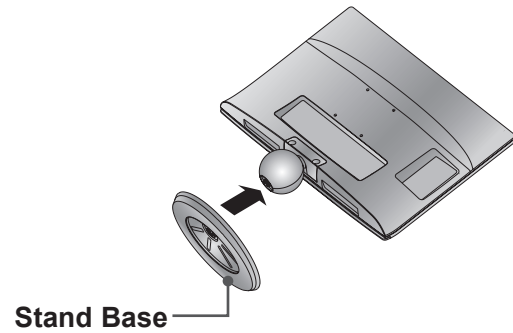

3 Use a **Coin** on the bottom of the stand base and turn the screw clockwise to tighten.

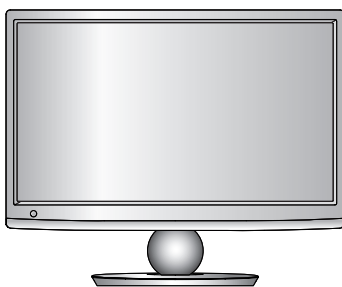
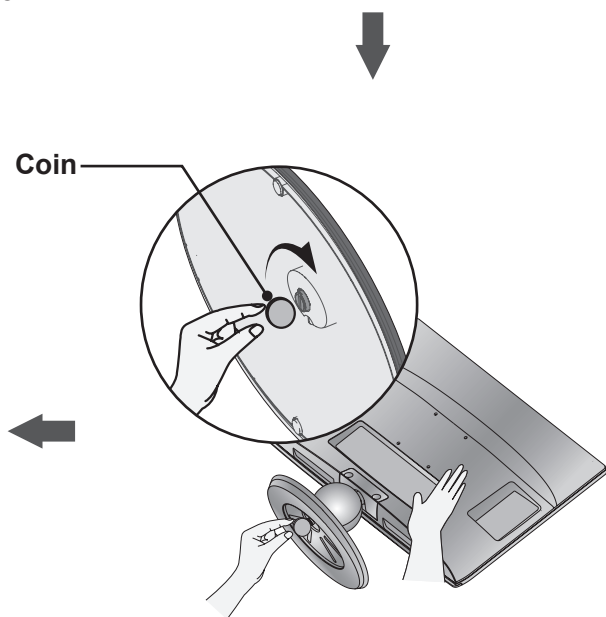

DETACHING STAND

■ The image shown may be somewhat different from your set.

1 Place the set screen side down on a cushion or soft cloth.

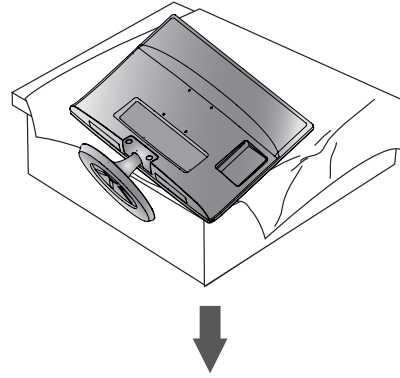

2 Detach the monitor to the **Stand Base** by turning the screw to the left.
Turn the screw by using a **Coin**.

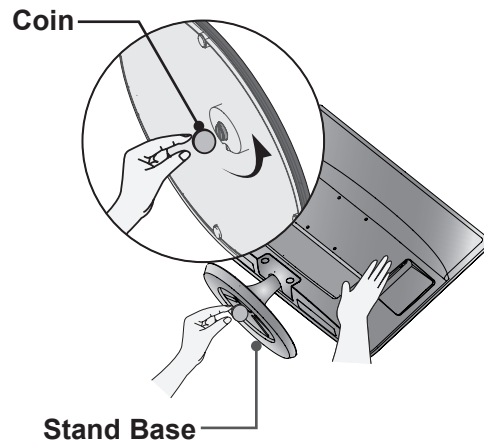

3 Pull the stand base.

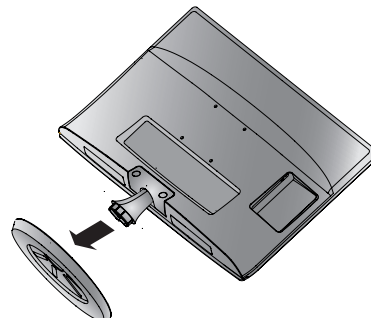

PREPARATION

M2080DF/M2280DF/M2380DF/M2780DF

DETACHING STAND

■ The image shown may be somewhat different from your set.

1 Place the set screen side down on a cushion or soft cloth.

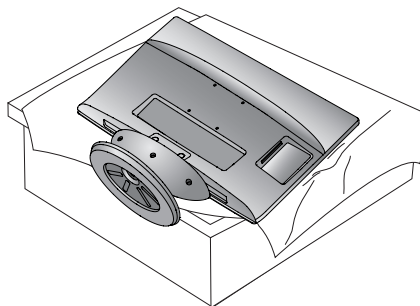

2 Detach the monitor to the **Stand Base** by turning the screw to the left.
Turn the screw by using a **Coin**.

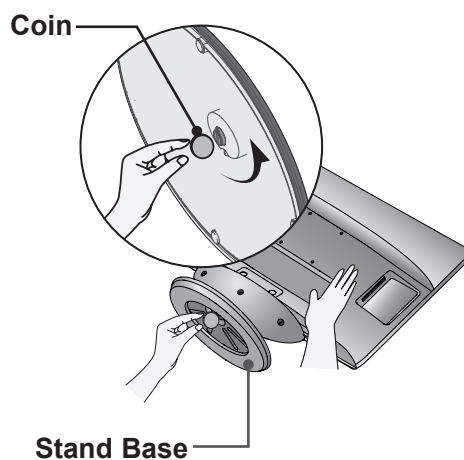

3 Pull the stand base.

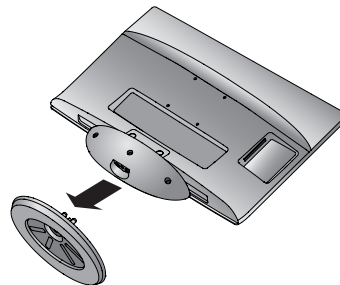

DETACHING STAND

■ The image shown may be somewhat different from your set.

1 Place the set screen side down on a cushion or soft cloth.

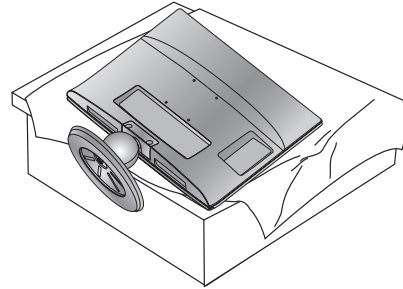

2 Detach the monitor to the **Stand Base** by turning the screw to the left.
Turn the screw by using a **Coin**.

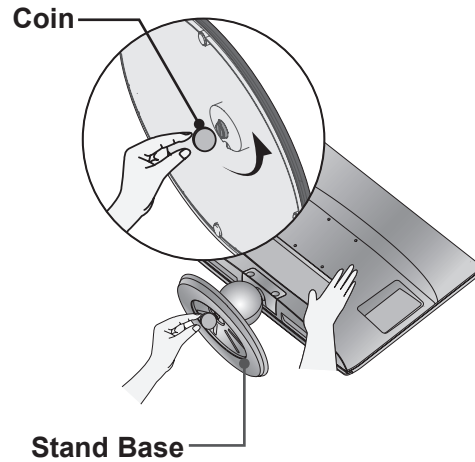

3 Pull the stand base.

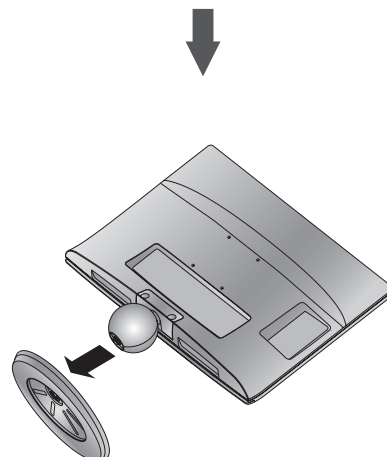

PREPARATION

DETACHING STAND BODY

- The image shown may be somewhat different from your set.
- Remove the Stand Body in the same way as the following when using it as a Wall Hook.

1. Remove the screw 2 point.
2. Pull the stand body.

M2080D / M2280D
M2380D / M2780D



M2080DB / M2280DB
M2380DB



3. Assemble the screw 2 point

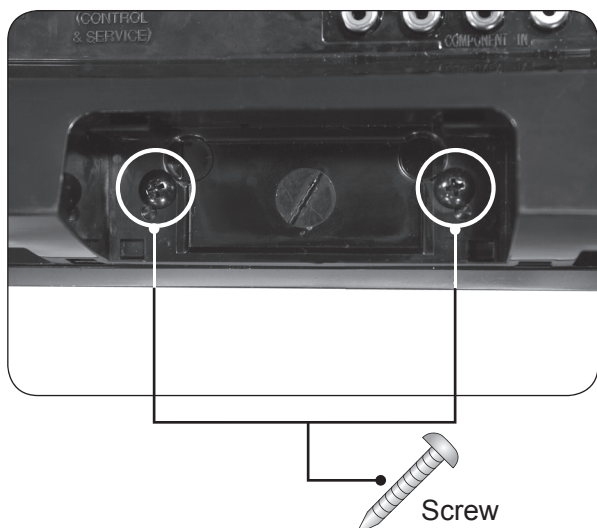

WALL MOUNT : HORIZONTAL INSTALLATION

For proper ventilation, allow a clearance of 10 cm on each side and from the wall. Detailed installation instructions are available from your dealer, see the optional Tilt Wall Mounting Bracket Installation and Setup Guide.

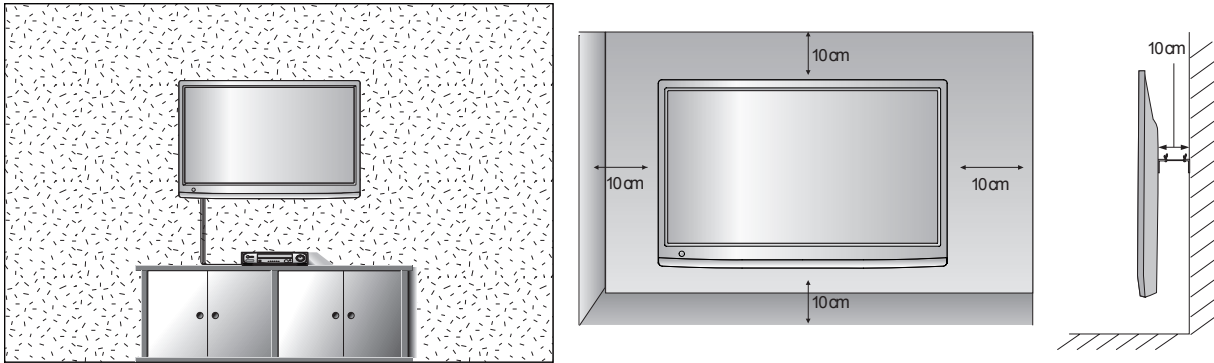

If you intend to mount the set to a wall, attach Wall mounting interface (optional parts) to the back of the set. When you install the set using the wall mounting interface (optional parts), attach it carefully so it will not drop.

1. Be sure to use screws and a wall mount that meet VESA standards.
2. Using screws longer than those recommended might damage the product.
3. Using screws that do not meet VESA standards might either damage the product or result in it coming away from the wall. We will not be held responsible for any damage resulting from failure to follow these instructions.
4. VESA compatible only with respect to screw mounting interface dimensions and mounting screw specifications
5. Please use VESA standard as below.
 - 5-1) 784.8 mm (30.9 inch) and under
 - * Wall Mount Pad Thickness : 2.6 mm
 - * Screw : Φ 4.0 mm x Pitch 0.7 mm x Length 10 mm
 - 5-2) 787.4 mm (31.0 inch) and above
 - * Please use VESA standard wall mount pad and screws.

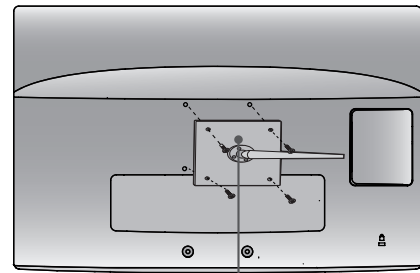

Wall Mount Pad

< Screw Mounting Interface Dimensions >

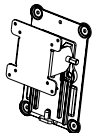
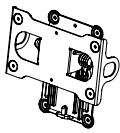
Model	M2080D M2280D M2380D M2080DF M2380DF M2380DF	M2080DB M2280DB M2380DB M2080DN M2380DN M2380DN	M2780D M2780DF M2780DN
VESA (A x B)	75 x 75		200 x 100
Wall mount bracket(optional)	RW120 		RW240 

PREPARATION

DESKTOP PEDESTAL INSTALLATION

- The image shown may be somewhat different from your set.
For proper ventilation, allow a clearance of 10 cm on each side and from the wall.

PREPARATION

**M2080D / M2280D
M2380D / M2780D**

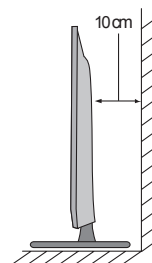
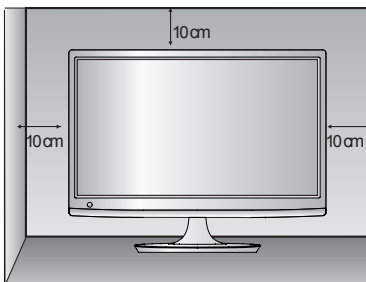
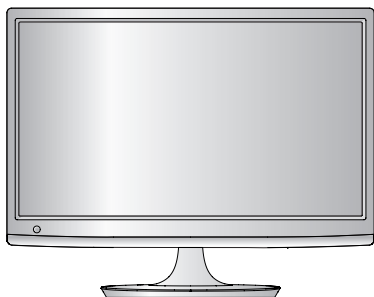

**M2080DF / M2280DF
M2380DF / M2780DF**

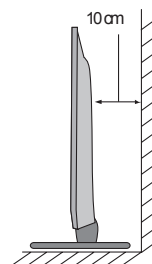
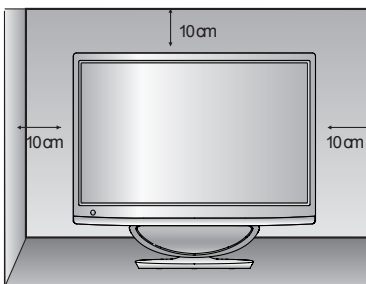
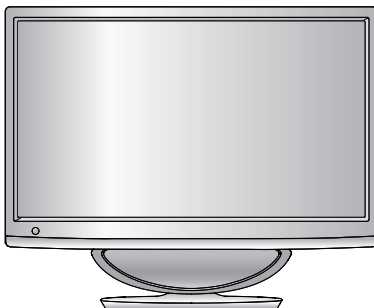

**M2080DB / M2280DB
M2380DB**

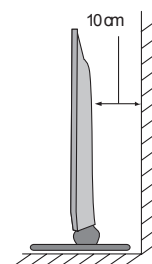
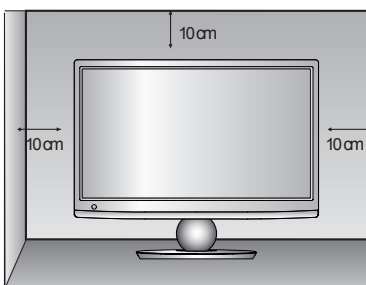
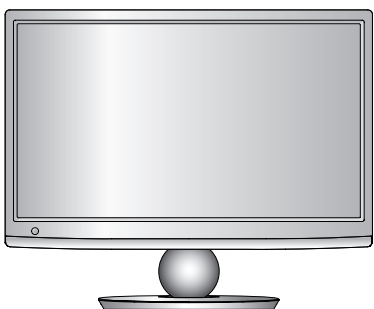

POSITIONING YOUR DISPLAY

- The image shown may be somewhat different from your set.

* Tilt range

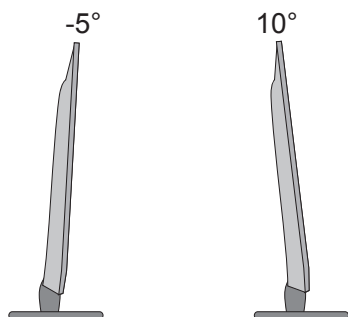

Adjust the position of the panel in various ways for maximum comfort.

SWIVEL STAND(Only M2780D / M2780DF)

- The image shown may be somewhat different from your set.

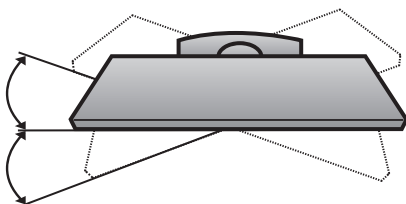

After installing the set, you can adjust the set manually to the left or right direction by 179 degrees to suit your viewing position.

LOCATION

Position your set so that no bright light or sunlight falls directly onto the screen. Care should be taken not to expose the set to any unnecessary vibration, moisture, dust or heat. Also, ensure that the set is placed in a position to allow a free flow of air. Do not cover the ventilation openings on the back cover.

! WARNING

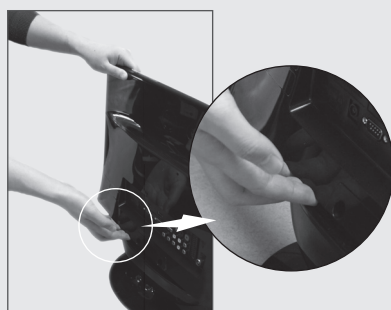
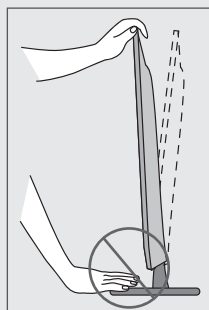

- When adjusting the angle of the screen, do not put your finger(s) in between the head of the monitor and the stand body or woofer.
You can hurt your finger(s).

M2080DF / M2280DF / M2380DF / M2780DF

PREPARATION

KENSINGTON SECURITY SYSTEM

- The product is equipped with a Kensington Security System connector on the back panel. Connect the Kensington Security System cable as shown below.
- For detailed installation and use of the Kensington Security System, refer to the user's guide provided with the Kensington Security System.

For further information, contact <http://www.kensington.com>, the internet homepage of the Kensington company. Kensington sells security systems for expensive electronic equipment such as notebook PCs and LCD projectors.

NOTE

- The Kensington Security System is an optional accessory.

NOTES

- If the product feels cold to the touch, there may be a small "flicker" when it is turned on. This is normal, there is nothing wrong with product.
- Some minute dot defects may be visible on the screen, appearing as tiny red, green, or blue spots. However, they have no adverse effect on the monitor's performance.
- Avoid touching the LCD screen or holding your finger(s) against it for long periods of time. Doing so may produce some temporary distortion effects on the screen.

**M2080D / M2280D
M2380D / M2780D**

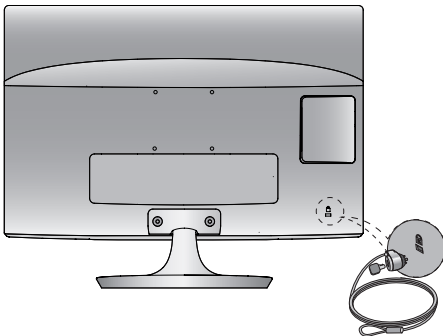

**M2080DF / M2280DF
M2380DF / M2780DF**

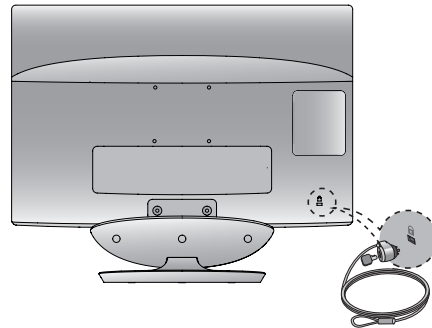

**M2080DB / M2280DB
M2380DB**

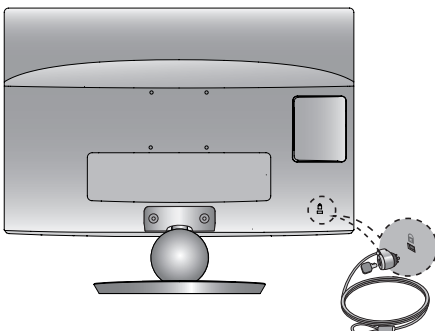

**M2080DN / M2280DN
M2380DN / M2780DN**

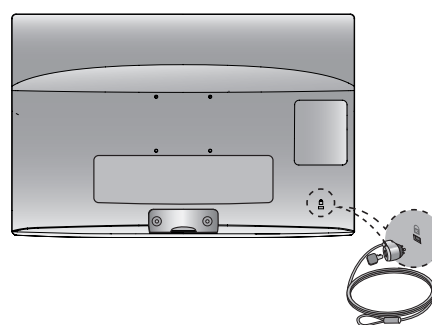

EXTERNAL EQUIPMENT SETUP

- To prevent damage do not connect to the mains outlet until all connections are made between the devices.

ANTENNA CONNECTION

- For optimum picture quality, adjust antenna direction.
- An antenna cable and converter are not supplied.

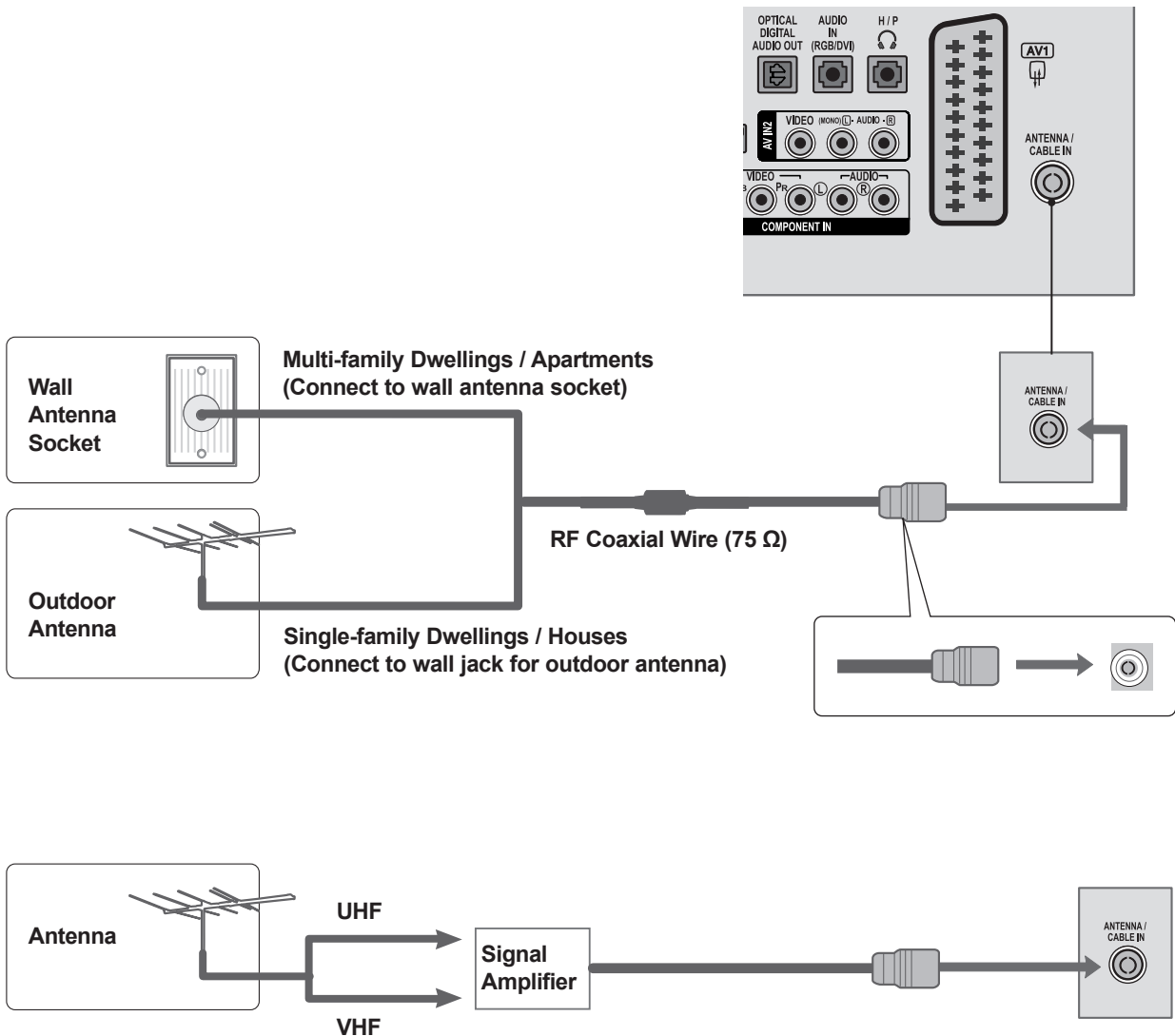

- In poor signal areas, to get better picture quality, install a signal amplifier to the antenna as shown above.
- If signal needs to be split for two sets, use an antenna signal splitter for connection.

EXTERNAL EQUIPMENT SETUP

- To avoid damaging any equipment, never plug in any power cords until you have finished connecting all equipment.
- The image shown may be somewhat different from your set.

HD RECEIVER SETUP

Connecting with a component cable

- 1 Connect the video outputs (Y, PB, PR) of the digital set-top box to the **COMPONENT IN VIDEO** jacks on the SET.
- 2 Connect the audio output of the digital set-top box to the **COMPONENT IN AUDIO** jacks on the SET.
- 3 Turn on the digital set-top box.
(Refer to the owner's manual for the digital set-top box.)
- 4 Select **COMPONENT** input source using the **INPUT** button on the remote control

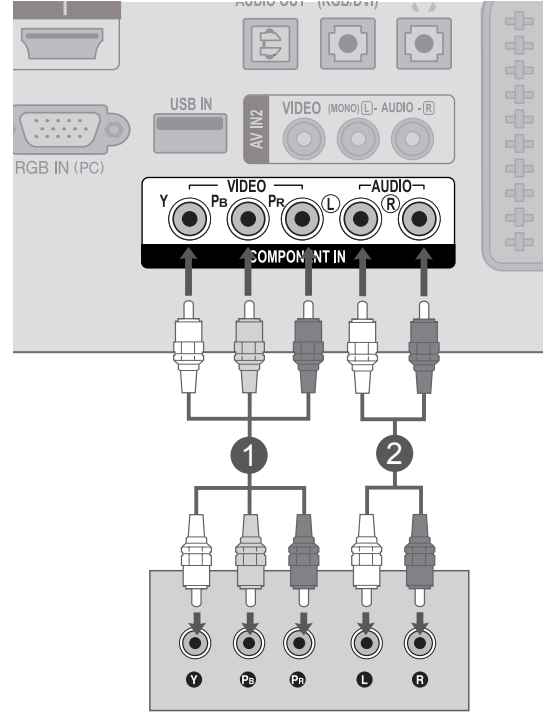

- **HDMI Audio Supported format : Dolby Digital, PCM**
DTS Audio format is not supported.

Signal	Component	HDMI
480i / 576i	YES	No
480p / 576p	YES	YES
720p / 1080i	YES	YES
1080p	YES (50 Hz / 60Hz only)	YES (24 Hz / 30 Hz / 50Hz / 60Hz)

Connecting a set-top box with a HDMI cable

- 1 Connect the digital set-top box to **HDMI/DVI IN 1** or **HDMI/DVI IN 2** jack on the SET
- 2 Turn on the digital set-top box.
(Refer to the owner's manual for the digital set-top box.)
- 3 Select **HDMI 1** or **HDMI 2** input source using the **INPUT** button on the remote control.

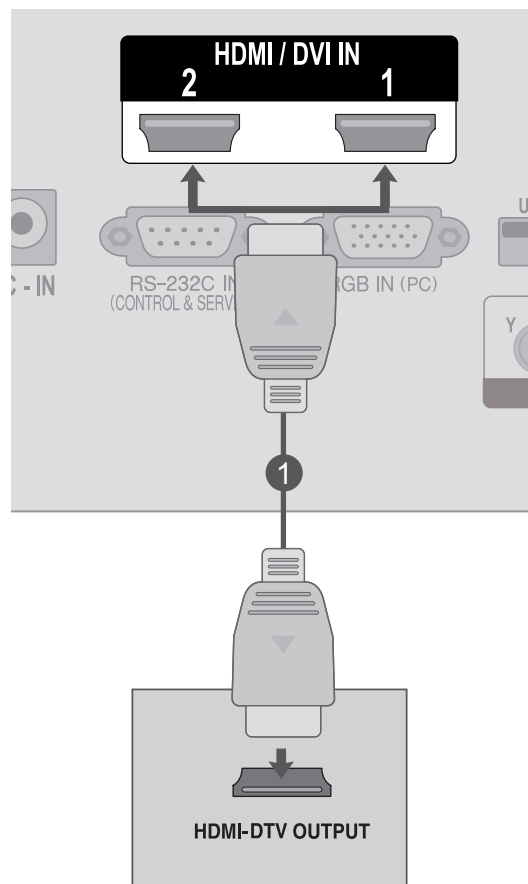

NOTE

- ▶ Check that your HDMI cable is High Speed HDMI Cable. If the HDMI cables are not High Speed HDMI Cable, flickering or no screen display can result. Please use the High Speed HDMI Cable.

EXTERNAL EQUIPMENT SETUP

Connecting with an HDMI to DVI cable

- 1 Connect the digital set-top box to **HDMI/DVI IN 1** or **HDMI/DVI IN 2** jack on the SET.
- 2 Connect the audio output of the digital set-top box to the **AUDIO IN (RGB/DVI)** jack on the SET.
- 3 Turn on the digital set-top box.
(Refer to the owner's manual for the digital set-top box.)
- 4 Select **HDMI 1** or **HDMI 2** input source using the **INPUT** button on the remote control.

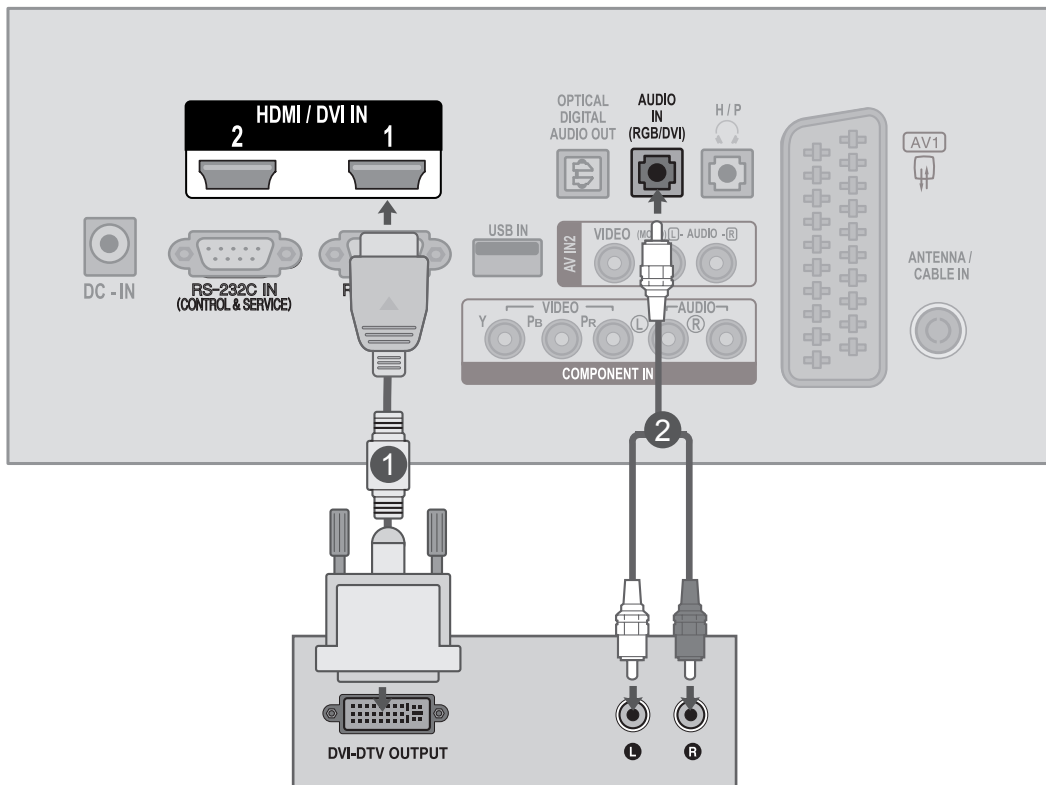

DVD SETUP

Connecting with a component cable

- 1 Connect the video outputs (Y, PB, PR) of the DVD to the **COMPONENT IN VIDEO** jacks on the SET.
- 2 Connect the audio outputs of the DVD to the **COMPONENT IN AUDIO** jacks on the SET.
- 3 Turn on the **DVD player**, insert a DVD.
- 4 Select **Component** input source using the **INPUT** button on the remote control.
- 5 Refer to the DVD player's manual for operating instructions.

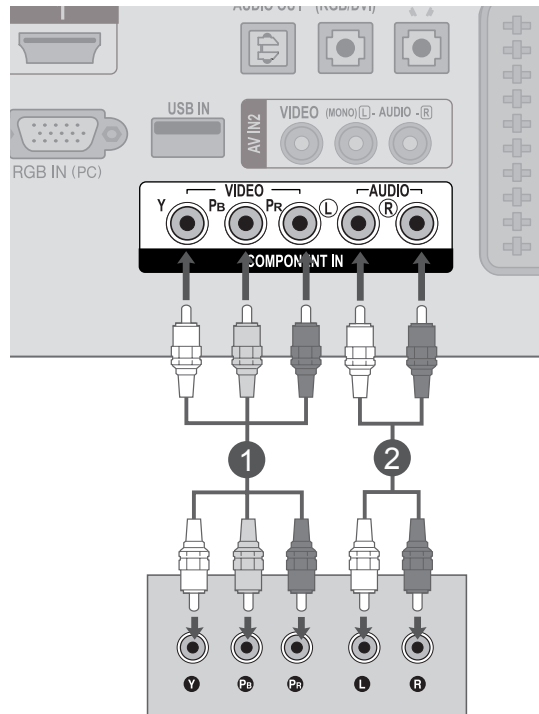

Component Input ports

To achieve better picture quality, connect a DVD player to the component input ports as shown below.

Component ports on the SET	Y	P _B	P _R
Video output ports on DVD player	Y	P _B	P _R
	Y	B-Y	R-Y
	Y	Cb	Cr
	Y	Pb	Pr

EXTERNAL EQUIPMENT SETUP

Connecting with a Euro Scart cable

- 1 Connect the Euro scart socket of the DVD to the **AV1** Euro scart socket on the SET.
- 2 Turn on the DVD player, insert a DVD.
- 3 Select **AV1** input source using the **INPUT** button on the remote control.
- 4 Refer to the DVD player's manual for operating instructions.

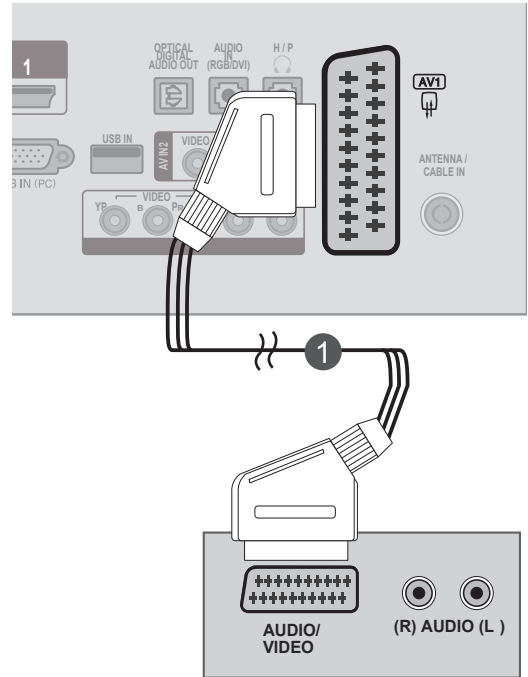

Scart	Input			Output
	Video	Audio	RGB	Video, Audio
AV1	O	O	O	Analogue TV, Digital TV

Current input mode	Output Type	AV1 (TV Out)	AV1 (When DTV scheduled recording is in progress using recording equipment)
	Digital TV	Digital TV	Digital TV
Analogue TV, AV	Analogue TV	Analogue TV	O (The input mode is converted to DTV)
Component / RGB	Analogue TV	Analogue TV	
HDMI	X	X	

▶ TV Out : Outputs Analogue TV or Digital TV signals.

! NOTE

- ▶ Signal type RGB, i.e. the signals red, green and blue can only be selected for the Euro scart and the AV 1 can be received. These signals are transmitted, for example, by a paid TV decoder, game machine or photo CD unit, etc.
- ▶ Please use shielded scart cable.

Connecting the HDMI cable

- 1 Connect the HDMI output of the DVD to the **HDMI/DVI IN 1** or **HDMI/DVI IN 2** jack on the SET
- 2 Select **HDMI 1** or **HDMI 2** input source using the **INPUT** button on the remote control.
- 3 Refer to the DVD player's manual for operating instructions.

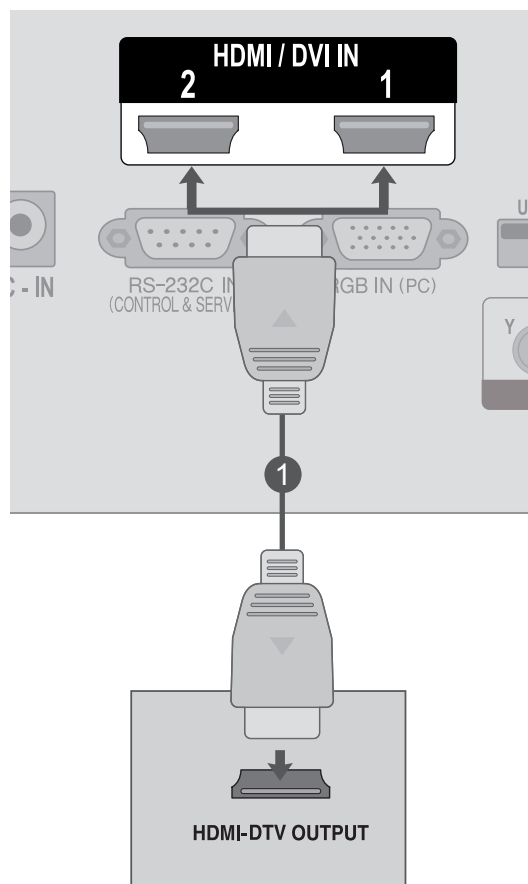

! NOTE

- ▶ Check that your HDMI cable is High Speed HDMI Cable. If the HDMI cables are not High Speed HDMI Cable, flickering or no screen display can result. Please use the High Speed HDMI Cable.

EXTERNAL EQUIPMENT SETUP

VCR SETUP

- To avoid picture noise (interference), allow adequate distance between the VCR and SET.

Connecting with a RF cable

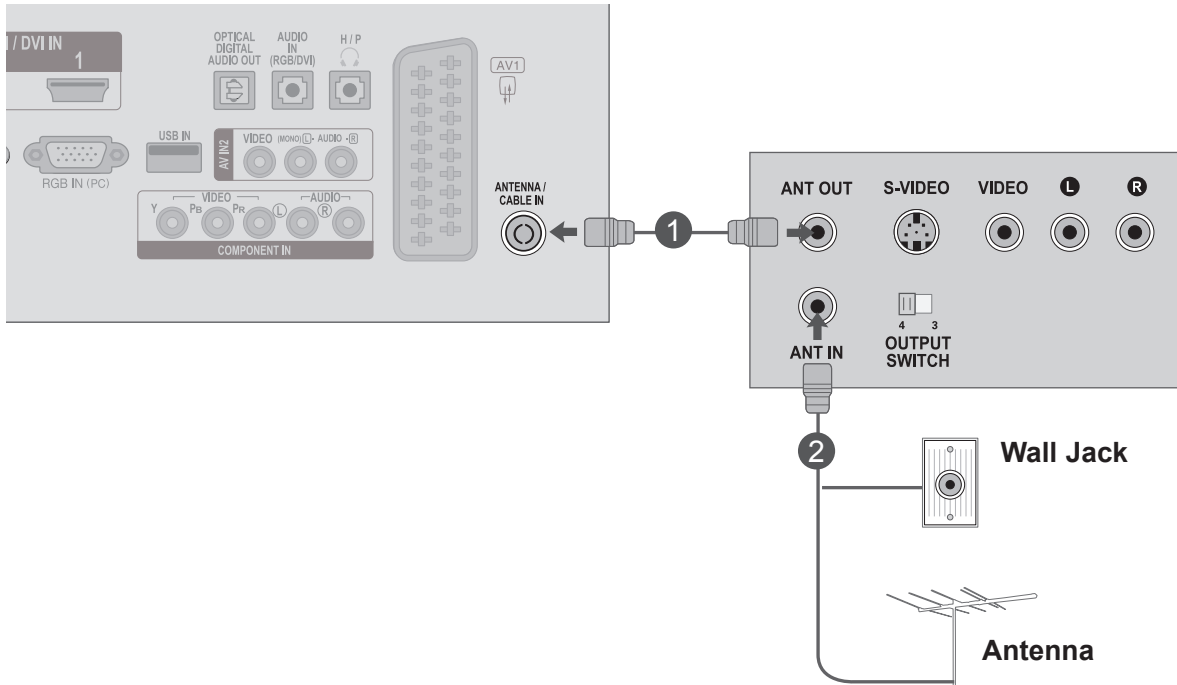

- 1 Connect the **ANT OUT** socket of the VCR to the **ANTENNA / CABLE IN** socket on the SET.
- 2 Connect the antenna cable to the **ANT IN** socket of the VCR.
- 3 Press the **PLAY** button on the **VCR** and match the appropriate channel between the SET and VCR for viewing.

Connecting with a Euro Scart cable

- 1 Connect the Euro scart socket of the VCR to the AV1 Euro scart socket on the SET.
- 2 Insert a video tape into the VCR and press PLAY on the VCR. (Refer to the VCR owner's manual.)
- 3 Select **AV1** input source using the **INPUT** button on the remote control.
- 4 Refer to the VCR player's manual for operating instructions.

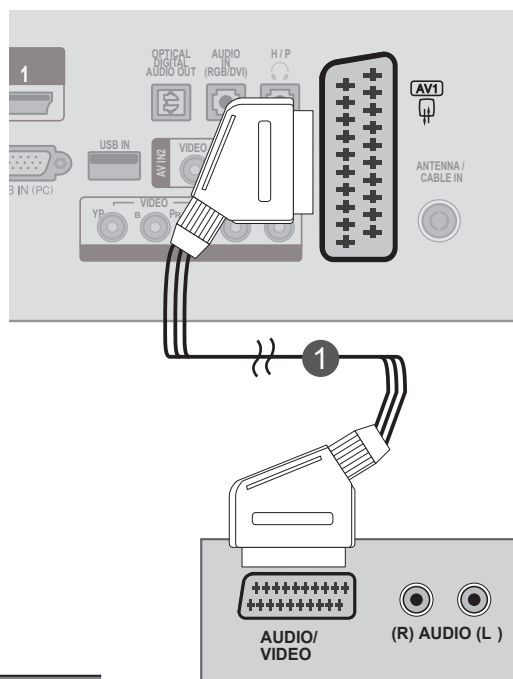

Scart	Input			Output
	Video	Audio	RGB	Video, Audio
AV1	O	O	O	Analogue TV, Digital TV

Current input mode \ Output Type	AV1 (TV Out)	AV1 (When DTV scheduled recording is in progress using recording equipment)
	Digital TV	Digital TV
Analogue TV, AV	Analogue TV	O (The input mode is converted to DTV)
Component / RGB	Analogue TV	
HDMI	X	

▶ TV Out : Outputs Analogue TV or Digital TV signals.

! NOTE

- ▶ Signal type RGB, i.e. the signals red, green and blue can only be selected for the Euro scart and the AV 1 can be received. These signals are transmitted, for example, by a paid TV decoder, game machine or photo CD unit, etc.
- ▶ Please use shielded scart cable.

EXTERNAL EQUIPMENT SETUP

Connecting with a RCA cable

- 1 Connect the **AUDIO/VIDEO** jacks between SET and VCR. Match the jack colours (Video = yellow, Audio Left = white, and Audio Right = red)
- 2 Insert a video tape into the **VCR** and press **PLAY** on the VCR. (Refer to the VCR owner's manual.)
- 3 Select **AV2** input source using the **INPUT** button on the remote control.

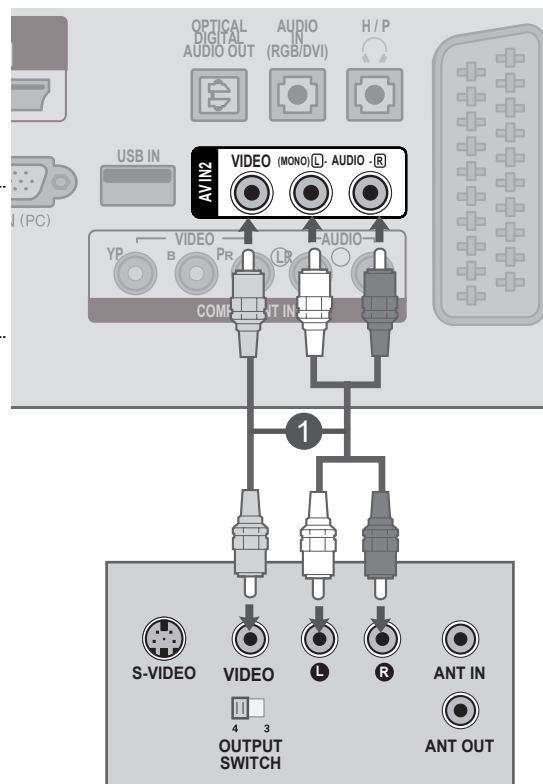

! NOTE

- ▶ If you have a mono VCR, connect the audio cable from the VCR to the **AUDIO L / MONO** jack of the SET.

INSERTION OF CI MODULE

- To view the encrypted (pay) services in digital TV mode.
- This feature is not available in all countries.

- 1 Insert the CI Module to **PCMCIA** (Personal Computer Memory Card International Association) **CARD SLOT** of SET as shown.

For further information, see p.61

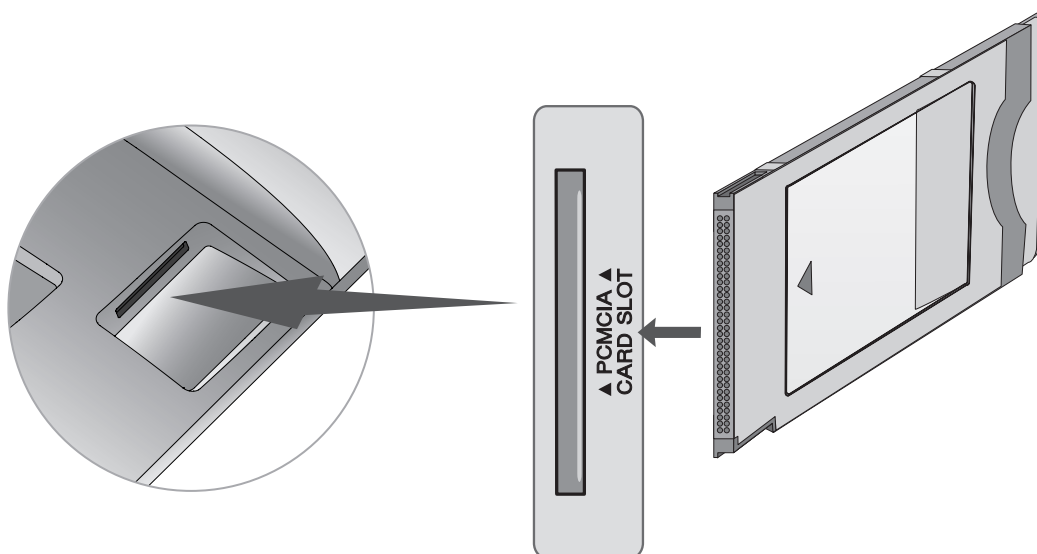

NOTE

- Check if the CI module is inserted into the PCMCIA card slot in the right direction. If the module is not inserted properly, this can cause damage to the TV and the PCMCIA card slot.

EXTERNAL EQUIPMENT SETUP

DIGITAL AUDIO OUT SETUP

Sending the TV's audio signal to external audio equipment via the Digital Audio Output (Optical) port.
If you want to enjoy digital broadcasting through 5.1-channel speakers, connect the OPTICAL DIGITAL AUDIO OUT terminal on the back of TV to a Home Theater (or amp).

- 1 Connect one end of an optical cable to the TV Digital Audio (Optical) Output port.
- 2 Connect the other end of the optical cable to the digital audio (Optical) input on the audio equipment.
- 3 Set the "TV Speaker option - Off" in the AUDIO menu. (▶ P. 92)
Refer to the external audio equipment instruction manual for operation.

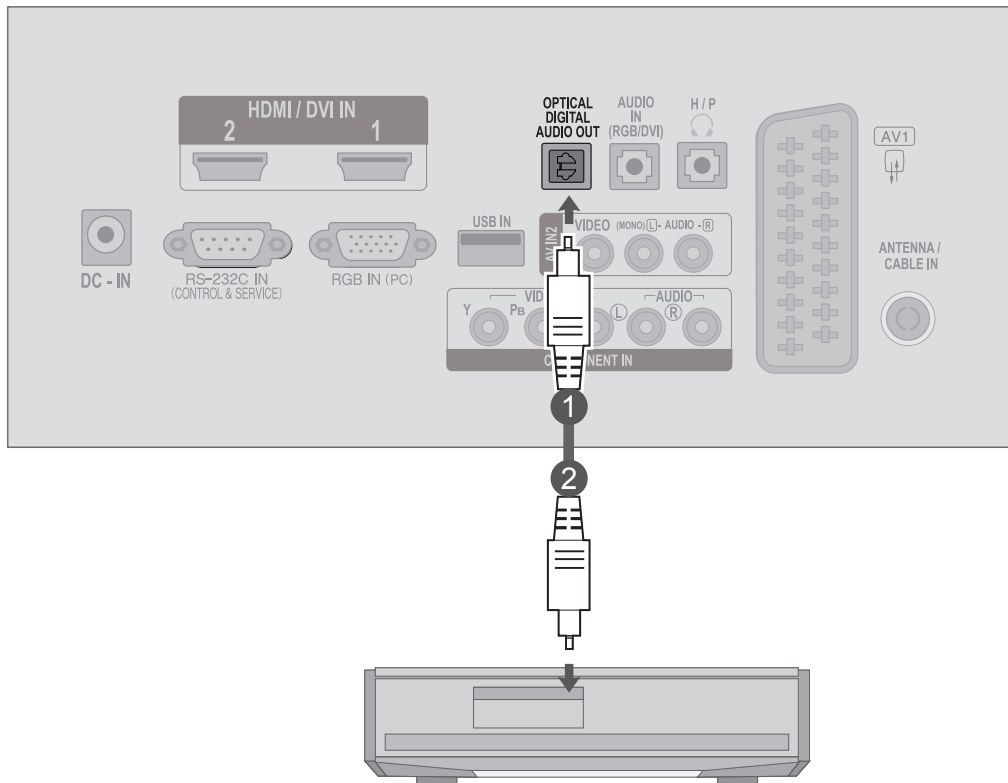

⚠ CAUTION

▶ Do not look into the optical output port. Looking at the laser beam may damage your vision.

USB SETUP

- 1 Connect the USB device to the **USB IN** jacks on the side of SET.
- 2 After connecting the **USB IN** jacks, you use the **USB** function. (▶ p.113)

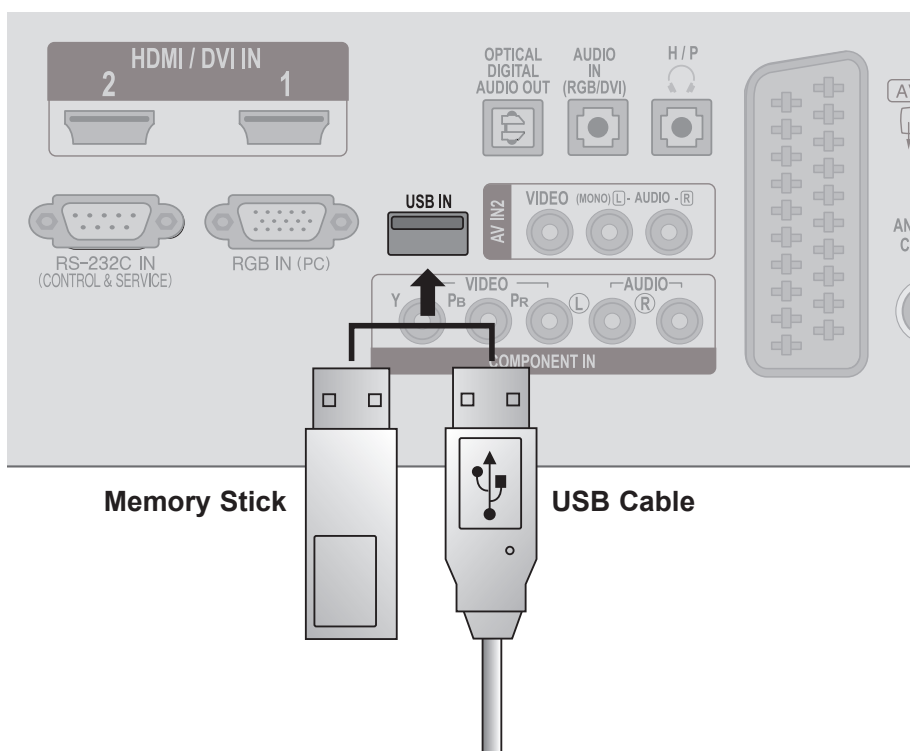

EXTERNAL EQUIPMENT SETUP

HEADPHONE SETUP

You can listen the sound through the headphone.

- 1 Plug the headphone into the **headphone** socket.
- 2 To adjust the **headphone volume**, press the  + or - button. If you press the **MUTE** button, the sound from the headphone is switched off.

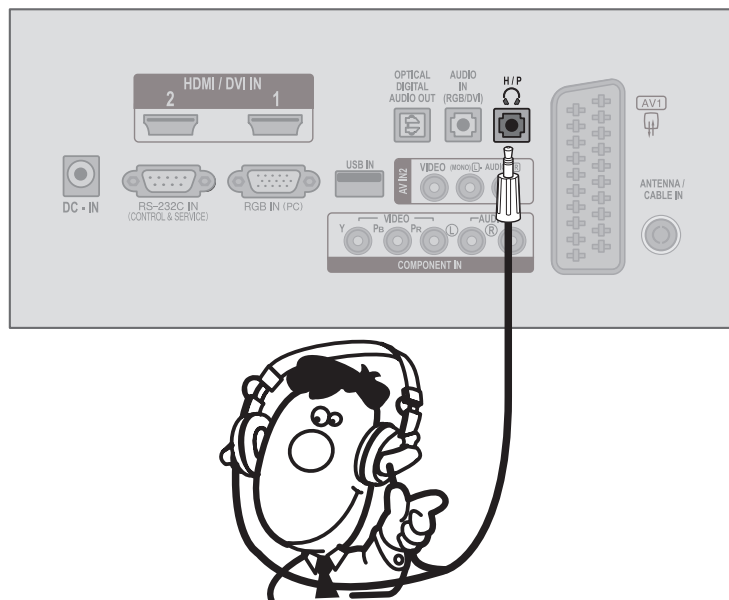

! NOTE

- ▶ AUDIO menu items are disabled when connecting a headphone.
- ▶ Optical Digital Audio Out is not available when connecting a headphone.

OTHER A/V SOURCE SETUP

- 1 Connect the **AUDIO / VIDEO** jacks between SET and external equipment. Match the jack colours.
(Video = yellow, Audio Left = white, and Audio Right = red)
- 2 Select **AV2** input source with using the **INPUT** button on the remote control.
- 3 Operate the corresponding external equipment.
Refer to external equipment operating guide.

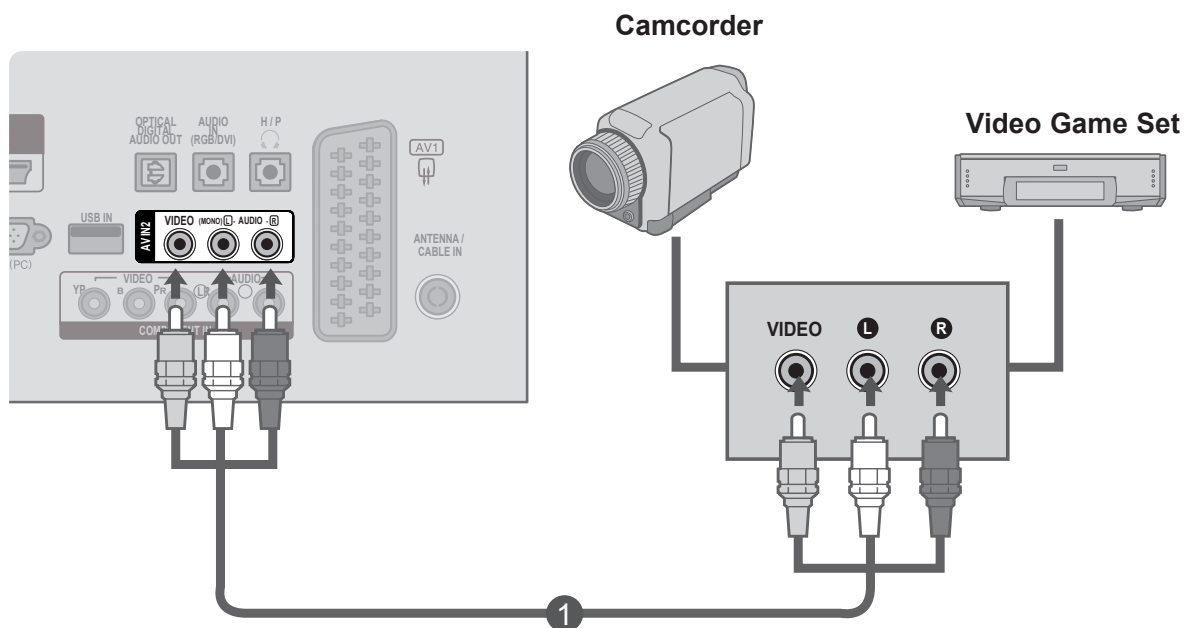

EXTERNAL EQUIPMENT SETUP

PC SETUP

When using the remote control, aim it at the remote control sensor on the SET.

When connecting with a D-sub 15 pin cable

- 1 Connect the signal cable from the monitor output socket of the **PERSONAL COMPUTER** to the **PC input** socket of the SET.
- 2 Connect the audio cable from the **PC** to the **AUDIO IN (RGB/DVI)** sockets of the SET.
- 3 Press the **INPUT** button to select **RGB**.
- 4 Switch on the **PC**, and the **PC** screen appears on the set. The set can be operated as a PC monitor.

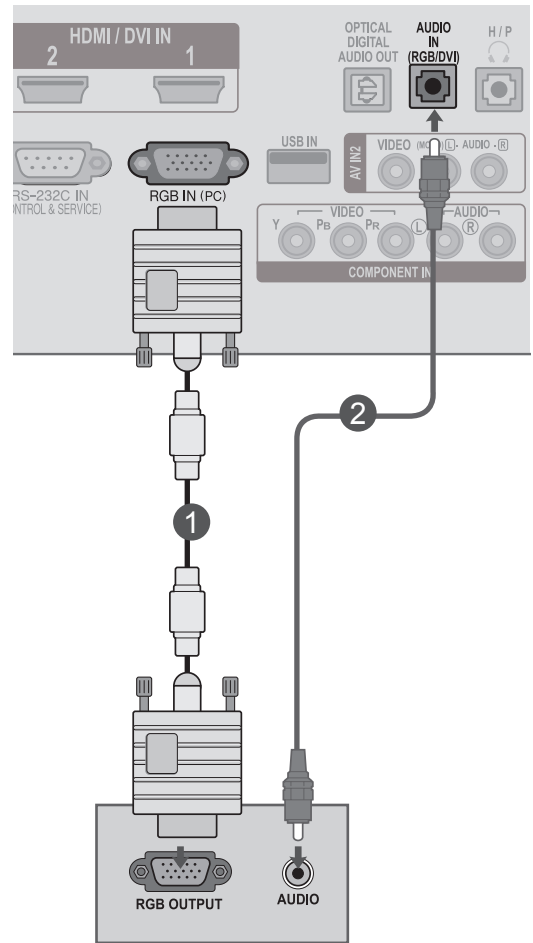

NOTE

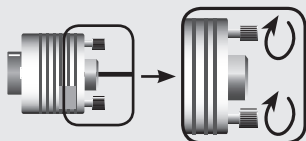

- ▶ Connect the signal input cable and tighten it up by turning in the direction of the arrow as shown in the figure.

Connecting with an HDMI to DVI cable

- 1 Connect the DVI output of the PC to the **HDMI/DVI IN1** or **HDMI/DVI IN2** jack on the SET.
- 2 Connect the PC audio output to the **AUDIO IN (RGB/DVI)** jack on the SET.
- 3 Turn on the PC and the SET.
- 4 Select **HDMI 1** or **HDMI 2** input source using the **INPUT** button on the remote control.

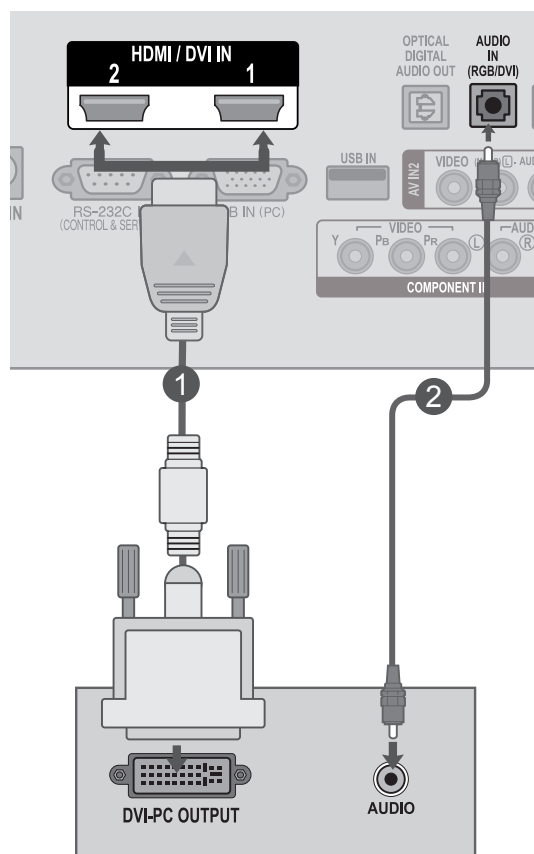

! NOTE

- ▶ If you want to use HDMI-PC mode, you must set the input label to PC mode.

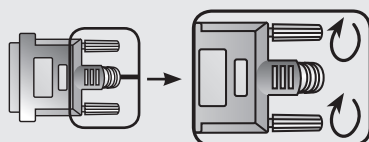

- ▶ Connect the signal input cable and tighten it up by turning in the direction of the arrow as shown in the figure.

EXTERNAL EQUIPMENT SETUP

Connecting with an HDMI to HDMI cable

- 1 Connect the HDMI output of the PC to the **HDMI/DVI IN1** or **HDMI/DVI IN2** jack on the SET.
- 2 Turn on the PC and the SET.
- 3 Select **HDMI 1** or **HDMI 2** input source using the **INPUT** button on the remote control.

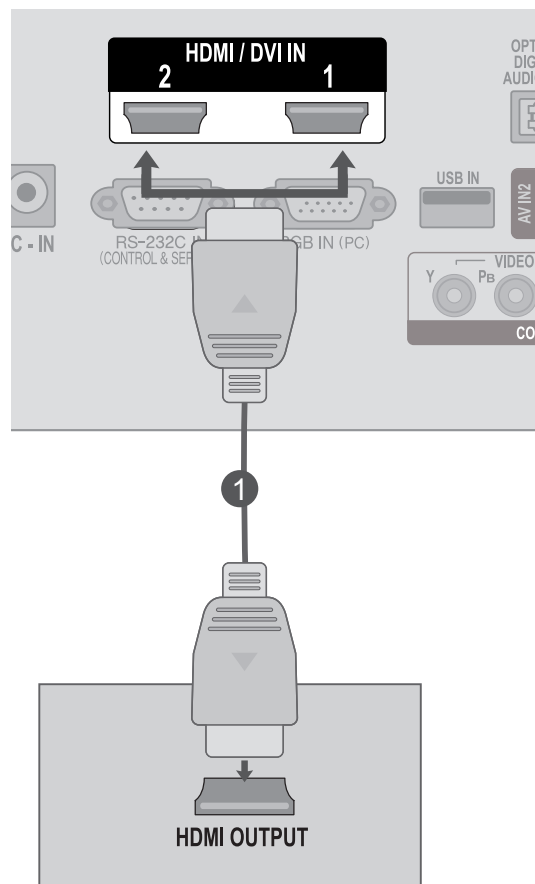

! NOTE

- ▶ Check that your HDMI cable is High Speed HDMI Cable. If the HDMI cables are not High Speed HDMI Cable, flickering or no screen display can result. Please use the High Speed HDMI Cable.
- ▶ If you want to use HDMI-PC mode, you must set the input label to PC mode.

BACK COVER FOR WIRE ARRANGEMENT

Tie cables together with a cable management as shown in the illustration.

**M2080D / M2280D
M2380D / M2780D**

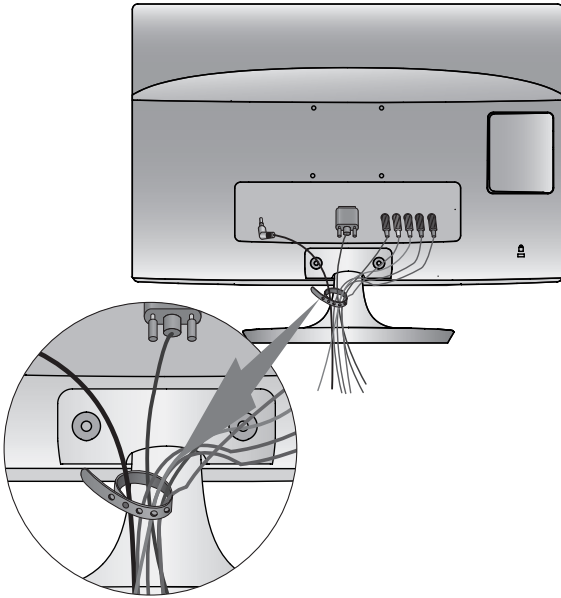

**M2080DF / M2280DF
M2380DF / M2780DF**

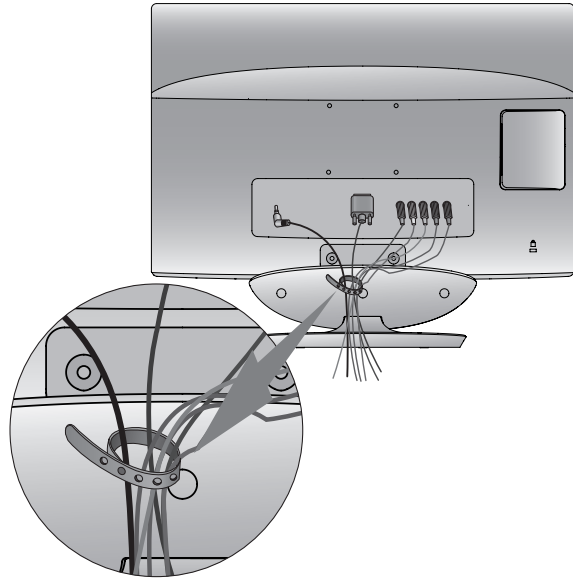

**M2080DB / M2280DB
M2380DB**

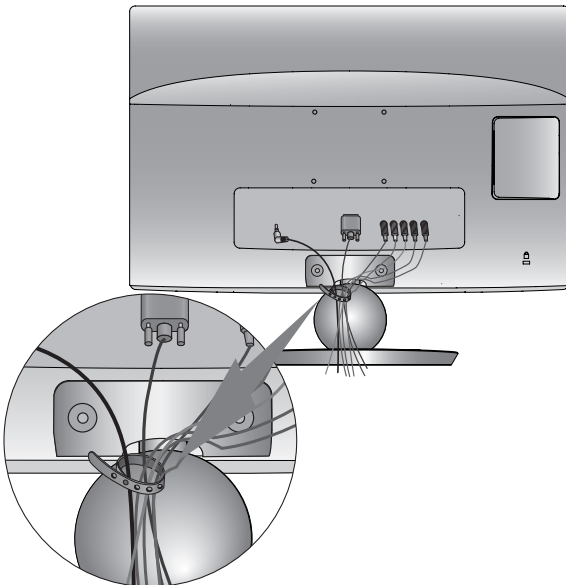

**M2080DN / M2280DN
M2380DN / M2780DN**

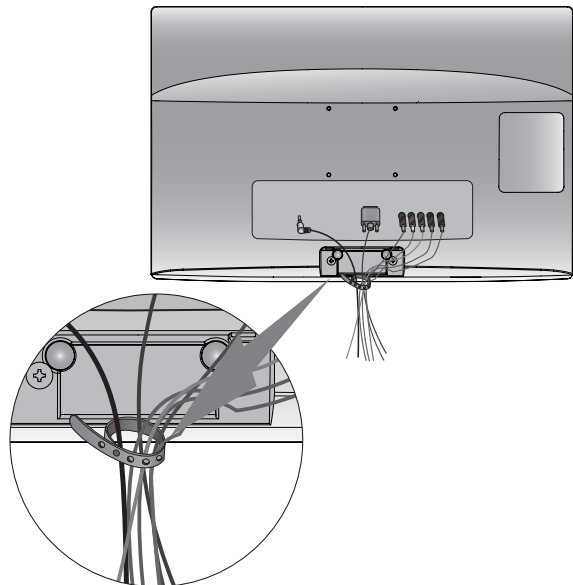

EXTERNAL EQUIPMENT SETUP

SUPPORTED DISPLAY RESOLUTION

RGB[PC] mode

M2080D / M2080DF / M2080DB / M2080DN

Resolution	Horizontal Frequency(kHz)	Vertical Frequency(Hz)
640 x 480	31.469	59.94
640 x 480	37.5	75
800 x 600	37.879	60.317
800 x 600	46.875	75
832 x 624	49.725	64.55
1024 x 768	48.363	60
1024 x 768	60.023	75.029
1280 x 1024	63.981	60.02
1600 x 900	60	60

M2280D / M2380D / M2780D / M2280DF / M2380DF / M2780DF / M2280DB / M2380DB / M2280DN / M2380DN / M2780DN

Resolution	Horizontal Frequency(kHz)	Vertical Frequency(Hz)
720 x 400	31.468	70.08
640 x 480	31.469	59.94
640 x 480	37.5	75
800 x 600	37.879	60.317
800 x 600	46.875	75.0
1024 x 768	48.363	60.0
1024 x 768	60.023	75.029
1152 x 864	67.500	75.000
1280 x 1024	63.981	60.02
1280 x 1024	79.976	75.025
1680 x 1050	64.674	59.883
1680 x 1050	65.290	59.954
1600 x 1200	75.0	60.0
1920 x 1080	67.5	60

HDMI/DVI - PC mode

M2080D / M2080DF / M2080DB / M2080DN

Resolution	Horizontal Frequency(kHz)	Vertical Frequency(Hz)
640 x 480	31.469	59.94
640 x 480	37.5	75
800 x 600	37.879	60.317
800 x 600	46.875	75
832 x 624	49.725	64.55
1024 x 768	48.363	60
1024 x 768	60.023	75.029
1152 x 870	68.681	75.062
1280 x 1024	63.981	60.02
1600 x 900	60	60

M2280D / M2380D / M2780D / M2280DF / M2380DF / M2780DF / M2280DB / M2380DB / M2280DN / M2380DN / M2780DN

Resolution	Horizontal Frequency(kHz)	Vertical Frequency(Hz)
720 x 400	31.468	70.08
640 x 480	31.469	59.94
640 x 480	37.5	75
800 x 600	37.879	60.317
800 x 600	46.875	75.0
1024 x 768	48.363	60.0
1024 x 768	60.023	75.029
1152 x 864	67.500	75.000
1280 x 1024	63.981	60.02
1280 x 1024	79.976	75.025
1680 x 1050	64.674	59.883
1680 x 1050	65.290	59.954
1600 x 1200	75.0	60.0
1920 x 1080	67.5	60

HDMI/DVI - DTV mode

Resolution	Horizontal Frequency(kHz)	Vertical Frequency(Hz)
720 x 480	31.469	59.94
	31.5	60
720 x 576	31.25	50
1280 x 720	37.500	50
1280 x 720	44.96	59.94
	45	60
1920 x 1080	33.72	59.94
	33.75	60
1920 x 1080	28.125	50.00
1920 x 1080	27	24
1920 x 1080	33.75	30.00
1920 x 1080	56.250	50
1920 x 1080	67.43	59.94
	67.5	60

Component mode

Resolution	Horizontal Frequency(kHz)	Vertical Frequency(Hz)
720 x 480	15.73	59.94
720 x 480	15.75	60.00
720 x 576	15.625	50.00
720 x 480	31.47	59.94
720 x 480	31.50	60.00
720 x 576	31.25	50.00
1280 x 720	44.96	59.94
1280 x 720	45.00	60.00
1280 x 720	37.50	50.00
1920 x 1080	33.72	59.94
1920 x 1080	33.75	60.00
1920 x 1080	28.125	50.00
1920 x 1080	56.25	50
1920 x 1080	67.432	59.94
1920 x 1080	67.5	60.00

! NOTE

- ▶ Avoid keeping a fixed image on the set's screen for prolonged periods of time. The fixed image may become permanently imprinted on the screen use a screen saver when possible.
- ▶ There may be interference relating to resolution, vertical pattern, contrast or brightness in PC mode. Change the PC mode to another resolution or change the refresh rate to another rate or adjust the brightness and contrast on the menu until the picture is clear. If the refresh rate of the PC graphic card can not be changed, change the PC graphic card or consult the manufacturer of the PC graphic card.
- ▶ The synchronization input waveform for Horizontal and Vertical frequencies are separate.
- ▶ Connect the signal cable from the monitor output port of the PC to the RGB (PC) port of the SET or the signal cable from the HDMI output port of the PC to the HDMI/DVI IN port on the SET.
- ▶ Connect the audio cable from the PC to the Audio input on the SET. (Audio cables are not included with the SET).
- ▶ If using a sound card, adjust PC sound as required.
- ▶ If the graphic card on the PC does not output analogue and digital RGB simultaneously, connect only one of either RGB or HDMI/DVI IN to display the PC output on the SET.
- ▶ If the graphic card on the PC does output analogue and digital RGB simultaneously, set the SET to either RGB or HDMI. (The other mode is set to Plug and Play automatically by the SET.)
- ▶ DOS mode may not work depending on the video card if you use an HDMI to DVI cable.
- ▶ If you use too long an RGB-PC cable that is too long, there may be interference on the screen. We recommend using under 5m of cable. This provides the best picture quality.

WATCHING TV / PROGRAMME CONTROL

REMOTE CONTROL KEY FUNCTIONS

When using the remote control, aim it at the remote control sensor on the set.

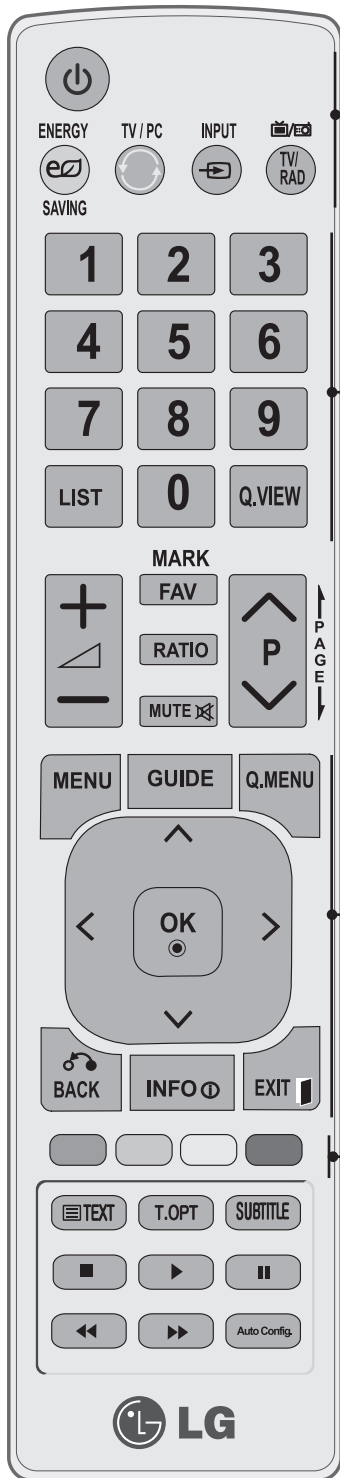

(POWER) Switches the set on from standby or off to standby.

ENERGY SAVING Adjust the Energy Saving mode of the SET. (▶ P. 72)

TV/PC Selects TV or PC mode.

INPUT External input mode rotates in regular sequence.

TV/RAD Selects Radio, TV and DTV channel.

0-9 number button Selects a programme.
Selects numbered items in a menu.

LIST Displays the programme table. (▶ P. 62)

Q.VIEW Returns to the previously viewed programme.

MENU Selects a menu.
Clears all on-screen displays and returns to TV viewing from any menu. (▶ P. 44)

GUIDE Shows programme schedule. (▶ P. 65 to 68)

Q. MENU Select the desired quick menu source. (Aspect Ratio, Clear Voice II, Picture Mode, Sound Mode, Audio, Sleep Timer, Favourite, USB Device). (▶ P.43)

THUMBSTICK (Up/Down/Left/Right) Allows you to navigate the on-screen menus and adjust the system settings to your preference.

OK Accepts your selection or displays the current mode.

BACK Allows the user to move return one step in an interactive application, EPG or other user interaction function.

INFO Shows the present screen information.

EXIT Clears all on-screen displays and returns to TV viewing from any menu

Coloured buttons These buttons are used for teletext (on TELETEXT buttons models only), Programme edit.

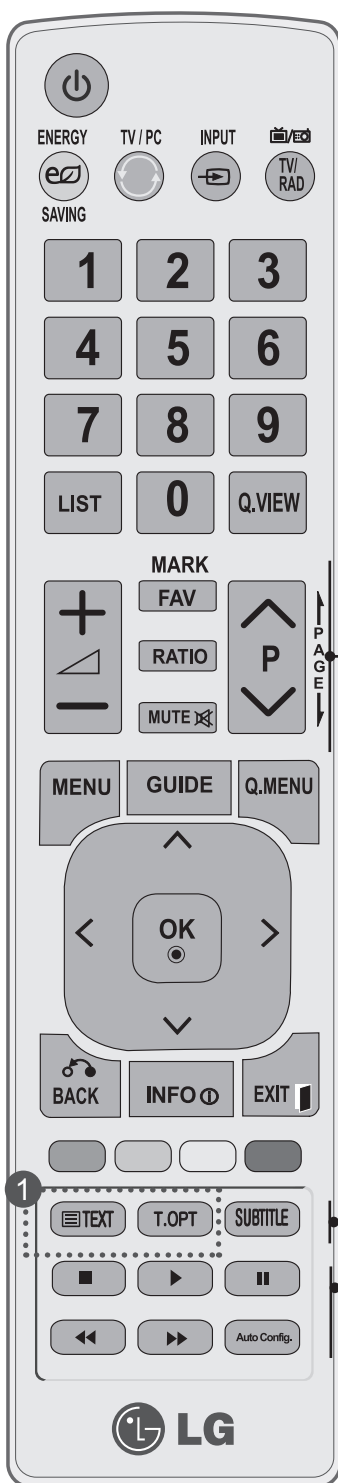

VOLUME UP/DOWN Adjusts the volume.

FAV Displays the selected favourite programme. (▶ P. 63)

MARK Check and un-check programmes in the USB menu.

RATIO Selects your desired Aspect Ratio of picture.

MUTE Switches the sound on or off.

Programme UP/DOWN Selects a programme.

PAGE UP/DOWN Move from one full set of screen information to the next one.

1 TELETEXT BUTTONS These buttons are used for teletext. For further details, see the 'Teletext' section. (▶ P. 134 to 135)

SUBTITLE Recalls your preferred subtitle in digital mode.

USB Menu control buttons USB menu(Photo List and Music List or Movie List).

Auto Config. Automatically adjusts picture position and minimizes image instability.

Installing Batteries

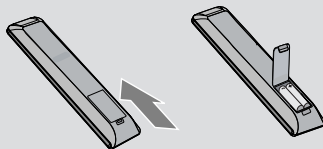

- Open the battery compartment cover on the back side and install the batteries matching correct polarity (+with +, -with -)
- Install two 1.5 V AAA batteries. Don't mix old or used batteries with new ones.
- Close cover.
- To remove the batteries, perform the installation actions in reverse.

WATCHING TV / PROGRAMME CONTROL

TURNING ON THE TV

- When your TV is turned on, you will be able to use its features.

- 1 Firstly, connect the power cord correctly.
At this stage, the TV switches to standby mode.
- 2 In standby mode to turn TV on, press the ϕ / I , **INPUT** or **P** \wedge \vee button on the TV or press the **POWER**, **INPUT**, **P** \wedge \vee or **NUMBER** button on the remote control and the TV will switch on.

Initializing setup

If the OSD (On Screen Display) is displayed on the screen after turning on the TV, you can adjust the **Language**, **Mode Setting**, **Country** or **Set Password** (When France is selected for Country), **Auto Tuning**.

Note:

- a. If you close without completing the initial setting, the Initial Setting menu can be displayed again.
- b. Press the BACK button to change the current OSD to the previous OSD.
- c. For those countries without confirmed DTV broadcasting standards, some DTV features might not work, depending on the DTV broadcasting environment.
- d. "Home Use" mode is the optimal setting for home environments, and is the TV's default mode.
- e. "Store Demo" mode is the optimal setting for store environments. If a user modifies image quality data, "Store Demo" mode initializes the product to the image quality set by us after a certain period of time.
- f. The mode (Home Use, Store Demo) can be changed by executing Mode Setting in the OPTION menu.
- g. When France is selected for Country, password is not '0', '0', '0', '0' but '1', '2', '3', '4'.

PROGRAMME SELECTION

- 1 Press the **P** \wedge \vee or **NUMBER** buttons to select a programme number.

VOLUME ADJUSTMENT

- 1 Press the \triangle + or - button to adjust the volume.
- 2 If you wish to switch the sound off, press the **MUTE** button.
You can cancel this function by pressing the **MUTE**, \triangle + , - button.

QUICK MENU

Your TV's OSD (On Screen Display) may differ slightly from that shown in this manual.

Q.Menu (Quick Menu) is a menu of features which users might use frequently.

- Aspect Ratio:** Selects your desired picture format. For Zoom Setting, select 14:9, Zoom and Cinema Zoom in Ratio Menu. After completing Zoom Setting, the display goes back to Q.Menu.
- Backlight:** Adjusts the brightness of the screen by controlling the LCD backlight.
- Picture Mode:** Selects your desired Picture Mode.
- Sound Mode:** It is a feature to automatically set the sound combination which it deems the best for the images being watched. Selects your desired Sound Mode.
- Audio:** Selects the sound output.
- Sleep Timer:** Sets the sleep timer.
- Favourite:** Selects the favourite programme.
- USB Device:** Selects "Eject" in order to eject USB device.

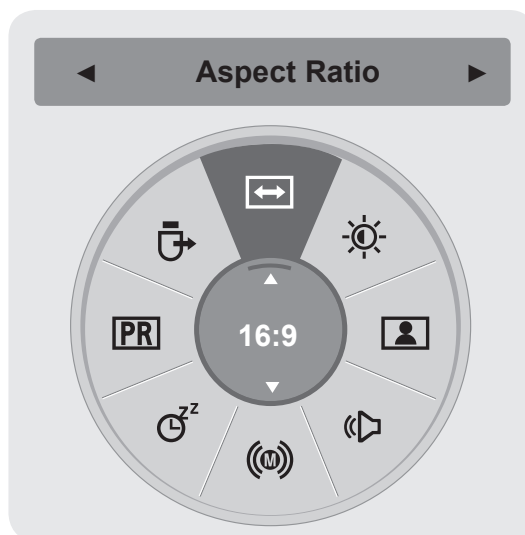

- 1
Q.MENU
◀ ▶
 Display each menu.
- 2
↑ ↓
 Select your desired Source.
- 3
OK

- Press the **BACK** button to move to the previous menu screen.



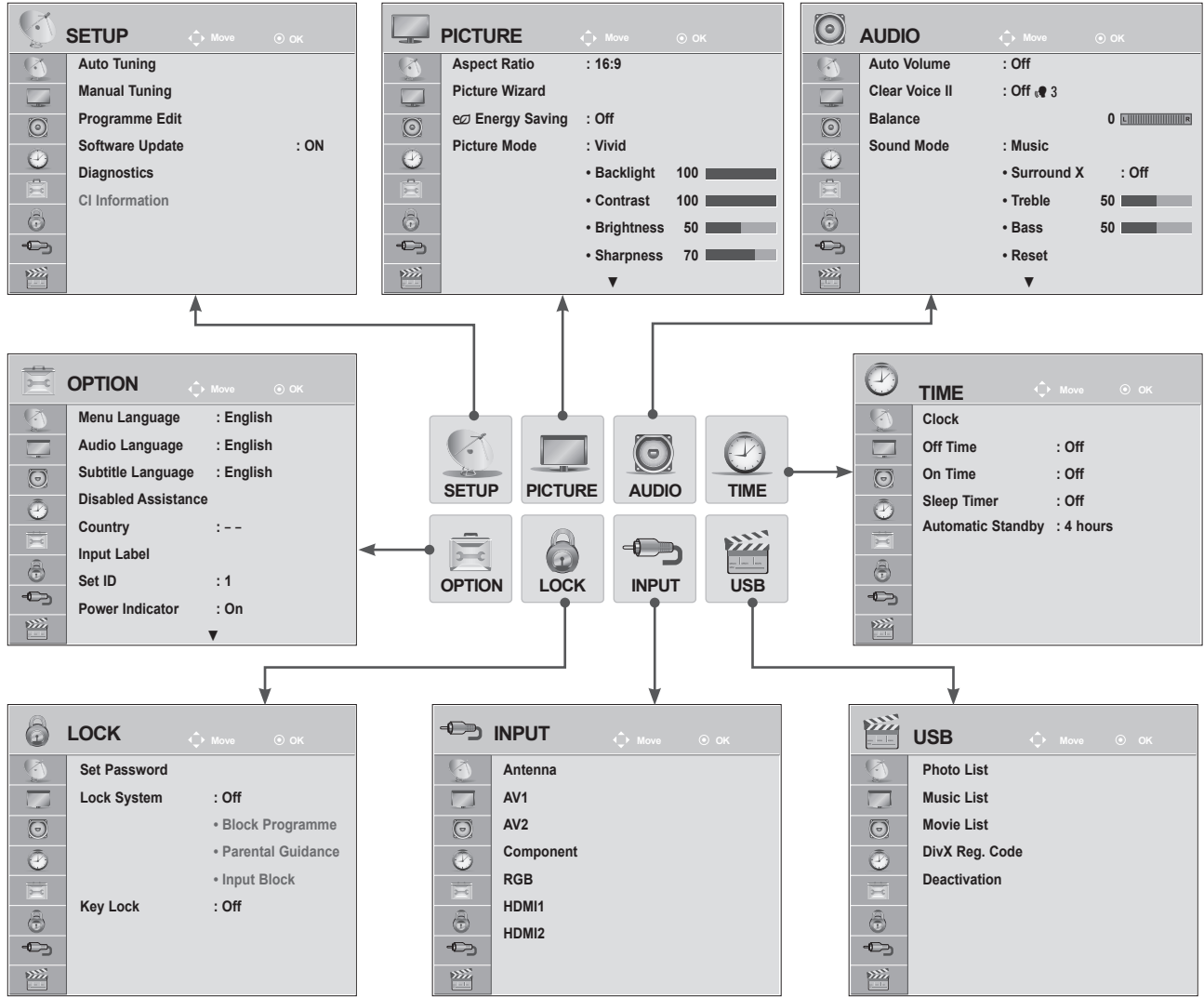

WATCHING TV / PROGRAMME CONTROL

ON SCREEN MENUS SELECTION AND ADJUSTMENT

Your set's OSD (On Screen Display) may differ slightly from what is shown in this manual.



WATCHING TV / PROGRAMME CONTROL

- 1   Display each menu.
- 2   Select a menu item.
- 3  Move to the pop up menu.

- Press the **MENU** or **EXIT** button to close the menu window.
- Press the **BACK** button to move to the previous menu screen.

NOTE

- ▶ It is not possible to use **CI Information** in Analogue mode.

AUTO PROGRAMME TUNING





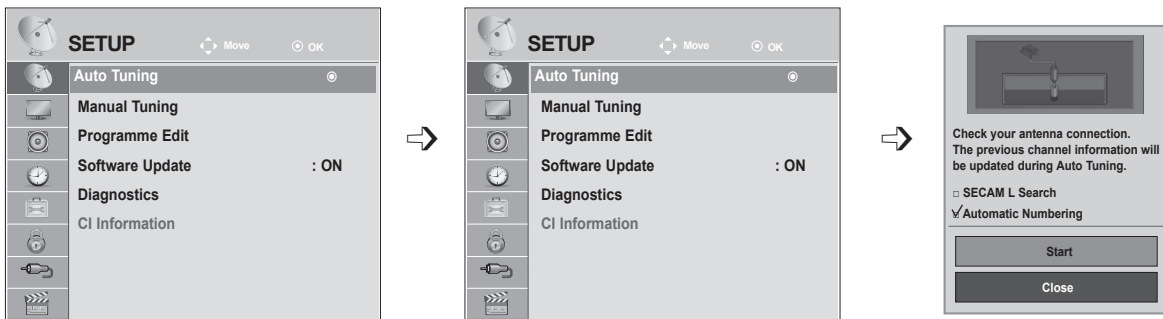

(For countries other than Finland, Sweden, Denmark and Norway)

Use this to automatically find and store all available programmes.

When you start auto programming, all previously stored service information will be deleted.

The maximum number of programmes that can be stored is 1000. But the number may differ slightly depending on broadcasting signals.



- 1   Select **SETUP**.
- 2   Select **Auto Tuning**.
- 3   Select **Antenna**.
- 4  Run **Auto tuning**.

- Use **NUMBER** buttons to input a 4-digit password in **Lock System 'On'**.
- If you wish to keep on auto tuning select **Start** using the ^ v button. Then, press the **OK button**. Otherwise select **Close**.
- **Automatic Numbering**: Decide whether to use the programme numbers as sent by broadcasting stations for tuning.
- When select **Italy** in the County menu, if the pop up is displayed when the conflicted Programme after Auto Tuning, select a broadcaster for conflicting programme number to solve.

- Press the **MENU** or **EXIT** button to close the menu window.
- Press the **BACK** button to move to the previous menu screen.

WATCHING TV / PROGRAMME CONTROL

AUTO PROGRAMME TUNING

(Only for Finland, Sweden, Denmark and Norway)







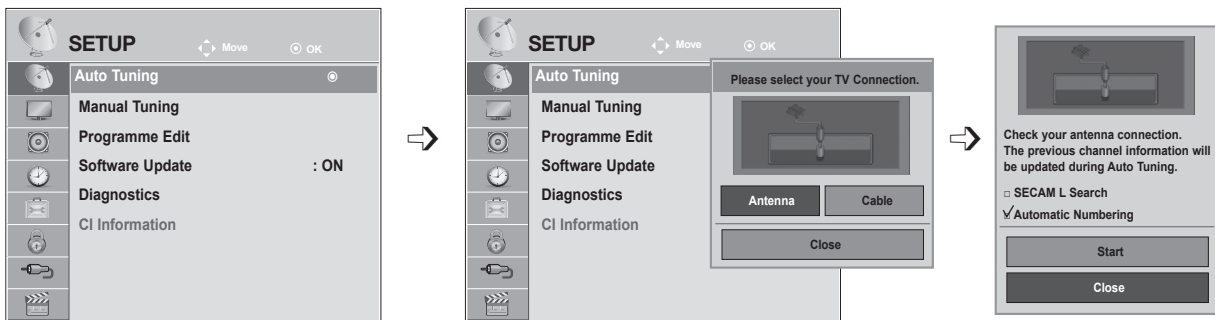

DVB-C Auto Tuning is a menu for users in countries that support DVB cable.

Use this to automatically find and store all available programmes.

When you start auto programming, all previously stored service information will be deleted.

If you want to select the **Antenna**,



- 1   Select **SETUP**.
- 2   Select **Auto Tuning**.
- 3   Select **Antenna**.
- 4   Select **Start**.
- 5  Run **Auto tuning**.

- Use **NUMBER** buttons to input a 4-digit password in **Lock System 'On'**.
- If you wish to keep on auto tuning select **Start** using the $\wedge \vee$ button. Then, press the **OK button**. Other wise select **Close**.
- **Automatic Numbering**: Decide whether to use the programme numbers as sent by broadcasting stations for tuning.

- Press the **MENU** or **EXIT** button to close the menu window.
- Press the **BACK** button to move to the previous menu screen.

If you want to select the **Cable**,

- The image shown may be somewhat different from your set.

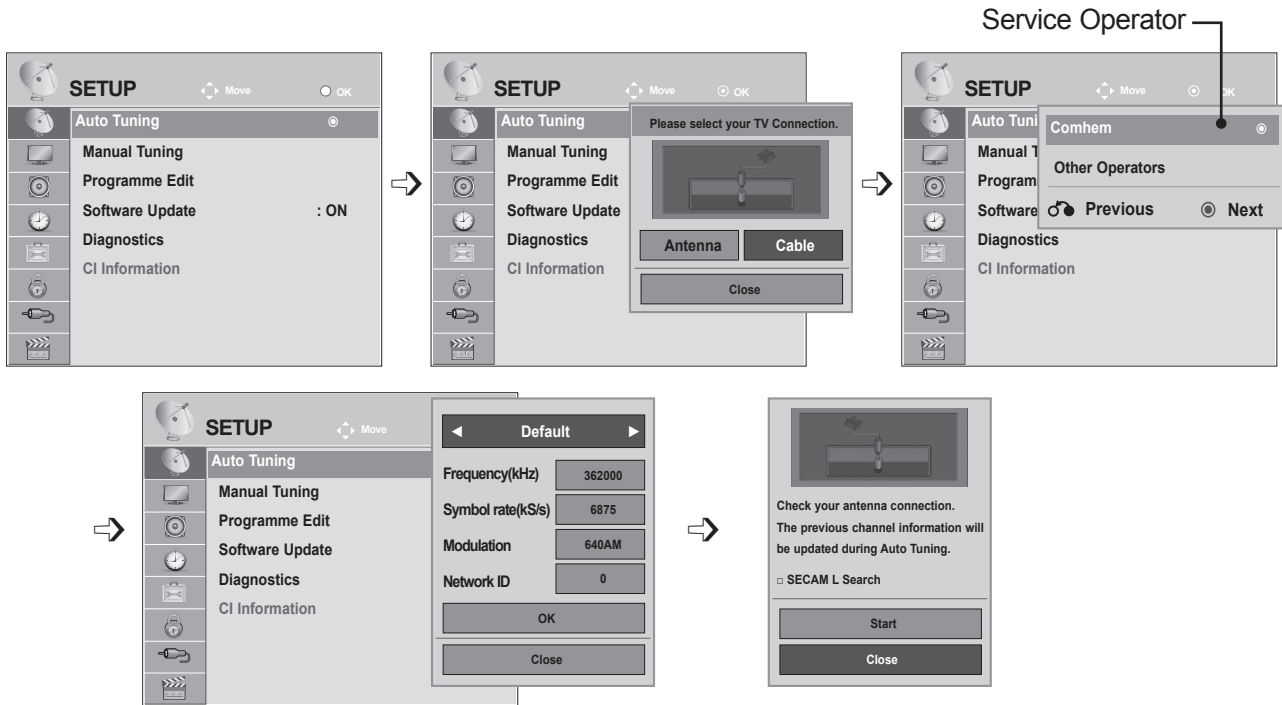

- 1 Select **SETUP**.
- 2 Select **Auto Tuning**.
- 3 Select **Cable**.
- 4 Select **Comhem** or **Other Operators**.
- 5 Select **Default**, **Full** or **User**
- 6 Make appropriate adjustments. (Except for Full mode)

- 7 Select **Close**.
- 8 Select **Start**.
- 9 Run **Auto tuning**.

- Use **NUMBER** buttons to input a 4-digit password in **Lock System 'On'**.
- If you wish to keep on auto tuning select **Start** using the ^ v button. Then, press the **OK** button. Other wise select **Close**.
- **Automatic Numbering**: Decide whether to use the programme numbers as sent by broadcasting stations for tuning.

- Press the **MENU** or **EXIT** button to close the menu window.
- Press the **BACK** button to move to the previous menu screen.

WATCHING TV / PROGRAMME CONTROL

- When you select the **Cable**, the **Cable Service Operator** selection screen can differ or not exist by the Cable situation of the applicable country
- The popup window to select between **Service Operator** is only shown initially for the 3 cases when you accessing the **Initial Setting** menu, when you change from **Antenna** to **Cable** or when you access the menu after changing the **Country**.
- When you want to select between **Service Operator** aside from the above 3 cases, you can do so by selecting **SETUP** → **Cable DTV Setting** → **Service Operator**.

- Acquired certification SO: Sweden(Comhem), Denmark(YouSee, Stofa).
- If there are not any Service Operator that you want, select **Other Operators**.
- If you select "Other Operators", or the selected country supports "Other Operators" only, it may take some time to search all the channels, or it may not search some of the channels.

If some of the channels do not appear, follow the steps below.

1. **SETUP** → **Auto Tuning** → **Cable**

2. Input additional values such as the frequency, symbol rate, modulation, and network ID
(You can ask your cable service provider for the above information)

The following values are needed in order to search all available programmes quickly and correctly.

The commonly used values are provided as "default".

However, for correct settings, please inquire of the cable service provider.

When running Auto Tuning in DVB cable mode, selecting Full will search through all frequencies to find available channels.

In the case when the programme is not searched by selecting the Default, perform the searching by selecting the Full.

However, in the case when the programme is searched by selecting the Full, the Auto Tuning time can be taken too much.

- **Frequency:** Enter a user-defined frequency range.
- **Symbol rate:** Enter a user-defined symbol rate (Symbol rate: Speed at which a device such as modem sends symbols to a channel).
- **Modulation:** Enter a user-defined modulation. (Modulation: Loading of audio or video signals onto carrier).
- **Network ID:** Unique identifier allocated for each user.

AUTO PROGRAMME TUNING

If you select the “- -” of Country Setting, (Except for Finland, Sweden, Denmark and Norway)

To watch DVB-C in the countries excluding Finland, Sweden, Denmark and Norway select '- -' as the **Country** in **OPTION**.

You can select User mode or **Full** mode in **Auto Tuning**.

The corresponding home frequency information may need to be changed when tuning the **User** mode, and the corresponding information depends on the Cable Service Operator (SO) in service.

During **Full** mode tuning, some channel may be restricted for some Cable Service Operator (SO), and it may take a long time for tuning.

Note

- ▶ Your cable provider may charge for their services, or require you to agree to its items and conditions of business.
- ▶ DVB-C Cable may not operate correctly with some cable providers.
- ▶ Compatibility with DVB-C digital cable broadcasts is not guaranteed.

! NOTE

- ▶ M**80D/DF/DB/DN-PYM does not support DVB-C. (Check the model name on the label on the back of the product.)





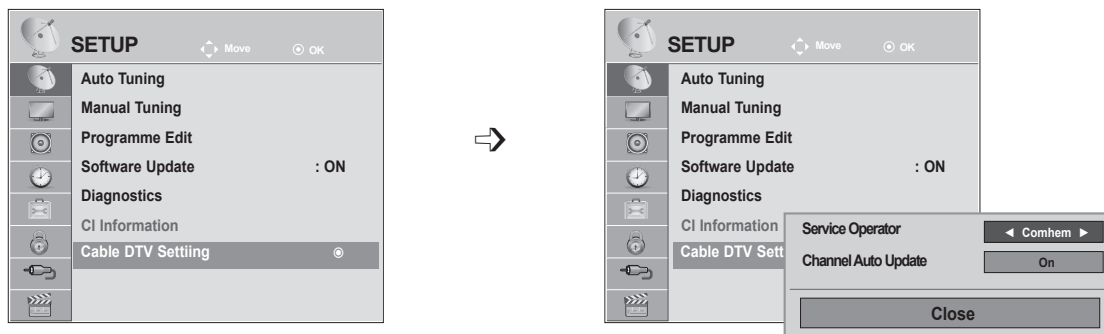

WATCHING TV / PROGRAMME CONTROL

CABLE DTV SETTING (IN CABLE MODE ONLY)

The range that a user can select from the Service Operator menu differs depending on number of Service Operator supported by each country, and if number of supported Service Operator for each country is 1, corresponding function becomes non-activation.

After changing Service Operator, a warning window saying that channel map will be deleted when **OK** button is pressed or Close is selected, and a Auto-tuning pop-up window appears when 'YES' is selected.



-   Select **SETUP**.
-   Select **Cable DTV Setting**.
-   Select **Service Operator** or **Channel Auto Update**.
-  Select your desired source.

- If you select Cable, you can see Cable DTV Setting menu.
- When Channel Auto Update in On, the channel information will be automatically updated whenever the network information changes.
- When Channel Auto Update is Off, the channel information will not be updated.







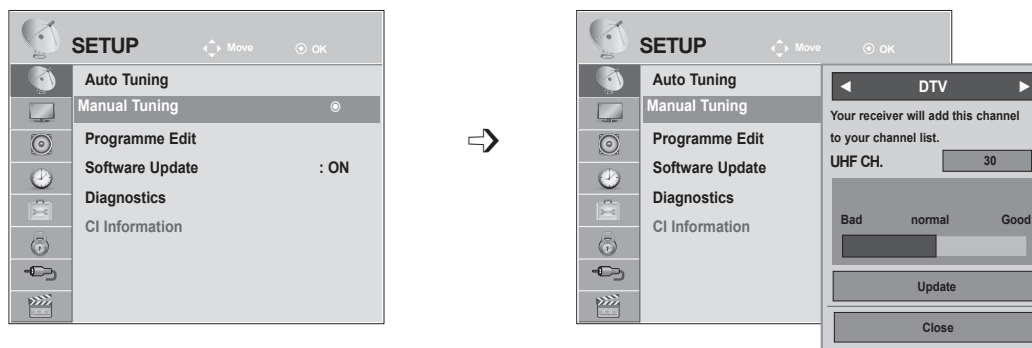

- Press the **MENU** or **EXIT** button to close the menu window.
- Press the **BACK** button to move to the previous menu screen.

MANUAL PROGRAMME TUNING (IN DIGITAL MODE)

Manual Tuning lets you manually add a programme to your programme list.

(For countries other than Finland, Sweden, Denmark and Norway & When selecting Antenna if Finland, Sweden, Denmark, Norway or "--" country is chosen)



-   Select **SETUP**.
-   Select **Manual Tuning**.
-   Select **DTV**.
-   Select the desired channel number.







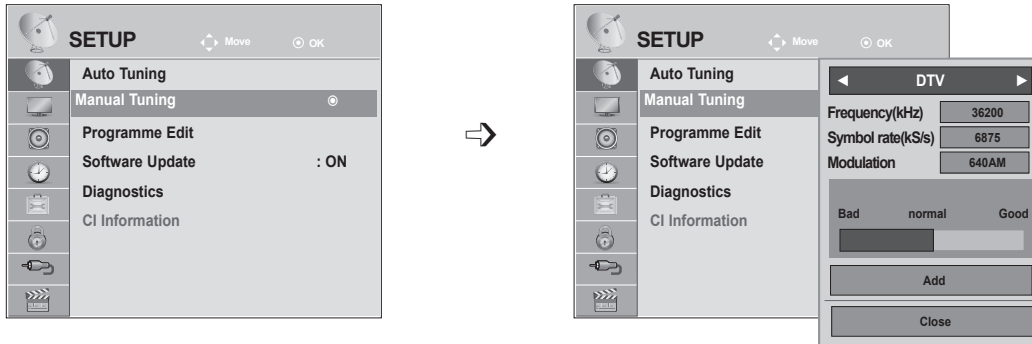

- Use **NUMBER** buttons to input a 4-digit password in **Lock System 'On'**.

- Press the **MENU** or **EXIT** button to close the menu window.
- Press the **BACK** button to move to the previous menu screen.

WATCHING TV / PROGRAMME CONTROL

(When selecting Cable (DVB cable mode) if Finland, Sweden, Denmark, Norway or "--" country is chosen)



- 1   Select **SETUP**.
- 2   Select **Manual Tuning**.
- 3   Select **DTV**.
- 4    Select the desired channel number.

- Use **NUMBER** buttons to input a 4-digit password in **Lock System 'On'**.
- **Symbol rate**: Enter a user-defined symbol rate. (symbol rate: Speed at which a device such as modem sends symbols to a channel.)
- **Modulation**: Enter a user-defiend modulation. (Modulation: Loading of audio or video signals onto carrier)

- Press the **MENU** or **EXIT** button to close the menu window.
- Press the **BACK** button to move to the previous menu screen.

! NOTE

- ▶ M**80D/DF/DB/DN-PYM does not support DVB-C. (Check the model name on the label on the back of the product.)

Frequency, Symbol rate, and Modulation mode are needed in order to add a programme correctly in DVB cable mode. Please inquire of the cable service provider about the correct values.

MANUAL PROGRAMME TUNING (IN ANALOGUE MODE)

Manual Tuning lets you manually tune and arrange the stations in whatever order you desire.

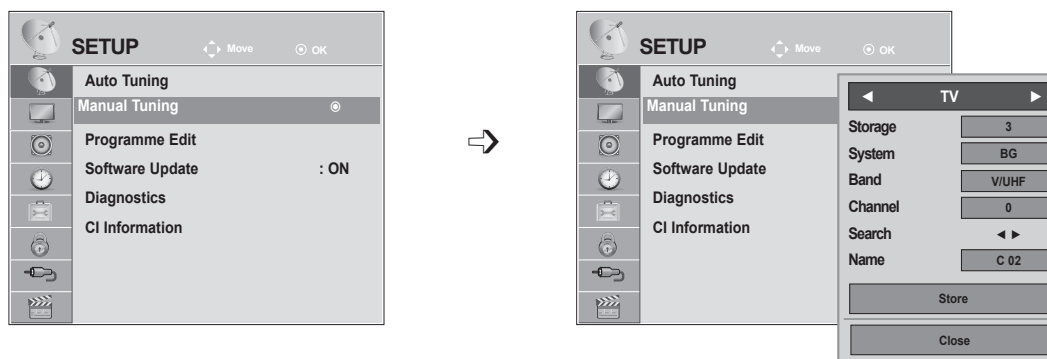

- 1 Select **SETUP**.
- 2 Select **Manual Tuning**.
- 3 Select **TV**.
- 4 or Select the desired programme number on.
- 5 Select a **TV** system.

- 6 Select **V/UHF** or **Cable**.
- 7 or Select the desired channel number.
- 8 Commence searching..
- 9 Select **Store**.

- Press the **MENU** or **EXIT** button to close the menu window.
- Press the **BACK** button to move to the previous menu screen.





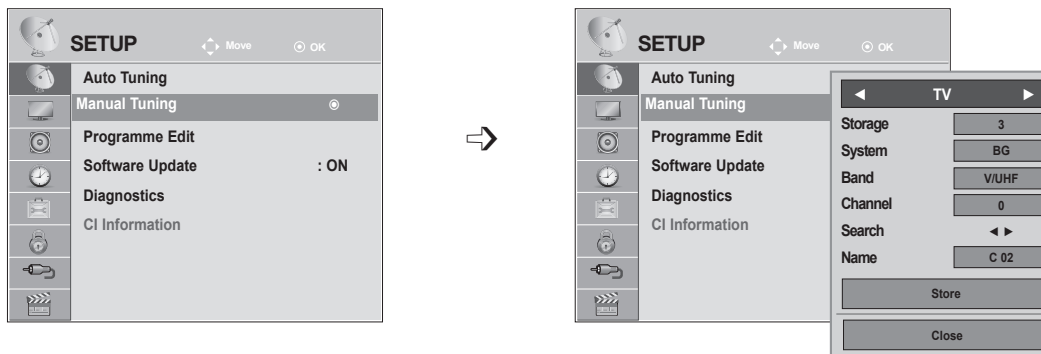









- Use **NUMBER** buttons to input a 4-digit password in **Lock System 'On'**.
- **L**: SECAM L/L (France)
BG: PAL B/G, SECAM B/G (Europe / East Europe / Asia / New Zealand / M.East / Africa / Australia)
I: PAL I/II (U.K. / Ireland / Hong Kong / South Africa)
DK: PAL D/K, SECAM D/K (East Europe / China / Africa / CIS)
- To store another channel, repeat steps 4 to 9.

WATCHING TV / PROGRAMME CONTROL



■ Assigning a station name

You can assign a station name with five characters to each programme number.

- 1   Select **SETUP**.
- 2   Select **Manual Tuning**.
- 3   Select **TV**.
- 4   Select **Name**.
- 5   Select the position and make your choice of the second character, and so on. You can use an the alphabet **A** to **Z**, the number **0** to **9**, **+/-**, and blank.
- 6   Select **Close**.
- 7   Select **Store**.

- Press the **MENU** or **EXIT** button to close the menu window.
- Press the **BACK** button to move to the previous menu screen.

PROGRAMME EDIT





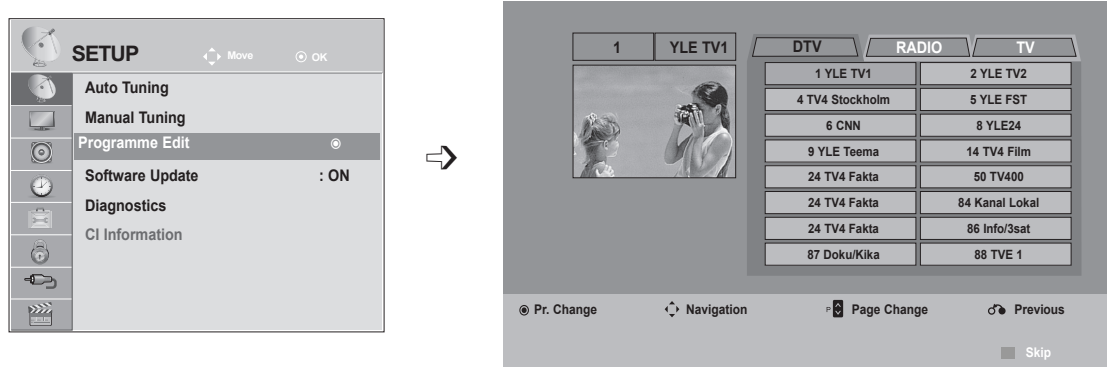

When a programme number is skipped, it means that you will be unable to select it using **P** ^ v button during TV viewing.

If you wish to select the skipped programme, directly enter the programme number with the **NUMBER buttons** or select it in the Programme edit menu.

This function enables you to skip the stored programmes.

You can change the programme number using “Move” function, if “Automatic Numbering” is unchecked when you start Auto Tuning.



- 1   Select **SETUP**.
- 2   Select **Programme Edit**.
- 3  Enter the **Programme Edit**.
- 4  Select a programme to be stored or skipped.

- Use **NUMBER** buttons to input a 4-digit password in **Lock System "On"**.

- Press the **MENU** or **EXIT** button to close the menu window.
- Press the **BACK** button to move to the previous menu screen.

WATCHING TV / PROGRAMME CONTROL

IN DTV/RADIO MODE

■ Skipping a programme number

1  Select a programme number to be skipped.

2  Turn the programme number to blue.

3  Release.

- When programmes are to be skipped, the skipped programme shows in blue and these programmes will not be selected by the P ^ v buttons during TV viewing.
- If you wish to select a skipped programme, directly enter the programme number with the NUMBER buttons or select it in the programme edit or EPG.

IN TV MODE

This function enables you to delete or skip the stored programmes.
You can also move some channels and use other programme numbers.

■ Deleting a programme

1  Select a programme number to be skipped.



2  Turn the programme number to red.

3  Delete.  Release.

- The selected programme is deleted, all the following programmes are shifted up one.

■ Moving a programme

1  Select a programme number to be skipped.

2   Turn the programme number to green.



3  Release.

■ Auto Sort

- 1  Start Auto Sort.

- After activating Auto Sort once, you can no longer edit programmes.

■ Skipping a programme number

- 1  Select a programme number to be skipped.
- 2  Turn the programme number to blue.
- 3  Release.





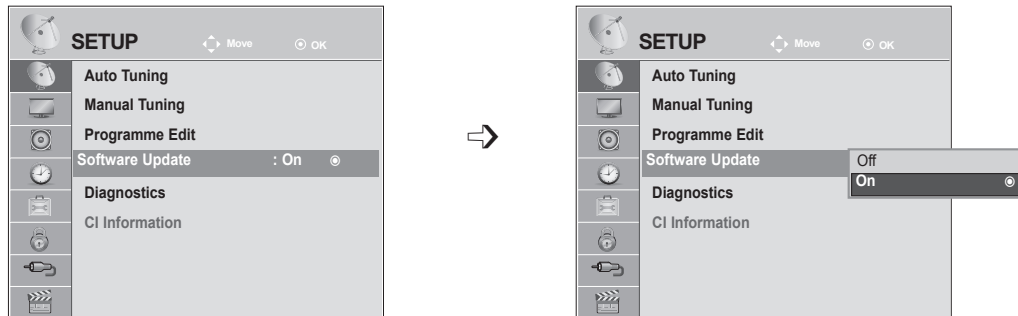

- When a programme number is skipped it means that you will be unable to select it using the P ^ v button during normal TV viewing.
- If you wish to select a skipped programme, directly enter the programme number with the NUMBER buttons or select it in the programme edit or EPG.

WATCHING TV / PROGRAMME CONTROL

SOFTWARE UPDATE

Software Update means software can be downloaded through the digital terrestrial broadcasting system.



-   Select **SETUP**.
-   Select **Software Update**.
-   Select **On** or **Off**.
 - If you select **On**, a user confirm message box will be displayed to notify that new software is found.
-  Save.

* When setting "Software Update"

Occasionally, a transmission of updated digital software information will result in the following menu on the TV screen.

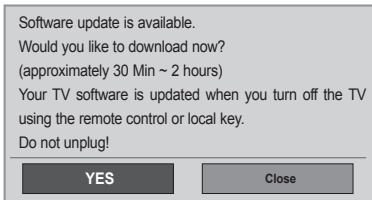

Simple Update: for current update stream

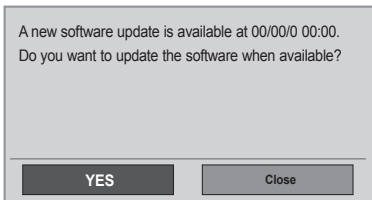

Schedule Update: for scheduled update stream
When the Software Update menu is "Off", the message to change it to "On" appears.

Select the Yes using the < > button and you will see the following picture.

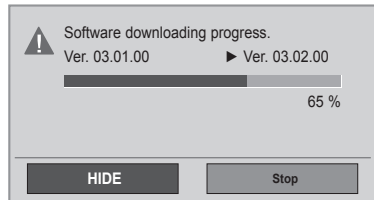

After the Software Update is complete, the System restarts.

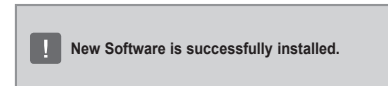

When the power is turned off, downloading starts.
When the power is turned on while updating, the progress status is displayed.

- During Progress of a Software Update, please note the following:
 - Power to the TV must not be interrupted.
 - The TV must not be switched off.
 - The antenna must not be disconnected.
 - After Software Update, you can confirm the updated software version in Diagnostics menu.
 - It may take hours to download the software, so make sure that the power stays on during the download.

WATCHING TV / PROGRAMME CONTROL

DIAGNOSTICS





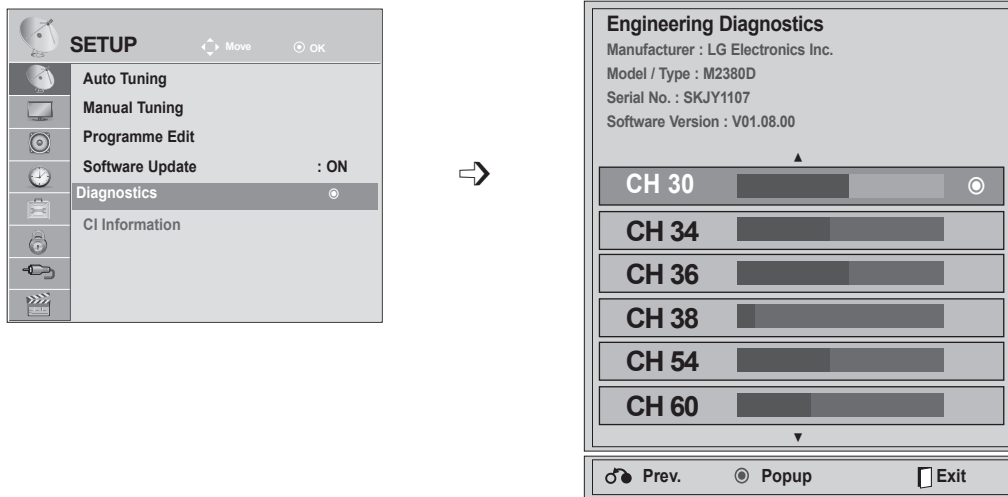

This function enables you to view information on the Manufacturer, Model/Type, Serial Number and Software Version.

This displays the information and signal strength of the tuned *MUX.

This displays the signal information and service name of the selected MUX.

(*MUX: A higher directory of channels in digital broadcasting (a single MUX contains multiple channels.))



-   Select **SETUP**.
-   Select **Diagnostics**.
-  Display Manufacturer, Model / Type, Serial Number and Software Version.
-   Display the information of Channel.

- Press the **MENU** or **EXIT** button to close the menu window.
- Press the **BACK** button to move to the previous menu screen.

CI [COMMON INTERFACE] INFORMATION

This function enables you to watch some encrypted services (pay services). If you remove the CI Module, you cannot watch pay services.

When the module is inserted into the CI slot, you can access the module menu.

To purchase a module and smart card, contact your dealer. Do not repeatedly insert or remove a CI module from the TV. This may cause a malfunction. When the TV is turned on after inserting a CI Module, you may not have any sound output.





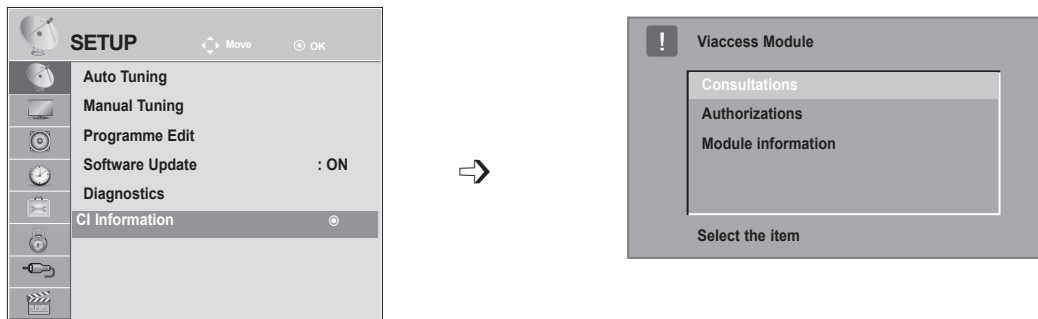

This may be incompatible with the CI module and smart card.

CI (Common Interface) functions may not be possible depending upon the country broadcasting circumstances.

When using a CAM(Conditional Access Module), please make sure it meets fully the requirements of either DVB CI or CI plus.



- This OSD is only for illustration and the menu options and screen format will vary according to the Digital pay services provider.
- It is possible for you to change CI (Common Interface) menu screen and service by consulting your dealer.

- 

 Select **SETUP**.
- 

 Select **CI Information**.
- 

 Select the desired item: Module information, smart card information, language, or software download etc.
- 
 Save.

- Press the **BACK** button to move to the previous menu screen.

WATCHING TV / PROGRAMME CONTROL

SELECTING THE PROGRAMME LIST

You can check which programmes are stored in the memory by displaying the programme list.

Mini Glossary

 Displayed when the Locked Programme.

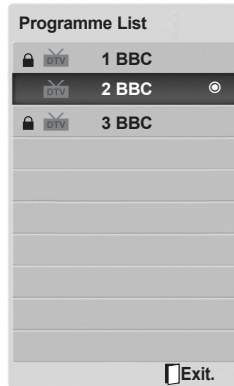



■ Displaying programme LIST

-  Display the Programme List.

- You may find some blue programmes. These have been set up to be skipped by auto programming or in the programme edit mode.
- Some programmes with the channel number shown in the programme LIST indicate there is no station name assigned.



■ Selecting a programme in the programme list

-  Select a programme.
-  Switch to the chosen programme number.



The mode will be switched between TV, DTV, and Radio from the program you are currently watching.

■ Paging through a programme list



-  Turn the pages.
-  Return to normal TV viewing.

FAVOURITE PROGRAMME SETUP

■ Selecting favourite programme

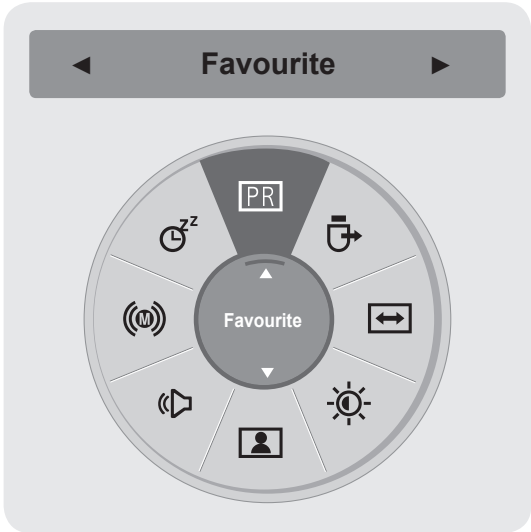
Favourite programme is a convenient feature that lets you quickly scan up to programmes of your choice without having to wait for the TV to scan through all the in-between programmes.

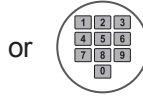

- 1  or  Select your desired programme.
- 2   Select **Favourite**.

- 3  Select **Favourite**.
- 4  Return to TV viewing.

• This will automatically include the selected programme into your favourite programme list.

■ Displaying the favourite programme list



- 3  Display the Favourite Programme List.

WATCHING TV / PROGRAMME CONTROL

INPUT LIST

HDMI1/2, AV1/2, COMPONENT and **RGB** can be recognized by a detect pin and thus enabled only when an external device approves voltage.

By using **TV/RAD** button, you can move from External Input to RF Input and to the last watched programme in **DTV/RADIO/TV** mode.

- **Antenna** or **Cable**: Select it when watching the DTV/TV. (Digital cable input is available only at Finland, Sweden and "--" country)
- **AV1, AV2**: Select it when watching the VCR or external equipment.
- **Component**: Select it when using the DVD or the Digital set-top box depends on connector.
- **RGB**: Select it when using PC depends on connector.
- **HDMI 1, HDMI 2**: Select it when using DVD, PC or Digital set-top box depend on connector.

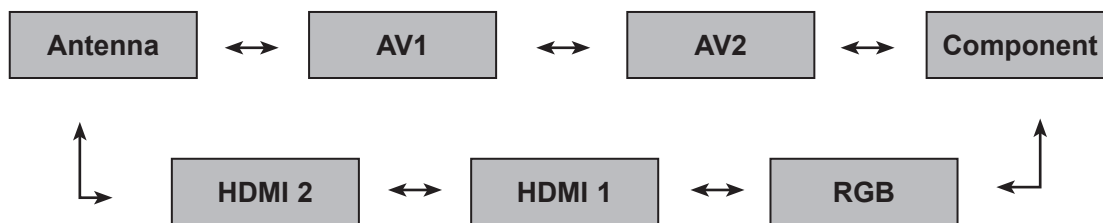

NOTE

► The OSD (On Screen Display) is displayed on the screen as shown below.

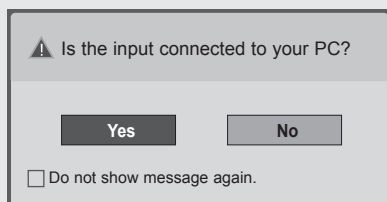

- When turning the product on in HDMI input.
- When switching to HDMI input.
- When connecting an HDMI cable with no signal.

- If you select "**Yes**," the size and image quality are optimised for your PC.
- If you select "**No**," the size and image quality are optimised for the **AV device (DVD player, set-top box, gaming device)**.
- If you select "**Do not show message again**," this message does not appear until the monitor is reset. You can change the set value in **MENU ► Option ► Input label**.
- The values set for HDMI1/HDMI2 are saved independently.













EPG (ELECTRONIC PROGRAMME GUIDE) (IN DIGITAL MODE)

This system has an Electronic Programme Guide (EPG) to help your navigation through all the possible viewing options.

The EPG supplies information such as programme listings, start and end times for all available services. In addition, detailed information about the programme is often available in the EPG (the availability and amount of these programme details will vary, depending on the particular broadcaster).

This function can be used only when the EPG information is broadcast by broadcasting companies.

The EPG displays the programme details for next 8 days.



 Shows the present screen information.	 Displayed with a Teletext Programme.
 Displayed with a DTV Programme.	 Displayed with a Subtitle Programme.
 Displayed with a Radio Programme.	 Displayed with a Scramble Programme.
 Displayed with a MHEG Programme.	 Displayed with a Dolby Programme.
 Displayed with a AAC Programme.	 Displayed with a Dolby Digital PLUS Programme.
 Aspect ratio of broadcasting programme.	 Broadcasted programme with the icon may not be displayed in Monitor Out depending on the information of the programme.
 Aspect ratio of broadcasting programme.	

576i/p, 720p, 1080i/p: Resolution of broadcasting programme

Switch on/off EPG

-  Switch on or off EPG.







Select a programme

-  or  Select desired programme.
-  The EPG will disappear after moving to a selected program.





EPG (ELECTRONIC PROGRAMME GUIDE) (IN DIGITAL MODE)

Button Function in NOW/NEXT Guide Mode

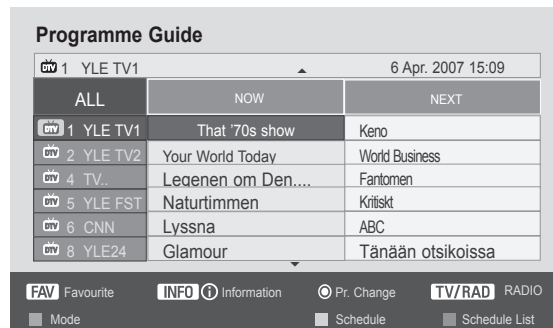







You can view a program being broadcasted and one scheduled to follow.

-  **RED** Change EPG mode.
-  **YELLOW** Enter Timer Record/Remind setting mode.
-  **BLUE** Enter Timer Record/Remind list mode.
-  **OK** The EPG will disappear after moving to a selected program.
-  Select NOW or NEXT Programme.
-  Select the Broadcast Programme.
-  Page Up/Down.







-  **GUIDE** or  **BACK** or  **EXIT** Switch off EPG.
-  **TV/RAD** Select TV or RADIO Programme.
-  **INFO** Detail information on or off

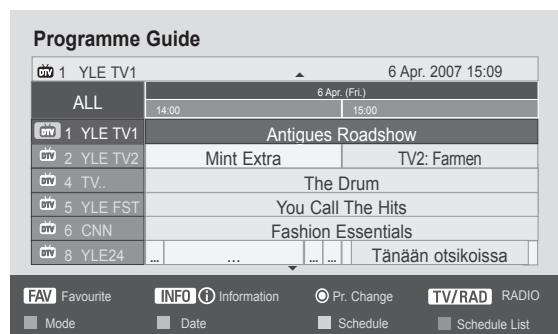





Button Function in 8 Day Guide Mode

-  **RED** Change EPG mode.
-  **GREEN** Enter Date setting mode.
-  **YELLOW** Enter Timer Record/Remind setting mode.
-  **BLUE** Enter Timer Record/Remind list mode.
-  **OK** The EPG will disappear after moving to a selected program.
-  Select Programme.
-  Select the Broadcast Programme.
-  Page Up/Down.





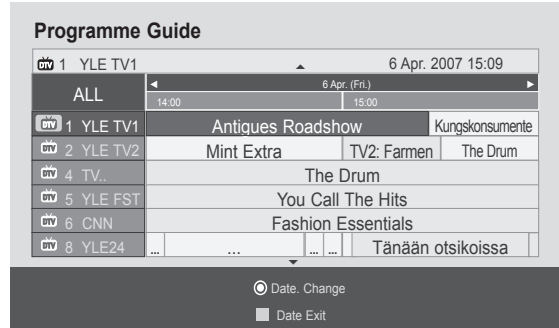

-  **GUIDE** or  **BACK** or  **EXIT** Switch off EPG.
-  **TV/RAD** Select TV or RADIO Programme.
-  **INFO** Detail information on or off

Button Function in Date Change Mode

-  Switch off Date setting mode.
-  Change to the selected date.
-  Select a date.
-  Switch off Date setting mode.
-  or  or  Switch off EPG.



Button Function in Extended Description Box

-  Text Up/Down.
-  Enter Timer Record/Remind setting mode.
-  or  The detail information on or off.
-  Switch off EPG.

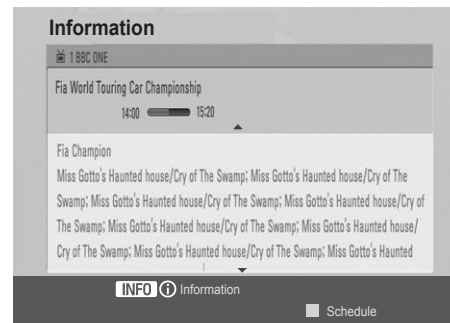

EPG (ELECTRONIC PROGRAMME GUIDE) (IN DIGITAL MODE)

Button Function in Record/Remind Setting Mode

Sets a start or end time for recording, and sets only a start time for the reminder with the end time grayed out. This function is available only when recording equipment that use pin8 recording signalling has been connected to the TV-OUT(AV1) terminal, using a SCART cable.



Change to Guide or Schedule mode.



Select Record or Remind.
Function setting.



Select Date, Start/End time or Programme.



Save Timer Record/Remind.

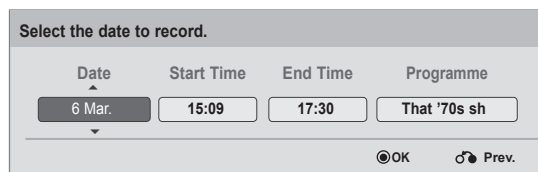

Button Function in Schedule List Mode

If you've created a schedule list, a scheduled program is displayed at the scheduled time even when you are watching a different program at the time.

Only the Up/Down/OK/BACK keys will work when a popup window is open.



Add new Manual Recording setting mode.



Add new Timer Watching setting mode.



Change to Guide mode.



Switch off EPG.



Select your desired Option(Modify/Delete/Delete All).



Select **Schedule List**.



Page Up/Down.

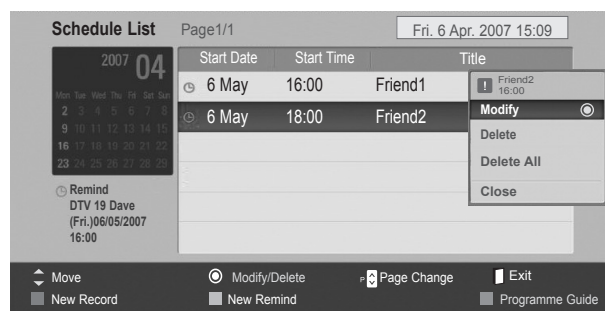

PICTURE CONTROL



PICTURE SIZE (ASPECT RATIO) CONTROL

You can watch the screen in various picture formats: **16:9**, **Just Scan**, **Original**, **Full Wide**, **4:3**, **14:9**, **Zoom** and **Cinema Zoom**.

If a fixed image is displayed on the screen for a long time, that fixed image may become imprinted on the screen and remain visible.

You can adjust the enlarge proportion using $\wedge \vee$ button.

This function works in the following signal.

-   Select **Aspect Ratio**.
-  Select the desired picture format.

- You can also adjust **Aspect Ratio** in the **PICTURE** menu.
- For Zoom Setting, select **14:9**, **Zoom** and **Cinema Zoom** in Ratio Menu. After completing Zoom Setting, the display goes back to Q.Menu.

• 16:9

The following selection will allow you to adjust the picture horizontally, in linear proportion, to fill the entire screen (useful for viewing 4:3 formatted DVDs).



• Just Scan

Following Selection will lead to you view the picture of best quality without loss of original picture in high resolution image.

Note : If there is noise in original Picture, You can see the noise at the edge.

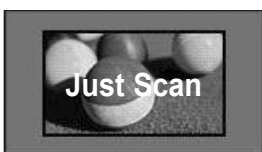

• Original

When your TV receives a wide screen signal it will automatically change to the picture format broadcast.

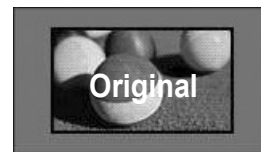

• Full Wide

When TV receives the wide screen signal, it will lead you to adjust the picture horizontally or vertically, in a linear proportion, to fill the entire screen fully.



PICTURE CONTROL

• 4:3

The following selection will allow you to view a picture with an original 4:3 aspect ratio, gray bars will appear on both the left and right of the screen.



• 14 : 9

You can view a picture format of 14:9 or a general TV programme in the 14:9 mode. The 14:9 screen is viewed in the same way as in 4:3, but is magnified to the left and right.



• Zoom

The following selection will allow you to view the picture without any alteration, while filling the entire screen. However, the top and bottom of the picture will be cropped.

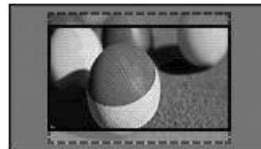

• Cinema Zoom

Choose Cinema Zoom when you want to enlarge the picture in correct proportion. Note: When enlarging or reducing the picture, the image may become distorted.

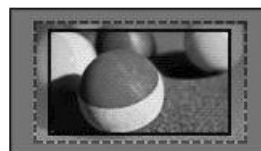

- ◀ or ▶ button: Adjust enlarge proportion of Cinema Zoom. The adjustment range is 1 to 16.
- ▼ or ▲ button: Move the screen.

! NOTE

- ▶ You can only select **4:3**, **16:9 (Wide)**, **14:9**, **Zoom/Cinema Zoom** in Component mode.
- ▶ You can only select **4:3**, **Original**, **16:9 (Wide)**, **14:9**, **Zoom/Cinema Zoom** in HDMI mode.
- ▶ You can only select **4:3**, **16:9 (Wide)** in RGB-PC, HDMI-PC mode only.
- ▶ In DTV/HDMI/Component (over 720p) mode, Just Scan is available.
- ▶ In Analogue/AV mode, Full Wide is available.

PICTURE WIZARD









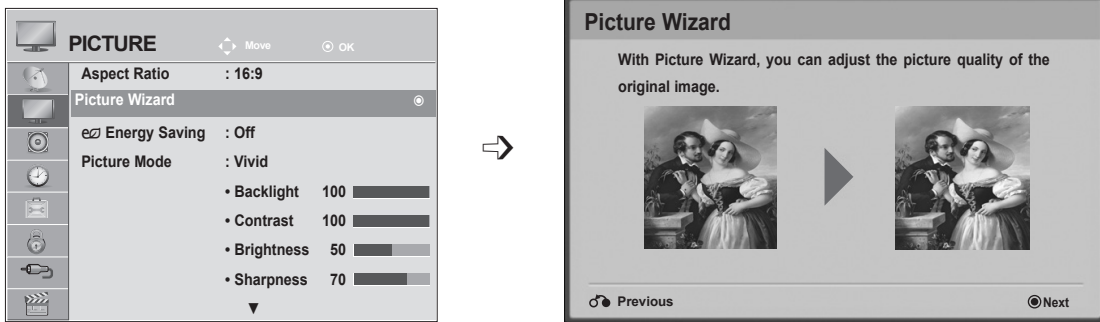

This feature lets you adjust the picture quality of the original image.

Use this to calibrate the screen quality by adjusting the Black and White Level etc. General users can calibrate the screen quality by easily following each stage.

When you adjust the image to Low, Recommended or High, you can see the changed result as an example.

In RGB-PC / HDMI-PC mode, the changed Colour, Tint and H/V Sharpness values are not applied.



- 1   Select **PICTURE**.
- 2    Select **Picture Wizard**.
- 3   Adjust **Black level, White level, Colour, Tint, Horizontal Sharpness, Vertical Sharpness, Colour Temperature, Dynamic Contrast, Colour Gain, Backlight**.
- 4    Select input source to apply the settings.
- 5 

- If you stop the setting before the final stage, the changes will not be applied
- The adjustment value is saved to **Expert 1**.

- Press the **MENU** or **EXIT** button to close the menu window.
- Press the **BACK** button to move to the previous menu screen.

PICTURE CONTROL

ENERGY SAVING

It reduces the TV's power consumption.







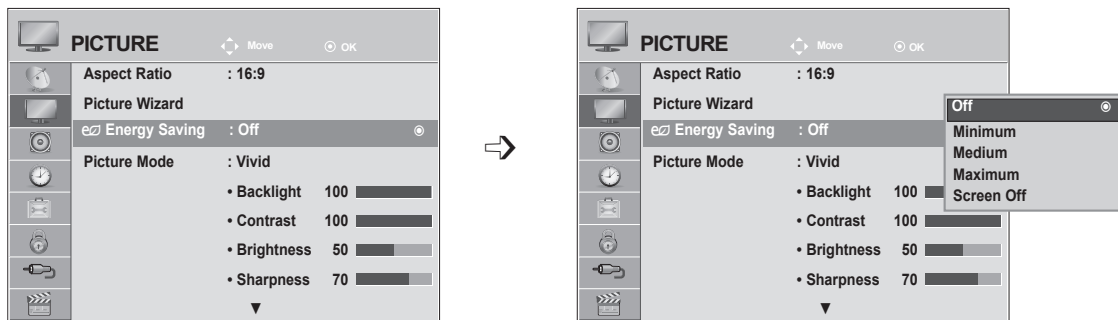

The default factory setting is adjusted to the comfortable level to be viewed at home.

You can increase the brightness of your screen by adjusting the **Energy Saving level** or by setting the **Picture Mode**.

When adjusting Energy Saving in MHEG mode, the Energy Saving setting is applied after MHEG is finished.

Selecting '**Screen Off**' while tuned to a radio station channel will reduce power consumption.



-   Select **PICTURE**.
-   Select ** Energy Saving**.
-   Select **Off**, **Minimum**, **Medium**, **Maximum** or **Screen Off**.
- 

- Press the **MENU** or **EXIT** button to close the menu window.
- Press the **BACK** button to move to the previous menu screen.





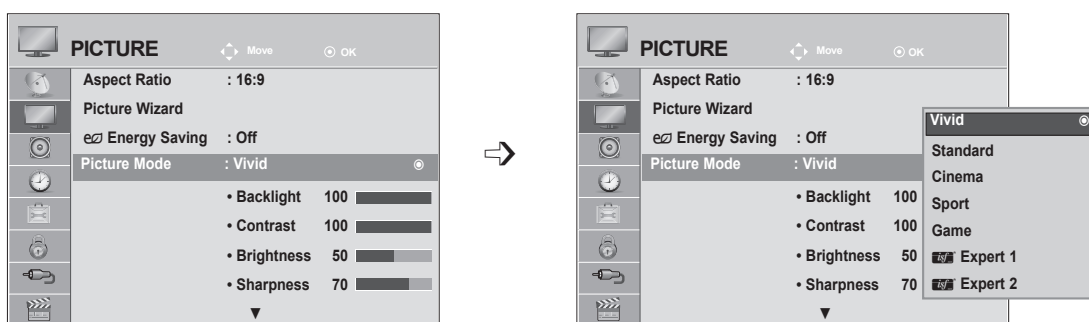

- When you select Screen Off, the screen will be turned off in 3 seconds and Screen Off will start. And the TV is disabled to be automatically turned off.
- You can also adjust this feature by selecting **Energy Saving** button on the remote control.
- If you want to return from Screen off, input any key.

PRESET PICTURE SETTINGS

Picture Mode-Preset

- Vivid** Strengthen the contrast, brightness, colour and sharpness for vivid picture.
- Standard** The most general screen display status.
- Cinema** Optimizes video for watching movies.
- Sport** Optimizes video for watching sports events.
- Game** Optimizes video for playing games.



-   Select **PICTURE**.
-   Select **Picture Mode**.
-   Select **Vivid, Standard, Cinema, Sport or Game**
- 

- Press the **MENU** or **EXIT** button to close the menu window.
- Press the **BACK** button to move to the previous menu screen.

- **Picture Mode** adjusts the TV for the best picture appearance. Select the preset value in the **Picture Mode** menu based on the programme category.
- You can also adjust Picture Mode in the **Q. Menu**.

PICTURE CONTROL

MANUAL PICTURE ADJUSTMENT

Picture Mode-User option

Backlight

To control the brightness of the screen, adjust the brightness of LCD panel.
Adjusting the backlight when setting the brightness of the set is recommended.

Contrast

Adjusts the signal level between black and white in the picture. You may use Contrast when the bright part of the picture is saturated.

Brightness

Adjusts the base level of the signal in the picture.

Sharpness

Adjusts the level of crispness in the edges between the light and dark areas of the picture.
The lower the level, the softer the image.

Colour

Adjusts intensity of all colours.









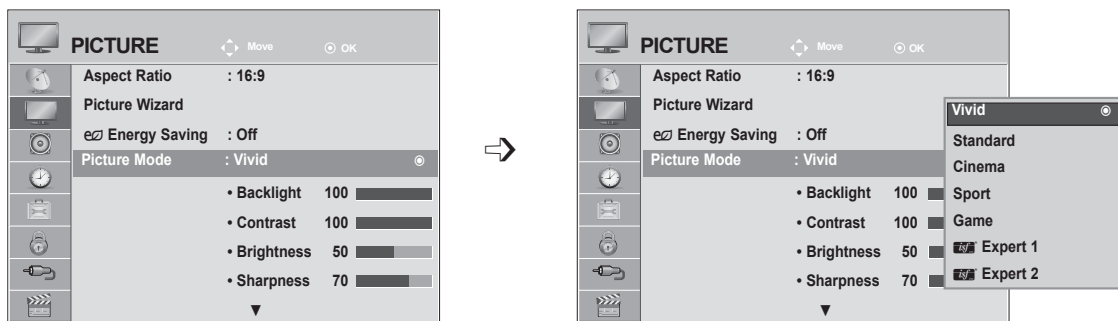

Tint

Adjusts the balance between red and green levels.

Colour Temperature

Set to warm to enhance hotter colours such as red, or set to cool to make picture bluish.



-   Select **PICTURE**.
-   Select **Picture Mode**.
-   Select **Vivid, Standard, Cinema, Sport or Game**
-   Select **Backlight, Contrast, Brightness, Sharpness, Colour, Tint or Colour Temperature**.
-   Make appropriate adjustments.

- Press the **MENU** or **EXIT** button to close the menu window.
- Press the **BACK** button to move to the previous menu screen.

NOTE

- ▶ You cannot adjust colour and tint in the RGB-PC / HDMI-PC mode.
- ▶ When the Expert 1/2 is selected, you can select **Backlight, Contrast, Brightness, H Sharpness, V Sharpness, Colour or Tint**.







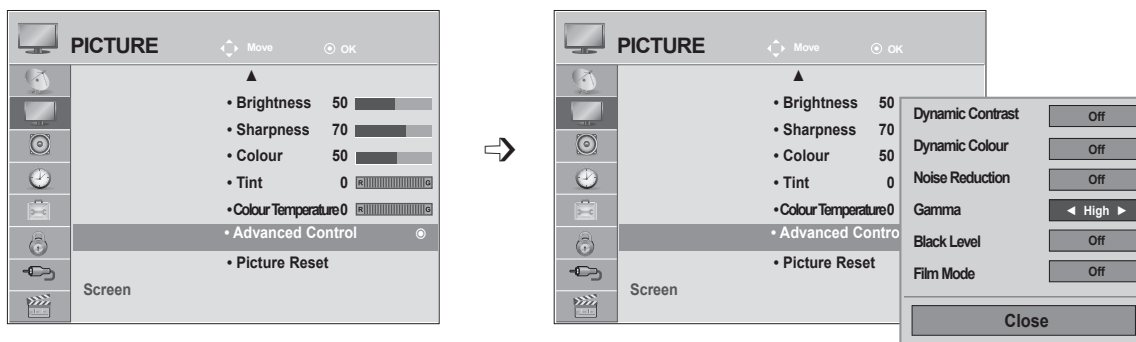

PICTURE IMPROVEMENT TECHNOLOGY

You can calibrate the screen for each Picture Mode or set the video value according to the special video screen.

You can set the video value differently for each input.

To reset to the factory default screen after making adjustments to each video mode, execute the “**Picture Reset**” function for each **Picture Mode**.



- 1   Select **PICTURE**.
- 2   Select **Advanced Control**.
- 3   Select **Dynamic Contrast, Dynamic Colour, Noise Reduction, Gamma, Black Level or Film Mode. (Refer to p. 77 to 78)**
- 4   Select your desired Source.

- Press the **MENU** or **EXIT** button to close the menu window.
- Press the **BACK** button to move to the previous menu screen.







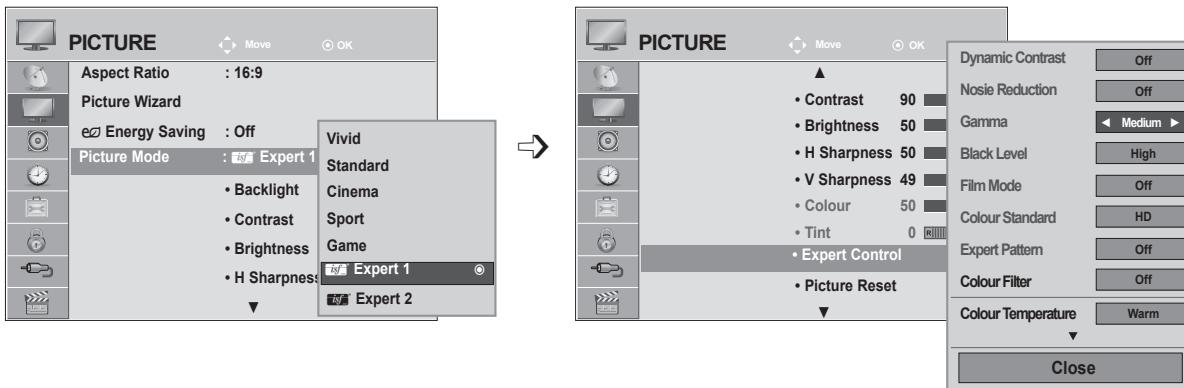

PICTURE CONTROL

EXPERT PICTURE CONTROL

By segmenting categories, **Expert 1** and **Expert 2** provide more categories which users can set as they see fit, offering the optimal picture quality for users.

This may also be used to help a professional optimize the TV performance using specific videos.



- 1   Select **PICTURE**.
- 2   Select **Picture Mode**.
- 3   Select  **Expert 1** or  **Expert 2**.
- 4   Select **Expert Control**.
- 5   Select your desired Source.
- 6  Make appropriate adjustments.

- Press the **MENU** or **EXIT** button to close the menu window.
- Press the **BACK** button to move to the previous menu screen.

<p>Dynamic Contrast (Off/Low/High)</p>	<ul style="list-style-type: none"> ■ Adjusts the contrast to keep it at the best level according to the brightness of the screen. The picture is improved by making bright parts brighter and dark parts darker.
<p>Dynamic Colour (Off/Low/High)</p>	<ul style="list-style-type: none"> ■ Adjusts screen colours so that they look livelier, richer and clearer. This feature enhances hue, saturation and luminance so that red, blue, green and white look more vivid.
<p>Noise Reduction (Off/Low/Medium/High)</p>	<ul style="list-style-type: none"> ■ Reduces screen noise without compromising video quality.
<p>Gamma (Low/Medium/High)</p>	<ul style="list-style-type: none"> ■ You can adjust brightness of dark area and middle gray level area of the picture. <ul style="list-style-type: none"> • Low: Make dark and middle gray level area of the picture brighter. • Medium: Express original picture levels. • High: Make dark and middle gray level area of the picture darker.
<p>Black Level (Low/High/Auto)</p>	<ul style="list-style-type: none"> • Low: The picture of the screen gets darker. • High: The picture of the screen gets brighter. • Auto: Realizing the black level of the screen and set it to High or Low automatically. ■ Set black level of the screen to proper level. ■ This function enables to select 'Low' or 'High' in the following mode: AV(NTSC-M), HDMI or Component. Otherwise, 'Black level' is set to 'Auto'.
<p>Film Mode (On/Off)</p>	<ul style="list-style-type: none"> ■ You can watch a cinema-like video by eliminating judder effect. ■ Use this function when you watch movies.
<p>Colour Standard (SD/HD)</p>	<ul style="list-style-type: none"> ■ Converts the colour of a different video to HD colour. This function is set for SD video (BT-601) and HD video (BT-709) colour format.





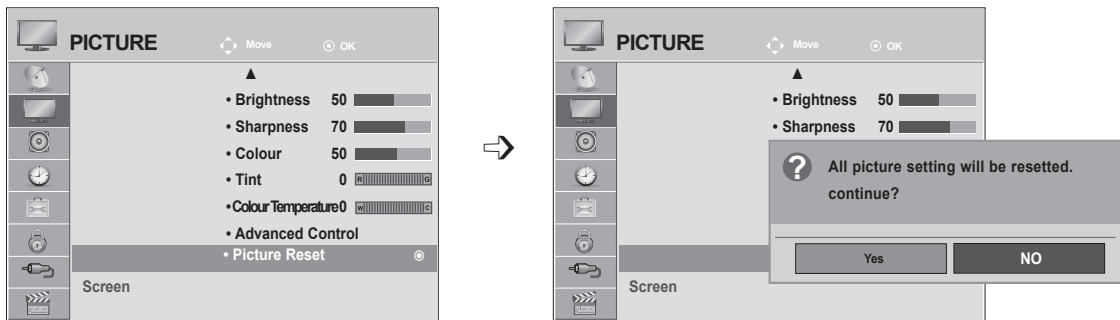

PICTURE CONTROL

<p>Expert Pattern (Off/Expert 1/Expert 2)</p>	<ul style="list-style-type: none"> ■ This is the pattern necessary for expert adjustment. ■ This function is enabled in "Picture Mode - Expert" when you watch DTV.
<p>Colour Filter (Off/Red/Green/Blue)</p>	<ul style="list-style-type: none"> ■ This is the function to filter the specific colours of the video. You can use the RGB filter to set colour saturation and hue accurately.
<p>Colour Temperature (Medium/Warm/Cool)</p>	<ul style="list-style-type: none"> ■ This is the function to adjust the overall colour of the screen to the feeling you want. <ol style="list-style-type: none"> a. • Method: 2 Points <ul style="list-style-type: none"> • Pattern: Inner, Outer • Red/Green/Blue Contrast, Red/Green/Blue Brightness : The adjustment range is -50 to +50. b. • Method: 10 point IRE <ul style="list-style-type: none"> • Pattern: Inner / Outer • IRE (Institute of Radio Engineers) is the unit to display the size of the video signal and can be set among 10, 20, 30 to 100. You can adjust Red, Green or Blue according to each setting. • Red/Green/Blue: The adjustment range is -50 to +50.
<p>Colour Management System</p>	<ul style="list-style-type: none"> ■ As the tool used by the experts to make adjustments by using the test patterns, this does not affect other colours but can be used to selectively adjust the 6 colour areas (Red/Green/Blue/Cyan/Magenta/Yellow). Colour difference may not be distinctive even when you make the adjustments for the general video. ■ Adjusts Red/Green/Blue/Yellow/Cyan/Magenta. <ul style="list-style-type: none"> • Red/Green/Blue/Yellow/Cyan/Magenta Colour: The adjustment range is -30 to +30. • Red/Green/Blue/Yellow/Cyan/Magenta Tint: The adjustment range is -30 to +30. ■ This feature is disable in RGB-PC and HDMI (PC) mode.

PICTURE RESET

Settings of the selected picture modes BACK to the default factory settings.



- 1   Select **PICTURE**.
- 2   Select **Picture Reset**.
- 3   Select **Yes** or **No**.
- 4 

- Press the **MENU** or **EXIT** button to close the menu window.
- Press the **BACK** button to move to the previous menu screen.

PICTURE CONTROL

SCREEN SETUP FOR PC MODE

Selecting Resolution

To view a normal picture, match the resolution of RGB mode and selection of PC mode.

This function works in the following mode: RGB[PC] mode.

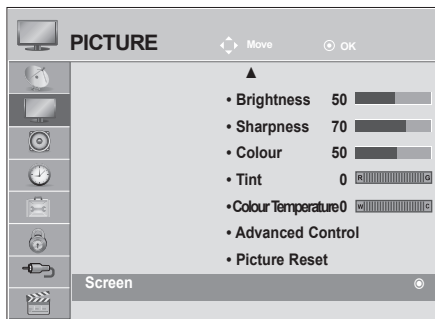

<Vertical resolution : 768>

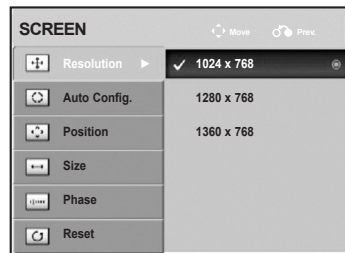



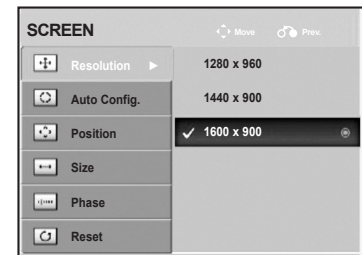



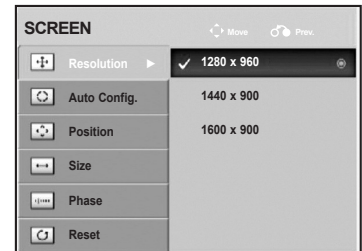

M2080D / M2080DF / M2080D / M2080DN
<Vertical resolution : 900>



M2280D / M2380D / M2780D
M2280DF / M2380DF / 2780DF
M2280DB / M2380DB
M2280DN / M2380DN / M2780DN
<Vertical resolution : 900>



- 1   Select **PICTURE**.
- 2   Select **Screen**.
- 3   Select **Resolution**.
- 4   Select the desired resolution.
- 5 

- Press the **MENU** or **EXIT** button to close the menu window.
- Press the **BACK** button to move to the previous menu screen.

Auto Configure (RGB [PC] mode only)







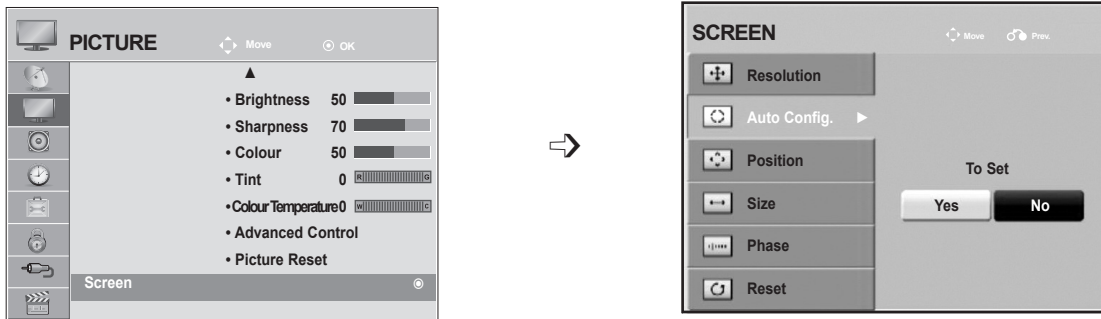

Automatically adjusts picture position and minimizes image instability. After adjustment, if the image is still not correct, your set is functioning properly but needs further adjustment.

Auto configure

This function is for automatic adjustment of the screen position, clock, and phase. The displayed image will be unstable for a few seconds while the auto configuration is in progress.

1. Using OSD



- 1   Select **PICTURE**.
- 2   Select **Screen**.
- 3   Select **Auto Config.**
- 4   Select **Yes**.
- 5  Run **Auto Config.**

- If the position of the image is still not correct, try Auto adjustment again.
- If picture needs to be adjusted again after Auto adjustment in RGB (PC), you can adjust the Position, Size or Phase.

- Press the **MENU** or **EXIT** button to close the menu window.
- Press the **BACK** button to move to the previous menu screen.

PICTURE CONTROL

2. Using Auto Config. (Remocon)

This function is available for RGB signals only.

M2080D / M2080DF / M2080DB / M2080DN

1



Press **Auto Config.**

Auto in progress

<1600 x 900 Resolution>



Auto in progress
For optimal display
change resolution 1600 x 900

<Others Resolution>

M2280D / M2380D / M2780D / M2280DF / 2380DF / M2780DF M2280DB / M2380DB / M2280DN / M2380DN / M2780DN

2



Press **Auto Config.**

Auto in progress

<1920 x 1080 Resolution>



Auto in progress
For optimal display
change resolution 1920 x 1080









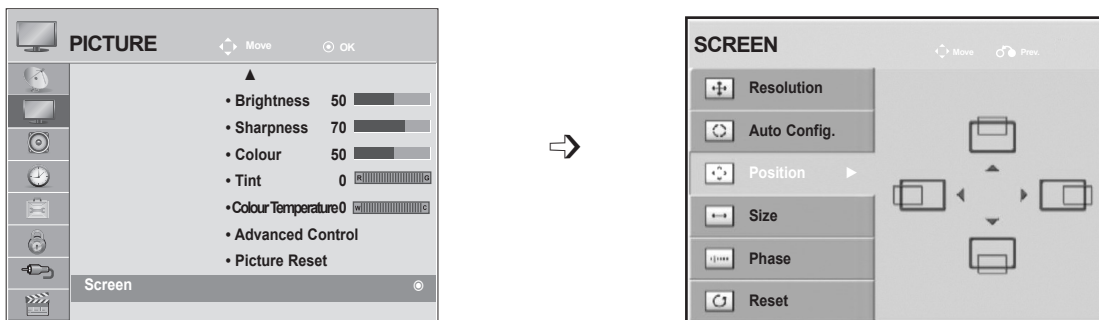

<Others Resolution>

Adjustment for screen Position, Size, Phase

If the picture is not clear after auto adjustment and especially if characters are still trembling, adjust the picture phase manually.

This function works in the following mode: RGB[PC].



- 1   Select **PICTURE**.
- 2   Select **Screen**.
- 3   Select **Position, Size or Phase**.
- 4    Make appropriate adjustments.
- 5 

- Press the **MENU** or **EXIT** button to close the menu window.
- Press the **BACK** button to move to the previous menu screen.







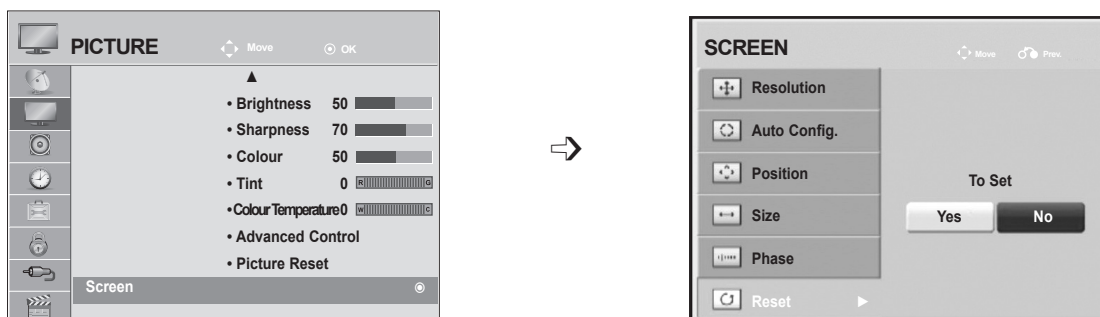

PICTURE CONTROL

Screen Reset

Returns **Position**, **Size** and **Phase** to the factory default settings.

This function works in the following mode: RGB[PC].



- 1   Select **PICTURE**.
- 2   Select **Screen**.
- 3   Select **Reset**.
- 4   Select **Yes**.
- 5  Run **Reset**.

- Press the **MENU** or **EXIT** button to close the menu window.
- Press the **BACK** button to move to the previous menu screen.

SOUND CONTROL





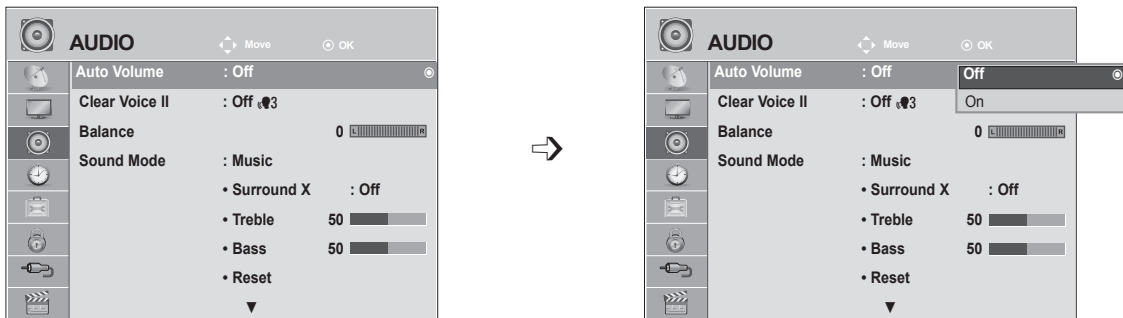

AUTO VOLUME LEVELER

AVL automatically remains on the same level of volume if you change programmes.

Because each broadcasting station has its own signal conditions, volume adjustment may be needed every time the channel is changed. This feature allows users to enjoy stable volume levels by making automatic adjustments for each program.

If sound quality or volume is not at the level you want, it is recommended to use a separate home theater system or amp to cope with different user environments.



- 1   Select **AUDIO**.
- 2   Select **Auto Volume**.
- 3   Select **On** or **Off**.
- 4 





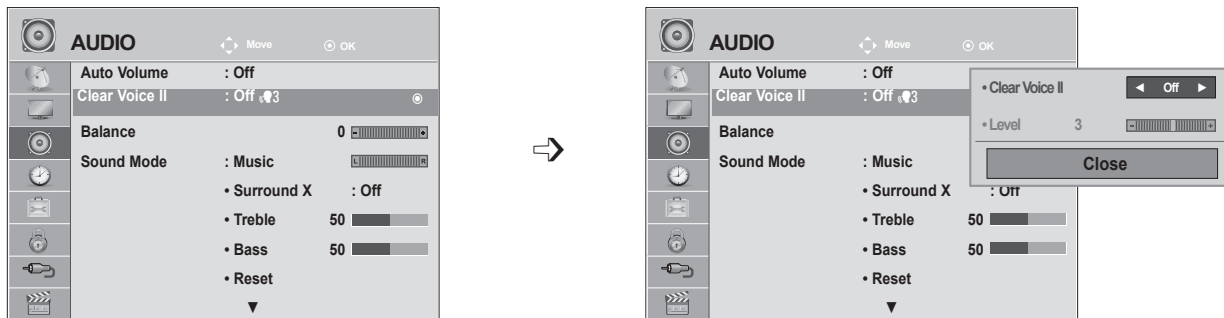

- Press the **MENU** or **EXIT** button to close the menu window.
- Press the **BACK** button to move to the previous menu screen.

SOUND CONTROL

CLEAR VOICE II

By differentiating the human sound range from others, it helps users listen to human voices better.



- 1   Select **AUDIO**.
- 2   Select **Clear Voice II**.
- 3   Select **On** or **Off**.

- If you select “On” for **Clear Voice II**, **Surround X** feature will not work.
- Select levels from ‘-6’ to ‘+6’.

Adjustment for Clear Voice Level With selecting On





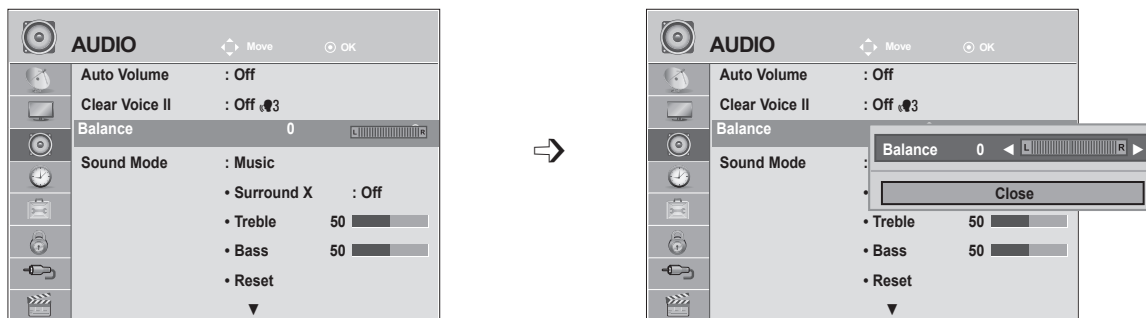

- 4   Select **Level**.
- 5   Make desired adjustment.

- Press the **MENU** or **EXIT** button to close the menu window.
- Press the **BACK** button to move to the previous menu screen.

BALANCE

You can adjust the sound balance of the speakers to preferred levels.



- 1   Select **AUDIO**.
- 2   Select **Balance**.
- 3   Make desired adjustment.

- Press the **MENU** or **EXIT** button to close the menu window.
- Press the **BACK** button to move to the previous menu screen.

SOUND CONTROL

PRESET SOUND SETTINGS-SOUND MODE





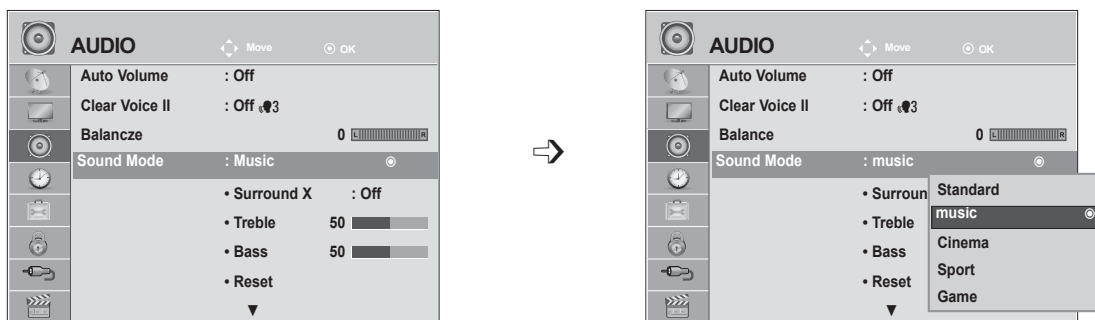

You can select your preferred sound setting; **Standard**, **Music**, **Cinema**, **Sport** or **Game** and you can also adjust the **Treble**, **Bass**.

Sound Mode lets you enjoy the best sound without any Special adjustment as the TV sets the appropriate sound options based on the programme content.

Standard, **Music**, **Cinema**, **Sport** and **Game** are preset for optimum sound quality at the factory.

- | | |
|-----------------|---|
| Standard | Offers standard-quality sound. |
| Music | Optimizes sound for listening to music. |
| Cinema | Optimizes sound for watching movies. |
| Sport | Optimizes sound for watching sports events. |
| Game | Optimizes sound for playing games. |



- 1   Select **AUDIO**.
- 2   Select **Sound Mode**.
- 3   Select **Standard**, **Music**, **Cinema**, **Sport** or **Game**.
- 4 

• You can also adjust **Sound Mode** in the **Q. Menu**.

- Press the **MENU** or **EXIT** button to close the menu window.
- Press the **BACK** button to move to the previous menu screen.

PRESET SOUND SETTINGS-USER MODE

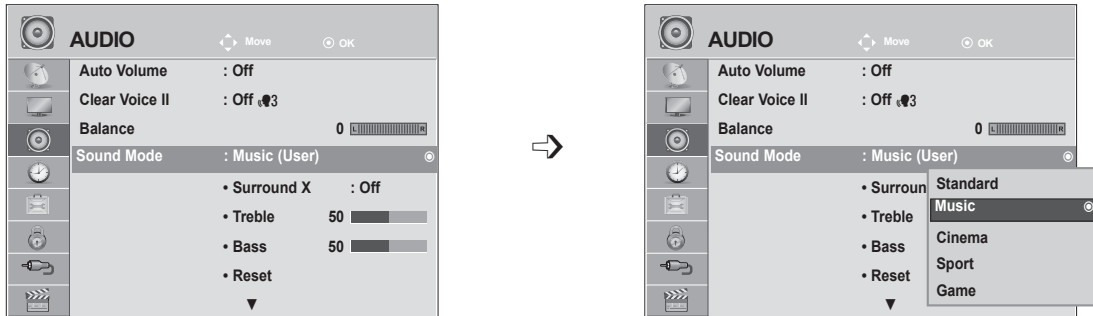

- 1 Select **AUDIO**.
- 2 Select **Sound Mode**.
- 3 Select **Standard, Music, Cinema, Sport or Game**.
- 4 Select **Treble** or **Bass**.
- 5 Set the desired sound level.

Surround X

Select this option to sound realistic.

Enhance sound depth and darity by maximizing Surround effect.

- 1 Select **AUDIO**.
- 2 Select **Surround X**.
- 3 Select **On** or **off**
- 4

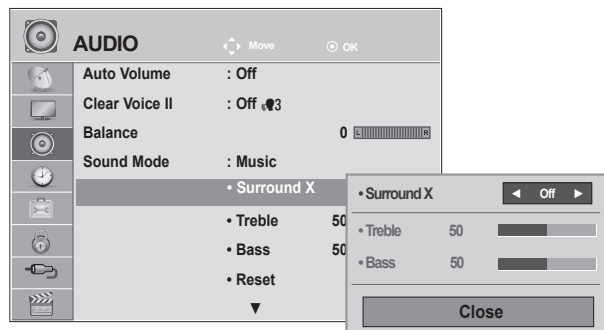





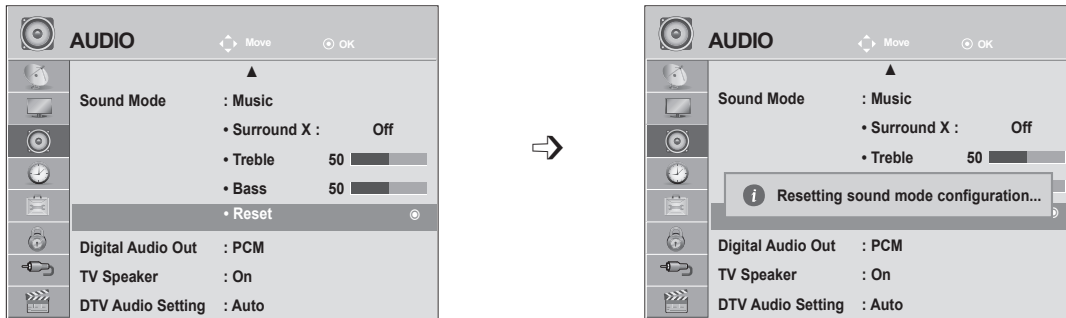

- Press the **MENU** or **EXIT** button to close the menu window.
- Press the **BACK** button to move to the previous menu screen.

SOUND CONTROL

AUDIO RESET

Settings of the selected Sound Mode return to the default factory settings.



- 1   Select **AUDIO**.
- 2   Select **Reset**.
- 3  Initialize the adjusted value.

- Press the **MENU** or **EXIT** button to close the menu window.
- Press the **BACK** button to move to the previous menu screen.

DIGITAL AUDIO OUT

This function allows you to select your preferred Digital Audio Output.

The TV can only output DOLBY Digital if a channel is broadcast with Dolby Digital audio.

When Dolby digital is available, selecting Auto in the Digital Audio Out menu will set SPDIF (Sony Philips Digital InterFace) output to Dolby Digital.

If Auto is selected in the digital audio out menu when dolby digital is not available, SPDIF output will be PCM (Pulse-code modulation).

Even if both Dolby Digital and Audio language have been set in a channel which broadcast Dolby Digital Audio, only Dolby Digital will be played.

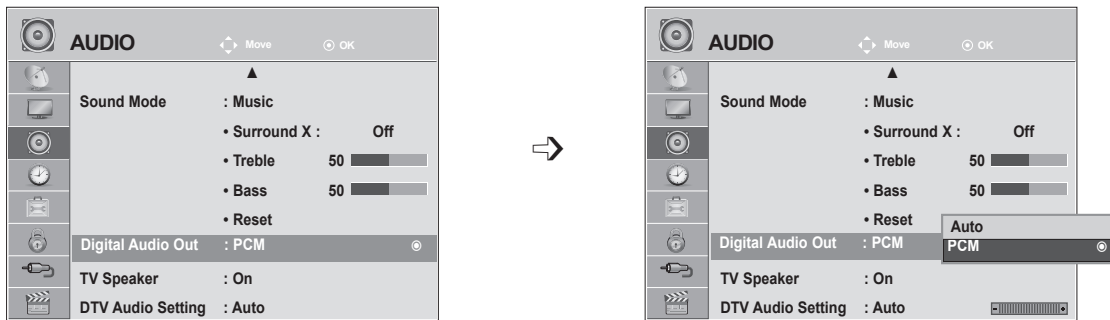

- 1 Select **AUDIO**.
- 2 Select **Digital Audio Out**.
- 3 Select **Auto** or **PCM**.
- 4 Select **Auto** or **PCM**.



Manufactured under license from Dolby Laboratories. "Dolby" and the double-D symbol are trademarks of Dolby Laboratories.

- There is a possibility that when HDMI mode, some DVD players do not make SPDIF sound. At that time, set the output of the digital audio of the DVD player to PCM. (In HDMI, Dolby Digital Plus is not supported).

Item	Audio Input	Digital Audio output
Auto (Speaker On)	MPEG Dolby Digital Dolby Digital Plus HE-AAC	PCM Dolby Digital Dolby Digital PCM
Auto (Speaker Off)	MPEG Dolby Digital Dolby Digital Plus HE-AAC	PCM Dolby Digital Dolby Digital Dolby Digital
PCM	PCM	PCM

- Press the **MENU** or **EXIT** button to close the menu window.
- Press the **BACK** button to move to the previous menu screen.

SOUND CONTROL





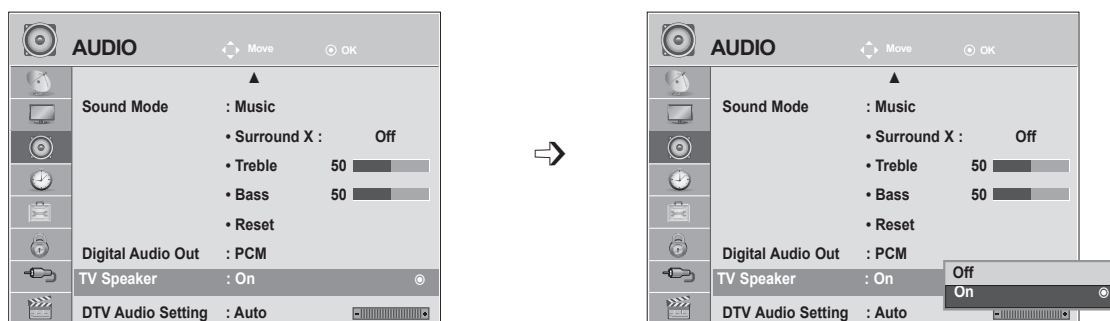

TV SPEAKERS ON / OFF SETUP

You can adjust the TV internal speaker status.

In **AV1, AV2, COMPONENT, RGB** and **HDMI 1** or **HDMI** with **HDMI to DVI** cable, the TV speaker can be operational even when there is no video signal.

If you wish to use an external Hi-Fi system, turn off the TV's internal speakers.



- 1   Select **AUDIO**.
- 2   Select **TV Speaker**.
- 3   Select **On** or **Off**.
- 4 

- Press the **MENU** or EXIT button to close the menu window.
- Press the **BACK** button to move to the previous menu screen.





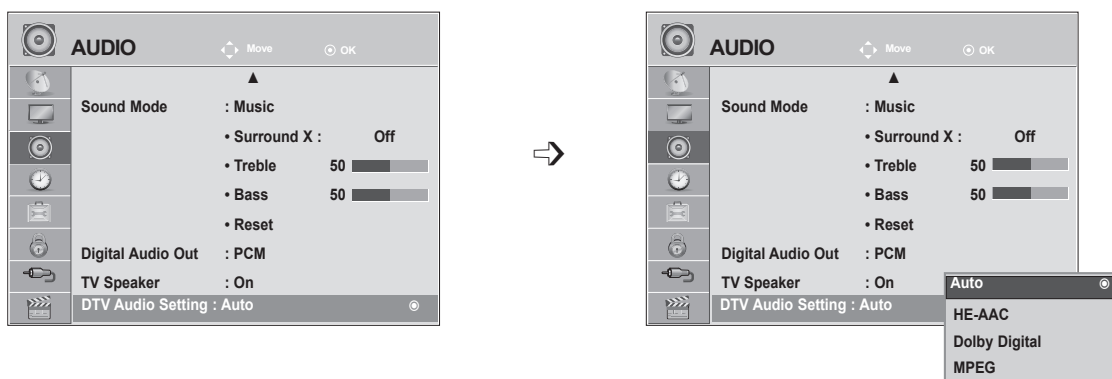

! NOTE

- ▶ When the TV speaker is turned off while the Simplink home theater is operating, the sound output automatically switches to the Home theater speaker, but when the TV speaker is turned on, the sound output the TV speaker.
- ▶ Some menus in **AUDIO** are disabled when TV Speaker is set to Off.

DTV AUDIO SETTING (IN DIGITAL MODE ONLY)

When different audio types exist in an input signal, this function allows you to select the audio type you want.



- 1   Select **AUDIO**.
- 2   Select **DTV Audio Setting**.
- 3   Select **Auto, HE-AAC, Dolby Digital or MPEG**.
- 4 

- Press the **MENU** or **EXIT** button to close the menu window.
- Press the **BACK** button to move to the previous menu screen.

- **Auto**: Automatically outputs in the order **HE - AAC** ► **Dolby Digital** ► **MPEG**.
- **HE - AAC, Dolby Digital, MPEG**: Allows users to select the audio type they want.
If **MPEG** is selected, MPEG is always outputted.
If **MPEG** is not supported, **HE - AAC** and **Dolby Digital** are selected in that order.
- Refer to p. 100 (Audio Language Selection)

SOUND CONTROL

I/II

Stereo/Dual Reception (In Analogue Mode Only)

When a programme is selected, the sound information for the station appears with the programme number and station name.



Broadcast	On Screen Display
Mono	MONO
Stereo	STEREO
Dual	DUAL I , DUAL II , DUAL I + II

■ Mono sound selection

If the stereo signal is weak in stereo reception, you can switch to mono. In mono reception, the clarity of sound is improved.

■ Language selection for dual language broadcast

If a programme can be received in two languages (dual language), you can switch to DUAL I, DUAL II or DUAL I + II.

DUAL I Sends the primary broadcast language to the loudspeakers.

DUAL II Sends the secondary broadcast language to the loudspeakers.

DUAL I+II Sends a separate language to each loudspeaker.

NICAM Reception (In Analogue Mode Only)

If the TV is equipped with a receiver for NICAM reception, high quality NICAM (Near Instantaneous Companding Audio Multiplex) digital sound can be received.

Sound output can be selected according to the type of broadcast received.

-
- 1 When **NICAM mono** is received, you can select **NICAM MONO** or **MONO**.

 - 2 When **NICAM stereo** is received, you can select **NICAM STEREO** or **MONO**.
If the stereo signal is weak, switch to **MONO**.

 - 3 When **NICAM dual** is received, you can select **NICAM DUAL I**, **NICAM DUAL II** or **NICAM DUAL I+II** or **MONO**.
-

Speaker Sound Output Selection

In AV, Component, RGB and HDMI mode, you can select output sound for the left and right loudspeakers.

Select the sound output.

L+R: Audio signal from audio L input is sent to the left loudspeaker and audio signal from audio R input is sent to the right loudspeaker.

L+L: Audio signal from audio L input is sent to left and right loudspeakers.

R+R: Audio signal from audio R input is sent to left and right loudspeakers.

TIME SETTING

CLOCK SETUP





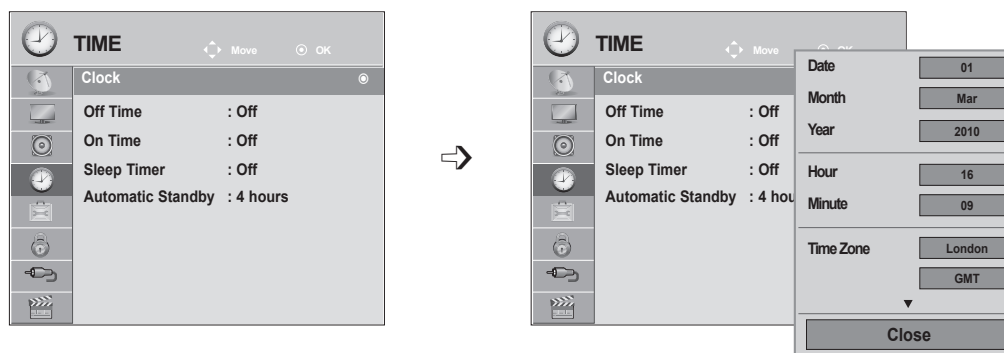

The clock is set automatically when receiving a digital signal. (You can set the clock manually only if the TV has no DTV signal.)

You must set the time correctly before using on/off timer function.

When you select a Time Zone city, the TV time is set by the time offset information based on Time Zone and GMT (Greenwich Mean Time) which is received with the broadcast signal and the time is set automatically by a digital signal.

Once Clock is set in DTV mode, you cannot change time, but if the city name in Time Zone is changed into offset, you can change time by 1 hour.



-   Select **TIME**.
-   Select **Clock**.
-   Select **either the year, month, date, time or Time Zone** option.
-  Set the **year, month, date, time or Time Zone** option.

- Press the **MENU** or **EXIT** button to close the menu window.
- Press the **BACK** button to move to the previous menu screen.

AUTO ON/OFF TIME SETTING

The Off time function automatically switches the TV to standby at a preset time.

Two hours after the TV is switched on by the on time function it will automatically switch back to standby mode unless a button has been pressed.

The Off time function overrides the On time function if both are set to the same time.

The TV must be in standby mode for the On time to work.

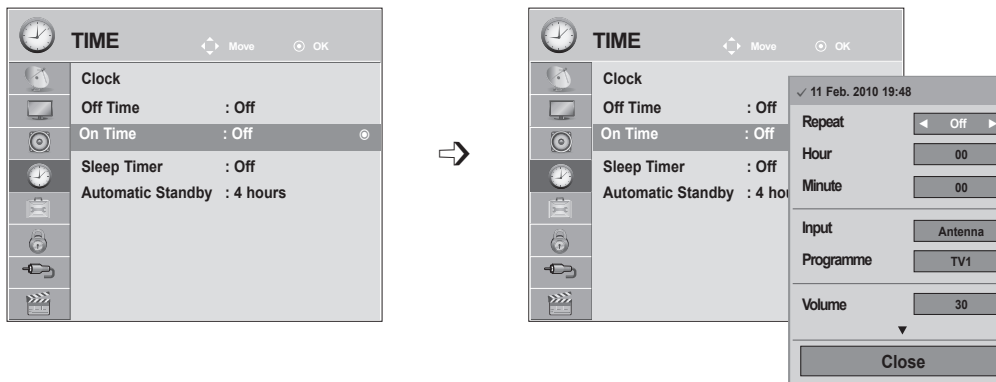

- 1 Select **TIME**.
- 2 Select **Off Time** or **On Time**.
- 3 Select **Repeat**.
- 4 Select **Off**, **Once**, **Daily**, **Mon ~ Fri**, **Mon ~ Sat**, **Sat ~ Sun** or **Sun**.
- 5 Set the **hour**.
- 6 Set the **minutes**.

- To cancel **On/Off** Time function, select **Off**.
 - For On Time function only
- 1 Select **Input**.
 - 2 Select the input source.
 - 3 Set the programme.
 - 4 Adjust volume level at switch-on.

- Press the **MENU** or **EXIT** button to close the menu window.
- Press the **BACK** button to move to the previous menu screen.

TIME SETTING

SLEEP TIMER SETTING

You do not have to remember to switch the TV off before you go to sleep. The sleep timer automatically switches the TV to standby after the preset time has elapsed.

1   Select **Sleep Timer**.

2  Select **Off, 10, 20, 30, 60, 90, 120, 180 or 240 min.**



- When you switch the TV off, the preset sleep timer is cancelled.
- You can also adjust **Sleep Timer** in the **TIME** menu.

AUTOMATIC STNADBY SETTING

If you do not press any button when Automatic Standby function is on, the TV automatically switches to the standby mode.

1   Select **TIME**.

2   Select **Automatic Standby**.

3   Select **Off, 4 hours, 6 hours or 8 hours**.

4  Save.

! NOTE

- ▶ This function does not work on Store Demo mode or while Software update.
- ▶ This function does not work on RGB-PC/HDMI-PC mode.

OPTION SETTING

ON-SCREEN MENU LANGUAGE / COUNTRY SELECTION

The installation guide menu appears on the TV screen when it is switched on for the first time.

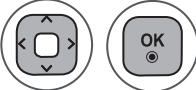
1  Select your **desired language**.

2  Select your **country**.

• If you want to change Language/ Country selection

1  Select **OPTION**.

2  Select **Menu Language** or **Country**.

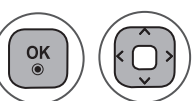
3  Select your **desired language** or **country**.

4  Save.

- When France is selected for Country, password is not '0', '0', '0', '0' but '1', '2', '3', '4'.

- Press the **MENU** or **EXIT** button to close the menu window.
- Press the **BACK** button to move to the previous menu screen.

! NOTE

- ▶ If you do not finish the set-up **Installation Guide** by pressing **RETURN** or if you time out on the OSD (On Screen Display) the installation menu will continuously appear until the set up is completed whenever the TV is switched on.
- ▶ If you select the wrong local country, teletext may not appear correctly on the screen and some problems may occur during teletext operation.
- ▶ The CI (Common Interface) function may not be applied based on country broadcasting circumstances.
- ▶ DTV mode control buttons may not function based on country broadcasting circumstances.
- ▶ In country that Digital broadcasting regulation isn't fixed, some DTV function may not work depending on digital broadcasting circumstances.
- ▶ The Country Setting "UK" should only be activated in UK.
- ▶ If the country setting is set to "-", European terrestrial/cable digital standard broadcasting programmes are available, but some DTV functions may not work properly.

OPTION SETTING

LANGUAGE SELECTION (IN DIGITAL MODE ONLY)

The Audio function allows selection of a preferred language.

If audio data in a selected language is not broadcast, the default language audio will be played.

Use the Subtitle function when two or more subtitle languages are broadcast. If subtitle data in a selected language is not broadcast, the default language subtitle will be displayed.

When the languages you selected as the primary for Audio Language and Subtitle Language are not supported, you can select language in secondary category.

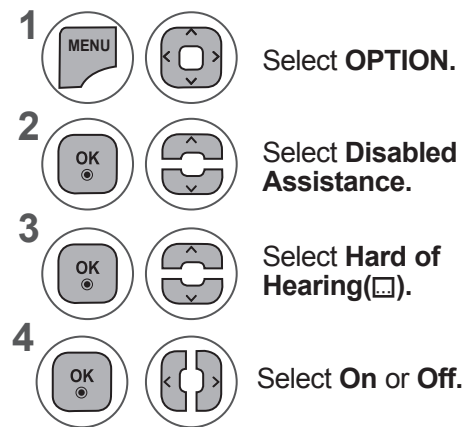
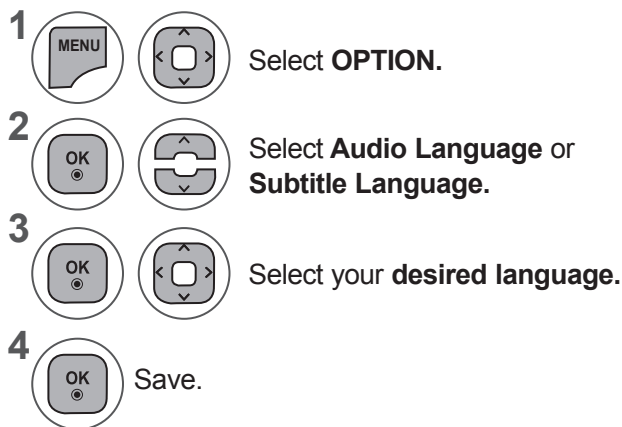

- Press the **BACK** button to move to the previous menu screen.

< Audio Language Selection >

▶ When two or more audio languages are broadcast, you can select the audio language.

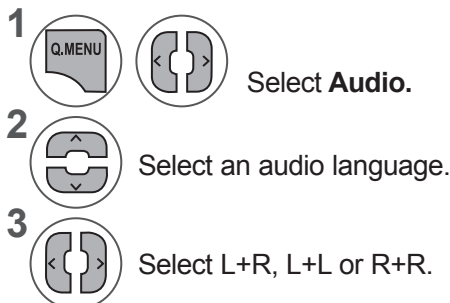

< Subtitle Language Selection >

▶ When two or more subtitle languages are broadcast, you can select the subtitle language with the **SUBTITLE** button on the remote control.

▶ Press the $\wedge \vee$ button to select a subtitle language.

- The audio/subtitles can be displayed in a simpler form with 1 to 3 characters broadcast by the service provider.
- When you select supplementary Audio (Audio for "Visual/Hearing Impaired") the TV may output a part of the Main audio.

Audio Language OSD Information

Display	Status
N.A	Not Available
MPEG	MPEG Audio
DD	Dolby Digital Audio
VI	Audio for "Visual Impaired"
ABC	Audio for "Hearing Impaired"
DD+	Dolby Digital Plus Audio
AAC	AAC Audio

Subtitle Language OSD Information







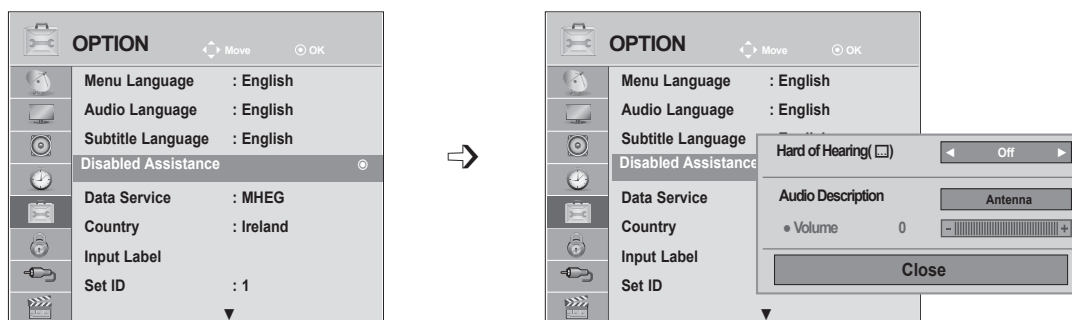

Display	Status
N.A	Not Available
TV	Teletext Subtitle
ABC	Subtitle for "Hard of Hearing"

AUDIO DESCRIPTION (IN DIGITAL MODE ONLY)





This function is for the blind, and provides explanatory audio describing the current situation in a TV programme in addition to the basic audio.

When Audio Description On is selected, basic audio and Audio Description are provided only for those programmes that have Audio Description included.



- 1   Select **OPTION**.
- 2   Select **Disabled Assistance**.
- 3   Select **Audio Description**.
- 4   Select **On** or **Off**.

Adjustment for Audio Description Volume With selecting On

- 5   Select **Volume**.
- 6   Make desired adjustment.

- Press the **MENU** or **EXIT** button to close the menu window.
- Press the **BACK** button to move to the previous menu screen.

OPTION SETTING





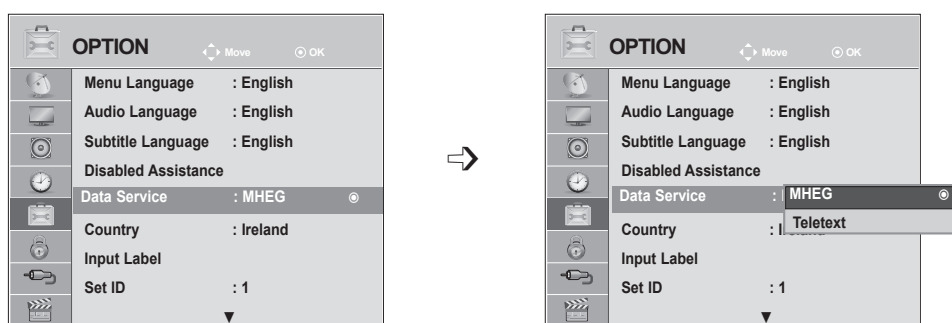

DATA SERVICE

(This menu is enabled only in Ireland.)

This function allow users to choose between **MHEG (Digital Teletext)** and **Teletext** if both exist at the same time.

If only one of them exists, either **MHEG** or **Teletext** is enabled regardless of which option you selected.



- 1   Select **OPTION**.
- 2   Select **Data Service**.
- 3   Select **MHEG** or **Teletext**.
- 4  Save.

- Press the **MENU** or **EXIT** button to close the menu window.
- Press the **BACK** button to move to the previous menu screen.





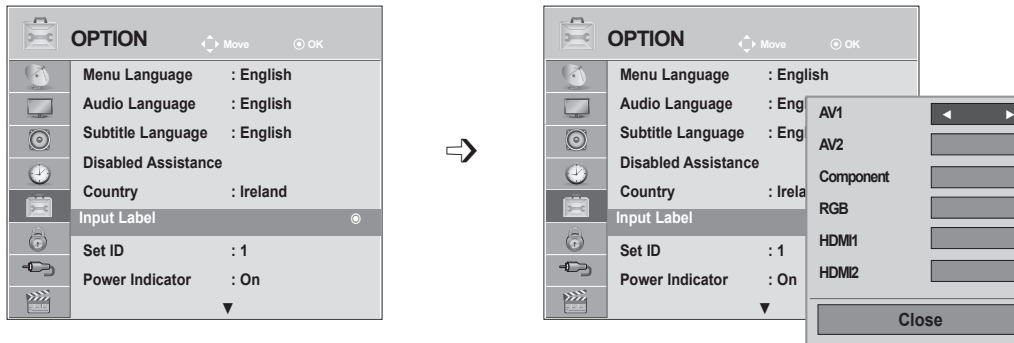

INPUT LABEL

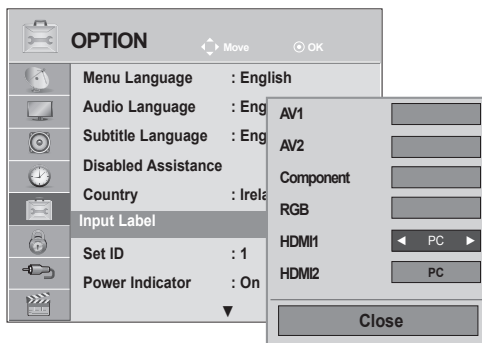
Selects a label for each input source.



If you want to use HDMI-PC mode, you must set the input label to PC mode.
(Refer to the below figure)



- 1   Select **OPTION**.
- 2   Select **Input Label**.
- 3   Select the source.
- 4  Select the label.

- Press the **MENU** or **EXIT** button to close the menu window.
- Press the **BACK** button to move to the previous menu screen.

OPTION SETTING

POWER INDICATOR

Select the power indicator on or off.





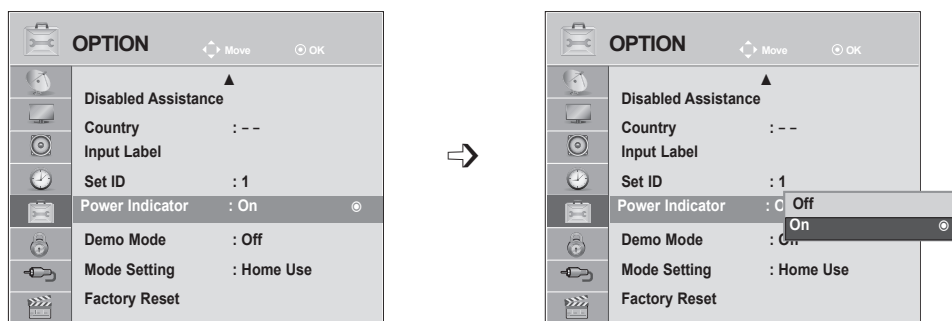

Power indicator On

- Normal Mode: Blue LED On.
- Off Mode: LED Off

Power indicator Off

- Normal Mode: Blue LED Off.
- Off Mode: LED Off



- 1   Select **OPTION**.
- 2   Select **Power Indicator**.
- 3   Select **On** or **Off**.
- 4 

- Press the **MENU** or **EXIT** button to close the menu window.
- Press the **BACK** button to move to the previous menu screen.

DEMO MODE

Display the slide show to explain the various logo of this TV.

It is not possible to use **Demo Mode** in **Home Use mode**.

In **Store Demo**, **Demo Mode** is automatically set to **On**.

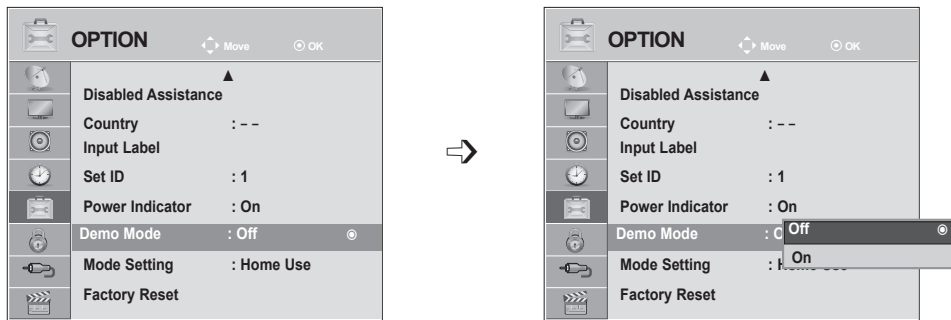

Once **Demo Mode** is set to **Off** in **Store Demo**, **Demo Mode** does not run and only the screen is reset.

The screen is reset automatically after 5 minutes in **Demo Mode**.



1   Select **OPTION**.

2   Select **Demo Mode**.

3   Select **On** to show the various logo of TV.

4  Return to TV viewing.
If you want to stop the demo, press any button. (Except for MUTE, \triangle + , - button)





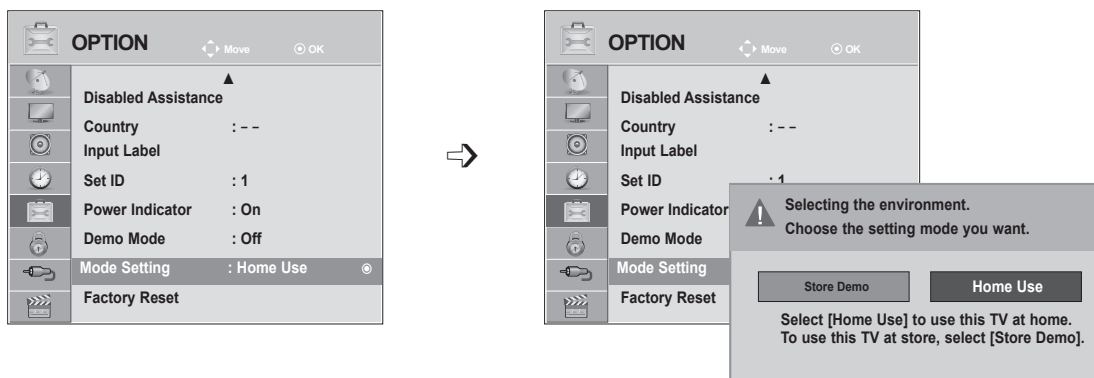

- Press the **MENU** or **EXIT** button to close the menu window.
- Press the **BACK** button to move to the previous menu screen.

OPTION SETTING

MODE SETTING

We recommend setting the TV to “**Home Use**” mode for the best picture in your home environment. “**Store Demo**” mode is an optimal setting for displaying at stores..



- 1   Select **OPTION**.
- 2   Select **Mode Setting**.
- 3   Select **Store Demo** or **Home Use**.
- 4  Save.

- Press the **MENU** or **EXIT** button to close the menu window.
- Press the **BACK** button to move to the previous menu screen.

INITIALIZING(RESET TO ORIGINAL FACTORY SETTINGS)

This function initializes all settings.





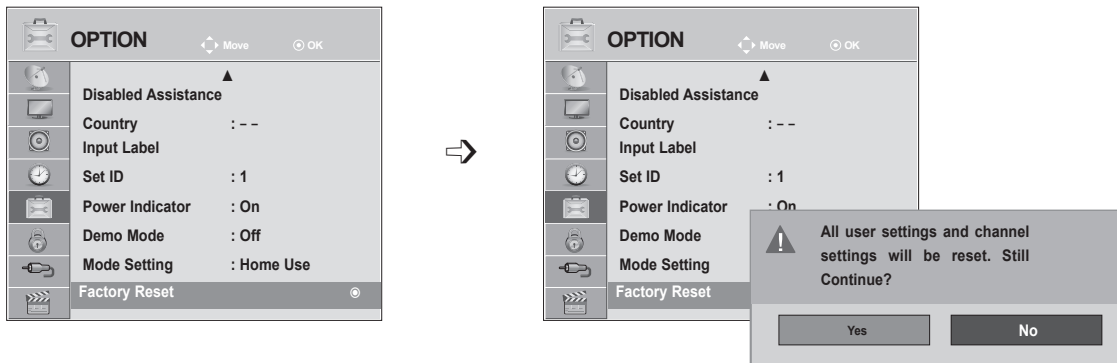

But the settings of **Day** and **Night** of the **Picture Mode** cannot be initialized.

It is useful to initialize the product or when you move to other city or country.

When the Factory Reset is completed, you must restart the Initializing setup.

When the **Lock System** menu is "On", the message to enter the password appears.



- 1   Select **OPTION**.
- 2   Select **Factory Reset**.
- 3   Select **Yes**.
- 4  Start **Factory Reset**.

• In **Lock System "On"**, if you forget your password, press '0', '3', '2', '5' on the remote control handset.

- Press the **MENU** or **EXIT** button to close the menu window.
- Press the **BACK** button to move to the previous menu screen.

PARENTAL CONTROL / RATINGS

SET PASSWORD & LOCK SYSTEM









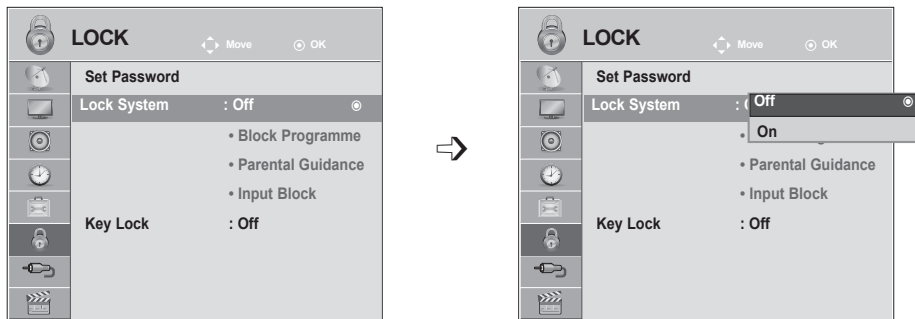

Enter the password, press '0', '0', '0', '0' on the remote control handset.

When France is selected for Country, password is not '0', '0', '0', '0' but '1', '2', '3', '4'.

When France is selected for Country, password cannot be set as '0', '0', '0', '0'.

If a channel is locked, enter the password to unlock it temporarily.



- 1   Select **LOCK**.
- 2   Select **Lock System**.
- 3   Select **On**.
- 4    Set the password.
- 5  Input a 4-digit password.
Be sure to remember this number!
Re-enter new password for confirm.

- If you forget your password, press '0', '3', '2', '5' on the remote control handset.

- Press the **MENU** or **EXIT** button to close the menu window.
- Press the **BACK** button to move to the previous menu screen.





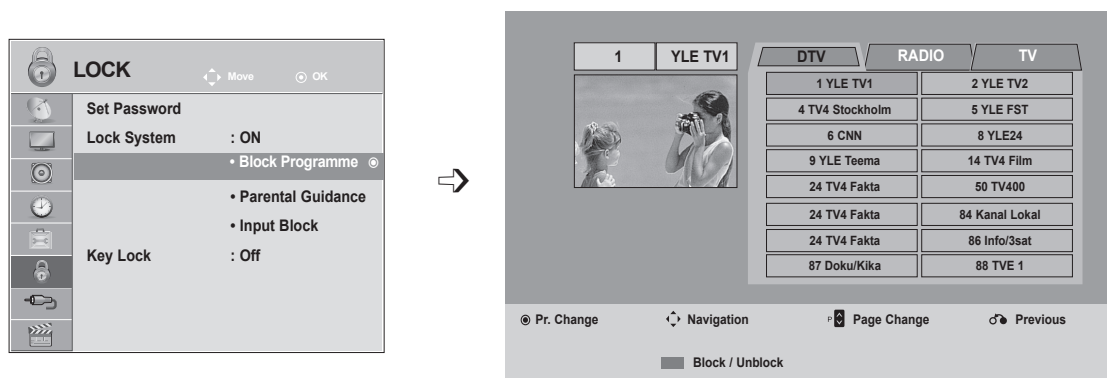

BLOCK PROGRAMME

Blocks any programmes that you do not want to watch or that you do not want your children to watch.

This function is available in **Lock System "On"**.

Enter a password to watch a blocked programme.



- 1   Select **LOCK**.
- 2   Select **Block Programme**.
- 3  Enter the **Block Programme**.
- 4   Select a programme to be locked.

- Press the **MENU** or **EXIT** button to close the menu window.
- Press the **BACK** button to move to the previous menu screen.

PARENTAL CONTROL / RATINGS

PARENTAL CONTROL (IN DIGITAL MODE ONLY)

This function operates according to information from the broadcasting station. Therefore if the signal has incorrect information, this function does not operate.





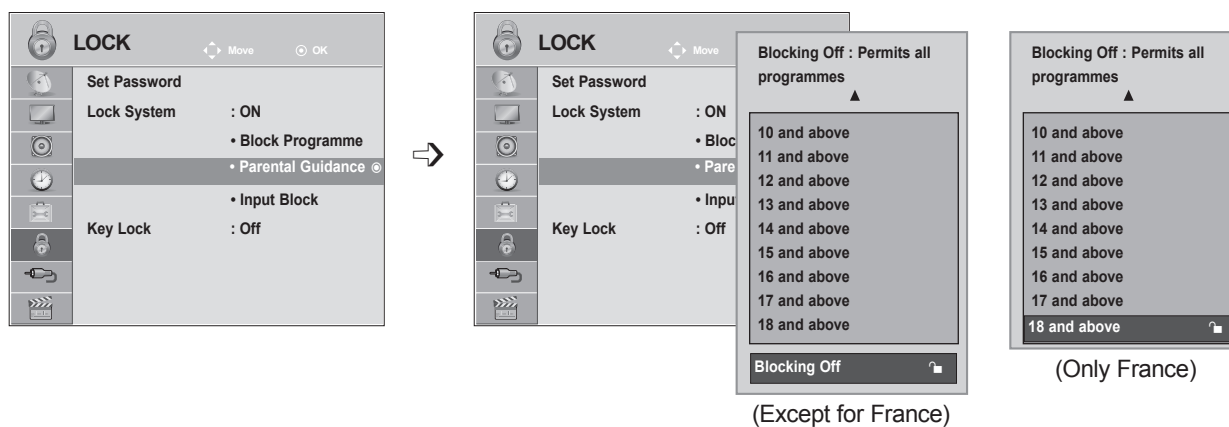

A password is required to gain access to this menu.

This set is programmed to remember which option it was last set to even if you switch the set off.

Prevents children from watching certain adult's TV programmes, according to the ratings limit set.

Enter a password to watch a blocked programme.



- 1   Select **LOCK**.
- 2   Select **Parental Guidance**.
- 3   Make appropriate adjustments.
- 4  Save







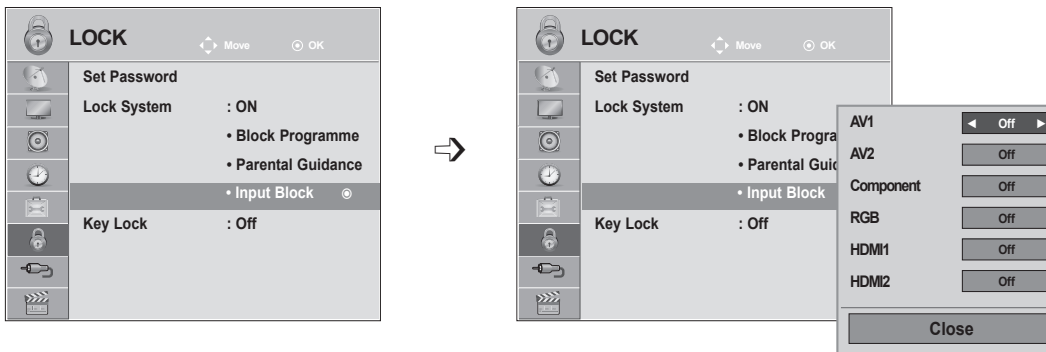

- Press the **MENU** or **EXIT** button to close the menu window.
- Press the **BACK** button to move to the previous menu screen.

INPUT BLOCK

Enables you to block an input.

It is available to use this function in **Lock System "On"**.



- 1   Select **LOCK**.
- 2   Select **Input Block**.
- 3   Select input source.
- 4   Select **On** or **Off**.
- 5  Save





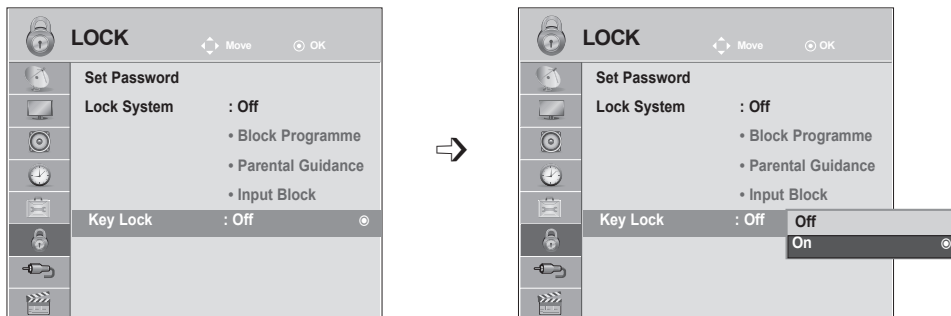

- Press the **MENU** or **EXIT** button to close the menu window.
- Press the **BACK** button to move to the previous menu screen.

PARENTAL CONTROL / RATINGS

KEY LOCK

The TV can be set so that the remote control is required to control it. This feature can be used to prevent unauthorized viewing.



- 1   Select **LOCK**
- 2   Select **Key Lock**.
- 3   Select **On or Off**.
- 4  Save

- In **Key Lock 'On'**, if the TV is turned off, press the **INPUT, P ^ v** button on the TV or **POWER, INPUT, P ^ v, TV/PC** or **NUMBER** buttons on the remote control then the set will be turned on.
- With the **Key Lock On**, the display '**▲ Key Lock On**' appears on the screen if any button on the front panel is pressed while viewing the TV.

- Press the **MENU** or **EXIT** button to close the menu window.
- Press the **BACK** button to move to the previous menu screen.

TO USE A USB DEVICE

WHEN CONNECTING A USB DEVICE

When you connect a USB device, this pop up menu is displayed, automatically.

“POP UP MENU” will not be displayed while the OSD including Menu, EPG or Schedule list is activated or while the Bluetooth Headset is connected.

When the Pop Up menu does not appear, you can select **Music List**, **Photo List** or **Movie List** in the USB menu.

In USB device, you can not add a new folder or delete the existing folder.

- 1 Connect the USB device to the **USB IN** jack on the TV.

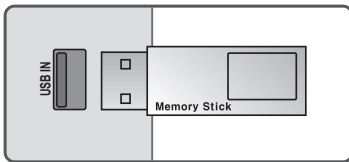

- Only photo(JPEG), music (MP3) and movie (DAT, MPG, MPEG, VOB, AVI, DIVX, MP4, MKV, TS, TRP, TP) are supported.

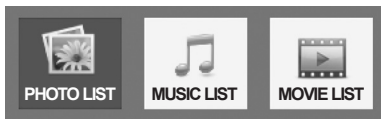

- 2 Select **PHOTO LIST**, **MUSIC LIST** or **MOVIE LIST**



- 3

When removing the USB device

Select the USB Device menu before removing the USB device.

- 1   Select **USB Device**.
- 2  Select **Eject**.

TO USE A USB DEVICE

Precautions when using the USB device

- ▶ Only a USB storage device is recognizable.
- ▶ If the USB storage device is connected through a USB hub, the device is not recognizable.
- ▶ A USB storage device using an automatic recognition programme may not be recognized.
- ▶ A USB storage device which uses its own driver may not be recognized.
- ▶ The recognition speed of a USB storage device may depend on each device.
- ▶ Please do not turn off the TV or unplug the USB device when the connected USB storage device is working. When such device is suddenly separated or unplugged, the stored files or the USB storage device may be damaged.
- ▶ Please do not connect the USB storage device which was artificially maneuvered on the PC. The device may cause the product to malfunction or fail to be played. Never forget to use only a USB storage device which has normal music files, image files or movie files.
- ▶ Please use only a USB storage device which was formatted as a FAT, FAT16, FAT32, NTFS file system provided with the windows operating system. In case of a storage device formatted as a different utility programme which is not supported by Windows, it may not be recognized.
- ▶ Please connect power to a USB storage device(over 0.5 A) which requires an external power supply. If not, the device may not be recognized.
- ▶ Please connect a USB storage device with the cable offered by the device maker.
- ▶ Some USB storage devices may not be supported or operated smoothly.
- ▶ File alignment method of USB storage device is similar to Window XP and filename can recognize up to 100 English characters.
- ▶ Be sure to back up important files since data stored in a USB memory device may be damaged. We will not be responsible for any data loss.
- ▶ If the USB HDD does not have an external power source, the USB device may not be detected. So be sure to connect the external power source.
 - Please use a power adaptor for an external power source. We do not guarantee an USB cable for an external power source.
- ▶ Data in a USB storage device cannot be deleted in the NTFS file system.
- ▶ If your USB memory device has multiple partitions, or if you use a USB multi-card reader, you can use up to 4 partitions or USB memory devices.
- ▶ Only the FAT, FAT16, FAT32 file system supports the delete function.
- ▶ If a USB memory device is connected to a USB multi-card reader, its volume data may not be detected.
- ▶ If the USB memory device does not work properly, disconnect and reconnect it.
- ▶ How fast a USB memory device is detected differs from device to device.
- ▶ If the USB is connected in Standby Mode, specific hard disk will automatically be loaded when the TV is turned on.
- ▶ The recommended capacity is 1 TB or less for a USB external hard disk and 32 GB or less for USB memory.
- ▶ Any device with more than the recommended capacity may not work properly.
- ▶ If a USB external hard disk with a "Energy Saving" function does not work, turn the hard disk off and on again to make it work properly.
- ▶ USB storage devices below USB 2.0 are supported as well. But they may not work properly in the movie list.
- ▶ When a broken file is played in the USB storage, the TV may turn off or work abnormally.

PHOTO LIST

You can view photo files on USB storage device.

The On Screen Display may be different from your TV. Images are an example to assist with the TV operation.

When you are watching the photo by the Photo List function, you can not change the picture mode.

PHOTO(*.JPEG) supporting file

Baseline : 64 x 64 to 15360 x 8640

Progressive : 64 x 64 to 1920 x 1440

- You can play JPEG files only.
- Non-supported files are displayed in the form of predefined icon.

Screen Components

1

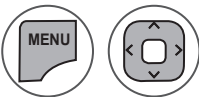

Select **USB**.

2



Select **Photo List**.

- 1** Moves to upper level folder.
- 2** Current page / Total pages.
- 3** Total number of marked photos.
- 4** Corresponding buttons on the remote control.

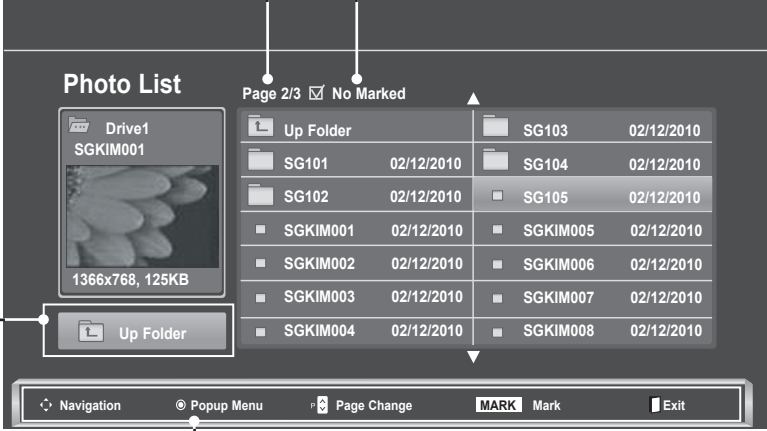





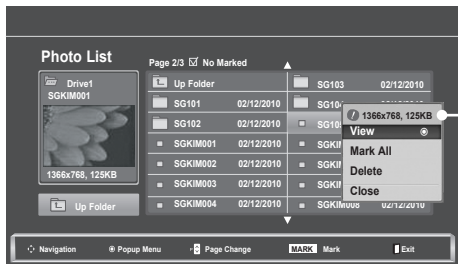
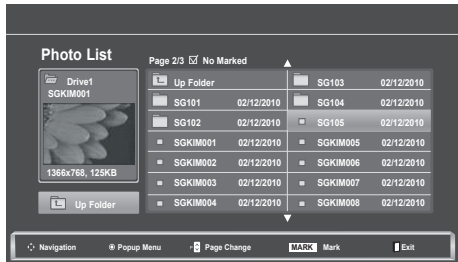

The screenshot shows a 'Photo List' interface. At the top, it says 'Page 2/3' and 'No Marked'. Below this is a list of folders and files: 'Up Folder', 'SG101', 'SG102', 'SG103', 'SG104', 'SG105', 'SGKIM001', 'SGKIM002', 'SGKIM003', 'SGKIM004', 'SGKIM005', 'SGKIM006', 'SGKIM007', and 'SGKIM008'. A 'Up Folder' button is highlighted at the bottom left of the list. At the bottom of the screen is a navigation bar with buttons for 'Navigation', 'Popup Menu', 'Page Change', 'MARK', 'Mark', and 'Exit'.

TO USE A USB DEVICE

Photo Selection and PopUp Menu



- ▶ **View:** Display the selected item.
- ▶ **Mark All:** Mark all photos on the screen.
- ▶ **Unmark All:** Deselect all marked photos.
- ▶ **Delete** or **Delete Marked:** Delete the selected photo item.
- ▶ **Close:** Close the **Pop-Up** menu.

- 1  Select the target folder or drive.
- 2   Select the desired photos.
- 3  Show the **Pop-Up** menu.
- 4   Select the desired **PopUp** menu.

- Use the **P** ^ v button to navigation in the photo page.
- Use the **MARK** button to mark or unmark a photo. When one or more photos are marked, you can view each marked photo or a slide show of the marked photos. If no photos are marked, you can view every individual photo in the folder or a slide show of all photos in the folder.

- Press the **BACK** button to move to the previous menu screen.





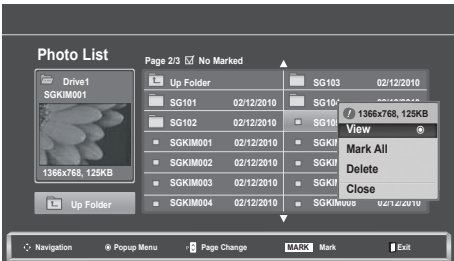
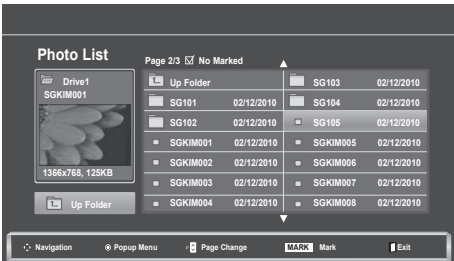

How to view photo

Detailed operations are available on full-sized photo view screen.



The aspect ratio of a photo may change the size of the photo displayed on the screen in full size.

Press the **BACK** button to move to the previous menu screen.

- 1  Select the target folder or drive.
- 2   Select the desired photos.
- 3  Show the **Pop-Up** menu.
- 4  Select **View**.
- 5  The selected photo is displayed in full size.

- Use the **P** ^ v button to navigation in the photo page.

- Press the **BACK** button to move to the previous menu screen.

TO USE A USB DEVICE

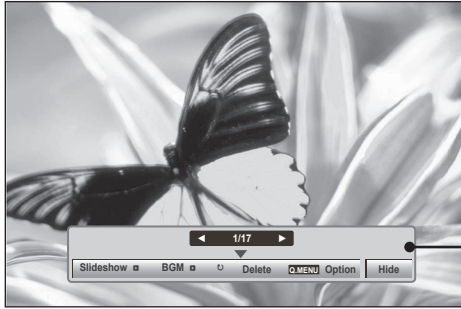

6

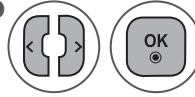



Select the **Slideshow**, **BGM**, **⌚(Rotate)**, **Delete**, **Option** or **Hide**.

- Use < > button to select the previous or next photo.
- Use < > button to select and control the menu on the full-sized screen.

- ▶ **Slideshow** : When no picture is selected, all photos in the current folder are displayed during slide show. If some photos are selected, those photos are displayed in a slide show.
 - Set the time interval of the slide show in **Option**.
- ▶ **BGM (Background Music)**: Listen to music while viewing photos in full size.
 - Set the Music Folder for **BGM** in Options before using this function.
- ▶ **⌚ (Rotate)**: Rotate photos.
 - Rotates the photo 90°, 180°, 270°, 360° clockwise.
 - It can not be rotate when the width of a picture is bigger than supported height.
- ▶ **Delete**: Delete photos.
- ▶ **Option**: Set values for **Slide Speed** and **Music Folder** for **BGM**.
 - Use ^ v < > button and **OK** button to set values. Press **OK** to save the settings.
 - You cannot change **Music Folder** while **BGM** is playing.
- ▶ **Hide**: Hide the menu on the full-sized screen.
 - To see the menu again on the full-sized screen, press **OK** button to display.

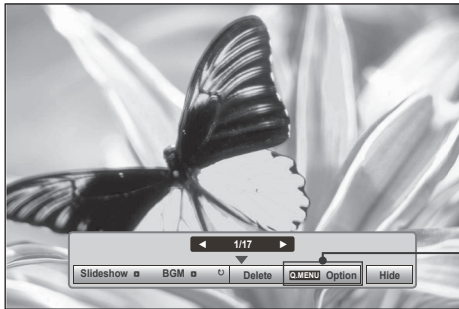
Using the Photo List function





1  Show the **PopUp** menu.

2   Select **Set Photo View**, **Set Video** or **Set Audio**.

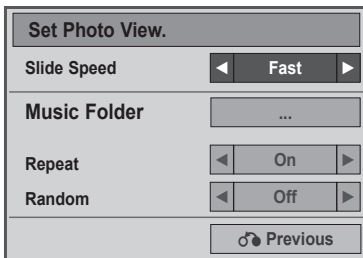
► When you select the **Set Photo View**,



1  Show the **Slide Speed** or **Music Folder**.

2   Make appropriate adjustments.

- When **“Off”** is selected in **Repeat** menu, replay will stop once the last file in the list finishes playing. But, when **“▶▶”** button is pressed while the last file in the list is in the middle of replay and **“Repeat”** is in **“Off”** position, the first file in the list will be played and **“Repeat”** menu will be activated.

TO USE A USB DEVICE

► When you select the **Set Video**,

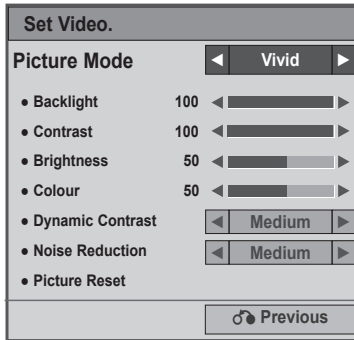

1



Make appropriate adjustments. (Refer to p. 74, 77, 78)

► When you select the **Set Audio**,

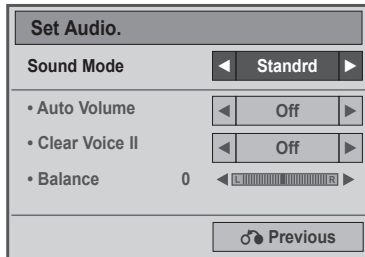

1



Show the **Sound Mode, Auto Volume, Clear Voice II, Balance**.

2



Make appropriate adjustments. (Refer to p. 85 to 89)

MUSIC LIST

You can play music files on USB storage device.

Purchased music files(*.MP3) may contain copyright restrictions. Playback of these files may not be supported by this model.

Music file on your USB device can be played by this unit.

The On Screen Display may be different from your TV. Images are an example to assist with the TV operation.

MUSIC (*.MP3) supporting file Bit rate 32 to 320

- Sampling rate MPEG1 Layer3: 32 kHz, 44.1 kHz, 48 kHz
- Sampling rate MPEG2 Layer3: 16 kHz, 22.05 kHz, 24 kHz
- Sampling rate MPEG2.5 Layer3: 8 kHz, 11.025 kHz, 12 kHz

Screen Components

1

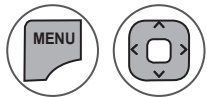

Select **USB**.

2



Select **Music List**.

- 1** Preview: If any album jacket for the file (Album Art Image) exists, this jacket is displayed.
- 2** Moves to upper level folder.
- 3** Current page / Total pages.
- 4** Total number of marked music title.
- 5** Corresponding buttons on the remote control.

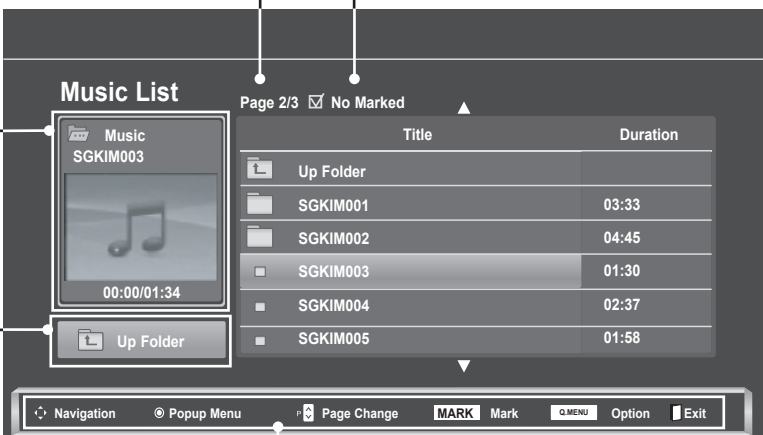

The screenshot shows the 'Music List' interface. At the top left, a preview window (1) displays album art for 'Music SGKIM003' with a progress bar at 00:00/01:34. Below it is an 'Up Folder' button (2). The main list (3) shows 'Page 2/3' and 'No Marked' items. The list table has columns for 'Title' and 'Duration':

Title	Duration
Up Folder	
SGKIM001	03:33
SGKIM002	04:45
SGKIM003	01:30
SGKIM004	02:37
SGKIM005	01:58

At the bottom, a navigation bar (5) includes buttons for Navigation, Popup Menu, Page Change, MARK, Mark, Q.MENU, Option, and Exit.





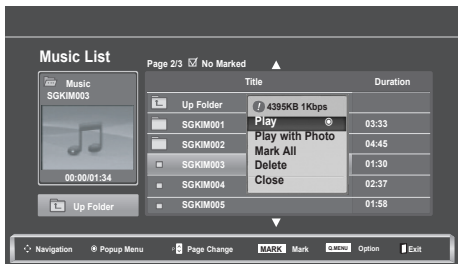
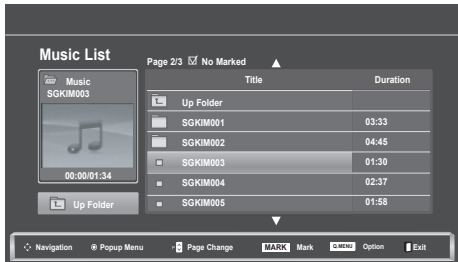

TO USE A USB DEVICE

Music Selection and PopUp Menu

As shown, up to 6 music titles are listed per page.



- ▶ **Play** (During stop): Play the selected music titles. One playback of a piece of music finishes, the next selected one will be played. When there are no selected music titles to play, the next one in the current folder will be played. If you go to a different folder and press the **OK** button, the current music in playback will stop.
- ▶ **Play Marked**: Play the selected music titles. Once a music finishes playing, the next selected one will be played automatically.
- ▶ **Stop Play** (During playback): Stop the playing music titles.
- ▶ **Play with Photo**: Start playing the selected music titles and then move to the **Photo List**.
- ▶ **Mark All**: Mark all music titles in the folder.
- ▶ **Unmark All**: Deselect all marked music titles.
- ▶ **Delete** or **Delete Marked**: Delete the selected music titles.
- ▶ **Close**: Close the **Pop-Up** menu.

- 1  Select the target folder or drive.
- 2   Select the desired photos.
- 3  Show the **Pop-Up** menu.
- 4   Select the desired **PopUp** menu.

- Use the **P** ^ v button to navigate up/down in the music page.
- Use **MARK** button to mark or unmark a music. When one or more music files are marked, the marked music title will be played in sequence. For example, if you want to listen to only one music repeatedly, just mark the music only and play it. If no music is marked, all the music in the folder will be played in sequence.

- Press the **BACK** button to move to the previous menu screen.

- If you don't press any button for a while during the playing, the play information box (as shown in the below) will float as a screen saver.
- The 'Screen Saver'?
Screen saver is to prevent screen pixel damage due to an fixed image remaining on the screen for a extended period of time.

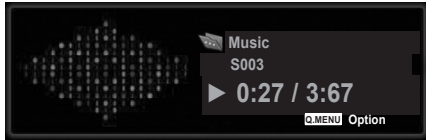

NOTE

- ▶ When a music file is played, ♪ is displayed behind the title.
- ▶ A damaged or corrupted music does not play but displays 00:00 in play time.
- ▶ A music downloaded from a paid service with copyright protection does not start but displays inappropriate information in playtime.
- ▶ If you press **OK**, **■** buttons, screen saver is stopped.
- ▶ The **PLAY(▶)**, **Pause(II)**, **■**, **▶▶**, **◀◀** buttons on the remote control are also available in this mode.
- ▶ You can use the **▶▶** button to select the next music and the **◀◀** button to select the previous music.

Using the Music List function, play

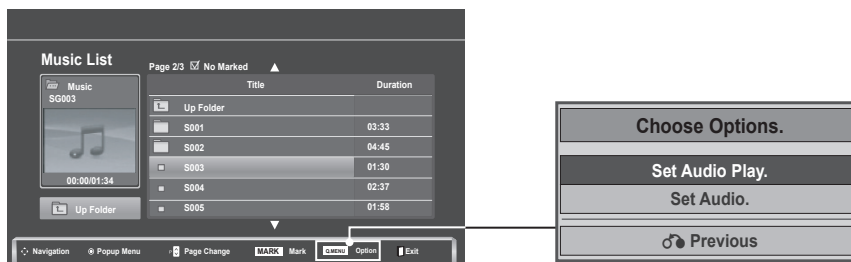

1 Show the **PopUp** menu.

2 Select **Set Audio Play** or **Set Audio**.

TO USE A USB DEVICE

► When you select the **Set Audio Play**,



1



Show the **Set Audio Play**.

2



Make appropriate adjustments.

- When “**Off**” is selected in **Repeat** menu, replay will stop once the last file in the list finishes playing. But, when “▶▶” button is pressed while the last fine in the list is in the middle of replay and “Repeat” is in “Off” position, the first file in the list will be played and “Repeat” menu will be activated.

► When you select the **Set Audio**,

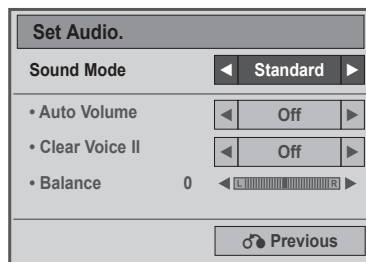

1



Show the **Sound Mode, Auto Volume, Clear Voice II, Balance**.

2



Make appropriate adjustments. (Refer to p. 85 to 89)

MOVIE LIST

You can play movie files on a USB storage device.

The movie list is activated once USB is detected. It is used when playing movie files on TV.

Displays the movies in the USB folder and supports Play.

Allows playback of all movies in the folder and user desired files.

It is a movie list that displays folder information and movie file.

The On Screen Display may be different from your TV. Images are an example to assist with the TV operation.

Movie(*.dat / *.mpg / *.mpeg / *.ts / *.trp / *.tp / *.vob/ *.mp4 / *.mkv / *.avi / *.divx) supporting file
Video format :DivX3.11, DivX4.12, DivX5.x, DivX6, Xvid1.00, Xvid1.01, Xvid1.02, Xvid1.03, Xvid 1.10- beta-1/beta-2, Mpeg-1, Mpeg-2, Mpeg-4, H.264/AVC

Audio format: Dolby Digital, AAC, Mpeg, MP3, LPCM, HE-AAC

Bit rate: within 32 kbps to 320 kbps (MP3)

Subtitle format: *.smi / *.srt / *.sub (MicroDVD, SubViewer1.0/2.0) / *.ass / *.ssa / *.txt (TMPlayer) / *.psb (PowerDivx).

- Some user-created subtitles may not work properly.
- Some special characters are not supported in subtitles.
- HTML tags are not supported in subtitles.
- Subtitles in languages other than the supported languages are not available.
- Time information in an external subtitle file should be arranged in ascending order to be played.
- The screen may suffer temporary interruptions (image stoppage, faster playback, etc.) when the audio language is changed.
- A damaged movie file may not be played correctly, or some player functions may not be usable.
- Movie files produced with some encoders may not be played correctly.
- If the video and audio structure of recorded file is not interleaved, either video or audio is outputted.
- HD videos with a maximum of 1920 x 1080 @ 25/30P or 1280 x 720 @ 50 / 60P are supported, depending on the frame.
- Videos with resolutions higher than 1920 x 1080 @ 25 / 30P or 1280 x 720 @ 50 / 60P may not work properly depending on the frame.
- Movie files other than the specified types and formats may not work properly.
- **Max bitrate of playable movie file is 20 Mbps.**
- We do not guarantee smooth playback of profiles encoded level 4.1 or higher in H.264 / AVC.
- DTS Audio codec is not supported.
- A movie file more than 30GB in file size is not supported for playback.
- A DivX movie file and its subtitle file must be located in the same folder.
- A video file name and its subtitle file name must be identical for it to be displayed.
- Playing a video via a USB connection that doesn't support high speed may not work properly..
- Files encoded with GMC (Global Motion Compensation) may not be played.
- When you are watching the movie by Movie List function, you can adjust an image by **Energy Saving** key on the remote control. User setup for each image mode does not operate.

TO USE A USB DEVICE

File Extension name	Video Decoder	Audio Codec	Max Resolution
mpeg, vob	MPEG1, MPEG2	Dolby Digital, MPEG, MP3, LPCM	1920 x 1080 @ 30p
dat	MPEG1	Dolby Digital, MPEG, MP3, LPCM	
ts, trp, tp	MPEG2, H.264 / AVC	Dolby Digital, AAC, MPEG	
mp4	MPEG4 SP, MPEG4 ASP, Divx 3.11, Divx 4.12, Divx 5.x, Divx 6, Xvid 1.00, Xvid 1.01, Xvid 1.02, Xvid 1.03, Xvid 1.10-beta 1, Xvid 1.10-beta 2, H.264 / AVC	Dolby Digital, HE-AAC, AAC, MPEG, MP3, LPCM	
avi	MPEG 2, MPEG 4 SP, MPEG4 ASP, Divx 3.11, Divx 4, Divx 5, Divx 6, Xvid 1.00, Xvid 1.01, Xvid 1.02, Xvid 1.03, Xvid 1.10-beta 1, Xvid 1.10-beta 2, H.264 / AVC	Dolby Digital, HE-AAC, AAC, MPEG, MP3, LPCM	
mkv	H.264 / AVC, MPEG 1, MPEG 2, MPEG 4 SP, MPEG4 ASP	Dolby Digital, HE-AAC, AAC, MPEG, MP3, LPCM	
divx	MPEG 2, MPEG 4 SP, MPEG4 ASP, Divx 3.11, Divx 4, Divx 5, Divx 6, Xvid 1.00, Xvid 1.01, Xvid 1.02, Xvid 1.03, Xvid 1.10-beta 1, Xvid 1.10-beta 2, H.264 / AVC	Dolby Digital, HE-AAC, AAC, MPEG, MP3, LPCM	

Screen Components

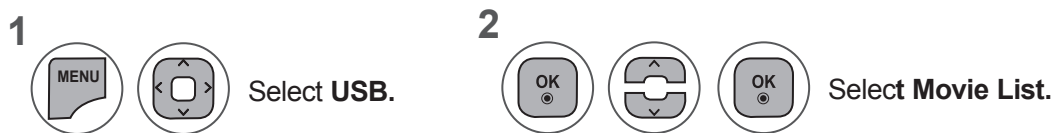



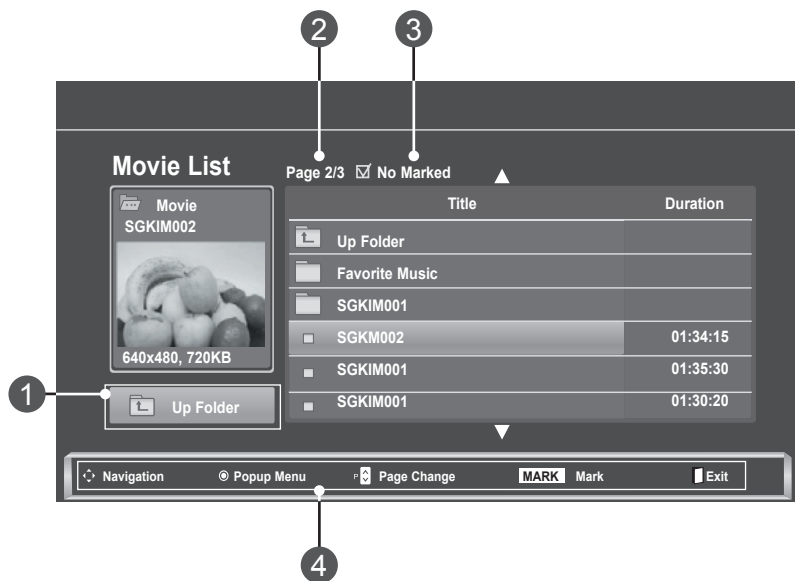

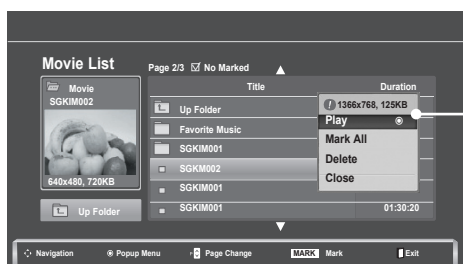
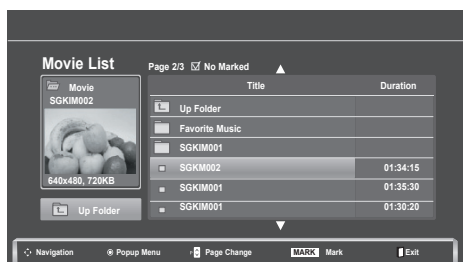

- 1 Moves to upper level folder.
- 2 Current page/Total pages.
- 3 Total number of marked movie title.
- 4 Corresponding buttons on the remote control.



Movie Selection and PopUp Menu



- ▶ **Play:** Play the selected movie. Divx Play is executed while screen changes.
- ▶ **Mark All:** Mark all Movie in the folder.
- ▶ **Unmark All:** Deselect all marked movies.
- ▶ **Delete or Delete Marked:** Delete the selected Movie item.
- ▶ **Close:** Close the **pop-up** menu.

- 1  Select the target folder or drive.
- 2   Select the desired movie title
- 3  Show the **PopUp** menu.
- 4   Select the desired **PopUp** menu.

- Use the **P** ^ v button to navigation in the movie page.
- Use **MARK** button to mark or unmark a movie. When one or more movie files are marked, the marked movies will be played in sequence.

- Press the **BACK** button to move to the previous menu screen.

NOTE

- ▶ In the case of files not supported, a message regarding non-supported file is displayed.

TO USE A USB DEVICE

Using the Movie List function, play





1  Show the **PopUp** menu.

2  Select **Set Video Play**, **Set Video** or **Set Audio**.

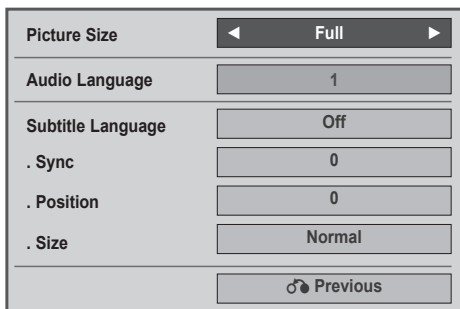
► When you select the **Set Video Play**,



- **Picture Size:** Selects your desired picture format during movie play.
- **Audio Language & Subtitle Language:** Changes the Language Group of the audio/subtitle during movie play.
- **Sync:** Adjusts the time synchronisation of the subtitle from -10 secs to +10 secs by steps of 0.5 secs during movie play.
- **Position:** Changes the position of the subtitle either up or down during movie play.
- **Size:** Selects your desired Subtitle size during movie play.

- 1  Show the **Picture Size, Audio Language or Subtitle Language**.
- 2  Make appropriate adjustments.

Subtitle Language	Support Language
Latin1	English, Spanish, French, German, Italian, Swedish, Finnish, Dutch, Portuguese, Danish, Romanian, Norwegian, Albanian, Gaelic, Welsh, Irish, Catalan, Valencian
Latin2	Bosnian, Polish, Croatian, Czech, Slovak, Slovenian, Serbian, Hungarian
Latin4	Estonian, Latvian, Lithuanian
Cyrillic	Bulgarian, Macedonian, Russian, Ukrainian, Kazakh
Greek	Greek
Turkish	Turkish

NOTE

- Only the files saved in ASCII CODE is supported for the external subtitles of the movie.
- Only 500 alphabets and 500 numbers are supported for each line of the subtitle.
- Only 10,000 of sync blocks can be supported within the subtitle file.

TO USE A USB DEVICE

► When you select the **Set Video**,

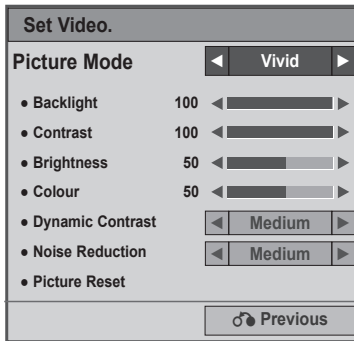

1

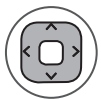

Make appropriate adjustments. (Refer to p. 74, 77, 78)

► When you select the **Set Audio**,

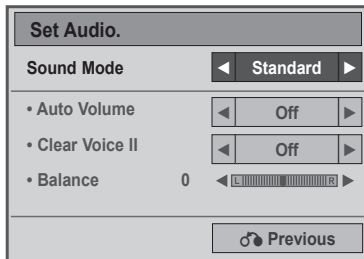

1





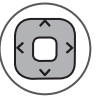

Show the **Sound Mode, Auto Volume, Clear Voice II, Balance**.

2



Make appropriate adjustments. (Refer to p. 85 to 89)

Using the remote control

	<p>When playing, repeatedly, press the REW(◀◀) button to speed up ◀◀(x2) → ◀◀◀ (x4) → ◀◀◀◀(x8) → ◀◀◀◀◀(x16) → ◀◀◀◀◀◀(x32) .</p> <p>repeatedly, press the FF(▶▶) button to speed up ▶▶(x2) → ▶▶▶ (x4) → ▶▶▶▶ (x8) → ▶▶▶▶▶(x16) → ▶▶▶▶▶▶(x32).</p> <ul style="list-style-type: none"> ■ Pressing these buttons repeatedly increases the fast forward/reverse speed.
	<p>During playback, press the Pause (II) button.</p> <ul style="list-style-type: none"> ■ Still screen is displayed. ■ If no buttons are pressed on the remote control for 10 minutes after pausing, the TV returns to the playback state. ■ Press the Pause (II) button and then use the FF (▶▶) button for slow motion.
	<p>When using the < or > button during playback a cursor indicating the position can be viewed on the screen.</p>
	<p>Press the Play(▶) button to return to normal playback.</p>
	<p>Press the ENERGY SAVING button repeatedly to increase the brightness of your screen. (Refer to p. 72)</p>





TO USE A USB DEVICE

DIVX REGISTRATION CODE

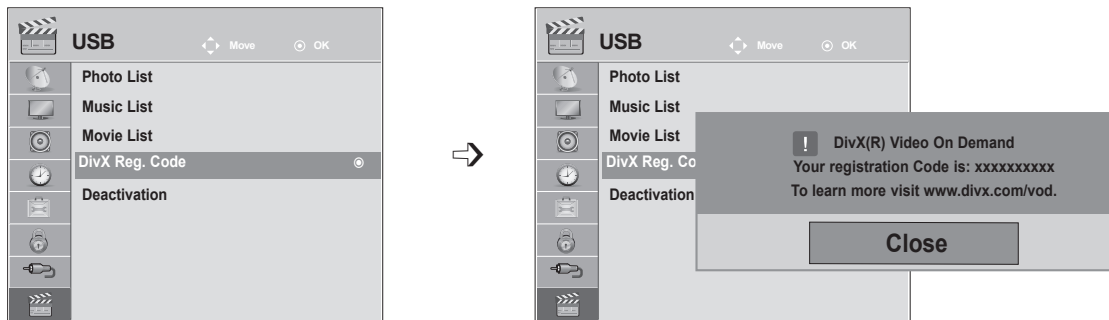
Confirm the DivX registration code number of the TV. Using the registration number, movies can be rented or purchased at www.divx.com/vod.

With a DivX registration code from other TV, playback of rented or purchased DivX file is not allowed. (Only DivX files matched with the registration code of the purchased TV are playable.)



- 1   Select **USB**.
- 2   Select **DivX Reg. Code**.
- 3  Display **DivX Reg. Code**.

- Press the **MENU** or **EXIT** button to close the menu window.
- Press the **BACK** button to move to the previous menu screen.

DIVX
HD

ABOUT DIVX VIDEO: DivX® is a digital video format created by DivX, Inc. This is an official DivX Certified device that plays DivX video. Visit www.divx.com for more information and software tools to convert your files into DivX video.

ABOUT DIVX VIDEO-ON-DEMAND: This DivX Certified® device must be registered in order to play DivX Video-on-Demand (VOD) content. To generate the registration code, locate the DivX VOD section in the device setup menu. Go to vod.divx.com with this code to complete the registration process and learn more about DivX VOD.

“DivX Certified® to play DivX® video up to HD 1080p, including premium content.”

“DivX®, DivX Certified® and associated logos are trademarks of DivX, Inc. and are used under license.”

“Pat. 7,295,673; 7,460,668; 7,515,710; 7,519,274”

! NOTE

- ▶ Movie files are supported as follows

Resolution: under 1920x1080 WxH pixels





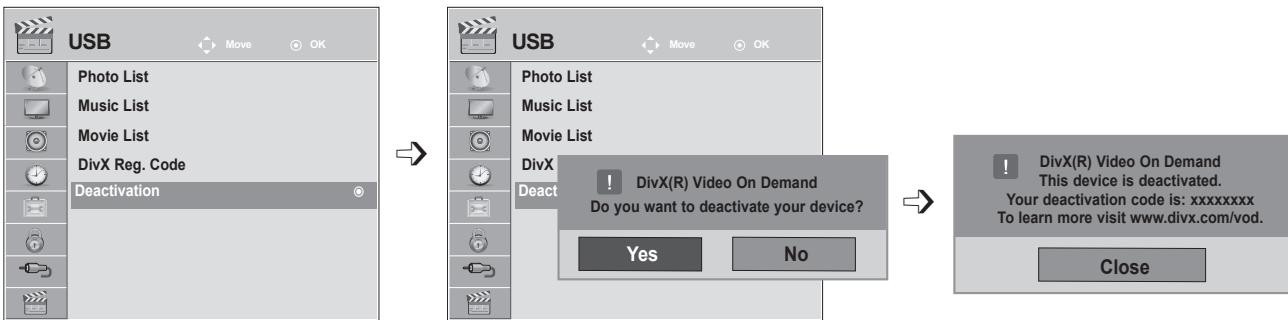

Frame rate: under 30 frames/sec(1920x1080), under 60 frames/sec(under 1280x720)

- ▶ **Video Codec:** MPEG 1, MPEG 2, MPEG 4, H.264/AVC, DivX 3.11, DivX 4.12, DivX 5.x, DivX 6, Xvid 1.00, Xvid 1.01, Xvid 1.02, Xvid 1.03, Xvid 1.10-beta1, Xvid 1.10-beta2

DEACTIVATION

The purpose of deactivation is to allow deactivation of devices for users who have activated all the available devices through the web server and are blocked from activating more devices. DivX VOD allowed the consumer to activate up to 6 devices under one account, but to replace or deactivate any of those devices, the consumer had to contact DivX Support and request deletion. Now with this added feature, consumers will be able to deactivate the device themselves and hence better manage their DivX VOD devices.



-   Select **USB**.
-   Select **Deactivation**.
-   Select **Yes**.
-  Display **Deactivation**.

- Press the **MENU** or **EXIT** button to close the menu window.
- Press the **BACK** button to move to the previous menu screen.

TELETEXT

This feature is not available in all countries.

Teletext is a free service broadcast by most **TV** stations which gives up-to-the-minute information on news, weather, television programmes, share prices and many other topics.

The teletext decoder of this **TV** can support the **SIMPLE**, **TOP** and **FASTTEXT** systems. **SIMPLE** (standard teletext) consists of a number of pages which are selected by directly entering the corresponding page number. **TOP** and **FASTTEXT** are more modern methods allowing quick and easy selection of teletext information.

SWITCH ON/OFF

Press the **TEXT** button to switch to teletext. The initial page or last page appears on the screen.

Two page numbers, **TV** station name, date and time are displayed on the screen headline. The first page number indicates your selection, while the second shows the current page displayed.

Press the **TEXT** or **EXIT** button to switch off teletext. The previous mode reappears.

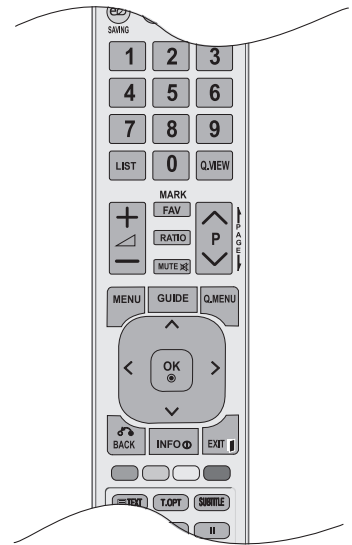

SIMPLE TEXT

■ Page selection

- 1 Enter the desired page number as a three-digit number with the NUMBER buttons. If during selection you press a wrong number, you must complete the three-digit number and then re-enter the correct page number.
- 2 The **P** ^ v button can be used to select the previous or next page.

TOP TEXT

The user guide displays four fields—red, green, yellow and blue at the bottom of the screen. The yellow field denotes the next group and the blue field indicates the next block.

■ Block / group / page selection

- 1 With the blue button you can progress from block to block.
- 2 Use the yellow button to proceed to the next group with automatic overflow to the next block.
- 3 With the green button you can proceed to the next existing page with automatic overflow to the next group. Alternatively, the **P** ^ button can be used.
- 4 The RED button permits you to return to previous selection. Alternatively, the **P** v button can be used.

■ Direct page selection

As with SIMPLE teletext mode, you can select a page by entering it as a three digit number using the NUMBER buttons in TOP mode.

FASTTEXT

The teletext pages are colour coded along the bottom of the screen and are selected by pressing the corresponding coloured button.

■ Page selection

- 1 Press the **T.OPT** button and then use $\wedge \vee$ button to select  menu. Display the index page.
- 2 You can select the pages which are colour coded along the bottom line with corresponding coloured buttons.
- 3 AS with SIMPLE teletext mode, you can select a page by entering its three digit page number with the NUMBER buttons in FASTTEXT mode.
- 4 The **P** $\wedge \vee$ button can be used to select the preceding or following page.

SPECIAL TELETEXT FUNCTION

- Press the **T. OPT** button and then use $\wedge \vee$ button to select the **Text Option** menu.

Index

Select the each index page.

Time

When viewing a TV programme, select this menu to display the time at the top right hand corner of the screen.

In the teletext mode, press this button to select a sub page number. The sub page number is displayed at the bottom of the screen. To hold or change the sub page, press the RED/GREEN, $< >$ or NUMBER buttons.

Hold

Stops the automatic page change which will occur if a teletext page consists of 2 or more sub pages. The number of sub pages and the sub page displayed is, usually, shown on the screen below the time. When this menu is selected the stop symbol is displayed at the top left-hand corner of the screen and the automatic page change is inactive.

Reveal

Select this menu to display concealed information, such as solutions to riddles or puzzles.

Update

Displays the TV picture on the screen while waiting for a new teletext page. The display will appear at the top left hand corner of the screen. When the updated page is available then display will change to the page number. Select this menu again to view the updated teletext page.

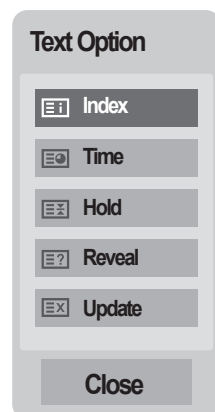

DIGITAL TELETEXT

***This function works in UK, Ireland only.**

The TV gives you access to digital teletext which is greatly improved in various aspects such as text, graphics etc.

This digital teletext can access special digital teletext services and specific services which broadcast digital teletext.

You should select off in the subtitle language menu to display teletext by pressing the **SUBTITLE** button.

TELETEXT WITHIN DIGITAL SERVICE

- 1 Press the numeric or **P** ^ v button to select a digital service which broadcasts digital teletext.
- 2 Follow the indications on digital teletext and move onto the next step by pressing **TEXT, OK, ^ v < >** , **RED, GREEN, YELLOW, BLUE** or **NUMBER** buttons and etc.
- 3 To change digital teletext service, select a different service by the numeric or **P** ^ v button.



TELETEXT IN DIGITAL SERVICE

- 1 Press the numeric or **P** ^ v button to select a certain service which broadcasts digital teletext.
- 2 Press the **TEXT** or coloured button to switch on teletext.
- 3 Follow the indications on digital teletext and move onto the next step by pressing **OK, ^ v < >** , **RED, GREEN, YELLOW, BLUE** or **NUMBER** buttons and so on.
- 4 Press the **TEXT** or colour button to switch off digital teletext and return to **TV** viewing.

Some services may allow you to access text services by pressing the **RED** button.



APPENDIX

TROUBLESHOOTING

The operation does not work normally.

The remote control doesn't work	<ul style="list-style-type: none">■ Check to see if there is any object between the product and the remote control causing obstruction. Ensure you are pointing the remote control directly at the set.■ Ensure that the batteries are installed with correct polarity (+ to +, - to -).■ Ensure that the correct remote operating mode is set: TV, VCR, etc.■ Install new batteries.
Power is suddenly turned off	<ul style="list-style-type: none">■ Is the sleep timer set?■ Check the power control settings. Power interrupted.■ If the TV is switched on and there is no input signal, it will switch off automatically after 15 minutes to save the power consumption.■ When a broken file was played in the USB mode, the TV may turn off. Please check the file in your usb storage.■ Except the screen off mode of the energy saving menu.

The video function does not work.

No picture & No sound	<ul style="list-style-type: none">■ Check whether the product is turned on.■ Try another channel. The problem may be with the broadcast.■ Is the power cord inserted into wall power outlet?■ Check your antenna direction and/or location.■ Test the wall power outlet, plug another product's power cord into the outlet where the product's power cord was plugged in.
Picture appears slowly after switching on	<ul style="list-style-type: none">■ This is normal, the image is muted during the product startup process. Please contact your service centre, if the picture has not appeared after five minutes.
No color, poor colour, or poor picture	<ul style="list-style-type: none">■ Adjust Colour in menu option.■ Keep a sufficient distance between the product and the VCR.■ Try another channel. The problem may be with the broadcast.■ Are the video cables installed properly?■ Activate any function to restore the brightness of the picture.
Horizontal / vertical bars or picture shaking	<ul style="list-style-type: none">■ Check for local interference such as an electrical appliance or power tool.

APPENDIX

The video function does not work.

Poor reception on some channels	<ul style="list-style-type: none"> ■ Station or cable product experiencing problems, tune to another station. ■ Station signal is weak, reorient antenna to receive weaker station. ■ Check for sources of possible interference.
Lines or streaks in pictures	<ul style="list-style-type: none"> ■ Check antenna (Change the direction of the antenna).
No picture when connecting HDMI	<ul style="list-style-type: none"> ■ Check that your HDMI cable is High Speed HDMI Cable. If the HDMI cables are not High Speed HDMI Cable, flickering or no screen display can result. Please use the High Speed HDMI Cable.

The audio function does not work.

Picture OK & No sound	<ul style="list-style-type: none"> ■ Press the  + or - button. ■ Sound muted? Press MUTE button. ■ Try another channel. The problem may be with the broadcast. ■ Are the audio cables installed properly?
No output from one of the speakers	<ul style="list-style-type: none"> ■ Adjust Balance in menu option.
Unusual sound from inside the product	<ul style="list-style-type: none"> ■ A change in ambient humidity or temperature may result in an unusual noise when the product is turned on or off and does not indicate a problem with the product.
No sound when connecting HDMI or USB	<ul style="list-style-type: none"> ■ Check HDMI cable is High Speed HDMI Cable. ■ Check USB cable over version 2.0. ■ If the sound is abnormal in the HDMI, check the audio format in your external equipments <ul style="list-style-type: none"> ▶ Audio Supported format : Dolby Digital, PCM

There is a problem with PICTURE settings.

When the user changes the picture settings, the TV automatically converts back to the initial settings after a certain period of time.

- It means that the TV is currently set to **Store Demo** mode. To switch to Home use mode you should do the followings:
From the TV Menu, choose **OPTION** → Choose **Mode Setting** → Choose **Home use**. Now, you have completed switching to the Home use mode.

Only PC mode applied

No image is displayed.

Power is on, power indicator is blue but the screen appears extremely dark.

- Adjust brightness and contrast again.

Does the 'Invalid format' message appear?

- The signal from the PC (Video card) is out of the vertical or horizontal frequency range of the product.
Adjust the frequency range by referring to the Specifications in this user's guide.

Does the 'Check signal cable' message appear?

- The signal cable between PC and product is not connected. Check the signal cable.
- Press the '**INPUT**' button in the remote control to check the input signal.

'Unknown Product' message appears when the product is connected.

Did you install the driver?

- Install the product driver, which is provided with the product, or download it from the web site. (<http://www.lg.com>)
- See if the plug & play function is supported by referring to the video card user's guide.

After-image appears on the product.

After-image appears when the product is turned off.

- If you use a fixed image for a long time, the pixels may be damaged quickly.
Use the screen saver function.

APPENDIX

Screen color is abnormal.

Screen has poor color resolution (16_colors).	<ul style="list-style-type: none"> ■ Set screen color resolution to more than 24 bits (true color) Select control Pane → Display → Settings → Color Table menu in Windows.
Screen color is unstable or mono color.	<ul style="list-style-type: none"> ■ Check the connection status of the signal cable.
Do back spots appear on the screen?	<ul style="list-style-type: none"> ■ Several pixels (red, green, white or black color) may appear on the screen, which can be attributable to the unique characteristics of the LCD panel. It is not a malfunction of the LCD.

The screen image looks abnormal.

Is the screen position wrong?	<ul style="list-style-type: none"> ■ Adjust the Position menu in OSD. ■ A See if the video card resolution and frequency are supported by the product. If the frequency is out of range, set to the recommended resolution in the Control Panel → Display → Setting menu.
Do thin lines appear on the background screen?	<ul style="list-style-type: none"> ■ Adjust the Clock menu in OSD.
Horizontal noise appears or the characters look blurred.	<ul style="list-style-type: none"> ■ Adjust the Phase menu in OSD.

MAINTENANCE

Early malfunctions can be prevented. Careful and regular cleaning can prolong the life of your new set.

Caution: Be sure to switch the power off and unplug the power cord before you begin any cleaning.

Cleaning the Screen

- 1 A good way to keep the dust off your screen for a while is to wet a soft cloth in a mixture of lukewarm water and a little fabric softener or dish washing detergent. Wring the cloth until it is almost dry, and then use it to wipe the screen.
- 2 Ensure there is no excess water on the screen. Allow any water or dampness to evaporate before switching on.

Cleaning the Cabinet

- To remove dirt or dust, wipe the cabinet with a soft, dry, lint-free cloth.
- Do not to use a wet cloth..

Extended Absence

WARNING

- ▶ If you expect to leave your TV dormant for prolonged periods (such as a holiday), unplug the power cord to protect against possible damage from lightning or power surges.

APPENDIX

PRODUCT SPECIFICATIONS

M2080D / M2080DF / M2080DB / M2080DN

LCD Panel	Screen Type	508.5 mm Wide (20.0 inch) TFT (Thin Film Transistor) LCD (Liquid Crystal Display) Panel Visible diagonal size: 508.5 mm
	Pixel Pitch	0.2766 mm (H) x 0.2766 mm (V)
Video Signal	Max. Resolution	1600 x 900 @ 60 Hz
	Recommended Resolution	1600 x 900 @ 60 Hz
	Horizontal Frequency	30 kHz to 65 kHz
	Vertical Frequency	56 Hz to 75 Hz
	Synchronization Type	Separate Sync, Digital
Input Connector		TV, D-Sub Analog, SCART, PC Audio In, component, HDMI*2, CVBS
Power	Rated Voltage	19 V \pm 2.0 A
	Power Consumption	On Mode 32 W (typ.) Off Mode \leq 1 W
AC/DC Adapter		Manufacturer: LITE-ON, Model PA-1650-68
Tilt	Tilt Range	-5° to 10°
Dimensions (Width x Height x Depth) Weight	M2080D	
	476.4 mm x 376.1 mm x 193.8 mm (18.75 inch x 14.81 inch x 7.62 inch) 3.5 kg (7.12 lb)	
	M2080DF	
	476.4 mm x 387.8 mm x 193.9 mm (18.75 inch x 15.26 inch x 7.63 inch) 3.7 kg (8.16 lb)	
	M2080DB	
	476.4 mm x 389.4 mm x 194.4 mm (18.75 inch x 15.33 inch x 7.65 inch) 3.5 kg (7.12 lb)	
M2080DN		
476.4 mm x 310.5 mm x 56.1 mm (18.75 inch x 12.22 inch x 2.21 inch) 2.7 kg (5.95 lb)		
Environmental conditions	Operating Temperature	10 °C to 35 °C
	Operating Humidity	20 % to 80 %
	Storage Temperature	-10 °C to 60 °C
	Storage Humidity	5 % to 90 %

■ The specifications shown above may be changed without prior notice for quality improvement.

M2280D / M2280DF / M2280DB / M2280DN

LCD Panel	Screen Type	546.86 mm Wide (21.53 inch) TFT (Thin Film Transistor) LCD (Liquid Crystal Display) Panel Visible diagonal size: 546.86 mm
	Pixel Pitch	0.248 mm (H) x 0.248 mm (V)
Video Signal	Max. Resolution	1920 x 1080 @ 60 Hz
	Recommended Resolution	1920 x 1080 @ 60 Hz
	Horizontal Frequency	30 kHz to 83 kHz
	Vertical Frequency	56 Hz to 75 Hz
	Synchronization Type	Separate Sync, Digital
Input Connector		TV, D-Sub Analog, SCART, PC Audio In, component, HDMI*2, CVBS
Power	Rated Voltage	19 V $\overline{\text{---}}$ 2.2 A
	Power Consumption	On Mode 35 W (typ.) Off Mode \leq 1 W
AC/DC Adapter		Manufacturer: LITE-ON, Model PA-1650-68
Tilt	Tilt Range	-5° to 10°
Dimensions (Width x Height x Depth) Weight	M2280D	
	509.6 mm x 396.2 mm x 193.8 mm (20.06 inch x 15.6 inch x 7.63 inch) 3.7 kg (8.16 lb)	
	M2280DF	
	509.6 mm x 407.3 mm x 193.9 mm (20.06 inch x 16.03 inch x 7.63 inch) 3.9 kg (8.6 lb)	
	M2280DB	
	509.6 mm x 409.6 mm x 194.4 mm (20.06 inch x 16.12 inch x 7.65 inch) 3.7 kg (8.16 lb)	
Environmental conditions	Operating Temperature	10 °C to 35 °C
	Operating Humidity	20 % to 80 %
	Storage Temperature	-10 °C to 60 °C
	Storage Humidity	5 % to 90 %

■ The specifications shown above may be changed without prior notice for quality improvement.

APPENDIX

M2380D / M2380DF/ M2380DB / M2380DN

LCD Panel	Screen Type	584.2 mm Wide (23 inch) TFT (Thin Film Transistor) LCD (Liquid Crystal Display) Panel Visible diagonal size: 584.2 mm	
	Pixel Pitch	0.265 mm (H) x 0.265 mm (V)	
Video Signal	Max. Resolution	1920 x 1080 @ 60 Hz	
	Recommended Resolution	1920 x 1080 @ 60 Hz	
	Horizontal Frequency	30 kHz to 83 kHz	
	Vertical Frequency	56 Hz to 75 Hz	
	Synchronization Type	Separate Sync, Digital	
Input Connector		TV, D-Sub Analog, SCART, PC Audio In, component, HDMI*2, CVBS	
Power	Rated Voltage	19 V $\overline{\text{---}}$ 2.4 A	
	Power Consumption	On Mode 40 W (typ.) Off Mode \leq 1 W	
AC/DC Adapter		Manufacturer: LITE-ON, Model PA-1650-68	
Tilt	Tilt Range	-5° to 10°	
Dimensions (Width x Height x Depth) Weight	M2380D		
	547 mm x 415.7 mm x 193.8 mm (21.53 inch x 16.37 inch x 7.63 inch) 4.2 kg (9.26 lb)		
	M2380DF		
	547 mm x 427.9 mm x 193.9 mm (21.53 inch x 16.85 inch x 7.6 inch) 4.4 kg (9.7 lb)		
	M2380DB		
	547 mm x 429.1 mm x 194.4 mm (21.53 inch x 16.89 inch x 7.65 inch) 4.2 kg (9.26 lb)		
M2380DN			
547 mm x 349.6 mm x 57.8 mm (21.53 inch x 13.76 inch x 2.27 inch) 3.4 kg (7.5 lb)			
Environmental conditions	Operating Temperature	10 °C to 35 °C	
	Operating Humidity	20 % to 80 %	
	Storage Temperature	-10 °C to 60 °C	
	Storage Humidity	5 % to 90 %	

■ The specifications shown above may be changed without prior notice for quality improvement.

M2780D / M2780DF / M2780DN

LCD Panel	Screen Type	685.8 mm Wide (27 inch) TFT (Thin Film Transistor) LCD (Liquid Crystal Display) Panel Visible diagonal size: 685.8 mm	
	Pixel Pitch	0.3114 mm (H) x 0.3114 mm (V)	
Video Signal	Max. Resolution	1920 x 1080 @ 60 Hz	
	Recommended Resolution	1920 x 1080 @ 60 Hz	
	Horizontal Frequency	30 kHz to 83 kHz	
	Vertical Frequency	56 Hz to 75 Hz	
	Synchronization Type	Separate Sync, Digital	
Input Connector		TV, D-Sub Analog, SCART, PC Audio In, component, HDMI*2, CVBS	
Power	Rated Voltage	19 V $\overline{\text{---}}$ 2.8 A	
	Power Consumption	On Mode 47 W (typ.) Off Mode \leq 1 W	
AC/DC Adapter		Manufacturer: LITE-ON, Model PA-1650-68	
Tilt	Tilt Range	-5° to 10°	
Dimensions (Width x Height x Depth) Weight	M2780D		
	644 mm x 480.6 mm x 222.8 mm (23.53 inch x 18.92 inch x 8.77 inch) 5.8 kg (12.79 lb)		
	M2780DF		
	644 mm x 493.6 mm x 221.7 mm (23.53 inch x 19.43 inch x 8.72 inch) 6.1 kg (13.45 lb)		
Environmental conditions	M2780DN		
	Operating Temperature	10 °C to 35 °C	
	Operating Humidity	20 % to 80 %	
	Storage Temperature	-10 °C to 60 °C	
	Storage Humidity	5 % to 90 %	

- The specifications shown above may be changed without prior notice for quality improvement.

APPENDIX

IR CODES

• This feature is not available for all models.

Code (Hexa)	Function	Note
95	Energy Saving	R/C BUTTON
08	POWER	R/C BUTTON (POWER ON/OFF)
50	TV / PC	R/C BUTTON
0B	INPUT	R/C BUTTON
79	RATIO	R/C BUTTON
F0	TV/RAD	R/C BUTTON
45	Q.MENU	R/C BUTTON
43	MENU	R/C BUTTON
AB	GUIDE	R/C BUTTON
40	Up (^)	R/C BUTTON
41	Down (v)	R/C BUTTON
07	Left (<)	R/C BUTTON
06	Right (>)	R/C BUTTON
44	OK(●)	R/C BUTTON
28	BACK	R/C BUTTON
5B	EXIT	R/C BUTTON
AA	INFO ⓘ	R/C BUTTON
02	▲ (+)	R/C BUTTON
03	▼ (-)	R/C BUTTON
1E	FAV (MARK)	R/C BUTTON
09	MUTE	R/C BUTTON
00	P (^)	R/C BUTTON
01	P (v)	R/C BUTTON
10 to 19	Number Key 0 to 9	R/C BUTTON
53	LIST	R/C BUTTON
1A	Q.VIEW	R/C BUTTON
72	RED Key	R/C BUTTON
71	GREEN Key	R/C BUTTON
63	YELLOW Key	R/C BUTTON
61	BLUE Key	R/C BUTTON
20	TEXT	R/C BUTTON
21	T.OPT (T.Option)	R/C BUTTON
39	SUBTITLE	R/C BUTTON
99	Auto Config.	R/C BUTTON
B1	■	R/C BUTTON
B0	▶	R/C BUTTON
BA		R/C BUTTON
8F	◀◀	R/C BUTTON
8E	▶▶	R/C BUTTON

EXTERNAL CONTROL DEVICE SETUP

RS-232C Setup

Connect the RS-232C (serial port) input jack to an external control device (such as a computer or an A/V control system) to control the product's functions externally.

Connect the serial port of the control device to the RS-232C jack on the product back panel.

Note: RS-232C connection cables are not supplied with the product.

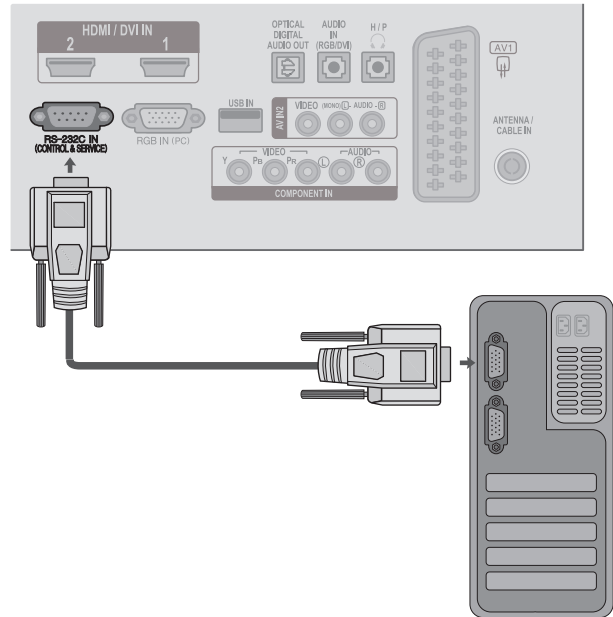

Type of Connector; D-Sub 9-Pin Male

No.	Pin Name
1	No connection
2	RXD (Receive data)
3	TXD (Transmit data)
4	DTR (DTE side ready)
5	GND
6	DSR (DCE side ready)
7	RTS (Ready to send)
8	CTS (Clear to send)
9	No Connection

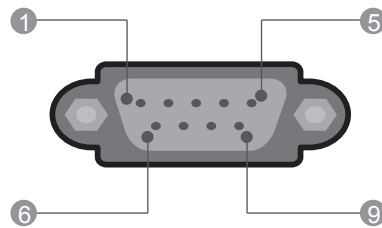

RS-232C Configurations

7-Wire Configurations (Standard RS-232C cable)

	PC	TV	
RXD	2	3	TXD
TXD	3	2	RXD
GND	5	5	GND
DTR	4	6	DSR
DSR	6	4	DTR
RTS	7	8	CTS
CTS	8	7	RTS

D-Sub 9 D-Sub 9

3-Wire Configurations (Not standard)

	PC	TV	
RXD	2	3	TXD
TXD	3	2	RXD
GND	5	5	GND
DTR	4	6	DTR
DSR	6	4	DSR
RTS	7	7	RTS
CTS	8	8	CTS





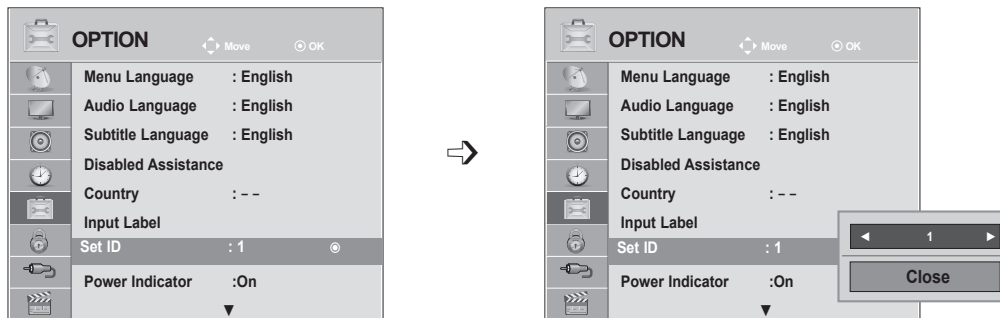

D-Sub 9 D-Sub 9

APPENDIX

Set ID

Use this function to specify a set ID number.
Refer to 'Real Data Mapping'. ► p.153



- 1   Select **OPTION**.
- 2    Select **Set ID**.
- 3   Adjust Set ID to choose the desired TV ID number.
The adjustment range of SET ID is 1 to 99.

- Press the **MENU** or **EXIT** button to close the menu window.
- Press the **BACK** button to move to the previous menu screen.

Communication Parameters

- Baud rate: 9600 bps (UART)
- Data length: 8 bits
- Parity : None
- Stop bit: 1 bit
- Communication code: ASCII code
- Use a crossed (reverse) cable.

Command Reference List

	COMMAND 1	COMMAND 2	DATA (Hexadecimal)
01. Power	k	a	00 to 01
02. Aspect Ratio	k	c	Refer to p. 150
03. Screen Mute	k	d	00 to 01
04. Volume Mute	k	e	00 to 01
05. Volume Control	k	f	00 to 64
06. Contrast	k	g	00 to 64
07. Brightness	k	h	00 to 64
08. Colour	k	i	00 to 64
09. Tint	k	j	00 to 64
10. Sharpness	k	k	00 to 64
11. OSD Select	k	l	00 to 01
12. Remote control lock mode	k	m	00 to 01
13. Treble	k	r	00 to 64
14. Bass	k	s	00 to 64
15. Balance	k	t	00 to 64
16. Colour Temperature	x	u	00 to 64
17. Energy Saving	j	q	00 to 05
18. Auto Configuration	j	u	01
19. Tune Command	m	a	Refer to p. 152
20. Programme Add/Skip	m	b	00 to 01
21. Key	m	c	Key Code
22. Back Light	m	g	00 to 64
23. Input select (Main)	x	b	Refer to p. 153

* When setting the 17 to 24, a menu does not appear on screen.

* Note : During USB operations such as Dvix or EMF, all commands except Power(ka) and Key(mc) are not executed and treated as NG.

Transmission / Receiving Protocol

Transmission

[Command1][Command2][][Set ID][][Data][Cr]

- * [Command 1] : First command to control the TV.
(j, k, m or x)
- * [Command 2] : Second command to control the TV.
- * [Set ID] : You can adjust the set ID to choose desired monitor ID number in option menu. Adjustment range is 1 to 99. When selecting Set ID '0', every connected set is controlled. Set ID is indicated as decimal (1 to 99) on menu and as Hexa decimal (0x0 to 0x63) on transmission/receiving protocol.
- * [DATA] : To transmit command data. Transmit 'FF' data to read status of command.
- * [Cr] : Carriage Return
ASCII code '0x0D'
- * [] : ASCII code 'space (0x20)'

OK Acknowledgement

[Command2][][Set ID][][OK][Data][x]

- * The set transmits ACK (acknowledgement) based on this format when receiving normal data. At this time, if the data is data read mode, it indicates present status data. If the data is data write mode, it returns the data of the PC computer.

Error Acknowledgement

[Command2][][Set ID][][NG][Data][x]

- * The set transmits ACK (acknowledgement) based on this format when receiving abnormal data from non-viable functions or communication errors.

Data 00: Illegal Code

APPENDIX

01. Power (Command: k a)

► To control Power On/Off of the set.

Transmission

```
[k][a][ ][Set ID][ ][Data][Cr]
```

Data 00 : Power Off 01 : Power On

Ack

```
[a][ ][Set ID][ ][OK/NG][Data][x]
```

► To show Power On/Off.

Transmission

```
[k][a][ ][Set ID][ ][FF][Cr]
```

Ack

```
[a][ ][Set ID][ ][OK/NG][Data][x]
```

- * Similarly, if other functions transmit '0xFF' data based on this format, Acknowledgement data feed back presents status about each function.
- * OK Ack., Error Ack. and other message may display on the screen when TV is power On.

02. Aspect Ratio (Command: k c) (Main Picture Size)

► To adjust the screen format. (Main picture format)
You can also adjust the screen format using the **Aspect Ratio** in the Q.MENU. or PICTURE menu.

Transmission

```
[k][c][ ][Set ID][ ][Data][Cr]
```

Data 01 : Normal screen (4:3) 07 : 14:9
02 : Wide screen (16:9) 09 : Just Scan
04 : Zoom 0B : Full Wide
06 : Original 10to 1F: Cinema Zoom 1 to 16

Ack

```
[c][ ][Set ID][ ][OK/NG][Data][x]
```

- * Using the PC input, you select either 16:9 or 4:3 screen aspect ratio.
- * In DTV/HDMI (1080i 50 Hz / 60 Hz, 720p 50 Hz / 60 Hz, 1080p 24 Hz / 30 Hz / 50 Hz / 60 Hz), Component(720p, 1080i, 1080p 50 Hz / 60 Hz) mode, Just Scan is available.
- * **Full Wide** is supported only for Analogue, AV1, 2.

03. Screen Mute (Command: k d)

► To select screen mute on/off.

Transmission

```
[k][d][ ][Set ID][ ][Data][Cr]
```

Data 00 : Screen mute off (Picture on)
Video mute off
01 : Screen mute on (Picture off)
10 : Video mute on

Ack

```
[d][ ][Set ID][ ][OK/NG][Data][x]
```

- * In case of video mute on only, TV will display On Screen Display(OSD). But, in case of Screen mute on, TV will not display OSD.

04. Volume Mute (Command: k e)

► To control volume mute on/off.
You can also adjust mute using the MUTE button on remote control.

Transmission

```
[k][e][ ][Set ID][ ][Data][Cr]
```

Data 00 : Volume mute on (Volume off)
01 : Volume mute off (Volume on)

Ack

```
[e][ ][Set ID][ ][OK/NG][Data][x]
```

05. Volume Control (Command: k f)

► To adjust volume.
You can also adjust volume with the VOLUME buttons on remote control.

Transmission

```
[k][f][ ][Set ID][ ][Data][Cr]
```

Data Min : 00 to Max : 64

- * Refer to 'Real data mapping 1'. See page 153.

Ack

```
[f][ ][Set ID][ ][OK/NG][Data][x]
```

06. Contrast (Command: k g)

► To adjust screen contrast.
You can also adjust contrast in the PICTURE menu.

Transmission

```
[k][g][ ][Set ID][ ][Data][Cr]
```

Data Min : 00 to Max : 64

- * Refer to 'Real data mapping 1'. See page 153.

Ack

```
[g][ ][Set ID][ ][OK/NG][Data][x]
```

07. Brightness (Command: k h)

- ▶ To adjust screen brightness.
You can also adjust brightness in the PICTURE menu.

Transmission

[k][h][][Set ID][][Data][Cr]

Data Min : 00 to Max : 64

* Refer to 'Real data mapping 1'. See page 153.

Ack

[h][][Set ID][][OK/NG][Data][x]

08. Colour (Command: k i)

- ▶ To adjust the screen colour. (Except PC mode)
You can also adjust colour in the PICTURE menu.

Transmission

[k][i][][Set ID][][Data][Cr]

Data Min : 00 to Max : 64

* Refer to 'Real data mapping 1'. See page 153.

Ack

[i][][Set ID][][OK/NG][Data][x]

09. Tint (Command: k j)

- ▶ To adjust the screen tint. (Except PC mode)
You can also adjust tint in the PICTURE menu.

Transmission

[k][j][][Set ID][][Data][Cr]

Data Red : 00 to Green : 64

* Refer to 'Real data mapping 1'. See page 153.

Ack

[j][][Set ID][][OK/NG][Data][x]

10. Sharpness (Command: k k)

- ▶ To adjust the screen sharpness.
You can also adjust sharpness in the PICTURE menu.

Transmission

[k][k][][Set ID][][Data][Cr]

Data Min : 00 to Max : 64

* Refer to 'Real data mapping 1'. See page 153.

Ack

[k][][Set ID][][OK/NG][Data][x]

11. OSD Select (Command: k l)

- ▶ To select OSD (On Screen Display) on/off when controlling remotely.

Transmission

[k][l][][Set ID][][Data][Cr]

Data 00 : OSD off 01 : OSD on

Ack

[l][][Set ID][][OK/NG][Data][x]

12. Remote control lock mode (Command: k m)

- ▶ To lock the front panel controls on the monitor and remote control.

Transmission

[k][m][][Set ID][][Data][Cr]

Data 00 : Lock off 01 : Lock on

Ack

[m][][Set ID][][OK/NG][Data][x]

- * If you are not using the remote control, use this mode.
When main power is on/off, external control lock is released.
- * Local Power Key will work properly.

13. Treble (Command: k r)

- ▶ To adjust treble.
You can also adjust treble in the AUDIO menu.

Transmission

[k][r][][Set ID][][Data][Cr]

Data Min : 00 to Max : 64

* Refer to 'Real data mapping 1'. See page 153.

Ack

[r][][Set ID][][OK/NG][Data][x]

14. Bass (Command: k s)

- ▶ To adjust bass.
You can also adjust bass in the AUDIO menu.

Transmission

[k][s][][Set ID][][Data][Cr]

Data Min : 00 to Max : 64

* Refer to 'Real data mapping 1'. See page 153.

Ack

[s][][Set ID][][OK/NG][Data][x]

APPENDIX

15. Balance (Command: k t)

- ▶ To adjust balance.
You can also adjust balance in the AUDIO menu.

Transmission

[k][t][][Set ID][][Data][Cr]

Data Min : 00 to Max : 64

* Refer to 'Real data mapping 1'. See page 153.

Ack

[t][][Set ID][][OK/NG][Data][x]

16. Colour Temperature (Command: x u)

- ▶ To adjust colour temperature. You can also adjust Colour Temperature in the PICTURE menu.

Transmission

[x][u][][Set ID][][Data][Cr]

Data Min : 00 to Max : 64

* Refer to 'Real data mapping 1'. See page 153.

Ack

[u][][Set ID][][OK/NG][Data][x]

17. Energy Saving (Command: j q)

- ▶ To reduce the power consumption of the TV. You can also adjust Energy Saving in OPTION menu.

Transmission

[j][q][][Set ID][][Data][Cr]

Power Saving Function					Level				Description
7	6	5	4		3	2	1	0	
0	0	0	0	Low Power	0	0	0	0	Off
0	0	0	0	Low Power	0	0	0	1	Minimum
0	0	0	0	Low Power	0	0	1	0	Medium
0	0	0	0	Low Power	0	0	1	1	Maximum
0	0	0	0	Low Power	0	1	0	1	Screen Off

Ack

[q][][Set ID][][OK/NG][Data][x]

18. Auto Configure(Command: j u)

- ▶ To adjust picture position and minimize image shaking automatically. It works only in RGB (PC) mode.

Transmission

[j][u][][Set ID][][Data][Cr]

Data 01: To set

Ack

[u][][Set ID][][OK/NG][Data][x]

19. Tune Command (Command: m a)

- ▶ Select channel to following physical number.

Transmission

[m][a][][Set ID][][Data0][][Data1][][Data2][Cr]

Data00 : High channel data

Data01 : Low channel data

ex. No. 47 -> 00 2F (2FH)

No. 394 -> 01 8A (18AH),

DTV No. 0 -> Don't care

Data02 : 0x00 : Analogue Main

0x10 : DTV Main

0x20 : Radio

Channel data range

Analogue - Min: 00 to Max: 63 (0 to 99)

Digital - Min: 00 to Max: 3E7 (0 to 999)

(Except For Sweden, Finland, Norway, Denmark, Ireland)

Digital - Min: 00 to Max: 270F (0 to 9999)

(Only Sweden, Finland, Norway, Denmark, Ireland)

Ack

[a][][Set ID][][OK/NG][Data][x]

Data Min: 00 to Max: 7DH

20. Programme Add/Skip(Command: m b)

► To set skip status for the current Programme.

Transmission

```
[m][b][ ][Set ID][ ][Data][Cr]
Data 00 : Skip      01 : Add
```

Ack

```
[b][ ][Set ID][ ][OK/NG][Data][x]
```

* Real data mapping 1	
00 : Step 0	Tint
:	Step 0 : R50
A : Step 10 (Set ID 10)	:
:	Step 49 : R1
F : Step 15 (Set ID 15)	Step 50 : 0
10 : Step 16 (Set ID 16)	Step 51 : G1
:	:
64 : Step 100	Step 100 : G50
:	
6E : Step 110	Balance
:	Step 0 : L50
73 : Step 115	:
74 : Step 116	Step 49 : L1
:	Step 50 : 0
CF : Step 199	Step 51 : R1
:	:
FE : Step 254	Step 100 : R50
FF : Step 255	
	Colour Temperature
	Step 0 : W50
	:
	Step 49 : W1
	Step 50 : 0
	Step 51 : C1
	:
	Step 100 : C50

21. Key(Command: m c)

► To send IR remote key code.

Transmission

```
[m][c][ ][Set ID][ ][Data][Cr]
Data Key code - Refer to page 148.
```

Ack

```
[c][ ][Set ID][ ][OK/NG][Data][x]
```

22. Back Light (Command: m g)

► To Control the back light.

Transmission

```
[m][g][ ][Set ID][ ][Data][Cr]
Data : data Min: 00 to Max: 64
```

Ack

```
[g][ ][Set ID][ ][OK/NG][Data][x]
```

23. Input select (Command: x b) (Main Picture Input)

► To select input source for main picture.

Transmission

```
[x][b][ ][Set ID][ ][Data][Cr]
Data Structure
```

```
Data 00: DTV      40: Component
      10: Analogue 60: RGB
      20: AV       90: HDMI
```

Ack

```
[b][ ][Set ID][ ][OK/NG][Data][x]
```

When does switchover happen?

*Copeland switches on October 17, 2007



The exact date you switch depends on the transmitter you are served by. To check when you switch, go to Digital UK's postcode checker on www.digitaluk.co.uk

Check your ITV news service or look at Teletext page 106 to see what TV region you're in.

Visit us at digitaluk.co.uk call us on 0845 6 50 50 50†

†Calls charged at BT rate of 3p per minute daytime and 1p per minute evenings and weekends. Rates may vary for calls from non-BT lines.

Keep this important information about how to re-tune your TV during the digital TV switchover

Keep this leaflet and your instruction manual safe – you'll need them

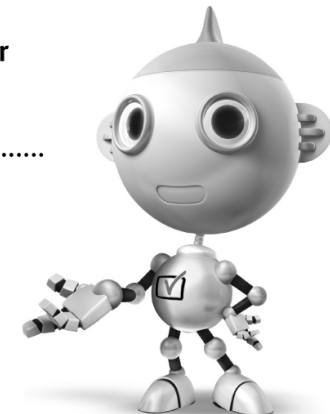

get set for digital 

Television in the UK is going digital, bringing us all more choice and new services. Starting in late 2007 and ending in 2012, television services in the UK will go completely digital, TV region by TV region.

Please see overleaf to find out when your area switches to digital.

Digital UK is the independent, non-profit organisation leading the process of digital TV switchover in the UK. Digital UK provides impartial information on what people need to do to prepare for the move to digital, and when they need to do it.

How the switchover affects your TV equipment:

Your new TV has a digital tuner built in, which means it is ready to receive the Freeview signal by simply plugging it into your aerial socket (check if you can get digital TV through your aerial now, or whether you'll have to wait until switchover, at www.digitaluk.co.uk).

When the TV switchover happens in your area, there are at least two occasions when you will need to re-tune your TV in order to continue receiving your existing TV channels, and also to pick up new ones. Digital UK, the body leading the digital TV switchover, will advise you when you need to re-tune during the switchover.

If you choose to connect your TV to satellite or cable with a digital box then it will not be affected by switchover, and you won't need to re-tune.

How to re-tune:

To find out how to re-tune your TV, check your manufacturer's instructions for details. Or see below for a typical sequence:

1. With your TV in digital TV mode, press 'Menu' on your remote control. (Some TVs will ask you for a code. If you have not already changed it, the default code is usually 0000, or check your instruction book.)
2. From the Menu options on screen, select 'SETUP'. Select 'Auto Tuning'* to re-tune your digital TV (not 'add channels'). You may have to wait a couple of minutes for the re-tune to complete.

*Also sometimes referred to as 'Update', 'Rescan', 'Replace', 'Auto-Tuning', 'Channel Search', 'First Time Install', or 'Store Channels'.

3. If you do not re-tune your channels when advised to do so by Digital UK, you may lose some or all of your channels until you do re-tune. You should re-tune your TV every few months to check for any new channels.

If you are missing any channels, it may be that they are not available in your area, or that your aerial needs upgrading.

If you have any questions, please contact your equipment supplier or call Digital UK on **0845 6 50 50 50** or visit www.digitaluk.co.uk



Make sure to read the Safety Precautions before using the product.
Keep the Owner's Manual (CD) in an accessible place for future reference.
The model and serial number of the SET is located on the back and one side of the SET.
Record it below should you ever need service.

MODEL _____

SERIAL _____