

Portable DVD Player



Owner's Manual

Model: DP181

Before connecting, operating or adjusting this product, please read this instruction booklet carefully and completely.

P/No.: MFL30593038

Safety Precautions



CAUTION
RISK OF ELECTRIC SHOCK
DO NOT OPEN



CAUTION: TO REDUCE THE RISK OF ELECTRIC SHOCK
DO NOT REMOVE COVER (OR BACK)
NO USER-SERVICEABLE PARTS INSIDE
REFER SERVICING TO QUALIFIED SERVICE PERSONNEL.



This lightning flash with arrowhead symbol within an equilateral triangle is intended to alert the user to the presence of uninsulated dangerous voltage within the product's enclosure that may be of sufficient magnitude to constitute a risk of electric shock to persons.



The exclamation point within an equilateral triangle is intended to alert the user to the presence of important operating and maintenance (servicing) instructions in the literature accompanying the product.

WARNING: TO PREVENT FIRE OR ELECTRIC SHOCK
HAZARD, DO NOT EXPOSE THIS PRODUCT TO RAIN
OR MOISTURE.

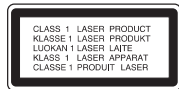

CAUTION: Do not block any ventilation openings. Install in accordance with the manufacturer's instructions.

Slots and openings in the cabinet are provided for ventilation and to ensure reliable operation of the product and to protect it from over heating. The openings should be never be blocked by placing the product on a bed, sofa, rug or other similar surface. This product should not be placed in a built-in installation such as a bookcase or rack unless proper ventilation is provided or the manufacturer's instruction have been adhered to.

CAUTION: VISIBLE AND INVISIBLE LASER RADIATION WHEN OPEN AND INTERLOCKS DEFEATED.

CAUTION:

This product employs a Laser System.

To ensure proper use of this product, please read this owner's manual carefully and retain it for future reference. Should the unit require maintenance, contact an authorized service center.

Use of controls, adjustments or the performance of procedures other than those specified herein may result in hazardous radiation exposure.

To prevent direct exposure to laser beam, do not try to open the enclosure. Visible laser radiation when open. **DO NOT STARE INTO BEAM.**

CAUTION: The apparatus should not be exposed to water (dripping or splashing) and no objects filled with liquids, such as vases, should be placed on the apparatus.

NOTES ON COPYRIGHTS:

It is forbidden by law to copy, broadcast, show, broadcast via cable, play in public, or rent copyrighted material without permission.

This product features the copy protection function developed by Macrovision. Copy protection signals are recorded on some discs. When recording and playing the pictures of these discs on a VCR, picture noise will appear.

This product incorporates copyright protection technology that is protected by method claims of certain U.S. patents and other intellectual property rights owned by Macrovision Corporation and other rights owners. Use of this copyright protection technology must be authorized by Macrovision Corporation, and is intended for home and other limited viewing uses only unless otherwise authorized by Macrovision Corporation. Reverse engineering or disassembly is prohibited.

Safety Precautions (Continued)

CAUTION concerning the Power Cord

Most appliances recommend they be placed upon a dedicated circuit;

That is, a single outlet circuit which powers only that appliance and has no additional outlets or branch circuits. Check the specification page of this owner's manual to be certain.

Do not overload wall outlets. Overloaded wall outlets, loose or damaged wall outlets, extension cords, frayed power cords, or damaged or cracked wire insulation are dangerous. Any of these conditions could result in electric shock or fire. Periodically examine the cord of your appliance, and if its appearance indicates damage or deterioration, unplug it, discontinue use of the appliance, and have the cord replaced with an exact replacement part by an authorized servicer.

Protect the power cord from physical or mechanical abuse, such as being twisted, kinked, pinched, closed in a door, or walked upon. Pay particular attention to plugs, wall outlets, and the point where the cord exits the appliance.

To disconnect power from the mains, pull out the mains cord plug. When installing the product, ensure that the plug is easily accessible.



This product is manufactured to comply with the radio interference requirements of EEC DIRECTIVE 89/336/EEC, 93/68/EEC and 73/23/EEC.



1. When this crossed-out wheeled bin symbol is attached to a product it means the product is covered by the European Directive 2002/96/EC.
2. All electrical and electronic products should be disposed of separately from the municipal waste stream via designated collection facilities appointed by the government or the local authorities.
3. The correct disposal of your old appliance will help prevent potential negative consequences for the environment and human health.
4. For more detailed information about disposal of your old appliance, please contact your city office, waste disposal service or the shop where you purchased the product.

Table of Contents

Introduction

Safety Precautions	2-3
Table of Contents	4
Before Use	5-7
About the  Symbol Display	5
Symbol used in this Manual	5
Notes on Discs	5
Maintenance and Service	6
Types of Playable Discs	7
Identification of Controls	8-11
Main Unit	8-9
Remote Control	10-11
Power Connections	12-15
AC Adapter	12
Automotive Adapter	13
Battery Pack	14-15
Rotate the LCD	16
Playing a Disc	17

Advanced Operations

Displaying Disc Information on-screen	18
Initial Settings	18-23
General Operation	18
LANGUAGE	19
DISPLAY	19
AUDIO	20
LOCK (Parental Control)	21-22
OTHERS	23
General Features	24-26
Additional Features	27

Playing an Audio CD or MP3/WMA file	28
Programmed Playback	29
Erasing a Track from Program List	29
Viewing a JPEG file	30-31
Slide Show	30
Still Picture	30
Moving to another File	30
Zoom	30
To rotate picture	30
JPEG file compatibility with this player is limited as follows	31
Playing a DVD VR format Disc	32
Playing a DivX Movie file	33-34
DivX file compatibility with this player is limited as follows	34
Playing an USB	35

Connections

Setting up the Player	36-37
DVD Player Connections	36
Audio Connection to Optional Equipment	37

Reference

Troubleshooting	38
Language Code	39
Area Codes	40
Specifications	41

Before Use

To ensure proper use of this product, please read this owner's manual carefully and retain for future reference.

This manual provides information on the operation and maintenance of your DVD player. Should the unit require service, contact an authorized service location.

About the Symbol Display

" " may appear on your LCD display during operation and indicates that the function explained in this owner's manual is not available on that specific DVD video disc.







Symbol Used in this Manual

NOTE

Indicates special notes and operating features.

TIP

Indicates tips and hints for making the task easier. A section whose title has one of the following symbols is applicable only to the disc represented by the symbol.

- | | |
|---|--|
|  ALL All discs and files listed below |  MP3 MP3 files. |
|  DVD DVD and finalized DVD±R/RW |  DivX DivX files |
|  VCD Video CDs. | |
|  CD Audio CDs. | |
|  WMA WMA files. | |

Notes on Discs

Handling Discs

Do not touch the playback side of the disc. Hold the disc by the edges so that fingerprints do not get on the surface. Never stick paper or tape on the disc.

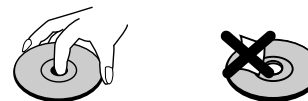

Storing Discs

After playing, store the disc in its case. Do not expose the disc to direct sunlight or sources of heat and never leave it in a parked car exposed to direct sunlight.

Cleaning Discs

Fingerprints and dust on the disc can cause poor picture quality and sound distortion. Before playing, clean the disc with a clean cloth. Wipe the disc from the center out.

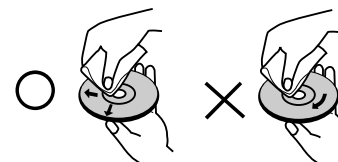

Do not use strong solvents such as alcohol, benzene, thinner, commercially available cleaners, or anti-static spray intended for older vinyl records.

Before Use (Continued)

Maintenance and Service

Refer to the information in this chapter before contacting a service technician.

Handling the Unit

When shipping the unit

Please save the original shipping carton and packing materials. If you need to ship the unit, for maximum protection, re-pack the unit as it was originally packed at the factory.

Keeping the exterior surfaces clean

- Do not use volatile liquids such as insecticide spray near the unit.
- Do not leave rubber or plastic products in contact with the unit for a long period of time. since they leave marks on the surface.

Cleaning the unit

To clean the player, use a soft, dry cloth. If the surfaces are extremely dirty, use a soft cloth lightly moistened with a mild detergent solution.

Do not use strong solvents such as alcohol, benzine, or thinner, as these might damage the surface of the unit.

Maintaining the Unit



The DVD player is a high-tech, precision device. If the optical pick-up lens and disc drive parts are dirty or worn, the picture quality could be diminished.

Depending on the operating environment, regular inspection and maintenance are recommended after every 1,000 hours of use.

For details, please contact your nearest authorized service center.

Before Use (Continued)

Types of Playable Discs

	DVD (8 cm / 12 cm disc)
	Video CD (VCD) (8 cm / 12 cm disc)
	Audio CD (8 cm / 12 cm disc)

In addition, this unit plays DivX file, DVD±R, DVD±RW, SVCD, and CD-R or CD-RW that contains audio titles, MP3, WMA or JPEG files.



This indicates a product feature that is capable of playing DVD-RW discs recorded with Video Recording format.

NOTES

- Depending on the conditions of the recording equipment or the CD-R/RW (or DVD±R/±RW) disc itself, some CD-R/RW (or DVD±R/±RW) discs cannot be played on the unit.
- Do not attach any seal or label to either side (the labeled side or the recorded side) of a disc.
- Do not use irregularly shaped CDs (e.g., heart-shaped or octagonal). It may result in malfunctions.

Customers should note that permission is required in order to download MP3 / WMA files and music from the Internet. Our company has no right to grant such permission. Permission should always be sought from the copyright owner.

Regional Code

This unit has a regional code printed on the rear of the unit. This unit can play only DVD discs labelled same as the rear of the unit or "ALL".

Notes on Regional Codes

- Most DVD discs have a globe with one or more numbers in it clearly visible on the cover. This number must match your unit's regional code or the disc cannot play.
- If you try to play a DVD with a different regional code from your player, the message "Check Regional Code" appears on the TV screen.

Manufactured under license from Dolby Laboratories. "Dolby", "Pro Logic", and the double-D symbol are trademarks of Dolby Laboratories.

DTS and DTS Digital Out are trademarks of Digital Theater Systems, Inc.

Identification of Controls

Main Unit

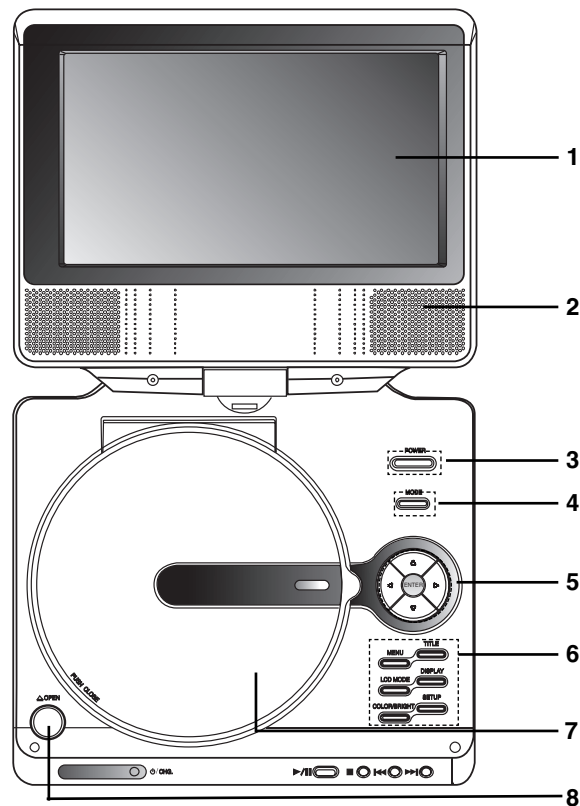

1. **LCD screen**
2. **Speaker**
3. **Power** : Switches the player ON or OFF.
4. **MODE** : Selects the source.
5. **◀ ▶ ▲ ▼ (left/right/up/down)**
 - Selects an item in the menu.
 - ◀ ▶ : Adjusts the COLOR/BRIGHT.
 - ENTER : Confirms menu selection.
6. **COLOR/BRIGHT** : Selects the mode of LCD adjustment
Brightness → Color → OFF
 - **SETUP** : Accesses or removes setup menu.
 - **TITLE** : Displays title menu, if available.
 - **MENU** : Accesses menu on a DVD disc.
 - **DISPLAY** : Accesses On-Screen display.
 - **LCD MODE** : NORMAL → FULL → ZOOM → OFF
7. **Disc Lid**
8. **OPEN button** : Push this button to open the Disc lid.

NOTE

Place a disc with the playback side down on the spindle, and push gently on the center of the disc so it goes into position.

Identification of Controls (continued)

Main Unit

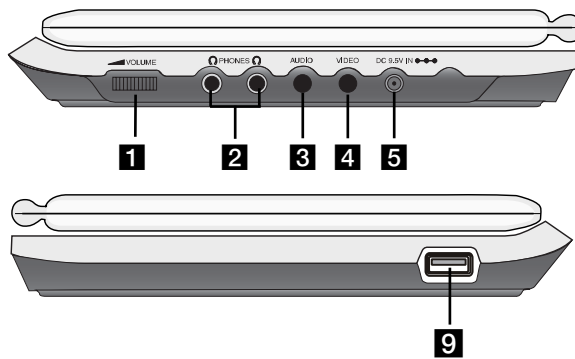

- 1** Volume Control
- 2** Earphone jack
- 3** AUDIO In/Out jack (OPTICAL OUT)
- 4** VIDEO In/Out jack

NOTE

If the VIDEO IN signal is not connected in AV IN mode, this unit will automatically power off in 10 minutes to prevent battery discharge.

- 5** DC 9.5V IN
Connect the AC adapter or Automotive adapter.

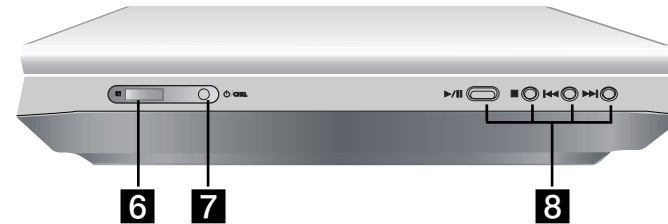

- 6** Remote sensor
Receive the signal from the Remote Control for operation.
- 7** Battery charge indicator
During recharging, charge indicator is red. If recharging is complete, charge indicator changes to green colour.
- 8** • **PLAY (▶/||)**: Starts playback/ Pauses playback temporarily.
• **STOP (■)**: Stops playback.
• **Reverse SKIP/SEARCH (◀◀)**
Search backward*/ go to beginning of current chapter or track or go to previous chapter or track.
• **Forward SKIP/SEARCH (▶▶)**
Search forward*/ go to next chapter or track.
* Press and hold button for about two seconds.
- 9** **USB**: Connect a USB device..

Identification of Controls (continued)

Remote Control

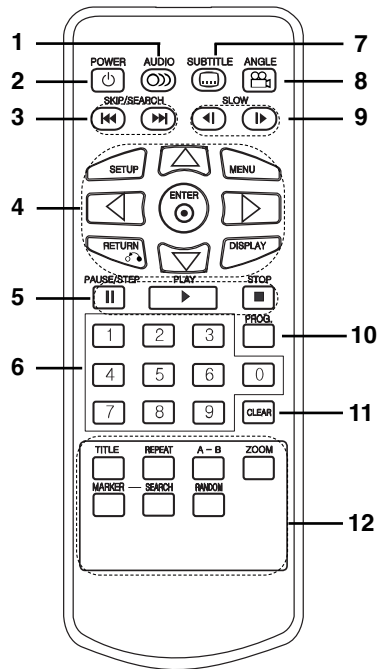

1. **AUDIO**
Selects an audio language (DVD).
2. **POWER**
Switches DVD Player ON or OFF.
3.
 - **Reverse SKIP/SEARCH (◀◀)**
Search backward*/ go to beginning of current chapter or track or go to previous chapter or track.
 - **Forward SKIP/SEARCH (▶▶)**
Search forward*/ go to next chapter or track.

* Press and hold button for about two seconds.
4.
 - **SETUP**
Accesses or removes setup menu.
 - **MENU**
Accesses menu on a DVD disc.
 - **RETURN**
Displays the video CD with PBC.
 - **DISPLAY**
Accesses On-Screen display.
 - **◀ ▶ ▲ ▼ (left/right/up/down)**
Selects an item in the menu.
 - **ENTER**
Confirms menu selection.
5.
 - **PAUSE / STEP**
Pauses playback temporarily/ press repeatedly for frame-by-frame playback.
 - **PLAY**
Starts playback.
 - **STOP (■)**
Stops playback.
6. **0-9 number buttons**
Selects numbered items in a menu.
7. **SUBTITLE**
Selects a subtitle language.
8. **ANGLE**
Selects a DVD camera angle, if available.
9. **SLOW (◀◀ / ▶▶)**
Reverse/ Forward slow playback.
10. **PROG.**
Places a track on the program list.
11. **CLEAR**
Removes a track number on the program list or a mark on the MARKER SEARCH menu.
12.
 - **A-B**
Repeat sequence.
 - **ZOOM**
Enlarges video image.
 - **TITLE**
Displays title menu, if available.
 - **MARKER**
Marks any point during playback.
 - **SEARCH**
Displays MARKER SEARCH menu.
 - **REPEAT**
Repeat chapter, track, title all.
 - **RANDOM**
Plays tracks in random order.

Identification of Controls (continued)

Insert the battery (Lithium battery)

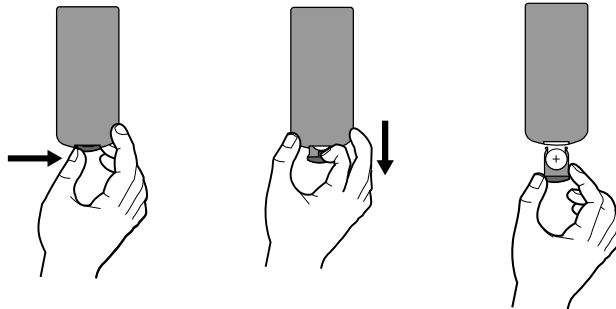

NOTES

- Do not expose the remote control sensor to bright light.
- Do not place obstacles between the remote control sensor and the remote control.

■ Replacing the button-type battery

The battery normally lasts for about a year. Replace the battery if the remote control fails to operate the unit when used within the operation range.

Button-type battery (Lithium battery)

1. Pinch the battery holder clip together then pull the tab to remove the battery holder.
2. Insert the battery with the + facing in the same direction as the + on the battery holder.
3. Replace the battery holder with battery into the remote control unit making sure that it is fully inserted.

NOTES

- Replace remote control unit battery with 3V micro lithium cells such as CR. 2025 or its equivalent.
- Dispose of battery safely in accordance with local laws. Do not dispose of in fire.

Warning : The battery used in this device may present a fire or chemical burn hazard if mistreated. Do not recharge, disassemble, incinerate, or heat above 100 °C (212 °F). Replace the battery with Matsushita Elec. Ind. Co., Ltd. (Panasonic), part no. CR. 2025 only. Use of another battery may present a risk of fire or explosion. Dispose of used batteries. Keep batteries away from children. Do not disassemble or dispose of in fire.

Power Connections

AC Adapter

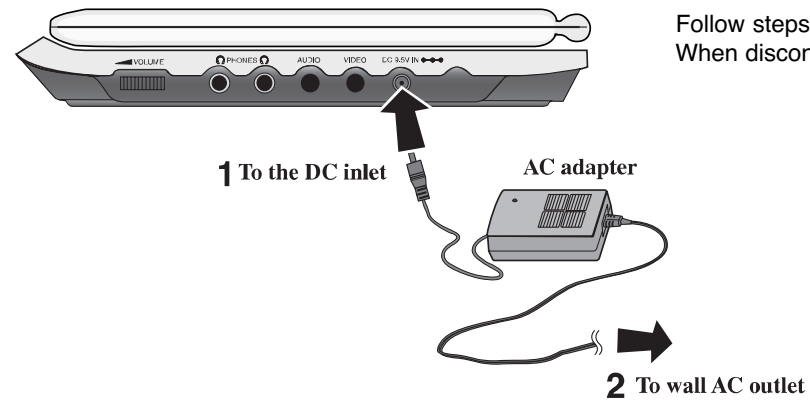

Follow steps 1 to 2 to connect.
When disconnecting, reverse the order.

Caution

- Do not connect the power plug to a power outlet other than that indicated on the label, as this can result in a risk of fire or electric shock.
- Do not connect or disconnect the power plug with wet hands. Doing so may cause electric shock.
- Do not use an AC adapter other than one specified, as it can cause a fire or damage to the player.

AC adapter

- This AC adapter operates on 100-240V~ 1.5A 50-60Hz.
- MODEL NO. : DPAC1T
- Manufactured by WANLIDA Digital Technology Co., Ltd.
- Contact an electrical parts distributor for assistance in selecting a suitable AC plug adapter or AC cord set.

Power Connections (continued)

Automotive Adapter

This DVD player and its automotive adapter are designed for use in vehicles that have 12 volt, negative ground electrical systems. (This is standard for most vehicles.) If your vehicle has a different type of electrical system, the DC power system cannot be used.

Follow steps 1 to 2 to connect.
When disconnecting, reverse the order.

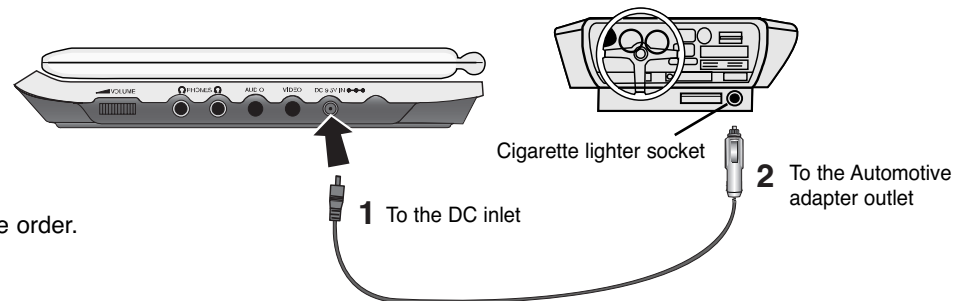

Caution

- To prevent electrical shock and possible damage to your DVD player or vehicle, always unplug the automotive adapter from the cigarette lighter socket before you remove the plug from your DVD player.
- A 3 amp, 250V fuse for protection is installed in the automotive adapter.
- While the engine is being started, disconnect the automotive adapter from the car's cigarette lighter socket.
- Do not operate your DVD player when the car battery is discharged. Peak current from the car generator may cause the DC fuse to blow.
- If the vehicle's supply voltage drops below approximately 10 volts, your DVD player may not work properly.
- Do not leave your DVD player in a place where the temperature exceeds 70°C (158°F), or the pick-up device may be damaged.
Examples include:
 - Inside a car with the windows closed and in direct sunshine.
 - Near a heating appliance.

Automotive adapter

- This automotive adapter operates on DC 12V.
- MODEL NO. : DPDC1
- Manufactured by WANLIDA Digital Technology Co., Ltd.
- Contact an electrical parts distributor for assistance in selecting a suitable automotive adapter.

Power Connections (continued)

Battery Pack

Charge the battery pack before using it for the first time.

■ Attaching the battery pack

1. Match the hooks of the battery pack into the holes on the bottom of the player.
2. Press and slide the battery pack until the hooks click.

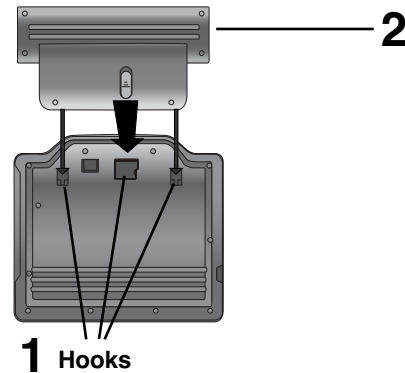

NOTES

- Do not detach the battery pack during playback.
- Be careful not to drop the battery pack.

■ Detaching the battery pack

1. Press the RELEASE knob.
2. Pull the battery pack until the hooks click.

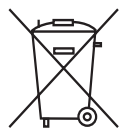
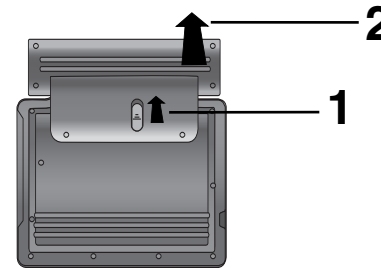

ATTENTION

The product that you have purchased contains a rechargeable battery. The battery is recyclable. At the end of its useful life, under various state and local laws, it may be illegal to dispose of this battery into the municipal waste stream. Check with your local solid waste/officials for details in your area for recycling options or proper disposal.

Power Connections (continued)

■ Charging the battery pack

1. Attach the battery pack to the player.
2. Connect the AC power adapter to the player and the plug into an AC outlet.

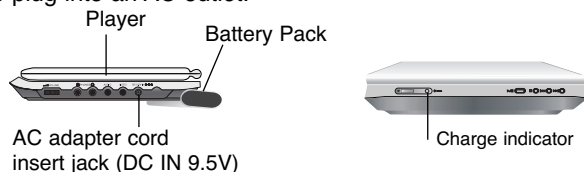

3. During recharging, charge indicator is red. If recharging is complete, charge indicator changes to green color.

CAUTION

Take the following precautions to avoid liquid leakage, overheating, etc.

- Do not use any unauthorized parts.
- Use the authorized AC adapter when recharging battery.
- Do not expose to high temperature above 60°C (140°F).
- Do not attempt to dismantle or modify the unit.
- Excessive impact may cause the unit to malfunction.
- Do not incinerate.
- Do not disassemble; dispose of properly.
- Do not short-circuit.

NOTE

Charging a battery only happens when the power is off. The battery will not be charged when it is naturally or purposely discharged. Because the unit cannot perceive battery voltage, even if you attached the battery. When you are in this situation, power on the unit and then power off again. Then battery charge will proceed.

■ Recharging and play times

Recharging	Play time	
	LCD On	LCD Off
Standby	Approx. 3.5 hours*	Approx. 4 hours
Approx. 3 hour		

* When Brightness control is set to initial mode.

■ Press “Display” to display the battery status on the screen.

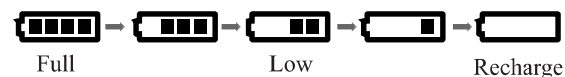

If using the AC adapter, battery display does not appear.

This unit power is off automatically after the “Check Battery” displayed on the screen.

■ If play time dramatically reduces after recharging

The battery pack has reached the end of its service life (it can be recharged about 300 times).

■ If the unit is not used for a long time

Detach the battery pack. (Even if the unit is off, it still uses some power. This can lead to over discharging of the battery and malfunction.) Recharge the battery pack when you are ready to use it again.

■ Battery Pack

MODEL NO. : DPSB135

Rotating the LCD

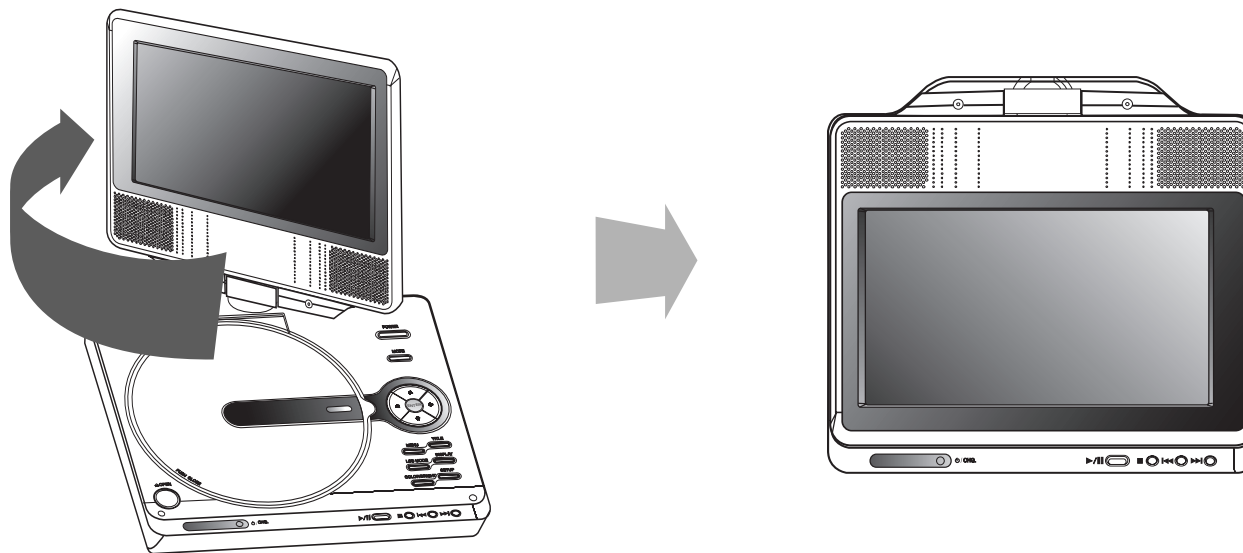

You can rotate LCD clockwise an angle of 180 degrees. However, if you turn it by force, it can cause serious damage.

After rotating LCD completely, you can fold the LCD screen as shown above.

Playing a Disc

1. Prepare the power supply.
2. Open the outer cover and press **POWER** button.
3. Press **OPEN** to open the disc lid and insert a disc with the side you want to play label up. Close the disc lid by hand.
 - If the disc is placed in upside down (and it is a single-sided disc), "NO DISC" or "DISC ERROR" appears on the screen.
 - After playing back all of the chapters in the title, the DVD player automatically stops and returns to the menu screen.
4. Press **PLAY** to start play.
5. Adjust the volume.

NOTES

- Place a disc with the playback side down on the spindle, and push gently on the center of the disc so it goes into position.
- Confirm LCD MODE position by pressing LCD MODE button.

■ Changing the size of the picture

Use the LCD MODE button to change the picture mode. The mode is shown on the unit's display as follows.

NORMAL → FULL → ZOOM → OFF
↑

NOTE

May appear to differ according to kind of disc.

■ The picture mode and size

The picture shown on the LCD depends on the display mode and the size recorded on the disc.

NOTES

- If you are not using the LCD on this unit, select OFF to conserve power.
- The LCD is turned off if you close the unit.
- Horizontal lines may appear in the picture when the mode is switched to ZOOM, but this is not an indication of a malfunction.

On-Screen Display

Displaying Disc Information on-screen

You can display various information about the disc loaded on-screen.

1. Press DISPLAY to show various playback information. The items displayed differ depending on the disc type or playing status.
2. You can select an item by pressing ◀ / ▶ and change or select the setting by pressing ▲ / ▼.
 - Title (Track) – Current title (or track) number/total number of titles (or tracks)
 - Chapter – Current chapter number/total number of chapters
 - Time – Elapsed playing time
 - Audio - Select the Audio (VCD disc only)

NOTE:

If no button is pressed for a few seconds, the on-screen display disappears.

Initial Settings

By using the Setup menu, you can make various adjustments to items such as picture and sound. You can also set a language for the subtitles and the Setup menu, among other things. For details on each Setup menu item, see pages 19 to 23.

To display and exit the Menu :

Press SETUP to display the menu. A second press of SETUP will take you back to initial screen.

To go to the next level :

Press ▶ on the remote control.

To go back to the previous level :

Press ◀ on the remote control.

General Operation

1. Press SETUP. The Setup menu appears.
2. Use ◀ / ▶ to select the desired option then press ▼ to move to the second level. The screen shows the current setting for the selected item, as well as alternate setting(s).
3. Use ▲ / ▼ to select the second desired option then press ▶ to move to the third level.
4. Use ▲ / ▼ to select the desired setting then press ENTER to confirm your selection. Some items require additional steps.
5. Press SETUP to exit the Setup menu.

Initial Settings

LANGUAGE

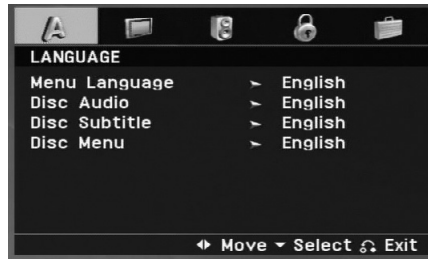

Menu Language

Select a language for the Setup menu and on-screen display.

Disc Audio / Subtitle / Menu

Select the language you prefer to the audio track (disc audio), subtitles, and the disc menu.

Original: Refers to the original language in which the disc was recorded.

Other: To select another language, press number buttons then ENTER to enter the corresponding 4-digit number according to the language code list in the reference chapter. If you enter the wrong language code, press CLEAR.

DISPLAY



TV Aspect

4:3: Select when a standard 4:3 TV is connected.

16:9 Wide: Select when a 16:9 wide TV is connected.

Display Mode

Display Mode setting works only when the TV Aspect mode is set to "4:3".

LetterBox: Displays a wide picture with bands on the upper and lower portions of the screen.

Panscan: Automatically displays the wide picture on the entire screen and cuts off the portions that do not fit.

Initial Settings (continued)

AUDIO

Each DVD disc has a variety of audio output options. Set the player's AUDIO options according to the type of audio system you use.



Dolby Digital / DTS / MPEG

Bitstream: Select "Bitstream" if you connect the DVD Player's DIGITAL OUT jack to an amplifier or other equipment with a Dolby Digital, DTS or MPEG decoder.

PCM (for Dolby Digital / MPEG): Select when connected to a two-channel digital stereo amplifier. DVDs encoded in Dolby Digital or MPEG will be automatically downmixed to two-channel PCM audio.

Off (for DTS): If you select "Off", the DTS signal is not output through the DIGITAL OUT jack.

Sample Freq (Frequency)

If your receiver or amplifier is NOT capable of handling 96 kHz signals, select 48 kHz. When this choice is made, this unit automatically converts any 96 kHz signals to 48 kHz so your system can decode them.

If your receiver or amplifier is capable of handling 96 kHz signals, select 96 kHz. When this choice is made, this unit passes each type of signal through without any further processing.

Check the documentation for your amplifier to verify its capabilities.

Dynamic Range Control (DRC)

With the DVD format, you can hear a program's soundtrack in the most accurate and realistic presentation possible, thanks to digital audio technology. However, you may wish to compress the dynamic range of the audio output (the difference between the loudest sounds and the quietest ones). This allows you to listen to a movie at a lower volume without losing clarity of sound. Set DRC to On for this effect.

Initial Settings (continued)

LOCK (Parental Control)

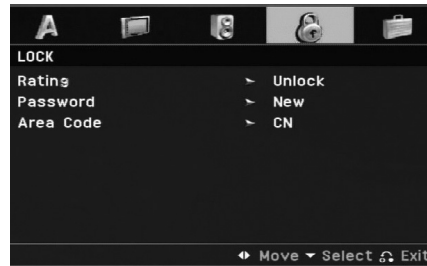

Rating

Blocks playback of rated DVDs based on their content. Not all discs are rated.

1. Select "Rating" on the LOCK menu then press ►.
2. To access the Rating, Password and Area Code features, you must input the 4-digit security code you created. If you have not yet entered a security code you are prompted to do so. Input a 4-digit code and press ENTER. Enter it again and press ENTER to verify. If you make a mistake before pressing ENTER, press CLEAR.

3. Select a rating from 1 to 8 using the ▲ / ▼ buttons.

Rating 1-8: Rating one (1) has the most restrictions and rating eight (8) is the least restrictive.

Unlock

If you select unlock, parental control is not active and the disc plays in full.

NOTE

If you set a rating for the player, all disc scenes with the same rating or lower are played. Higher rated scenes are not played unless an alternate scene is available on the disc. The alternative must have the same rating or a lower one. If no suitable alternative is found, playback stops. You must enter the 4-digit password or change the rating level in order to play the disc.

4. Press ENTER to confirm your rating selection, then press SETUP to exit the menu.

Initial Settings (continued)

Password

You can enter or change password.

1. Select Password on the LOCK menu then press ►.
2. **To make a new password:**
Press ENTER when the "New" option is highlighted. Enter a new password using the numbered buttons then press ENTER. Enter the password again to verify.
To change the password:
Press ENTER when the "Change" option is highlighted. Enter a current password using the numbered buttons then press ENTER. Enter a new password using the numbered buttons then press ENTER. Enter the password again to verify.
3. Press SETUP to exit the menu.

If you forget your Security Code

If you forget your security code you can clear it using the following steps:

1. Press SETUP to display the Setup menu.
2. Select the LOCK menu using ◀ / ▶ buttons.
3. Input the 6-digit number "210499" and the security code is cleared.
4. Enter a new code as described above.

Area Code

Enter the code of the area whose standards were used to rate the DVD video disc, based on the list in the reference chapter.

1. Select "Area Code" on the LOCK menu then press ►.
2. Follow step 2 as shown previous page (Rating).
3. Select the first character using ▲ / ▼ buttons.
4. Press ENTER (or ►) and select the second character using ▲ / ▼ buttons.
5. Press ENTER to confirm your area code selection.

Initial Settings (continued)

OTHERS

The PBC, Auto Play and DivX(R) VOD settings can be changed.



PBC

Set Playback Control (PBC) to On or Off.

On: Video CDs with PBC are played according to the PBC.

Off: Video CDs with PBC are played the same way as Audio CDs.

Auto Play

You can set up the DVD Player so a DVD disc automatically starts playing whenever the DVD is inserted.

If Auto Play mode is set to On, this DVD player will search for title that has the longest playback time and then play back the title automatically.

NOTE

The Auto Play function may not work for some DVDs.

DivX(R) VOD

We provide you the DivX® VOD (Video On Demand) registration code that allows you to rent and purchase videos using the DivX® VOD service. For more information, visit www.divx.com/vod.

1. Select "DivX(R) VOD" option then press ►.
2. Press ENTER while "Select" is selected and the registration code will appear.
Use the registration code to purchase or rent the videos from DivX® VOD service at www.divx.com/vod. Follow the instructions and download the video onto a disc for playback on this unit.
3. Press ENTER to exit.

NOTE

All the downloaded videos from DivX® VOD can only be played back on this unit.

General Features

DVD

Use the ◀▶▲▼ buttons to select the title/chapter you want to view, then press ENTER to start. Press TITLE or MENU to return to the menu screen.

VCD

Use the number buttons to select the track you want to view and press RETURN to return to the menu screen. Menu settings and operating procedures may differ. Follow the instructions on the each menu screen. You also may set PBC to Off (See "PBC" on page 23).

NOTE

If parental control is set and the disc is not within the rating settings you must input the password.
(See "Lock Menu" on page 21-22.)

Unless stated otherwise, all operations described use the remote control. Some features may also be available on the Setup menu.

Moving to another TITLE **DVD**

When a disc has more than one title, you can move to another title. Press DISPLAY while playback is stopped then the appropriate number (0-9) or use ◀/▶ to move to another title. You can play any title by inputting its number while playback is stopped.

Moving to another CHAPTER/TRACK **ALL**

During playback, press SKIP (◀◀ or ▶▶) to go to the next chapter/track or to return to the beginning of the current chapter/track.

Press SKIP ◀◀ twice briefly to step back to the previous chapter/track.

Search **ALL**

1. Press and hold SKIP/SEARCH ◀◀ or ▶▶ for about two seconds during playback.
The player will now go into SEARCH mode.
2. Press and hold SKIP/SEARCH ◀◀ or ▶▶ repeatedly to select the required speed.
DVD, DivX disc : 4 steps
Video CD, MP3, WMA, Audio CD : 3 steps
3. To exit SEARCH mode, press PLAY.

Slow Motion **DVD** **VCD** **DivX**

1. Press SLOW ◀| or |▶ during playback.
The player will enter SLOW mode.
DVD disc: 4 steps
DivX disc : 4 steps (forward only)
Video CD : 3 steps (forward only)
2. To exit slow motion mode, press PLAY.

General Features (Continued)

Still Picture and Frame-by-Frame Playback

ALL

During playback, press PAUSE/STEP to pause playback.

DVD VCD DivX

Press PAUSE/STEP repeatedly to play Frame-by-Frame.
(Remote control Only)

To exit still motion mode, press PLAY.

Time Search **DVD VCD DivX**

To start playing at any chosen time on the disc:

1. Press DISPLAY during playback. The time search box shows the elapsed playing time.
2. Press ◀ / ▶ to select the time clock icon and “-:--:--” appears.
3. Input the required start time in hours, minutes, and seconds from left to right. If you enter the wrong numbers, press CLEAR to remove the numbers you entered. Then input the correct numbers.
4. Press ENTER to confirm. Playback starts from the selected time.

Repeat A-B **DVD VCD DivX ACD**

During playback, each press of A-B button to select point A and point B and repeats a sequence from point A (Starting point) to point B (End point).

Press A-B again to cancel.

Repeat **ALL VCD1.1**

During playback, press REPEAT repeatedly to select a desired repeat mode.

DVD Video Discs : Chapter/Title/Off

Video CDs, Audio CD discs : TRACK(TRK)/All/Off

DivX/MP3/WMA files : TRACK(TRK)/DIR/All/Off

NOTE

If you press SKIP (▶▶) once during Repeat Chapter (Track) playback, the repeat playback cancels.

Zoom **DVD VCD DivX**

During watching pictures, press ZOOM to enlarge the video image (4 steps).

You can move through the zoomed picture using ◀ ▶ ▲ ▼ buttons. Press CLEAR to exit.

NOTES

- Zoom may not work on some DVDs.
- Screen fit mode is available for playing the DVD disc, VR disc and movie file.

Resume Play **ALL**

When play is stopped, the unit records the point where STOP was pressed (RESUME function).

Press PLAY and play will resume from this point.

General Features (Continued)

Title Menu **DVD**

If the current DVD title has a menu, the title menu appears on the screen. Otherwise, the disc menu may appear.

Disc Menu **DVD**

Press MENU and the disc menu is displayed. Press MENU again to exit.

Changing the Audio Language **DVD** **DivX**

Press AUDIO repeatedly during playback to hear a different audio language or audio track.

With DVD-RW discs recorded in VR mode that have both a main and a Bilingual audio channel, you can switch between Main (L), Bilingual (R), or a mix of both (Main + Bilingual) by pressing AUDIO.

VCD

Press AUDIO repeatedly during playback to hear a different audio channel (STEREO, LEFT, or RIGHT).

Camera Angle **DVD**

During playback of DVD disc contains scenes recorded different camera angles, press ANGLE repeatedly to select a desired angle.

TIP

The angle indicator will blink on the screen during scenes recorded at different angles as an indication that angle switching is possible.

Subtitles **DVD** **DivX**

Press SUBTITLE repeatedly during playback to see the different subtitle languages.

NOTE

If there is no information or there is a code that can not read in the DivX file, " 1 " etc are displayed.

Additional features

Marker Search **DVD** **DivX** **VCD**

To enter a Marker

You can start playback from up to nine memorized points. To enter a marker, press MARKER at the desired point on the disc. The Marker icon appears on the TV screen briefly. Repeat to enter up to nine markers.

To Recall or Clear a Marked Scene

1. During disc playback, press SEARCH. The marker search menu appears on the screen.
2. Within 10 seconds, press ◀ / ▶ to select a marker number that you want to recall or clear.
3. Press ENTER and playback starts from the marked scene. Or, Press CLEAR and the marker number is erased from the list.
4. You can play any marker by inputting its number on the marker search menu.

NOTES

- These operations work only with discs for which the elapsed playing time appears in the display window during playback or stop.
- Some subtitles recorded around the marker may fail to appear (DVD).
- All the markers are cleared when the power is turned off or the disc is removed.
- The marker is not stored when the DVD or title menu is displayed on the screen.

Last Scene Memory **DVD** **ACD** **VCD1.1**

This player memorizes last scene from the last disc that is viewed. The last scene remains in memory even if you remove the disc from the player or switch off the player. If you load a disc that has the scene memorized, the scene is automatically recalled.

NOTE

This player does not memorize the scene of a disc if you switch off the player before commencing to play the disc.

Screen Saver

The screen saver appears when you leave the DVD player in Stop mode for about five minutes. If the Screen Saver is displayed for five minutes, the DVD Player automatically turns itself off.

Playing an Audio CD or MP3/WMA file

The DVD player can play MP3/WMA formatted recordings on CD-ROM, CD-R, or CD-RW discs.

MP3/ WMA/ Audio CD

Once you insert an MP3/WMA files recorded media or Audio CD, a menu appears on the TV screen.

Press ▲ / ▼ to select a track/file then press PLAY or ENTER and playback starts. You can use variable playback functions. Refer to page 24-25.



ID3 TAG (MP3/WMA)

- When playing a file containing information such as track titles, you can see the information by pressing TITLE.
[Song, Artist, Album, Year]
- If there is no information, “NO ID3 TAG” appears on the display.

TIPS

- If you are in a file list on the MUSIC menu and want to return to the Folder list, use the ▲ / ▼ to highlight  and press ENTER or MENU.
- Press ► to move to the next page.
Press ◀ to move to the previous page.
- On a CD with MP3/WMA and JPEG you can switch MP3/WMA and JPEG.
Press ▲ / ▼ to select a folder, and press ENTER to see the folder contents.

MP3 / WMA file compatibility with this player is limited as follows:

- Sampling frequency: within 8 - 48 kHz (MP3),
within 32 - 48kHz (WMA)
- Bit rate: within 8 - 320kbps (MP3),
32 - 192kbps (WMA)
- The player cannot read an MP3/WMA file that has a file extension other than “.mp3” / “.wma”.
- CD-R physical format should be ISO 9660
- If you record MP3 / WMA files using software that cannot create a file system (eg. Direct-CD) it is impossible to playback MP3 / WMA files. We recommend that you use Easy-CD Creator, which creates an ISO 9660 file system.
- File names should have a maximum of 8 letters and must incorporate an .mp3 or .wma extension.
- They should not contain special letters such as / ? * : “ < > | etc.
- The total number of files in a folder should be less than 4500 files.
- This DVD player requires discs and recordings to meet certain technical standards in order to achieve optimal playback quality. Pre-recorded DVDs are automatically set to these standards. There are many different types of recordable disc formats (including CD-R containing MP3 or WMA files) and these require certain pre-existing conditions (see above) to ensure compatible playback.

Programmed Playback

The program function enables you to store your favorite tracks from any disc in the player memory.

A program can contain 30 tracks.

1. Insert a disc. (Audio CD, MP3 or WMA.)
2. Press ▲ / ▼ to select the desired file.
3. Press PROG. during playback or in the stop mode.
Repeat press PROG. to place additional tracks on the program list.
4. Press DISPLAY. Program List menu appear.
Press ▲ / ▼ to select the track you want to start playing.
Press ► to move to the next page.
Press ◀ to move to the previous page.



Audio CD Menu



MP3/WMA Menu

Erasing a Track from program list

1. Use ▲ / ▼ to select the track that you wish to erase from the program list.
2. Press CLEAR. Repeat to erase additional tracks on the list.

For details on each operation item, refer to relevant page.(See pages 24-25)

NOTE:

The programs are also cleared when the power is off or the disc is removed.

5. Press PLAY or ENTER to start.
6. To resume normal playback from programmed playback.
Press DISPLAY then select a track of list and then press PLAY or ENTER.

Viewing a JPEG file

Using this DVD Player you can view discs with JPEG files.

1. Insert a JPEG files recorded media. The Photo menu appears on the TV screen.

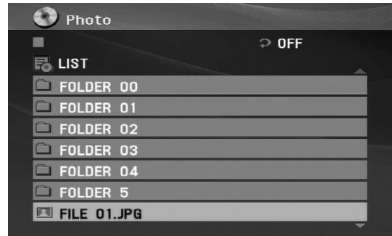

2. Press ▲ / ▼ to select a folder, and press ENTER. A list of files in the folder appears. If you are in a file list and want to return to the previous Folder list, use the ▲ / ▼ buttons on the remote to highlight  and press ENTER or MENU.
3. If you want to view a particular file, press ▲ / ▼ to highlight a file and press ENTER or PLAY.
While viewing a file, you can press STOP to move to the previous menu (Photo menu).

TIPS

- Press ► to move to the next page.
Press ◀ to move to the previous page.
- On a CD with MP3/WMA and JPEG you can switch MP3/WMA and JPEG.
Press ▲ / ▼ to select a folder, and press ENTER to see the folder contents.
- while watching a picture, press RETURN to hide the help menu.

Slide Show

If you want to view a slide show, to select a file in the folder then press ENTER.

Still Picture

1. Press PAUSE/STEP during slide show.
The player will now go into PAUSE mode.
2. To return to the slide show, press PLAY, ENTER or press PAUSE/STEP again.

Moving to another File

Press SKIP/SEARCH or cursor (◀ or ▶) once while viewing a picture to advance to the next or previous file.

Zoom

During watching pictures, press ZOOM to enlarge the video image (3 steps).

You can move through the zoomed picture using ◀ ▶ ▲ ▼ buttons.

To rotate picture

Press ▲ / ▼ during showing a picture to rotate the picture clockwise or counterclockwise.

Viewing a JPEG file (continued)

JPEG file compatibility with this player is limited as follows:

- Depending upon the size and number of JPEG files, it could take a long time for the DVD player to read the disc's contents. If you don't see an on-screen display after several minutes, some of the files may be too large — reduce the resolution of the JPEG files to less than 2M pixels as 2760 x 2048 pixels and burn another disc.
- The total number of files in a folder should be less than 4500 files.
- Some discs may be incompatible due to a different recording format or the condition of disc.
- Ensure that all the selected files have the “.jpg” extensions when copying into the CD layout.
- If the files have “.jpe” or “.jpeg” extensions, please rename them as “.jpg” file.
- File names without “.jpg” extension will not be able to be read by this DVD player. Even though the files are shown as JPEG image files in Windows Explorer.

Playing a DVD VR format Disc

This unit will play DVD-RW discs recorded using the Video Recording (VR) format.

1. Insert a disc and close the tray. The DVD-VR menu appears on the screen.



2. Press ▲ / ▼ to select a track then press PLAY or ENTER and playback starts.
3. Press MENU to move to the list menu.

NOTES

- Unfinalized DVD-R/RW discs cannot be played in this player.
- Some DVD-VR disc are made with CPRM data by DVD RECORDER. Player does not support these kinds of discs and display the "CHECK DISC".

What is 'CPRM'?

CPRM is a copy protection system (with scramble system) only allowing the recording of 'copy once' broadcast programs. CPRM stands for Content Protection for Recordable Media.

Playing a DivX Movie file

Using this DVD Player you can play DivX file.

1. Insert a DivX file recorded media. The Movie menu appears on the screen.



2. Press ▲ / ▼ to select a folder, and press ENTER. A list of files in the folder appears. If you are in a file list and want to return to the Folder list, use the ▲ / ▼ buttons on the remote to highlight  and press ENTER.
3. If you want to view a particular file, press ▲ / ▼ to highlight a file and press ENTER or PLAY. You can use variable playback functions. Refer to page 24-25.
4. Press STOP to stop the playback. The Movie menu appears.

Notice for displaying the DivX subtitle

If the subtitle does not display properly during playback, press and hold SUBTITLE about 3 seconds then press ▲ / ▼ to select another language code until the subtitle is displayed properly.

TIPS

- Press ► to move to the next page.
- On a CD with MP3/WMA and JPEG you can switch MP3/WMA and JPEG. Press ▲ / ▼ to select a folder, and press ENTER to see the folder contents.
- The disc subtitle may not be displayed properly, if a DivX subtitle is downloaded through the internet.
- If the disc subtitle setup menu does not have the DivX subtitle language you are going to play, the subtitle language may not be displayed properly.

Playing a DivX Movie Disc (Continued)

DivX disc compatibility with this player is limited as follows:

- Available resolution size of the DivX file is under 720x576 (W x H) pixel.
- The file name of the DivX subtitle is limited to 56 characters.
- If there is impossible code to express in the DivX file, it may be displayed as " _ " mark on the display.
- **If the frame rate is over 30 frames per second, this unit may not operate normally.**
- **If the video and audio structure of recorded file is not interleaved, either video or audio is outputted.**
- **If the file is recorded with GMC, the unit supports only 1-point of the record level.**
 - * GMC?
GMC is the acronym for Global Motion Compensation. It is an encoding tool specified in MPEG4 standard. Some MPEG4 encoder, like DivX or Xvid, have this option.
There are different levels of GMC encoding, usually called 1-point, 2-point, or 3-point GMC.

Playable DivX file

“.avi”, “.mpg”, “.mpeg”

Playable Subtitle format

SubRip(*.srt/*.txt)
SAMI(*.smi)
SubStation Alpha(*.ssa/*.txt)
MicroDVD(*.sub/*.txt)
SubViewer 2.0(*.sub/*.txt)
TMPlayer(*.txt)
Dvd Subtitle System(*.txt)
VobSub (*.sub) → Sub/idx, stream based format.

Playable Codec format

“DIVX3.xx”, “DIVX4.xx”, “DIVX5.xx”, “XVID”,
“MP43”, “3IVX”.

Playable Audio format

“Dolby Digital”, “DTS”, “PCM”, “MP3”, “WMA”.
• Sampling frequency: within 8 - 48 kHz (MP3),
within 32 - 48kHz (WMA)
• Bit rate: within 8 - 320kbps (MP3),
32 - 192kbps (WMA)

Playing an USB

1. Connect the USB device to the USB port on the unit after power is on.
2. Press MODE on the unit.
The mode selection menu appears on the screen.



3. Select the USB using ◀ / ▶ buttons and press ENTER.
The file or folder list in USB device appears on the screen.
4. If you want to exit the menu, select the other mode in mode selection menu.

To Remove the USB device from the unit

1. Follow step 4 as shown above, to exit the menu.
2. Remove the USB from the unit.

NOTES

- Do not extract the USB device in operating.
- Music files (MP3/WMA), image files (JPEG) and DivX files can be played.
- The total number of files in a folder should be less than 650 files.
- This unit does not support all USB devices.
- This unit supports only USB Flash Memory.
- This unit can support USB1.1.

**For details on each operations item,
refer to relevant page. (See pages 28-34)**

Setting up the Player

The picture and sound of a nearby TV, VCR, or radio may be distorted during playback. If this occurs, position the player away from the TV, VCR, or radio, or turn off the unit after removing the disc.

DVD Player Connections

Depending on your TV and other equipment there are various ways you can connect the player. Please refer to the manuals of your TV, stereo system or other devices as necessary for additional connection information.

Video and Audio Connections to Your TV

Make sure the DVD player is connected directly to the TV and not to a VCR, otherwise the DVD image could be distorted by the copy protection system.

Video:

Connect the VIDEO OUT jack on the DVD player to the video in jack on the TV using the video cable.

Audio Connection to Your TV:

Connect the AUDIO OUT jacks of the DVD Player to the audio left and right IN jacks on the TV using the audio cables. Do not connect the DVD Player's AUDIO OUT jack to the phone in jack (record deck) of your audio system.

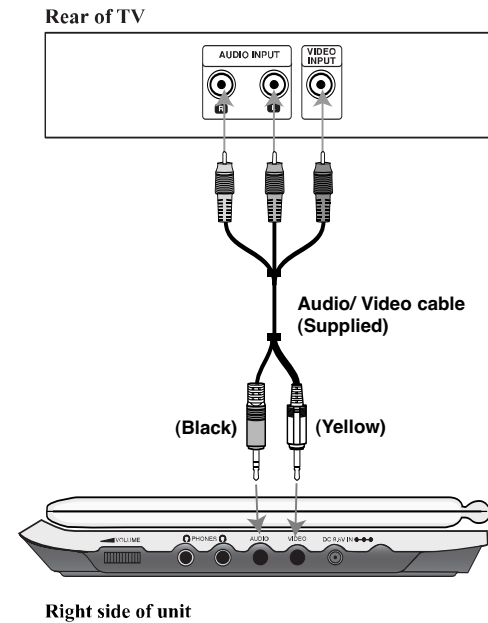

You must set the Mode selection menu to “USB” or “DISC” mode.

Setting up the Player (continued)

Audio Connection to Optional Equipment

Connect the DVD player to your optional equipment for audio output.

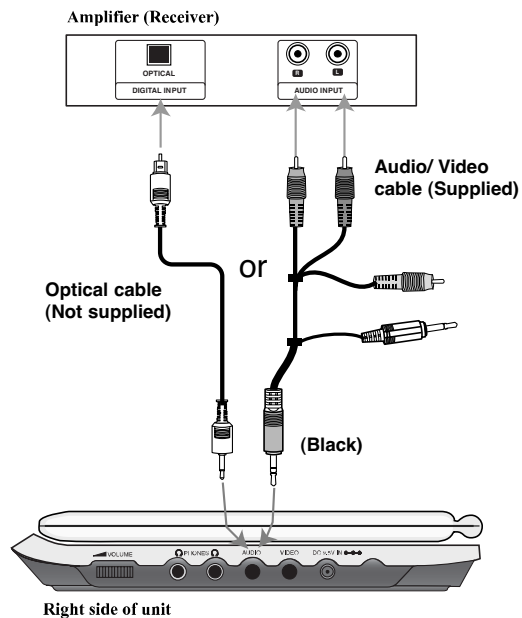

You must set the Mode selection menu to “USB” or “DISC” mode.

Amplifier equipped with 2-channel analog stereo or Dolby Pro Logic II / Pro Logic: Connect the AUDIO OUT jacks on the DVD player to the audio left and right IN jacks on your amplifier, receiver, or stereo system, using the audio cables.

Amplifier equipped with 2-channel digital stereo (PCM) or audio / video receiver equipped with a multi-channel decoder (Dolby Digital™, MPEG 2, or DTS): Connect one of the DVD Player’s DIGITAL AUDIO OUT jack to the corresponding in jack on your amplifier. Use an optional digital audio cable.

Digital Multi-channel sound

A digital multi-channel connection provides the best sound quality. For this you need a multi-channel audio / video receiver that supports one or more of the audio formats supported by your DVD player such as MPEG 2, Dolby Digital and DTS. Check the receiver manual and the logos on the front of the receiver.

NOTES

- If the audio format of the digital output does not match the capabilities of your receiver, the receiver produces a strong, distorted sound or no sound at all.
- Six Channel Digital Surround Sound via a digital connection can only be obtained if your receiver is equipped with a Digital Multi-channel decoder.
- To see the audio format of the current DVD in the on-screen display, press AUDIO.

Troubleshooting

Symptom	Cause	Correction
No power.	• The power cord is disconnected.	• Plug the power cord into the wall outlet securely.
	• The battery is discharged.	• Recharge the battery.
No picture on the LCD or TV (including video from another unit).	• The video cable is not connected securely.	• Connect the video cable into the jacks securely.
	• The MODE selection is not set correctly.	• Set the MODE correctly. While you are viewing video from other equipment, set the MODE to A/V IN mode.
	• LCD mode is set to OFF.	• Select a LCD mode other than OFF.
	• Check that Brightness control is set to “—”.	• Adjust the brightness.
No sound.	• The TV is not set to receive DVD signal output.	• Select the appropriate video input mode on the TV so the picture from the DVD player appears on the screen.
	• The equipment connected with the audio cable is not set to receive DVD signal output.	• Select the correct input mode of the audio receiver so you can listen to the sound from the DVD player.
The DVD player does not start playback.	• The audio cables are not connected securely.	• Connect the audio cable into the jacks securely.
	• An unplayable disc is inserted.	• Insert a playable disc. (Check the disc type, color system and Regional code.)
No response when buttons are pressed.	• The Rating level is set.	• Cancel the Rating function or change the rating level.
	• Some discs prohibit certain operations.	• “⊘” may appear on the screen during operation.
The remote control does not work properly.	• The remote control is too far from the DVD player.	• Operate the remote control within about 23 ft (7 m).

Language Codes

Use this list to input your desired language for the following initial settings:
Disc Audio, Disc Subtitle, Disc Menu.

Language	Code	Language	Code	Language	Code	Language	Code
Abkhazian	6566	Fiji	7074	Lingala	7678	Singhalese	8373
Afar	6565	Finnish	7073	Lithuanian	7684	Slovak	8375
Afrikaans	6570	French	7082	Macedonian	7775	Slovenian	8376
Albanian	8381	Frisian	7089	Malagasy	7771	Somali	8379
Ameharic	6577	Galician	7176	Malay	7783	Spanish	6983
Arabic	6582	Georgian	7565	Malayalam	7776	Sudanese	8385
Armenian	7289	German	6869	Maltese	7784	Swahili	8387
Assamese	6583	Greek	6976	Maori	7773	Swedish	8386
Aymara	6588	Greenlandic	7576	Marathi	7782	Tagalog	8476
Azerbaijani	6590	Guarani	7178	Moldavian	7779	Tajik	8471
Bashkir	6665	Gujarati	7185	Mongolian	7778	Tamil	8465
Basque	6985	Hausa	7265	Nauru	7865	Tatar	8484
Bengali; Bangla	6678	Hebrew	7387	Nepali	7869	Telugu	8469
Bhutani	6890	Hindi	7273	Norwegian	7879	Thai	8472
Bihari	6672	Hungarian	7285	Oriya	7982	Tibetan	6679
Breton	6682	Icelandic	7383	Panjabi	8065	Tigrinya	8473
Bulgarian	6671	Indonesian	7378	Pashto, Pushto	8083	Tonga	8479
Burmese	7789	Interlingua	7365	Persian	7065	Turkish	8482
Byelorussian	6669	Irish	7165	Polish	8076	Turkmen	8475
Cambodian	7577	Italian	7384	Portuguese	8084	Twi	8487
Catalan	6765	Japanese	7465	Quechua	8185	Ukrainian	8575
Chinese	9072	Javanese	7487	Rhaeto-Romance	8277	Urdu	8582
Corsican	6779	Kannada	7578	Rumanian	8279	Uzbek	8590
Croatian	7282	Kashmiri	7583	Russian	8285	Vietnamese	8673
Czech	6783	Kazakh	7575	Samoan	8377	Volapük	8679
Danish	6865	Kirghiz	7589	Sanskrit	8365	Welsh	6789
Dutch	7876	Korean	7579	Scots Gaelic	7168	Wolof	8779
English	6978	Kurdish	7585	Serbian	8382	Xhosa	8872
Esperanto	6979	Laothian	7679	Serbo-Croatian	8372	Yiddish	7473
Estonian	6984	Latin	7665	Shona	8378	Yoruba	8979
Faroese	7079	Latvian, Lettish	7686	Sindhi	8368	Zulu	9085

Area Codes

Choose an area code from this list.

Area	Code	Area	Code	Area	Code	Area	Code
Afghanistan	AF	Ethiopia	ET	Malaysia	MY	Saudi Arabia	SA
Argentina	AR	Fiji	FJ	Maldives	MV	Senegal	SN
Australia	AU	Finland	FI	Mexico	MX	Singapore	SG
Austria	AT	France	FR	Monaco	MC	Slovak Republic	SK
Belgium	BE	Germany	DE	Mongolia	MN	Slovenia	SI
Bhutan	BT	Great Britain	GB	Morocco	MA	South Africa	ZA
Bolivia	BO	Greece	GR	Nepal	NP	South Korea	KR
Brazil	BR	Greenland	GL	Netherlands	NL	Spain	ES
Cambodia	KH	Herd and McDonald Islands	HM	Netherlands Antilles	AN	Sri Lanka	LK
Canada	CA	Hungary	HU	New Zealand	NZ	Sweden	SE
Chile	CL	India	IN	Nigeria	NG	Switzerland	CH
China	CN	Indonesia	ID	Norway	NO	Thailand	TH
Colombia	CO	Israel	IL	Oman	OM	Turkey	TR
Congo	CG	Italy	IT	Pakistan	PK	Uganda	UG
Costa Rica	CR	Jamaica	JM	Panama	PA	Ukraine	UA
Croatia	HR	Japan	JP	Paraguay	PY	United States	US
Czech Republic	CZ	Kenya	KE	Philippines	PH	Uruguay	UY
Denmark	DK	Kuwait	KW	Poland	PL	Uzbekistan	UZ
Ecuador	EC	Libya	LY	Portugal	PT	Vietnam	VN
Egypt	EG	Luxembourg	LU	Romania	RO	Zimbabwe	ZW
El Salvador	SV			Russian Federation	RU		

Specifications

DVD Player

Power supply:
DC 9.5V (AC adapter terminal), DC 7.4V (Battery)

Power consumption: 12W with battery

Weight: 1.58 lbs (0.72 kg) (without battery pack)

External dimensions (W x H x D):
7.5 x 1.2 x 6.8 inches (191 x 30.5 x 174 mm)

Signal system: PAL

Laser:

DVD Laser wavelength 662+25 / 662-15 nm

CD Laser wavelength 785+25 / 785-15 nm

Frequency range (audio):

DVD linear sound: 48kHz sampling 8 Hz to 20 kHz
96kHz sampling 8 Hz to 44 kHz

Signal-to-noise ratio (audio): More than 95 dB

Dynamic range (audio): More than 95 dB

Harmonic distortion (audio): 0.08 %

Operating conditions:

Temperature: 0°C to 40°C, Operation status: Horizontal

Connectors

Video input/output (VIDEO In/Out):

1.0 V (p-p), 75 Ω, negative sync., ø3.5mm mini jack x 1

Audio input/output (AUDIO In/Out, analog audio):

2.0 Vrms(1 KHz, 0 dB), ø3.5mm mini jack x 1

Earphone terminal: ø3.5mm stereo mini jack x 2

Liquid Crystal Display

Panel size: 7 inches wide (diagonal)

Projection system: R.G.B. stripe

Driving system: TFT active matrix

Resolution: 234 x 480 x 3 (effective pixel rate: more than 99.99%)

Supplied Accessories

- RCA Audio/Video cable.....1
- AC Adapter1
- Automotive Adapter1
- Battery Pack1
- Remote control.....1
- Battery for Remote control (Lithium Battery)1

● Design and specifications are subject to change without notice.