



DR389



The Clear Choice In Digital Video™





**CAUTION**  
RISK OF ELECTRIC SHOCK  
DO NOT OPEN



**CAUTION:** TO REDUCE THE RISK OF ELECTRIC SHOCK DO NOT REMOVE COVER (OR BACK) NO USER-SERVICEABLE PARTS INSIDE REFER SERVICING TO QUALIFIED SERVICE PERSONNEL.



This lightning flash with arrowhead symbol within an equilateral triangle is intended to alert the user to the presence of uninsulated dangerous voltage within the product's enclosure that may be of sufficient magnitude to constitute a risk of electric shock to persons.



The exclamation point within an equilateral triangle is intended to alert the user to the presence of important operating and maintenance (servicing) instructions in the literature accompanying the product.

**WARNING:** TO PREVENT FIRE OR ELECTRIC SHOCK HAZARD, DO NOT EXPOSE THIS PRODUCT TO RAIN OR MOISTURE.

**WARNING:** Do not install this equipment in a confined space such as a book case or similar unit.

**CAUTION:** Do not block any ventilation openings. Install in accordance with the manufacturer's instructions.

Slots and openings in the cabinet are provided for ventilation and to ensure reliable operation of the product and to protect it from over heating. The openings should be never be blocked by placing the product on a bed, sofa, rug or other similar surface. This product should not be placed in a built-in installation such as a bookcase or rack unless proper ventilation is provided or the manufacturer's instruction has been adhered to.

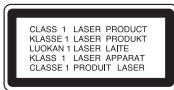

**CAUTION:** CLASS 3B VISIBLE AND INVISIBLE LASER RADIATION WHEN OPEN AND INTERLOCKS DEPEATED AVOID EXPOSER TO THE BEAM.

**CAUTION:** This product employs a Laser System.

To ensure proper use of this product, please read this owner's manual carefully and retain it for future reference. Should the unit require maintenance, contact an authorized service center.

Use of controls, adjustments or the performance of procedures other than those specified herein may result in hazardous radiation exposure.

To prevent direct exposure to laser beam, do not try to open the enclosure. Visible laser radiation when open. DO NOT STARE INTO BEAM.

**CAUTION:** The apparatus should not be exposed to water (dripping or splashing) and no objects filled with liquids, such as vases, should be placed on the apparatus.

#### **CAUTION concerning the Power Cord**

**Most appliances recommend they be placed upon a dedicated circuit;**

That is, a single outlet circuit which powers only that appliance and has no additional outlets or branch circuits. Check the specification page of this owner's manual to be certain. Do not overload wall outlets. Overloaded wall outlets, loose or damaged wall outlets, extension cords, frayed power cords, or damaged or cracked wire insulation are dangerous. Any of these conditions could result in electric shock or fire. Periodically examine the cord of your appliance, and if its appearance indicates damage or deterioration, unplug it, discontinue use of the appliance, and have the cord replaced with an exact replacement part by an authorized service center. Protect the power cord from physical or mechanical abuse, such as being twisted, kinked, pinched, closed in a door, or walked upon. Pay particular attention to plugs, wall outlets, and the point where the cord exits the appliance. To disconnect power from the mains, pull out the mains cord plug. When installing the product, ensure that the plug is easily accessible.

#### **Disposal of your old appliance**



1. When this crossed-out wheeled bin symbol is attached to a product it means the product is covered by the European Directive 2002/96/EC.
2. All electrical and electronic products should be disposed of separately from the municipal waste stream via designated collection facilities appointed by the government or the local authorities.
3. The correct disposal of your old appliance will help prevent potential negative consequences for the environment and human health.
4. For more detailed information about disposal of your old appliance, please contact your city office, waste disposal service or the shop where you purchased the product.



**This product is manufactured to comply with EMC Directive 2004/108/EC and Low Voltage Directive 2006/95/EC.**

European representative:  
LG Electronics Service Europe B.V.  
Veluwezoom 15, 1327 AE Almere, The Netherlands  
(Tel : +31-036-547-8940)

## Copyrights

- Recording equipment should be used only for lawful copying and you are advised to check carefully what is lawful copying in the area in which you are making a copy. Copying of copyright material such as films or music is unlawful unless permitted by a legal exception or consented to by the rights owner.
- This product incorporates copyright protection technology that is protected by method claims of certain U.S. patents and other intellectual property rights owned by Macrovision Corporation and other rights owners. Use of this copyright protection technology must be authorized by Macrovision Corporation, and is intended for home and other limited viewing uses only, unless otherwise authorized by Macrovision corporation. Reverse engineering or disassembly is prohibited.
- CONSUMERS SHOULD NOTE THAT NOT ALL HIGH DEFINITION TELEVISION SETS ARE FULLY COMPATIBLE WITH THIS PRODUCT AND MAY CAUSE ARTIFACTS TO BE DISPLAYED IN THE PICTURE. IN CASE OF 625 PROGRESSIVE SCAN PICTURE PROBLEMS, IT IS RECOMMENDED THAT THE USER SWITCH THE CONNECTION TO THE 'STANDARD DEFINITION' OUTPUT. IF THERE ARE QUESTIONS REGARDING OUR TV SET COMPATIBILITY WITH THIS MODEL 625p DVD RECORDER, PLEASE CONTACT OUR CUSTOMER SERVICE CENTER.

Manufactured under license from Dolby Laboratories. Dolby and the double-D symbol are registered trademarks of Dolby Laboratories.

# Contents

Before you start .....	5-6
Remote control .....	7
Main Unit .....	8
Hooking up the unit .....	9-12
Operating USB Flash Drive .....	12
Auto setup .....	13
Using the Home Menu .....	13-14
Adjust the SETUP settings .....	14-18
Displaying disc Information .....	18-19
Play a disc .....	20-21
Playing a DivX® movie files .....	21
Listening to a music .....	22
Viewing a photo .....	23
Recording .....	24-25
Editing a title .....	25-28
Language Codes .....	29
Area Codes .....	29
Troubleshooting .....	30-31
Specifications .....	32









Before connecting, operating or adjusting this product, please read this instruction booklet carefully and completely.



## Before you start











### Recordable and Playable discs

This unit can play and record all widely-used DVD types. The table below shows some specific compatibility differences depending on the disc types.

	DVD-R	DVD-RW	DVD+R	DVD+RW
Symbol used in this manual				
Logos				
Re-Writable	No	Yes	No	Yes
Formatting Mode (new discs)	Video mode	Video mode	Video	Video
Editing	Limited	Yes	Limited	Yes
Play on other players	The player must compatible with corresponding media and the media has to be finalized.			
Recommended discs	Mitsubishi(8x,16x) Verbatim(8x,16x)	Mitsubishi(4x) Verbatim(4x) JVC(4x) Maxell(4x)	Mitsubishi(8, 16x) Verbatim(8, 16x)	Mitsubishi(4x) HP(4x) Verbatim(4x) Ricoh(4x)

### Playable discs

The table below shows the file formats and media types that this unit can playback.

	DVD	Audio CD	Data disc (DivX, JPEG, MP3 or WMA)
Symbol used in this manual			   
Logos			 
Characteristics	Discs such as movies that can be purchased or rented.	Music CDs or CD-R/RWs in music CD format that can be purchased	CD-R/CD-RW/DVD discs that contain DivX, JPEG, MP3 or WMA files.

## Notes on discs

---

- Depending on the conditions of the recording equipment or the CD-R/RW (or DVD±R/RW) disc itself, some CD-R/RW (or DVD±R/RW) discs cannot be played on the unit.
- Do not attach any seal or label to either side (the labeled side or the recorded side) of a disc.
- Do not use irregularly shaped CDs (e.g., heart-shaped or octagonal). Doing so may result in malfunctions.
- Depending on the recording software & the finalization, some recorded discs (CD-R/RW or DVD±R/RW) may not be playable.
- DVD-R/RW, DVD+R/RW and CD-R/RW discs recorded using a personal computer or a DVD or CD Recorder may not play if the disc is damaged or dirty, or if there is dirt or condensation on the Unit's lens.
- If you record a disc using a personal computer, even if it is recorded in a compatible format, there are cases in which it may not play because of the settings of the application software used to create the disc. (Check with the software publisher for more detailed information.)
- This unit requires discs and recordings to meet certain technical standards in order to achieve optimal playback quality. Pre-recorded DVDs are automatically set to these standards. There are many different types of recordable disc formats (including CD-R containing MP3 or WMA files) and these require certain pre-existing conditions (see above) to ensure compatible playback.
- Customers should note that permission is required in order to download MP3 / WMA files and music from the Internet. Our company has no right to grant such permission. Permission should always be sought from the copyright owner.

## Restrictions on copying

---

Some video material is copy-once protected: Such material cannot be copied to DVD. You can identify copy-once protected material during playback by displaying disc information on-screen.

- NTSC format signal is not recorded correctly with this unit.
- Video signals in SECAM format (from the built-in TV tuner or from the analog inputs) are recorded in PAL format.

## About the Symbol Display

---

“  ” may appear on your TV display during operation and indicates that the function explained in this owner's manual is not available on that specific media.

## Regional Codes

---

This unit has a regional code printed on the rear of the unit. This unit can play only DVD discs labeled same as the rear of the unit or “ALL”.

- Most DVD discs have a globe with one or more numbers in it clearly visible on the cover. This number must match your unit's regional code or the disc cannot play.
- If you try to play a DVD with a different regional code from the unit, the message “Incorrect region code. Can't play back” appears on the TV screen.

## Remote Control Operation

---

Point the Remote Control at the remote sensor and press the buttons.

## Remote Control Battery Installation

---

Remove the battery cover on the rear of the Remote Control, and insert R03 (size AAA) battery with ⊕ and ⊖ matched correctly.

# Remote control

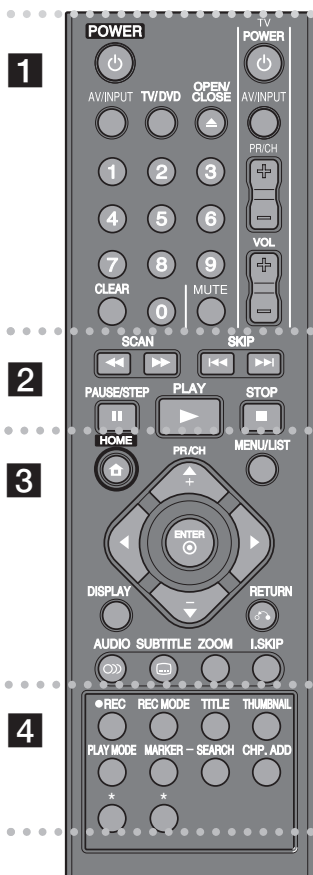

..... 1 .....

**POWER:** Switches the unit ON or OFF.  
**AV/INPUT:** Changes the input source (Tuner, AV1-3, or DV IN).  
**TV/DVD:** Press to switch between 'TV mode', in which you get the picture and sound from the TV's tuner, and 'DVD mode', in which you get picture and sound from this unit.  
**OPEN/CLOSE:** Opens and closes the disc tray.  
**0-9 numerical buttons:** Selects numbered options in a menu.  
**CLEAR:** Removes a mark on the Marker Search menu.  
**TV Control Buttons:** You can control the sound level, input source, selects TV's channel and power switch of your TV.

..... 2 .....

**SCAN (◀◀ / ▶▶):** Search backward or forward.  
**SKIP (◀◀◀ / ▶▶▶):** Go to next or previous chapter or track.  
**PAUSE/STEP (||):** Pause playback or recording temporarily.  
**PLAY (▶):** Starts playback.  
**STOP (■):** Stops playback or recording.

..... 3 .....

**HOME:** Accesses or removes the HOME menu.  
**MENU/LIST:** Accesses menu on a DVD disc. Switches between Title List-Original and Title List-Playlist menu.  
**DISPLAY:** Accesses On-Screen Display.  
**RETURN (↵):** Removes the on-screen displays.  
**◀ / ▶ / ▲ / ▼ (left/right/up/down):** Used to navigate on-screen displays.

**ENTER (⊙):** Acknowledges menu selection.  
**PR/CH (+/-):** Scans up or down through memorized channels.  
**AUDIO (🔊):** Selects an audio language or audio channel.  
**SUBTITLE (🗣️):** Selects a subtitle language.  
**ZOOM:** Enlarges DVD video image.  
**I.SKIP (INSTANT SKIP):** Skips 30 seconds forward during playback.

..... 4 .....

**REC (●):** Starts recording.  
**REC MODE:** Selects the recording mode.  
**TITLE:** Displays the disc's Title menu, if available.  
**THUMBNAIL:** Selects a thumbnail picture.  
**PLAY MODE:** Selects a play mode.  
**MARKER:** Marks any point during playback.  
**SEARCH:** Displays Marker Search menu.  
**CHP. ADD:** Inserts a chapter marker when playing/recording.  
 \*: Feature is not available.

## Setting up the remote to control your TV

You can operate your TV with the supplied remote control. If your TV is listed in the table below, set the appropriate manufacturer code.

While holding down TV POWER button, and press the manufacturer code for your TV with the numerical buttons (see the table below). Release the TV POWER button to complete setting.

Manufacturer	Code Number
LG / GoldStar	1 (Default), 2
Zenith	1, 3, 4
Samsung	6, 7
Sony	8, 9
Hitachi	4

Depending on your TV, some or all buttons may not function on the TV, even after entering the correct manufacturer code. When you replace the batteries of the remote, the code number you have set may be reset to the default setting. Set the appropriate code number again.

# Main Unit

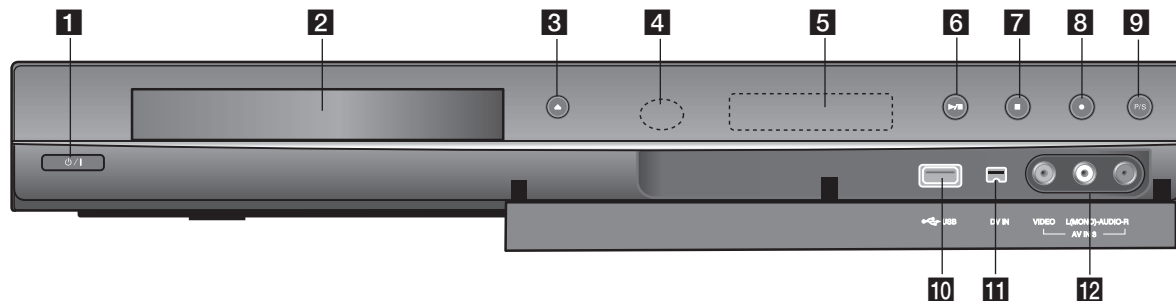

- 1** **⏻ / I (POWER button)**  
Switches the unit ON or OFF.
- 2** **Disc Tray**  
Insert a disc here.
- 3** **OPEN/CLOSE (▲)**  
Opens or closes the disc tray.
- 4** **Remote Sensor**  
Point the remote control here.
- 5** **Display window**  
Shows the current status of the recorder.  
**REC:** The recorder is recording.  
**TV:** Indicates when the recorder is in TV tuner mode.  
⌚ : Indicates when the recorder is in timer recording or a timer recording is programmed.  
⌚:⌚:⌚:⌚ : Shows the current status of the recorder. (clock, program number, etc).
- 6** **▶ / II (PLAY / PAUSE)**  
Starts playback.  
Pause playback or recording temporarily, press again to exit pause mode.
- 7** **■ (STOP)**  
Stops playback or recording.
- 8** **● (REC)**  
Starts recording. Press repeatedly to set the recording time.
- 9** **P/S (Progressive Scan)**  
Switches the progressive mode.  
576i(OFF), 576p(ON)
- 10** **USB Port**  
Connect an USB Memory Stick.
- 11** **DV IN**  
Connect the DV output of a digital camcorder.
- 12** **AV IN 3 (VIDEO IN/AUDIO IN (Left/Right))**  
Connect the audio/video output of an external source (Audio system, TV/Monitor, VCR, Camcorder, etc.).



# Hooking up the unit

## 3 SCART connection

Connect one end of the scart cable into the AV1 SCART jack on the unit and other end to the corresponding in jack on your TV. You can get Audio and Video signals together with this connection.

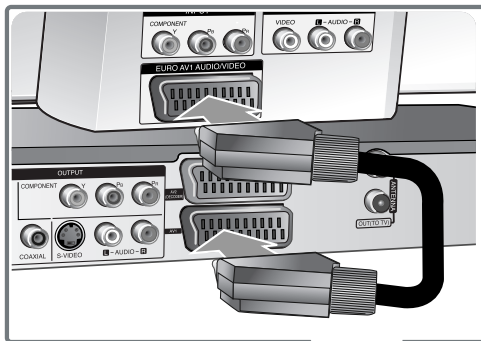

## 1 Antenna connection

Connect the Terrestrial TV antenna to the ANTENNA IN jack on the unit.

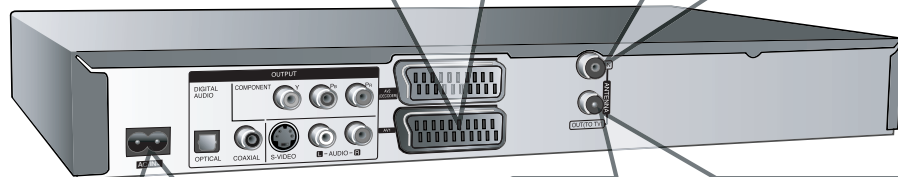
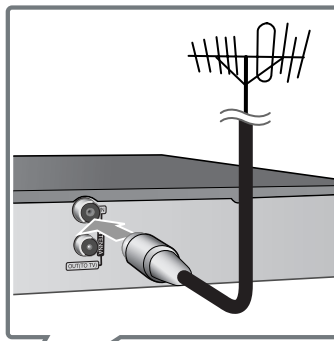

## 4 Power cord connection

Connect the mains lead to the AC IN terminal on the unit. Then plug the power cord into the mains.

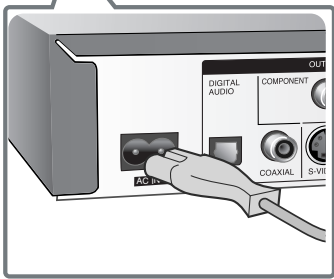

## 2 Antenna connection to your TV

Connect one end of the RF cable to ANTENNA OUT jack on the unit and other end to ANTENNA IN jack on your TV.

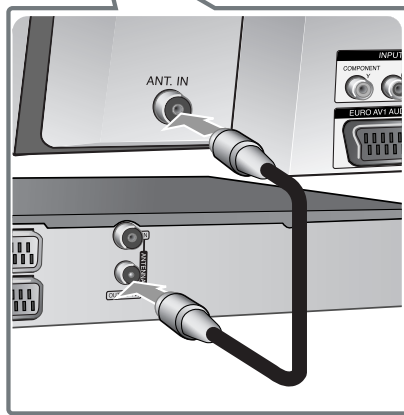

# Hooking up the unit - more you can do

## Component connection

Connect one end of the component(Y PB PR) cable to the COMPONENT OUTPUT jack on the unit and other end to the COMPONENT INPUT jack on your TV.

Connect one ends of the audio cables (red and white) to the analog AUDIO OUTPUT jack on the unit and other ends to the AUDIO INPUT jack on your TV.

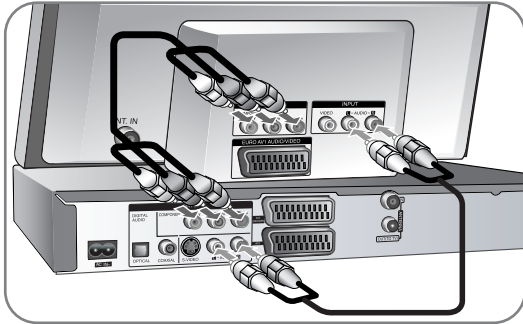

If your television is a high-definition or “digital ready” television, you may take advantage of the unit’s progressive scan output for the highest video resolution possible. If your TV does not accept the Progressive Scan format, the picture will appear scrambled with the progressive signal.

Set the resolution to 576p using P/S button on the front panel for progressive signal.

## S-Video connection

Connect one end of the S-Video cable to the S-VIDEO OUTPUT jack on the unit and other end to the S-Video INPUT jack on your TV.

Connect one ends of the audio cables (red and white) to the analog AUDIO OUTPUT jack on the unit and other ends to the AUDIO INPUT jack on your TV.

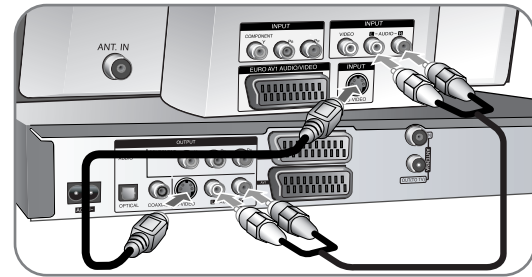

## Digital audio connection

Connecting to an amplifier/receiver, Dolby Digital/MPEG/DTS decoder or other equipment with a digital input.

Connect one end of the digital audio cables (COAXIAL or OPTICAL) to the digital audio output jack (COAXIAL or OPTICAL) on the unit and other end to the digital audio input jack (COAXIAL or OPTICAL) on your amplifier.

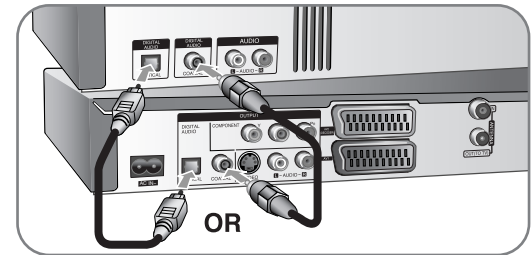

This recorder does not perform internal (2 channel) decoding of a DTS sound track. To enjoy DTS multi channel surround, you must connect this recorder to a DTS compatible receiver via one of this recorder’s digital audio outputs.

## Connecting a PAY-TV/Canal Plus Decoder

You can watch or record PAY-TV/Canal Plus programmes if you connect a decoder (not supplied) to the unit. Disconnect the unit's mains lead from the mains when connecting the decoder. You do not need to turn on the unit to view the signals from the connected tuner on your TV.

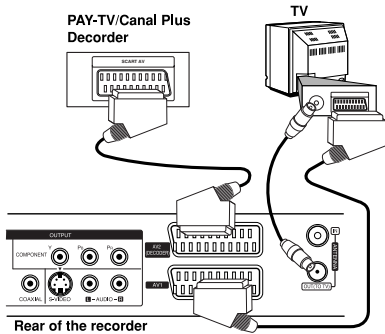

To watch or record PAY-TV/Canal Plus programmes, set [AV2 Connection] option to [Decoder] (see page 15) and set the program's [Decoder On/Off] option to [On] on the Setup menu (page 13). If you disconnect the unit's mains lead, you will not be able to view the signals from the connected decoder.

- Pictures containing copy protection signals that prohibit any copying cannot be recorded.
- If you pass the unit signals via the VCR, you may not receive a clear image on your TV screen.  
Be sure to connect your VCR to the unit and your TV in the order shown below. To watch video tapes, watch the tapes through a second line input on your TV.

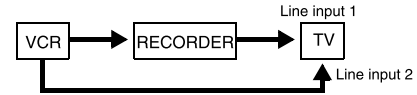

- When you record to a VCR from this unit, do not switch the input source to TV by pressing the TV/DVD button on the remote.
- If you are using a B Sky B tuner, be sure to connect the tuner's VCR SCART jack to the AV2 DECODER jack.
- If you disconnect the unit's mains lead, you will not be able to view the signals from the connected VCR or tuner.

## Connecting to the AV2 DECODER jack

Connect a VCR or similar recording device to the AV2 DECODER jack of this unit. You do not need to turn on the unit to view the signals from the connected tuner on your TV.

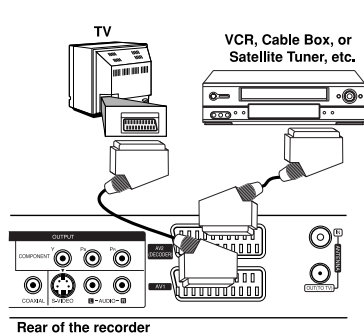

To watch or record the source from AV2 DECODER jack, set [AV2 Connection] option to [Other Device] (see page 15) and set [AV2 Recording] option to [Auto], [CVBS], [RGB] or [S-Video] as required (see page 17).

## Connecting to the AV IN 3 Jacks

Connect the input jacks (AV IN 3) on the unit to the audio/video out jacks on your accessory component using audio/video cables.

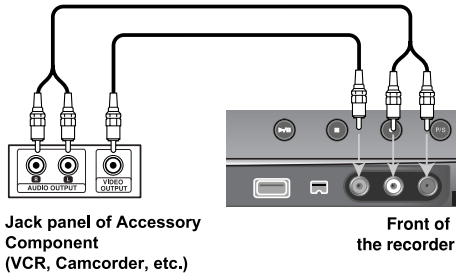

## Connecting a Digital Camcorder

Using the front panel DV IN jack, it is possible to connect a DV digital camcorder and digitally transfer DV tapes to DVD.

Use a DV cable (not supplied) to connect the DV in/out jack of your DV camcorder to the front panel DV IN jack of this unit.

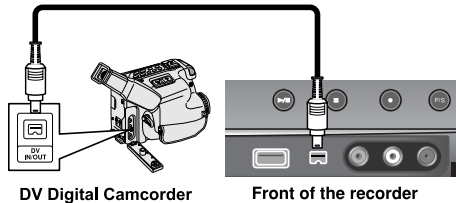

The DV IN jack is for connection to DV digital camcorder only. It is not compatible with digital satellite tuners or D-TAPE video decks. Disconnecting the DV cable while recording a contents of the connected digital camcorder may result in malfunction.

## Operating USB Flash Drive

	ON REMOTE
1. Insert an USB Flash Drive to the USB port:	—
2 Displays the HOME menu:	HOME
3 Select a main option: [MUSIC], [PHOTO] or [MOVIE] option	◀ ▶
4 Select the [USB] option:	▲ ▼
5 Displays corresponding menu list: For details of operations on each files, refer to relevant pages.	ENTER

## Using USB Flash Drive - more you can do

### Using an USB Flash Drive

This unit can play the MP3/WMA/JPEG/DivX files contained in the USB Flash Drive.

**Inserting the USB Flash Drive** – Insert straight-in until it fits into place.

**Removing the USB Flash Drive** – Withdraw the USB Flash Drive carefully when the connected USB Flash Drive is not operating.

### Notes on USB Flash Drive

- The contents on the disc cannot be moved or copied to USB Flash Drive.
- Keep the USB Flash Drive out of reach of children. If swallowed, seek medical advice immediately.
- This unit supports only USB Flash Drive with FAT16 or FAT32 format.
- The USB Flash Drives which require additional program installation when you have connected it to a computer are not supported.
- This unit is compatible with the Flash type USB device that supports USB 1.1.
- This unit may not supports some USB Flash Drive.
- **Do not extract the USB Flash Drive in operating (play, etc.). It may cause a malfunction on this unit.**

## Auto setup

When the first time to turn on the unit, the initial setup wizard sets the language, clock and channels automatically.

### ON REMOTE

<b>1 Turn on the unit</b> The initial setup wizard appears on the screen.	<b>POWER</b>
<b>2 Choose a language:</b>	<b>▲ ▼</b>
<b>3 Select the chosen language:</b>	<b>ENTER</b>
<b>4 Check the antenna and go to the next step:</b>	<b>ENTER</b>
<b>5 Choose a country you are using the unit:</b>	<b>▲ ▼ ▶</b>
<b>6 Select the [Start] and starts channel scan:</b>	<b>▶ ENTER</b>
<b>7 Choose a clock setting mode:</b>	<b>▲ ▼</b>
<b>8 Select the chosen clock setting mode:</b>	<b>ENTER</b>
<b>9 Set the clock:</b> This step is not available for Auto mode	<b>▲ ▼ ◀ ▶</b> <b>ENTER</b>
<b>10 Close the initial setup:</b>	<b>ENTER</b>

## Auto setup - more you can do

### Adjust the programmed channels

Press HOME, then use ◀▶ to select [Setup] option. Press ENTER while [Start] is selected. The SETUP menu appears on the screen. Select the [Program Edit] on the second level options then press ▶ to move to the third level. Press ENTER while [Edit] option is selected. The channel editing screen appears on the screen.

Select which channel you would like to edit and press ENTER. An option menu appear on the left side of the screen.

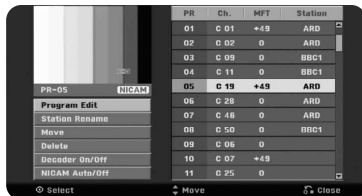

[Program Edit]: Change the settings of a channel manually.  
 [Station Rename]: Change a name of the selected channel.  
 [Move]: Moves the program's location on the program list.  
 [Delete]: Delete the selected channel from programmed channel list.  
 [Decoder On/Off] Sets the channels for the decoder. You need this setting to watch or record PAY-TV/Canal Plus programmes. Press ENTER so [Decoder] appears on the display. Press ENTER again to turn off the setting.  
 [NICAM Auto/off]: Sets the channels for the NICAM broadcast.

### Editing a channel

You can change the settings of prgrammed channel by selecting [Program Edit] option on the left side of the channel editing screen.



[PR]: Indicates the selected channel position.  
 [Seek]: Searches for a channel automatically. Searching stops when the unit tunes in a channel.  
 [Ch.] Changes the channel number.  
 [MFT] Fine tunes the channel to obtain a clearer picture.  
 [OK]: Confirm the settings and return to the channel list menu.

## Using the Home Menu

### ON REMOTE

<b>1 Displays the HOME menu:</b>	<b>HOME</b>
<b>2 Select a main option:</b>	<b>◀ ▶</b>
<b>3 Select a sub option:</b>	<b>▲ ▼</b>
<b>4 Exit the HOME menu:</b>	<b>HOME</b>

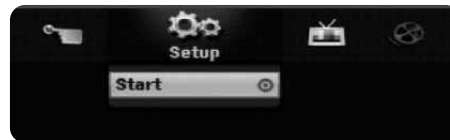

# Using the Home Menu - more you can do

## Setup

Start – Displays SETUP menu. (page 15-18)

## MOVIE

### DISC

- Displays [Title List] menu, which shows recorded titles on the disc. (page 25)
- Displays [Movie List] menu, which shows DivX® movie files on the disc. (page 21)
- Plays DVD-Video disc (page 20).

USB – Displays [Movie List] menu on the USB Flash Drive. (page 21)

## PHOTO

DISC – Displays [Photo List] menu, which shows photo files on the disc. (page 23)

USB – Displays [Photo List] menu, which shows photo files on the USB Flash Drive. (page 23)

## MUSIC

DISC – Displays [Music List] menu, which shows music files or audio tracks on the disc. (page 22)

USB – Displays [Music List] menu, which shows music files on the USB Flash Drive. (page 22)

## Easy Menu

Disc Manager – Displays the disc settings menu. (page 18)

DV Input – Changes to DV Input mode.

Rec Mode – Displays [Disc Record Mode] option in the SETUP Menu. (page 17)

## TV

Auto Ch. Scan – Displays [Auto Programming] option in the SETUP Menu. (page 15)

PR Edit – Displays [Program Edit] option in the SETUP Menu. (page 13)

Timer Record – Displays [Timer Record] menu. (page 24)

## Adjust the SETUP settings

	ON REMOTE
<b>1 Displays the HOME menu:</b>	<b>HOME</b>
<b>2 Select the [Setup] option:</b>	<b>◀ ▶</b>
<b>3 Select the [Start] option:</b>	<b>ENTER</b>
<b>4 Select a desired option on the first level:</b>	<b>▲ ▼</b>
<b>5 Move to second level:</b>	<b>▶</b>
<b>6 Select a desired option on the second level:</b>	<b>▲ ▼</b>
<b>7 Move to third level:</b>	<b>▶</b>
<b>8 Adjust or confirm the setting:</b>	<b>▲ ▼, ENTER</b>
<b>9 Go back to the previous level:</b>	<b>◀</b>

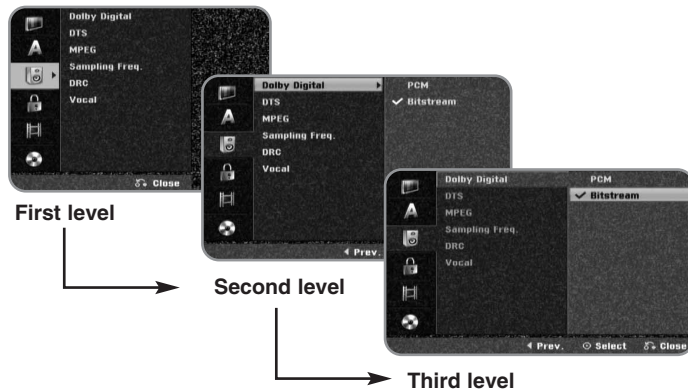

# Adjust the SETUP settings - more you can do

## Adjust the general settings

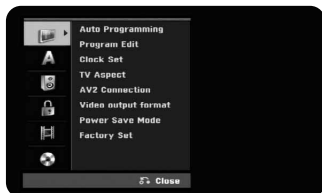

**Auto Programming** – This option automatically scans and sets the available channels.

[Country]: Select a country where you operate this unit. If the country that you want to set is not listed, select [Others].

[Start]: Start the channel scanning.

**Program Edit**– This option allows you to add channels and edit preset channels.

[Edit]: Displays the screen which show preset channel list and channel editing options. (page 13)

**Clock Set** – The clock must be set in order to use [Timer record].

[Auto]: Set the channel that broadcasts a clock signal and the clock will be set automatically.

[Manual]: If there is no channel that broadcasts a clock signal in your area, you can set the time and date manually.

**TV Aspect** – Selects the aspects ratio of the connected TV.

[4:3 Letter Box]: Select this when connecting to a standard 4:3 screen TV and prefer the wide picture with bands on the upper and lower portions of the screen.

[4:3 Pan Scan]: Select this when connecting to a standard 4:3 screen TV and prefer the wide picture on the entire screen cuts off the portions that do not fit.

[16:9 Wide]: Select this when connecting to a wide-screen TV.

**AV2 Connection** – You can connect a decoder or the other device to the AV2(DECODER) jack on the rear panel.

[Decoder]: Select this when you connect a PAY-TV or Canal Plus decoder to the AV2(DECODER) jack on the unit.

[Other Device]: Select this when you connect a VCR or similar recording device to the AV2(DECODER) jack on the unit.

**Video output format** – Select an option according to the TV connection type.

[YPbPr]: When your TV is connected to the COMPONENT OUTPUT jacks on the unit.

[RGB]: When your TV is connected to the SCART jack on the unit.

**Power Save mode** – Selects whether this unit is in power save mode when the power is turned off. This option is not available when a timer recording is set.

[ON]\*1: The front panel display is off and only signals arriving at the antenna input are passed through when the unit is turned off.

[OFF]: Turns off the [Power Save Mode].

\*1 If you turns off the unit while receiving encoded signals, the power save mode does not work

**Factory Set** – You can reset the unit to all its factory settings. Some options cannot be reset (Rating, Password, and Area Code). The auto setup menu appears on the screen after the factory settings.

## Adjust the language settings

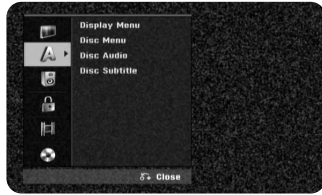

**Display Menu** – Select a language for the Setup menu and on-screen display.

**Disc Menu/Audio/Subtitle** – Select a language for the Menu/Audio/Subtitle.

[Original]: Refers to the original language in which the disc was recorded.

[Others]: To select another language, press number buttons to enter the corresponding 4-digit number according to the language code list on page 29. If you make a mistake while entering number, press CLEAR repeatedly to delete numbers one by one then correct it.

[OFF] (for Disc Subtitle): Turn off Subtitle.

## Adjust the audio settings



**Dolby Digital / DTS / MPEG** – Selects the type of digital audio signal when using the DIGITAL AUDIO OUTPUT jack.

[Bitstream] – Select this when you connect this unit's DIGITAL AUDIO OUTPUT jack to an audio component with a built-in Dolby Digital, DTS or MPEG decoder.

[PCM] (for Dolby Digital / MPEG) – Select this when you connect this unit's DIGITAL AUDIO OUTPUT jack to an audio component without a built-in Dolby Digital or MPEG decoder.

[Off] (for DTS) – Select this when you connect this unit's DIGITAL AUDIO OUTPUT jack to an audio component without a built-in DTS decoder.

**Sampling Freq. (Frequency)** – Selects the sampling frequency of the audio signal.

[48 kHz]: 48 kHz]: The digital audio signals are output in their original format upto 48 kHz. In case of DVD with 96KHz sampling, Output is converted to 48kHz. If your receiver or amplifier is NOT capable of handling 96 kHz signals, select [48 kHz].

[96 kHz]: The digital audio signals are output in their original sampling format.

**DRC (Dynamic Range Control)** – Make the sound clear when the volume is turned down (Dolby Digital only). Set to [On] for this effect.

**Vocal** – Select [On] to mix karaoke channels into normal stereo. This function is effective for multi-channel karaoke DVDs only.

## Adjust the lock settings

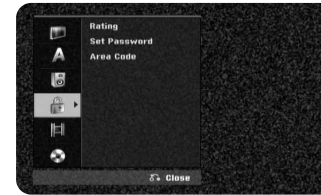

To access the Rating, Password or Area Code options, you must enter the 4-digit password. If you have not yet entered a password you are prompted to do so. Enter a 4-digit password. Enter it again to verify. If you make a mistake while entering number, press CLEAR repeatedly to delete numbers one by one then correct it.

If you forget your password, you can reset it. Displays the SETUP menu. Input '210499' and select [OK] to confirm. The password has now been cleared.

**Rating** – Select a rating level. The lower the level, the stricter the rating. Select [No Limit] to deactivate the rating.

**Set Password** – Changes or deletes the password.

[Change]: Enter the new password twice after entering the current password.

[Delete]: Delete the current password after entering the current password.

**Area code** – Select a code for a geographic area as the playback rating level. This determines which area's standards are used to rate DVDs controlled by the parental lock. See the Area Codes on page 29.



## Adjust the recording settings

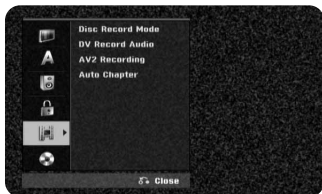

**Disc Record Mode** – Select the picture quality for recording from XP, SP, LP, EP or MLP. See recording time of each mode on page 32.

[XP]: Highest picture quality.

[SP]: Standard picture quality.

[LP]: Slightly lower picture quality than [SP] mode.

[EP]: Low picture quality.

[MLP]: The longest recording time with the lowest picture quality.

**DV Record Audio** – You need to set this if you have a camcorder using 32kHz/12-bit sound connected to the front panel DV IN jack.

Some digital camcorders have two stereo tracks for audio. One is recorded at the time of shooting; the other is for overdubbing after shooting.

On the Audio 1 setting, the sound that was recorded while shooting is used.

On the Audio 2 setting, the overdubbed sound is used.

**AV2 Recording** – Selects a method of inputting video signals for the AV2(DECODER) jack. The picture will not be clear if this setting does not match the type of the video input signal.

[Auto]: The video input signal will automatically follow the video signal received.

[CVBS]: Inputs CVBS(composite) video signals.

[RGB]: Inputs RGB signals.

[S-VIDEO]: Inputs S-Video signals.

**Auto Chapter** – When DVD recording, chapter markers are added automatically in every specified interval (5 or 10 min.).

## Adjust the disc settings



**Initialize** – You can Initialize a DVD by pressing ENTER while [Start] is selected. The [Initialize] menu appears. The unit starts formatting after confirmation. You can select a mode between VR and Video for DVD-RW discs. The everything recorded on the DVD will be erased after formatting.

The disc format for DVD-R, DVD+R, DVD+RW, discs is always “Video” format - the same as pro-recorded DVD-Video discs.

(You can play a DVD-R, DVD+R, DVD+RW, discs in a regular player).

If you load a completely blank disc, the unit will initialize the disc automatically. See “Formatting mode (new disc)” on page 5 for more information.

**Finalize** – Finalizing is necessary when you play disc recorded with this unit on other DVD equipment. How long finalization takes depends on the disc condition, recorded length and number of titles.

[Finalize]: The [Finalize] menu appears. The unit starts finalizing after confirmation.

[Unfinalize]: The finalized DVD-RW discs can be unfinalized after confirming on the [Unfinalize] menu. After unfinalizing, the disc can be edited and re-record.

Before finalizing, check the characteristics between the disc type in the table below.

<b>-RW</b>	The finalized DVD-RW discs can be unfinalized so that the disc can edit or record again.
<b>+R -R</b>	Once you finalize a disc, you can not edit or record anything on the disc.
<b>+RW</b>	Discs are automatically finalized when removed from the unit. The edited contents are playable on DVD+RW compatible players only after finalization

**Disc Label** – This function allow you to change the default disc name to something more descriptive. This name appears when you load a disc and when you display disc information on-screen. The keyboard menu appears by pressing ENTER while [Edit] is selected.

**Disc Protect** – This function allow you to protect discs from accidental record, erasure and editing by setting this option to [ON]. The DVD-R and Video mode formatted DVD-RW are not available to protect.

**About DivX(R)** – We provide you with the DivX® VOD (Video On Demand) registration code that allows you to rent and purchase videos using the DivX® VOD service. For more information, visit [www.divx.com/vod](http://www.divx.com/vod). Press ENTER when [Enter] icon is highlighted and you can view the registration code of the unit.

## Displaying disc information

	ON REMOTE
1 Play the disc loaded on the unit	PLAY
2 Displays current status of playback:	DISPLAY
3 Displays the playback menu:	DISPLAY
4 Select an item:	▲ ▼
5 Adjust the playback menu settings:	◀ ▶
6 Exit the disc playback menu	DISPLAY

## Displaying disc Information - more you can do

### Adjusting playback menu item

You can select an item by pressing ▲▼ and change or select the setting by pressing ◀▶.



- Current title/track / Total number of titles/tracks
- Current chapter / total number of chapters
- Elapsed playing time
- Selected audio language or audio channel
- Selected subtitle
- Selected angle / Total number of angles
- Selected sound mode

## Moving to another title **DVD ALL** **DivX**

When a disc has more than one title, you can move to another title. Press DISPLAY twice during playback then use ▲ / ▼ to select the title icon. Then, press the appropriate numbered button (0-9) or ◀ / ▶ to select a title number.

## Starting playback from selected time **DVD ALL** **DivX**

Press DISPLAY twice during playback. The time search box shows the elapsed playing time. Select the time search box and then input the required start time in hours, minutes, and seconds from left to right. For example, to find a scene at 2 hours, 10 minutes, and 20 seconds, enter "21020" and press ENTER. If you enter the wrong numbers, press ◀ / ▶ to move the under bar (|) to the wrong number. Then enter the correct numbers.

## Selecting a subtitle language **DVD** **DivX**

During playback, press DISPLAY twice to display the playback menu. Use ▲ ▼ to select the subtitle option then use ◀ ▶ to select desired subtitle language.

OR

During playback, press SUBTITLE then use ◀ ▶ to select desired subtitle language.

## Watching from a different angle **DVD**

If the disc contains scenes recorded at different camera angles, you can change to a different camera angle during playback.

During playback, press DISPLAY twice to display the playback menu. Use ▲ ▼ to select the angle option then use ◀ ▶ to select desired angle.

## Selecting a sound mode **DVD ALL** **DivX**

This unit can produce a 3D Surround effect, which simulates multi-channel audio playback from two conventional stereo speakers, instead of the five or more speakers normally required to listen to multi-channel audio from a home theater system.

During playback, press DISPLAY twice to display the playback menu. Use ▲ ▼ to select the sound option then use ◀ ▶ to select desired sound mode (3D SUR. or NORMAL).

## Displaying information while watching TV

During viewing the TV, Press DISPLAY to display the information displayed on-screen.

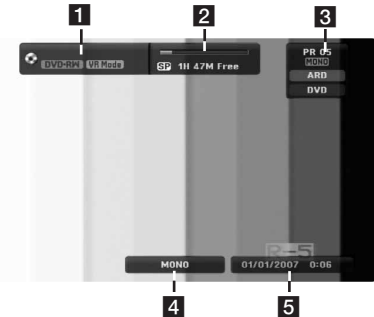

- 1 Indicates disc name and format.
- 2 Indicates the record mode, free space, and elapsed time progress bar.
- 3 Indicates channel number, station name, and audio signal (STEREO, MONO) received by the tuner.
- 4 Indicates current audio channel.
- 5 Indicates current date and time.

## Play a disc

### ON REMOTE

<b>1 Open the disc tray:</b>	<b>OPEN/CLOSE (▲)</b>
<b>2 Insert a disc:</b>	-
<b>3 Close the disc tray:</b>	<b>OPEN/CLOSE (▲)</b>
<b>4 Adjust the disc menu settings:</b> A disc menu may not appear on the screen depending on the disc.	<b>▲ ▼ ◀ ▶</b>
<b>5 Starts playback:</b>	<b>PLAY (▶)</b>
<b>6 Stops playback:</b>	<b>STOP (■)</b>

## Play a disc - more you can do

### Playing a disc that contains a menu **DVD**

The menu screen may be displayed first after loading a DVD which contains a menu.

**DVD** – Use the ◀ / ▶ / ▲ / ▼ buttons to select the title/chapter you want to view, then press ENTER to start playback. Press TITLE or MENU/LIST to return to the menu screen.

### Skip to the next/previous chapter/track/file

**DVD ALL ACD MP3 WMA DivX**

Press SKIP (▶▶) to move to the next chapter/track/file.  
Press SKIP (◀◀) to return to the beginning of the current chapter/track/file.  
Press SKIP (◀◀) twice briefly to step back to the previous chapter/track/file.

### Pause a playback

Press PAUSE/STEP (■) to pause playback. Press PLAY (▶) to continue playback.

### Frame-by-Frame playback **DVD ALL DivX**

Press PAUSE/STEP (■) repeatedly to play Frame-by-Frame playback.

### Fast forward or fast reverse **DVD ALL ACD DivX**

Press SCAN (◀◀ or ▶▶) to play fast forward or fast reverse during playback. You can change the various playback speed by pressing SCAN (◀◀ or ▶▶) repeatedly. Press PLAY (▶) to continue play at normal speed.

### Hearing a different audio **DVD ALL DivX**

Press AUDIO then press ◀ or ▶ repeatedly to hear a different audio language, audio track or encoding method.

### Slow down the playing speed **DVD ALL**

While playback is paused, press SCAN(◀◀ or ▶▶) to slow down forward or reverse playback. You can change the various playback speed by pressing SCAN (◀◀ or ▶▶) repeatedly. Press PLAY (▶) to continue play at normal speed.

### Playing repeatedly **DVD ALL ACD MP3 WMA**

Press PLAY MODE repeatedly to select an item to be repeated. The current title, chapter or track will be played back repeatedly. To return to normal playback, press PLAY MODE repeatedly to select [Off].

### Repeating a specific portion (A-B) **DVD ALL ACD**

Press PLAY MODE to select [A-] at the beginning of the portion you wish to repeat and press ENTER at the end of the portion. Your selected portion will be repeated continually.  
To return to normal playback, press PLAY MODE repeatedly to select [Off].

### Watching a enlarged video image **DVD ALL**

During playback or pause mode, press ZOOM repeatedly to select zoom mode. You can move through the zoomed picture using ▲▼◀▶ buttons. Press CLEAR to exit.

### Marking a favorite scene **DVD ALL**

You can mark positions by pressing MARKER at the desired position up to six markers. Also you can recall or clear positions by pressing SEARCH.  
Use ◀ / ▶ / ▲ / ▼ to select a desired marker, then press ENTER to recall it or CLEAR to clear it.

## Viewing the Title menu **DVD**

Press TITLE to displays the title menu or disc menu. If the current DVD title has a menu, the title menu appears on the screen. Otherwise, the disc menu may appears.

## Last Scene Memory **DVD**

This unit memorizes last scene from the last disc that is viewed. The last scene remains in memory even if you remove the disc from the player or switch off the unit. If you load a disc that has the scene memorized, the scene is automatically recalled.

## Playing DivX® movie files

### ON REMOTE

1 Displays the HOME menu:	HOME
2 Selects a [MOVIE] option:	◀ ▶
3 Selects an option that contains DivX file:	▲ ▼ ENTER
4 Selects a movie file from the menu:	▲ ▼
5 Plays the selected movie file:	PLAY
6 Stops the playback:	STOP

## Playing a DivX® movie files - more you can do

### Movie List menu options

Select which file you would like to show menu and press ENTER. An options menu appear on the left side of the screen.



[Play]: Starts playback the selected file.

[Open]: Opens the folder and a list of files in the folder appears.

## Notice for displaying DivX® subtitle

If the subtitle does not display properly, press PAUSE/STEP when the subtitle appears. Then press and hold SUBTITLE about 3 seconds to display the language code menu. Use ◀ / ▶ to change the language code until the subtitle is displayed properly. Press PLAY (▶) to continue playback.

## Displaying movie file information

Press DISPLAY while the file you want to show the file information is selected. The unit shows the various kind of file information on the screen.

## Divx file requirement

**Available resolution size:** 720x576 (W x H) pixel

**DivX file extensions:** “.avi”, “.divx”

**Playable DivX subtitle:** “.smi”, “.srt”, “.sub (Micro DVD format only)”, “.txt (Micro DVD format only)”

**Playable Codec format:** “DIV3”, “MP43”, “DIVX”, “DX50”

**Playable Audio format:** “AC3”, “PCM”, “MP2”, “MP3”, “WMA”

Sampling frequency: within 8-48 kHz (MP3), within 32-48kHz (WMA)

Bit rate: within 8 - 320kbps (MP3), within 32 - 192kbps (WMA)

**CD-R Format:** ISO 9660 and JOLIET.

**DVD±R/RW Format:** ISO 9660 (UDF Bridge format)

**Maximum Files/Folder:** Less than 650

## Notes on DivX format

- The DivX subtitle file name has to be identified with the DivX file name to be display on the unit.
- If the number of the screen frame is over 29.97 frames per second, this unit may not operate normally.
- If the video and audio structure of DivX file is not interleaved, returns to the menu screen.
- If there is impossible code to express in the DivX file name, it may be displayed as “\_” mark.
- This unit does not support the DivX file that is recorded with GMC (Global Motion Compensation).
- If a bitrate of DivX file on the USB is over 4Mbps, the file may not be played properly.

## Listening to a music

### ON REMOTE

1 Displays the HOME menu:	HOME
2 Select a [MUSIC] option:	◀▶
3 Selects an option that contains music:	▲▼ ENTER
4 Selects a music from the menu:	▲▶◀▶
5 Plays the selected music:	PLAY
6 Stops the playback:	STOP

## Listening to a music - more you can do

### Music List menu options

Select which file/track you would like to show menu and press ENTER. A menu appears on the left side of the screen.



Audio CD



MP3/WMA

[Play]: Starts playback the selected file/track.

[Random]: Starts or stops random playback.

[Open]: Opens the folder and a list of files in the folder appears.

### Playing musics in random order

When you select the [RANDOM] option on the Music List menu then press ENTER, the unit automatically begins random playback and "RANDOM" appears on the menu screen. To return to normal playback, select [Random] option again then press ENTER.

### Displaying MP3/WMA file information

Press DISPLAY while the file you want to show the file information is selected. The unit shows the ID3-Tag information of the file. If the file does not have ID3-Tag information, [ID3-Tag: None] appears on the screen.

### MP3/WMA audio file requirement

**File extensions:** ".mp3", ".wma".

**Sampling frequency:** within 8 - 48 kHz (MP3), within 32 - 48kHz (WMA)

**Bit rate:** within 8 - 320kbps (MP3), within 32 - 192kbps (WMA)

**CD-R Format:** ISO 9660 and JOLIET.

**DVD±R/RW Format:** ISO 9660 (UDF Bridge format)

**Maximum Files/Disc:** Less than 650 (total number of files and folders)

## Viewing a photo

### ON REMOTE

1 Displays the HOME menu:	HOME
2 Selects a [PHOTO] option:	◀▶
3 Selects an option that contains photo file:	▲▼ ENTER
4 Selects a photo from the menu:	▲▼◀▶
5 Displays the selected photo in full screen:	PLAY
6 Returns to the Photo List:	STOP

## Viewing a photo - more you can do

### Photo List menu options

Select which file/track you would like to show menu and press ENTER. A menu appears on the left side of the screen.



[Full Screen]: Shows the selected file in full screen.

[Open]: Opens the folder and a list of files in the folder appears.

[Slide Show]: Displays the [Slide Show] menu.

### Skip to the next/previous photo

Press SKIP (I◀◀ or ▶▶I) to view the previous/next photo while displayed in full screen.

### Rotate a photo

Use ▲▼ to rotate the photo while displayed in full screen.

## Viewing photo files as a slide show

To slide show photos in the [Photo list], select the [Slide Show] option on the left side of the screen then press ENTER. The [Slide Show] menu appears on the screen. Set the [Object] and [Speed] options then press ENTER while [Start] option is selected. The unit starts slide show as you set on the menu.

[Object] option:

- [Selected] Views slide show only selected files.  
Use the MARKER button to select multiple files.
- [All] Views slide show all files.

[Speed] option:

Sets the Slide Show speed to [Slow], [Normal], or [Fast].

### Pause a slide show

Press PAUSE/STEP to pause a slide show. Press PLAY to continue the slide show.

### Photo file requirement

**File extension:** “.jpg”

**Photo size:** Less than 4MB recommended

**CD-R Format:** ISO 9660 and JOLIET.

**DVD±R/RW Format:** ISO 9660 (UDF Bridge format)

**Maximum Files/Disc:** Less than 650 (total number of files and folders)

### Notes on JPEG file

- Progressive and lossless compression JPEG image files are not supported.
- Depending on the size and number of the JPEG files, it may take several minutes to read the contents of the media.

## Recording

Follow the instruction below to record a TV channel or other source. The recording continues until the media is full or you stop the recording.

### ON REMOTE

<b>1 Selects a recording mode:</b> You can select a recording mode on the SETUP menu. (XP, SP, LP, EP or MLP)	<b>HOME</b> ▲▼◀▶ <b>ENTER</b>
<b>2 Selects a channel or source you want to record:</b>	<b>PR(+, -) or AV/INPUT</b>
<b>3 Starts recording:</b>	<b>REC</b>
<b>4 Stops recording:</b>	<b>STOP</b>

## Recording - more you can do

### Instant timer recording

Instant timer recording allow you to make a recording of preset length easily.

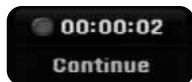

When the REC is first pressed, recording starts. Press REC repeatedly to select a certain amount of time. Each press of REC displays the increased recording time on-screen. You can set the instant timer recording within the free space available.

### To Pause the Recording

Press PAUSE/STEP to pause recording. When you want to continue recording, press PAUSE/STEP.

### Setting a timer record

This unit can be programmed to record up to 16 timer recording within a month. The clock must be set correctly before setting a timer record.



Press HOME and select TV option. Press ▲▼ to select the [Timer Record] and press ENTER to display [Timer record List] menu. Use ▲▼ to select [New] and press ENTER to display [Timer Record] menu. Adjust the each field using ▲▼◀▶.

[PR]: Choose a memorized program number, or one of the external inputs from which to record. (You cannot select DV input.)

[Date]: Choose a date up to 1 month in advance.

[Start Time]: Set the start time.

[End Time]: Set the end time.

[Mode]: Choose a record mode (XP, SP, LP, EP, MLP or AT).

AT (Auto) mode determines how much time is available on the disc and switches record mode, if necessary, to complete recording the program.

Press ENTER to set a timer recording. The “Rec OK” on the [Check] field on the [Timer Record List] menu indicates the timer recording is programmed correctly.



### Canceling a timer record

You can cancel a timer record before the timer recording actually starts. Select a timer recording that you want to cancel on the [Timer Record List] menu and press CLEAR to confirm.



## Timer Recording Troubleshooting

Even though the timer is set, the unit will not record when:

- There is no disc loaded.
- A non-recordable disc is loaded.
- [Disc Protect] option is set to [ON] in the Setup menu (see page 18).
- The unit is in operating (recording, deleting etc.).
- There are already 99 titles (DVD-RW, DVD-R), 49 titles (DVD+R, DVD+RW) recorded on the disc.

You cannot enter a timer program when:

- A recording is already underway.
- The time you're trying to set has already passed.
- There are already 16 timer programs set.

If two or more timer programs overlap:

- The earlier program takes priority.
- When the earlier program finishes, the later program starts.
- If two programs are set to start at exactly the same time, the program entered first takes priority.

## Recording From an external inputs

You can record from an external component, such as a camcorder or VCR, connected to any of the recorder's external inputs.

Each press of the AV/INPUT changes the input source as described below.

Make sure that the component you want to record from is connected properly to the unit before recording an external source.

- Tuner: Built-in tuner
- AV1: AV1 scart jack mounted on back panel
- AV2: AV2 DECODER scart jack mounted on back panel
- AV3: AV IN 3 (VIDEO, AUDIO (L/R)) mounted on the front panel

## Editing a title

Using the Title list menu, you can edit video contents.

	ON REMOTE
1 Selects a recording media:	DVD
2 Displays a [Title List] menu:	MENU/LIST
3 Selects a title you want to edit:	▲▼◀▶
4 Displays an editing menu: The options are differ depending on the media type.	ENTER
5 Selects a menu option:	▲▼◀▶, ENTER
6 Exit the [Title List] menu:	RETURN

## Editing a title - more you can do

### About title list menu

Press MENU/LIST to display the Title List menu. Playback should be stopped when you do this. You can also access it using HOME menu, select [MOVIE] option then select [DISC] option and press ENTER. If you are editing a VR mode disc, press MENU/LIST to switch between Original and Playlist menu.



- 1 Current media
- 2 Indicates the record mode, free space, and elapsed time progress bar.
- 3 Menu options: To display menu option, select a title or chapter then press ENTER. The options displayed differ depending on the disc type.
- 4 Currently selected title.
- 5 Thumbnail
- 6 Shows the title name, recorded date, and recording length.

## Before editing

This unit offers various edit options for various disc types. Before you edit, check the disc type, and select the option available for your disc.

You can enjoy advanced edit functions with VR mode formatted DVD (DVD-RW). Editing either the original recording (called the “original”), or the playback information created from the original (called a “Playlist”). Edits made to the original titles are final. If you plan to edit a title without editing the original title, you can create a Playlist title for editing. A Playlist is a group of Playlist titles created from the original title for editing purpose.

Titles in the disc’s original content contain one or more chapters. When you insert a disc’s title into the Playlist, all the chapters within that title also appear. In other words, chapters in the Playlist behave exactly as chapters on a DVD-Video disc do. Parts are sections of Original or Playlist titles. From the Original and Playlist menu you can add or delete parts. Adding a chapter or title to the Playlist creates a new title made up of a section (ie., chapter) of an Original title. Deleting a part removes part of a title from the Original or Playlist menu.

## Adding chapter markers **-RWvR** **+RW** **+R**

You can create chapters within a title by inserting chapter marks at the desired point. Press CHP.ADD at the desired point while playback or recording. A chapter marker icon appears on the screen.

The chapter markers can be added at regular interval automatically by setting the [Auto Chapter] option in the SETUP menu.

## Changing the thumbnail **-RWvR** **+RW** **+R**

Each title displayed in the Title List menu is represented by a thumbnail picture taken from the start of that title or chapter. Press THUMBNAIL to make the currently displayed picture that appears in the Title List menu.

## Deleting a title or chapter

When you delete a title or chapter from the Playlist, the title or chapter in the Original still remains. However, if you delete a chapter or title from Original, the title or chapter deleted from the Original are also removed from Playlist.

Select a title or chapter that you want to delete and press ENTER. Select [Delete] option from the menu on the left of the screen and press ENTER to confirm

## Chapter search **-RWvR** **-RWVideo** **+RW** **+R** **-R**

You can select the start of a title by searching a chapter. Select a title that you want to search and press ENTER. Select [Chapter] in the [Search] option from the menu on the left of the screen, and press ENTER to display the [Chapter List] menu.

Use **▲▼◀▶** to find the chapter you want to start playback, and press PLAY to start playback.

## Making a new PlayList **-RWvR**

The Playlist allow you to edit or re-edit a title or chapter without changing the Original recordings. Use this function to add an Original title or chapter to a new Playlist or the registered Playlist.



Select an Original title or chapter that you want to put into the Playlist then press ENTER. Select the [Playlist Add] option and then press ENTER to display the [Select Playlist] menu. Choose a Playlist-title that you want to put the selected Original title or chapter or select the [New Playlist] to create a new Playlist.

## Moving a PlayList chapter **-RWvR**

Use this function to re-arrange the playing order of a Playlist title on the [Chapter List-Playlist] menu. Select [Move] option from the menu on the left of the [Chapter List-Playlist] screen and press ENTER. Use **▲▼◀▶** to choose the place you want to move the chapter then press ENTER. The updated menu is displayed

## Time search **-RWvR** **-RWVideo** **+RW** **+R** **-R**

You can select the start of a title by searching time. Select a title that you want to search and press ENTER. Select [Time] in the [Search] option from the menu on the left of the screen and press ENTER to display the [Search] menu.



Use ◀▶ to find the time you want to start. Each press of ◀▶ to moves 1 minute and press and hold ◀▶ to moves 5 minutes. Press ENTER to watch a title from a selected time.

## Hiding a chapter or title **+RW** **+R**

You can skip through playing chapters or titles without actually deleting them. Select a chapter or title you want to hide and press ENTER. Select [Hide] in the [Edit] option then press ENTER.

If you want to recover the hidden title or chapter, select the hidden title or chapter and press ENTER. Select [Show] in the [Edit] option then press ENTER to recover it.

## Deleting a part **-RWvR**

You can delete a part which you do not want in the title.



Select a title that you want to delete part and press ENTER. Select [Delete Part] in the [Edit] option from the menu on the left of the screen and press ENTER to display the [Delete part] menu. You can find the point using PLAY, SCAN, PAUSE/STEP buttons.

[Start Point]: Select starting point of a part that you want to delete then press ENTER.

[End Point]: Select ending point of a part that you want to delete then press ENTER.

[Cancel]: Press ENTER to cancel the selected part.

[Done]: Press ENTER to delete the selected part.

## Dividing a title **+RW**

Use this function to split a title up into two titles. Select a title that you want to divide and press ENTER. Select [Divide] in the [Edit] option from the menu on the left of the screen and press ENTER to display the [Divide] menu. Find the point you want to divide a title using PLAY, SCAN, PAUSE/STEP buttons and press ENTER while [Divide] option is selected. The playback screen shows the divided point. Select [Done] option and press ENTER to divide.

## Naming a title

When a title is recorded by this unit, the title name will be named by a number. You can change a title name by using this function.



Select a title that you want to change a name and press ENTER. Select [Title Name] option from the menu on the left of the screen and press ENTER to display the keyboard menu. Use ▲▼◀▶ to select a character then press ENTER to confirm your selection on the keyboard menu.

[OK]: Finish the naming.

[Cancel]: Cancels all entered characters.

[Space]: Inserts a space at the cursor position.

[Delete]: Deletes the previous character at the cursor position.

You can use remote control buttons for entering a name

PLAY (▶): Inserts a space at the cursor position.

|| (PAUSE/STEP): Deletes the after character at the cursor position.

■ (STOP), CLEAR: Deletes the previous character at the cursor position.

◀◀ / ▶▶: Moves cursor to left or right.

MENU/LIST, DISPLAY: Changes the character set on the keyboard menu.

Numbers (0-9): Enters the corresponding character at the cursor position.

## Combining chapters **-RWvR** **+RW** **+R**

Use this function to merge the selected chapter with adjacent chapter. Select a chapter and press ENTER. Select [Combine] option to views combine indicator between chapter thumbnails. Press ENTER to combine indicated two chapters.

This function is not available in conditions as listed below.

- There is only one chapter within the title.
- The first chapter is selected.
- The chapters that you want to combine are created by deleting a part from an Original title.
- The chapters that you want to combine are created from different titles.
- One of the playlist chapter that you want to combine has been moved.

## Protect a title **-RWvR** **+RW** **+R**

Use this function to protect a title against accidental recording, editing or deleting. Select a title you want to protect and press ENTER. Select [Protect] option from the menu on the left and press ENTER. The lock mark will appears on the title thumbnail.

If you want to unprotect the title, select the protected title and press ENTER. Select [Unprotect] option from the menu on the left and press ENTER to unprotect it.

## Overwriting **+RW**

You can overwrite a new video recording on a recorded title that is not protected. Select the TV channel or input source you want to record. Press MENU/LIST to display the Title List menu. Use ▲▼◀▶ to highlights a title you want to overwrite and then press REC to start overwrite. To stop the recording, press STOP.

If you overwrite the longer recording than the current title on the fully recorded disc, the next title is overwritten. If next title is protected, the overwriting stops at the starting point of the title.

## Language Codes

Use this list to input your desired language for the following initial settings: Disc Audio, Disc Subtitle, Disc Menu.

Language	Code	Language	Code	Language	Code	Language	Code	Language	Code		
Afar	6565	Croatian	7282	Hausa	7265	Lingala	7678	Quechua	8185	Tajik	8471
Afrikaans	6570	Czech	6783	Hebrew	7387	Lithuanian	7684	Rhaeto-Romance	8277	Tamil	8465
Albanian	8381	Danish	6865	Hindi	7273	Macedonian	7775	Rumanian	8279	Telugu	8469
Ameharic	6577	Dutch	7876	Hungarian	7285	Malagasy	7771	Russian	8285	Thai	8472
Arabic	6582	English	6978	Icelandic	7383	Malay	7783	Samoan	8377	Tonga	8479
Armenian	7289	Esperanto	6979	Indonesian	7378	Malayalam	7776	Sanskrit	8365	Turkish	8482
Assamese	6583	Estonian	6984	Interlingua	7365	Maori	7773	Scots Gaelic	7168	Turkmen	8475
Aymara	6588	Faroese	7079	Irish	7165	Marathi	7782	Serbian	8382	Twì	8487
Azerbaijani	6590	Fiji	7074	Italian	7384	Moldavian	7779	Serbo-Croatian	8372	Ukrainian	8575
Bashkir	6665	Finnish	7073	Javanese	7487	Mongolian	7778	Shona	8378	Urdu	8582
Basque	6985	French	7082	Kannada	7578	Nauru	7865	Sindhi	8368	Uzbek	8590
Bengali; Bangla	6678	Frisian	7089	Kashmiri	7583	Nepali	7869	Singhalese	8373	Vietnamese	8673
Bhutani	6890	Galician	7176	Kazakh	7575	Norwegian	7879	Slovak	8375	Volapük	8679
Bihari	6672	Georgian	7565	Kirghiz	7589	Oriya	7982	Slovenian	8376	Welsh	6789
Breton	6682	German	6869	Korean	7579	Panjabi	8065	Spanish	6983	Wolof	8779
Bulgarian	6671	Greek	6976	Kurdish	7585	Pashto, Pushto	8083	Sudanese	8385	Xhosa	8872
Burmese	7789	Greenlandic	7576	Laotian	7679	Persian	7065	Swahili	8387	Yiddish	7473
Byelorussian	6669	Guarani	7178	Latin	7665	Polish	8076	Swedish	8386	Yoruba	8979
Chinese	9072	Gujarati	7185	Latvian, Lettish	7686	Portuguese	8084	Tagalog	8476	Zulu	9085

## Area Codes

Choose an area code from this list.

Area	Code	Area	Code	Area	Code	Area	Code	Area	Code	Area	Code
Afghanistan	AF	Costa Rica	CR	Greenland	GL	Maldives	MV	Paraguay	PY	Sri Lanka	LK
Argentina	AR	Croatia	HR	Hong Kong	HK	Mexico	MX	Philippines	PH	Sweden	SE
Australia	AU	Czech Republic	CZ	Hungary	HU	Monaco	MC	Poland	PL	Switzerland	CH
Austria	AT	Denmark	DK	India	IN	Mongolia	MN	Portugal	PT	Taiwan	TW
Belgium	BE	Ecuador	EC	Indonesia	ID	Morocco	MA	Romania	RO	Thailand	TH
Bhutan	BT	Egypt	EG	Israel	IL	Nepal	NP	Russian Federation	RU	Turkey	TR
Bolivia	BO	El Salvador	SV	Italy	IT	Netherlands	NL	Saudi Arabia	SA	Uganda	UG
Brazil	BR	Ethiopia	ET	Jamaica	JM	Netherlands Antilles	AN	Senegal	SN	Ukraine	UA
Cambodia	KH	Fiji	FJ	Japan	JP	New Zealand	NZ	Singapore	SG	United States	US
Canada	CA	Finland	FI	Kenya	KE	Nigeria	NG	Slovak Republic	SK	Uruguay	UY
Chile	CL	France	FR	Kuwait	KW	Norway	NO	Slovenia	SI	Uzbekistan	UZ
China	CN	Germany	DE	Libya	LY	Oman	OM	South Africa	ZA	Vietnam	VN
Colombia	CO	Great Britain	GB	Luxembourg	LU	Pakistan	PK	South Korea	KR	Zimbabwe	ZW
Congo	CG	Greece	GR	Malaysia	MY	Panama	PA	Spain	ES		

# Troubleshooting

## General

---

### The power does not turned on.

- ➔ Plug the power cord into the wall outlet securely.

### There is no picture.

- ➔ Select the appropriate video input mode on the TV so the picture from the unit appears on the TV screen.
- ➔ Connect the video connection securely.
- ➔ Check the [Video Output Format] in SETUP menu is set to the appropriate item that conforms to your video connection.

### Picture noise appears.

- ➔ You are playing a disc recorded in a color system that is different from your TV.
- ➔ The video signal from the external component is copy-protected.
- ➔ Set the resolution that your TV can accept.

### The channel is not found or stored.

- ➔ Check your antenna connection.

### There is no sound.

- ➔ Connect the audio connection securely.
- ➔ The input source setting on the amplifier or the connection to the amplifier is incorrect.
- ➔ The unit is in scan, slow motion, or pause mode.

### The remote control does not work properly.

- ➔ The remote control is not pointed at the remote sensor of the unit.
- ➔ The remote control is too far from the unit.
- ➔ There is an obstacle in the path of the remote control and the unit.
- ➔ The batteries in the remote control are exhausted.

## Playback

---

### The unit does not start playback.

- ➔ Insert a playable disc. (Check the disc type, color system, and regional code.)
- ➔ Place the disc with the playback side down.
- ➔ Place the disc on the disc tray correctly inside the guide.
- ➔ Clean the disc.

- ➔ Cancel the Rating function or change the rating level.

### Cannot play a disc recorded using this unit on other player.

- ➔ Finalize the disc.
- ➔ Check the disc compatibility of the player.
- ➔ Place the disc on the disc tray correctly inside the guide.
- ➔ Discs recorded with copy-once material cannot be played on other players.

### The angle cannot be changed.

- ➔ Multi-angles are not recorded on the DVD Video being played.
- ➔ The angle cannot be changed for the titles recorded on this unit.

### The subtitle language cannot be changed or turned off.

- ➔ Subtitles are not recorded on the DVD Video being played.
- ➔ The subtitle cannot be changed for the titles recorded on this unit.

### Cannot play MP3/WMA/JPEG/DivX files.

- ➔ The files are not recorded in a format that the unit can play.
- ➔ The unit does not support the codec of the DivX movie file.
- ➔ The resolution is higher than the unit can support.

## Recording

---

### Cannot record or does not record successfully.

- ➔ Check the remaining space on the disc.
- ➔ Check that the source you are trying to record in not copy protected.
- ➔ The power may have failed during recording.
- ➔ Use a VR mode formatted disc for copy-once material.

### Timer record does not record successfully.

- ➔ Clock is not set to correct time.
- ➔ The start time of the timer recording is past.
- ➔ Two timer recordings may have overlapped, in which case only the earlier one will record completely.
- ➔ When setting the recording channel, make sure you set the unit's built-in tuner, not the TV's built-in tuner.

**Stereo Audio Record and/or Playback is not present.**

- ➔ TV is not Stereo-compatible.
- ➔ Broadcast program is not in stereo format.
- ➔ The A/V Output jacks on the unit are not connected to TV A/V In jacks.

**Resetting the unit**

**If you observe any of the following symptoms.**

- The unit is plugged in, but the power will not turn on or off.
- The front panel display is not working.
- The unit is not operating normally.

**You can reset the unit as follows.**

- Press and hold the POWER button for at least five seconds. This will force the unit to power off then turn the unit back on.
- Unplug the power cord, wait at least five seconds, and then plug it in again.

# Specifications

## General

---

Power requirements	AC 200-240V, 50/60 Hz
Power consumption	15W
Dimensions (approx.)	430 X 49 X 245 mm (w x h x d) without foot
Net weight (approx.)	2.5 kg
Operating temperature	5°C to 35°C
Operating humidity	5 % to 65 %
Television system	PAL I, B/G, I/I, SECAM D/K, K1 color system
Recording format	PAL

## Recording

---

Recording format	DVD Video Recording, DVD-VIDEO
Recordable media	DVD-RW, DVD-R, DVD+RW, DVD+R
Recordable time	DVD (4.7GB): Approx. 1 hour (XP mode), 2 hours (SP mode), 4 hours (LP mode), 6 hours (EP mode), 14 hours (MLP mode)

## Video recording format

Sampling frequency	27MHz
Compression format	MPEG2 (VBR supported)

## Audio recording format

Sampling frequency	48kHz
Compression format	Dolby Digital

## Playback

---

Frequency response	DVD (PCM 48 kHz): 8 Hz to 22 kHz, CD: 8 Hz to 20 kHz DVD (PCM 96 kHz): 8 Hz to 44 kHz
Signal-to-noise ratio	More than 100 dB (AUDIO OUT connector)
Harmonic distortion	Less than 0.008% (AUDIO OUT connector)

## Inputs

---

Dynamic range	More than 95 dB (AUDIO OUT connector)
ANTENNA IN	Antenna input, 75 ohms
VIDEO IN	1.0 V <sub>p-p</sub> 75 ohms, sync negative, RCA jack x 1 / SCART x 2
AUDIO IN	2.0 V <sub>rms</sub> more than 47 kohms, RCA jack (L, R) x 1 / SCART x 2
DV IN	4 pin (IEEE 1394 standard)
USB IN	4 pin (USB 1.1 standard)

## Outputs

---

VIDEO OUT	1 V <sub>p-p</sub> 75 Ω, sync negative, SCART x 2
S-VIDEO OUT	(Y) 1.0 V (p-p), 75 Ω, sync negative, Mini DIN 4-pin x 1(C) 0.3 V (p-p) 75 Ω
COMPONENT VIDEO OUT	(Y) 1.0 V (p-p), 75 Ω, sync negative, RCA jack x 1, (PB)/(PR) 0.7 V (p-p), 75 Ω, RCA jack x 2
Audio output (digital audio)	0.5 V (p-p), 75 Ω, RCA jack x 1
Audio output (optical audio)	3 V (p-p), Optical connector x 1
Audio output (analog audio)	2 V <sub>rms</sub> (1 kHz, 0 dB), 600 Ω, RCA jack (L, R) x 1/ SCART x 2

## Accessories

---

RF cable (1), Remote control (1), Batteries (1)