



website <http://www.lgservice.com>

LG

ENGLISH

LG

Room Air Conditioner

OWNER'S MANUAL

MODELS : S4/S5 CHASSIS

Prior to installation, this air-conditioning unit must be submitted for approval by the utility service which provides electricity (EN 61000-2, EN 61000-3 Norm).

IMPORTANT

- Please read this owner's manual carefully and thoroughly before installing and operating your room air conditioner.
- Please retain this owner's manual for future reference after reading it thoroughly.

Safety Precautions

Warning2
 Caution3

Operating Instructions

Preparation before operation ..4
 Remote Control Features5
 Operation Mode Selection6
 Additional features10

Care and Maintenance

Care and Maintenance12
 Operation Tips14

Troubleshooting tips

Before You
 Call For Service15

Safety precautions

To prevent injury and property damage, follow these instructions.

 Incorrect operation due to ignoring instructions will cause harm or damage, the seriousness of which is indicated by the following symbols.

WARNING

This symbol shows the possibility of death or serious injury.

CAUTION

This symbol indicates the possibility of injury or damage to property.

■ The following items are classified by these symbols.

	Never Do This
	Always Do This

WARNING

 **Plug in the power plug properly.**

• Otherwise, it will cause electric shock or fire due to heat generation or electric shock.

 **Do not operate or stop the unit by inserting or pulling out the power plug.**

• It will cause electric shock or fire due to heat generation.

 **Do not damage or use an unspecified power cord.**

• It will cause electric shock or fire.
 • In the supply cord is damaged, it must be replaced by the manufacturer or its service agent or a similarly qualified person in order to avoid a hazard. (Y Attachment)

 **Do not modify power cord length or share the outlet with other appliances.**

• It will cause electric shock or fire due to heat generation.

 **Do not operate with wet hands or in damp environment.**

• It may cause electric shock.

 **Do not direct airflow at room occupants only.**

• This could damage your health.

 **Always perform grounding work.**

• No grounding may cause electric shock.

 **Do not allow water to run into electric parts.**

• It may cause failure of machine or electric shock.

 **Always install air leakage breaker and a dedicated switching board.**

• No installation may cause fire and electric shock accident.

 **Unplug the unit if strange sounds, smell, or smoke comes from it.**

• It may cause fire and electric shock accident.

 **Do not use the socket if it is loose or damaged.**

• It may cause fire and electric shock.

 **Do not open the entrance during operation.**

• It may cause electric shock.

 **Keep firearms away.**

• It may cause fire.

 **Do not use the power cord close to the heating tools.**

• It may cause fire and electric shock.

 **Do not use the power cord near flammable gas or combustibles, such as gasoline, benzene, thinner, etc.**

• It may cause an explosion or fire.

WARNING

⚠ **Ventilate before operating air conditioner when gas goes out.**

• It may cause explosion, fire and, burn.

⚠ **Do not disassemble or modify products randomly.**

• It may cause failure and electric shock.

CAUTION

⚠ **Never touch the metal parts of the unit when removing the filter.**

• They are sharp and may cause injury.

⚠ **Do not clean the air conditioner with water.**

• Water may enter the unit and degrade the insulation. It may cause an electric shock.

⚠ **Ventilate well when used together with a stove, etc.**

• An oxygen shortage may occur.

⚠ **When cleaning the unit, first make sure the power and breaker are turned off.**

• Since the fan rotates at high speed during operation, it may cause injury.

⚠ **Do not put a pet or house plant where it will be exposed to direct air flow.**

• This could injure the pet or plant.

⚠ **Do not use appliance for special purpose such as animals or vegetables, precision machine, or conservation of art articles.**

• It may cause damage of animals or vegetables or loss of property.

⚠ **Stop operation and close the window in storm or hurricane.**

• Operation with windows opened may cause wetting of indoor and soaking of household furniture.

⚠ **Hold the plug by the head of the power plug when taking it out.**

• It may cause electric shock and damage.

⚠ **Turn off the main power switch when not using it for a long time.**

• It may cause failure of product or fire.

⚠ **Do not place obstacles around the absorption inlet or instead of blowing-out inlet.**

• It may cause failure of appliance or accident.

⚠ **Ensure that an installation console of the outdoor appliance is not damaged due to the use for a long time.**

• If leaving appliance damaged, there is concern of damage due to the falling of product.

⚠ **Always insert the filters securely. Clean it once every two weeks.**

• Operation without filters may cause failure.

⚠ **Do not use strong detergent such as wax or thinner but use a soft cloth.**

• Appearance may be deteriorated due to change of product color or scratching of its surface.

⚠ **Do not place heavy object on the power cord and take care so that the cord should not be pressed.**

• There is danger of fire or electric shock.

⚠ **Do not drink water drained from air conditioner.**

• It contains contaminants and will make you sick.

⚠ **Use caution when unpacking and installing. Sharp edges could cause injury.**

⚠ **If water enters the product, turn the power switch of the main body of appliance off. After taking the power-plug out from the socket, contact with the service center.**

Preparation before operation

How to Insert the Batteries

- 1 Remove the battery cover by pulling it according to the arrow direction.
- 2 Insert new batteries making sure that the (+) and (-) of battery are installed correctly.
- 3 Reattach the cover by sliding it back into position.

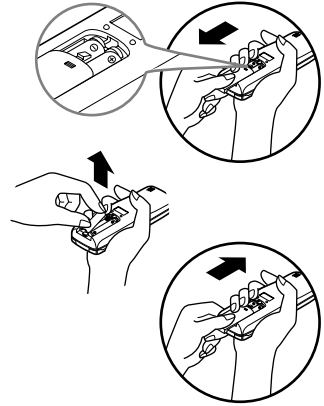

NOTES:

- Use 2 AAA(1.5volt) batteries. Do not use rechargeable batteries.

Storage and Tips For Using the Remote Control

- The remote control may be stored by mounting it on a wall.
- To operate the room air conditioner, aim the remote control at the signal receptor.

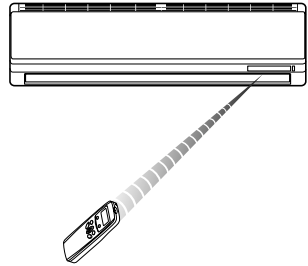
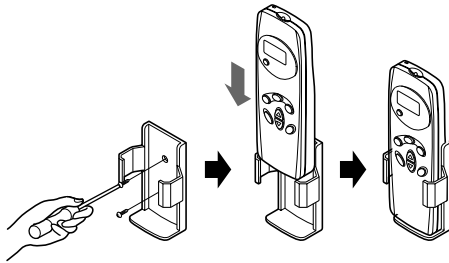

Signal Receptor

Receives the signals from the remote control.(Signal receiving sound: two short beeps or one long beep.)

Operation Indication Lamps

- Ⓛ On/Off : Lights up during the system operation.
- ⌚ Timer : Lights up during Timer operation.
- OUT DOOR** OUTDOOR UNIT OPERATION : Lights up during outdoor unit operation. (Cooling model only)

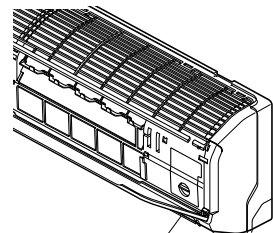

Operation indicating lamps

About the remote control on the system



Features of the Remote Control

Signal transmitter

Transmits the signals to the room air conditioner.

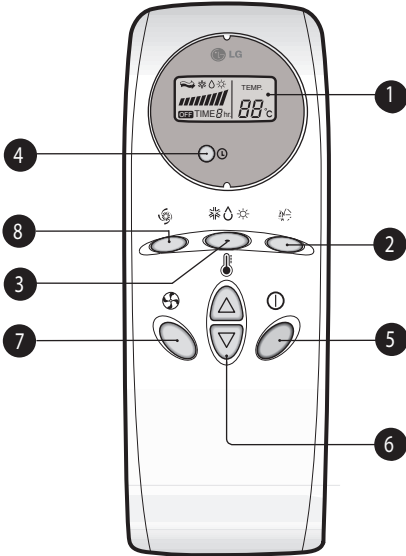

- 1 OPERATION DISPLAY**
Displays the operation conditions.
- 2 AIRFLOW DIRECTION START/STOP BUTTON**
Used to stop or start louver movement and set the desired up/down airflow direction.
- 3 OPERATION MODE SELECTION BUTTON**
Used to select the operation mode.
- 4 OFF TIMER BUTTON**
Used to set the time of stopping operation.
- 5 START/STOP BUTTON**
Operation starts when this button is pressed, and stops when the button is pressed again.
- 6 ROOM TEMPERATURE SETTING BUTTONS**
- 7 INDOOR FAN SPEED SELECTION BUTTON**
- 8 JET COOL OPERATION BUTTON**
Used to start or stop the speed (speed cooling operates super high fan speed in cooling mode.)

(1) OPERATION MODE

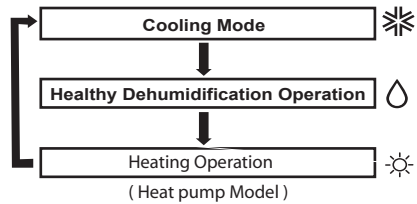
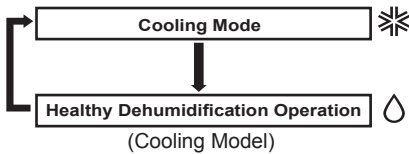

(2) OPERATION PROCEDURE

- 1st Start/Stop Button**
- 2nd Operation Mode Selection Button**
- 3rd Room Temperature Setting Button**
- 4th Indoor Fan Speed Selection Button**

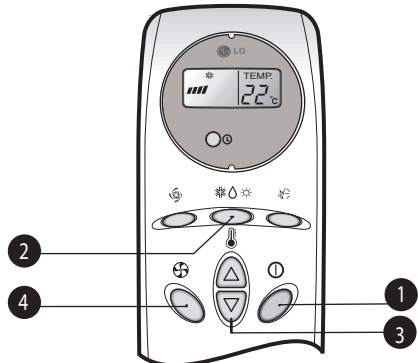

How to use the Operation Mode Selection button



Cooling Operation

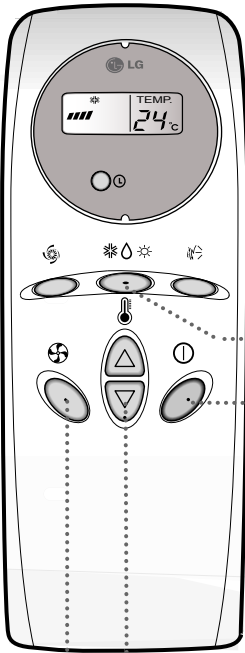

1 Press the Start/Stop button.
The unit will respond with a beep.

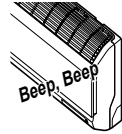

2 Selection Cooling Operation.
Press the Operation Mode Selection Button.
Each time the button is pressed, the operation mode is shifted in the arrow direction.

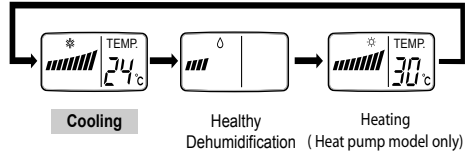

3 Set the temperature lower than the room temperature.
• The temperature can be set within a range of 18°C ~ 30°C by 1°C .

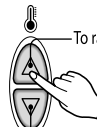

— To raise the temperature

— To lower the temperature

4 Set the fan speed.



- Select the fan speed in four steps
- Low , Medium High and chaos.
- The display shows high fan speed



Heating Operation (Heat pump only)

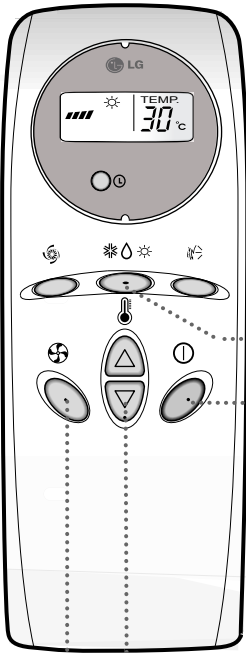

1 Press the Start/Stop button.
The unit will respond with a beep.

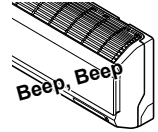

2 Selection Cooling Operation.
Press the Operation Mode Selection Button.
Each time the button is pressed, the operation mode is shifted in the arrow direction.

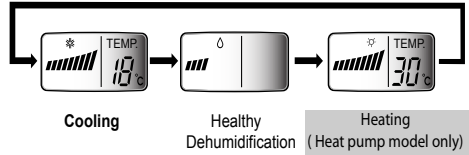

3 Set the temperature lower than the room temperature.
• The temperature can be set within a range of 16°C ~ 30°C by 1°C.

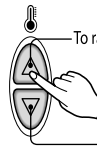

— To raise the temperature

— To lower the temperature

4 Set the fan speed.



- Select the fan speed in four steps
- Low , Medium High and chaos.
- The display shows high fan speed



Healthy Dehumidification Operation

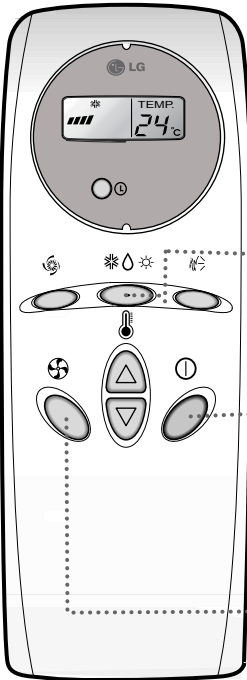

- 1** Press the Start/Stop button. The unit will respond with a beep.

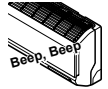

- 2** Select Healthy Dehumidification Operation.

Press the operation Mode Selection Button. Each time the button is pressed, the operation mode is shifted in the arrow direction.

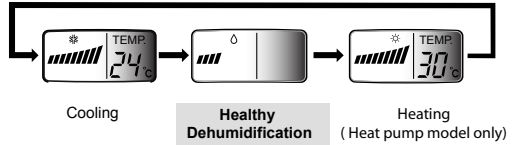

- 3** Set the fan speed.



- Select the fan speed in four steps
 - Low, Medium, High and chaos.
- The display shows high fan speed

During Healthy Dehumidification Operation:

- The indoor fan speed is automatically set to the low, so the shift of the indoor fan speed is impossible because of already being set to the best speed for Dry Operation by Micom Control.
- The indoor fan may be stopped not so as to be the room overcooling.



Jet Cool Operation

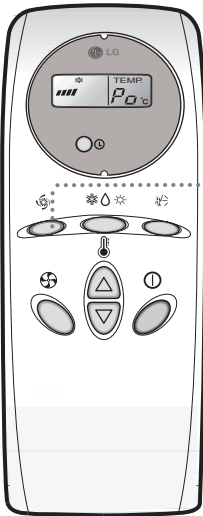

Press the **Jet Cool** button to operate the speed cooling mode and the unit will operate at super high fan speed on cooling mode for 30 minutes.



To cancel the **Jet Cool** mode, press the **Jet Cool** button, the fan speed button or the room temperature setting button again and the unit will operate at high fan speed on cooling mode.



Timer Control Setting

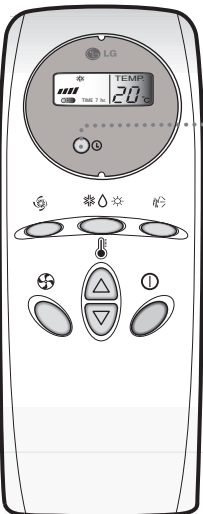

Press the OFF Time Button.

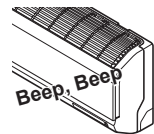

1. Press the OFF Time Button.
2. Check the OFF Time LED of the room air conditioner.
3. The Timer is programmed by 1 hour each pressing the OFF Time button from 1 hour to 7 hours.
(Step Fan operation low speed)



Additional features



Vertical Airflow Direction Control

Airflow Direction Control

The airflow direction can be adjusted as desired by using the remote controller. This is effective when you want to cool yourself directly, such as after taking a bath.

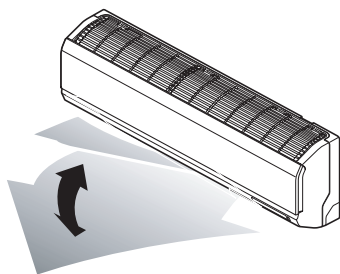

- 1 Press the Start/Stop Button.
(Confirm the unit on operation.)



- 2 Press the Airflow Direction Control Button and the vertical louvers swing up and down automatically.



- 3 Press again the Airflow Direction Control Button to set the vertical louver at the desired airflow direction.



Horizontal Airflow Direction Control

- Adjust the horizontal airflow direction by manually moving the horizontal airflow direction louver by hand.

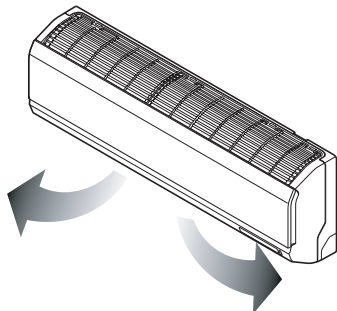

Caution

- Always use the remote controller to adjust the airflow direction. Manually moving the vertical airflow direction louver by hand could cause operation errors.
- When air conditioner operation is stopped, the vertical airflow direction louver will close the air outlet vent of room air conditioner.



Forced Operation

Operation procedures when the remote control can't be used.
 The operation will be started if the power button is pressed.
 If you want to stop operation, re-press the button.

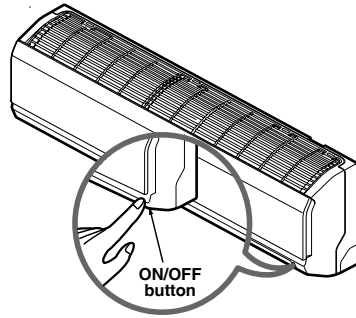

	Cooling Model	Heat pump Model		
		Room Temp. 24 °C	21 °C Room Temp. < 24 °C	Room Temp. < 21 °C
Operating mode	Cooling	Cooling	Healthy Dehumidification	Heating
Indoor FAN Speed	High	High	High	High
Setting Temperature	22 °C	22 °C	23 °C	24 °C

Test operation

During the TEST OPERATION, the unit operates in cooling mode with high speed fan, regardless of room temperature and resets in 18 minutes.

During test operation, if remote controller signal is received, the unit operates as remote controller sets.

If you want to use this operation, Press and hold the ON/OFF button for 3~5 seconds, then the buzzer sound 1 "beep".

If you want to stop the operation, re-press the button.



Auto restart

In case the power comes on again after a power failure, Auto Restarting Operation is the function to operate procedures automatically to the previous operating conditions.

So there is no need of activating this function by pressing any key or button.

In the initial mode, the fan operates at a low speed and the compressor starts 2.5~3 minutes later.

As the compressor starts, the fan speed also resumes its previous setting mode.

Helpful information

Fan speed and cooling capacity.

The cooling capacity indicated in the specification is the value when the fan speed is set to high, and the capacity will be lower at low or medium fan speed.

High fan speed is recommended when you wish to cool the room quickly.

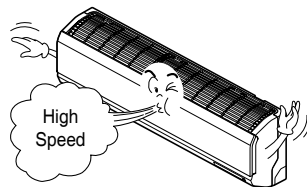

Care and maintenance of the air conditioner

CAUTION: Before performing any maintenance, turn off the main power to the system.

Indoor Unit

Grille, Case, and Remote Control

Turn the system off before cleaning. To clean, wipe with a soft, dry cloth. Do not use bleach or abrasives.

NOTE:
Supply power must be disconnected before cleaning the indoor unit.

Never use any of the followings:

- Water hotter than 40 °C
Could cause deformation and/or discoloration.
- Volatile substances
- Could damage the surfaces of the air conditioner.

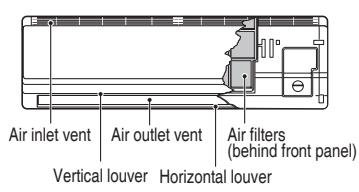

AIR FILTERS

The air filters behind the front grille should be checked and cleaned once in every 2 weeks or more often if necessary.

- 1 Lift the front access panel and pull the filter tab slightly forward to remove the filter.
- 2 Clean the filter with a vacuum cleaner or warm, soapy water.
 - If dirt is conspicuous, wash with a solution of detergent in lukewarm water.
 - If hot water (40 °C or more) is used, it may be deformed.
- 3 After washing with water, dry well in the shade.
- 4 Re-install the air filter.

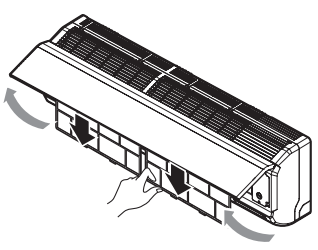

Outdoor Unit

The heat exchanger coils and panel vents of the outdoor unit should be checked regularly. If clogged with dirt or soot, the heat exchanger and panel vents may be professionally steam cleaned.

NOTE:

Dirty or clogged coils will reduce the operating efficiency of the system and cause higher operating costs.

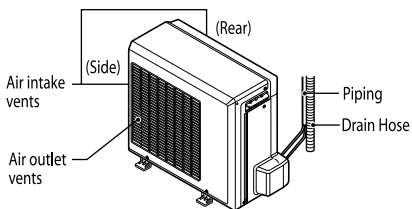
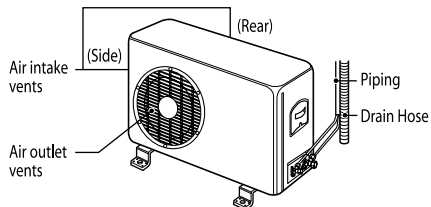
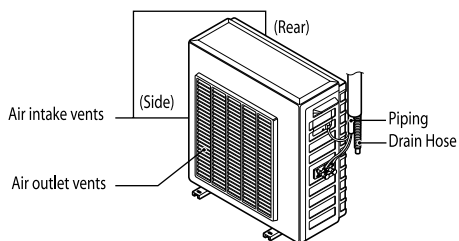

When the air conditioner is not going to be used for a long time.

When air conditioner is not going to be used for a long time.

- 1 Turn off the circuit breaker, and disconnect the plug.

CAUTION

Turn off the circuit breaker when the air conditioner is not going to be used for a long time. Dirt may collect and may cause a fire.

- 2 Remove the batteries from the remote control.

When the air conditioner is to be used again.

- 1 Clean the air filter and install it in the indoor unit. (Refer to page 12 for cleaning filters.)

- 2 Check that the air inlet and outlet of the indoor/outdoor unit are not blocked.

Operation Tips

Do not overcool the room.

This is not good for the health and wastes electricity.

Make sure that the doors and windows are shut tight.

Avoid opening doors and windows as much as possible to keep the cool air in the room.

Keep blinds or curtains closed.

Do not let direct sunshine enter the room when the air conditioner is in operation.

Clean the air filter regularly.

Blockages in the air filter reduces the airflow and lowers the cooling and dehumidifying effects. Clean at least once in every two weeks.

Keep the room temperature uniform.

Adjust the vertical and horizontal airflow direction to ensure a uniform temperature in the room.

Ventilate the room occasionally.

Since windows are kept closed, it is a good idea to open them and ventilate the room now and then.

Before you call for service...



Troubleshooting Tips! Save time and money!

Check the following points before requesting repairs or service....If the fault persists, please contact your dealer or service center.

Case	Explanation	See page
The air conditioner does not operate.	•Have you made a mistake in timer operation.	9
	•Has the fuse blown or has the circuit breaker been tripped.	-
The room has a peculiar odor.	•Check that this is not a damp smell exuded by the walls, carpet, furniture, or cloth items in the room.	-
It seems that condensation is leaking from the air conditioner.	•Condensation occurs when the airflow from the air conditioner cools the warm room air.	-
Air conditioner does not operate for about 3 minutes when restarted.	•This is the protector of the mechanism. •Wait about three minutes and operation will begin.	-
Does not cool or heat effectively.	•Is the air filter dirty? See air filter cleaning instructions.	12
	•Has the temperature been set incorrectly.	7, 8
	•Are the indoor unit's air inlet or outlet vents obstructed.	-
The air conditioner operation is noisy.	•For a noise that sounds like water flowing. -This is the sound of freon flowing inside the air conditioner unit. •For a noise that sounds like the compressed air releasing into atmosphere. -This is the sound of the dehumidifying water being processed inside the air conditioning unit.	-
Remote control display is faint, or no display at all.	•Are the batteries depleted. •Are the batteries inserted in the opposite (+) and (-) directions.	4
Crack sound is heard.	•This sound is generated by the expansion/constriction of the front panel, etc. due to changes of temperature.	-

NOTE

WATER RESISTANT: The outdoor side of this appliance is WATER RESISTANT.
The indoor side is not water resistant and should not be exposed to excess water.



LG Electronics Inc.