

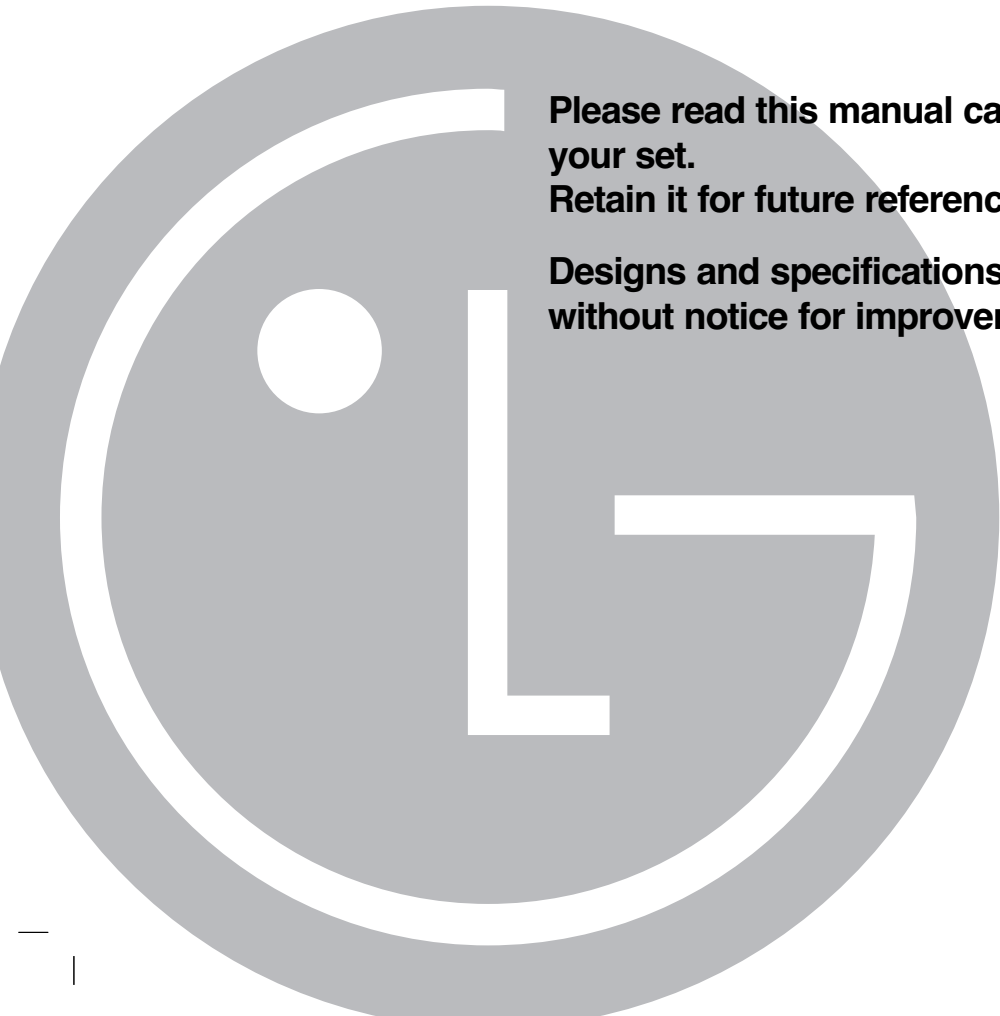

PORTABLE CD CASSETTE RECORDER OWNER'S MANUAL

MODEL: LPC-140A/X



A large, light gray watermark of the LG logo is positioned on the left side of the page, partially overlapping the text.

**Please read this manual carefully before operating
your set.
Retain it for future reference.**

**Designs and specifications are subject to change
without notice for improvement.**

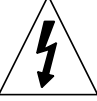

Precautions

	CAUTION RISK OF ELECTRIC SHOCK DO NOT OPEN	
CAUTION: TO REDUCE THE RISK OF ELECTRIC SHOCK DO NOT REMOVE COVER (OR BACK) NO USER SERVICEABLE PARTS INSIDE. REFER SERVICING TO QUALIFIED SERVICE PERSONNEL.		

Explanation Graphical Symbols:



The lightning flash with arrowhead symbol, within an equilateral triangle is intended to alert the user to the presence of uninsulated dangerous voltage within the product's enclosure that may be of sufficient magnitude to constitute a risk of electric shock to persons.



The exclamation point within an equilateral triangle is intended to alert the user to the presence of important operating and maintenance (servicing) instructions in the literature accompanying the appliance.

WARNING

TO REDUCE THE RISK OF FIRE OF ELECTRIC SHOCK, DO NOT EXPOSE THIS APPLIANCE TO RAIN OR MOISTURE.

To avoid electrical shock, do not open the cabinet, Refer servicing to qualified personnel only.

The apparatus shall not be exposed to dripping or splashing and that no objects filled with liquids, such as vases, shall be placed on the apparatus.

Warning:

Do not install this equipment in a confined space such as a book case or similar unit.

CAUTION

Use of controls or adjustments or performance of procedures other than those specified herein may result in hazardous radiation exposure.

Laser component in this product is capable of emitting radiation exceeding the limit for Class 1.

CAUTION: INVISIBLE LASER RADIATION WHEN OPEN AND INTERLOCKS DEFEATED. AVOID EXPOSURE TO BEAM.

WARNING: OSYNLIG LASERSTRÅLNING NÄR DENNA DEL ÄR ÖPPNAD STRÅLEN ÄR FARLIG.

Attention: Quand l'appareil est ouvert, ne pas s'exposer aux radiations invisibles du faisceau laser.

This label is located on the interior.

CLASS 1	LASER PRODUCT
KLASSE 1	LASER PRODUKT
LUOKAN 1	LASER LAITE
KLASS 1	LASER APPARAT
CLASSE 1	PRODUIT LASER

This Compact Disc player is classified as a CLASS 1 LASER product.

The CLASS 1 LASER PRODUCT label is located on the exterior.

This product is manufactured to comply with the radio interference requirements of EEC DIRECTIVE 89/336/EEC, 93/68/EEC and 73/23/EEC.

Table of Contents

INTRODUCTION

Precautions	2
Table of Contents	3
Before Use	4
Safety Precautions	4
Notes on Discs	4
Notes on Tapes	4
Up Panel/ Front Panel	5
Rear Panel/ Display Window	6

BEFORE OPERATION

Power Source	7
The AC Power Cord Connection	7
Adjusting the voltage (OPTIONAL)	7
Battery Installation	7
Audio Adjustment	7
Volume Adjustment	7
Headphone Socket	7



OPERATION

Radio Operation	8
Listening to the radio	8
Setting STEREO/ MONO	8
Tape Operation	8
Basic Playback	8
To Pause Play	8
To Stop Play	8
To Play Rewind or Fast Forward	8
CD Operation	9
Basic Playback	9
To Pause Play	9
To Stop Play	9
To Skipping the Track	9
To Searching the Track	9
To Repeat Play	9
Recording	10
Basic Recording	10
CD Synchronized Recording	10

REFERENCE

Specifications	11
----------------------	----

About the symbols for instructions

-  Indicates hazards likely to cause harm to the unit itself or other material damage.
-  Indicates special operating features of this unit.
-  Indicates tips and hints for making the task easier.

Before Use

Safety Precautions

Handling the unit

When shipping the unit

The original shipping carton and packing materials come in handy. For maximum protection, re-pack the unit as it was originally packed at the factory.

To keep the surface clean

Do not use volatile liquids, such as insecticide spray, near the unit. Do not leave rubber or plastic products in contact with the unit for a long period of time. They will leave marks on the surface.

Cleaning the unit

To clean the cabinet

Use a soft, dry cloth. If the surfaces are extremely dirty, use a soft cloth lightly moistened with a mild detergent solution. Do not use strong solvents, such as alcohol, benzene, or thinner, as these might damage the surface of the unit.

Notes on Discs

Handling discs

Do not touch the playback side of the disc.
Hold the disc by the edges so that fingerprints will not get on the surface.
Do not stick paper or tape on the disc.



Storing discs

After playing, store the disc in its case.
Do not expose the disc to direct sunlight or sources of heat, or leave it in a parked car exposed to direct sunlight, as there may be a considerable temperature increase inside the car.

Cleaning discs

Fingerprints and dust on the disc can cause poor quality and sound distortion. Before playing, clean the disc with a clean cloth. Wipe the disc from the center out.

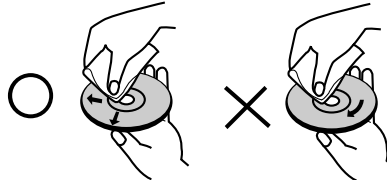

Do not use strong solvents such as alcohol, benzene, thinner, commercially available cleaners, or anti-static spray intended for analog records.

Notes on Tapes

Preventing record

Removing the tab(s) of the cassette (with a small screwdriver) will prevent accidental erasure.

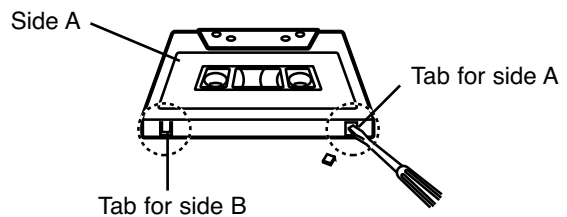

To record again, cover the hole of the tab with adhesive tape.

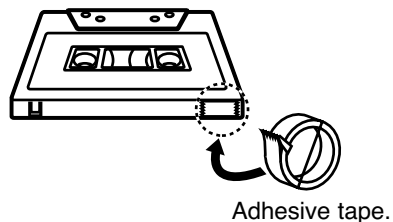

Up Panel/Front Panel

Up Panel

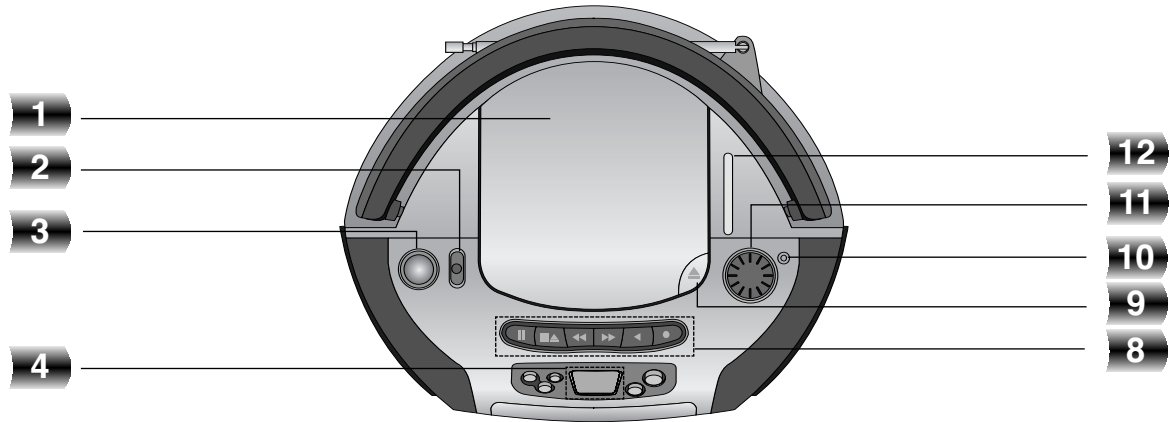

Front Panel

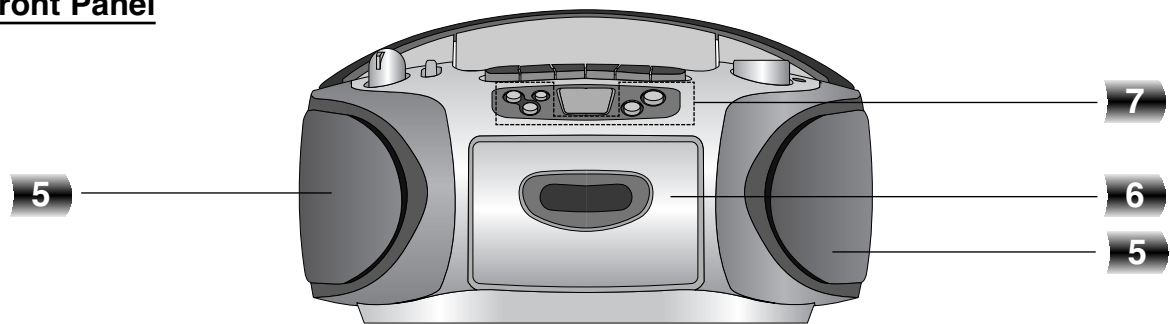

- | | |
|---|--|
| <ol style="list-style-type: none"> 1. CD DOOR 2. FUNCTION SWITCH
[CD/ FM/ AM/ TAPE] 3. VOLUME CONTROL DIAL 4. DISPLAY WINDOW indicator 5. LEFT/ RIGHT SPEAKER 6. TAPE DOOR 7. CD FUNCTION buttons <ul style="list-style-type: none"> • CD BACKWARD SKIP/SEARCH (⏮) button • CD FORWARD SKIP/SEARCH (⏭) button • CD REPEAT button • CD STOP (■) button • CD PLAY/PAUSE (▶) button | <ol style="list-style-type: none"> 8. TAPE FUNCTION buttons <ul style="list-style-type: none"> • TAPE PAUSE () button • TAPE STOP/EJECT(■▲) button • FAST FORWARD (⏩) button • REWIND (⏪) button • TAPE PLAY (◀) button • RECORD (●) button 9. CD DOOR OPEN (▲ OPEN) button 10. STEREO indicator 11. TUNING DIAL 12. FREQUENCY indicator |
|---|--|

Rear Panel/Display Window

Rear Panel

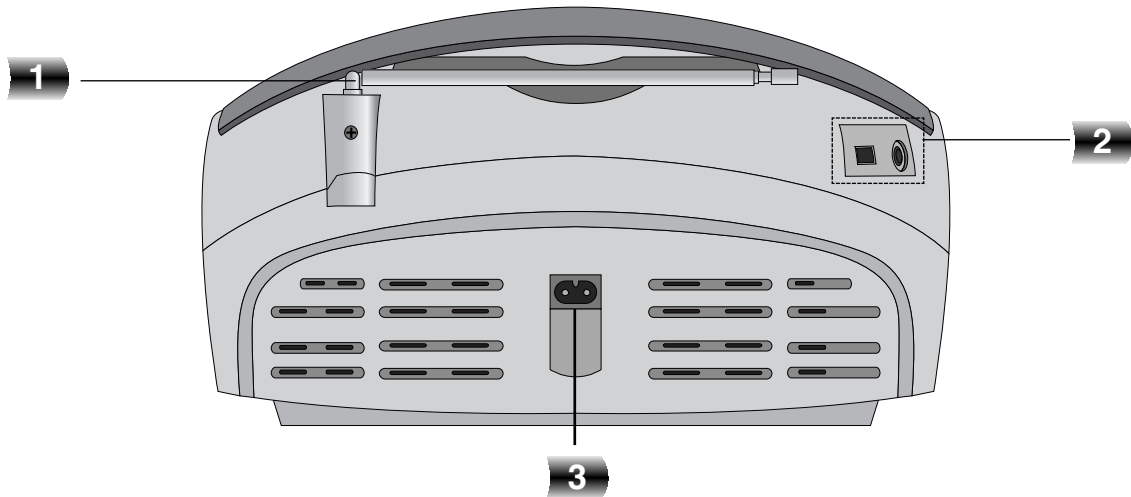

Display Window

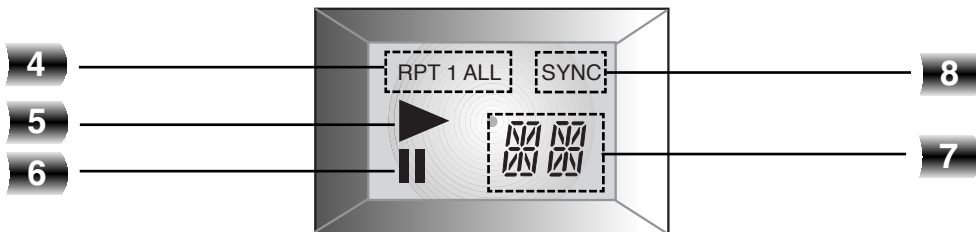

- | | |
|---|--|
| 1. FM ANTENNA | 5. CD PLAY indicator |
| 2. RIF/FM MODE SWITCH (ST./MONO)
HEADPHONE SOCKET (Ⓜ): ∅ 3.5mm | 6. CD PAUSE indicator |
| 3. AC POWER INPUT SOCKET | 7. CD TRACK NUMBER indicator |
| 4. CD REPEAT PLAY indicator | 8. CD SYNCHRONIZED RECORDING indicator |

Power Source

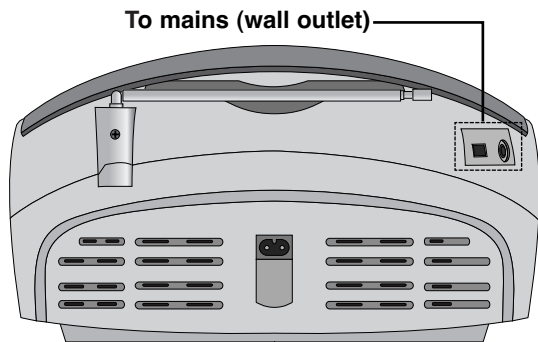

The AC Power Cord Connection

- 1** Before connecting the AC power cord, check that the operating voltage of your unit is identical with the voltage of your local power supplied.
- 2** Connect one end of the AC power cord (supplied) to the AC IN socket located at the backside of your unit.
- 3** Plug the other end into the wall outlet.

Note

Unplug the AC power cord from the wall outlet if you do not to use for an extended period of time.

Adjusting the voltage (OPTIONAL)

If your unit is equipped with a voltage selector at the back side, be sure to set it to your local power supplied before connecting the AC power cord.

Battery Installation

- 1** Press and open the battery cover.
- 2** Put six "C"(R14) batteries (not supplied) into the compartment making sure the + and - are correctly positioned.
- 3** Replace the battery cover.

Note

- To avoid damage from possible battery leakage, remove the batteries if you do not plan to use the unit for an extended period of time.
- When the batteries are weak, replace all the batteries with new ones.
- During the AC power cord connect to the wall outlet, the batteries are not worn out.

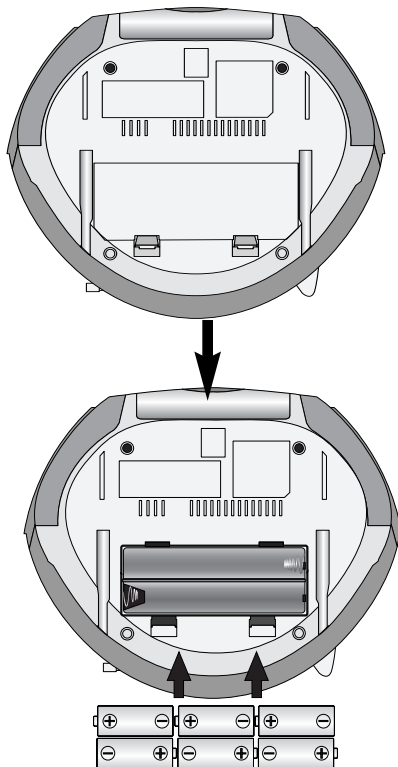

Audio Adjustment

Volume Adjustment

Turn **VOLUME CONTROL DIAL** clockwise to increase the sound level, or counterclockwise to decrease it.

Headphone Socket

- Connect a stereo headphone plug (ϕ 3.5mm) into the headphone jack.
- The speakers are automatically disconnected when you plug in the headphones (not supplied).

Radio Operation

FUNCTION SWITCH TUNING dial

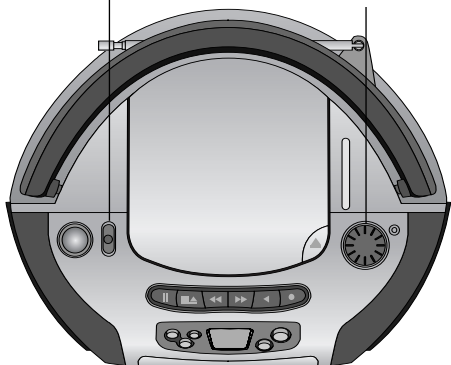

RIF/FM MODE SWITCH (ST./MONO)

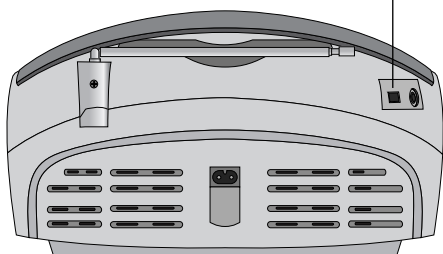

Listening to the radio

- 1** Set FUNCTION SWITCH to select AM or FM.
- 2** Set a station by turning TUNING dial.

To turn off the radio

Set FUNCTION SWITCH to TAPE(OFF) or CD to turn off your unit.

Setting STEREO/ MONO

- 1** Set RIF/ FM MODE SWITCH to ST. to listening to an FM stereobroadcast.
- 2** Set RIF/ FM MODE SWITCH to MONO when listening to an FM stereo broadcast.
Selecting this function will substantially reduce the noise, however the stereo effect will be lost.

Notes

Adjust the antenna to get more clear reception.

- **AM antenna**
This antenna is built within the unit and rotate the unit for better reception.
- **FM antenna**
Pull the telescopic antenna out and adjust the angle and direction for better reception.

Tape Operation

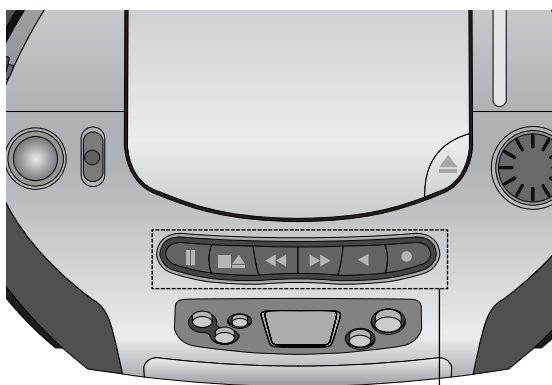

- TAPE PAUSE (||)
- TAPE STOP/EJECT (■▲)
- FAST FORWARD (◀◀)
- REWIND (▶▶)
- TAPE PLAY (◀)
- TAPE RECORD (●)

Basic Playback

- 1** Set FUNCTION SWITCH to TAPE.
- 2** Open the cassette door by pressing TAPE STOP/EJECT (■▲) button.
- 3** Insert a cassette and push close the TAPE door.
- 4** Press TAPE PLAY (◀) to playback.

To Pause Play

Press TAPE PAUSE (||) button to pause. Press the button again to resume play.

To Stop Play

Press TAPE STOP/EJECT (■▲) button to stop play. (Your cassette deck will automatically stop at the end of the tape.)

To Play Rewind or Fast Forward

After pressing and holding FAST FORWARD/REWIND (◀◀/▶▶) button during playback, press TAPE PLAY (◀) at the point you want.

CD Operation

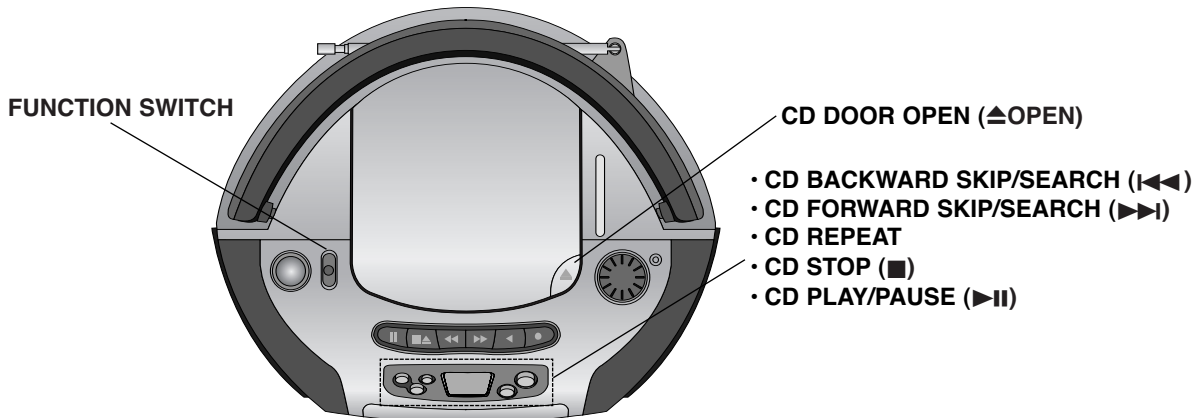

Basic Playback

- 1** Set FUNCTION SWITCH to CD.
- 2** Press CD DOOR OPEN (▲OPEN) button to open the disc compartment.
- 3** Load a disc with the printed side facing up.
- 4** Close the disc compartment. The display will show the total number of tracks.
- 5** Press CD PLAY/PAUSE (▶||) button to begin play.
The track number will be shown in the display.

To Pause Play

Press CD PLAY/PAUSE (▶||) button to pause during playback.
Press CD PLAY/PAUSE (▶||) button again to resume play.

To Stop Play

Press CD STOP (■) button during playback.

To Skipping the Track

- Press CD FORWARD SKIP/SEARCH (▶▶I) button to go to the next track.
- When CD BACKWARD SKIP/SEARCH (I◀◀) button is pressed once midway through a track, the player returns to the start of that track. When it is pressed again, a track is skipped each time the button is pressed.

To Searching the Track

After pressing and holding CD SKIP/SEARCH (I◀◀,▶▶I) button during playback, then release at the point you want.

N Notes

- Do not tilt or move your unit with discs loaded. If you do you may damage the discs and your unit.
- Do not touch the playing side of CD; the side without any printing on it.
- Clean your CD from the middle outward with a soft lint free cloth.

To Repeat Play

To play one track repeatedly

Press CD REPEAT button once during playback.
- "REPEAT 1" appears in the display.

To play all tracks repeatedly

Press CD REPEAT button again during playback.
- "REPEAT ALL" appears in the display.

To cancel repeat play

Press CD REPEAT button once more during playback.
- Repeat indicator disappears.

Recording

Wind the tape to the point recording starts. (Use only normal tapes.)

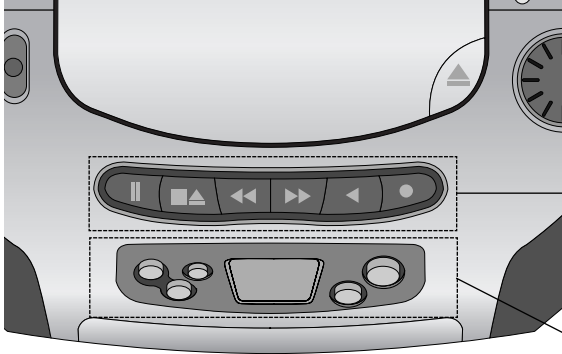

- TAPE PAUSE (||)
- TAPE STOP/EJECT (■▲)
- FAST FORWARD (◀◀)
- REWIND (▶▶)
- TAPE PLAY (◀)
- TAPE RECORD (●)

- CD BACKWARD SKIP/SEARCH (◀◀|)
- CD FORWARD SKIP/SEARCH (▶▶|)
- CD REPEAT
- CD STOP (■)
- CD PLAY/PAUSE (▶||)

Basic Recording

- 1** Select a function you wish to record by setting **FUNCTION SWITCH** except **TAPE** function.
- 2** Insert a blank tape.
- 3** Press **RECORD (●)** button. **TAPE PLAY (◀)** button is pressed automatically.
- 4** Start playing your **CD** or **RADIO**.

CD Synchronized Recording

This feature automatically records an entire CD into a cassette.

- 1** Load a CD disc and Set **FUNCTION SWITCH** to **CD**.
- 2** Insert a blank tape.
- 3** Press **RECORD (●)** button. **TAPE PLAY (◀)** button is pressed automatically.
- 4** The synchronized recording is started automatically after about 7 seconds.

To pause recording

Press **TAPE PAUSE (||)** button. Press **TAPE PAUSE (||)** button again to resume recording.

To stop recording

Press **TAPE STOP/EJECT (■▲)** button. (Your cassette deck will automatically stop at the end of the tape.)

Notes

- If you wish to record from the desired track, select the desired track with **CD SKIP/SEARCH (◀◀|, ▶▶|)** button before commencing CD recording.
- If bear noises sound when AM broadcast recording, reset **RIF** on the rear panel.

Specifications

SECTION		MODEL	LPC-140A	LPC-140X
[General]	Power supply		Refer to the back panel of the unit.	
	Power consumption		10W	
	Mass		3.0 kg	
	External dimensions (W x H x D)		300 x 252 x 171 mm	
	Output Power		1W X 2 T.H.D 10%	
	Speakers		8Ω X 2	
	Battery Operation		DC 9V, six "C"(R14) batteries (not supplied)	
[CD]	Frequency response		100 - 18000 Hz	
	Signal-to-noise ratio		55 dB	
	T.H.D		0.5 %	
[Tuner]	FM	Tuning Range	87.5 -108 MHz	87.5 -108 MHz/65 -108 MHz
		Intermediate Frequency	10.7 MHz	
		Antenna	Telescopic antenna	
	AM (MW)	Tuning Range	522 - 1611 kHz or 530 - 1610 kHz	
		Intermediate Frequency	455 kHz	
		Antenna	Ferrite bar antenna	
[TAPE]	Recording System	4 Tracks 2 channel stereo		
	Frequency Response	125 - 8000Hz		
	Signal to Noise Ratio	35/40dB (REC/PLAY)		

REFERENCE

Designs and specifications are subject to change without notice for improvement.



P/NO : 3834RC0026A