



LG

Life's Good

ENGLISH

OWNER'S MANUAL

MONITOR SIGNAGE

Please read this manual carefully before operating the your set and retain it for future reference.

MONITOR SIGNAGE MODELS

65VS10

CONTENTS

3 LICENSES

4 ASSEMBLING AND PREPARING

- 4 Unpacking
- 5 Optional Accessories
- 6 Parts and buttons
- 7 Connecting the Speakers
- 7 Portrait Layout
- 8 Installing on a wall

9 REMOTE CONTROL

11 USING THE MONITOR SET

- 11 Connecting to a PC
- 11 - Using the input list
- 12 - RGB connection
- 12 - HDM/DVI connection
- 13 - HDMI connection

14 CUSTOMIZING SETTINGS

- 14 Accessing main menus
- 15 - PICTURE settings
- 20 - AUDIO settings
- 21 - TIME settings
- 22 - OPTION settings
- 24 - TILE settings

26 ENTERTAINMENT

- 26 Using integrated media features
- 26 - Connecting USB storage devices
- 27 - Browsing files
- 29 - Viewing Photos
- 30 - Listening to Music
- 31 - Viewing Movies
- 34 - DivX registration code
- 34 - Deactivating the DivX feature

35 MAKING CONNECTIONS

- 36 Connecting to a HD receiver, DVD, Camcorder, Camera, Gaming Device or VCR player
- 36 - HDMI connection
- 36 - HDMI/DVI connection
- 37 - Component connection
- 37 - AV(CVBS) connection
- 38 Connecting to the LAN
- 38 - LAN connection
- 39 Daisy Chain Monitors
- 39 - RGB Mode
- 39 - AV(CVBS) Mode

40 TROUBLESHOOTING

43 SPECIFICATIONS

47 IR CODES

48 CONTROLLING THE MULTIPLE PRODUCT

- 48 Connecting the cable
- 48 RS-232C Configurations
- 48 Communication Parameter
- 49 Command reference list
- 51 Transmission / Receiving protocol

LICENSES

Supported licenses may differ by model. For more information of the licenses, visit www.lg.com.



HDMI, the HDMI logo and High-Definition Multimedia Interface are trademarks or registered trademarks of HDMI Licensing LLC.



ABOUT DIVX VIDEO: DivX® is a digital video format created by DivX, LLC, a subsidiary of Rovi Corporation. This is an official DivX Certified® device that plays DivX video. Visit divx.com for more information and software tools to convert your files into DivX videos.

ABOUT DIVX VIDEO-ON-DEMAND: This DivX Certified® device must be registered in order to play purchased DivX Video-on-Demand (VOD) movies. To obtain your registration code, locate the DivX VOD section in your device setup menu. Go to vod.divx.com for more information on how to complete your registration.

DivX Certified® to play DivX® video, including premium content.

DivX®, DivX Certified® and associated logos are trademarks of Rovi Corporation or its subsidiaries and are used under license.

Covered by one or more of the following U.S. patents: 7,295,673; 7,460,668; 7,515,710; 7,519,274

ASSEMBLING AND PREPARING

Unpacking

Check your product box for the following items. If there are any missing accessories, contact the local dealer where you purchased your product. The illustrations in this manual may differ from the actual product and accessories.

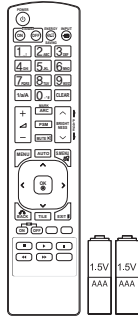

Remote control and Batteries

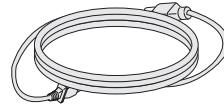

Power Cord



CD (Owner's Manual) / Card



D-Sub Signal Cable



CAUTION

- Do not use any pirated items to ensure the safety and product life span.
- Any damages or injuries by using pirated items are not covered by the warranty.



NOTE

- The accessories supplied with your product may vary depending on the model.
- Product specifications or contents in this manual may be changed without prior notice due to upgrade of product functions.

Optional Accessories

Without prior notice, optional accessories are subject to change to improve the performance of the product, and new accessories may be added. The illustrations in this manual may differ from the actual product and accessories.

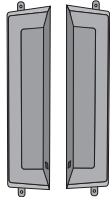

Speaker



Screws/Cable



Cable holder/
Cable Tie

Speaker kit



NOTE

- Cable holder/Cable tie may not be available in some areas or for some models.
- Optional accessories are not included for all models.

Parts and buttons

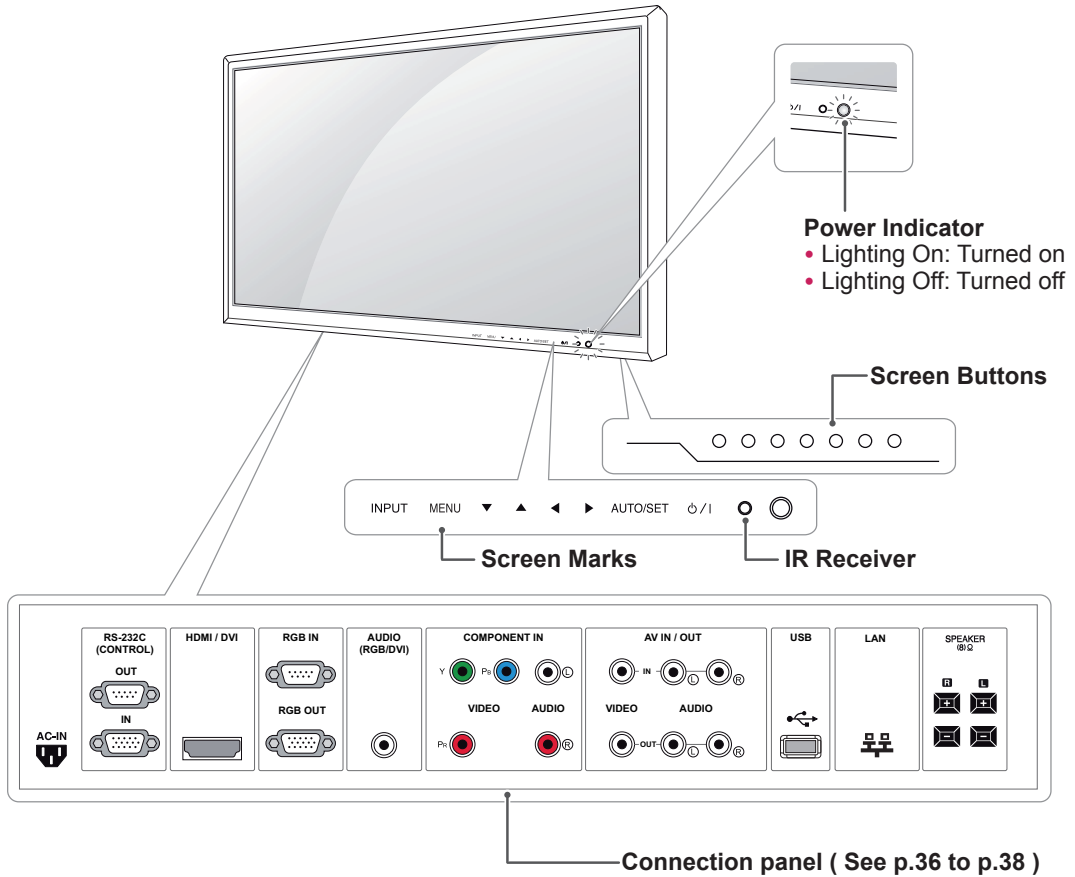

Screen Marks	Description
INPUT	Changes the input source.
MENU	Accesses the main menus, or saves your input and exits the menus.
▼ ▲	Adjust the up and down.
◀ ▶	Adjusts the volume level.
AUTO/SET	Auto setup when using RGB input. It is also the Set or enter button to make changes in the on-screen menus.
⏻ / I	Turns the power on or off.
IR Receiver	This is where the unit receives signals from the remote control.
Power Indicator	This Indicator lights up green when the display operates normally(on mode). If the display is in sleep (Energy Saving) mode, this indicator color changes to amber.

NOTE

- You can set the Power indicator to on or off by selecting **OPTION** in the main menu.

Connecting the Speakers

- Only on some models.

- 1 Mount the speaker by using a screw as shown in the following. Then connect the speaker cable.

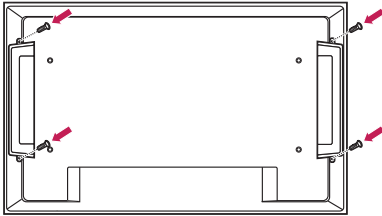

- 2 After installing your speakers, use holders and cable ties to organize the speaker cables.

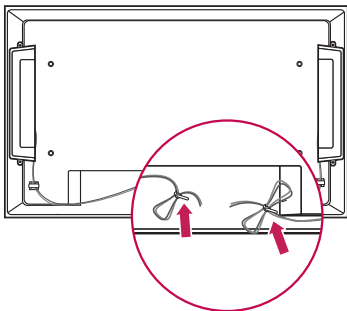
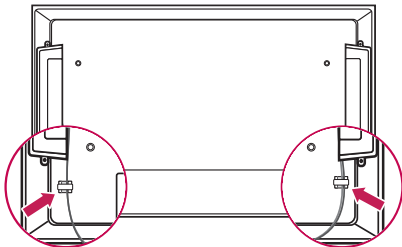

Portrait Layout

- Only on some models.

When installing in a Portrait Layout, rotate the monitor clockwise 90 degrees (when facing the screen).

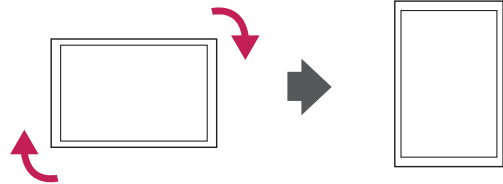

Installing on a wall

Install the monitor at least 10 cm away from the wall and leave about 10 cm of space at each side of the monitor to ensure sufficient ventilation. Detailed installation instructions can be obtained from your local retail store. Please refer to the manual to install and set up a tilting wall mounting bracket.

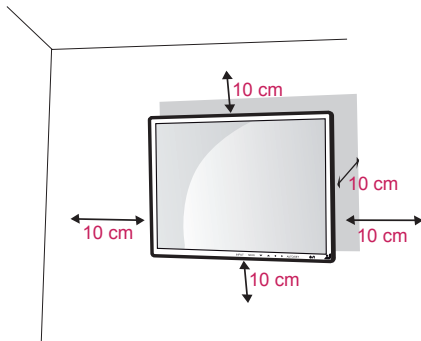

If you want to mount the monitor on the wall (optional), attach the wall mounting bracket to the rear of the monitor.

Make sure that the wall mounting bracket is securely fixed to the monitor and to the wall.

Use the wall mount plate and screws that comply with the VESA standard as specified below.

- 785mm(31 inch) or greater
 - * Fastening screw: Diameter 6.0 mm x Pitch 1.0 mm x Length 10 mm
(32 inch is Diameter 4.0 mm x Pitch 0.7 mm x Length 10 mm)



CAUTION

- Disconnect the power cord first, and then move or install the Monitor set. Otherwise electric shock may occur.
- If you install the Monitor set on a ceiling or slanted wall, it may fall and result in severe injury. Use an authorized LG wall mount and contact the local dealer or qualified personnel.
- Do not over tighten the screws as this may cause damage to the Monitor set and void your warranty.
- Use the screws and wall mounts that meet the VESA standard. Any damages or injuries by misuse or using an improper accessory are not covered by the warranty.



NOTE

- The wall mount kit includes an installation manual and necessary parts.
- The wall mount bracket is optional. You can obtain additional accessories from your local dealer.
- The length of screws may differ depending on the wall mount. Be sure to use the proper length.
- For more information, refer to the instructions supplied with the wall mount.

REMOTE CONTROL

The descriptions in this manual are based on the buttons of the remote control. Please read this manual carefully and use the Monitor set correctly.

To replace batteries, open the battery cover, replace batteries (1.5 V AAA) matching ⊕ and ⊖ ends to the label inside the compartment, and close the battery cover.

To remove the batteries, perform the installation actions in reverse.



CAUTION

- Do not mix old and new batteries, as this may damage the remote control.
- Make sure to point the remote control to the remote control sensor on the Monitor set.

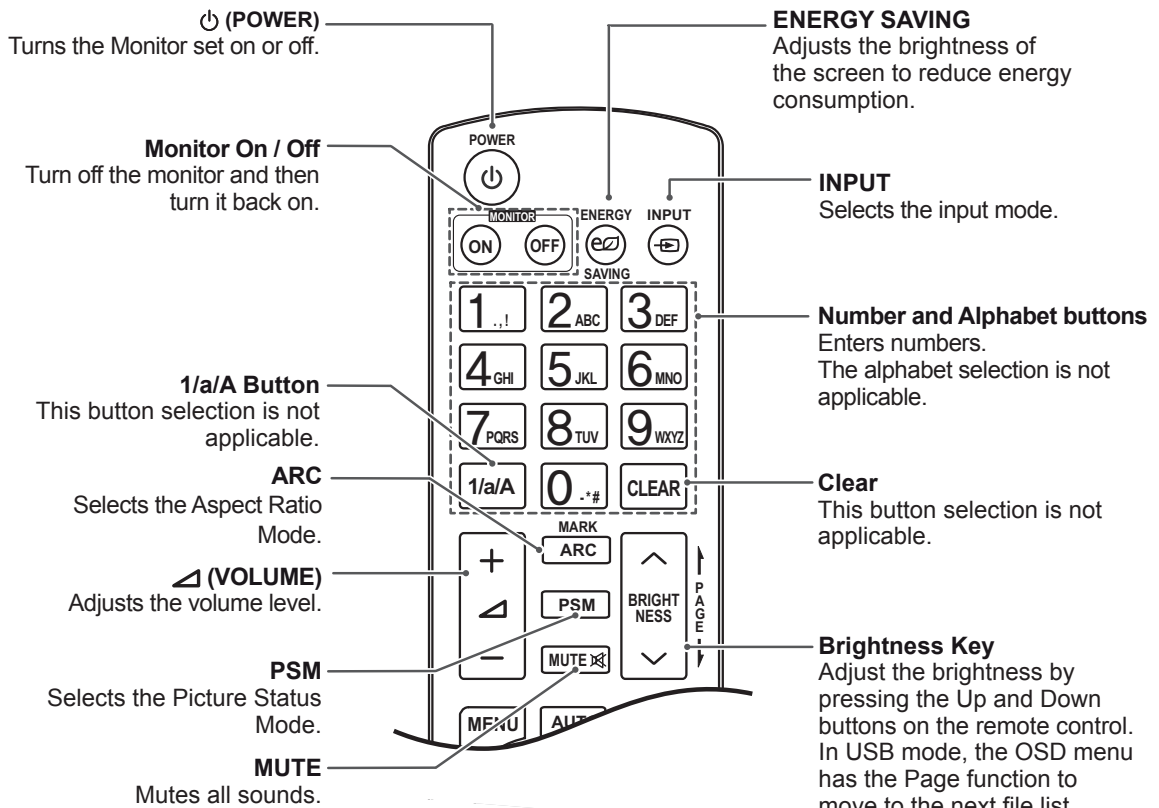
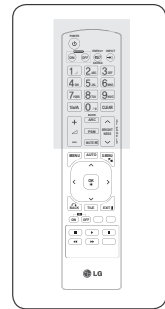
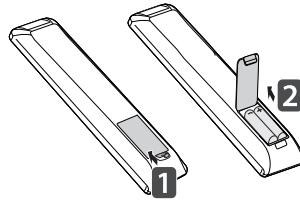

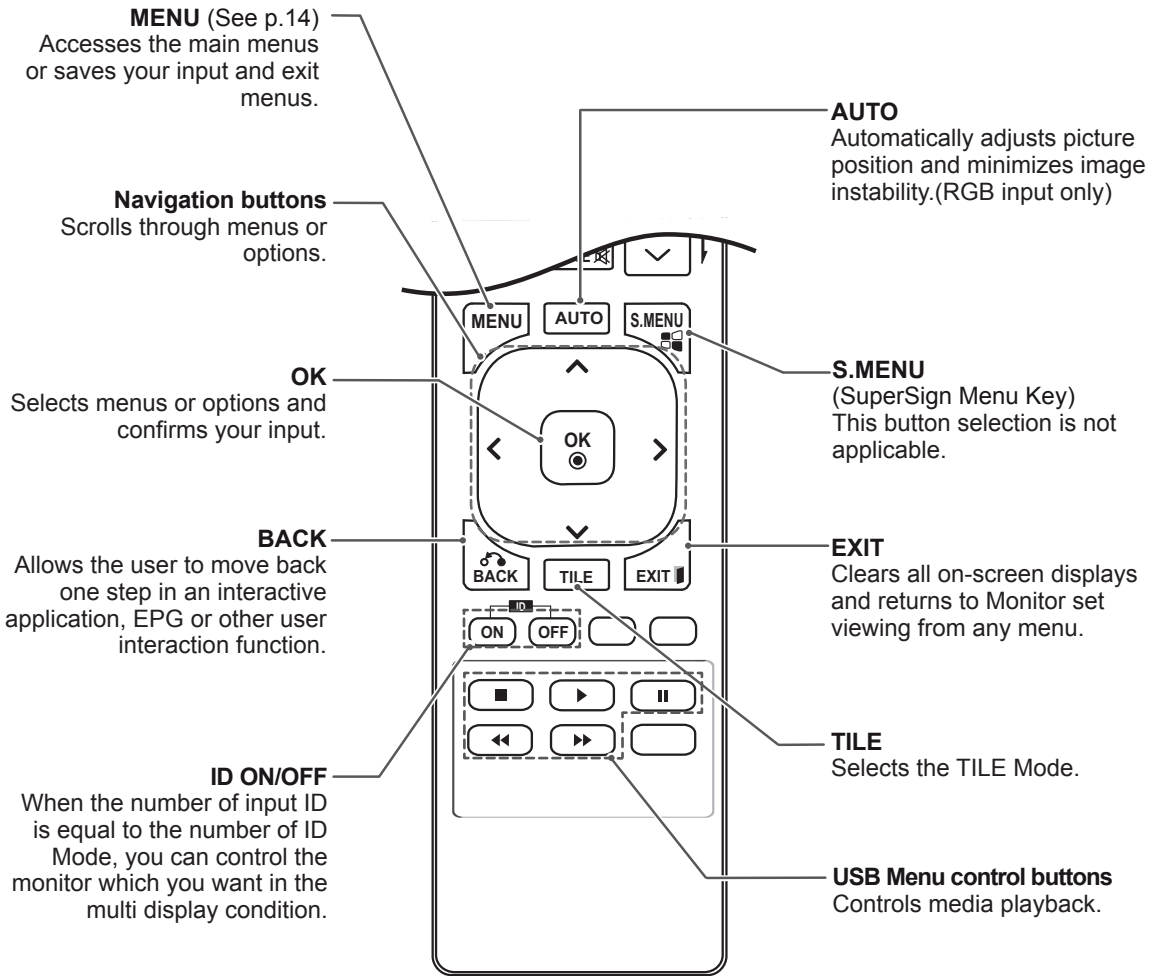
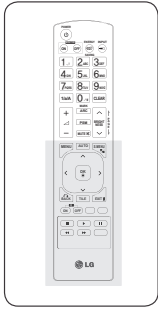

USING THE MONITOR SET

Connecting to a PC

Your Monitor set supports the Plug & Play* feature.

* Plug & Play: The function when a PC recognizes a connected device that users connect to a PC and turn on, without device configuration or user intervention.

NOTE

- It is recommended to use the Monitor set with an HDMI connection for the best image quality.
- If you turn the Monitor set on when cold, the screen may flicker. This is normal.
- Some red, green, or blue spots may appear on the screen. This is normal.

Using the input list

Selecting an input source

- 1 Press **INPUT** to access the input source list.
 - The connected device displays on each input source.
- 2 Press the Navigation buttons to scroll to one of the input sources and press **OK**.

Input source	Description
AV(CVBS)	A VCR or other external devices
Component	Older devices that do not have HDMI.
RGB	Computer input.
HDMI/DVI	Preferred connection type. Supports high resolution inputs.

CAUTION

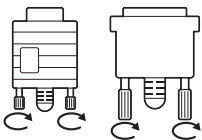

- Connect the signal input cable and tighten it by turning the screws clockwise.

- Do not press the screen with your finger for a long time as this may result in temporary distortion on the screen.
- Avoid displaying a fixed image on the screen for a long period of time to prevent image burn. Use a screensaver if possible.

RGB connection

Transmits the analog video signal from your PC to the Monitor set. Connect the PC and the Monitor set with the D-sub 15 pin cable as shown the following illustrations.

Select RGB input source.

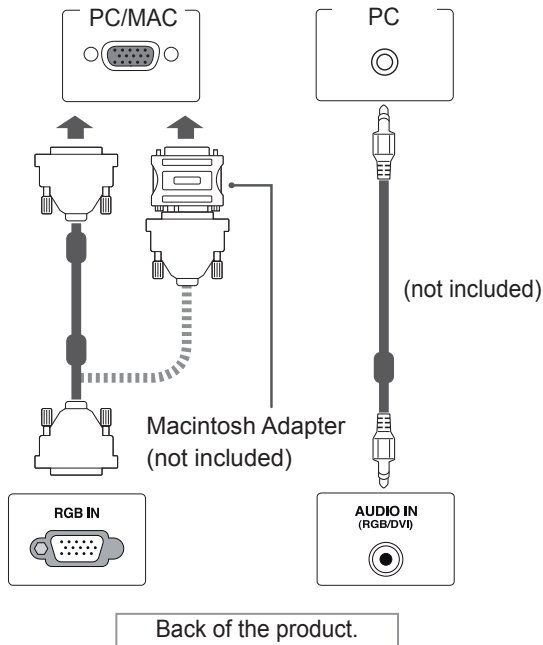

HDM/DVI connection

Transmits the digital video signal from your PC to the Monitor set. Connect the PC and the Monitor set with the HDMI/DVI cable as shown the following illustrations.

Select HDMI/DVI input source.

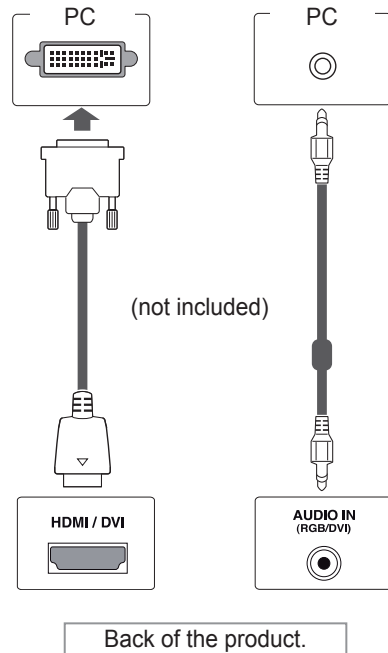

NOTE



- Apple computers may require an adapter to connect to this monitor. Call or visit their web site for more information.

NOTE

- When using computer input with HDMI, you must set the label of that HDMI input to PC.
- Use a shielded signal interface cable, such as D-sub 15 pin signal cable and DVI to HDMI cable, with a ferrite core to maintain standard compliance for the product.

HDMI connection

Transmits the digital video and audio signals from your PC to the Monitor set. Connect the PC and the Monitor set with the HDMI cable as shown in the following illustrations.

Select HDMI/DVI input source.

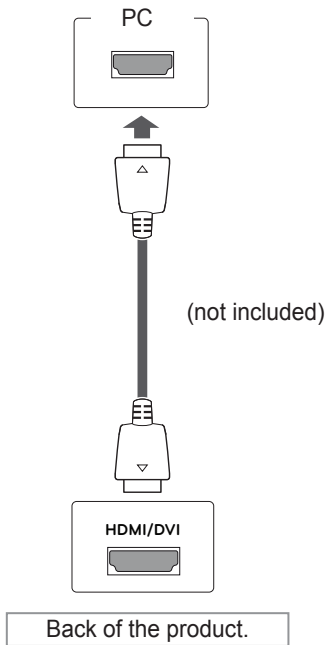

! NOTE

- Use a High Speed HDMI™ Cable.
- Please check the PC environment if you cannot hear the sound in HDMI mode. Some PCs require you to manually change the default audio output to HDMI.
- If you want to use HDMI-PC mode, you must set the input label to PC mode.

CUSTOMIZING SETTINGS

Accessing main menus

- 1 Press **MENU** to access the main menus.
- 2 Press the Navigation buttons to scroll to one of the following menus and press **OK**.
- 3 Press the Navigation buttons to scroll to the setting or option you want and press **OK**.
- 4 When you are finished, press **EXIT**.
When you return to the previous menu, press **BACK**.

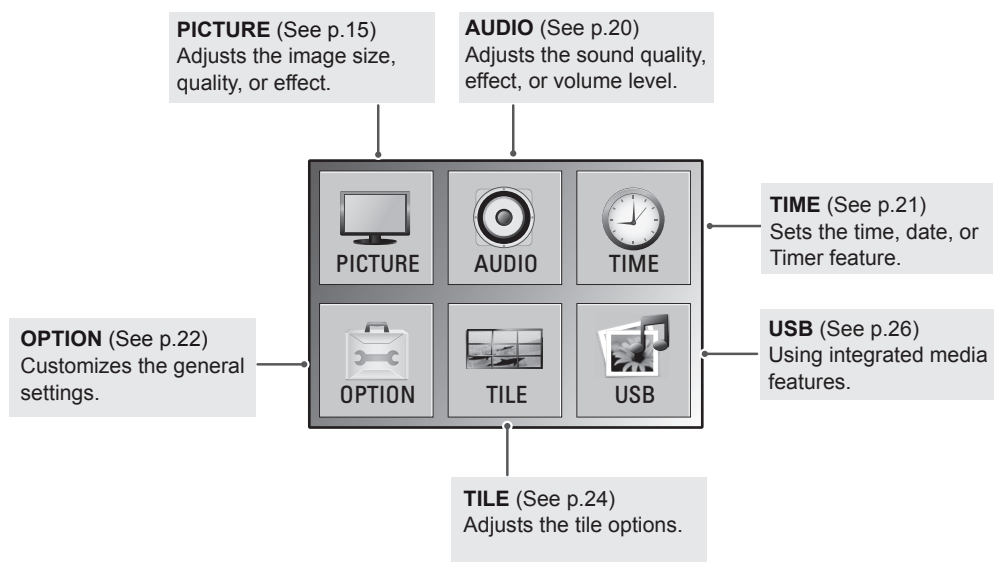
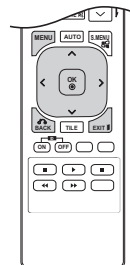

PICTURE settings

- 1 Press **MENU** to access the main menus.
- 2 Press the Navigation buttons to scroll to **PICTURE** and press **OK**.
- 3 Press the Navigation buttons to scroll to the setting or option you want and press **OK**.
- To return to the previous level, press **BACK**.
- 4 When you are finished, press **EXIT**.
When you return to the previous menu, press **BACK**.

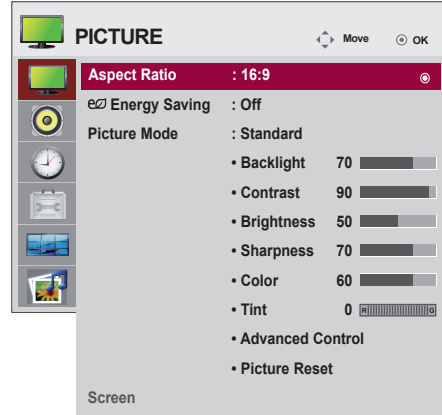

The available picture settings are described in the following:

Setting	Description
Aspect Ratio	Changes the image size to view images at its optimal size (See p.18 to p.19).
Energy Saving	Sets to automatically adjust the screen brightness corresponding to the surroundings.
	Level
	Off 100% light
	Level 1 80% light
	Level 2 60% light
	Level 3 40% light
	<div style="border: 1px solid black; border-radius: 10px; padding: 10px;"> <p>NOTE</p> <ul style="list-style-type: none"> If the 'Picture Mode' is set to 'Cinema', the 'Energy saving' mode is disabled. </div>
Picture Mode	Selects one of the preset image or customizes options in each mode for the best Monitor set screen performance. You are also able to customize advanced options of each mode. The available preset picture modes vary depending on the Monitor set .
	Mode
	Vivid Adjusts the video image for the retail environment by enhancing the contrast, brightness, Color, and sharpness.
	Standard Adjusts the image for the normal environment.
	Cinema Optimizes the video image for a cinematic look to enjoy movies as if you are in a movie theater.
	Sport Optimizes the video image for high and dynamic actions by emphasizing primary Colors such as white, grass, or sky blue.
	Game Optimizes the video image for a fast gaming screen such as PCs or games.
	Expert1/2 Adjusts the detailed video image settings for video experts as well as general viewers. Refer to the Basic image options. (See p.16).

SCREEN (In RGB Mode Only)	Customizes the PC display options in RGB mode.	
	Option	
	Resolution	Selects a proper resolution. See "Customizing PC display options".
	Auto Config.	Sets to adjust the screen position, clock, and phase automatically. The displayed image may be unstable for a few seconds while the configuration is in progress.
	Position/Size/ Phase	Adjusts the options when the picture is not clear, especially when characters are shaky, after the auto configuration.
	Reset	Restores the options to the default setting.

Basic image options

Setting	Description
Backlight	Adjusts the brightness of the screen by controlling the LCD backlight. If you decrease the brightness level, the screen becomes darker and the power consumption will be reduced without any video signal loss.
Contrast	Increases or decreases the gradient of the video signal. You may use Contrast when the bright part of the picture is saturated.
Brightness	Adjusts the base level of the signal in the picture. You may use Brightness when the dark part of the picture is saturated.
Sharpness	Adjusts the level of crispness in the edges between the light and dark areas of the picture. The lower the level, the softer the image.
Color	Adjusts intensity of all colors.
Tint	Adjusts the balance between red and green levels.
Advanced Control	Customizes the advanced options. Refer to the Advanced image options. (See p.17).
Picture Reset	Restores the options to the default setting.

! NOTE

- If the 'Picture Mode' setting in the Picture menu is set to **Vivid, Standard, Cinema, Sport** or **Game** the subsequent menus will be automatically set.
- You cannot adjust color and tint in the RGB-PC / HDMI-PC mode.
- When the Expert 1,2 is selected, you can select **Backlight, Contrast, Brightness, H Sharpness, V Sharpness, Color** or **Tint** .

Advanced image options

Setting	Description
Colour Temperature	Set to warm to enhance hotter Colors such as red, or set to cool to make picture bluish.
	Option
	Cool Sets the screen color to a bluish tone.
	Medium Sets the screen to the standard color.
Warm Sets the screen color to a reddish tone.	
Dynamic Contrast	Adjusts the contrast to keep it at the best level according to the brightness of the screen. The picture is improved by making bright parts brighter and dark parts darker. (This function can be used only under AV(CVBS) and Component.)
Dynamic Color	Adjusts screen Colors so that they look livelier, richer and clearer. This feature enhances hue, saturation and luminance so that red, blue, green and white look more vivid. (This function can be used only under AV(CVBS) and Component.)
Noise Reduction	Reduces screen noise without compromising video quality. (This function can be used only under AV(CVBS) and Component.)
Gamma	Set your own gamma value. On the monitor, high gamma values display whitish images and low gamma values display high contrast images.
Black Level	<ul style="list-style-type: none"> » Low: The picture of the screen gets darker. » High: The picture of the screen gets brighter. Set black level of the screen to proper level. (Function works in the following mode - AV(CVBS), Component, HDMI-DTV)
Film Mode	You can watch a cinema-like video by eliminating judder effect. Use this function when you watch movies.
White Balance	This is the function to adjust the overall Color of the image to the feeling you want. (Function works in the following mode - Expert 1, Expert 2 Picture mode)
Color Management System	As the tool used by the experts to make adjustments by using the test patterns, this does not affect other Colors but can be used to selectively adjust the 6 Color areas (Red/Green/Blue/Cyan/ Magenta/Yellow). Color difference may not be distinctive even when you make the adjustments for the general video. Adjusts Red/Green/Blue/Yellow/Cyan/Magenta. <ul style="list-style-type: none"> » Red/Green/Blue/Yellow/Cyan/Magenta Color: The adjustment range is -30 to +30. » Red/Green/Blue/Yellow/Cyan/Magenta Tint: The adjustment range is -30 to +30. (Function works in the following mode - Expert 1, Expert 2 Picture mode)

Aspect Ratio

Resize the image to view the image at its optimal size by pressing **ARC** button.

CAUTION

- If a fixed image displays on the screen for a long period of time, it will be imprinted and become a permanent disfigurement on the screen. This is “image burn” or “burn-in” and not covered by the warranty.
- If the aspect ratio is set to 4:3 for a long period of time, image burn may occur on the letterboxed area of the screen.

- **16:9** : The following selection will allow you to adjust the picture horizontally, in linear proportion, to fill the entire screen(useful for viewing 4:3 formatted DVDs).

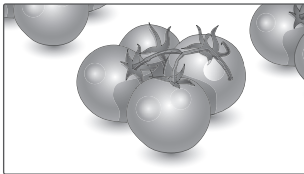

- **Just Scan** : Following Selection will lead to you view the picture of best quality without loss of original picture in high resolution image. Note: If there is noise in original Picture, You can see the noise at the edge.



- **Original** : The aspect ratio is not adjusted from the original. It is set by the program being watched.

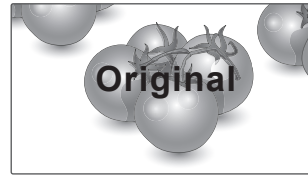

- **4:3** : The following selection will allow you to view a picture with an original 4:3 aspect ratio, gray bars will appear on both the left and right of the screen.

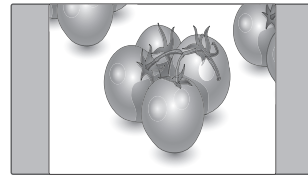

- **1:1** : The aspect ratio is not adjusted from the original. (Only HDMI/DVI PC, RGB PC)

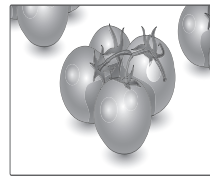

- **14:9** : You can view a picture format of 14:9 or a general Monitor set program in the 14:9 mode. The 14:9 screen is viewed in the same way as in 4:3, but is magnified to the left and right.

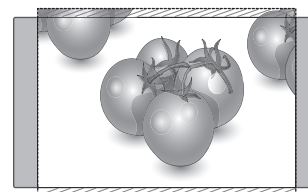

- **Zoom** : The following selection will allow you to view the picture without any alteration, while filling the entire screen. However, the top and bottom of the picture will be cropped.

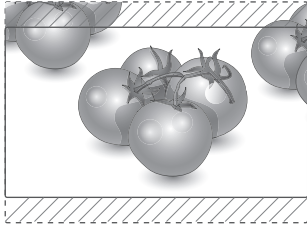

ARC \ MODE	AV	Component	HDMI/DVI		RGB
			DTV	PC	PC
16:9	o	o	o	o	o
Just Scan	x	o	o	x	x
Original	o	x	x	x	x
4:3	o	o	o	o	o
1:1	x	x	x	o	o
14:9	o	o	o	x	x
Zoom	o	o	o	x	x
Cinema Zoom 1	o	o	o	x	x
Full Wide	o	x	x	x	x

- **Cinema Zoom 1** : Choose Cinema Zoom when you want to enlarge the picture in correct proportion. Note: When enlarging or reducing the picture, the image may become distorted.

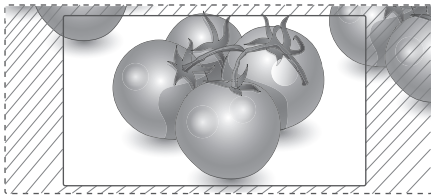

- **Full Wide** : When Monitor set receives the wide screen signal, it will lead you to adjust the picture horizontally or vertically, in a linear proportion, to fill the entire screen fully.

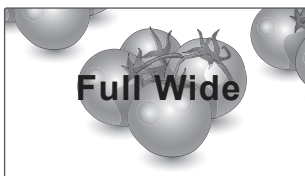

AUDIO settings

- 1 Press **MENU** to access the main menus.
- 2 Press the Navigation buttons to scroll to **AUDIO** and press **OK**.
- 3 Press the Navigation buttons to scroll to the setting or option you want and press **OK**.
 - To return to the previous level, press **BACK**.
- 4 When you are finished, press **EXIT**.
When you return to the previous menu, press **BACK**.

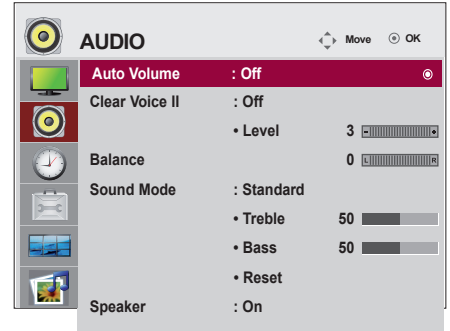

The available audio options are described in the following:

Setting	Description	
Auto Volume	To adjust uneven sound volumes across all channels or signals automatically to the most appropriate level. To use this feature, select On.	
Clear Voice II	By differentiating the human sound range from others, it helps users listen to human voices better.	
Balance	Adjusts balance between the left and right speakers according to your room environment.	
Sound Mode	Selects one of the preset sound modes or customize each option in each mode.	
	Mode	
	Standard	Select when you want standard-quality sound.
	Music	Select when you listen to music.
	Cinema	Select when you watch movies.
	Sport	Select when you watch sports events.
Game	Select when you watch game events.	
Speaker	ON: Enables sound to the monitor speaker. (* The monitor speaker is sold separately.) OFF: Disables sound to the monitor speaker. Use this option when using an external sound device.	

TIME settings

- 1 Press **MENU** to access the main menus.
- 2 Press the Navigation buttons to scroll to **TIME** and press **OK**.
- 3 Press the Navigation buttons to scroll to the setting or option you want and press **OK**.
 - To return to the previous level, press **BACK**.
- 4 When you are finished, press **EXIT**.
When you return to the previous menu, press **BACK**.

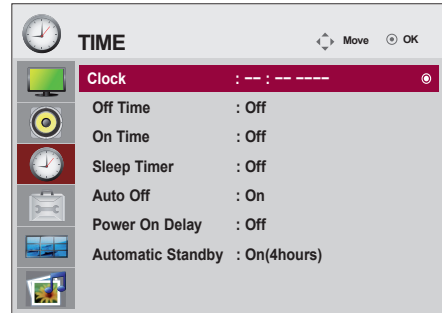

The available time settings are described in the following:

Setting	Description
Clock	Sets the time feature.
On/Off Time	Sets the time to turn on or off the Monitor set.
Sleep Timer	Sets the length of time until the Monitor set to turns off. When you turn the Monitor set off and turn it on again, the Sleep Timer will be set to off.
Auto off	If Auto off is active and there is no input signal, the set switches to off mode automatically after 10 minutes.
Power on delay	When connecting multiple monitors and turning the power on, the monitors are turned on individually to prevent overload.
Automatic Standby	If you do not use the monitor for more than 4 hours, it will be in standby mode automatically.

NOTE

- Once the on or off time is set, these functions operate daily at the preset time.
- The scheduled power-off function works properly only when the device time is set correctly.
- When the scheduled power-on and power-off times are the same, the power-off time has priority over the power-on time if the set is turned on, and vice versa if the set is turned off.
- The '**Automatic Standby**' function may not be available depending on the country.

OPTION settings

- 1 Press **MENU** to access the main menus.
- 2 Press the Navigation buttons to scroll to **OPTION** and press **OK**.
- 3 Press the Navigation buttons to scroll to the setting or option you want and press **OK**.
 - To return to the previous level, press **BACK**.
- 4 When you are finished, press **EXIT**.
 - When you return to the previous menu, press **BACK**.

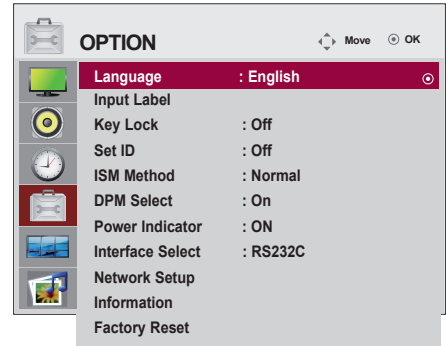

The available option settings are described in the following:

Setting	Description										
Language	To choose the language in which the control names are displayed.										
Input Label	Selects a label for an input source to identify a device connected to each input source. <div style="border: 1px solid black; padding: 5px; margin-top: 10px;"> <p>NOTE</p> <ul style="list-style-type: none"> • If you want to use HDMI-PC mode, you must set the input label to PC mode. </div>										
Key Lock	Use the buttons to select On or Off. The monitor can be set up so that it can only be used with the remote control. This feature can prevent unauthorized viewing. In order to lock the OSD screen adjustment, set the Key Lock tab to the 'On' position. In order to unlock it, do the following : Push the MENU button on the remote control and set Key Lock to the 'Off' position.										
Set ID	You can assign a unique Set ID NO (name assignment) to each product when several products are connected for display. Specify the number (1 to 99) using the button and exit. Use the assigned Set ID to individually control each product using the Product Control Program.										
ISM Method	A frozen or still picture from a PC/Video game displayed on the screen for prolonged periods could result in a ghost image remaining even when you change the image. Avoid allowing a fixed image to remain on the screen for a long period of time. <table border="1" style="width: 100%; margin-top: 10px;"> <thead> <tr> <th colspan="2">Setting</th> </tr> </thead> <tbody> <tr> <td>Normal</td> <td>Leave on normal if you don't foresee image burn in being a problem.</td> </tr> <tr> <td>Orbiter</td> <td>May help prevent ghost images. However, it is best not to allow any fixed image to remain on the screen. To avoid a permanent image on the screen, the screen will move every 2 minutes.</td> </tr> <tr> <td>Inversion</td> <td>This function inverts the panel color of the screen. The panel color is automatically inverted every 30 minutes.</td> </tr> <tr> <td>White wash</td> <td>White wash fills the screen with solid white. This helps removes permanent images burned into the screen. A permanent image may be impossible to clear entirely with white wash.</td> </tr> </tbody> </table>	Setting		Normal	Leave on normal if you don't foresee image burn in being a problem.	Orbiter	May help prevent ghost images. However, it is best not to allow any fixed image to remain on the screen. To avoid a permanent image on the screen, the screen will move every 2 minutes.	Inversion	This function inverts the panel color of the screen. The panel color is automatically inverted every 30 minutes.	White wash	White wash fills the screen with solid white. This helps removes permanent images burned into the screen. A permanent image may be impossible to clear entirely with white wash.
Setting											
Normal	Leave on normal if you don't foresee image burn in being a problem.										
Orbiter	May help prevent ghost images. However, it is best not to allow any fixed image to remain on the screen. To avoid a permanent image on the screen, the screen will move every 2 minutes.										
Inversion	This function inverts the panel color of the screen. The panel color is automatically inverted every 30 minutes.										
White wash	White wash fills the screen with solid white. This helps removes permanent images burned into the screen. A permanent image may be impossible to clear entirely with white wash.										
DPM Select	A user can choose to turn the power saving mode on / off.										
Power Indicator	Use this function to set the power indicator on the front side of the product to On or Off.										

Setting	Description
Interface Select	Sets up network connections.
	Option
	RS-232C Enables communication via Serial.
	Network LAN - Enables communication via Ethernet.
Network Setup	Option
	DHCP Allocates and sets up IP automatically.
	Manual Sets up IP address, Gateway, Subnet Mask, Primary DNS and Secondary DNS. The setup process is complete when you select Execute, and "IP Setup Completed" is displayed at the bottom of the screen. While "Wait for IP Setup" is displayed, you cannot use the local keys and remote control. "Wait for IP Setup" is displayed for up to 40 seconds. * If Network select is set to RS232C.DHCP and Manual are disabled.
Information	You can find informations about Serial No, F/W version, IP Address and MAC Address.
Factory Reset	Select this option to return to the default factory settings.

TILE settings

- 1 Press **MENU** to access the main menus.
- 2 Press the Navigation buttons to scroll to **TILE** and press **OK**.
- 3 Press the Navigation buttons to scroll to the setting or option you want and press **OK**.
 - To return to the previous level, press **BACK**.
- 4 When you are finished, press **EXIT**.
 - When you return to the previous menu, press **BACK**.

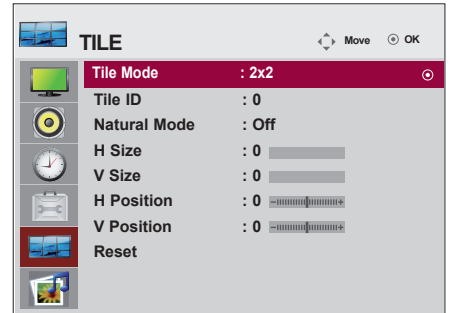

The available lock settings are described in the following:

Setting	Description
Tile Mode	To use this function <ul style="list-style-type: none"> - Must be displayed with various other products. - Must be in a function that can be connected to RGB Cable by distributor and RS-232C. Tile mode and choose Tile alignment and set the ID of the current product to set location. * Only after pressing the SET button the adjustments made to the settings will be saved. <ul style="list-style-type: none"> - Tile mode : column x row (c = 1, 2, 3, 4, 5 r = 1, 2, 3, 4, 5) - 5 x 5 available. - Configuration of an integration screen is also available as well as configuration of One by one Display.
Tile ID	Select the location of the Tile by setting an ID.
Natural	The image is omitted by the distance between the screens to be naturally shown.
H-Size	Adjust the horizontal size of the screen taking into account the size of the bezel.
V-Size	Adjust the vertical size of the screen taking into account the size of the bezel.
H-Position	Moving the screen position horizontally.
V-Position	Moving the screen position vertically.
Reset	Function to initialize and release Tile. All Tile setting are released when selecting Tile recall and the screen returns to Full screen.

Tile Mode

This monitor can be tiled with additional monitors to create a large tiled display.

• Off:
When the Tile Mode option is disabled

• 2X1:
When using 2 monitors

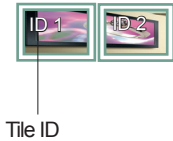

• 2X2:
When using 4 monitors



• 3X3:
When using 9 monitors



• 4X4:
When using 16 monitors



• 5X5:
When using 25 monitors



Tile Mode - Natural mode

When active, the part of the image that would normally be displayed in the gap between the monitors is omitted.

Before



After



ENTERTAINMENT

Using integrated media features

Connecting USB storage devices

Connect USB storage devices such as a USB flash memory, external hard drive, or MP3 player to the Monitor set and use multimedia features (“**Browsing files**” See p.27).

Connect a USB flash memory or USB memory card reader to the Monitor set as shown on the following illustration. The USB screen appears.

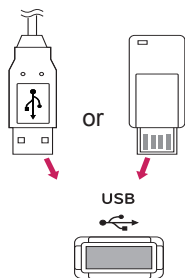

To disconnect a USB storage device, make sure to end the connection properly to prevent damages to the Monitor set or files.



CAUTION

- Do not turn the Monitor set off or remove a USB storage device while the USB storage device is connected to the Monitor set, as this could result in loss of files or damage to the USB storage device.
- Back up your files saved on a USB storage device frequently, as you may lose or damage the files and this may not be covered by the warranty.

Precautions when using the USB device

- Only a USB storage device is recognizable.
- If the USB storage device is connected through a USB hub, the device is not recognizable.
- A USB storage device using an automatic recognition program may not be recognized.
- A USB storage device which uses its own driver may not be recognized.
- The recognition speed of a USB storage device may depend on each device.
- Please do not turn off the Set or unplug the USB device when the connected USB storage device is working. When such device is suddenly separated or unplugged, the stored files or the USB storage device may be damaged.
- Please do not connect the USB storage device which was artificially maneuvered on the PC. The device may cause the product to malfunction or fail to be played. Never forget to use only a USB storage device which has normal music files or image files.
- Please use only a USB storage device which was formatted as a FAT16, FAT32, NTFS file system provided with the Windows operating system. In case of a storage device formatted as a different utility program which is not supported by Windows, it may not be recognized. Data in a USB storage device cannot be deleted in the NTFS file system.
- Please connect power to a USB storage device which requires an external power supply. If not, the device may not be recognized.
- Please connect a USB storage device with cable is offered by USB maker. If connected with cable is not offered by USB maker or an excessively long cable, the device may not be recognized.
- Some USB storage devices may not be supported or operated smoothly.
- Maximum of 999 files and folders can be recognized.
- Data in a USB storage device cannot be aligned. Up to 128 English characters can be

recognized as a file name.

- Please back up the important file because a data of USB device may be damaged. Data management is consumer's responsibility and in consequence the manufactures does not cover the product bearing data damage.
- If the USB is connected in Standby Mode, specific hard disk will automatically be loaded when the Set is turned on.
- The recommended capacity is 1TB or less for a USB external hard disk and 32GB or less for USB memory.
- Any device with more than the recommended capacity may not work properly.
- If a USB external hard disk with a "Power Saving" function does not work, turn the hard disk off and on again to make it work properly.
- Names and subtitles of some language files may not display properly.(Korean, Chinese, Japanese)
- When using Korean or Chinese subtitles or file names, it is recommended to set the language to the corresponding one.

Browsing files

Access the **Photo**, **Music** or **Movie** lists and browse files.

- 1 Connect a **USB** storage device.
- 2 Press **MENU** to access the main menus.
- 3 Press the Navigation buttons to scroll to **USB** and press **OK**.
- 4 Press the Navigation buttons to scroll to **PHOTO LIST**, **MUSIC LIST** or **MOVIE LIST** and press **OK**.

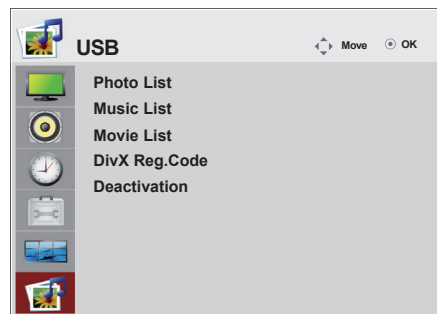
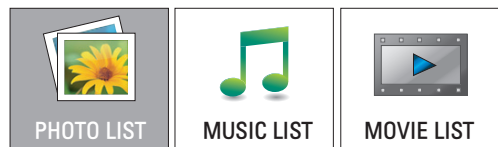

- 5 Select **Drive1** to access the connected USB storage device

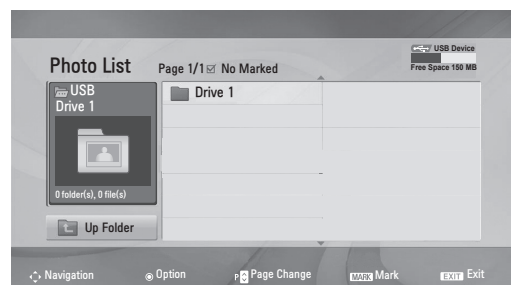

- 6 Select a folder you want.
 - To return to the previous level, select **Up Folder**.

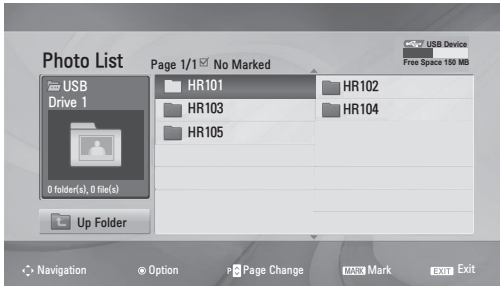

- 7 Press the Navigation buttons to browse files. The highlighted file will display in the preview window.

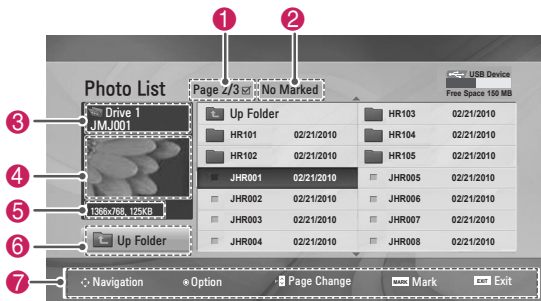

No.	Description
1	Current page number/total number of pages
2	The number of selected files
3	File and Folder name
4	Preview window
5	File size, information.
6	Return to the previous level
7	Available buttons on the remote control

Supported file format

Type	Supported file format
Photo	<ul style="list-style-type: none"> • JPG • Available size Baseline: 64 pixel (W) x 64 pixel (H) - 15360 pixel (W) x 8640 pixel (H) Progressive: 64 pixel (W) x 64 pixel (H) - 1024 pixel (W) x 768 pixel (H)
Music	<ul style="list-style-type: none"> • MP3 • Bit rate range 32 Kbps to 320 Kbps • Sampling rate (Sampling Frequency) MPEG1 layer 3: 32 kHz, 44.1 kHz, 48 kHz * A copy-protected file will not play.
Video	<ul style="list-style-type: none"> • MPEG1, MPEG2, MPEG4(Doesn't support Microsoft MPEG 4-V2, V3), DivX 3.xx, DivX 4.xx, DivX 5.xx, DivX VOD(DRM), XviD, DivX 6.xx(Playback) • Audio format: Mpeg, Mp3, PCM • Sampling frequency: within 32k to 48khz • Bit rate of audio format: within 32k to 320kbps • Supported subtitle format: *.smi, *.srt, *.sub (MicroDVD, SubViewer 2.0), *.ass, *.ssa, *.txt (DVD Subtitle System)

Viewing Photos

View image files saved in a USB storage device. The displays on the screen may differ from the model.

- 1 Press the Navigation buttons to scroll to **USB** and press **OK**.
- 2 Press the Navigation buttons to scroll to **Photo List** and press **OK**.
- 3 Press the Navigation buttons to select **Drive1** to access the connected USB storage device.
- 4 Press the Navigation buttons to scroll to a folder you want and press **OK**.
- 5 Press the Navigation buttons to scroll to a file you want and press **OK**.

A pop-up window will appear.

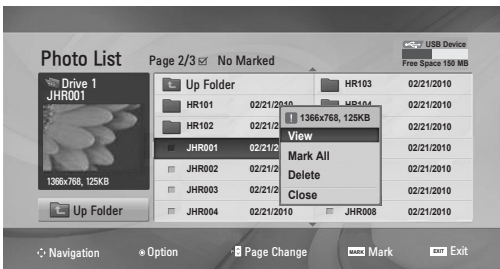

- 6 View photos by using the following menus.

Menu	Description
View	Displays the selected photo in a full-screen view. <ul style="list-style-type: none"> • Drive: Views photos saved in a USB storage drive.
Mark All or Unmark All	Selects all files or clears all of your selections
Delete	Deletes a file saved in a USB storage device. <div style="border: 1px solid black; padding: 5px; margin-top: 10px;"> <p>NOTE</p> <p>You cannot delete the files saved in a shared folder of a PC.</p> </div>
Close	Closes the pop-up menu.

Using photo options

Use the following options while viewing photos.

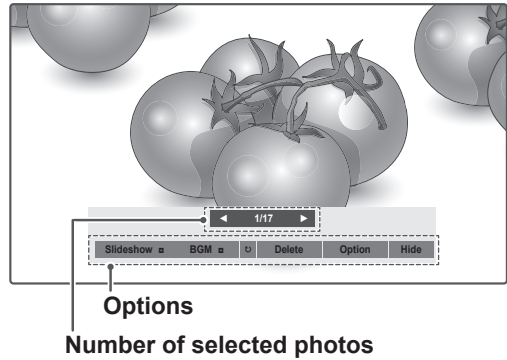

Option	Description
Slideshow	Starts or stops a slideshow with selected photos. If there are no selected photos, all photos saved in the current folder display during a slideshow. To set a slideshow speed, select Option .
BGM	Turns the background music on or off. To set the background music folder, select Option .
⌚ (Rotate)	Rotates photos clockwise (90°, 180°, 270°, 360°). <div style="border: 1px solid black; padding: 5px; margin-top: 10px;"> <p>NOTE</p> <p>The supported photo size is limited. You cannot rotate a photo if the resolution of the rotated width is larger than the supported resolution size.</p> </div>
Delete	Deletes a photo.
Option	<ul style="list-style-type: none"> • Slide Speed: Selects a slideshow speed (Fast, Medium, Slow). • Music Album: Selects a music folder for the background music. <div style="border: 1px solid black; padding: 5px; margin-top: 10px;"> <p>NOTE</p> <p>You cannot change the music folder while the background music is playing.</p> </div>
Hide	Hides the option window. To display the options, press OK .

Listening to Music

- 1 Press the Navigation buttons to scroll to **USB** and press **OK**.
- 2 Press the Navigation buttons to scroll to **Music List** and press **OK**.
- 3 Select **Drive1** to access the connected USB storage device.
- 4 Press the Navigation buttons to scroll to a folder you want and press **OK**.
- 5 Press the Navigation buttons to scroll to a file you want and press **OK**.

A pop-up window will appear.

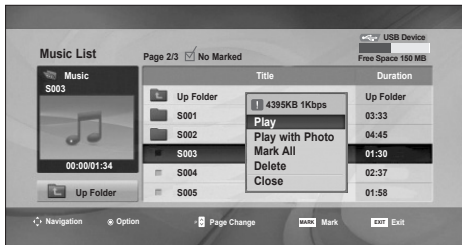

- 6 Play music by using the following menus.

Menu	Description
Play, Stop Play, or Play Marked	Plays music, stops playback, or plays the selected music file. If you play music without selecting music files, all of the music files saved in the current folder will play. The ♪ icon will appear in front of the duration on the currently playing file. • Drive: Listen to music files saved in a USB storage drive.
Play with Photo	Displays photos during playback.
Mark All or Unmark All	Selects all files or clears all of your selections
Delete	Deletes a file saved in a USB storage device.
Close	Closes the pop-up menu.

- 7 Control playback by using the following buttons.

Button	Description
■	Stops playback
▶	Plays a music file
⏸	Pauses or resumes playback
⏭	Skips to the next file
⏮	Skips to the previous file

NOTE

- A damaged or corrupted file will not play and the duration of the file display as 00:00.
- A copy-protected file will not play.
- If the Monitor set is not in use for some time during playback, the information box as a screensaver will appear to prevent image burn.
- To return to the Music list screen, press **OK**, ■ (stop) or **BACK**.

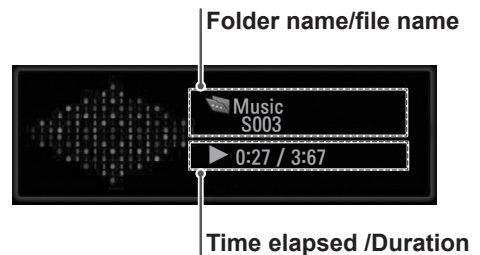

Viewing Movies

Play video files on the Monitor set. Your Monitor set displays all of the video files saved in a USB storage device.

- Movie (*.dat / *.mpg / *.mpeg / *.vob / *.m4v / *.avi / *.divx) supporting file.
- Video format: MPEG1, MPEG2, MPEG4(Doesn't support Microsoft MPEG 4-V2, V3), DivX 3.xx, DivX 4.xx, DivX 5.xx, DivX VOD(DRM), XviD, DivX 6.xx(Playback)
- Audio format: Mpeg, Mp3, PCM
- Bit rate: within 32 kbps to 320 kbps (MP3)
- Subtitle format: *.smi / *.srt / *.sub (Micro DVD, SubViewer 2.0) / *.ass / *.ssa / *.txt (DVD Subtitle System).
- Some user-created subtitles may not work properly.
- Some special characters are not supported in subtitles.
- HTML tags are not supported in subtitles.
- Subtitles in languages other than the supported languages are not available.
- Time information in an external subtitle file should be arranged in ascending order to be played.
- The screen may suffer temporary interruptions (image stoppage, faster playback, etc.) when the audio language is changed.
- A damaged movie file may not be played correctly, or some player functions may not be usable.
- Movie files produced with some encoders may not be played correctly.
- If the video and audio structure of recorded file is not interleaved, either video or audio is outputted.
- HD videos with a maximum of 1920 x 1080 @ 25/30P or 1280 x 720 @ 50/60P are supported, depending on the frame.
- Videos with resolutions higher than 1920 x 1080 @ 25/30P or 1280 x 720 @ 50/60P may not work properly depending on the frame.
- Movie files other than the specified types and formats may not work properly.
- **Max bit rate of playable movie file is 20 Mbps.**
- We do not guarantee smooth playback of profiles encoded level 4.1 or higher in H.264 / AVC.
- DTS Audio codec is not supported.

- A movie file more than 30GB in file size is not supported for playback.
- A DivX movie file and its subtitle file must be located in the same folder.
- A video file name and its subtitle file name must be identical for it to be displayed.
- Playing a video via a USB connection that doesn't support high speed may not work properly.
- Files encoded with GMC (Global Motion Compensation) may not be played.
- When you are watching the movie by Movie List function, you can adjust an image by **Energy Saving** key on the remote control. User setup for each image mode does not operate.

Video Decoder

- **mpg, mpeg, vob, dat:** MPEG1, MPEG2
- **avi, divx, m4v:** MPEG4 SP, MPEG4 ASP, DivX 3.xx, DivX 4.xx, DivX 5.xx, DivX 6.xx (Playback), XviD

Audio Codec

- **mpg, mpeg, vob, dat, avi, divx, m4v:** AC3, MPEG, MP3, PCM

Max Resolution

- **720 x 576 @ 25p**
- **720 x 480 @ 30p**

- 1 Press the Navigation buttons to scroll to **USB** and press **OK**.
- 2 Press the Navigation buttons to scroll to **Movie List** and press **OK**.
- 3 Select **Drive1** to access the connected USB storage device.
- 4 Press the Navigation buttons to scroll to a folder you want and press **OK**.
- 5 Press the Navigation buttons to scroll to a file you want and press **OK**.

A pop-up window will appear.

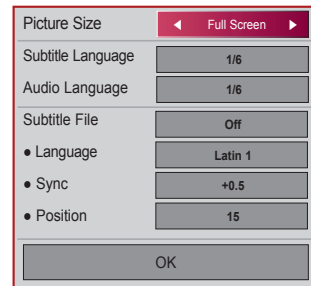
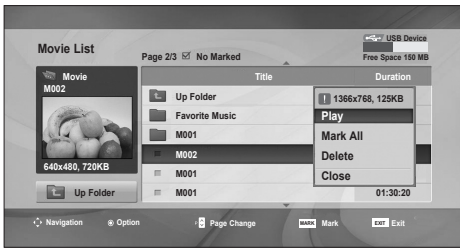

- 6 Play video by using the following menus.

Menu	Description
Play or Play Marked	Plays a movie or plays the selected movie. • Drive: Views videos saved in a USB storage drive.
Mark All or Unmark All	Selects all files or clears all of your selections.
Delete or Delete marked	Deletes a file formatted on the FAT32 file system and saved in a USB storage device.
Close	Closes the pop-up menu.

When you select the **Set Video Play**.

Menu	Description
Picture Size	Selects your desired picture format during movie play
Subtitle Language or Audio Language	Changes the Language Group of the subtitle/audio during movie play.
Language	Selects your desired Language.
Sync	Adjusts the time synchronisation of the subtitle from -10 secs to +10 secs by steps of 0.5 secs during movie play.
Position	Changes the position of the subtitle either up or down during movie play.

- 1 Press the Navigation button to show the **Picture Size, Audio Language or Subtitle Language**.
- 2 Press the Navigation button to make appropriate adjustments.

Subtitle Language	Support Language
Latin1	English, Spanish, French, German, Italian, Swedish, Finnish, Dutch, Portuguese, Danish, Romanian, Norwegian, Albanian, Gaelic, Welsh, Irish, Catalan, Valencian
Latin2	Bosnian, Polish, Croatian, Czech, Slovak, Slovenian, Serbian, Hungarian
Latin4	Estonian, Latvian, Lithuanian
Cyrillic	Bulgarian, Macedonian, Russian, Ukrainian, Kazakh
Greek	Greek
Hebrew	Hebrew
Chinese	Chinese
Korean	Korean

NOTE

- Only the files saved in ASCII CODE is supported for the external subtitles of the movie.
- Only 500 alphabets and 500 numbers are supported for each line of the subtitle.
- Only 10,000 of sync blocks can be supported within the subtitle file.

When you select the **Set Video**.

- 1 Press the Navigation button to make appropriate adjustments. See p.9

When you select the **Set Audio**,

- 1 Press the Navigation button to show the **Sound Mode, Auto Volume, Clear Voice II, Balance**.
- 2 Press the Navigation button to make appropriate adjustments.

Using the remote control.

Button	Description
◀▶	When playing, repeatedly, press the REW(◀) button to speed up ◀◀(x2) ◀◀◀(x4) ◀◀◀◀(x8) ◀◀◀◀◀(x16) ◀◀◀◀◀◀(x32) . repeatedly, press the FF(▶) button to speed up ▶▶(x2) ▶▶▶(x4) ▶▶▶▶(x8) ▶▶▶▶▶(x16) ▶▶▶▶▶▶(x32). • Pressing these buttons repeatedly increases the fast forward/reverse speed.
⏸ (II)	During playback, press the Pause (II) button. • Still screen is displayed. • If no buttons are pressed on the remote control for 10 minutes after pausing, the Monitor set returns to the playback state. • Press the Pause (II) button and then use the FF (▶▶) button for slow motion.
■	During playback, stops the screen.
▶ (Play)	Press the Play (▶) button to return to normal playback.

DivX registration code

Check and register the DivX registration code of your Monitor set so that you can rent or purchase the latest movies at www.divx.com/vod. To play a rented or purchased DivX file, the file's registration code should be same with your Monitor set's DivX registration code.

- 1 Press **MENU** to access the **USB** menus.
- 2 Press the Navigation button to scroll to **DivX Reg. Code** and press **OK**.
- 3 View the registration code of your Monitor set.

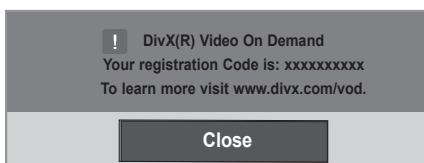

NOTE

- While you are checking the registration code, some buttons may not work.
- If you use the DivX registration code of another device, you cannot play the rented or purchased DivX file. Make sure to use the DivX registration code assigned to your Monitor set.
- The video or audio files that are not converted by the standard DivX codec may be corrupted or not be played.
- The DivX VOD code allows you to activate up to 6 devices under one account.

Deactivating the DivX feature

Deactivate all of the devices through the web server and block devices from activating. Delete the existing authentication information to receive a new DivX user authentication for the Monitor set. Once this function is executed, a DivX user authentication is required again to see DivX DRM files.

- 1 Press **MENU** to access the **USB** menus.
- 2 Press the Navigation button to scroll to **Deactivation** and press **OK**.
- 3 Select **Yes** to confirm.

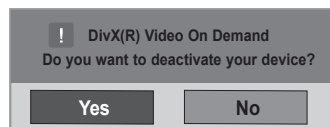

- 4 Select **Close**.



- 5 When you are finished, press **EXIT**. When you return to the previous menu, press **BACK**.

MAKING CONNECTIONS

Connect various external devices to the ports on the Monitor set's back panel.

- 1 Find an external device you want to connect to your Monitor set shown on the following illustration.
- 2 Check the connection type of the external device.
- 3 Go to the appropriate illustration and check the connection details.

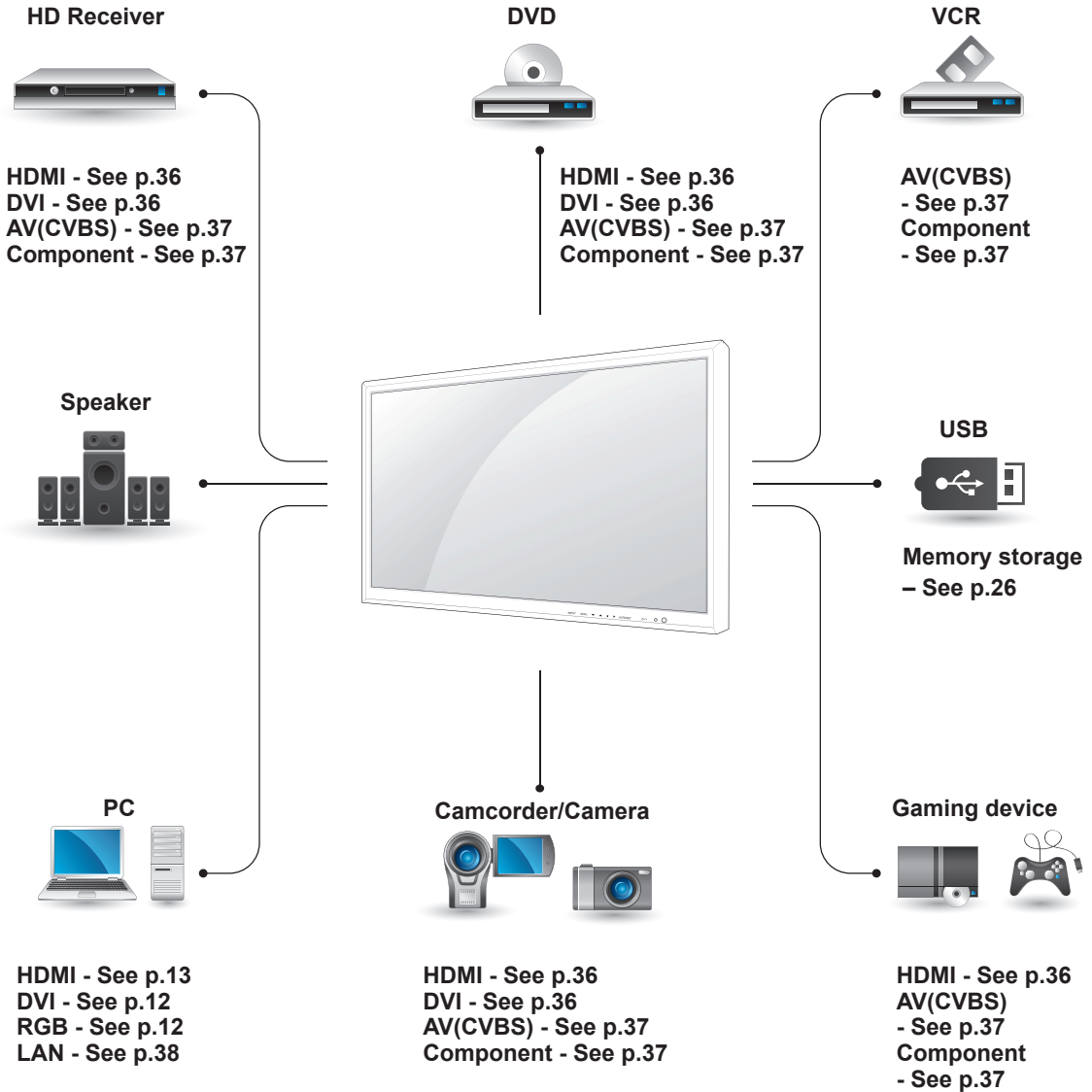

NOTE

- If you connect a gaming device to the Monitor set, use the cable supplied with the gaming device.

Connecting to a HD receiver, DVD, Camcorder, Camera, Gaming Device or VCR player

Connect a HD receiver, DVD, or VCR player to the Monitor set and select an appropriate input mode.

HDMI connection

Transmits the digital video and audio signals from an external device to the Monitor set. Connect the external device and the Monitor set with the HDMI cable as shown on the following illustration.

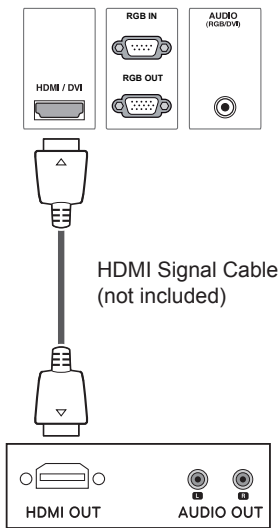

HDMI/DVI connection

Transmits the digital video signal from an external device to the Monitor set. Connect the external device and the Monitor set with the HDMI/DVI cable as shown in the following illustration. To transmit an audio signal, connect an optional audio cable.

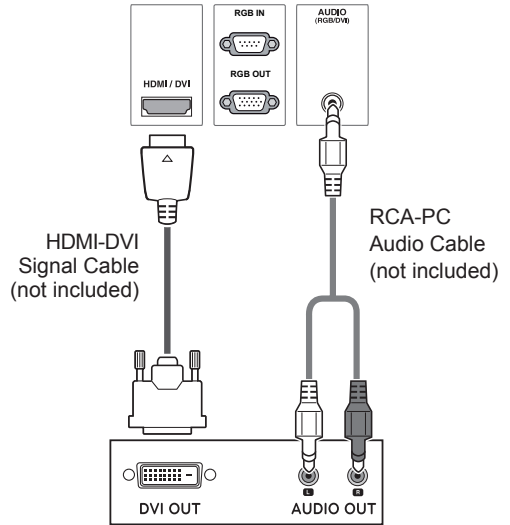

NOTE

- Use a High Speed HDMI™ Cable.
- High Speed HDMI™ Cables are tested to carry an HD signal up to 1080p and higher.

Component connection

Transmits the analog video and audio signals from an external device to the Monitor set. Connect the external device and the Monitor set with the component cable as shown on the following illustration. To display images by using progressive scan, make sure to use the component cable.

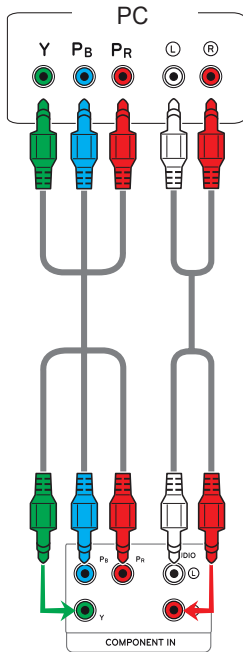

AV(CVBS) connection

Transmits the analog video and audio signals from an external device to the Monitor set. Connect the external device and the Monitor set with the BNC cable as shown on the following illustration.

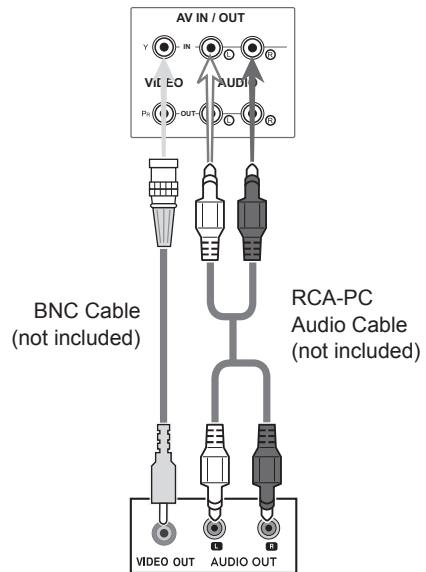

Connecting to the LAN

LAN connection

Connect the LAN cable and install the eZ-Net Manager program on the CD-ROM.

For more information about the program, please refer to eZ-Net Guide in the enclosed CD-ROM.

A Connect PC to Monitor directly.

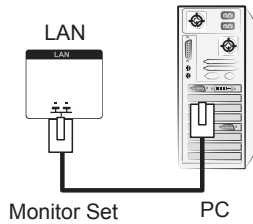

B Using a router(Switch)

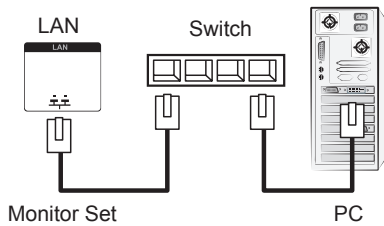

C Using the Internet.

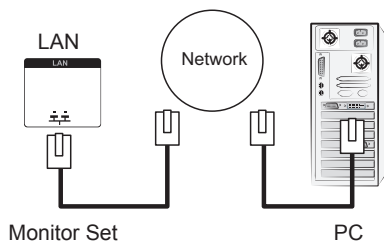

! NOTE

- Using LAN establishes communication between your PC and the monitor and enables to use the OSD menus on the PC as well as on the monitor.

Daisy Chain Monitors

Use this function to share the RGB video signal with other monitors without having to use a separate signal splitter box.

- To use different products connected to each other Connect one end of the signal input cable (15-pin D-Sub Signal Cable) to the RGB OUT connector of product 1 and connect the other end to the RGB IN connector of other products

RGB Mode

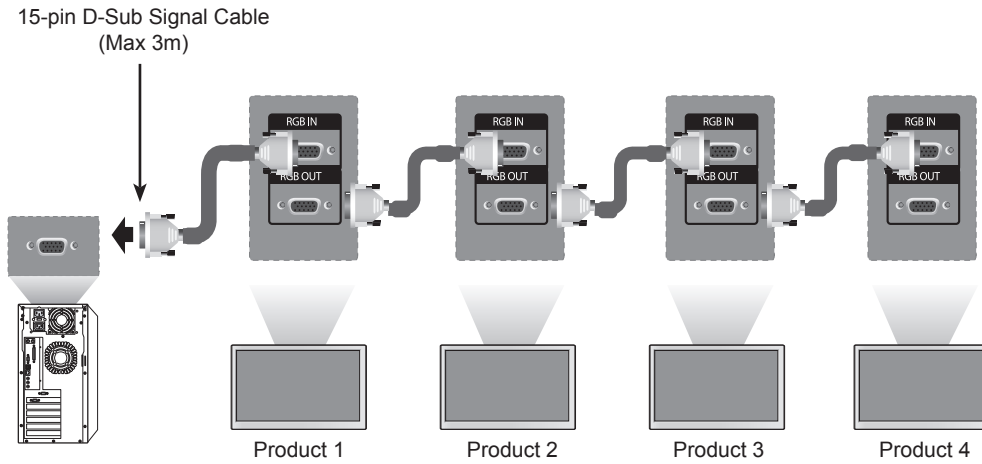

AV(CVBS) Mode

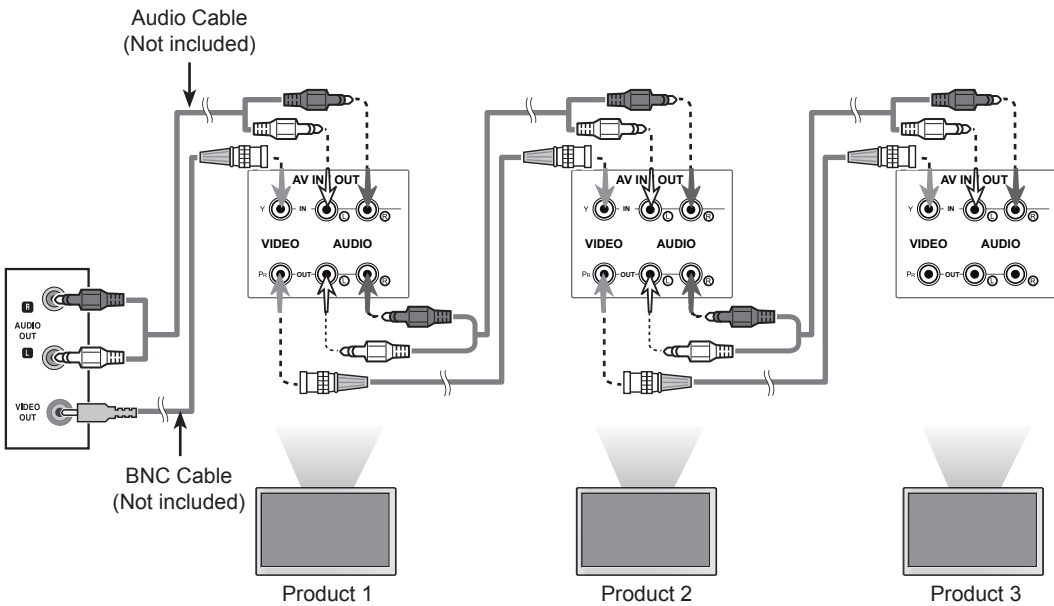

NOTE

- When multi-connecting in/out cascade format, no loss cables are recommended.
- We recommend that you should use cable distributor.

TROUBLESHOOTING

No image is displayed

Problem	Resolution
Is the product power cord connected?	<ul style="list-style-type: none"> • See if the power cord is properly connected to the outlet.
Is the power indicator light on?	<ul style="list-style-type: none"> • See if the power switch is turned on. • May need service.
Power is on, power indicator is blue but the screen appears extremely dark.	<ul style="list-style-type: none"> • Adjust brightness and contrast again. • Backlight may need repair.
The power indicator amber?	<ul style="list-style-type: none"> • If the product is in power saving mode, move the mouse or press any key. • Turn both devices off and then back on.
Does the 'Out of range' message appear?	<ul style="list-style-type: none"> • The signal from the PC (video card) is out of the vertical or horizontal frequency range of the product. Adjust the frequency range by referring to the Specifications in this manual. <p>* Maximum resolution RGB : 1920 x 1080 @ 60 Hz HDMI/DVI : 1920 x 1080 @ 60 Hz</p>
Does the 'Check signal cable' message appear?	<ul style="list-style-type: none"> • The signal cable between PC and product is not connected. Check the signal cable. • Press the 'INPUT' menu in the remote Control to check the input signal.

'Unknown Product' message appears when the product is connected.

Problem	Resolution
Did you install the driver?	<ul style="list-style-type: none"> • Install the product driver, which is provided with the product, or download it from the web site. (http://www.lg.com) • See if the plug&play function is supported by referring to the video card user manual.

'Key Lock On' message appears.

Problem	Resolution
The 'Key Lock On' message appears when pressing the Menu button.	<ul style="list-style-type: none"> The Lock function prevents the OSD settings from being changed inadvertently. To release the lock, go to Menu and Option and disable the Key Lock option.

The screen image looks abnormal.

Problem	Resolution
Is the screen position wrong?	<ul style="list-style-type: none"> D-Sub analog signal - Press the "AUTO" button in the remote control to automatically select the optimal screen status that fits into the current mode. If adjustment is not satisfactory, use the Position OSD menu. See if the video card resolution and frequency are supported by the product. If the frequency is out of range, set to the recommended resolution in the Control Panel "Display" Setting menu.
Do thin lines appear on the background screen?	<ul style="list-style-type: none"> D-Sub analog signal - Press the "AUTO" button in the remote control to automatically select an optimal screen status that fits into the current mode. If adjustment is not satisfactory, use the Clock OSD menu.
Horizontal noise appears or the characters look blurred.	<ul style="list-style-type: none"> D-Sub analog signal - Press the "AUTO" button in the remote control to automatically select an optimal screen status that fits into the current mode. If adjustment is not satisfactory, use the Phase OSD menu.
The screen is displayed abnormally.	<ul style="list-style-type: none"> The proper input signal is not connected to the signal port. Connect the signal cable that matches with the source input signal.

After-image appears on the product.

Problem	Resolution
After-image appears when the product is turned off.	<ul style="list-style-type: none"> If you use a fixed image for a long time, the pixels may be damaged quickly. Use the screen-saver function.

The audio function does not work.

Problem	Resolution
No sound?	<ul style="list-style-type: none"> • See if the audio cable is connected properly. • Adjust the volume. • See if the sound is set properly.
Sound is too dull.	<ul style="list-style-type: none"> • Select the appropriate equalize sound.
Sound is too low.	<ul style="list-style-type: none"> • Adjust the volume.

Screen color is abnormal.

Problem	Resolution
Screen has poor color resolution (16 colors).	<ul style="list-style-type: none"> • Set the number of colors to more than 24 bits (true color) Select Control Panel - Display - Settings - Color Table menu in Windows.
Screen color is unstable or mono-colored.	<ul style="list-style-type: none"> • Check the connection status of the signal cable. Or, re-insert the PC video card.
Do black spots appear on the screen?	<ul style="list-style-type: none"> • Several pixels (red, green, white or black color) may appear on the screen, which can be attributable to the unique characteristics of the LCD panel. It is not a malfunction of the LCD.

The operation does not work normally.

Problem	Resolution
The power suddenly turned off.	<ul style="list-style-type: none"> • Is the sleep timer set? • Check the power control settings. Power interrupted. • "CAUTION! FAN STOP!" If the power is turned off after this message appears, it means that the fan is out of order. In this case, contact your local service center.

SPECIFICATIONS

LCD Panel	Screen Type	1638.3 mm Wide (64.5 inch) TFT (Thin Film Transistor) LCD (Liquid Crystal Display) Panel. Visible diagonal size : 1638.3 mm
	Pixel Pitch	0.744 mm (H) x 0.744 mm (V)
Video Signal	Max. Resolution	RGB : 1920 X 1080 @ 60 Hz HDMI/DVI : 1920 X 1080 @ 60 Hz - It may not be supported depending on the OS or video card type.
	Recommended Resolution	RGB : 1920 X 1080 @ 60 Hz HDMI/DVI : 1920 X 1080 @ 60 Hz - It may not be supported depending on the OS or video card type.
	Horizontal Frequency	RGB : 30 kHz to 83 kHz HDMI/DVI : 30 kHz to 83 kHz
	Vertical Frequency	RGB : 56 Hz to 75 Hz HDMI/DVI : 56 Hz to 60 Hz
	Synchronization Type	Separate Sync, Composite Sync, Digital
Input Connector		15-pin D-Sub type, HDMI (digital), Composite Video, RS-232C, LAN
Power	Rated Voltage	AC 100-240 V~ 50/60 Hz 4.6 A
	Power Consumption	On Mode : 480 W Typ. Sleep Mode : ≤ 1 W (RGB) / 2 W (HDMI/DVI) Off Mode : ≤ 0.5 W
Environmental conditions	Operating Temperature	0 °C to 40 °C
	Operating Humidity	10 % to 80 %
	Storage Temperature	-20 °C to 60 °C
	Storage Humidity	5 % to 95 %

Product specifications shown above may be changed without prior notice due to upgrade of product functions.

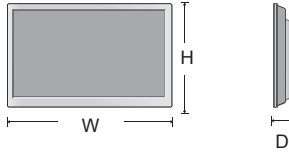
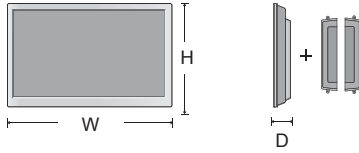
Dimensions (Width x Height x Depth) / Weight		
	1535.4 mm x 136.7 mm x 907.6 mm / 51.1 kg	
		
1535.4 mm x 136.7 mm x 907.6 mm / 51.85 kg		

*** Applicable only for models that support the speakers**

Audio	RMS Audio Output	10 W + 10 W (R + L)
	Input Sensitivity	0.7 Vrms
	Speaker Impedance	8 Ω

Product specifications shown above may be changed without prior notice due to upgrade of product functions.

Dimensions

The illustrations in this manual may differ from the actual product and accessories.
Please see the "Mounting on a wall" section for sizes of screws. (See p.8)

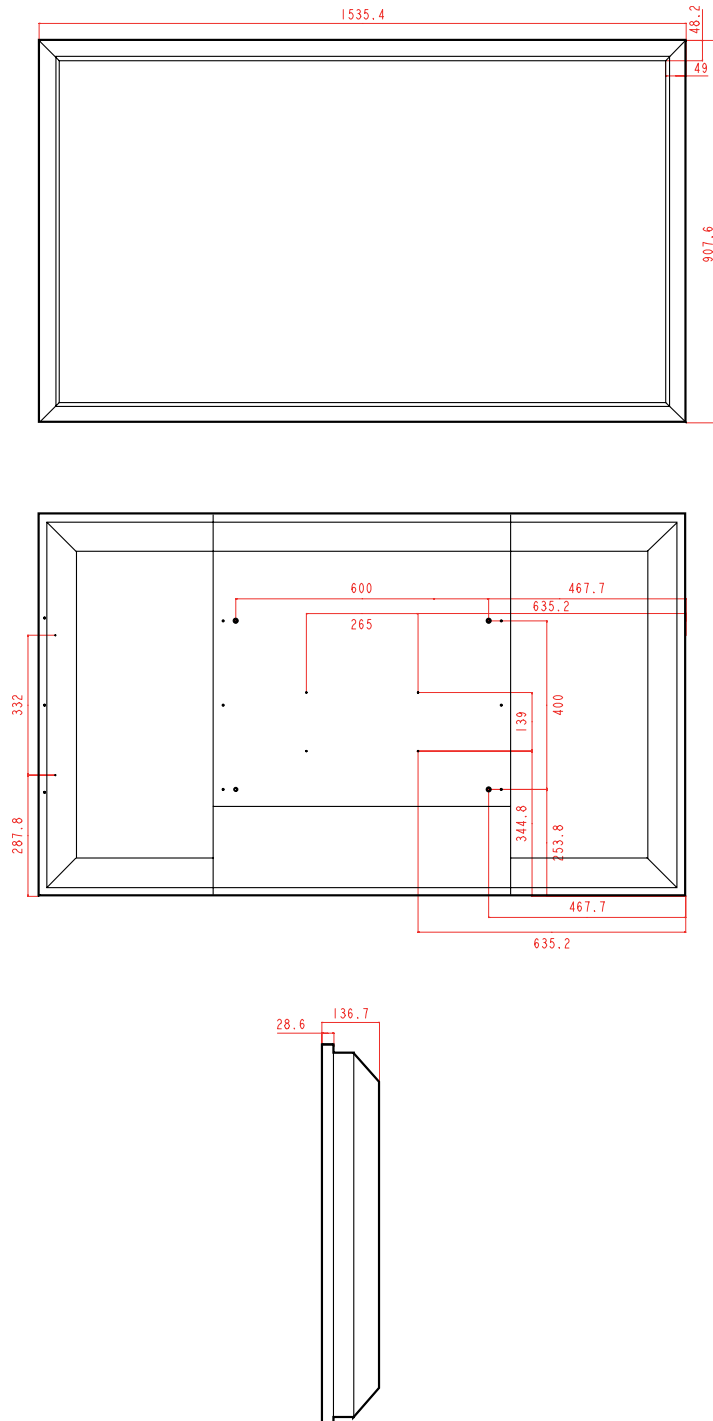

RGB (PC) supported mode

Resolution	Horizontal Frequency(kHz)	Vertical Frequency(Hz)
640 x 350	31.469	70.8
720 x 400	31.468	70.8
640 x 480	31.469	59.94
640 x 480	37.5	75
800 x 600	37.879	60.317
800 x 600	46.875	75
832 x 624	49.725	74.55
1024 x 768	48.363	60
1024 x 768	60.123	75.029
1280 x 720	44.772	59.855
1280 x 768	47.7	60
1360 x 768	47.72	59.799
1366 x 768	47.7	60
1280 x 1024	63.981	60.02
1280 x 1024	79.98	75.02
1680 x 1050	65.290	59.954
1920 x 1080	67.5	60

HDMI/DVI(PC) supported mode

Resolution	Horizontal Frequency(kHz)	Vertical Frequency(Hz)
640 x 480	31.469	59.94
800 x 600	37.879	60.317
1024 x 768	48.363	60
1280 x 720	44.772	59.855
1360 x 768	47.72	59.799
1366 x 768	47.7	60
1280 x 1024	63.981	60.02
1680 x 1050	65.290	59.954
1920 x 1080	67.5	60

DTV Mode

Resolution	Component	HDMI/DVI (DTV)
480i	o	x
576i	o	x
480p	o	o
576p	o	o
720p	o	o
1080i	o	o
1080p	o	o

Power Indicator

Mode	Product
On Mode	Green
Sleep Mode	Amber
Off Mode	-

NOTE

- DTV/PC selection on RGB and HDMI/DVI inputs is available for PC resolutions : 640 x 480 / 60 Hz, 1280 x 720 / 60 Hz, 1920 x 1080 / 60 Hz and DTV resolutions : 480p, 720p, 1080p.

NOTE

- Vertical frequency: To enable the user to watch the product display, screen image should be changed tens of times every second like a fluorescent lamp. The vertical frequency or refresh rate is the times of image display per second. The unit is Hz.
- Horizontal frequency: The horizontal interval is the time to display one horizontal line. When 1 is divided by the horizontal interval, the number of horizontal lines displayed every second can be tabulated as the horizontal frequency. The unit is kHz.

IR CODES

- This feature is not available for all models.

Code (Hexa)	Function	Note
95	Energy Saving (e0)	R/C BUTTON
08	⏻ (POWER)	R/C BUTTON (POWER ON/OFF)
0B	INPUT	R/C BUTTON
C4	Monitor On	R/C BUTTON (Discrete IR Code)
C5	Monitor Off	R/C BUTTON (Discrete IR Code)
79	ARC (MARK)	R/C BUTTON (Discrete IR Code)
43	MENU	R/C BUTTON
40	Up (^)	R/C BUTTON
41	Down (v)	R/C BUTTON
07	Left (<)	R/C BUTTON
06	Right (>)	R/C BUTTON
44	OK(⊙)	R/C BUTTON
28	BACK(↶)	R/C BUTTON
5B	EXIT	R/C BUTTON
4D	PSM	R/C BUTTON
02	▴ (+)	R/C BUTTON
03	▾ (-)	R/C BUTTON
09	MUTE	R/C BUTTON
E0	Brightness ^ (Page UP)	R/C BUTTON
E1	Brightness v (Page Down)	R/C BUTTON
10 to 19	Number Key 0 to 9	R/C BUTTON
72	Red Key	R/C BUTTON
71	Green Key	R/C BUTTON
63	Yellow Key	R/C BUTTON
61	Blue Key	R/C BUTTON
7B	TILE	R/C BUTTON
5A	AV(CVBS)	Discrete IR Code (Input AV Selection)
BF	Component	Discrete IR Code (Input Component Selection)
D5	RGB PC	Discrete IR Code (Input RGB PC Selection)
C6	HDMI/DVI	Discrete IR Code (Input HDMI/DVI Selection)
76	ARC (4:3)	Discrete IR Code (Only 4 : 3 mode)
77	ARC (16:9)	Discrete IR Code (Only 16 : 9 mode)
AF	ARC (ZOOM)	Discrete IR Code (Only Zoom, Cinema Zoom 1 mode)
99	Auto Config.	R/C BUTTON (Discrete IR Code)
B1	■	R/C BUTTON
B0	▶	R/C BUTTON
BA		R/C BUTTON
8F	◀	R/C BUTTON
8E	▶▶	R/C BUTTON

CONTROLLING THE MULTIPLE PRODUCT

- Use this method to connect several products to a single PC. You can control several products at a time by connecting them to a single PC.
- In the Option menu, Set ID must be between 1 and 99 without being duplicated.

Connecting the cable

Connect the RS-232C cable as shown in the picture.

- The RS-232C protocol is used for communication between the PC and product. You can turn the product on/off, select an input source or adjust the OSD menu from your PC.

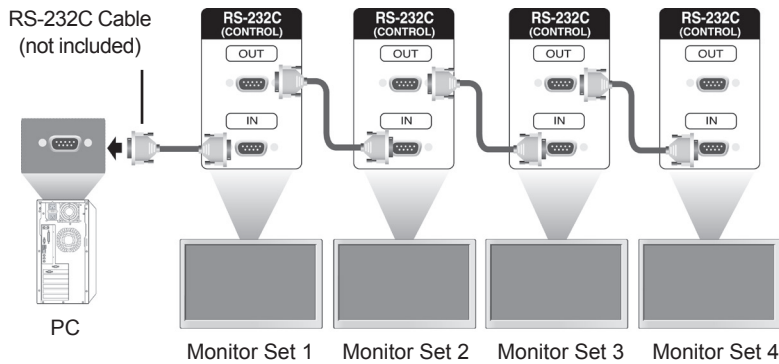

RS-232C Configurations

7-Wire Configurations (Standard RS-232C cable)

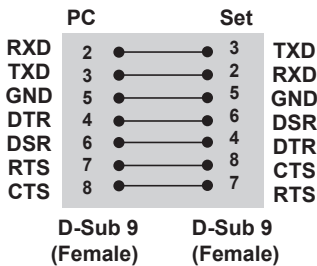

3-Wire Configurations (Not Standard)

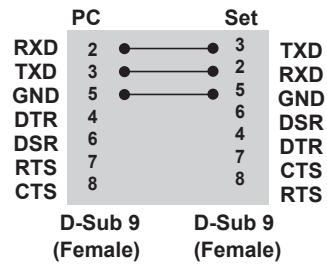

Communication Parameter

- Baud Rate : 9600 baud Rate (UART)
- Data Length : 8 bit
- Parity Bit : None
- Stop Bit : 1bit
- Flow Control : None
- Communication Code : ASCII code
- Use a crossed (reverse) cable

Command reference list

	COMMAND		DATA		
	1	2	1	2	3
01. Power	k	a	00H to 01H		
02. Input Select	k	b	02H to 09H		
03. Aspect Ratio	k	c	01H to 1FH		
04. Screen Mute	k	d	00H to 01H		
05. Volume Mute	k	e	00H to 01H		
06. Volume Control	k	f	00H to 64H		
07. Contrast	k	g	00H to 64H		
08. Brightness	k	h	00H to 64H		
09. Color	k	i	00H to 64H		
10. Tint	k	j	00H to 64H		
11. Sharpness	k	k	00H to 64H		
12. OSD Select	k	l	00H to 01H		
13. Remote Lock/ key Lock	k	m	00H to 01H		
14. Balance	k	t	00H to 64H		
15. Color Temperature	k	u	00H to 02H		
16. Abnomal state	k	z	FFH		
17. ISM mode	j	p	01H to 08H		
18. Auto configuration	j	u	01H		
19. Key	m	c	Key Code		
20. Tile Mode	d	d	00H to 55H		
21. Tile H Position	d	e	00H to 14H		
22. Tile V Position	d	f	00H to 14H		
23. Tile H Size	d	g	00H to 64H		
24. Tile V Size	d	h	00H to 64H		
25. Tile ID Set	d	i	00H to 19H		
26. Natural Mode (In Tile mode)	d	j	00H to 01H		
27. Picture mode (PSM)	d	x	00H to 06H		
28. Sound mode	d	y	00H to 05H		
29. Fan Fault check	d	w	FFH		
30. Elapsed time return	d	l	FFH		
31. Temperature value	d	n	FFH		
32. Lamp fault check	d	p	FFH		
33. Auto Volume	d	u	00H to 01H		
34. Speaker	d	v	00H to 01H		
35. Time	f	a	00H to 06H	00H to 17H	00H to 3BH
36. On Timer (On/Off Timer) Time	f	d	F1H to F4H E0H to E4H 01H to 80H	00H to 17H	00H to 3BH
37. Off Timer (On/Off Timer) Time	f	e	F1H to F4H E0H to E4H 01H to 80H	00H to 17H	00H to 3BH
38. Scheduling input select	f	u	F1H to F4H	02H to 09H	

	COMMAND		DATA		
	1	2	1	2	3
39. Sleep Time	f	f	00H to 08H		
40. Auto Sleep	f	g	00H to 01H		
41. Power On Delay	f	h	00H to 64H		
42. Language	f	i	00H to 09H		
43. DPM Select	f	j	00H to 01H		
44. Reset	f	k	00H to 02H		
45. Power Saving	f	l	00H to 03H		
46. Power Indicator	f	o	00H to 01H		
47. Serial no.	f	y	FFH		
48. S / W Version	f	z	FFH		
49. Input Select	x	b	20H to A0H		

- Note : During USB operations such as Dvix or EMF, all commands except Power(ka) and Key(mc) are not executed and treated as NG.

Transmission / Receiving protocol

Transmission

[Command1][Command2][][Set ID][][Data][Cr]

* [Command 1]: First command. (k, j, m, d, f, x)

* [Command 2]: Second command.(a to u)

* [Set ID]: Set up the Set ID number of product.

range : 01H to 63H. by setting '0', server can control all products.

* In case of operating with more than 2 sets using set ID as '0' at the same time, it should not be checked the ack message. Because all sets will send the ack message, so it's impossible the check the whole ack messages.

* [DATA]: To transmit command data.

Transmit 'FF' data to read status of command.

* [Cr]: Carriage Return (ASCII code '0 x 0 D')

* []: ASCII code Space (0 x 20)

OK Acknowledgement

[Command2][][Set ID][][OK][Data][x]

* The Product transmits ACK (acknowledgement) based on this format when receiving normal data. At this time, if the data is data read mode, it indicates present status data. If the data is data write mode, it returns the data of the PC computer.

Error Acknowledgement

[Command2][][Set ID][][NG][Data][x]

* If there is error, it returns NG

01. Power (Command: k a)

To control Power On/Off of the set.

Transmission

[k][a][][Set ID][][Data][Cr]

Data 00 : Power Off Data 01 : Power On

Acknowledgement

[a][][Set ID][][OK][Data][x]

To show the status of Power On/Off.

Transmission

[k][a][][Set ID][][FF][Cr]

Acknowledgement

[a][][Set ID][][OK][Data][x]

Data 00 : Power Off Data 01 : Power On

02. Input Select (Command: k b) (Main Picture Input)

To select input source for the Set.

You can also select an input source using the INPUT button on the remote control.

Transmission

[k][b][][Set ID][][Data][Cr]

Data 02 : AV(CVBS)
04 : Component
07 : RGB (PC)
08 : HDMI (DTV)
09 : HDMI (PC)

Acknowledgement

[b][][Set ID][][OK][Data][x]

Data 02 : AV(CVBS)
04 : Component
07 : RGB (PC)
08 : HDMI (DTV)
09 : HDMI (PC)

03. Aspect Ratio (Command: k c)

To adjust the screen format.

You can also adjust the screen format using the ARC (Aspect Ratio Control) button on remote control or in the Screen menu.

Transmission

[k][c][][Set ID][][Data][Cr]

Data 01 : Normal Screen (4 : 3)
02 : Wide Scran (16 : 9)
04 : Zoom (AV(CVBS))
06 : Original (AV(CVBS))
07 : 14 : 9 (AV(CVBS))
09 : Just Scan (HD DTV)
* When the RGB, HDMI / DVI PC mode(1:1)
10 to 1F : Cinema Zoom 1 to 16
B : Full Wide

Acknowledgement

[c][][Set ID][][OK][Data][x]

04. Screen Mute (Command: k d)

To select screen mute on / off.

Transmission

[k][d][][Set ID][][Data][Cr]

Data 00 : Screen mute off (Picture on)
01 : Screen mute on (Picture off)

Acknowledgement

[d][][Set ID][][OK][Data][x]

05. Volume Mute (Command: k e)

To control On/Off of the Volume Mute.

Transmission

[k][e][][Set ID][][Data][Cr]

Data 00 : Volume Mute On (Volume Off)
01 : Volume Mute Off (Volume On)

Acknowledgement

[e][][Set ID][][OK][Data][x]

Data 00 : Volume Mute On (Volume Off)
01 : Volume Mute Off (Volume On)

06. Volume Control (Command: k f)

To adjust Volume.

Transmission

[k][f][][Set ID][][Data][Cr]

Data Min : 00H to Max : 64H
(Hexadecimal code)

Acknowledgement

[f][][Set ID][][OK][Data][x]

Data Min : 00H to Max : 64H

* Real data mapping

0 : STEP 0
:
A : STEP 10
:
F : STEP 15
10 : STEP 16
:
64 : STEP 100

07. Contrast (Command: k g)

To adjust screen contrast.

You can also adjust the contrast in the Picture menu.

Transmission

[k][g][][Set ID][][Data][Cr]

Data Min : 00H to Max : 64H

Acknowledgement

[g][][Set ID][][OK][Data][x]

Data Min : 00H to Max : 64H

* Refer to 'Real data mapping '. See p.53

08. Brightness (Command: k h)

To adjust screen brightness.

You can also adjust the brightness in the Picture menu.

Transmission

[k][h][][Set ID][][Data][Cr]

Data Min : 00H to Max : 64H
(Hexadecimal code)

* Refer to 'Real data mapping '. See p.53

Acknowledgement

[h][][Set ID][][OK][Data][x]

* Refer to 'Real data mapping '. See p.53

09. Color (Command: k i) (Video Timing only)

To adjust the screen color.

You can also adjust the color in the Picture menu.

Transmission

[k][i][][Set ID][][Data][Cr]

Data Min : 00H to Max : 64H
(Hexadecimal code)

* Refer to 'Real data mapping '. See p.53

Acknowledgement

[i][][Set ID][][OK][Data][x]

Data Min : 00H to Max : 64H

10. Tint (Command: k j)

To adjust the screen tint.

You can also adjust the tint in the Picture menu.

Transmission

[k][j][][Set ID][][Data][Cr]

Data Min : 00H to Max : 64H
(Hexadecimal code)

00H : Step R50

64H : Step G50

Acknowledgement

[j][][Set ID][][OK][Data][x]

Data Min : 00H to Max : 64H

* Tint Real data mapping

0 : Step 0 to Red

:

64 : Step 100 to Green

11. Sharpness (Command: k k) (Video input only)

To adjust the screen Sharpness.
You can also adjust the sharpness in the Picture menu.

Transmission

[k][k][][Set ID][][Data][Cr]

Data Min : 00H to Max : 64H
(Hexadecimal code)

* Refer to 'Real data mapping '. See p.53

Acknowledgement

[k][][Set ID][][OK][Data][x]

Data Min : 00H to Max : 64H

12. OSD Select (Command: k l)

To control OSD on/off to the set.

Transmission

[k][l][][Set ID][][Data][Cr]

Data 00: OSD Off Data 01: OSD On

Acknowledgement

[l][][Set ID][][OK][Data][x]

Data 00: OSD Off Data 01: OSD On

13. Remote Lock /Key Lock (Command: k m)

To control Remote Lock on/off to the set.
This function, when controlling RS-232C, locks the remote control and the local keys.

Transmission

[k][m][][Set ID][][Data][Cr]

Data 00: Off Data 01: On

Acknowledgement

[m][][Set ID][][OK][Data][x]

Data 00: Off Data 01: On

14. Balance (Command: k t)

To adjust the sound balance.

Transmission

[k][t][][Set ID][][Data][Cr]

Data Min : 00H to Max : 64H
(Hexadecimal code)

00H : Step L50

64H : Step R50

Acknowledgement

[t][][Set ID][][OK][Data][x]

Data Min : 00H to Max : 64H
(Hexadecimal code)

00H : Step 0 to L50

64H : Step 100 to R50

* Balance : L50 to R50

15. Color Temperature (Command: k u)

To adjust the screen color temperature.

Transmission

[k][u][][Set ID][][Data][Cr]

Data 00 : Medium
01 : Cool
02 : Warm

Acknowledgement

[u][][Set ID][][OK][Data][x]

Data 00 : Medium
01 : Cool
02 : Warm

16. Abnormal state (Command: k z)

Used to Read the power off status when Stand-by mode.

Transmission

[k][z][][Set ID][][Data][Cr]

Data FF : Read

Acknowledgement

[z][][Set ID][][OK][Data][x]

Data 00 : Normal (Power on and signal exist)
01 : No signal (Power on)
02 : Turn the monitor off by remote control
03 : Turn the monitor off by sleep time function
04 : Turn the monitor off by RS-232C function
08 : Turn the monitor off by off time function
09 : Turn the monitor off by auto off function

17. ISM mode (Command: j p)

Used to select the afterimage preventing function.

Transmission

[j][p][][Set ID][][Data][Cr]

Data 01 : Inversion
02 : Orbiter
04 : White Wash
08 : Normal

Acknowledgement

[p][][Set ID][][OK][Data][x]

18. Auto Configure (Command: j u)

To adjust picture position and minimize image shaking.

Automatically. NB : Only applies to RGB(PC) mode.

Transmission

[j][u][][Set ID][][Data][Cr]

Data 01 : To set

Acknowledgement

[u][][Set ID][][OK][Data][x]

19. Key (Command: m c)

To send IR remote key code.

Transmission

[m][c][][Set ID][][Data][Cr]

Data Key code : Refer to 'IR CODES'. See p.47

Acknowledgement

[c][][Set ID][][OK][Data][x]

20. Tile Mode (Command: d d)

Change a Tile Mode.

Transmission

[d][d][][Set ID][][Data][Cr]

Data	Description
00 or 11	Tile mode is off.
12	1 x 2 mode (column x row)
13	1 x 3 mode
14	1 x 4 mode
...	...
55	1 x 2 mode

* The data can not be set to 0X or X0 except 00.

Acknowledgement

[d][][Set ID][][OK/NG][Data][x]

21. Tile H Position (Command: d e)

To set the Horizontal position.

Transmission

[d][e][][Set ID][][Data][Cr]

Data Min : 00H to Max : 14H

00H : Step -10(Left)

14H : Step 10(Right)

Acknowledgement

[e][][Set ID][][OK/NG][Data][x]

22. Tile V Position (Command: d f)

To set the Vertical position.

Transmission

[d][f][][Set ID][][Data][Cr]

Data Min : 00H to Max : 14H

00H : Step -10(Down)

14H : Step 10(Up)

Acknowledgement

[f][][Set ID][][OK/NG][Data][x]

23. Tile H Size (Command: d g)

To set the Horizontal size.

Transmission

[d][g][][Set ID][][Data][x]

Data Min : 00H to Max : 64H

* Refer to 'Real data mapping'. See p.53

Acknowledgement

[g][][Set ID][][OK/NG][Data][x]

24. Tile V Size (Command: d h)

To set the Vertical size.

Transmission

[d][h][][Set ID][][Data][x]

Data Min : 00H to Max : 64H

* Refer to 'Real data mapping'. See p.53

Acknowledgement

[h][][Set ID][][OK/NG][Data][x]

25. Tile ID Set (Command: d i)

To assign the Tile ID for Tiling function.

Transmission

[d][i][][Set ID][][Data][x]

Data Min : 00H to Max : 19H

(Hexadecimal code)

Acknowledgement

[i][][Set ID][][OK/NG][Data][x]

26. Natural Mode (Command: d j)

To assign the Tile Natural mode for Tiling function.

Transmission

[d][j][][Set ID][][Data][x]

Data 00 : Natural Off

01 : Natural On

ff : Read Status

Acknowledgement

[j][][Set ID][][OK/NG][Data][x]

27. Picture Mode (Command: d x)

To adjust the picture mode.

Transmission

[d][x][][Set ID][][Data][x]

Data Structure

Data(Hex)	Mode
00	Vivid
01	Standard
02	Cinema
03	Sport
04	Game
05	Export 1
06	Export 2

Acknowledgement

[x][][Set ID][][OK/NG][Data][x]

28. Sound Mode (Command: d y)

To adjust the Sound mode.

Transmission

[d][y][][Set ID][][Data][x]

Data Structure

Data(Hex)	Mode
01	Standard
02	Music
03	Cinema
04	Sport
05	Game

Acknowledgement

[y][][Set ID][][OK/NG][Data][x]

29. Fan Fault check (Command: d w)

To check the Fan fault of the Set.

Transmission

[d][w][][Set ID][][Data][x]

* The data is always FF (in Hex).

Data ff : Read Status

Acknowledgement

[w][][Set ID][][OK/NG][Data][x]

* Data is the status value of the Fan fault.

Data 00 : Fan fault

01 : Fan Ok

02 : N/A (Not Available)

32. Lamp fault Check (Command: d p)

To check lamp fault.

Transmission

[d][p][][Set ID][][Data][x]

* The data is always FF (in Hex).

Acknowledgement

[p][][Set ID][][OK/NG][Data][x]

* The data is 1 byte long in Hexadecimal.

Data 00 : Lamp Fault

01 : Lamp Ok

02 : N/A (DPM/Power Off)

30. Elapsed time return (Command: d l)

To read the elapsed time.

Transmission

[d][l][][Set ID][][Data][x]

* The data is always FF (in Hex).

Acknowledgement

[l][][Set ID][][OK/NG][Data][x]

* The data is always FF (in Hex).

(Hexadecimal code)

33. Auto volume (Command: d u)

Automatically adjust the volume level.

Transmission

[d][u][][Set ID][][Data][x]

Data 00: Off Data 01: On

Acknowledgement

[u][][Set ID][][OK/NG][Data][x]

31. Temperature value (Command: d n)

To read the inside temperature value.

Transmission

[d][n][][Set ID][][Data][x]

* The data is always FF (in Hex).

Acknowledgement

[n][][Set ID][][OK/NG][Data][x]

* The data is 1 byte long in Hexadecimal.

34. Speaker (Command: d v)

Turn the speaker on or off.

Transmission

[d][v][][Set ID][][Data][x]

Data 00: Off Data 01: On

Acknowledgement

[v][][Set ID][][OK/NG][Data][x]

35. Time (Command: f a)

Set the current time.

Transmission`[f][a][][Set ID][][Data1][][Data2][][Data3][Cr]`

[Data1]

00 : Monday

01 : Tuesday

02 : Wednesday

03 : Thursday

04 : Friday

05 : Saturday

06 : Sunday

[Data2]

0H to 17H (Hours)

[Data3]

00H to 3BH (Minutes)

Acknowledgement`[a][][Set ID][][OK/NG][Data1][Data2][Data3][x]`

*When reading data, FFH is inputted for [Data1], [Data2] and [Data3]. In other cases, all are treated as NG.

36. On Timer (On/Off Timer) Time (Command: f d)

Set On Timer.

Transmission`[f][d][][Set ID][][Data1][][Data2][][Data3][Cr]`

[Data1]

1. f1h to f4h(read one index)

f1: read 1st index of On Time List

f2: read 2nd index of On Time List

f3: read 3rd index of On Time List

f4: read 4th index of On Time List

2. e1h~e4h(delete one index), e0h(delete all indexes)

e0: delete all indexes of On Time List

e1: delete 1st index of On Time List

e2: delete 2nd index of On Time List

e3: delete 3rd index of On Time List

e4: delete 4th index of On Time List

3. 01h to 80h (write) (Day of Week)

bit0 (01h) : Monday

bit1 (02h) : Tuesday

bit2 (04h) : Wednesday

bit3 (08h) : Thursday

bit4 (10h) : Friday

bit5 (20h) : Saturday

bit6 (40h) : Sunday

bit7 (80h) : Everyday

(1fh) : Monday to Friday

(3fh) : Monday to Saturday

(60h) : Saturday to Sunday

[Data 2]

00h to 17h (Hours)

[Data 3]

00h to 3bh (Minutes)

*When you read/delete the current on time list, all of [Data2][Data3] are have to be FFH.

(ex1: fd 01 f1 ff ff - when you read 1st index of On Time List

ex2: fd 01 e1 ff ff - when you delete 1st index of On Time List

ex3: fd 01 3f 02 03 - when you write one On Time Data, "Monday to Saturday, 02:03"

Acknowledgement`[d][][Set ID][][OK][Data1][Data2][Data3][x]`

37. Off Timer (On/Off Timer) Time (Command: f e) Set Off Timer.

Transmission

[f][e][][Set ID][][Data1][][Data2][][Data3][Cr]

[Data 1]

1. f1h to f4h(read one index)
f1: read 1st index of Off Time List,
f2: read 2nd index of Off Time List
f3: read 3rd index of Off Time List
f4: read 4th index of Off Time List

2. e1h to e4h(delete one index), e0h(delete all indexes)

- e0: delete all indexes of Off Time List
e1: delete 1st index of Off Time List
e2: delete 2nd index of Off Time List
e3: delete 3rd index of Off Time List
e4: delete 4th index of Off Time List

3. 01h to 80h (write) (Day of Week)

- bit0 (01h) : Monday
bit1 (02h) : Tuesday
bit2 (04h) : Wednesday
bit3 (08h) : Thursday
bit4 (10h) : Friday
bit5 (20h) : Saturday
bit6 (40h) : Sunday
bit7 (80h) : Everyday
(1fh) : Monday to Friday
(3fh) : Monday to Saturday
(60h) : Saturday to Sunday

[Data 2]

00h to 17h (Hours)

[Data 3]

00h to 3bh (Minutes)

*When you read/delete the current on time list, all of [Data2][Data3] are have to be FFH.

- (ex1: fd 01 f1 ff ff - when you read 1st index of Off Time List
ex2: fd 01 e1 ff ff - when you delete 1st index of Off Time List
ex3: fd 01 3f 02 03 - when you write one Off Time Data, "Monday to Saturday, 02:03")

Acknowledgement

[e][][Set ID][][OK][Data1][Data2][Data3][x]

38. Scheduling Input select (Command: f u) (Main Picture Input)

To select input source for Set depending on day.

Transmission

[f][u][][Set ID][][Data1][][Data2][Cr]

[Data 1]

1. f1h to f4h(write/read one index)
f1: read 1st index of Scheduling Input
f2: read 2nd index of Scheduling Input
f3: read 3rd index of Scheduling Input
f4: read 4th index of Scheduling Input

[Data 2]

Input

Data(Hex)	Input
02	AV(CVBS)
04	Component
07	RGB - PC
08	HDMI/DVI - HD - DVD
09	HDMI/DVI - PC

*When you read/delete the current Scheduling Input, [Data2] needs to be FFH.

(ex1: fu 01 f1 ff - when you read 1st index of Scheduling Input.

ex2: fu 01 f3 02 - when you write one Scheduling Input Data in to 3rd index, "AV(CVBS)")

Acknowledgement

[u][][Set ID][][OK][Data1][Data2][x]

39. Sleep Time (Command: f f)

Set Sleep Time.

Transmission`[f][f][][Set ID][][Data][Cr]`

Data 00 : Off
 01 : 10
 02 : 20
 03 : 30
 04 : 60
 05 : 90
 06 : 120
 07 : 180
 08 : 240

Acknowledgement`[f][][Set ID][][OK/NG][Data][x]`**40. Auto Sleep (Command: f g)**

Set Auto Sleep.

Transmission`[f][g][][Set ID][][Data][Cr]`

Data 00 : Off
 01 : On

Acknowledgement`[g][][Set ID][][OK/NG][Data][x]`**41. Power On Delay (Command: f h)**

Set the schedule delay when the power is turned on (Unit: second).

Transmission`[f][h][][Set ID][][Data][Cr]`

Data : 00H to 64H (Data value)

* Refer to 'Real data mapping'. See p.53

Acknowledgement`[h][][Set ID][][OK/NG][Data][x]`**42. Language (Command: f i)**

Set the OSD language.

Transmission`[f][i][][Set ID][][Data][Cr]`

Data 00 : English
 01 : French
 02 : German
 03 : Spanish
 04 : Italian
 05 : Portuguese
 06 : Chinese
 07 : Japanese
 08 : Korean
 09 : Russian

Acknowledgement`[i][][Set ID][][OK/NG][Data][x]`**43. DPM Select (Command: f j)**

Set the DPM (Display Power Management) function.

Transmission`[f][j][][Set ID][][Data][Cr]`

Data 00 : Off
 01 : On

Acknowledgement`[j][][Set ID][][OK/NG][Data][x]`**44. Reset (Command: f k)**

Set the DPM (Display Power Management) function.

Transmission`[f][k][][Set ID][][Data][Cr]`

Data 00 : Picture Reset
 01 : Screen Reset
 02 : Factory Reset

Acknowledgement`[k][][Set ID][][OK/NG][Data][x]`

45. Power saving (Command: f l)

To set the Power saving mode.

Transmission

[f][l][][Set ID][][Data][Cr]

Data 00 : Off
01 : static level 1
02 : static level 2
03 : static level 3

Acknowledgement

[l][][Set ID][][OK/NG][Data][x]

46. Power Indicator (Command: f o)

To set the LED for Power Indicator

Transmission

[f][o][][Set ID][][Data][Cr]

Data 00 : Off
01 : On

Acknowledgement

[o][][Set ID][][OK/NG][Data][x]

47. Serial no.Check (Command: f y)

Check the Serial no.

Transmission

[f][y][][Set ID][][Data][Cr]

Data FF (to read the serial numbers)

Acknowledgement

[y][][Set ID][][OK/NG][Data1] to [Data13][x]

* The data format is ASCII Code.

48. S/W Version (Command: f z)

Check the software version.

Transmission

[f][z][][Set ID][][Data][Cr]

Data FFH : Read

Acknowledgement

[z][][Set ID][][OK/NG][Data][x]

49. Input Select (Command: x b)

To select input source for the Set.

Transmission

[x][b][][Set ID][][Data][Cr]

Data 20H : AV(CVBS)
40H : Component
60H : RGB(PC)
90H : HDMI/DVI(DTV)
A0H : HDMI/DVI(PC)

Acknowledgement

[b][][Set ID][][OK/NG][Data][x]

Data 20H : AV(CVBS)
40H : Component
60H : RGB(PC)
90H : HDMI/DVI(DTV)
A0H : HDMI/DVI(PC)



Make sure to read the Safety Precautions before using the product.
Keep the Owner's Manual(CD) in an accessible place for future reference.
The model and serial number of the SET is located on the back and one side of the SET.
Record it below should you ever need service.

MODEL _____

SERIAL _____

Temporary noise is normal when powering ON or OFF this device.