



LG

Life's Good

ENGLISH

OWNER'S MANUAL

CINEMA 3D TV

Please read this manual carefully before operating the your TV and retain it for future reference.

CINEMA 3D TV MODELS

DM2780D

DM2780A

CONTENTS

5 LICENSES

6 ASSEMBLING AND PREPARING

- 6 Unpacking
- 8 Parts and buttons
- 9 Lifting and moving the TV
- 9 Setting up the TV
 - 9 - Attaching the Stand Base
 - 10 - Detaching the Stand Base and Body
 - 10 - Mounting on a table
 - 12 - Tidying cables
 - 12 - Swivel stand
 - 12 - Mounting on a wall

14 REMOTE CONTROL

16 WATCHING TV

- 16 Connecting an antenna or cable
 - 16 - Connecting an antenna or basic cable
 - 16 - Connecting with a cable box
- 17 Accessing the TV for the first time
- 18 Watching TV
- 18 Managing programmes
 - 18 - Automatically setting up programmes
 - 21 - Manually setting up programmes (In digital mode)(Only DTV)
 - 22 - Manually setting up programmes (In analogue mode)
 - 23 - Cable DTV Setting (In Cable mode only)(Only DTV)
 - 23 - Editing your programme list
 - 24 - In DTV/RADIO mode (Only DTV)
 - 24 - In TV mode (Only DTV)
 - 25 - Software Update (Only DTV)
 - 26 - Diagnostics (Only DTV)
 - 26 - CI [Common interface] Information (Only DTV)

- 27 - Selecting the programme list
- 27 - Favourite programme setup
- 28 Using additional options
 - 28 - Adjusting aspect ratio
 - 30 - Using the input list
- 31 - On-screen menu language / Country selection (Only DTV)
- 32 - Language selection (In digital mode only)(Only DTV)
- 33 Using the Lock options
 - 33 - Locking the buttons on the TV.
 - 34 - Parental control (In digital mode only) (Only DTV)
- 34 Using the Quick menu

35 EPG (ELECTRONIC PROGRAMME GUIDE) (IN DIGITAL MODE) (ONLY DTV)

- 35 Using Electronic Programme Guide
 - 35 - Switch on/off EPG
 - 35 - Select a programme
 - 36 - Button Function in NOW/NEXT Guide Mode
 - 36 - Button Function in 8 Day Guide Mode
 - 36 - Button Function in Date Change Mode
 - 37 - Button Function in Extended Description Box
 - 37 - Button Function in Record/Remind Setting Mode
 - 37 - Button Function in Schedule List Mode

38 CONNECTING TO A PC

- 38 HDMI connection
- 39 DVI to HDMI connection
- 39 RGB connection
- 40 Adjusting the screen
 - 40 - Selecting an image mode
 - 40 - Customizing image options
 - 41 - Customizing PC display options

- 41 Adjusting the sound
- 41 - Selecting an sound mode
- 42 - Customizing sound options

43 ENTERTAINMENT

- 43 Using integrated media features
- 43 - Connecting USB storage devices
- 45 - Browsing files
- 46 - Viewing Photos
- 47 - Listening to Music
- 49 - Viewing Movies
- 52 - DivX® VOD Guide

53 3D IMAGING

- 53 3D Technology
- 53 Precautions to take when viewing 3D images
- 54 When using 3D Glasses
- 55 3D Imaging Viewing Range
- 56 Viewing 3D Imaging
- 57 3D Mode Setting Option

58 CUSTOMIZING SETTINGS

- 58 Accessing main menus
- 59 Customizing settings
- 59 - SETUP settings
- 60 - PICTURE settings
- 63 - AUDIO settings
- 66 - TIME settings
- 67 - OPTION settings
- 68 - LOCK settings
- 69 - INPUT settings
- 69 - USB settings

70 MAKING CONNECTIONS

- 70 Connection overview
- 72 Connecting to a Camcorder, Camera, HD receiver, DVD, VCR player or Gaming device
- 72 - HDMI connection
- 72 - DVI to HDMI connection
- 72 - Component connection
- 73 - Composite connection
- 73 - Euro Scart connection
- 73 Connecting to an audio system
- 73 - Digital optical audio connection
- 74 - Headphone connection
- 74 Connecting to a USB

75 TELETEXT

- 75 Switch On/Off
- 75 Simple Text
- 75 - Page selection
- 75 Top Text
- 75 - Block / Group / Page Selection
- 75 - Direct Page Selection
- 76 Fasttext
- 76 - Page selection
- 76 Special Teletext Function
- 76 - Text Option

77 DIGITAL TELETEXT (ONLY DTV)

- 77 Teletext within digital service
- 77 Teletext in digital service

78 MAINTENANCE

- 78 Screen and frame
- 78 Cabinet and stand
- 78 Power cord

79 TROUBLESHOOTING

- 79 General
- 80 PC mode

82 TROUBLESHOOTING WHEN USING 3D MODE

83 SPECIFICATIONS

87 IR CODES

88 EXTERNAL CONTROL DEVICE SETUP

- 88 RS-232C Setup
- 88 Type of connector; D-Sub 9-Pin Male
- 89 RS-232C configurations
- 90 Communication Parameters
- 90 Command reference list
- 91 Transmission / Receiving protocol

LICENSES

Supported licenses may differ by model. For more information of the licenses, visit www.lg.com.



Manufactured under license from Dolby Laboratories. "Dolby" and the double-D symbol are trademarks of Dolby Laboratories.



HDMI, the HDMI logo and High-Definition Multimedia Interface are trademarks or registered trademarks of HDMI Licensing LLC.



ABOUT DIVX VIDEO: DivX® is a digital video format created by DivX, LLC, a subsidiary of Rovi Corporation. This is an official DivX Certified® device that plays DivX video. Visit divx.com for more information and software tools to convert your files into DivX videos.

ABOUT DIVX VIDEO-ON-DEMAND: This DivX Certified® device must be registered in order to play purchased DivX Video-on-Demand (VOD) movies. To obtain your registration code, locate the DivX VOD section in your device setup menu. Go to vod.divx.com for more information on how to complete your registration.

DivX Certified® to play DivX® video up to HD 1080p, including premium content.

DivX®, DivX Certified® and associated logos are trademarks of Rovi Corporation or its subsidiaries and are used under license.

Covered by one or more of the following U.S. patents: 7,295,673; 7,460,668; 7,515,710; 7,519,274

NOTE

- Image shown may differ from your TV.
- Your TV's OSD (On Screen Display) may differ slightly from that shown in this manual.
- The available menus and options may differ from the input source or product model that you are using.

ASSEMBLING AND PREPARING

Unpacking

Check your product box for the following items. If there are any missing accessories, contact the local dealer where you purchased your product. The illustrations in this manual may differ from the actual product and accessories.

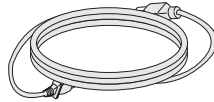

Power Cord

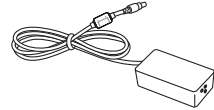

AC-DC Adapter

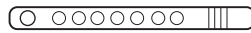

Cable Tie

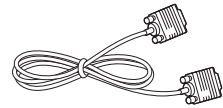

RGB Cable

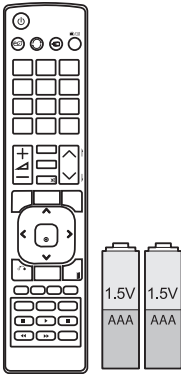

Remote control and Batteries



**CD (Owner's Manual) /
Card**

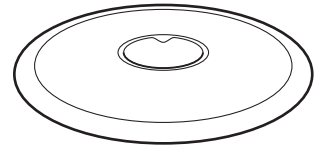

Stand Base



**TriDef 3D Game Software CD /
Quick Installation Guide**



**3D Glasses
(Normal type)**



**3D Glasses
(Clip type)**

**CAUTION**

- Do not use any pirated items to ensure the safety and product life span.
- Any damages or injuries by using pirated items are not covered by the warranty.

**NOTE**

- The accessories supplied with your product may vary depending on the model.
- Product specifications or contents in this manual may be changed without prior notice due to upgrade of product functions.

Parts and buttons

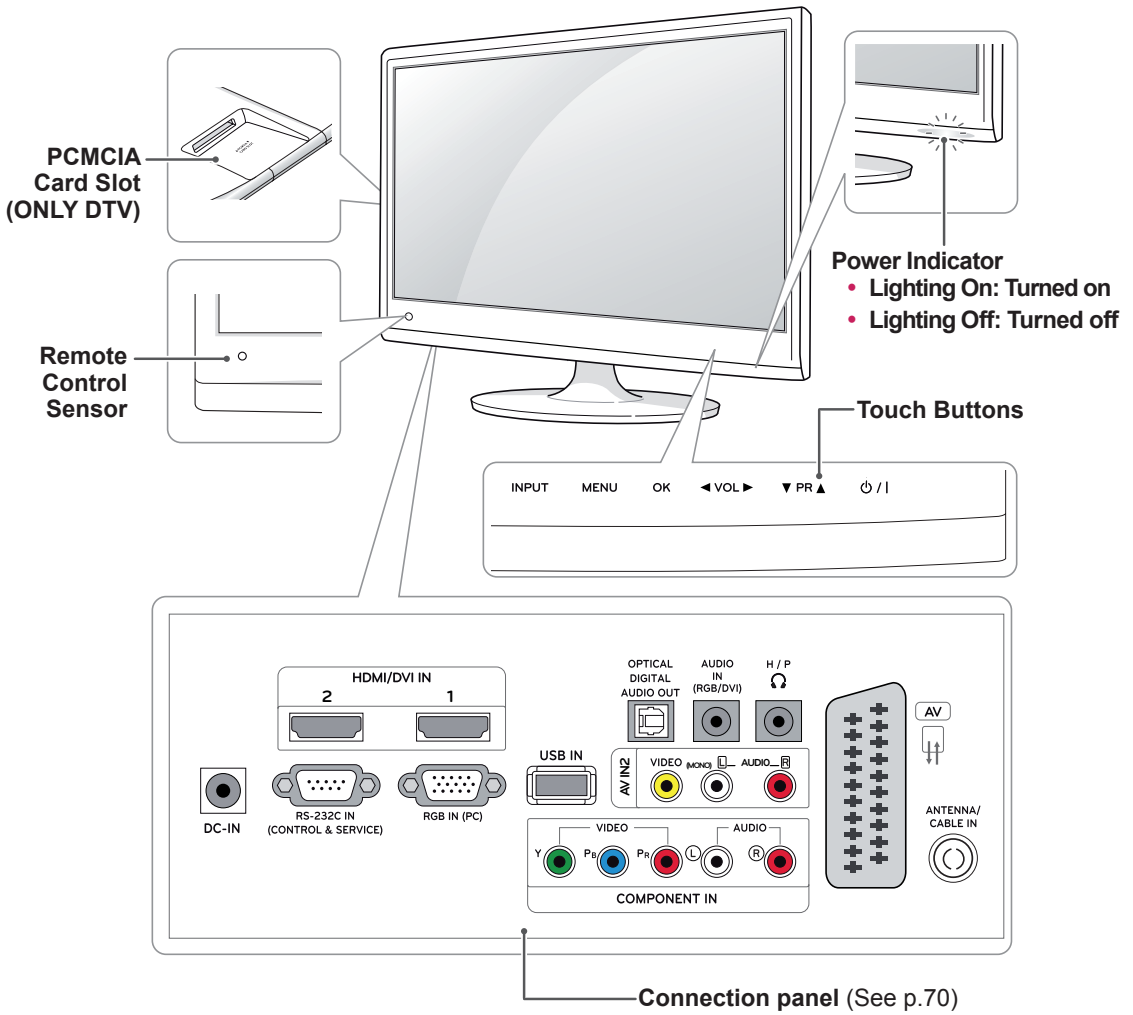

Touch button	Description
INPUT	Changes the input source.
MENU	Accesses the main menus, or saves your input and exits the menus.
OK	Selects the highlighted menu option or confirms an input.
<VOL>	Adjusts the volume level.
<PR>	Scrolls through the saved programmes.
<Power/Standby>	Turns the power on or off.

All of the buttons are touch sensitive and can be operated through simple touch with your finger.

NOTE

- You can set the Power indicator to on or off by selecting **OPTION** in the main menus.

Lifting and moving the TV

When moving or lifting the TV, read the following to prevent the TV from being scratched or damaged and for safe transportation regardless of its type and size.



CAUTION

Avoid touching the screen at all times, as this may result in damage to the screen or some of the pixels used to create images.

- It is recommended to move the TV in the box or packing material that the TV originally came in.
- Before moving or lifting the TV, disconnect the power cord and all cables.
- Hold the top and bottom of the TV frame firmly. Make sure not to hold the transparent part, speaker, or speaker grill area.

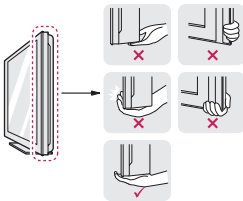

- When holding the TV, the screen should face away from you to prevent the screen from scratches.



- When transporting the TV, do not expose the TV to jolts or excessive vibration.
- When transporting the TV, keep the TV upright, never turn the TV on its side, or tilt towards the left or right.

Setting up the TV

Attaching the Stand Base

- 1 Place the TV with the screen side down on a flat and cushioned surface.



CAUTION

Lay a foam mat or soft protective cloth on the surface to protect the screen from damage.

- 2 Attach the **Stand Base** from the set by turning the screw to the right with a **Coin**.

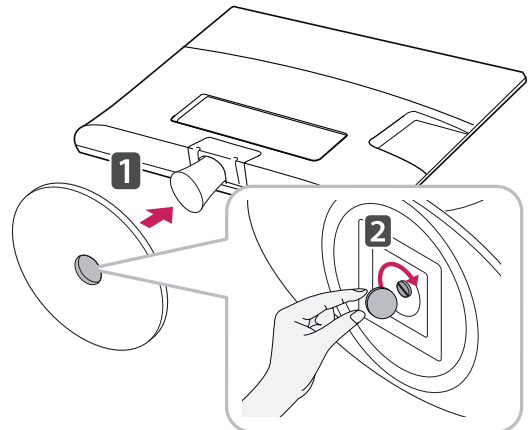

Detaching the Stand Base and Body

- 1 Place the TV with the screen side down on a flat and cushioned surface.
- 2 Turn the screw to the left, and then pull out the **Stand Base** from the **Stand Body**.

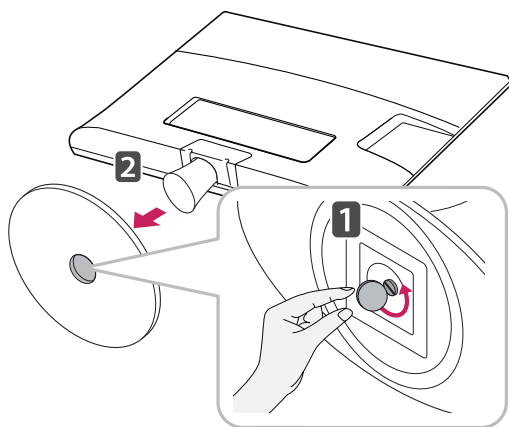

- 3 Remove 2 screws and pull out the **Stand Body** from the TV.

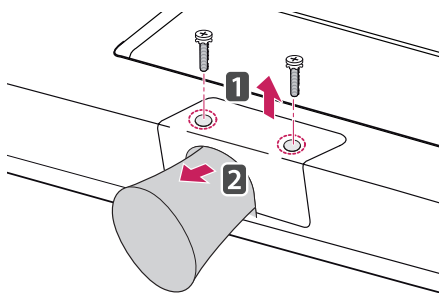

Mounting on a table

- 1 Lift and tilt the TV into its upright position on a table.
Leave a 10 cm (minimum) space from the wall for proper ventilation.

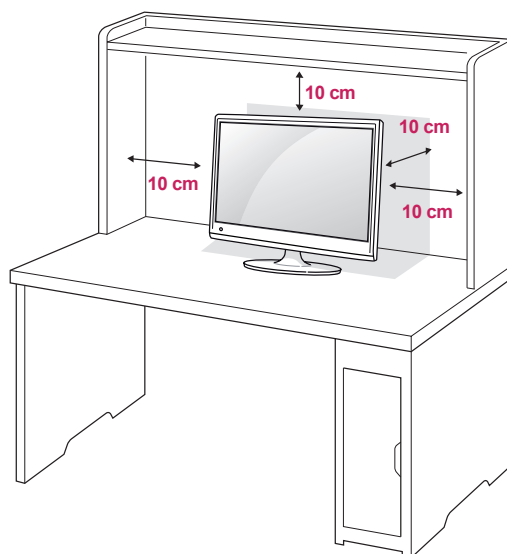

- 2 Connect the **AC-DC Adapter** and **Power Cord** to a wall outlet.

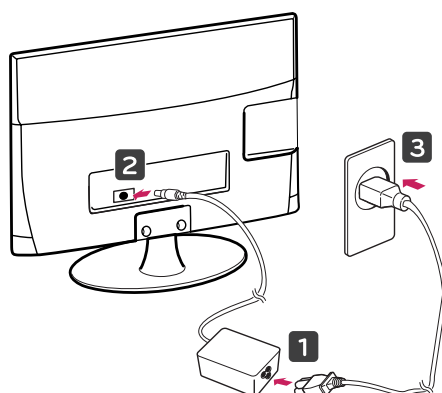

! WARNING

When you adjust the angle, do not hold the bottom of the TV frame as shown on the following illustration, as may injure your fingers.

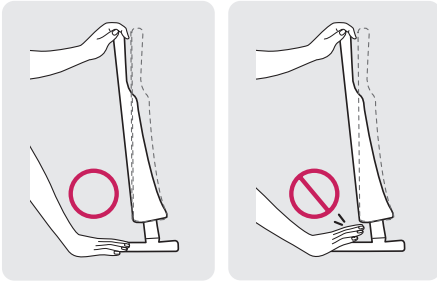
**! CAUTION**

Disconnect the power cord first, and then move or install the TV. Otherwise electric shock may occur.

! NOTE

Tilt from +18 to -5 degrees up or down to adjust the angle of the TV to suit your view.

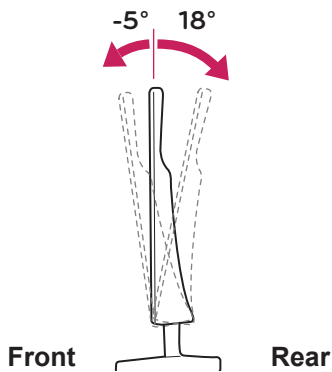
**Using the Kensington security system**

The Kensington security system connector is located at the back of the TV. For more information of installation and using, refer to the manual supplied with the Kensington security system or visit <http://www.kensington.com>.

Connect the Kensington security system cable between the TV and a table.

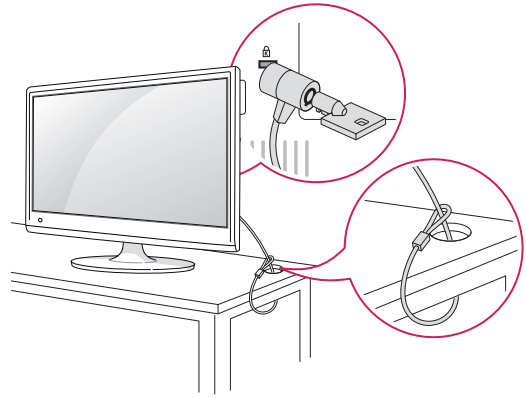
**! NOTE**

The Kensington security system is optional. You can obtain additional accessories from most electronics stores.

Tidying cables

Gather and bind the cables with the supplied cable tie.

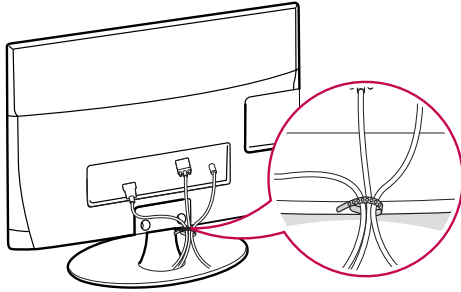

Swivel stand

Swivel 179 degrees and adjust the angle of the TV to suit your view.

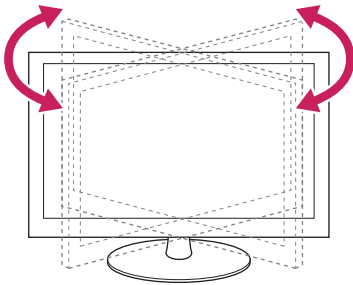

Mounting on a wall

For proper ventilation, allow a clearance of 10 cm on each side and from the wall. Detailed installation instructions are available from your dealer, see the optional Tilt Wall Mounting Bracket Installation and Setup Guide.

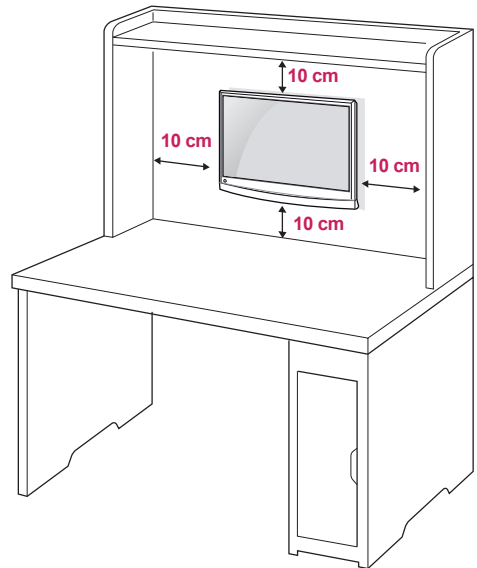

If you intend to mount the TV to a wall, attach Wall mounting interface (optional parts) to the back of the set.

When you install the TV using the wall mounting interface (optional parts), attach it carefully so it will not drop.

- 1 Please, Use the screw and wall mount interface in accordance with VESA Standards.
- 2 If you use screw longer than standard, the TV might be damaged internally.
- 3 If you use improper screw, the product might be damaged and drop from mounted position. In this case, LG Electronics is not responsible for it.
- 4 VESA compatible only with respect to screw mounting interface dimensions and mounting screw specifications.

- 5 Please use VESA standard as below.
- 784.8 mm (30.9 inch) and under
 - * Wall Mount Pad Thickness : 2.6 mm
 - * Screw : Φ 4.0 mm x Pitch 0.7 mm x Length 10 mm
 - 787.4 mm (31.0 inch) and above
 - * Please use VESA standard wall mount pad and screws.

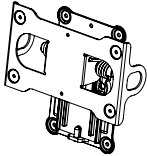
Model	DM2780D DM2780A
VESA (A x B)	200 x 100
Standard screw	M4
Number of screws	4
Wall mount bracket (optional)	RW240 

- VESA (A x B)

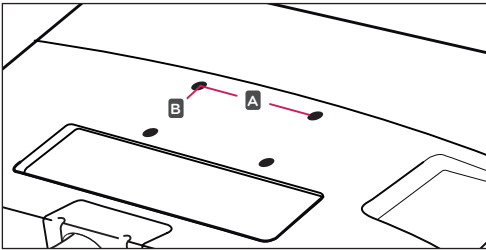

CAUTION

- Disconnect the power cord first, and then move or install the TV. Otherwise electric shock may occur.
- If you install the TV on a ceiling or slanted wall, it may fall and result in severe injury.
- Use an authorized LG wall mount and contact the local dealer or qualified personnel.
- Do not over tighten the screws as this may cause damage to the TV and void your warranty.
- Use the screws and wall mounts that meet the VESA standard. Any damages or injuries by misuse or using an improper accessory are not covered by the warranty.

NOTE

- Use the screws that are listed on the VESA standard screw specifications.
- The wall mount kit includes an installation manual and necessary parts.
- The wall mount bracket is optional. You can obtain additional accessories from your local dealer.
- The length of screws may differ depending on the wall mount. Be sure to use the proper length.
- For more information, refer to the instructions supplied with the wall mount.

REMOTE CONTROL

The descriptions in this manual are based on the buttons of the remote control. Please read this manual carefully and use the TV correctly.

To replace batteries, open the battery cover, replace batteries (1.5 V AAA) matching ⊕ and ⊖ ends to the label inside the compartment, and close the battery cover. To remove the batteries, perform the installation actions in reverse.

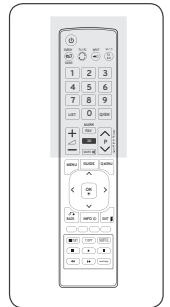

CAUTION

- Do not mix old and new batteries, as this may damage the remote control.
- In Analogue TV and some countries, some remote control keys may not work.

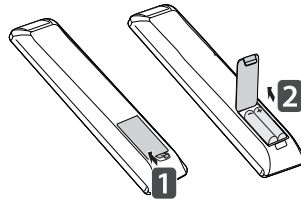

Make sure to point the remote control to the remote control sensor on the TV.

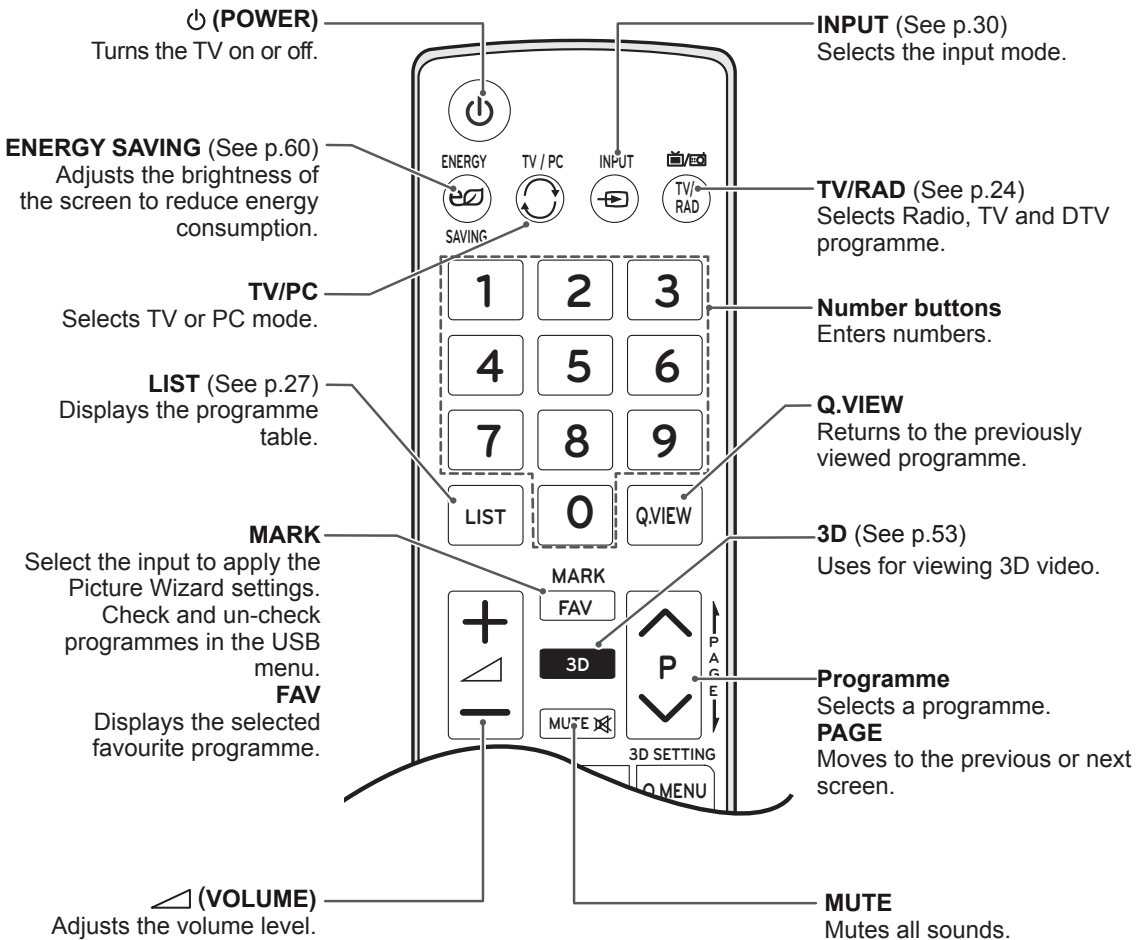

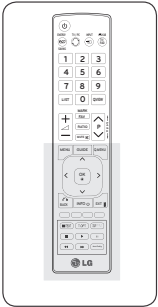

CAUTION

- In Analogue TV and some countries, some remote control keys may not work.

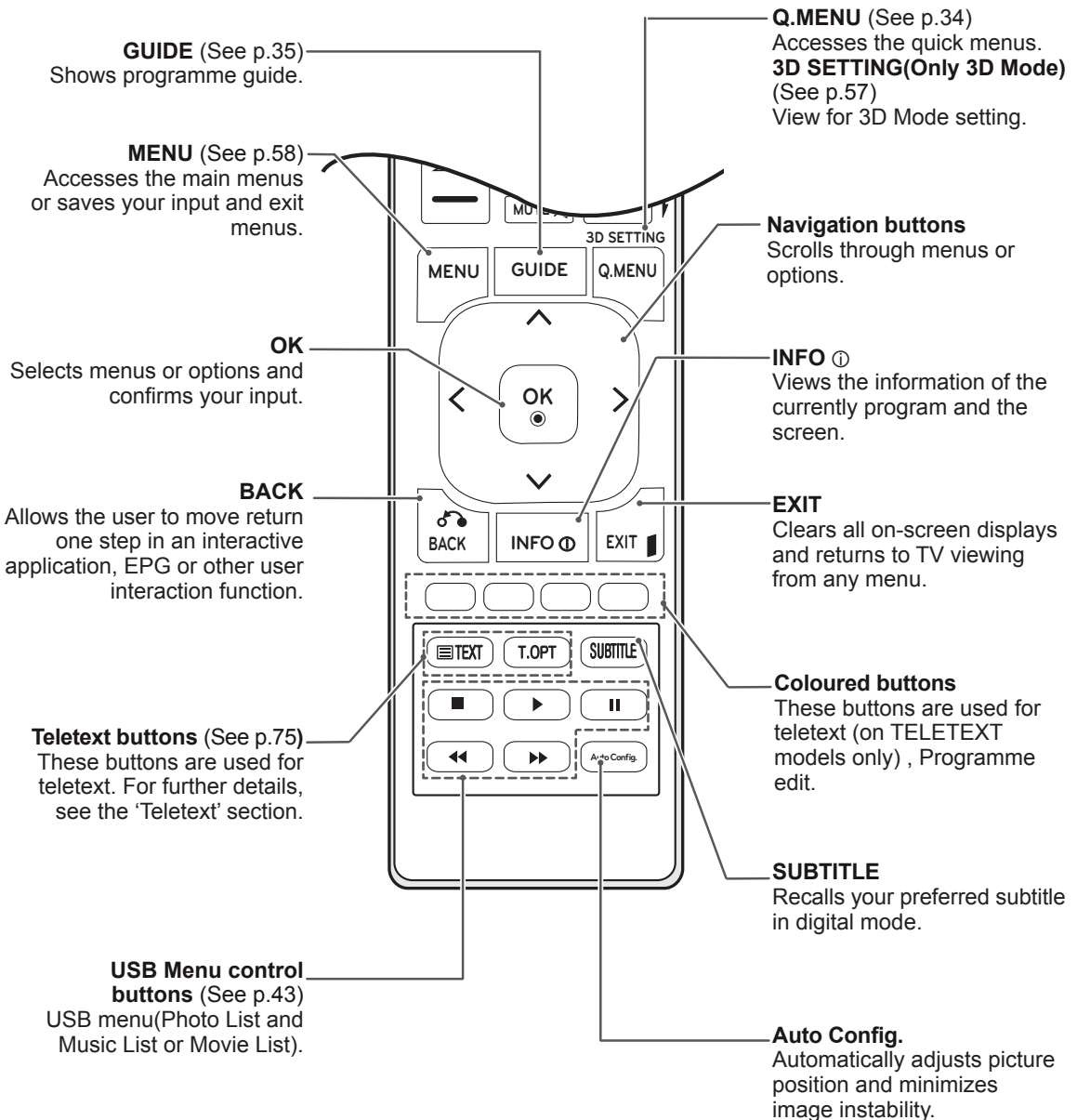

WATCHING TV

Connecting an antenna or cable

Connect an antenna, cable, or cable box to watch TV referring to the following. The illustrations may differ from the actual accessories and an RF cable is optional.

Connecting an antenna or basic cable

Connect the TV to a wall antenna socket with an RF cable (75 ohm).

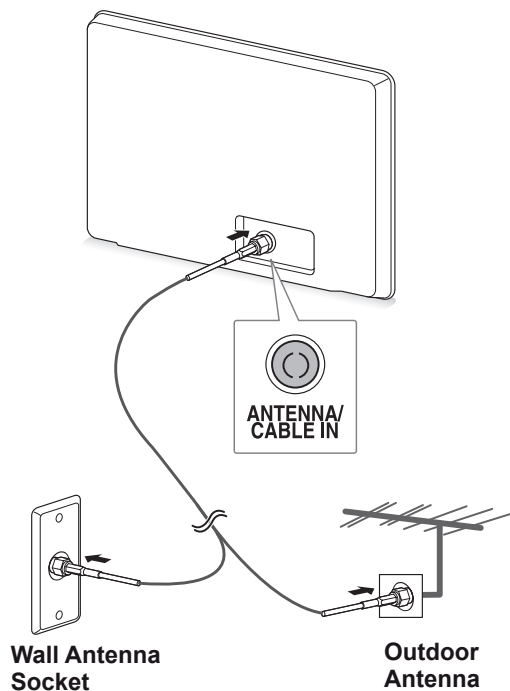

Connecting with a cable box

Connect the TV to a cable box and the cable box to a wall antenna socket with 2 RF cables (75 ohm).

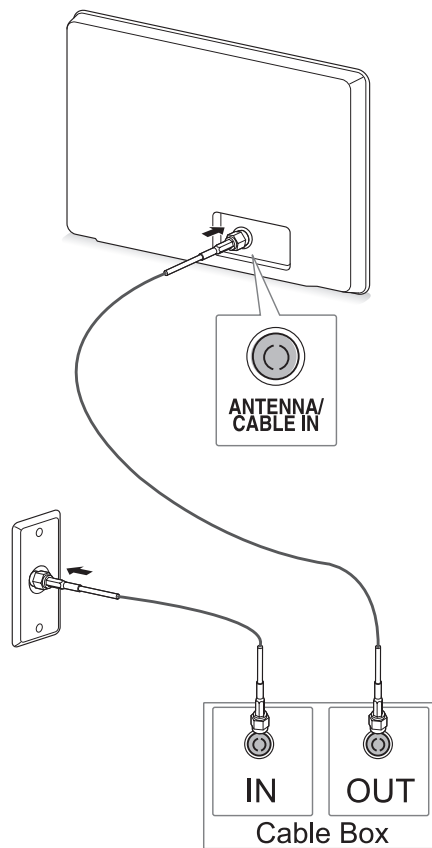

NOTE

- Use a signal splitter to use more than 2 TVs.
- If the image quality is poor, install a signal amplifier properly to improve the image quality.
- If the image quality is poor with an antenna connected, aim the antenna to the proper direction.
- Visit <http://AntennaWeb.org> for more information about the antenna and cable connection.

CAUTION

- Make sure not to bend the copper wire of the RF cable.

Copper wire

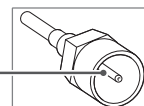

- Complete all connections instructions between devices, and then connect the power cord to the power outlet to prevent damages to your TV.

Accessing the TV for the first time

When you access the TV for the first time, the initial setting screen appears. Select a language and customize the basic settings.

- 1 Connect the power cord to a power outlet.
- 2 Press O/I on the TV to turn the TV on. The Power indicator lighting is turned on.

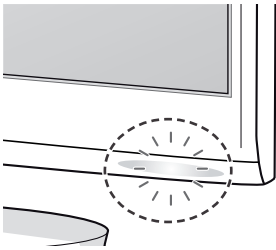

NOTE

When the TV is in Power saving mode, the Power indicator lighting blinks.



- 3 The initial setting screen appears if you access the TV for the first time.

NOTE

- You can also switch the TV from PC mode to TV mode, press **TV/PC**.
- You can also access **Initial Setting** by accessing **OPTION** in the main menus.
- If you do not operate the TV within 40 seconds when the setting menu screen appears, the setting menus will disappear.

- 4 Follow the on-screen instructions to customize your TV according to your preferences.

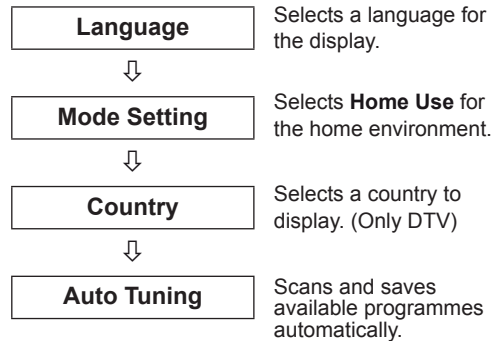

NOTE

- To display images in the best quality for your home environment, select **Home Use mode**.
- Store Demo mode is suitable for the retail environment.
- If you select **Store Demo** mode, the previously customized settings will switch to the default settings of **Store Demo** mode in 2 minutes.

- 5 When the basic settings are complete, press **OK**.

NOTE



If you do not complete the initial setting, it will appear whenever you access the TV.







- 6 To turn the TV off, press O/I on the TV. The Power Indicator turns off.



CAUTION

Disconnect the power cord from the power outlet when you do not use the TV for a long period of time.

Watching TV

- 1 Press  on the Remote control or /| on the TV to turn the TV on.
- 2 Press **INPUT** and select **Antenna**.
- 3 Control the TV using the following buttons and menus while you are watching TV.

Button / Menu	Description
P ( , ) or PR ( , )	Scrolls through the saved programmes
Numbers	Selects a programme by entering numbers
 (+, -) or VOL ( , )	Adjusts the volume level
MUTE	Mutes all sounds
PICTURE	Selects one of the preset image modes (See p.60)
AUDIO	Selects one of the preset audio modes. (See p.63)

- 4 To turn the TV off, Press  on the Remote control or /| on the TV.

Managing programmes

Automatically setting up programmes

For countries other than Finland, Sweden, Denmark and Norway)

Use this to automatically find and store all available programmes.

- 1 Press **MENU** to access the main menus.
- 2 Press the Navigation buttons to scroll to **SETUP** and press **OK**.
- 3 Press the Navigation buttons to scroll to **Auto Tuning** and press **OK**.
- 4 Select **Start** to start automatic tuning. The TV scans and saves available programmes automatically.
- 5 When you are finished, press **EXIT**. When you return to the previous menu, press **BACK**.

NOTE

- Use **Number** buttons to input a 4-digit password in **Lock System 'On'**.
- Automatic Numbering: Decide whether to use the programme numbers as sent by broadcasting stations for tuning.
- When select **Italy** in the Country menu, if the pop up is displayed when the conflicted Programme after Auto Tuning, select a broadcaster for conflicting programme number to solve.
- When select **UK** in the Country menu, if the pop up is displayed when the conflicted programme after Auto Tuning, select a regions, country for conflicting programme number to solve.

Only for Finland, Sweden, Denmark and Norway

DVB-C Auto Tuning is a menu for users in countries that support DVB cable.

- If you want to select the **Antenna**
- 1 Press **MENU** to access the main menus.
 - 2 Press the Navigation buttons to scroll to **SETUP** and press **OK**.
 - 3 Press the Navigation buttons to scroll to **Auto Tuning** and press **OK**.
 - 4 Press the Navigation buttons to scroll to **Antenna** and press **OK**.
 - 5 Select **Start** to start automatic tuning.
The TV scans and saves available programmes automatically.
 - 6 When you are finished, press **EXIT**.
When you return to the previous menu, press **BACK**.

NOTE

- Use **Number** buttons to input a 4-digit password in **Lock System 'On'**.
- Automatic Numbering: Decide whether to use the programme numbers as sent by broadcasting stations for tuning.

- If you want to select the **Cable**
- 1 Press **MENU** to access the main menus.
 - 2 Press the Navigation buttons to scroll to **SETUP** and press **OK**.
 - 3 Press the Navigation buttons to scroll to **Auto Tuning** and press **OK**.
 - 4 Press the Navigation buttons to scroll to **Cable** and press **OK**.
 - 5 Press the Navigation buttons to scroll to **Comhem** or **Other Operators** and press **OK**.
 - 6 Press the Navigation buttons to scroll to **Default, Full** or **User** and press **OK**.
 - 7 Press the Navigation buttons or Number buttons to scroll make appropriate adjustments (Except for Full mode) and press **OK**.
 - 8 Press the Navigation buttons to scroll to **Close** and press **OK**.
 - 9 Select **Start** to start automatic tuning.
The TV scans and saves available programmes automatically.
 - 10 When you are finished, press **EXIT**.
When you return to the previous menu, press **BACK**.

NOTE

- Use **Number** buttons to input a 4-digit password in **Lock System 'On'**.
- Automatic Numbering: Decide whether to use the programme numbers as sent by broadcasting stations for tuning.

- When you select the **Cable**, the **Cable Service Operator** selection screen can differ or not exist by the Cable situation of the applicable country.

The popup window to select between **Service Operator** is only shown initially for the 3 cases when you accessing the **Initial Setting** menu, when you change from **Antenna** to **Cable** or when you access the menu after changing the **Country**.

When you want to select between **Service Operator** aside from the above 3 cases, you can do so by selecting **SETUP** → **Cable DTV Setting** → **Service Operator**.

- Acquired certification SO: Sweden(Comhem, Canal Digital), Denmark(YouSee, Canal Digital, Stofa), Norway(Canal Digital).
If there are not any Service Operator that you want, select **Other Operators**.
If you select "Other Operators", or the selected country supports "Other Operators" only, it may take some time to search all the channels, or it may not search some of the channels.
If some of the channels do not appear, follow the steps below.
 1. **SETUP** → **Auto Tuning** → **Cable**
 2. Input additional values such as the frequency, symbol rate, modulation, and network ID (You can ask your cable service provider for the above information).
- The following values are needed in order to search all available programmes quickly and correctly. The commonly used values are provided as "default". However, for correct settings, please inquire of the cable service provider. When running Auto Tuning in DVB cable mode, selecting Full will search through all frequencies to find available channels. In the case when the programme is not searched by selecting the Default, perform the searching by selecting the Full. However, in the case when the programme is searched by selecting the Full, the Auto Tuning time can be taken too much.
 - » **Frequency**: Enter a user-defined frequency range.
 - » **Symbol rate**: Enter a user-defined symbol rate (Symbol rate: Speed at which a device such as modem sends symbols to a channel).
 - » **Modulation**: Enter a user-defined

modulation. (Modulation: Loading of audio or video signals onto carrier).

- » **Network ID**: Unique identifier allocated for each user.

If you select the "- ." of Country Setting, (Except for Finland, Sweden, Denmark and Norway)

To watch DVB-C in the countries excluding Finland, Sweden, Denmark and Norway select '- .' as the Country in OPTION.

You can select User mode or Full mode in Auto Tuning.

The corresponding home frequency information may need to be changed when tuning the User mode, and the corresponding information depends on the Cable Service Operator (SO) in service. During Full mode tuning, some channel may be restricted for some Cable Service Operator (SO), and it may take a long time for tuning.

NOTE

- Your cable provider may charge for their services, or require you to agree to its items and conditions of business.
- DVB-C Cable may not operate correctly with some cable providers.
- Compatibility with DVB-C digital cable broadcasts is not guaranteed.

Manually setting up programmes (In digital mode)(Only DTV)

Manual Tuning lets you manually add a programme to your programme list.

(For countries other than Finland, Sweden, Denmark and Norway & When selecting Antenna if Finland, Sweden, Denmark, Norway or "--"country is chosen)

- 1 Press **MENU** to access the Main menus.
- 2 Press the Navigation buttons to scroll to **SETUP** and press **OK**.
- 3 Press the Navigation buttons to scroll to **Manual Tuning** and press **OK**.
- 4 Press the Navigation buttons to scroll to DTV.
- 5 Press the Navigation buttons or Number buttons to scroll Select the desired channel number, and then add programmes.
- 6 When you are finished, press **EXIT**.
When you return to the previous menu, press **BACK**.

! NOTE

- Use **Number** buttons to input a 4-digit password in Lock System 'On'.

(When selecting Cable (DVB cable mode) if Finland, Sweden, Denmark, Norway or "--"country is chosen)

- 1 Press **MENU** to access the Main menus.
- 2 Press the Navigation buttons to scroll to **SETUP** and press **OK**.
- 3 Press the Navigation buttons to scroll to **Manual Tuning** and press **OK**.
- 4 Press the Navigation buttons to scroll to DTV.
- 5 Press the Navigation buttons or Number buttons to scroll Select the desired Frequency, Symbol rate and Modulation, and then add programmes.
- 6 When you are finished, press **EXIT**.
When you return to the previous menu, press **BACK**.

! NOTE

- Use **Number** buttons to input a 4-digit password in Lock System 'On'.
- **Symbol rate**: Enter a user-defined symbol rate. (symbol rate: Speed at which a device such as modem sends symbols to a channel.)
- **Modulation**: Enter a user-defined modulation. (Modulation: Loading of audio or video signals onto carrier)
- Frequency, Symbol rate, and Modulation mode are needed in order to add a programme correctly in DVB cable mode. Please inquire of the cable service provider about the correct values.

Manually setting up programmes (In analogue mode)

Manual Tuning lets you manually tune and arrange the stations in whatever order you desire.

- 1 Press **MENU** to access the main menus.
- 2 Press the Navigation buttons to scroll to **SETUP** and press **OK**.
- 3 Press the Navigation buttons to scroll to **Manual Tuning** and press **OK**.
- 4 Press the Navigation buttons to scroll to **TV** and press **OK**. (Only DTV)
- 5 Press the Navigation buttons to scroll to **System**.
- 6 Press the Navigation buttons to scroll to **V/UHF** or **Cable**.
- 7 Press the Navigation buttons or Number buttons to scroll Select the desired channel number.
- 8 Press the Navigation buttons to scroll to Commence searching.
- 9 Press the Navigation buttons to scroll to **Store** and press **OK**
- 10 When you are finished, press **EXIT**.
When you return to the previous menu, press **BACK**.



NOTE

- Use **Number** buttons to input a 4-digit password in Lock System '**On**'.
- **L**: SECAM L/L (France)
- **BG**: PAL B/G, SECAM B/G (Europe / East Europe / Asia / New Zealand / M.East / Africa / Australia)
- **I**: PAL I/II (U.K. / Ireland / HongKong / South Africa)
- **DK**: PAL D/K, SECAM D/K (East Europe / China / Africa / CIS)
- To store another channel, repeat steps 4 to 9.

Assigning a station name

You can assign a station name with five characters to each programme number.

- 1 Press **MENU** to access the main menus.
- 2 Press the Navigation buttons to scroll to **SETUP** and press **OK**.
- 3 Press the Navigation buttons to scroll to **Manual Tuning** and press **OK**.
- 4 Press the Navigation buttons to scroll to **TV** .
(Only DTV)
- 5 Press the Navigation buttons to scroll to **Name** and press **OK**.
- 6 Press the Navigation buttons to scroll to **TV System**.
- 7 Press the Navigation buttons to scroll to **V/UHF** or **Cable**.
- 8 Press the Navigation buttons to scroll Select the position and make your choice of the second character, and so on. You can use an the alphabet A to Z, the number 0 to 9, +/ -, and blank and press **OK**
- 9 Press the Navigation buttons to scroll to **Close** and press **OK**.
- 10 Press the Navigation buttons to scroll to **Store** and press **OK**
- 11 When you are finished, press **EXIT**.
When you return to the previous menu, press **BACK**.

Cable DTV Setting (In Cable mode only)(Only DTV)

The range that a user can select from the Service Operator menu differs depending on number of Service Operator supported by each country, and if number of supported Service Operator for each country is 1, corresponding function becomes non-activation.

After changing Service Operator, a warning window saying that channel map will be deleted when OK button is pressed or Close is selected, and a Auto-tuning pop-up window appears when 'YES' is selected.

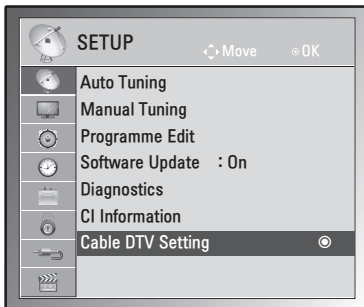

- 1 Press **MENU** to access the Main menus.
- 2 Press the Navigation buttons to scroll to **SETUP** and press **OK**.
- 3 Press the Navigation buttons to scroll to **Cable DTV Setting** and press **OK**.
- 4 Press the Navigation buttons to scroll to **Service Operator** or **Channel Auto update** and press **OK**.
- 5 When you are finished, press **EXIT**.
When you return to the previous menu, press **BACK**.

! NOTE

- If you select Cable, you can see Cable DTV Setting menu.
- When Channel Auto Update is On, the channel information will be automatically updated whenever the network information changes.
- When Channel Auto Update is Off, the channel information will not be updated.

Editing your programme list

- 1 Press **MENU** to access the main menus.
- 2 Press the Navigation buttons to scroll to **SETUP** and press **OK**.
- 3 Press the Navigation buttons to scroll to **Programme Edit** and press **OK**.
- 4 Edit programmes using the following buttons.

Button	Description
^	Highlights the programme type
Navigation	Scrolls through programme types or programmes
OK	Selects a programme to view
P (^, v)	Moves to the previous or next page

! NOTE

- Use **Number** buttons to input a 4-digit password in Lock System 'On'.

In DTV/RADIO mode (Only DTV)

Skipping a programme number

- 1 Press the Navigation buttons, scroll to the programme number you wish to skip.
- 2 Press the **Blue** button to skip the selected programme number.
- 3 Press the **Blue** button again to release.

! NOTE

- The skipped programmes are shown in blue on the programme list and these programmes will not appear on the screen when changing programmes using P(∧, ∨) buttons during watching TV.
- If you wish to watch a skipped programme, directly enter the programme number using number buttons or release it in the Programme Edit menu or EPG.

In TV mode (Only DTV)

Deleting a programme

- 1 Press the Navigation buttons, scroll to the programme number you wish to delete.
- 2 Press the **Red** button to delete the selected programme number.
- 3 Press the **Blue** button to release.

! NOTE

- The selected programme is deleted, all the following programmes are shifted up one.

Moving a programme

- 1 Press the Navigation buttons, scroll to the programme number you wish to move.
- 2 Press the **Green** button with the programme number selected, you wish to move.
- 3 Press the navigation buttons, move to where you wish to place the programme number, and then press the **Green** button again.

Auto Sort

- 1 Press the **Yellow** button to start Auto Sort.

! NOTE

- After activating Auto Sort once, you can no longer edit programmes.

Skipping a programme number

- 1 Press the Navigation buttons, scroll to the programme number you wish to skip.
- 2 Press the **Blue** button to skip the selected programme number.
- 3 Press the **Blue** button again to release.

! NOTE

- You will be unable to select a skipped programme using P(∧, ∨) buttons during watching TV.
- If you wish to watch a skipped programme, directly enter the programme number using number buttons or release it in the **Programme Edit** menu or EPG.

Software Update (Only DTV)

Software Update means software can be downloaded through the digital terrestrial broadcasting system.

- 1 Press **MENU** to access the main menus.
- 2 Press the Navigation buttons to scroll to **SETUP** and press **OK**.
- 3 Press the Navigation buttons to scroll to **Software Update** and press **OK**.
- 4 Select **On** or **Off**.
If you select **On**, a user confirm message box will be displayed to notify that new software is found.
- 5 When you are finished, press **EXIT**.
When you return to the previous menu, press **BACK**.

When setting "Software Update"

- Occasionally, a transmission of updated digital software information will result in the following menu on the TV screen.

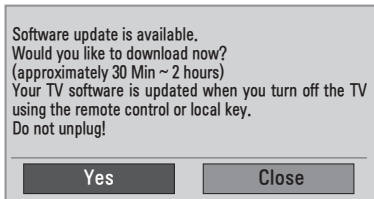

- Simple Update: for current update stream.

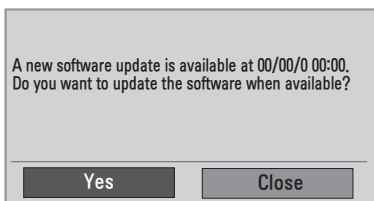

- Schedule Update: for scheduled update stream When the Software Update menu is "**Off**", the message to change it to "**On**" appears.

- Select the **Yes** using the < > button and you will see the following picture.
- When the power is turned off, downloading starts. When the power is turned on while updating, the progress status is displayed.

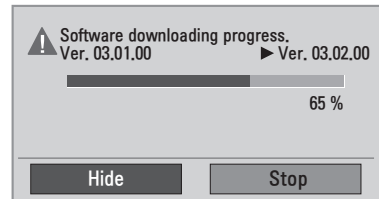

- After the Software Update is complete, the System restarts.

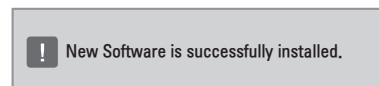

NOTE

- During Progress of a Software Update, please note the following
 - » The TV must not be switched off.
 - » The antenna must not be disconnected.
 - » After Software Update, you can confirm the updated software version in Diagnostics menu.
 - » It may take hours to download the software, so make sure that the power stays on during the download.

Diagnostics (Only DTV)

This function enables you to view information on the Manufacturer, Model/Type, Serial Number and Software Version.

- This displays the information and signal strength of the tuned ***MUX**.
 - This displays the signal information and service name of the selected ***MUX**.
 - ***MUX**: A higher directory of channels in digital broadcasting (a single MUX contains multiple channels.)
- 1 Press **MENU** to access the main menus.
 - 2 Press the Navigation buttons to scroll to **SETUP** and press **OK**.
 - 3 Press the Navigation buttons to scroll to **Diagnostics** and press **OK**.
 - 4 Display Manufacturer, Model / Type, Serial Number and Software Version.
 - 5 When you are finished, press **EXIT**.
When you return to the previous menu, press **BACK**.

CI [Common interface] Information (Only DTV)

This function enables you to watch some encrypted services (pay services). If you remove the CI Module, you cannot watch pay services. When the module is inserted into the CI slot, you can access the module menu. To purchase a module and smart card, contact your dealer. Do not repeatedly insert or remove a CI module from the TV. This may cause a malfunction. When the TV is turned on after inserting a CI Module, you may not have any sound output.

This may be incompatible with the CI module and smart card.

CI (Common Interface) functions may not be possible depending upon the country broadcasting circumstances.

When using a CAM(Conditional Access Module), please make sure it meets fully the requirements of either DVB CI or CI plus.

- 1 Press **MENU** to access the main menus.
- 2 Press the Navigation buttons to scroll to **SETUP** and press **OK**.
- 3 Press the Navigation buttons to scroll to **CI Information**. and press **OK**.
- 4 Select the desired item: Module information, smart card information, language, or software download etc and press **OK**.
- 5 When you are finished, press **EXIT**.
When you return to the previous menu, press **BACK**.



NOTE

- This OSD is only for illustration and the menu options and screen format will vary according to the Digital pay services provider.
- It is possible for you to change CI (Common Interface) menu screen and service by consulting your dealer.

Selecting the programme list

You can check which programmes are stored in the memory by displaying the programme list.

Displaying programme LIST

- 1 Press **LIST** to access the Programme List.
- 2 When you are finished, press **MENU** or **EXIT**.

NOTE

- You may find some blue programmes. These have been set up to be skipped by auto programming or in the programme edit mode.
- Some programmes with the channel number shown in the programme LIST indicate there is no station name assigned.

Selecting a programme in the programme list

- 1 Press the Navigation buttons to programme.
- 2 Switch to the chosen programme number and press **OK**.

NOTE

- Press **TV/RAD in Digital TV**. (The mode will be switched between TV, DTV and Radio from the program you are currently watching.)

Paging through a programme list

- 1 Press the Navigation buttons to turn the pages.
- 2 Return to normal TV viewing and Press **LIST**.

Favourite programme setup

Selecting favourite programme

Favourite programme is a convenient feature that lets you quickly scan up to programmes of your choice without having to wait for the TV to scan through all the in-between programmes.

- 1 Select your desired programme.
- 2 Press **Q.MENU** to access the **Favourite** menu.
- 3 Press the Navigation buttons to scroll to **Favourite**.
- 4 When you are finished, press **OK** or **Q.MENU**.

NOTE

- This will automatically include the selected programme into your favourite programme list.

Displaying the favourite programme list

- 1 Press **FAV** to access the Favourite Programme List.
- 2 When you are finished, press **EXIT**.

Using additional options

Adjusting aspect ratio

Resize the image to view the image at its optimal size by pressing **Q.MENU** while you are watching TV.

NOTE

- You can also change the image size by pressing **Q. MENU** or accessing Aspect Ratio in the **PICTURE** menu.

CAUTION

- If a fixed image displays on the screen for a long period of time, it will be imprinted and become a permanent disfigurement on the screen. This is "image burn" or "burn-in" and not covered by the warranty.
- If the aspect ratio is set to 4:3 for a long period of time, image burn may occur on the letterboxed area of the screen.

- **16:9**: The following selection will allow you to adjust the picture horizontally, in linear proportion, to fill the entire screen (useful for viewing 4:3 formatted DVDs).

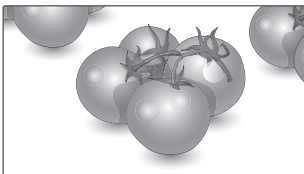

- **Just Scan**: Following Selection will lead to you view the picture of best quality without loss of original picture in high resolution image.
Note: If there is noise in original Picture, You can see the noise at the edge.



- **Original**: When your TV receives a wide screen signal it will automatically change to the picture format broadcast.

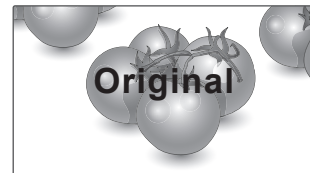

- **Full Wide**: When TV receives the wide screen signal, it will lead you to adjust the picture horizontally or vertically, in a linear proportion, to fill the entire screen fully.

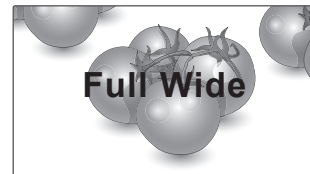

- **4:3:** The following selection will allow you to view a picture with an original 4:3 aspect ratio, gray bars will appear on both the left and right of the screen.

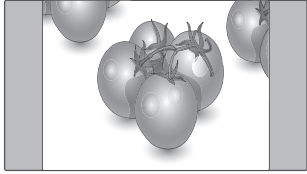

- **Cinema Zoom:** Choose Cinema Zoom when you want to enlarge the picture in correct proportion. Note: When enlarging or reducing the picture, the image may become distorted.

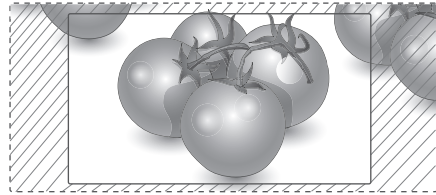

- **14:9:** You can view a picture format of 14:9 or a general TV programme in the 14:9 mode. The 14:9 screen is viewed in the same way as in 4:3, but is magnified to the left and right.

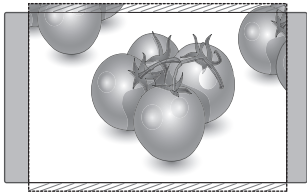

- **< or >** button: Adjust enlarge proportion of Cinema Zoom. The adjustment range is 1 to 16.
- **^ or v** button: Move the screen.

- **Zoom:** The following selection will allow you to view the picture without any alteration, while filling the entire screen. However, the top and bottom of the picture will be cropped.

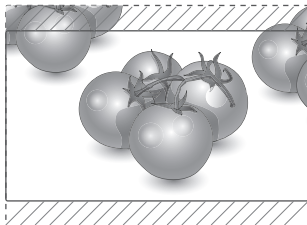
**NOTE**

- You can only select **4:3, 16:9 (Wide), 14:9, Zoom/Cinema Zoom** in Component mode.
- You can only select **4:3, Original, 16:9 (Wide), 14:9, Zoom/Cinema Zoom** in HDMI mode.
- You can only select **4:3, 16:9 (Wide)** in **RGB-PC, HDMI-PC** mode only.
- In DTV/HDMI/Component (over 720p) mode, **Just Scan** is available.
- In Analogue/AV mode, **Full Wide** is available.

Using the input list

Selecting an input source

- 1 Press **INPUT** to access the input source list.
- The connected device displays on each input source.
- 2 Press the Navigation buttons to scroll to one of the input sources and press **OK**.

Input source	Description
Antenna or Cable	Watch TV over the air, cable, and digital cable broadcast
RGB	View a PC display on the screen
AV 1/2	Watch the contents in a VCR or other external devices
Component	Watch the contents in a DVD or other external devices, or through a digital set-top box
HDMI 1/2	Watch contents in a PC, DVD or Digital settop box other high definition devices

The connected input sources display in black and the disconnected input sources in grey.
- If you add an input label to each input sources, you can easily identify a device connected to each input source.

Adding an Input label

- 1 Press **MENU** to access the main menus.
- 2 Press the Navigation buttons to scroll to **OPTION** and press **OK**.
- 3 Press the Navigation buttons to scroll to **Input Label** and press **OK**.
- 4 Press the Navigation buttons to scroll to one of the input sources.
- 5 Press the Navigation buttons to scroll to one of the input label and press **OK**.
- 6 When you are finished, press **EXIT**.
When you return to the previous menu, press **BACK**.



NOTE

- If you want to use HDMI-PC mode, you must set the input label to PC mode.



NOTE

- The **OSD (On Screen Display)** is displayed on the screen as shown below.
 - » When turning the product on in **HDMI** input.
 - » When switching to **HDMI** input.
 - » When connecting an **HDMI** cable with no signal.

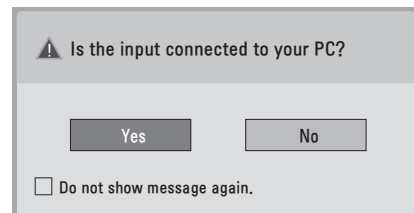

- If you select "**Yes**" the size and image quality are optimised for your PC.
- If you select "**No**" the size and image quality are optimised for the **AV device (DVD player, set-top box, gaming device)**.
- If you select "**Do not show message again**" this message does not appear until the TV is reset. You can change the set value in **MENU ► OPTION ► Input Label**.
- The values set for HDMI1/HDMI2 are saved independently.

On-screen menu language / Country selection

The installation guide menu appears on the TV screen when it is switched on for the first time.

- 1 Press the Navigation buttons to scroll to **Desired Language** and press **OK**.
- 2 Press the Navigation buttons to scroll to **Country** and press **OK**.

If you want to change Language / Country selection

- 1 Press **MENU** to access the main menus.
- 2 Press the Navigation buttons to scroll to **OPTION** and press **OK**.
- 3 Press the Navigation buttons to scroll to **Menu Language** or **Country** and press **OK**.
- 4 Press the Navigation buttons to scroll to **Desired Language** or **Country** option you want and press **OK**.
- 5 When you are finished, press **EXIT**.
When you return to the previous menu, press **BACK**.

! NOTE

- Country selection : Only DTV Mode
- When France is selected for Country, password is not '0' , '0' , '0' , '0' but '1' , '2' , '3' , '4' .
- If you do not finish the set-up **Installation Guide** by pressing **BACK** or if you time out on the OSD (On Screen Display) the installation menu will continuously appear until the set up is completed whenever the TV is switched on.
- If you select the wrong local country, teletext may not appear correctly on the screen and some problems may occur during teletext operation.
- The CI (Common Interface) function may not be applied based on country broadcasting circumstances.
- DTV mode control buttons may not function based on country broadcasting circumstances.
- In country that Digital broadcasting regulation isn't fixed, some DTV function may not work depending on digital broadcasting circumstances.
- The Country Setting "UK" should only be activated in UK.
- If the country setting is set to "--", European terrestrial/cable digital standard broadcasting programmes are available, but some DTV functions may not work properly.

Language selection (In digital mode only)(Only DTV)

The Audio function allows selection of a preferred language.

If audio data in a selected language is not broadcast, the default language audio will be played.

Use the Subtitle function when two or more subtitle languages are broadcast. If subtitle data in a selected language is not broadcast, the default language subtitle will be displayed.

When the languages you selected as the primary for **Audio Language** and **Subtitle Language** are not supported, you can select language in secondary category.

- 1 Press **MENU** to access the main menus.
- 2 Press the Navigation buttons to scroll to **OPTION** and press **OK**.
- 3 Press the Navigation buttons to scroll to **Audio Language** or **Subtitle Language** and press **OK**.
- 4 Press the Navigation buttons to scroll to **Desired Language** option you want and press **OK**.
- 5 When you are finished, press **EXIT**.
When you return to the previous menu, press **BACK**.

Audio Language Selection

When two or more audio languages are broadcast, you can select the audio language.

- 1 Press **Q.MENU** to access the quick menu.
- 2 Press the Navigation buttons to scroll to **Audio**.
- 3 Press the Navigation buttons to scroll to **Audio Language** option you want and press **OK**.
- 4 When you are finished, press **Q.MENU** or **EXIT**.



Audio Language OSD Information

Display	Status
N.A	Not Available
MPEG	MPEG Audio
Dolby Digital	Dolby Digital Audio
Visual Impaired	Audio for "Visual Impaired"
Hearing Impaired	Audio for "Hearing Impaired"
Dolby Digital Plus	Dolby Digital Plus Audio
AAC	AAC Audio

Subtitle Language Selection

When two or more subtitle languages are broadcast, you can select the subtitle language with the SUBTITLE button on the remote control. Press the Navigation buttons to select a subtitle language.

Subtitle Language OSD Information

Display	Status
N.A	Not Available
	Teletext Subtitle
	Subtitle for "Hard of Hearing"

- The audio/subtitles can be displayed in a simpler form with 1 to 3 characters broadcast by the service provider.
- When you select supplementary Audio (Audio for "Visual/Hearing Impaired") the TV may output a part of the Main audio.

Using the Lock options

Locking the buttons on the TV.

Enter the password, press '0', '0', '0', '0' on the remote control handset.







When France is selected for Country, password is not '0', '0', '0', '0' but '1', '2', '3', '4'.

Lock the buttons on the TV to prevent any unwanted operations or accidents by children.

- 1 Press **MENU** to access the main menus.
- 2 Press the Navigation buttons to scroll to **LOCK** and press **OK**.
- 3 Press the Navigation buttons to scroll to **Key Lock** and press **OK**.
- 4 Press the Navigation buttons to scroll to **On** and press **OK** to activate the Key lock feature.
- To deactivate the Key lock feature, select **Off**.
- 5 When you are finished, press **EXIT**.
When you return to the previous menu, press **BACK**.



NOTE

- The TV is programmed to remember the last setting after you turn the TV off.
- If you turn the TV off while the key lock feature is activated and wish to turn it back on, press the  /  on the TV. You can also switch the device on using the remote control by pressing the , **INPUT**, **P**, ,  or **Number** buttons.
- If you press any button on the TV with the Key lock feature activated,  **Key Lock On** appears on the screen.

Parental control (In digital mode only) (Only DTV)

This function operates according to information from the broadcasting station. Therefore if the signal has incorrect information, this function does not operate.

A password is required to gain access to this menu.

This set is programmed to remember which option it was last set to even if you switch the set off.

Prevents children from watching certain adult's TV programmes, according to the ratings limit set.

Enter a password to watch a blocked programme.

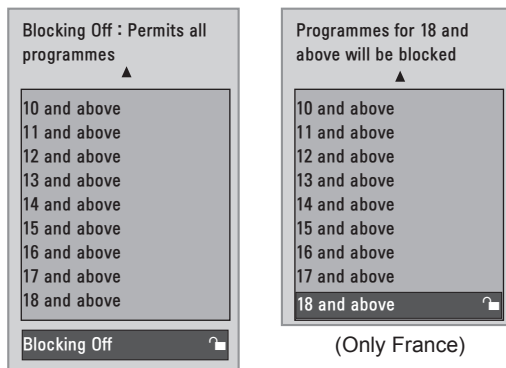

(Except for France)

- 1 Press **MENU** to access the main menus.
- 2 Press the Navigation buttons to scroll to **LOCK** and press **OK**.
- 3 Press the Navigation buttons to scroll to **Parental Guidance** and press **OK**.
- 4 Press the Navigation buttons to scroll to Make appropriate adjustments and press **OK**.
- 5 When you are finished, press **EXIT**.
When you return to the previous menu, press **BACK**.

Using the Quick menu

Customize the frequently using menus.

- 1 Press **Q.MENU** to access the quick menu.
- 2 Press the Navigation buttons to scroll through the following menus.

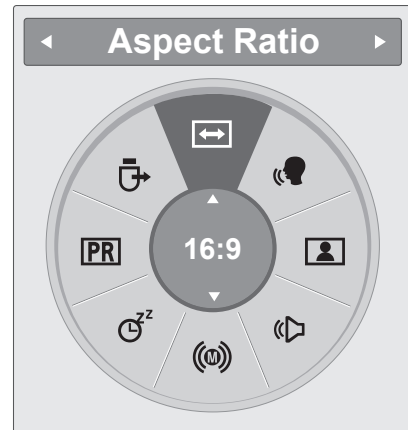

Menu	Description
Aspect Ratio	Resizes an image. (16:9, Just Scan, Original, Full Wide, 4:3, 14:9, Zoom, Cinema Zoom1)
Clear Voice II	By differentiating the human sound range from others, it helps users listen to human voices better.
Picture Mode	Selects one of the preset image modes (Vivid, Standard, Cinema, Sport, Game)
Sound Mode	Selects one of the sound modes (Standard, Music, Cinema, Sport, Game)
Audio	Selects the sound output.
Sleep Timer	Sets the length of time until the TV to turns off
Favourite	Selects the favourite programme.
USB Device	Selects "Eject" in order to eject USB device.

! NOTE

The available menus and options may differ from the input source that you are using.

- 3 Press the Navigation buttons to scroll to an option you want and press **OK**.

EPG (ELECTRONIC PROGRAMME GUIDE) (IN DIGITAL MODE) (ONLY DTV)











Using Electronic Programme Guide

This system has an Electronic Programme Guide (EPG) to help your navigation through all the possible viewing options.

The EPG supplies information such as programme listings, start and end times for all available services. In addition, detailed information about the programme is often available in the EPG (the availability and amount of these programme details will vary, depending on the particular broadcaster). This function can be used only when the EPG information is broadcast by broadcasting companies.

The EPG displays the programme details for next 8 days.

- 1 Press **INFO**  to shows the present screen information.

Icon	Description
	Displayed with a DTV Programme.
	Displayed with a Radio Programme.
	Displayed with a MHEG Programme.
	Displayed with a AAC Programme.
	Aspect ratio of broadcasting programme.
	
	Displayed with a Teletext Programme.
	Displayed with a Subtitle Programme.
	Displayed with a Scramble Programme.
	Displayed with a Dolby Programme.
	Displayed with a Dolby Digital PLUS Programme.



NOTE



Broadcasted programme with the icon may not be displayed in TV Out depending on the information of the programme.

- 576i/p, 720p, 1080i/p: Resolution of broadcasting programme

Switch on/off EPG

- 1 Press **GUIDE** to switch on or off EPG.

Select a programme

- 1 Press the Navigation buttons or PAGE buttons to select desired programme.
- 2 The EPG will disappear after moving to a selected program, press **OK**.

Button Function in NOW/NEXT Guide Mode

You can view a program being broadcasted and one scheduled to follow.

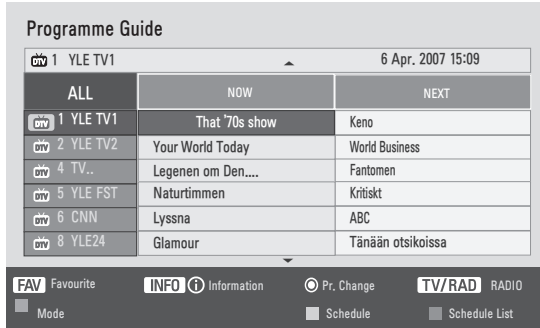

Button	Description
Red Button	Change EPG mode.
Yellow Button	Enter Timer Record/Remind setting mode.
Blue Button	Enter Timer Record/Remind list mode.
OK	The EPG will disappear after moving to a selected program.
< or >	Select NOW or NEXT Programme.
^ or v	Select the Broadcast Programme.
PAGE (^, v)	Page Up/Down.
GUIDE	Switch off EPG.
BACK	
EXIT	
TV/RAD	Select TV or RADIO Programme.
INFO ⓘ	Detail information on or off
FAV	This displays the now/next mode for the programme in the Favourite List.

Button Function in 8 Day Guide Mode

Button	Description
Red Button	Change EPG mode.
Green Button	Enter Date setting mode.
Yellow Button	Enter Timer Record/Remind setting mode.
Blue Button	Enter Timer Record/Remind list mode.
OK	The EPG will disappear after moving to a selected program.
< or >	Select NOW or NEXT Programme.
^ or v	Select the Broadcast Programme.
PAGE (^, v)	Page Up/Down.
GUIDE	Switch off EPG.
BACK	
EXIT	
TV/RAD	Select TV or RADIO Programme.
INFO ⓘ	Detail information on or off
FAV	This displays the 8 Day Guide mode for the programme in the Favourite List.

Button Function in Date Change Mode

Button	Description
Green Button	Switch off Date setting mode.
OK	Change to the selected date.
< or >	Select a date.
v	Switch off Date setting mode.
GUIDE	Switch off EPG.
BACK	
EXIT	

Button Function in Extended Description Box

Button	Description
^ or v	Text Up/Down.
Yellow Button	Enter Timer Record/Remind setting mode.
INFO ⓘ	The detail information on or off.
BACK	
GUIDE	Switch off EPG.

Button Function in Record/Remind Setting Mode

Sets a start or end time for recording, and sets only a start time for the reminder.

This function is available only when recording equipment that use pin8 recording signaling has been connected to the AV terminal, using a SCART cable.

Button	Description
BACK	Change to Guide or Schedule mode.
< or >	Select Record or Remind. Function setting.
^ or v	Select Date, Start/End time or Programme.
OK	Save Timer Record/Remind.

Button Function in Schedule List Mode

If you've created a schedule list, a scheduled program is displayed at the scheduled time even when you are watching a different program at the time.

Only the Up/Down/OK/BACK keys will work when a popup window is open.

Button	Description
Red Button	Add new Manual Recording setting mode.
Green Button	Add new Timer Watching setting mode.
Blue Button	Change to Guide mode.
GUIDE	
BACK	Switch off EPG.
EXIT	Select your desired Option(Modify/Delete/Delete All).
OK	
^ or v	Select Schedule List.
PAGE (^, v)	Page Up/Down.

CONNECTING TO A PC

Your TV supports the Plug & Play* feature and has the built-in speakers with Surround X that reproduces sound clearly with a rich bass.

* Plug & Play: The function when a PC recognizes a connected device that users connect to a PC and turn on, without device configuration or user intervention.

NOTE

- It is recommended to use the TV with the HDMI connection for the best image quality.
- If you want to use an optional external speaker instead of the built-in speaker, set the TV speaker feature to off (See p.63).

HDMI connection

Transmits the digital video and audio signals from your PC to the TV. Connect the PC and the TV with the HDMI cable as shown in the following illustrations. You should set PC as an input label to connect the PC to the TV with an HDMI connection. To add an input label, see Adding an Input label on See p.30.

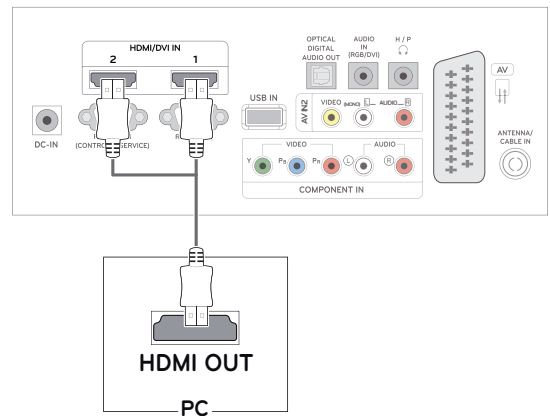

NOTE

- Use a High Speed HDMI™ Cable.
- Please check the PC environment if you cannot hear the sound in HDMI mode.
- If you want to use HDMI-PC mode, you must set the input label to PC mode.

DVI to HDMI connection

Transmits the digital video signal from your PC to the TV. Connect the PC and the TV with the DVI to HDMI cable as shown the following illustrations. To transmit an audio signal, connect an optional audio cable.

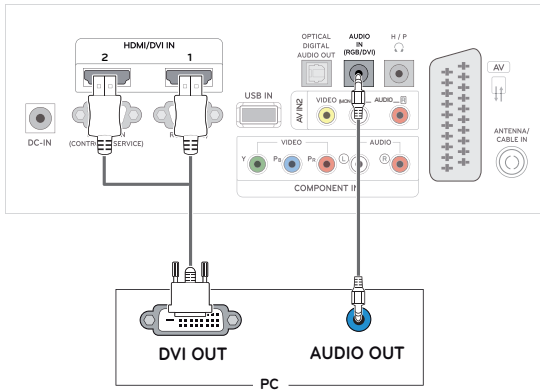

RGB connection

Transmits the analog video signal from your PC to the TV. Connect the PC and the TV with the D-sub 15 pin cable as shown the following illustrations. To transmit an audio signal, connect an optional audio cable.

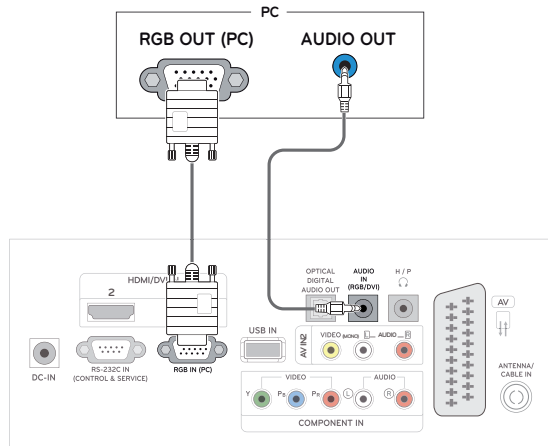

NOTE

- If you want to use HDMI-PC mode, you must set the input label to PC mode.
- If you do not use an optional external speaker, connect the PC to the TV with the optional audio cable.
- If you turn the TV on when the set becomes cold, the screen may flicker. This is normal.
- Use a shielded signal interface cable, such as D-sub 15 pin signal cable and DVI to HDMI cable, with a ferrite core to maintain standard compliance for the product.
- Some red, green, or blue spots may appear on the screen. This is normal.

CAUTION

- Connect the signal input cable and tighten it by turning the screws clockwise.
- Do not press the screen with your finger for a long time as this may result in temporary distortion on the screen.
- Avoid displaying a fixed image on the screen for a long period of time to prevent image burn. Use a screensaver if possible.

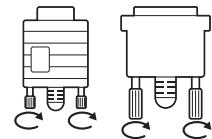

Adjusting the screen

Selecting an image mode

Display images in its optimized settings by selecting one of the preset image modes.

- 1 Press **MENU** to access the main menus.
- 2 Press the Navigation buttons to scroll to **PICTURE** and press **OK**.
- 3 Press the Navigation buttons to scroll to **Picture Mode** and press **OK**.
- 4 Press the Navigation buttons to scroll to an image mode you want and press **OK**.

Mode	Description
Vivid	Adjusts the video image for the retail environment by enhancing the Contrast, Brightness, Colour, and Sharpness .
Standard	Adjusts the image for the normal environment.
Cinema	Optimizes the video image for the cinematic look and enjoy movies as if you are in a movie theater.
Sport	Optimizes the video image for high and dynamic actions by emphasizing primary Colours such as white, grass, or sky blue.
Game	Optimizes the video image for a fast gaming screen such as PCs or games.
Expert1/2	Adjusts the detailed video image settings for video experts as well as general viewers.

- 5 When you are finished, press **EXIT**.
When you return to the previous menu, press **BACK**.

Customizing image options

Customize basic and advanced options of each image mode for the best screen performance.

- 1 Press **MENU** to access the main menus.
- 2 Press the Navigation buttons to scroll to **PICTURE** and press **OK**.
- 3 Press the Navigation buttons to scroll to **Picture Mode** and press **OK**.
- 4 Press the Navigation buttons to scroll to an image mode you want and press **OK**.
- 5 Select and adjust following options, and then press **OK**.

Option	Description
Backlight	Adjusts the brightness of the screen by controlling the LCD backlight. If you decrease the brightness level, the screen becomes darker and the power consumption will be reduced without any video signal loss.
Contrast	Increases or decreases the gradient of the video signal. You may use Contrast when the bright part of the image is saturated.
Brightness	Adjusts the base level of the signal in the image. You may use Brightness when the dark part of the image is saturated.
Sharpness	Adjusts the level of crispness in the edges between the light and dark areas of the picture. The lower the level, the softer the image.
Colour	Adjusts intensity of all Colours .
Tint	Adjusts the balance between Red and Green levels.
Colour Temperature	Set to warm to enhance hotter colours such as red, or set to cool to make picture bluish.
Advanced Control	Customizes the advanced options. See more information about advanced options See p.62.
Picture Reset	Restores the options to the default setting.

- 6 When you are finished, press **EXIT**.
When you return to the previous menu, press **BACK**.

Customizing PC display options

Customize options of each image mode for the best image quality.

- This function works in the following mode: RGB[PC] mode.
- 1 Press **MENU** to access the main menus.
 - 2 Press the Navigation buttons to scroll to **PICTURE** and press **OK**.
 - 3 Press the Navigation buttons to scroll to **Screen** and press **OK**.
 - 4 Select and adjust following options, and then press **OK**.

Option	Description
Resolution	Match the resolution of RGB mode. (Resolution menu is Enabled only for the following resolution with 60Hz.)
	Vertical resolution : 768
	1024 x 768(Default) 1280 x 768 1360 x 768
	Vertical resolution : 900
	1280 x 960(Default) 1440 x 900 1600 x 900
	Vertical resolution : 1050
	1400 x 1050 1680 x 1050(Default)
Auto Configure	Sets to adjust the screen Position , Size and Phase automatically. The displayed image may be unstable for a few seconds while the configuration is in progress.
Position/ Size/Phase	Adjusts the options when the image is not clear, especially when characters are shaky, after the auto configuration.
Reset	Restores the options to the default setting.

- 5 When you are finished, press **EXIT**.
When you return to the previous menu, press **BACK**.

Adjusting the sound

Selecting an sound mode

Play the sound in its optimized settings by selecting one of the preset sound modes.

- 1 Press **MENU** to access the main menus.
- 2 Press the Navigation buttons to scroll to **AUDIO** and press **OK**.
- 3 Press the Navigation buttons to scroll to **Sound Mode** and press **OK**.
- 4 Press the Navigation buttons to scroll to a sound mode you want and press **OK**.

Mode	Description
Standard	Selects when you want standard-quality sound.
Music	Selects when you listen to music.
Cinema	Selects when you watch movies.
Sport	Selects when you watch sports events.
Game	Selects when you play games.

- 5 When you are finished, press **EXIT**.
When you return to the previous menu, press **BACK**.

Customizing sound options

Customize options of each sound mode for the best sound quality.

- 1 Press **MENU** to access the main menus.
- 2 Press the Navigation buttons to scroll to **AUDIO** and press **OK**.
- 3 Press the Navigation buttons to scroll to **Sound Mode** and press **OK**.
- 4 Press the Navigation buttons to scroll to a sound mode you want and press **OK**.
- 5 Select and adjust following options, and then press **OK**.

Option	Description
Surround X	This option enhances sound depth and clarity by maximizing the Surround effect.
Treble	Controls the dominant sounds in the output. When you turn up the treble, it will increase the output to the higher frequency range.
Bass	Controls the softer sounds in the output. When you turn up the bass, it will increase the output to the lower frequency range.
Reset	Resets the sound mode to the default setting.

- 6 When you are finished, press **EXIT**.
When you return to the previous menu, press **BACK**.

ENTERTAINMENT

Using integrated media features

Connecting USB storage devices

Connect USB storage devices such as a USB flash memory, external hard drive, or MP3 player to the TV and use multimedia features (“**Browsing files**” See p.45).

Connect a USB flash memory or USB memory card reader to the TV as shown on the following illustration. The USB screen appears.

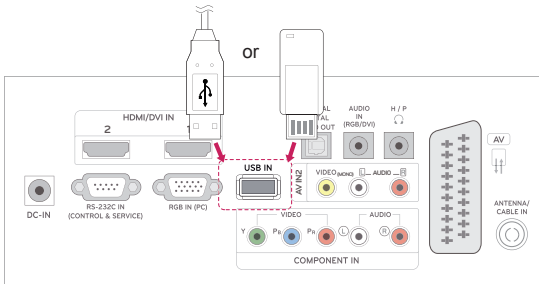

To disconnect a USB storage device, make sure to end the connection properly to prevent damages to the TV or files.

- 1 Press **Q.MENU** to access the quick menus.
- 2 Press the Navigation buttons to scroll to **USB Device** and press **OK**.
- 3 Disconnect the USB storage device only when the message says that it is safe to remove.



CAUTION

- Do not turn the TV off or remove a USB storage device while the USB storage device is connected to the TV, as this could result in loss of files or damage to the USB storage device.
- Back up your files saved on a USB storage device frequently, as you may lose or damage the files and this may be not covered by the warranty.

Tips for using USB storage devices

- Only a USB storage device is recognizable.
- If the USB storage device is connected through a USB hub, the device is not recognizable.
- A USB storage device using an automatic recognition programme may not be recognized.
- A USB storage device which uses its own driver may not be recognized.
- The recognition speed of a USB storage device may depend on each device.
- Please do not turn off the TV or unplug the USB device when the connected USB storage device is working. When such device is suddenly separated or unplugged, the stored files or the USB storage device may be damaged.
- Please do not connect the USB storage device which was artificially maneuvered on the PC. The device may cause the product to malfunction or fail to be played. Never forget to use only a USB storage device which has normal music files, image files or movie files.
- Please use only a USB storage device which was formatted as a FAT, FAT16, FAT32, NTFS file system provided with the windows operating system. In case of a storage device formatted as a different utility programme which is not supported by Windows, it may not be recognized.
- Please connect power to a USB storage device(over 0.5 A) which requires an external power supply. If not, the device may not be recognized.
- Please connect a USB storage device with the cable offered by the device maker.
- Some USB storage devices may not be supported or operated smoothly.
- File alignment method of USB storage device is similar to Window XP and filename can recognize up to 100 English characters.
- Be sure to back up important files since data stored in a USB memory device may be damaged. We will not be responsible for any data loss.
- If the USB HDD does not have an external power source, the USB device may not be detected. So be sure to connect the external power source.
 - Please use a power adaptor for an external power source. We do not guarantee an USB cable for an external power source.
- Data in a USB storage device cannot be deleted in the NTFS file system.
- If your USB memory device has multiple partitions or if you use a USB multi-card reader, you can use up to 4 partitions or USB memory devices.
- Only the FAT, FAT16, FAT32 file system supports the delete function.
- If a USB memory device is connected to a USB multi-card reader, its volume data may not be detected.
- If the USB memory device does not work properly, disconnect and reconnect it.
- How fast a USB memory device is detected differs from device to device.
- If the USB is connected in Standby Mode, specific hard disk will automatically be loaded when the TV is turned on.
- The recommended capacity is 1 TB or less for a USB external hard disk and 32 GB or less for USB memory.
- Any device with more than the recommended capacity may not work properly.
- If a USB external hard disk with a "Energy Saving" function does not work, turn the hard disk off and on again to make it work properly.
- USB storage devices below USB 2.0 are supported as well. But they may not work properly in the movie list.
- When a broken file is played in the USB storage, the TV may turn off or work abnormally.

Browsing files

Access the **Photo**, **Music** or **Movie** lists and browse files.

- 1 Connect a **USB** storage device.
- 2 Press the Navigation buttons to scroll to **PHOTO LIST**, **MUSIC LIST** or **MOVIE LIST** and press **OK**.



- 3 Select **Drive1** to access the connected USB storage device

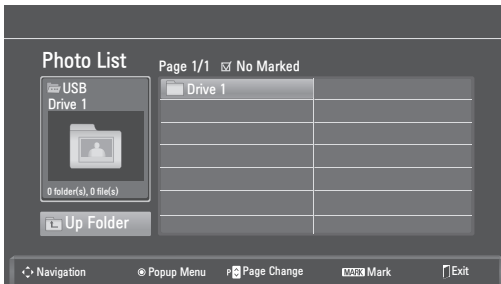

- 4 Select a folder you want.
 - To return to the previous level, select **Up Folder**.

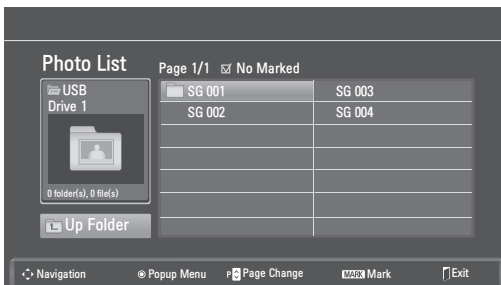

- 5 Press the Navigation buttons to browse files. The highlighted file will display in the preview window.

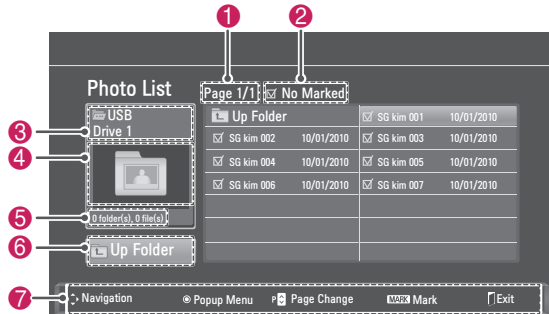

No.	Description
1	Current page number/total number of pages
2	The number of selected files
3	File and Folder name
4	Preview window
5	File size, information.
6	Return to the previous level
7	Available buttons on the remote control

Supported file format

Type	Supported file format
Photo	<ul style="list-style-type: none"> JPG Available size Baseline: 64 pixel (W) x 64 pixel (H) - 15360 pixel (W) x 8640 pixel (H) Progressive: 64 pixel (W) x 64 pixel (H) - 1920 pixel (W) x 1440 pixel (H)
Music	<ul style="list-style-type: none"> MP3 Bit rate range 32 Kbps - 320 Kbps Sampling rate (Sampling Frequency) MPEG1 layer 3: 32 kHz, 44.1 kHz, 48 kHz MPEG2 layer 3: 16 kHz, 22.05 kHz, 24 kHz MPEG2.5 layer 3: 8 kHz, 11.025 kHz, 12 kHz * A copy-protected file will not play.
Video	<ul style="list-style-type: none"> dat, mpg, mpeg, ts, trp, tp, vob, mp4, mkv, avi, divx Max bit rate of playable movie file: 20Mbps (Mega bit per second) Bit rate of audio format: within 32 - 320kbps (MP3) Supported subtitle format: *.smi, *.srt, *.sub (MicroDVD, SubViewer1.0/2.0), *.ass, *.ssa, *.txt (TMPlayer), *.psb(PowerDivx)

Viewing Photos

View image files saved in a USB storage device. The displays on the screen may differ from the model.

- 1 Press the Navigation buttons to scroll to **USB** and press **OK**.
- 2 Press the Navigation buttons to scroll to **Photo List** and press **OK**.
- 3 Press the Navigation buttons to select **Drive1** to access the connected USB storage device.
- 4 Press the Navigation buttons to scroll to a folder you want and press **OK**.
- 5 Press the Navigation buttons to scroll to a file you want and press **OK**.

A pop-up window will appear.

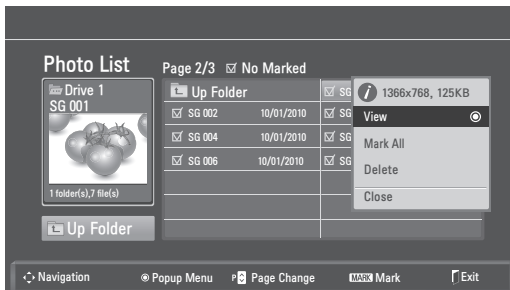

- 6 View photos by using the following menus.

Menu	Description
View	Displays the selected photo in a full-screen view. <ul style="list-style-type: none"> • Drive: Views photos saved in a USB storage drive.
Mark All or Unmark All	Selects all files or clears all of your selections
Delete	Deletes a file saved in a USB storage device. <div style="border: 1px solid black; padding: 5px; margin-top: 10px;"> <p>NOTE</p> <p>You cannot delete the files saved in a shared folder of a PC.</p> </div>
Close	Closes the pop-up menu.

Using photo options

Use the following options while viewing photos.

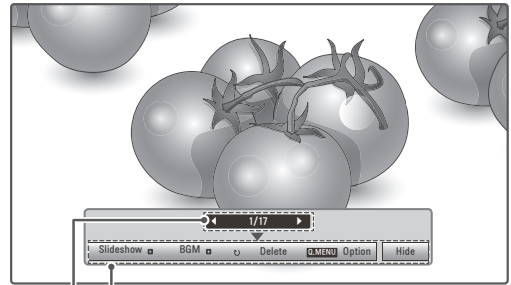

Options
Number of selected photos

Option	Description
Slideshow	Starts or stops a slideshow with selected photos. If there are no selected photos, all photos saved in the current folder display during a slideshow. To set a slideshow speed, select Option .
BGM	Turns the background music on or off. To set the background music folder, select Option .
(Rotate)	Rotates photos clockwise (90°, 180°, 270°, 360°). <div style="border: 1px solid black; padding: 5px; margin-top: 10px;"> <p>NOTE</p> <p>The supported photo size is limited. You cannot rotate a photo if the resolution of the rotated width is larger than the supported resolution size.</p> </div>
Delete	Deletes a photo.
Option	<ul style="list-style-type: none"> • Slide Speed: Selects a slideshow speed (Fast, Medium, Slow). • Music Album: Selects a music folder for the background music. <div style="border: 1px solid black; padding: 5px; margin-top: 10px;"> <p>NOTE</p> <p>You cannot change the music folder while the background music is playing.</p> </div>
Hide	Hides the option window. To display the options, press OK .

Q.MENU options for Photo List.

- 1 Press **Q. MENU** to access the **Pop-Up** menus.
- 2 Press the Navigation buttons to scroll to **Set Photo View** or **Set Video**, **Set Audio** and Press **OK**



When you select the **Set Photo View**.

- 1 Press **Q. MENU** to access the **Pop-Up** menus.
- 2 Press the Navigation buttons to scroll to **Slide Speed** or **Music Folder**.
- 3 Press the Navigation buttons to make appropriate adjustments and press **OK**.

NOTE

- When **“Off”** is selected in **Repeat** menu, replay will stop once the last file in the list finishes playing. But, when **“▶▶”** button is pressed while the last file in the list is in the middle of replay and **“Repeat”** is in **“Off”** position, the first file in the list will be play.

When you select the **Set Video**.

- 1 Press the Navigation buttons to make appropriate adjustments.(See p.61)

When you select the **Set Audio**.

- 1 Press the Navigation buttons to show the **Sound Mode**, **Auto Volume**, **Clear Voice II**, **Balance**.
- 2 Press the Navigation buttons to make appropriate adjustments.(See p.63)

Listening to Music

- 1 Press the Navigation buttons to scroll to **USB** and press **OK**.
- 2 Press the Navigation buttons to scroll to **Music List** and press **OK**.
- 3 Select **Drive1** to access the connected USB storage device.
- 4 Press the Navigation buttons to scroll to a folder you want and press **OK**.
- 5 Press the Navigation buttons to scroll to a file you want and press **OK**.
A pop-up window will appears.

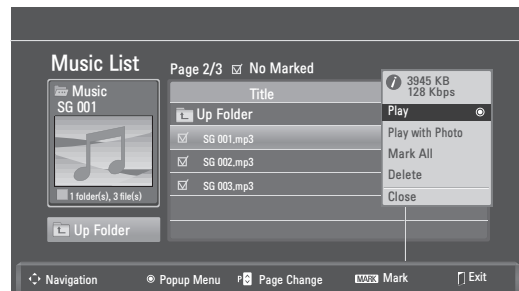

- 6 Play music by using the following menus.

Menu	Description
Play, Stop Play, or Play Marked	Plays music, stops playback, or plays the selected music file. If you play music without selecting music files, all of the music files saved in the current folder will play. The ♪ icon will appear in front of the duration on the currently playing file. • Drive : Listen to music files saved in a USB storage drive.
Play with Photo	Displays photos during playback.
Mark All or Unmark All	Selects all files or clears all of your selections
Delete	Deletes a file saved in a USB storage device.
Close	Closes the pop-up menu.

- 7 Control playback by using the following buttons.

Button	Description
■	Stops playback
▶	Plays a music file
⏸	Pauses or resumes playback
▶▶	Skips to the next file
◀◀	Skips to the previous file

NOTE

- A damaged or corrupted file will not play and the duration of the file display as 00:00.
- A copy-protected file will not play.
- If the TV is not in use for some time during playback, the information box as a screensaver will appear to prevent image burn.

To return to the Music list screen, press **OK** or **BACK**.

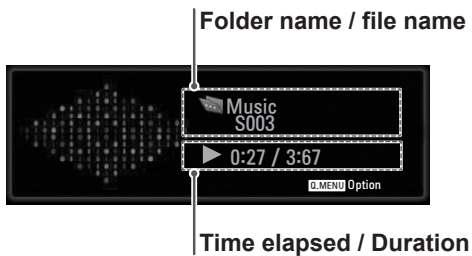

Q.MENU options for Music List

- 1 Press **Q. MENU** to access the **Pop-Up** menus.
- 2 Press the Navigation buttons to scroll to **Set Audio Play** or **Set Audio** and Press **OK**.



When you select the **Set Audio Play**.

- 1 Press the Navigation buttons to show the **Set Audio Play**.
- 2 Press the Navigation buttons to make appropriate adjustments.

NOTE

- When "Off" is selected in **Repeat** menu, replay will stop once the last file in the list finishes playing. But, when "▶▶" button is pressed while the last file in the list is in the middle of replay and "Repeat" is in "Off" position, the first file in the list will be play.

When you select the **Set Audio**.

- 1 Press the Navigation buttons to to show the **Sound Mode, Auto Volume, Clear Voice II, Balance**.
- 2 Press the Navigation buttons to to make appropriate adjustments.(See p.63)

Viewing Movies

Play video files on the TV. Your TV displays all of the video files saved in a USB storage device.

- Movie (*.dat / *.mpg / *.mpeg / *.ts / *.trp / *.tp / *.vob / *.mp4 / *.mkv / *.avi / *.divx) supporting file.
- Video format: DivX3.11, DivX4.12, DivX5.x, DivX6, Xvid1.00, Xvid1.01, Xvid1.02, Xvid1.03, Xvid 1.10- beta-1/beta-2, Mpeg-1, Mpeg-2, Mpeg-4, H.264/AVC
- Audio format: Dolby Digital, AAC, Mpeg, MP3, LPCM, HE-AAC
- Bit rate: within 32 kbps to 320 kbps (MP3)
- Subtitle format: *.smi / *.srt / *.sub (Micro DVD, SubViewer1.0/2.0) / *.ass / *.ssa / *.txt (TM Player) / *.psb (Power Divx).
- Some user-created subtitles may not work properly.
- Some special characters are not supported in subtitles.
- HTML tags are not supported in subtitles.
- Subtitles in languages other than the supported languages are not available.
- Time information in an external subtitle file should be arranged in ascending order to be played.
- The screen may suffer temporary interruptions (image stoppage, faster playback, etc.) when the audio language is changed.
- A damaged movie file may not be played correctly, or some player functions may not be usable.
- Movie files produced with some encoders may not be played correctly.
- If the video and audio structure of recorded file is not interleaved, either video or audio is outputted.
- HD videos with a maximum of 1920 x 1080 @ 25/30P or 1280 x 720 @ 50/60P are supported, depending on the frame.
- Videos with resolutions higher than 1920 x 1080 @ 25/30P or 1280 x 720 @ 50/60P may not work properly depending on the frame.
- Movie files other than the specified types and formats may not work properly.
- **Max bit rate of playable movie file is 20 Mbps.**
- We do not guarantee smooth playback of

profiles encoded level 4.1 or higher in H.264 / AVC.

- DTS Audio codec is not supported.
- A movie file more than 30GB in file size is not supported for playback.
- A DivX movie file and its subtitle file must be located in the same folder.
- A video file name and its subtitle file name must be identical for it to be displayed.
- Playing a video via a USB connection that doesn't support high speed may not work properly.
- Files encoded with GMC (Global Motion Compensation) may not be played.
- When you are watching the movie by Movie List function, you can adjust an image by **Energy Saving** key on the remote control. User setup for each image mode does not operate.

Video Decoder

- **mpeg, vob:** MPEG1, MPEG2
- **dat:** MPEG1
- **ts, trp, tp:** MPEG2, H.264 / AVC
- **mp4:** MPEG4 SP, MPEG4 ASP, Divx 3.11, Divx 4.12, Divx 5.x, Divx 6, Xvid 1.00, Xvid 1.01, Xvid 1.02, Xvid 1.03, Xvid 1.10-beta 1, Xvid 1.10-beta 2, H.264/AVC
- **avi:** MPEG 2, MPEG 4 SP, MPEG4 ASP, Divx 3.11, Divx 4, Divx 5, Divx 6, Xvid 1.00, Xvid 1.01, Xvid 1.02, Xvid 1.03, Xvid 1.10-beta 1, Xvid 1.10-beta 2, H.264/AVC
- **mkv:** H.264 / AVC, MPEG 1, MPEG 2, MPEG 4 SP, MPEG4 ASP
- **divx:** MPEG 2, MPEG 4 SP, MPEG4 ASP, Divx 3.11, Divx 4, Divx 5, Divx 6, Xvid 1.00, Xvid 1.01, Xvid 1.02, Xvid 1.03, Xvid 1.10-beta 1, Xvid 1.10-beta 2, H.264 / AVC

Audio Codec

- **mpeg, vob:** Dolby Digital, MPEG, MP3, LPCM
- **dat:** Dolby Digital, MPEG, MP3, LPCM
- **ts, trp, tp:** Dolby Digital, AAC, MPEG
- **mp4:** Dolby Digital, HE-AAC, AAC, MPEG, MP3, LPCM
- **avi:** Dolby Digital, HE-AAC, AAC, MPEG,

MP3, LPCM

- **mkv:** Dolby Digital, HE-AAC, AAC, MPEG, MP3, LPCM
- **divx:** Dolby Digital, HE-AAC, AAC, MPEG, MP3, LPCM

NOTE

The  image under the preview window will appear if you select a non-supported file.

Max Resolution

- **1920 x 1080 @ 30p**

- 1 Press the Navigation buttons to scroll to **USB** and press **OK**.
- 2 Press the Navigation buttons to scroll to **Movie List** and press **OK**.
- 3 Select **Drive1** to access the connected USB storage device.
- 4 Press the Navigation buttons to scroll to a folder you want and press **OK**.
- 5 Press the Navigation buttons to scroll to a file you want and press **OK**.
A pop-up window will appear.

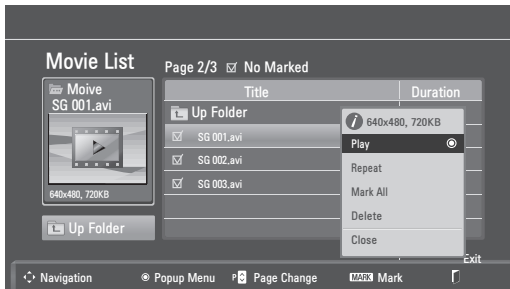

- 7 Control playback by using the following buttons.

Button	Description
INFO ⓘ	Views the information of the currently playing video
■	Stops the playback
▶	Plays a video
⏸	Pauses or resumes the playback
◀◀	Scans backward in a file
▶▶	Scans forward in a file
< or >	Skips to specific points in a file during playback. The time of a specific point will appear on the status bar. In some files, this function may not work properly.
◀◀ or ▶▶	Plays videos in slow motion
ENERGY SAVING ⓘ	Press the ENERGY SAVING button repeatedly to increase the brightness of your screen.

Q.MENU options for Movie List

- 1 Press **Q. MENU** to access the **Pop-Up** menus.
- 2 Press the Navigation button and **OK** to scroll to **Set Video Play, Set Video** or **Set Audio**.

- 6 Play video by using the following menus.

Menu	Description
Play or Play Marked	Plays a movie or plays the selected movie. • Drive: Views videos saved in a USB storage drive.
Repeat or Repeat Marked	Repeats a movie or Repeats the selected movie.
Mark All or Unmark All	Selects all files or clears all of your selections.
Delete or Delete marked	Deletes a file formatted on the FAT32 file system and saved in a USB storage device.
Close	Closes the pop-up menu.

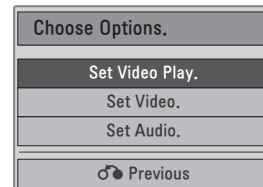

When you select the Set Video Play.

Menu	Description
Picture Size	Selects your desired picture format during movie play
Audio Language or Subtitle Language	Changes the Language Group of the audio/subtitle during movie play.
Sync	Adjusts the time synchronisation of the subtitle from -10 secs to +10 secs by steps of 0.5 secs during movie play.
Position	Changes the position of the subtitle either up or down during movie play.
Size	Selects your desired Subtitle size during movie play.

- 1 Press the Navigation button to show the **Picture Size, Audio Language or Subtitle Language**.
- 2 Press the Navigation button to make appropriate adjustments.

Subtitle Language	Support Language
Latin1	English, Spanish, French, German, Italian, Swedish, Finnish, Dutch, Portuguese, Danish, Romanian, Norwegian, Albanian, Gaelic, Welsh, Irish, Catalan, Valencian
Latin2	Bosnian, Polish, Croatian, Czech, Slovak, Slovenian, Serbian, Hungarian
Latin4	Estonian, Latvian, Lithuanian
Cyrillic	Bulgarian, Macedonian, Russian, Ukrainian, Kazakh
Greek	Greek
Turkish	Turkish

NOTE

- Only the files saved in ASCII CODE is supported for the external subtitles of the movie.
- Only 500 alphabets and 500 numbers are supported for each line of the subtitle.
- Only 10,000 of sync blocks can be supported within the subtitle file.

When you select the Set Video.

- 1 Press the Navigation button to make appropriate adjustments. (See p.61)

When you select the Set Audio,

- 1 Press the Navigation button to show the **Sound Mode, Auto Volume, Clear Voice II, Balance**.
- 2 Press the Navigation button to make appropriate adjustments. (See p.63)
Using the remote control.

Button	Description
◀▶	When playing, repeatedly, press the REW(◀) button to speed up ◀(x2) ◀◀(x4) ◀◀◀(x8) ◀◀◀◀(x16) ◀◀◀◀◀(x32). repeatedly, press the FF(▶) button to speed up ▶(x2) ▶▶(x4) ▶▶▶(x8) ▶▶▶▶(x16) ▶▶▶▶▶(x32). <ul style="list-style-type: none"> • Pressing these buttons repeatedly increases the fast forward/reverse speed.
Pause (II)	During playback, press the Pause (II) button. <ul style="list-style-type: none"> • Still screen is displayed. • If no buttons are pressed on the remote control for 10 minutes after pausing, the TV returns to the playback state. • Press the Pause (II) button and then use the FF (▶▶) button for slow motion.
< or >	When using the < or > button during playback a cursor indicating the position can be viewed on the screen.
Play (▶)	Press the Play (▶) button to return to normal playback.
ENERGY SAVING 	Press the ENERGY SAVING button repeatedly to increase the brightness of your screen. (See p.60)

DivX® VOD Guide

DivX(R) VOD Registration

In order to play purchased or rented DivX® VOD contents, you should register your device with 10 digit DivX registration code from your device at www.divx.com/vod.

- 1 Press **MENU** to access the **USB** menus.
- 2 Press the Navigation button to scroll to **DivX Reg. Code** and press **OK**.
- 3 View the registration code of your TV.

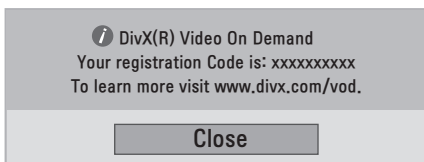

NOTE

- While you are checking the registration code, some buttons may not work.
- If you use the DivX registration code of another device, you cannot play the rented or purchased DivX file. Make sure to use the DivX registration code assigned to your TV.
- The video or audio files that are not converted by the standard DivX codec may be corrupted or not be played.
- The DivX VOD code allows you to activate up to 6 devices under one account.

DivX® VOD Deregistration

You should deregister your device with 8 digit DivX deregistration code from your device at www.divx.com/vod.

NOTE

Once the deregistration is executed, you must register your device again to see DivX® VOD contents.

- 1 Press **MENU** to access the **USB** menus.
- 2 Press the Navigation button to scroll to **Deactivation** and press **OK**.
- 3 Select **Yes** to confirm.

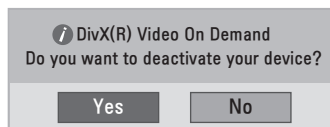

- 4 Select **Close**.



- 5 When you are finished, press **EXIT**. When you return to the previous menu, press **BACK**.

3D IMAGING

3D Technology

This TV can display in 3D via 3D broadcasting or when the TV is connected to a compatible device, such as a Blu-ray 3D Player. The viewer must wear compatible 3D glasses in order to see these images in 3D format.



NOTE

- After powering on the TV, a few seconds may be needed for your TV to calibrate.
- When watching digital TV in 3D imaging mode, TV out signals cannot be output through the SCART cable.
- If you set the 3D mode to On while a scheduled recording is performed on digital TV, TV out signals cannot be output through the SCART cable, and the recording cannot be performed.
- If 3D TV broadcast standard changes in the future and it is not supported by this TV set, you may need a separate device, such as a set-top box.

Precautions to take when viewing 3D images



WARNING

- If you view 3D images from too close a distance, your eyesight may deteriorate.
- If you view images in 3D for a long period of time, you may feel dizzy or experience blurred vision.
- If you are pregnant, elderly, have heart problems, experience severe nausea or if you are under the influence of alcohol, we recommend that you do not view 3D images.
- This is because the 3D images can cause disorientation and confusion.
- Put fragile or breakable objects away when viewing 3D images.
- Such objects may break, or cause personal injuries when you are startled by the realistic 3D images.
- Parents should prevent children who are 5 years or younger from watching 3D images because viewing 3D images can be harmful to vision development.
- Warning about photosensitivity seizures

Some users may have a seizure or other abnormal reactions when they are exposed to a flashing light or a particular pattern in a video game or film. If anyone in your family has a history of epilepsy or has ever experienced any kind of seizure, please consult your doctor before viewing 3D images. If you exhibit any of the symptoms listed below when viewing 3D images, stop viewing immediately and have a break.

- » Dizziness, blurred vision or facial tics, involuntary movements, twitching, blackouts, confusion and disorientation. Please consult your doctor if such symptoms persist.
- To prevent a photosensitivity seizure, please take the following precautions.
 - » Have a 5- to 15-minute break every hour.
 - » If your left and right eye sight is significantly different, correct the sight difference first.
 - » You should be able to see all of the screen at eye level.
 - » If you experience headaches, fatigue or dizziness, stop viewing and have a rest.
 - » Do not view 3D images when you are tired or ill.

**CAUTION**

- Parents/guardians should TV children's viewing of 3D images because they may not be used to the 3D viewing experience and lack knowledge on how to handle potential risks.

When using 3D Glasses

**CAUTION**

- Do not use the 3D glasses to replace your corrective glasses, sunglasses or protective goggles.
- Do not store the 3D glasses in hot or cold locations.
- Do not drop objects onto the 3D glasses. Do not drop or bend the glasses.
- Since the lenses of the 3D glasses are easily scratched, make sure to clean only with a soft cloth. Shake off any dust before using the cloth
- Do not scratch the surface of the lens(Polarized film) of 3D glasses with a sharp tool or wipe the lens with chemicals.
- The lens of the 3D glasses is different from those of general glasses, and is very thin. Therefore be careful with the glasses as the lens can be popped out easily.
- Be careful of the edges of the glass frame when putting on the 3D glasses.

3D Imaging Viewing Range

TV size, viewing angle & other circumstances may change the viewing distance and the angle of view.

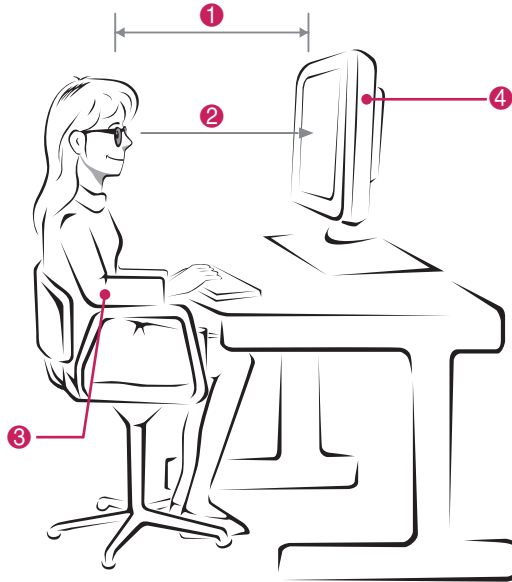

No.	Description
①	Adjust your distance from the TV to allow you to view images from the optimal distance (L).
②	Adjust the TV and your posture to allow you to view images at the optimal viewing angle (D).
③	Place your hands gently on the keyboard, keeping your arms bent at the elbows and horizontally outright.
④	Adjust the location of the TV to avoid it reflecting light.

Mode	When viewing 3D images
Size(Inch)	686 mm
Optimal viewing distance (L)	70 cm
Up/Down Optimal viewing angle (D)	14°

Viewing 3D Imaging

- 1 Play the video produced in 3D.
- 2 Press **3D**.
- 3 Wear the 3D glasses.
- 4 Press the Navigation buttons to scroll the OK and press **OK**.
- 5 Press the Navigation buttons to scroll the shape and press **OK**.

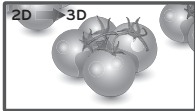
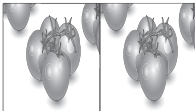
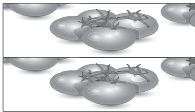
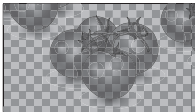
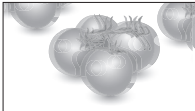
Mode	Description
2D → 3D	Changed from 2D imaging to 3D imaging. 
Side by Side	
Top & Bottom	
Checker Board	
Frame Sequential	

- 6 Press **3D** button to to **2D Off** or **3D Off**.

Mode	Description
3D → 2D	Displays images in 2D without any 3D effects.
2D → 3D	Displays images in 3D.
3D Off	Displays images in original format.
Cancel	Close the pop-up window.

3D Mode Setting Option

- 1 Press **3D SETTING** to access the **Pop-Up** menus.
- 2 Press the Navigation buttons to scroll to one of the following options and press **OK**

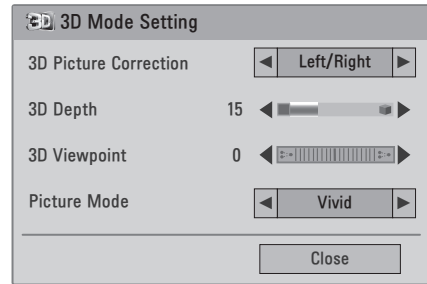

The available Programme settings are described in the following:

Option	Description	
3D Picture Correction	Select Left/Right or Right/Left. Select the screen with 3D video with better visibility.	
3D Depth	Adjusts the stereoscopic effect of the 3D image converted from a 2D image.	
3D Viewpoint	Moves the 3D image to the front and back to adjust the 3D perspective view.	
Picture Mode	Selects one of the preset image or customizes options in each mode for the best TV screen performance. You are also able to customize advanced options of each mode. The available preset picture modes vary depending on the TV.	
	Mode	
	Vivid	Adjusts the video image for the retail environment by enhancing the contrast, brightness, Colour, and sharpness.
	Standard	Adjusts the image for the normal environment.
	Cinema	Optimizes the video image for a cinematic look to enjoy movies as if you are in a movie theater.
	Sport	Optimizes the video image for high and dynamic actions by emphasizing primary Colours such as white, grass, or sky blue.
	Game	Optimizes the video image for a fast gaming screen such as PCs or games.

NOTE

- The Image View Mode option is disabled when 2D images are converted into 3D.
- The 3D Depth option is enabled when 2D images are converted into 3D.
- You cannot enter the Main menu while watching 3D files.

CAUTION

- Some menus may not work while viewing 3D imaging.
- The 3D imaging is disabled automatically when switching input source.
- The screen may not be displayed properly if you view 2D images in 3D imaging mode.
- 3D effect can be seen when 3D Mode is selected appropriately for the 3D input signal supplied to the TV.
- When switching channels, the conversion from 2D to 3D is maintained. If you stay on a channel with no images for 3 seconds, it changes back to 2D.
- When viewing multiple photos stored on the USB device, the conversion from 2D to 3D is maintained.
- When viewing multiple video files stored on the USB device, the 3D mode is also maintained.
- When watching a 3D movie from the USB device, Picture Mode is not supported.

CUSTOMIZING SETTINGS

Accessing main menus

- 1 Press **MENU** to access the main menus.
- 2 Press the Navigation buttons to scroll to one of the following menus and press **OK**.
- 3 Press the Navigation buttons to scroll to the setting or option you want and press **OK**.
- 4 When you are finished, press **EXIT**.
When you return to the previous menu, press **BACK**.

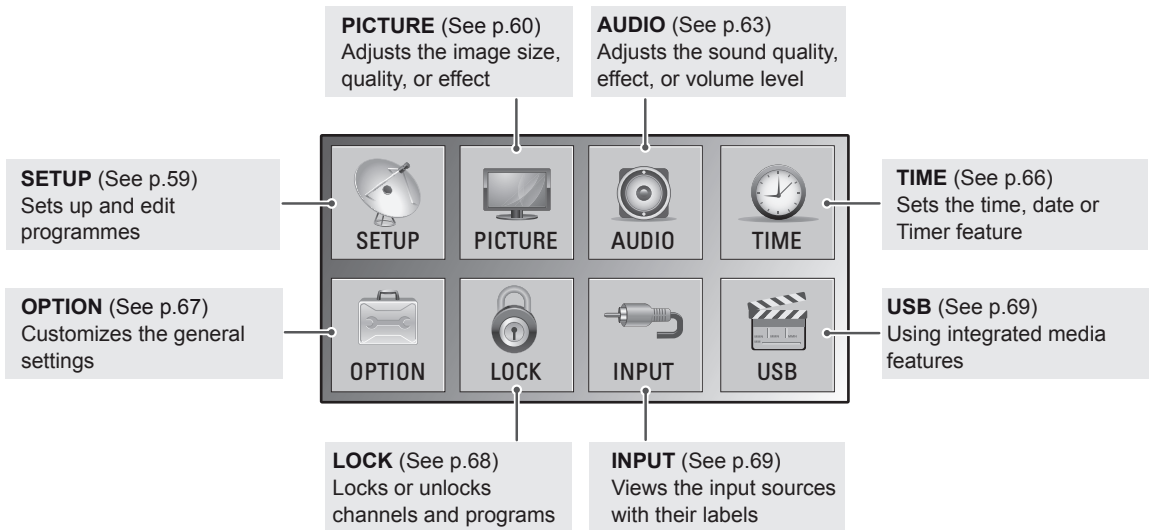
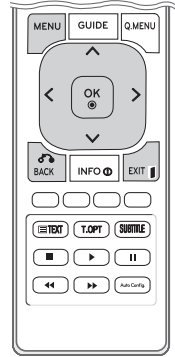

! NOTE

- Image shown may differ from you TV.
- Your TV's OSD(On Screen Display) may differ slightly from that shown in this manual.
- The available menus and options may differ from the input source or product model that you are using.

Customizing settings

SETUP settings

- Image shown may differ from your TV.

- 1 Press **MENU** to access the main menus.
- 2 Press the Navigation buttons to scroll to **SETUP** and press **OK**.
- 3 Press the Navigation buttons to scroll to the setting or option you want and press **OK**.
 - To return to the previous level, press **BACK**.
- 4 When you are finished, press **EXIT**.
When you return to the previous menu, press **BACK**.

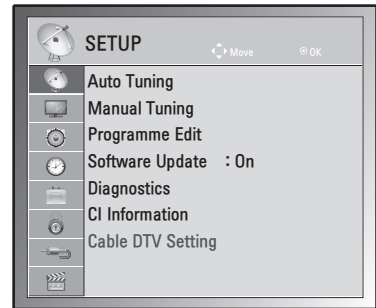

The available Programme settings are described in the following:

Setting	Description
Auto Tuning	Tunes and stores all available programmes through antennas or cable inputs (See p.18).
Manual Tuning	Tunes and stores the programmes you want manually (See p.21 to 22).
Programme Edit	Adds or deletes programmes on the programme (See p.23).
Software Update	This automatically updates your TV's software. (See p.25).
Diagnostics	This shows you the manufacturer, model or type number, serial number and software information. (See p.26).
CI information	Enables you to watch some encrypted services (pay services) (See p.26).
Cable DTV Setting (In Cable Mode Only)	You can run the service operator or the programme auto update. (Only in countries where DBV-C is supported). (See p.23).

PICTURE settings

- 1 Press **MENU** to access the main menus.
- 2 Press the Navigation buttons to scroll to **PICTURE** and press **OK**.
- 3 Press the Navigation buttons to scroll to the setting or option you want and press **OK**.
 - To return to the previous level, press **BACK**.
- 4 When you are finished, press **EXIT**.
When you return to the previous menu, press **BACK**.

• Image shown may differ from your TV.

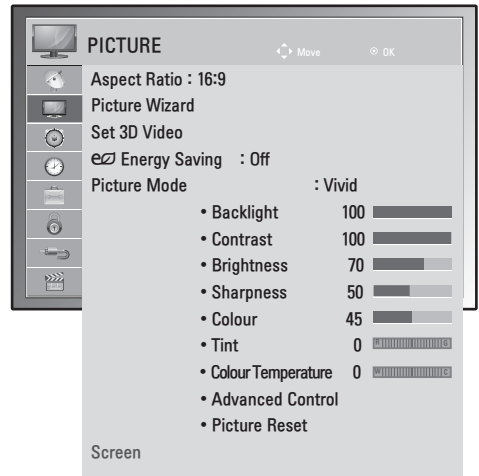

The available picture settings are described in the following:

Setting	Description
Aspect Ratio	Changes the image size to view images at its optimal size. (See p.28)
Picture Wizard	<p>Adjusts the image quality and calibrates the screen by following the on-screen instructions. The customized options will be saved as Expert1 in the picture modes.</p> <pre> graph LR PW[Picture Wizard] --> BL[Black Level] BL --> WL[White Level] WL --> CO[Colour] CO --> TI[Tint] TI --> HVS[Horizontal/Vertical Sharpness] HVS --> CT[Colour Temperature] CT --> DC[Dynamic Contrast] DC --> CG[Colour Gain] CG --> BLIGHT[Backlight] BLIGHT --> COMP[Complete] </pre> <p>NOTE If you use Picture wizard, the Energy saving feature will turn off automatically.</p>
Set 3D Video (Only 3D model)	Sets the 3D imaging option. (See p.53)
Energy Saving	Sets to automatically adjust the screen brightness corresponding to the surroundings.
	Option
	Off The backlight is off.
	Minimum/ Medium/ Maximum Selects the brightness level of the backlight.
	Screen off The screen turns off in 3 seconds.

Setting	Description	
Picture Mode	Selects one of the preset image or customizes options in each mode for the best TV screen performance. You are also able to customize advanced options of each mode. The available preset picture modes vary depending on the TV .	
	Mode	
	Vivid	Adjusts the video image for the retail environment by enhancing the contrast, brightness, Colour, and sharpness.
	Standard	Adjusts the image for the normal environment.
	Cinema	Optimizes the video image for a cinematic look to enjoy movies as if you are in a movie theater.
	Sport	Optimizes the video image for high and dynamic actions by emphasizing primary Colours such as white, grass, or sky blue.
	Game	Optimizes the video image for a fast gaming screen such as PCs or games.
	Expert1/2	Adjusts the detailed video image settings for video experts as well as general viewers.
Screen (In RGB-PC Mode Only)	Customizes the PC display options in RGB mode.	
	Option	
	Resolution	Selects a proper resolution. See "Customizing PC display options", p.41
	Auto Configure	Sets to adjust the screen position, clock, and phase automatically. The displayed image may be unstable for a few seconds while the configuration is in progress.
	Position/Size/Phase	Adjusts the options when the picture is not clear, especially when characters are shaky, after the auto configuration.
	Reset	Restores the options to the default setting.

Basic image options

Setting	Description
Backlight	Adjusts the brightness of the screen by controlling the LCD backlight. If you decrease the brightness level, the screen becomes darker and the power consumption will be reduced without any video signal loss.
Contrast	Increases or decreases the gradient of the video signal. You may use Contrast when the bright part of the picture is saturated.
Brightness	Adjusts the base level of the signal in the picture. You may use Brightness when the dark part of the picture is saturated.
Sharpness	Adjusts the level of crispness in the edges between the light and dark areas of the picture. The lower the level, the softer the image.
Colour	Adjusts intensity of all Colours.
Tint	Adjusts the balance between red and green levels.
Colour Temperature	Set to warm to enhance hotter colours such as red, or set to cool to make picture bluish.
Advanced Control	Customizes the advanced options.
Reset	Restores the options to the default setting.

NOTE

- You cannot adjust **Colour** and **Tint** in the RGB-PC / HDMI-PC mode.
- When the Expert 1/2 is selected, you can select **Backlight, Contrast, Brightness, H Sharpness, V Sharpness, Colour** or **Tint** .

Advanced image options

Setting	Description
Dynamic Contrast (Off/Low/High)	Adjusts the contrast to keep it at the best level according to the brightness of the screen. The picture is improved by making bright parts brighter and dark parts darker.
Dynamic Colour (Off/Low/High)	Adjusts screen colours so that they look livelier, richer and clearer. This feature enhances hue, saturation and luminance so that red, blue, green and white look more vivid.
Noise Reduction (Off/Low/Medium/High)	Reduces screen noise without compromising video quality.
Gamma (Low/Medium/High)	You can adjust brightness of dark area and middle gray level area of the picture. <ul style="list-style-type: none"> » Low: Make dark and middle gray level area of the picture brighter. » Medium: Express original picture levels. » High: Make dark and middle gray level area of the picture darker.
Black Level (Low/High/Auto)	<ul style="list-style-type: none"> » Low: The picture of the screen gets darker. » High: The picture of the screen gets brighter. » Auto: Realizing the black level of the screen and set it to High or Low automatically. Set black level of the screen to proper level. This function enables to select 'Low' or 'High' in the following mode: AV(NTSC-M), HDMI or Component. Otherwise, 'Black level' is set to 'Auto'.
Film Mode (On/Off)	You can watch a cinema-like video by eliminating judder effect. Use this function when you watch movies.
Colour Standard (SD/HD)	Converts the colour of a different video to HD colour. This function is set for SD video (BT-601) and HD video (BT-709) colour format.
Expert Pattern (Off/Expert 1/Expert 2)	This is the pattern necessary for expert adjustment. This function is enabled in "Picture Mode - Expert" when you watch DTV.
Colour Filter (Off/Red/Green/Blue)	This is the function to filter the specific colours of the video. You can use the RGB filter to set colour saturation and hue accurately.
Colour Temperature (Medium/Warm/Cool)	This is the function to adjust the overall colour of the screen to the feeling you want. <ul style="list-style-type: none"> • A <ul style="list-style-type: none"> » Method: 2 Points » Pattern: Inner, Outer » Red/Green/Blue Contrast, Red/Green/Blue Brightness : » The adjustment range is -50 to +50. • B <ul style="list-style-type: none"> » Method: 10 point IRE » Pattern: Inner / Outer » IRE (Institute of Radio Engineers) is the unit to display the size of the video signal and can be set among 10, 20, 30 to 100. You can adjust Red, Green or Blue according to each setting. » Red/Green/Blue: The adjustment range is -50 to +50.
Colour Management System	As the tool used by the experts to make adjustments by using the test patterns, this does not affect other colours but can be used to selectively adjust the 6 colour areas (Red/Green/Blue/ Cyan/ Magenta/Yellow). Colour difference may not be distinctive even when you make the adjustments for the general video. Adjusts Red/Green/Blue/Yellow/Cyan/Magenta. <ul style="list-style-type: none"> » Red/Green/Blue/Yellow/Cyan/Magenta Colour: The adjustment range is -30 to +30. » Red/Green/Blue/Yellow/Cyan/Magenta Tint: The adjustment range is -30 to +30. This feature is disable in RGB-PC and HDMI (PC) mode.

AUDIO settings

- 1 Press **MENU** to access the main menus.
- 2 Press the Navigation buttons to scroll to **AUDIO** and press **OK**.
- 3 Press the Navigation buttons to scroll to the setting or option you want and press **OK**.
- To return to the previous level, press **BACK**.
- 4 When you are finished, press **EXIT**.
When you return to the previous menu, press **BACK**.

- Image shown may differ from your TV.

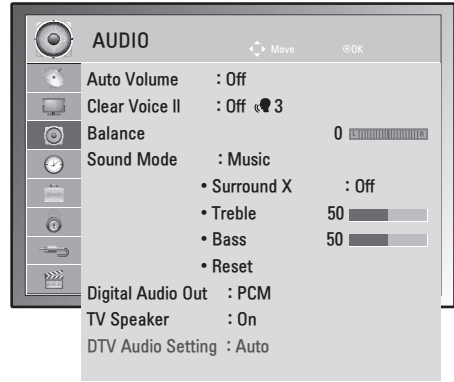

The available audio options are described in the following:

Setting	Description
Auto Volume	Activates the Auto Volume feature to keep the volume level consistent whenever you change programmes. The volume level may not be consistent due to different signal conditions of broadcasting stations.
Clear Voice II	By differentiating the human sound range from others, it helps users listen to human voices better.
Balance	Adjusts balance between the left and right speakers according to your room environment.
Sound Mode	Selects one of the preset sound modes or customize each option in each mode.
Mode	
Standard	Select when you want standard-quality sound.
Music	Select when you listen to music.
Cinema	Select when you watch movies.
Sport	Select when you watch sports events.
Game	Select when you play games.
<div style="border: 1px solid black; padding: 5px;"> <p>NOTE</p> <p>If sound quality or volume is not at the level you want, it is recommended to use a separate home theater system or amplifier to cope with different user environments.</p> </div>	
Option	
Surround X	Provides an enveloping surround sound with clear dialog and bass using just two speakers. Surround X is a patented Surround technology that solves the problem of playing 5.1 multichannel contents over two speakers.
Treble	Controls the dominant sounds in the output. When you turn up the treble, it will increase the output to the higher frequency range.
Bass	Controls the softer sounds in the output. When you turn up the bass, it will increase the output to the lower frequency range.
Reset	Resets the sound mode to the default setting.

Setting	Description		
Digital Audio Out	<p>This function allows you to select your preferred Digital Audio Output. When Dolby Digital is available, selecting Auto in the Digital Audio Out menu will set SPDIF(Sony Philips Digital InterFace) output to Dolby Digital. If Auto is selected in the digital audio out menu when Dolby Digital is not available, SPDIF output will be PCM(Pulse-code modulation). Even if both Dolby Digital and Audio language have been set in a channel which broadcast Dolby Digital Audio, only Dolby Digital will be played.</p>		
	Mode	Audio Input	Digital Audio output
	Auto (Speaker On)	MPEG Dolby Digital Dolby Digital Plus HE-AAC	PCM Dolby Digital Dolby Digital PCM
	Auto (Speaker Off)	MPEG Dolby Digital Dolby Digital Plus HE-AAC	PCM Dolby Digital Dolby Digital Dolby Digital
	PCM	PCM	PCM
TV Speaker	Turns on the internal speaker of the TV when using an external Hi-Fi or SRS system. You can use the TV speaker as an audio output device even if there is no video input.		
DTV Audio Setting (In Digital Mode Only)	<p>When different audio types exist in an input signal, this function allows you to select the audio type you want.</p> <div style="border: 1px solid black; padding: 10px; margin-top: 10px;"> <p>NOTE</p> <ul style="list-style-type: none"> • Auto: Automatically outputs in the order HE - AAC ▶ Dolby Digital ▶ MPEG. • HE - AAC, Dolby Digital, MPEG: Allows users to select the audio type they want. <ul style="list-style-type: none"> » If MPEG is selected, MPEG is always outputted. » If MPEG is not supported, HE - AAC and Dolby Digital are selected in that order. </div>		

Stereo/Dual Reception (In Analogue Mode Only)

When a programme is selected, the sound information for the station appears with the programme number and station name.

- 1 Press **Q. MENU** and press the Navigation to access the **AUDIO** and press **OK**.
- 2 Press the Navigation button to scroll to sound output and press **OK**.

Broadcast	On Screen Display
Mono	MONO
Stereo	STEREO
Dual	DUAL I , DUAL II , DUAL I + II

Mono sound selection

If the stereo signal is weak in stereo reception, you can switch to mono. In mono reception, the clarity of sound is improved.

Language selection for dual language broadcast

a programme can be received in two languages (dual language), you can switch to DUAL I, DUAL II or DUAL I + II.

- DUAL I** Sends the primary broadcast language to the loudspeakers.
DUAL II Sends the secondary broadcast language to the loudspeakers.
DUAL I+II Sends a separate language to each loudspeaker.

Stereo/Dual Reception (In Analogue Mode Only)

If the TV is equipped with a receiver for NICAM reception, high quality NICAM (Near Instantaneous Companding Audio Multiplex) digital sound can be received.

Sound output can be selected according to the type of broadcast received.

- 1 When **NICAM mono** is received, you can select **NICAM MONO** or **MONO**.
- 2 When **NICAM stereo** is received, you can select **NICAM STEREO** or **MONO**.
If the stereo signal is weak, switch to **MONO**.
- 3 When **NICAM dual** is received, you can select **NICAM DUAL I**, **NICAM DUAL II** or **NICAM DUAL I+II** or **MONO**.

Speaker Sound Output Selection

In AV, Component, RGB and HDMI mode, you can select output sound for the left and right loudspeakers. Select the sound output.

L+R: Audio signal from audio L input is sent to the left loudspeaker and audio signal from audio R input is sent to the right loudspeaker.

L+L: Audio signal from audio L input is sent to left and right loudspeakers.

R+R: Audio signal from audio R input is sent to left and right loudspeakers.

TIME settings

- Image shown may differ from your TV.

- 1 Press **MENU** to access the main menus.
- 2 Press the Navigation buttons to scroll to **TIME** and press **OK**.
- 3 Press the Navigation buttons to scroll to the setting or option you want and press **OK**.
 - To return to the previous level, press **BACK**.
- 4 When you are finished, press **EXIT**.
 - When you return to the previous menu, press **BACK**.



The available time settings are described in the following:

Setting	Description
Clock	<p>Sets the time, date, time zone, and daylight-saving time feature. The time will be set automatically according to a digital channel signal which includes time information provided by the broadcasting station. If not, set the time and date manually.</p> <p>NOTE</p> <p>If you turn the power off by disconnecting the power cord, the current time setting will be reset.</p>
Off Time/On Time	<p>Sets the time to turn on or off the TV automatically. To use this function, you should set the current time and date in the Clock menu.</p> <p>NOTE</p> <ul style="list-style-type: none"> • If you do not press any button within 2 hours after the TV turns on by the On Time feature, the TV enters the Standby mode automatically. • If you set the On Time feature and turn the TV off by pressing Main power switch, the On Time feature will not work. To activate the On Time feature, the TV set must be in Standby mode. • If you set both Off Time and On Time features to the same time, the Off Time function overrides the On Time feature, when the TV is on.
Sleep Timer	<p>Sets the length of time until the TV to turns off. When you turn the TV off and turn it on again, the Sleep Timer will be set to off.</p>
Automatic Standby	<p>If you do not press any button when Automatic Standby function is on, the TV automatically switches to the standby mode.</p> <p>NOTE</p> <ul style="list-style-type: none"> • This function does not work on Store Demo mode or while Software update. • This function does not work on RGB-PC/HDMI-PC mode.

OPTION settings

- Image shown may differ from your TV.

- 1 Press **MENU** to access the main menus.
- 2 Press the Navigation buttons to scroll to **OPTION** and press **OK**.
- 3 Press the Navigation buttons to scroll to the setting or option you want and press **OK**.
- To return to the previous level, press **BACK**.
- 4 When you are finished, press **EXIT**.
When you return to the previous menu, press **BACK**.

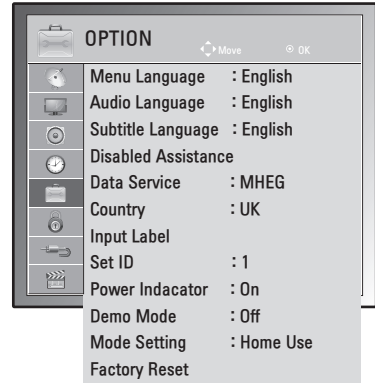

The available option settings are described in the following:

Setting	Description			
Language	Selects a language for the display or audio(Only DTV) (See p.32).			
Disabled Assistance (In Digital Mode)	Audio commentary or subtitles are provided for those who are hard of hearing or visually impaired			
	Option			
	Hard of Hearing This function if for the hearing impaired. If it is set to on, the subtitle is displayed by default.			
	Audio Description This function is for the blind, and provides explanatory audio describing the current situation in a TV programme in addition to the basic audio. When Audio Description On is selected, basic audio and Audio Description are provided only for those programmes that have Audio Description included.			
Volume	Changes the Audio Description volume			
Data Service (only in Ireland.)	This function allow users to choose between MHEG (Digital Teletext) and Teletext if both exist at the same time.(See p.75 to 77)			
Country	Selects a desired country.(See p.31)			
Input Label	Selects a label for an input source to identify a device connected to each input source.			
	<div style="border: 1px solid black; padding: 5px;"> <p>NOTE If you want to use HDMI-PC mode, you must set the input label to PC mode.</p> </div>			
Set ID	Adds an ID to the connected devices.(See p.89)			
Power Indicator	Sets to turn on or off the Power indicator on the TV.			
Demo Mode	Display the slide show to explain the various logo of this TV.			
Mode Setting	Customizes the TV settings to suit your preference. The initial setup screen will appear when you turn on the TV for the first time.			
	<table border="0"> <tr> <td colspan="2">Setting</td> </tr> <tr> <td>Mode Setting</td> <td>Selects Home Use mode for the home environment. Selects Store Demo mode for the retail environment.</td> </tr> </table>	Setting		Mode Setting
Setting				
Mode Setting	Selects Home Use mode for the home environment. Selects Store Demo mode for the retail environment.			
Factory Reset	This function initializes all settings.			
	<div style="border: 1px solid black; padding: 5px;"> <p>NOTE In Lock System "On", if you forget your password, press '0', '3', '2', '5' on the remote control handset.</p> </div>			

LOCK settings

- 1 Press **MENU** to access the main menus.
- 2 Press the Navigation buttons to scroll to **LOCK** and press **OK**.
- 3 Press the Navigation buttons to scroll to the setting or option you want and press **OK**.
 - To return to the previous level, press **BACK**.
- 4 When you are finished, press **EXIT**.
When you return to the previous menu, press **BACK**.

- Image shown may differ from your TV.

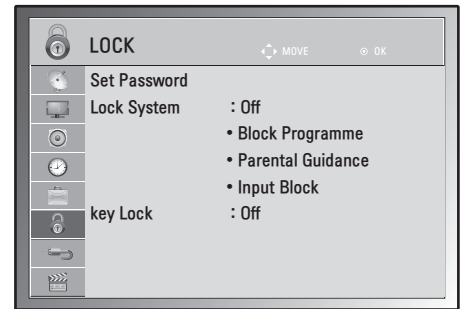

The available lock settings are described in the following:

Setting	Description								
Set Password	<p>Changes the 4-digit password. The default password is '0', '0', '0', '0'. When France is selected for Country, the default password is not '0', '0', '0', '0' but '1', '2', '3', '4'.</p> <div style="border: 1px solid black; padding: 5px; margin-top: 10px;"> <p>NOTE</p> <p>If you forget the password, press '0' '3' '2' '5' and set the new password.</p> </div>								
Lock System	<p>Activates or deactivates the lock system</p> <table border="1" style="width: 100%; border-collapse: collapse;"> <thead> <tr> <th colspan="2">Rating</th> </tr> </thead> <tbody> <tr> <td style="width: 25%;">Block Programme</td> <td>Blocks any programmes that you do not want to watch or that you do not want your children to watch. <ul style="list-style-type: none"> • This function is available in Lock System "On". • Enter a password to watch a blocked programme. </td> </tr> <tr> <td>Parental Guidance</td> <td>This function operates according to information from the broadcasting station. Therefore if the signal has incorrect information, this function does not operate. (See p.34)</td> </tr> <tr> <td>Input Block</td> <td>Blocks the input sources</td> </tr> </tbody> </table>	Rating		Block Programme	Blocks any programmes that you do not want to watch or that you do not want your children to watch. <ul style="list-style-type: none"> • This function is available in Lock System "On". • Enter a password to watch a blocked programme. 	Parental Guidance	This function operates according to information from the broadcasting station. Therefore if the signal has incorrect information, this function does not operate. (See p.34)	Input Block	Blocks the input sources
Rating									
Block Programme	Blocks any programmes that you do not want to watch or that you do not want your children to watch. <ul style="list-style-type: none"> • This function is available in Lock System "On". • Enter a password to watch a blocked programme. 								
Parental Guidance	This function operates according to information from the broadcasting station. Therefore if the signal has incorrect information, this function does not operate. (See p.34)								
Input Block	Blocks the input sources								
Key Lock	<p>The TV can be set so that the remote control is required to control it. This feature can be used to prevent unauthorized viewing.</p> <div style="border: 1px solid black; padding: 5px; margin-top: 10px;"> <p>NOTE</p> <ul style="list-style-type: none"> • In Key Lock "On", if the TV is turned off, press the INPUT, P ^ V button on the TV or POWER, INPUT, P ^ V, TV/PC or NUMBER buttons on the remote control then the set will be turned on. • With the Key Lock On, the display ' Key Lock On ' appears on the screen if any button on the front panel is pressed while viewing the TV. </div>								

INPUT settings

- Image shown may differ from your TV.

- 1 Press **MENU** to access the main menus.
- 2 Press the Navigation buttons to scroll to **INPUT** and press **OK**.
- 3 Press the Navigation buttons to scroll to the setting or option you want and press **OK**.
 - To return to the previous level, press **BACK**.
- 4 When you are finished, press **EXIT**.
 - When you return to the previous menu, press **BACK**.

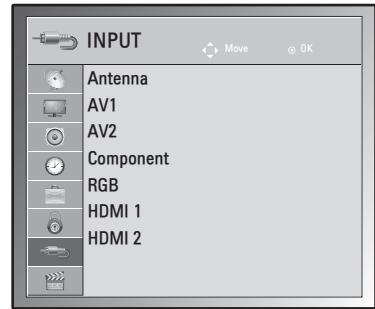

The available input settings are described in the following:

Setting	Description
Antenna	Select it when watching the DTV/TV.(See p.16).
AV1/2	Select it when watching the VCR or external equipment.(See p.73).
Component	Select it when using the DVD or the Digital set-top box depends on connector.(See p.72).
RGB	Select it when using PC depends on connector.(See p.39).
HDMI1/2	Select it when using DVD, PC or Digital set-top box depend on connector.(See p.38 or 72).

USB settings

- Image shown may differ from your TV.

- 1 Press **MENU** to access the main menus.
- 2 Press the Navigation buttons to scroll to **USB** and press **OK**.
- 3 Press the Navigation buttons to scroll to the setting or option you want and press **OK**.
 - To return to the previous level, press **BACK**.
- 4 When you are finished, press **EXIT**.
 - When you return to the previous menu, press **BACK**.



The available usb settings are described in the following:

Setting	Description
Photo List	You can view photo files on USB storage device. (See p.46)
Music List	You can play music files on USB storage device. (See p.47)
Movie List	You can play movie files on a USB storage device. (See p.49)
Divx Reg. Code	Check and register the DivX registration code of your TV so that you can rent or purchase the latest movies at www.divx.com/vod .(See p.52).
Deactivation	The purpose of deactivation is to allow deactivation of devices for users who have activated all the available devices through the web server and are blocked from activating more devices.(See p.52)

MAKING CONNECTIONS

Connect various external devices to the TV and switch input modes to select an external device. For more information about an external device's connection, refer to the manual supplied with each device.

Available external devices are: HD receivers, DVD players, VCRs, audio systems, USB storage devices, PC, camcorders or cameras, gaming devices, and other external devices.



NOTE

- If you record a TV program on a DVD recorder or VCR, make sure to connect the TV signal input cable to the TV through a DVD recorder or VCR. For more information about recording, refer to the manual supplied with the connected device.
- The external device connection may differ from the model.

Connect external devices to the TV by referring to the following table.

Connection overview

Connection type	Video		Audio	
	Digital	Analog	Digital	Analog
HDMI (highly recommended)	○	-	○	-
Component	-	○	-	-
Composite	-	○	-	-
RGB	-	○	-	-
Optical audio	-	-	○	-
Analog audio	-	-	-	○

Connect various external devices to the ports on the TV's back panel.

- 1 Find an external device you want to connect to your TV shown on the following illustration.
- 2 Check the connection type of the external device.
- 3 Go to the appropriate illustration and check the connection details.

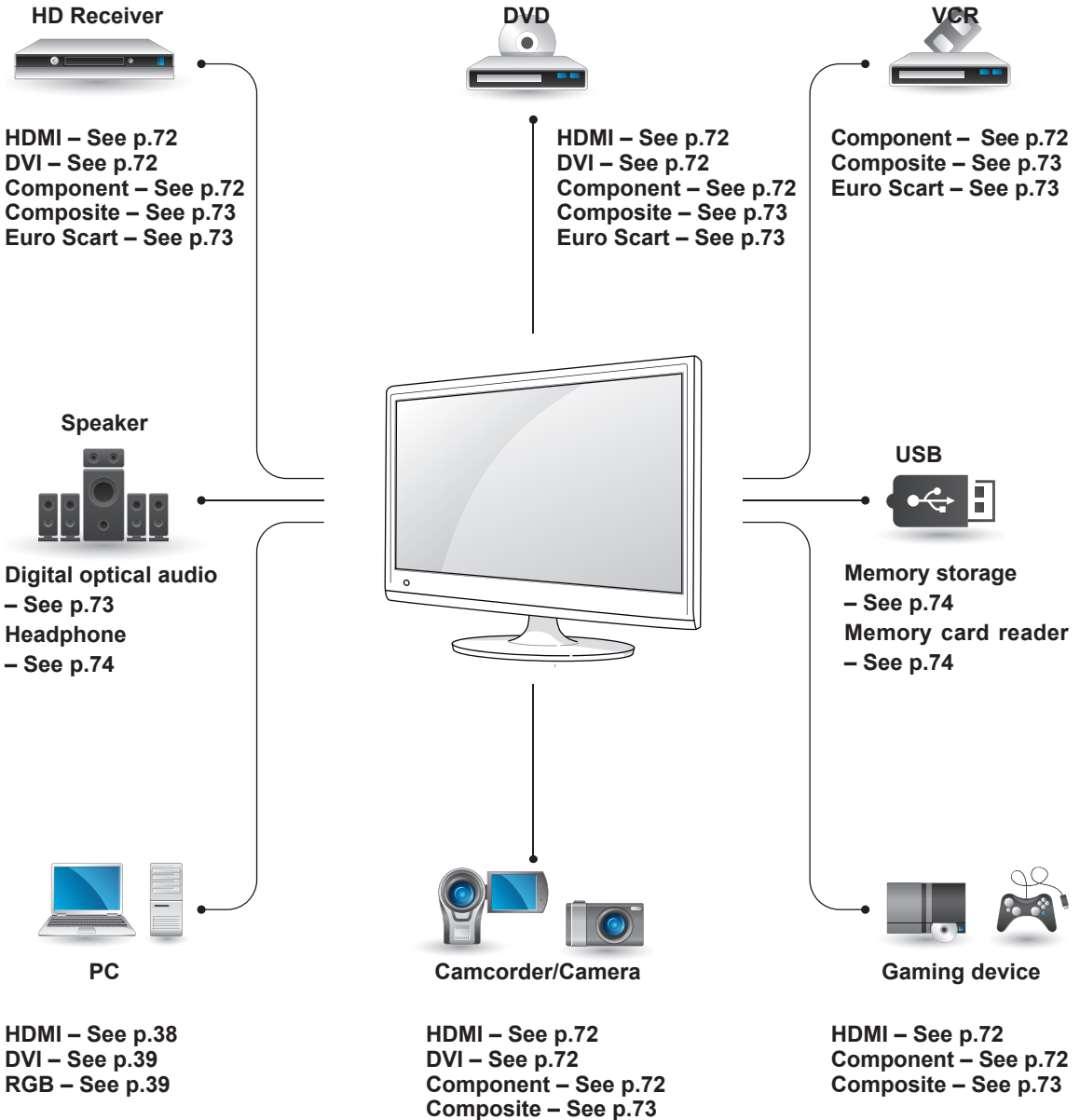

NOTE

If you connect a gaming device to the TV, use the cable supplied with the gaming device.

Connecting to a Camcorder, Camera, HD receiver, DVD, VCR player or Gaming device

Connect a Camcorder, Camera, HD receiver, DVD, VCR player or Gaming device to the TV and select an appropriate input mode.

HDMI connection

Transmits the digital video and audio signals from an external device to the TV. Connect the external device and the TV with the HDMI cable as shown on the following illustration.

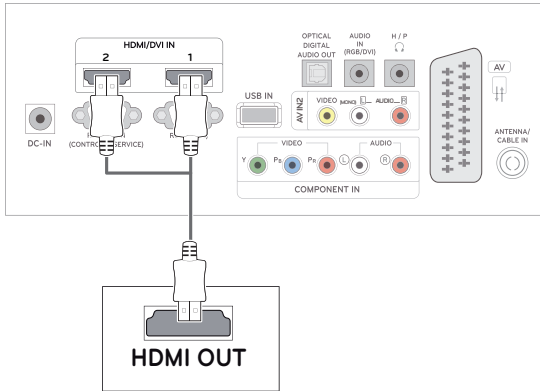

NOTE

- Use a High Speed HDMI™ Cable.
- High Speed HDMI™ Cables are tested to carry an HD signal up to 1080p and higher.

DVI to HDMI connection

Transmits the digital video signal from an external device to the TV. Connect the external device and the TV with the DVI-HDMI cable as shown in the following illustration. To transmit an audio signal, connect an optional audio cable.

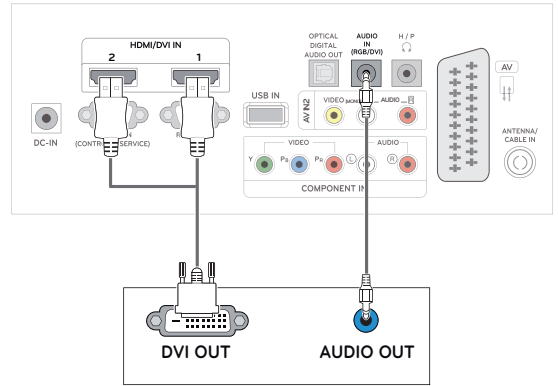

Component connection

Transmits the analog video and audio signals from an external device to the TV. Connect the external device and the TV with the component cable as shown on the following illustration. To display images by using progressive scan, make sure to use the component cable.

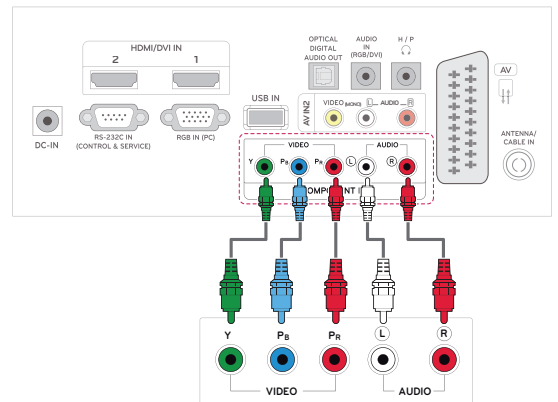

Composite connection

Transmits the analog video and audio signals from an external device to the TV. Connect the external device and the TV with the composite cable as shown on the following illustration.

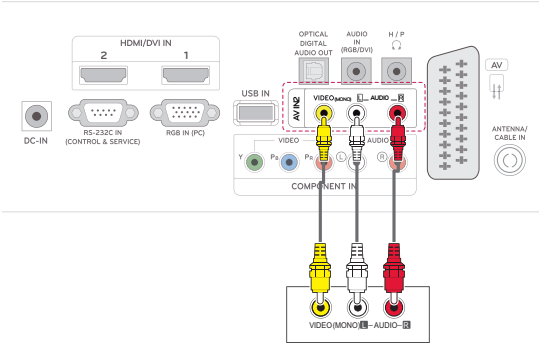

Connecting to an audio system

Use an optional external audio system instead of the built-in speaker.

! NOTE

- If you use an external audio device instead of the built-in speaker, set the TV speaker feature to off (See p.63).

Digital optical audio connection

Transmits the digital audio signal from the TV to an external device. Connect the external device and the TV with the optical audio cable as shown on the following illustration

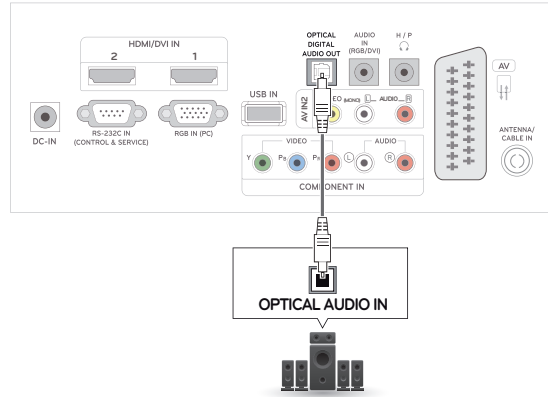

Euro Scart connection

Transmits the video and audio signals from an external device to the TV. Connect the external device and the TV with the Euro Scart cable as shown on the following illustration. To display images by using progressive scan, make sure to use the Euro Scart cable.

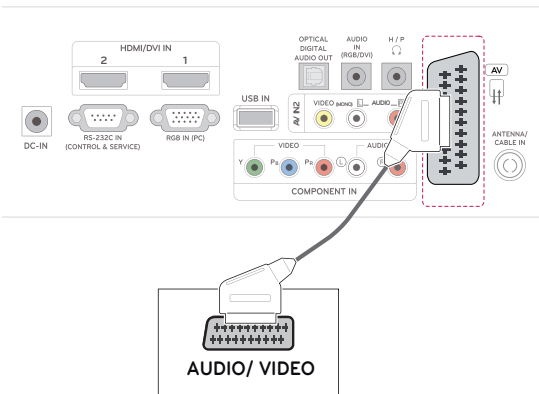

Headphone connection

Transmits the headphone signal from the TV to an external device. Connect the external device and the TV with the headphone as shown on the following illustration.

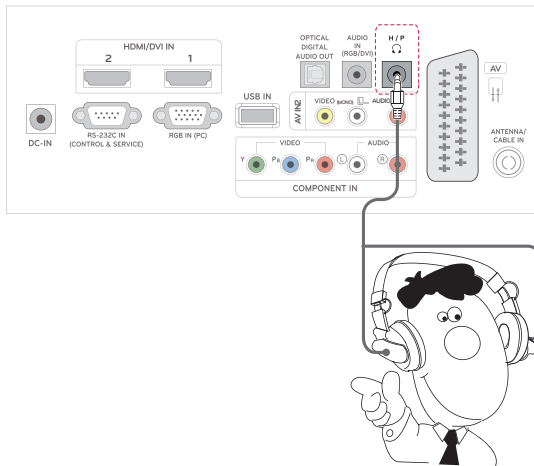

Connecting to a USB

Connect a USB storage device such as a USB flash memory, external hard drive, MP3 player or a USB memory card reader to the TV and access the USB menu to use various multimedia files. **"Connecting USB storage devices"** on See p.43 and **"Browsing files"** on See p.45

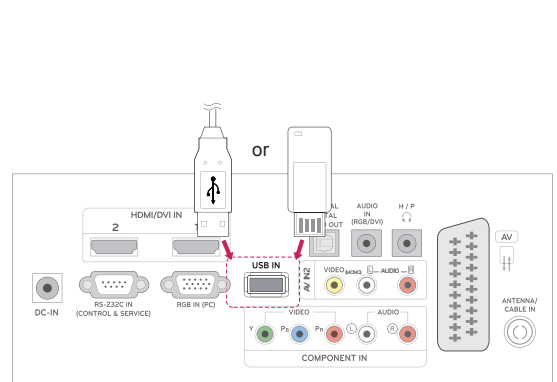

TELETEXT

- This feature is not available in all countries.

Teletext is a free service broadcast by most **TV** stations which gives up-to-the-minute information on news, weather, television programmes, share prices and many other topics. The teletext decoder of this **TV** can support the **SIMPLE**, **TOP** and **FASTTEXT** systems. **SIMPLE** (standard teletext) consists of a number of pages which are selected by directly entering the corresponding page number. **TOP** and **FASTTEXT** are more modern methods allowing quick and easy selection of teletext information.

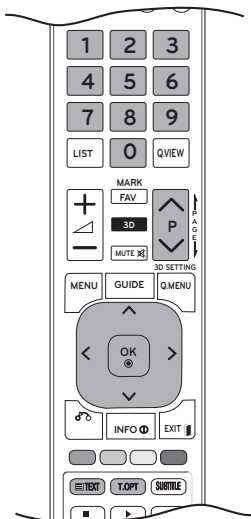

Switch On/Off

Press the **TEXT** button to switch to teletext. The initial page or last page appears on the screen. Two page numbers, **TV** station name, date and time are displayed on the screen headline. The first page number indicates your selection, while the second shows the current page displayed. Press the **TEXT** or **EXIT** button to switch off teletext. The previous mode reappears.

Simple Text

Page selection

- 1 Enter the desired page number as a three-digit number with the **Number** buttons. If during selection you press a wrong number, you must complete the three-digit number and then re-enter the correct page number.
- 2 The **P** \wedge or \vee button can be used to select the previous or next page.

Top Text

The user guide displays four fields—red, green, yellow and blue at the bottom of the screen. The yellow field denotes the next group and the blue field indicates the next block.

Block / Group / Page Selection

- 1 With the **Blue** button you can progress from block to block.
- 2 Use the **Yellow** button to proceed to the next group with automatic overflow to the next block.
- 3 With the **Green** button you can proceed to the next existing page with automatic overflow to the next group. Alternatively, the **P** \wedge button can be used.
- 4 The Red button permits you to return to previous selection. Alternatively, the **P** \wedge button can be used.



Direct Page Selection

As with **SIMPLE** teletext mode, you can select a page by entering it as a three digit number using the **Number** buttons in **TOP** mode.

Fastext

The teletext pages are colour coded along the bottom of the screen and are selected by pressing the corresponding coloured button.

Page selection

- 1 Press the **T.OPT** button and then use the Navigation button to select  menu. Display the index page.
- 2 You can select the pages which are colour coded along the bottom line with corresponding coloured buttons.
- 3 AS with SIMPLE teletext mode, you can select a page by entering its three digit page number with the **NUMBER** buttons in Fastext mode.
- 4 The **P**  or  button can be used to select the preceding or following page.

Special Teletext Function

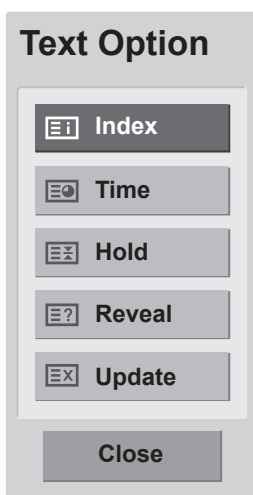

Index

Select the each index page.

Time

When viewing a TV programme, select this menu to display the time at the top right hand corner of the screen.

In the teletext mode, press this button to select a sub page number. The sub page number is displayed at the bottom of the screen. To hold or change the sub page, press the **Red** buttons / **Green** buttons, < > or **Number** buttons.

Hold

Stops the automatic page change which will occur if a teletext page consists of 2 or more sub pages.

The number of sub pages and the sub page displayed is, usually, shown on the screen below the time. When this menu is selected the stop symbol is displayed at the top left-hand corner of the screen and the automatic page change is inactive.

Reveal

Select this menu to display concealed information, such as solutions to riddles or puzzles.

Update

Displays the TV picture on the screen while waiting for a new teletext page. The display will appear at the top left hand corner of the screen. When the updated page is available then display will change to the page number. Select this menu again to view the updated teletext page.

DIGITAL TELETEXT (ONLY DTV)

- This function works in UK, Ireland only.

The TV gives you access to digital teletext which is greatly improved in various aspects such as text, graphics etc. This digital teletext can access special digital teletext services and specific services which broadcast digital teletext. You should select off in the subtitle language menu to display teletext by pressing the SUBTITLE button.

Teletext within digital service



- 1 Press the numeric or **P** \wedge or \vee button to select a digital service which broadcasts digital teletext.
- 2 Follow the indications on digital teletext and move onto the next step by pressing **TEXT**, **OK**, **Navigation button**, **Red button**, **Green button**, **Yellow button**, **Blue button** or **Number buttons** and etc.
- 3 To change digital teletext service, select a different service by the numeric or **P** \wedge or \vee button.

Teletext in digital service

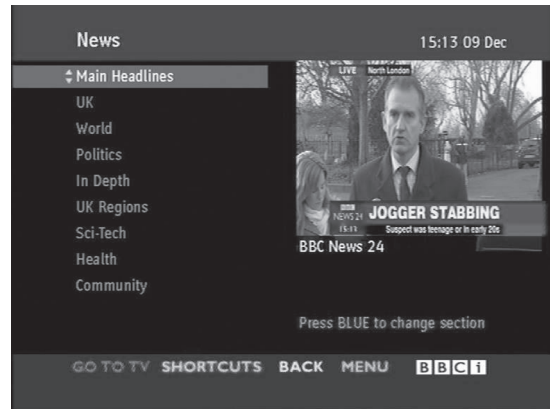

- 1 Press the numeric or **P** \wedge or \vee button to select a certain service which broadcasts digital teletext.
- 2 Press the **TEXT** or coloured button to switch on teletext.
- 3 Follow the indications on digital teletext and move onto the next step by pressing **OK**, **Navigation button**, **Red button**, **Green button**, **Yellow button**, **Blue button** or **Number buttons** and so on.
- 4 Press the **TEXT** or colour button to switch off digital teletext and return to **TV** viewing.

Some services may allow you to access text services by pressing the **Red** button.

MAINTENANCE

Clean your TV regularly to keep the best performance and to extend the product lifespan.



CAUTION

- Make sure to turn the power off and disconnect the power cord and all other cables first.
- When the TV is left unattended and unused for a long time, disconnect the power cord from the wall outlet to prevent possible damage from lightning or power surges.

Screen and frame

To remove dust, wipe the surface with a dry and soft cloth.

To remove major dirt, wipe the surface with a soft cloth dampened in clean water or a diluted mild detergent. Then wipe immediately with a clean and dry cloth.



CAUTION

- Do not push, rub, or hit the surface with your fingernail or a sharp object, as this may result in scratches on the screen and image distortions.
- Do not use any chemicals, such as waxes, benzene, alcohol, thinners, insecticides, air fresheners, lubricants, as these may damage the screen's finish and cause discolorations.

Cabinet and stand

To remove dust, wipe the cabinet with a dry and soft cloth.

To remove major dirt, wipe the cabinet with a soft cloth dampened in a clean water or water containing a small amount of mild detergent.



CAUTION

- Do not spray liquid onto the surface. If water enters the TV, it may result in fire, electric shock, or malfunction.
- Do not use any chemicals as this may deteriorate the surface.

Power cord

Remove the accumulated dust or dirt on the power cord regularly.

TROUBLESHOOTING

General

The operation does not work normally.

Problem	Resolution
The remote control doesn't work	<ul style="list-style-type: none"> • Check to see if there is any object between the product and the remote control causing obstruction. Ensure you are pointing the remote control • Ensure that the batteries are installed with correct polarity (+ to +, - to -). • Ensure that the correct remote operating mode is set: TV, VCR, etc. • Install new batteries.
Power is suddenly turned off	<ul style="list-style-type: none"> • Is the sleep timer set? • Check the power control settings. Power interrupted. • If the TV is switched on and there is no input signal, it will switch off automatically after 15 minutes to save the power consumption. • When a broken file was played in the USB mode, the TV may turn off. Please check the file in your usb storage. • Except the screen off mode of the energy saving menu.

The video function does not work.

Problem	Resolution
No picture & No sound	<ul style="list-style-type: none"> • Check whether the product is turned on. • Try another channel. The problem may be with the broadcast. • Is the power cord inserted into wall power outlet? • Check your antenna direction and/or location. • Test the wall power outlet, plug another product's power cord into the outlet where the product's power cord was plugged in.
Picture appears slowly after switching on	<ul style="list-style-type: none"> • This is normal, the image is muted during the product startup process. Please contact your service centre, if the picture has not appeared after five minutes.
No Colour, poor colour, or poor picture	<ul style="list-style-type: none"> • Adjust Colour in menu option. • Keep a sufficient distance between the product and the VCR. • Try another channel. The problem may be with the broadcast. • Are the video cables installed properly? • Activate any function to restore the brightness of the picture.
Horizontal / vertical bars or picture shaking	<ul style="list-style-type: none"> • Check for local interference such as an electrical appliance or power tool.
Poor reception on some channels	<ul style="list-style-type: none"> • Station or cable product experiencing problems, tune to another station. • Station signal is weak, reorient antenna to receive weaker station. • Check for sources of possible interference.
Lines or streaks in pictures	<ul style="list-style-type: none"> • Check antenna (Change the direction of the antenna).

Problem	Resolution
No picture when connecting HDMI	<ul style="list-style-type: none"> Check that your HDMI cable is High Speed HDMI Cable. If the HDMI cables are not High Speed HDMI Cable, flickering or no screen display can result. Please use the High Speed HDMI Cable.

The audio function does not work.

Problem	Resolution
Picture OK & No sound	<ul style="list-style-type: none"> Press the  (+, -) button or VOL (◀, ▶) button. Sound muted? Press MUTE button. Try another channel. The problem may be with the broadcast. Are the audio cables installed properly?
No output from one of the speakers	<ul style="list-style-type: none"> Adjust Balance in menu option.
Unusual sound from inside the product	<ul style="list-style-type: none"> A change in ambient humidity or temperature may result in an unusual noise when the product is turned on or off and does not indicate a problem with the product.
No sound when connecting HDMI or USB	<ul style="list-style-type: none"> Check HDMI cable is High Speed HDMI Cable. Check USB cable over version 2.0. If the sound is abnormal in the HDMI, check the audio format in your external equipments. <ul style="list-style-type: none"> » Audio Supported format : Dolby Digital, PCM

There is a problem with PICTURE settings.

Problem	Resolution
When the user changes the picture settings, the TV automatically converts back to the initial settings after a certain period of time.	<ul style="list-style-type: none"> It means that the TV is currently set to Store Demo mode. To switch to Home use mode you should do the followings: From the TV Menu, choose OPTION → Choose Mode Setting → Choose Home use. Now, you have completed switching to the Home use mode.

PC mode

No image is displayed.

Problem	Resolution
Power is on, power indicator is blue but the screen appears extremely dark.	<ul style="list-style-type: none"> Adjust brightness and contrast again.
Does the 'Invalid format' message appear?	<ul style="list-style-type: none"> The signal from the PC (Video card) is out of the vertical or horizontal frequency range of the product. Adjust the frequency range by referring to the Specifications in this user's guide.
Does the 'Check signal cable' message appear?	<ul style="list-style-type: none"> The signal cable between PC and product is not connected. Check the signal cable. Press the 'INPUT' button in the remote control to check the input signal.

'Unknown Product' message appears when the product is connected.

Problem	Resolution
Did you install the driver?	<ul style="list-style-type: none"> • Install the product driver, which is provided with the product, or download it from the web site. (http://www.lg.com) • See if the plug & play function is supported by referring to the video card user's guide.

After-image appears on the product.

Problem	Resolution
After-image appears when the product is turned off.	<ul style="list-style-type: none"> • If you use a fixed image for a long time, the pixels may be damaged quickly. Use the screen saver function.

Screen Colour is abnormal.

Problem	Resolution
Screen has poor Colour resolution (16_Colours).	<ul style="list-style-type: none"> • Set screen Colour resolution to more than 24 bits (true Colour) Select control Pane → Display → Settings → Colour Table menu in Windows.
Screen Colour is unstable or mono Colour.	<ul style="list-style-type: none"> • Check the connection status of the signal cable.
Do back spots appear on the screen?	<ul style="list-style-type: none"> • Several pixels (red, green, white or black Colour) may appear on the screen, which can be attributable to the unique characteristics of the LCD panel. It is not a malfunction of the LCD.

The screen image looks abnormal.

Problem	Resolution
Is the screen position wrong?	<ul style="list-style-type: none"> • Adjust the Position menu in OSD. From the TV Menu, Choose PICTURE → Choose Screen → Adjusts Position. • A See if the video card resolution and frequency are supported by the product. If the frequency is out of range, set to the recommended resolution in the Control Panel → Display → Setting menu.
Do thin lines appear on the background screen?	<ul style="list-style-type: none"> • Adjust the Size menu in OSD. From the TV Menu, Choose PICTURE → Choose Screen → Adjusts Size.
Horizontal noise appears or the characters look blurred.	<ul style="list-style-type: none"> • Adjust the Phase menu in OSD. From the TV Menu, Choose PICTURE → Choose Screen → Adjusts Phase.

TROUBLESHOOTING WHEN USING 3D MODE

I can see a swirling oil-like pattern on the TV when the TV is turned off.

This is caused by the interference of external light in the air layer between the LCD surface and 3D filter. The pattern becomes almost invisible when you turn on the power again.

I cannot see 3D image properly

Problem	Resolution
If you are not using the glasses provided with the TV.	When you view 3D images with this TV, it is very important that you use the glasses provided with the TV. The glasses are designed to compensate optically for the 3D filter attached to the surface of the TV. If you wear third-party glasses, you may not see 3D images properly on the TV.
If you view 3D images outside the optimal viewing angle or distance.	The optimal viewing angle of this TV is between 14° degrees; the optimal viewing distance is between 50 cm to 90 cm from the TV. When you view 3D images outside the optimal viewing angle or viewing distance, the images may look overlapped or not be displayed properly in 3D.

Notes for Viewing 3D Image with 3D Digital Brodcating

***In Analogue Brodcating, 3D Imaging does not work.**

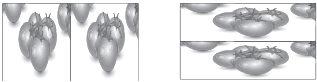
Problem	Resolution
When switching the 2D image display to the 3D image display with the 3D button on the remote control, the overlapped image may be displayed.	<ul style="list-style-type: none"> • Disable the 3D imaging mode with the 3D button. • The 3D imaging mode is disabled automatically if you change the channel.
If the screen is divided into left/right or top/bottom when you change the channel 	This channel supports the 3D imaging mode. Select the 3D imaging type displayed on the screen by pressing the 3D button on the remote control.
If your eyes are sore or the screen looks blurry while viewing 3D images.	Select Left/Right or Right/Left option, which you find better for viewing 3D images.

SPECIFICATIONS

LCD Panel	Screen Type	685.8 mm Wide (27 inch) TFT (Thin Film Transistor) LCD (Liquid Crystal Display) Panel Visible diagonal size: 685.8 mm
	Pixel Pitch	0.3114 mm (H) x 0.3114 mm (V)
Video Signal	Max. Resolution	1920 × 1080 @ 60 Hz
	Recommended Resolution	1920 × 1080 @ 60 Hz
	Horizontal Frequency	30 kHz to 83 kHz
	Vertical Frequency	56 Hz to 75 Hz
	Synchronization Type	Separate Sync, Digital
Input Connector		TV, D-Sub Analog, SCART, PC Audio In, Component, HDMI*2, CVBS
Power	Rated Voltage	19 V --- 3.0 A
	Power Consumption	On Mode : 47 W (typ.) Off Mode ≤ 0.5 W
AC/DC Adapter		Manufacturer: LITE-ON, Model PA-1650-68
Tilt	Tilt Range	-5° to 18°
Dimensions (Width x Height x Depth)		644 mm x 480.6 mm x 222.8 mm
Weight		6.0 kg
Environmental conditions	Operating Temperature	10 °C to 35 °C
	Operating Humidity	20 % to 80 %
	Storage Temperature	-10 °C to 60 °C
	Storage Humidity	5 % to 90 %

Product specifications shown above may be changed without prior notice due to upgrade of product functions.

RGB (PC) / HDMI (PC) supported mode

Resolution	Horizontal Frequency(kHz)	Vertical Frequency(Hz)
720 x 400	31.468	70.080
640 x 480	31.469	59.940
640 x 480	37.500	75.000
800 x 600	37.879	60.317
800 x 600	46.875	75.000
1024 x 768	48.363	60.000
1024 x 768	60.023	75.029
1152 x 864	67.500	75.000
1280 x 720	63.981	60.020
1280 x 800	49.702	59.810
1280 x 1024	63.981	60.020
1280 x 1024	79.976	75.025
1400 x 1050	65.317	59.978
1440 x 900	55.935	59.887
1600 x 900	60.000	60.000
1680 x 1050	64.674	59.883
1680 x 1050	65.290	59.954
1920 x 1080	67.500	60.000

HDMI (DTV) supported mode

Resolution	Horizontal Frequency(kHz)	Vertical Frequency(Hz)
720 x 480	31.469 31.500	59.940 60.000
720 x 576	31.250	50.000
1280 x 720	37.500	50.000
1280 x 720	44.960 45.000	59.940 60.000
1920 x 1080	33.720 33.750	59.940 60.000
1920 x 1080	28.125	50.000
1920 x 1080	27.000	24.000
1920 x 1080	33.750	30.000
1920 x 1080	56.250	50.000
1920 x 1080	67.430 67.500	59.940 60.000

Component supported mode

Resolution	Horizontal Frequency(kHz)	Vertical Frequency(Hz)
720 x 480	15.730	59.940
720 x 480	15.750	60.000
720 x 576	15.625	50.000
720 x 480	31.470	59.940
720 x 480	31.500	60.000
720 x 576	31.250	50.000
1280 x 720	44.960	59.940
1280 x 720	45.000	60.000
1280 x 720	37.500	50.000
1920 x 1080	33.720	59.940
1920 x 1080	33.750	60.000
1920 x 1080	28.125	50.000
1920 x 1080	56.250	50.000
1920 x 1080	67.432	59.940
1920 x 1080	67.500	60.000

Component port connecting informatio

Component ports on the TV	Y	P _B	P _R
Video output ports on DVD player	Y	P _B	P _R
	Y	B-Y	R-Y
	Y	Cb	Cr
	Y	Pb	Pr

! NOTE

- Avoid keeping a fixed image on the set's screen for prolonged periods of time. The fixed image may become permanently imprinted on the screen. Use a screen saver when possible.
- There may be interference relating to resolution, vertical pattern, contrast or brightness in PC mode. Change the PC mode to another resolution or change the refresh rate to another rate or adjust the brightness and contrast on the menu until the picture is clear. If the refresh rate of the PC graphic card can not be changed, change the PC graphic card or consult the manufacturer of the PC graphic card.
- The synchronization input waveform for Horizontal and Vertical frequencies are separate.
- Connect the signal cable from the TV output port of the PC to the RGB (PC) port of the TV or the signal cable from the HDMI output port of the PC to the HDMI/DVI IN port on the TV.
- Connect the audio cable from the PC to the Audio input on the TV. (Audio cables are not included with the TV).
- If using a sound card, adjust PC sound as required.
- If the graphic card on the PC does not output analogue and digital RGB simultaneously, connect only one of either RGB or HDMI/DVI IN to display the PC output on the TV.
- If the graphic card on the PC does output analogue and digital RGB simultaneously, TV the TV to either RGB or HDMI. (The other mode is set to Plug and Play automatically by the TV.)
- DOS mode may not work depending on the video card if you use an HDMI to DVI cable.
- If you use too long an RGB-PC cable that is too long, there may be interference on the screen. We recommend using under 5 m of cable. This provides the best picture quality.

3D video input format supported.

	Signal	Resolution	Horizontal Frequency (kHz)	Vertical Frequency (Hz)	Playable 3D video format
HDMI	720p	1280 x 720	45	60	Top & Bottom, Side by Side
			89.9 90	59.94 60	HDMI Frame Packing
			37.5	50	Top & Bottom, Side by Side
			75		HDMI Frame Packing
	1080i	1920 x 1080	33.75	60	Top & Bottom, Side by Side
			28.125	50	
	1080p	1920 x 1080	67.50	60	Top & Bottom, Side by Side, Checker Board, Single Frame Sequential
			56.250	50	Top & Bottom, Side by Side, Checker Board, Single Frame Sequential
			27	24	Top & Bottom, Side by Side, Checker Board
			53.95 54	23.98 24	HDMI Frame Packing
33.75			30	Top & Bottom, Side by Side, Checker Board	
USB	1080p	1920 x 1080	33.75	30	Top & Bottom, Side by Side, Checker Board
RGB	1080p	1920 x 1080	66.587	59.93	Top & Bottom, Side by Side
	Signal				Playable 3D video format
DTV	720p, 1080i				Top & Bottom, Side by Side

**NOTE**

- If HDMI input is received in HDMI 3D format, images are automatically converted into 3D.
- **2D → 3D** mode is available to watch for all signals.
- If you change **2D → 3D** mode, the left and right edges of the screen are clipped.
- If you select HDMI 3D, 3D mode is automatically enabled, which may cause the delay of screen turning on.
- For some 3D content files, if a 3D file is converted into 2D, the left and right edges of the screen may appear truncated.

IR CODES

- This feature is not available for all models.

Code (Hexa)	Function	Note
95	Energy Saving (e2)	R/C BUTTON
08	⏻ (POWER)	R/C BUTTON (POWER ON/OFF)
50	TV / PC	R/C BUTTON
0B	INPUT	R/C BUTTON
DC	3D	R/C BUTTON
F0	TV/RAD	R/C BUTTON
45	Q.MENU(3D SETTING)	R/C BUTTON
43	MENU	R/C BUTTON
AB	GUIDE	R/C BUTTON
40	Up (^)	R/C BUTTON
41	Down (v)	R/C BUTTON
07	Left (<)	R/C BUTTON
06	Right (>)	R/C BUTTON
44	OK(⊙)	R/C BUTTON
28	BACK(↶)	R/C BUTTON
5B	EXIT	R/C BUTTON
AA	INFO ⓘ	R/C BUTTON
02	⏪ (+)	R/C BUTTON
03	⏩ (-)	R/C BUTTON
1E	FAV (MARK)	R/C BUTTON
09	MUTE	R/C BUTTON
00	P (^)	R/C BUTTON
01	P (v)	R/C BUTTON
10 to 19	Number Key 0 to 9	R/C BUTTON
53	LIST	R/C BUTTON
1A	Q.VIEW	R/C BUTTON
72	Red Key	R/C BUTTON
71	Green Key	R/C BUTTON
63	Yellow Key	R/C BUTTON
61	Blue Key	R/C BUTTON
20	TEXT	R/C BUTTON
21	T.OPT (T.Option)	R/C BUTTON
39	SUBTITLE	R/C BUTTON
99	Auto Config.	R/C BUTTON
B1	■	R/C BUTTON
B0	▶	R/C BUTTON
BA		R/C BUTTON
8F	◀	R/C BUTTON
8E	▶▶	R/C BUTTON

EXTERNAL CONTROL DEVICE SETUP

RS-232C Setup

Connect the RS-232C (serial port) input jack to an external control device (such as a computer or an A/V control system) to control the product's functions externally.

Connect the serial port of the control device to the RS-232C jack on the product back panel.

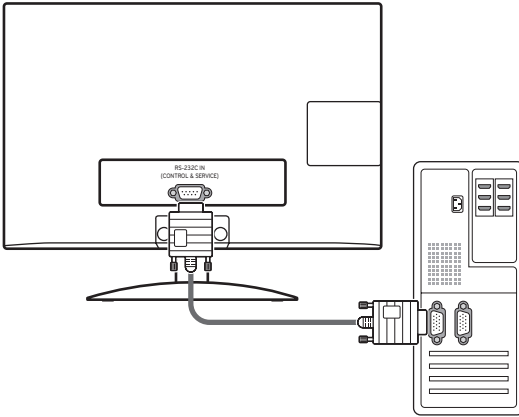

NOTE

RS-232C on this unit is intended to be used with third party RS-232C control hardware and software. The instructions below are provided to help with programming software or to test functionality using telenet software. RS-232C connection cables are not supplied with the product.

Type of connector; D-Sub 9-Pin Male

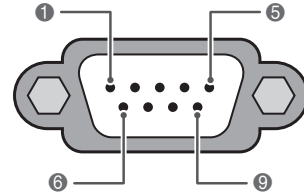

RS-232C IN
(CONTROL & SERVICE)

No.	Pin name
1	No connection
2	RXD (Receive data)
3	TXD (Transmit data)
4	DTR (DTE side ready)
5	GND
6	DSR (DCE side ready)
7	RTS (Ready to send)
8	CTS (Clear to send)
9	No Connection

RS-232C configurations

7-Wire Configuration

(Serial female-female NULL modem cable)

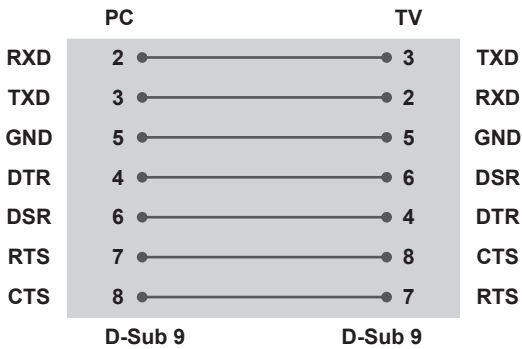

3-Wire Configurations(Not standard)

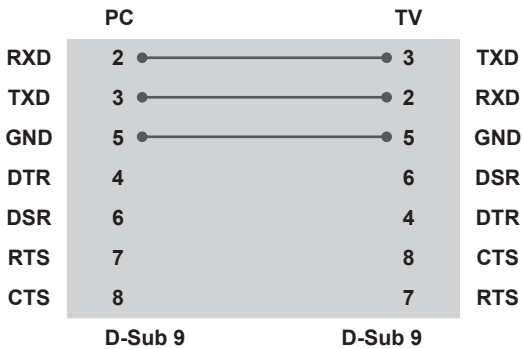

Set ID

Set ID number. "Real Data Mapping" on See p.95

- Image shown may differ from your TV.

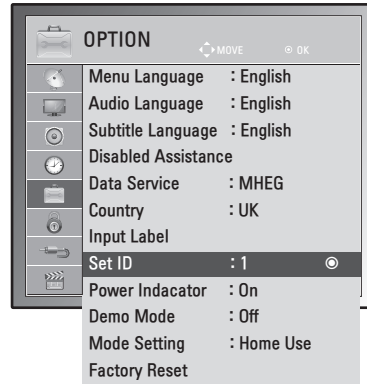

- 1 Press **MENU** to access the main menus.
- 2 Press the Navigation buttons to scroll to **OPTION** and press **OK**.
- 3 Press the Navigation buttons to scroll to **Set ID** and press **OK**.
- 4 Scroll left or right to select a set ID number and select **Close**. The adjustment range is 1-99.
- 5 When you are finished, press **EXIT**.
When you return to the previous menu, press **BACK**.

Communication Parameters

- Baud rate: 9600 bps (UART)
- Data length: 8 bits
- Parity : None
- Stop bit: 1 bit
- Communication code: ASCII code
- Use a crossed (reverse) cable.

Command reference list

	COMMAND1	COMMAND2	DATA (Hexadecimal)
01. Power	k	a	00 to 01
02. Aspect Ratio	x	c	See p.92
03. Screen Mute	k	d	00 to 01
04. Volume Mute	k	e	00 to 01
05. Volume Control	k	f	00 to 64
06. Contrast	k	g	00 to 64
07. Brightness	k	h	00 to 64
08. Colour	k	i	00 to 64
09. Tint	k	j	00 to 64
10. Sharpness	k	k	00 to 64
11. OSD Select	k	l	00 to 01
12. Remote control lock mode	k	m	00 to 01
13. Treble	k	r	00 to 64
14. Bass	k	s	00 to 64
15. Balance	k	t	00 to 64
16. Colour Temperature	x	u	00 to 64
17. Energy Saving	j	q	00 to 05
18. Auto Configuration	j	u	01
19. Tune Command	m	a	See p.94
20. Programme Add/Skip	m	b	00 to 01
21. Key	m	c	Key Code
22. Back Light	m	g	00 to 64
23. Input select (Main)	x	b	See p.95
24. 3D	x	t	See p.96
25. Extended 3D	x	v	See p.96

- Note : During USB operations such as Dvix or EMF, all commands except Power(ka) and Key(mc) are not executed and treated as NG.

Transmission / Receiving protocol

Transmission

[Command1][Command2][][Set ID][][Data][Cr]

[Command 1] : First command to control the TV.(j, k, m or x)

[Command 2] : Second command to control the TV.

[Set ID] : You can adjust the set ID to choose desired TV ID number in option menu. Adjustment range is 1 to 99. When selecting Set ID '0', every connected set is controlled. Set ID is indicated as decimal (1 to 99) on menu and as Hexa decimal (0x0 to 0x63) on transmission/receiving protocol.

* [DATA] : To transmit command data.

Transmit 'FF' data to read status of command.

* [Cr] : Carriage Return

ASCII code '0 x 0D'

* [] : ASCII code 'space (0 x 20)'

OK Acknowledgement

[Command2][][Set ID][][OK][Data][x]

The set transmits ACK (acknowledgement) based on this format when receiving normal data. At this time, if the data is data read mode, it indicates present status data. If the data is data write mode, it returns the data of the PC computer.

Error Acknowledgement

[Command2][][Set ID][][NG][Data][x]

* The set transmits ACK (acknowledgement) based on this format when receiving abnormal data from non-viable functions or communication errors. Data 00: Illegal Code

01. Power (Command: k a)

To control Power On/Off of the set.

Transmission
[k][a][][Set ID][][Data][Cr]

Data 00: Power Off Data 01: Power On

Acknowledgement
[a][][Set ID][][OK/NG][Data][x]

To show Power On/Off.

Transmission
[k][a][][Set ID][][FF][Cr]

Acknowledgement
[a][][Set ID][][OK/NG][Data][x]

*Similarly, if other functions transmit '0xFF' data based on this format, Acknowledgement data feed back presents status about each function.

*OK Ack., Error Ack. and other message may display on the screen when TV is power On.

02. Aspect Ratio (Command: k c) (Main Picture Size)

To adjust the screen format. (Main picture format)

You can also adjust the screen format using the Aspect Ratio in the Q.MENU. or PICTURE menu.

Transmission
[k][c][][Set ID][][Data][Cr]

Data 01 : Normal screen (4:3)
02 : Wide screen (16:9)
04 : Zoom
06 : Original
07 : 14:9
09 : Just Scan
0B : Full Wide
10 to 1F : Cinema Zoom 1 to 16

Acknowledgement
[c][][Set ID][][OK/NG][Data][x]

* Using the PC input, you select either 16:9 or 4:3 screen aspect ratio.

* In DTV/HDMI (1080i 50 Hz / 60 Hz, 720p 50 Hz / 60 Hz, 1080p 24 Hz / 30 Hz / 50 Hz / 60 Hz), Component(720p, 1080i, 1080p 50 Hz / 60 Hz) mode, Just Scan is available.

* Full Wide is supported only for Analogue, AV.

03. Screen Mute (Command: k d)

To select screen mute on/off.

Transmission
[k][d][][Set ID][][Data][Cr]

Data 00 : Screen mute off (Picture on)
Video mute off
01 : Screen mute on (Picture off)
10 : Video mute on

Acknowledgement
[d][][Set ID][][OK/NG][Data][x]

* In case of video mute on only, TV will display On Screen Display(OSD). But, in case of Screen mute on, TV will not display OSD.

04. Volume Mute (Command: k e)

To control volume mute on/off.

You can also adjust mute using the MUTE button on remote control.

Transmission
[k][e][][Set ID][][Data][Cr]

Data 00 : Volume mute on (Volume off)
01 : Volume mute off (Volume on)

Acknowledgement
[e][][Set ID][][OK/NG][Data][x]

05. Volume Control (Command: k f)

To adjust volume.

You can also adjust volume with the VOLUME buttons on remote control.

Transmission
[k][f][][Set ID][][Data][Cr]

Data Min : 00 to Max : 64

* Refer to 'Real data mapping'. See p.95

Acknowledgement
[f][][Set ID][][OK/NG][Data][x]

06. Contrast (Command: k g)

To adjust screen contrast.

You can also adjust contrast in the PICTURE menu.

Transmission
[k][g][][Set ID][][Data][Cr]

Data Min : 00 to Max : 64

* Refer to 'Real data mapping'. See p.95

Acknowledgement
[g][][Set ID][][OK/NG][Data][x]

07. Brightness (Command: k h)

To adjust screen brightness.
You can also adjust brightness in the PICTURE menu.

Transmission
[k][h][][Set ID][][Data][Cr]

Data Min : 00 to Max : 64

* Refer to 'Real data mapping '. See p.95

Acknowledgement
[h][][Set ID][][OK/NG][Data][x]

08. Colour (Command: k i)

To adjust the screen colour. (Except PC mode)
You can also adjust colour in the PICTURE menu.

Transmission
[k][i][][Set ID][][Data][Cr]

Data Min : 00 to Max : 64

* Refer to 'Real data mapping '. See p.95

Acknowledgement
[i][][Set ID][][OK/NG][Data][x]

09. Tint (Command: k j)

To adjust the screen tint. (Except PC mode)
You can also adjust tint in the PICTURE menu.

Transmission
[k][j][][Set ID][][Data][Cr]

Data Min : 00 to Max : 64

* Refer to 'Real data mapping '. See p.95

Acknowledgement
[j][][Set ID][][OK/NG][Data][x]

10. Sharpness (Command: k k)

To adjust the screen sharpness.
You can also adjust sharpness in the PICTURE menu.

Transmission
[k][k][][Set ID][][Data][Cr]

Data Min : 00 to Max : 64

* Refer to 'Real data mapping '. See p.95

Acknowledgement
[k][][Set ID][][OK/NG][Data][x]

11. OSD Select (Command: k l)

To select OSD (On Screen Display) on/off when controlling remotely.

Transmission
[k][l][][Set ID][][Data][Cr]

Data 00 : OSD off 01 : OSD on

Acknowledgement
[l][][Set ID][][OK/NG][Data][x]

12. Remote control lock mode (Command: k m)

To lock the front panel controls on the TV and remote control.

Transmission
[k][m][][Set ID][][Data][Cr]

Data 00 : Lock off 01 : Lock on

Acknowledgement
[m][][Set ID][][OK/NG][Data][x]

* If you are not using the remote control, use this mode. When main power is on/off, external control lock is released.

* Local Power Key will work properly.

13. Treble (Command: k r)

To adjust treble.
You can also adjust treble in the AUDIO menu.

Transmission
[k][r][][Set ID][][Data][Cr]

Data Min : 00 to Max : 64

* Refer to 'Real data mapping '. See p.95

Acknowledgement
[r][][Set ID][][OK/NG][Data][x]

14. Bass (Command: k s)

To adjust bass.
You can also adjust bass in the AUDIO menu.

Transmission
[k][s][][Set ID][][Data][Cr]

Data Min : 00 to Max : 64

* Refer to 'Real data mapping '. See p.95

Acknowledgement
[s][][Set ID][][OK/NG][Data][x]

15. Balance (Command: k t)

To adjust balance.
You can also adjust balance in the AUDIO menu.

Transmission
[k][t][][Set ID][][Data][Cr]

Data Min : 00 to Max : 64
* Refer to 'Real data mapping '. See p.95

Acknowledgement
[t][][Set ID][][OK/NG][Data][x]

16. Colour Temperature (Command: x u)

To adjust colour temperature. You can also adjust Colour.
Temperature in the PICTURE menu.

Transmission
[x][u][][Set ID][][Data][Cr]

Data Min : 00 to Max : 64
* Refer to 'Real data mapping '. See p.95

Acknowledgement
[u][][Set ID][][OK/NG][Data][x]

17. Energy Saving (Command: j q)

To reduce the power consumption of the TV. You can also adjust Energy Saving in OPTION menu.

Transmission
[j][q][][Set ID][][Data][Cr]

Power Saving Function					Level				Description
7	6	5	4		3	2	1	0	
0	0	0	0	Low Power	0	0	0	0	Off
0	0	0	0	Low Power	0	0	0	1	Minimum
0	0	0	0	Low Power	0	0	1	0	Medium
0	0	0	0	Low Power	0	0	1	1	Maximum
0	0	0	0	Low Power	0	1	0	1	Screen Off

Acknowledgement
[q][][Set ID][][OK/NG][Data][x]

18. Auto Configure(Command: j u)

To adjust picture position and minimize image shaking automatically. It works only in RGB (PC) mode.

Transmission
[j][u][][Set ID][][Data][Cr]

Data 01: To set

Acknowledgement
[u][][Set ID][][OK/NG][Data][x]

19. Tune Command (Command: m a)

Select channel to following physical number.

Transmission
[m][a][][Set ID][][Data0][][Data1][][Data2][Cr]

Data00 : High channel data
Data01 : Low channel data
ex. No. 47 -> 00 2F (2FH)
No. 394 -> 01 8A (18AH),
DTV No. 0 -> Don't care

Data02 : 0x00 : Analogue Main
0x10 : DTV Main
0x20 : Radio

Channel data range
Analogue - Min: 00 to Max: 63 (0 to 99)
Digital - Min: 00 to Max: 3E7 (0 to 999)
(Except For Sweden, Finland, Norway, Denmark, Ireland)
Digital - Min: 00 to Max: 270F (0 to 9999)
(Only Sweden, Finland, Norway, Denmark, Ireland)

Acknowledgement
[a][][Set ID][][OK/NG][Data][x]

Data Min: 00 to Max: 7DH

20. Programme Add/Skip (Command: m b)

To set skip status for the current Programme.

Transmission`[m][b][][Set ID][][Data][Cr]`

Data 00 : Skip 01 : Add

Acknowledgement`[b][][Set ID][][OK/NG][Data][x]`**Real data mapping**

00 : Step 0	Tint
:	Step 0 : R50
A : Step 10 (Set ID 10)	:
:	Step 49 : R1
F : Step 15 (Set ID 15)	Step 50 : 0
10 : Step 16 (Set ID 16)	Step 51 : G1
:	:
64 : Step 100	Step 100 : G50
:	
6E : Step 110	Balance
:	
73 : Step 115	Step 0 : L50
74 : Step 116	:
:	Step 49 : L1
CF : Step 199	Step 50 : 0
:	Step 51 : R1
FE : Step 254	:
FF : Step 255	Step 100 : R50
	Colour Temperature
	Step 0 : W50
	:
	Step 49 : W1
	Step 50 : 0
	Step 51 : C1
	:
	Step 100 : C50

21. Key (Command: m c)

To send IR remote key code.

Transmission`[m][c][][Set ID][][Data][Cr]`

Data Min : 00 to Max : 64

* Data Key cod -See p.87

Acknowledgement`[c][][Set ID][][OK/NG][Data][x]`**22. Back Light (Command: m g)**

To Control the back light.

Transmission`[m][g][][Set ID][][Data][Cr]`

Data : data Min: 00 to Max: 64

Acknowledgement`[g][][Set ID][][OK/NG][Data][x]`**23. Input select (Command: x b) (Main Picture Input)**

To select input source for main picture.

Transmission`[x][b][][Set ID][][Data][Cr]`

Data Structure

Data 00 : DTV	40: Component
10: Analogue	60: RGB
20: AV	90: HDMI

Acknowledgement`[b][][Set ID][][OK/NG][Data][x]`

24. 3D(Command: x t) (only 3D model)

To change 3D mode for TV.

Transmission
 [x][t][][Set ID][][Data01][][Data02][][Data03][][Data04][Cr]

Data01
 00 : 3D On
 01 : 3D Off
 02 : 3D to 2D
 03 : 2D to 3D

Data02
 00 : Top and Bottom
 01 : Side by Side
 02 : Check Board
 03 : Frame Sequential

Data03
 00 : Right to Left
 01 : Left to Right

Data04
 3D Depth : Min: 0 to Max: 14

- * Refer to 'Real data mapping '. See p.95
- *If data1 is 00(3D On), data4 has no meaning.
- *If data1 is 01(3D Off) or 02(3D to 2D), data2, data3 and data4 have no meaning.
- *If data1 is 03(2D to 3D), data2 and data3 have no meaning.

Data1	Data2	Data3	Data4
00	O	O	X
01	X	X	X
02	X	X	X
03	X	X	O

X : don't care

Acknowledgement
 [t][][OK][Data01][Data02][Data03][Data04][x]
 [t][][NG][Data01][x]

25. Extended 3D(Command: x v) (only 3D model)

To change 3D mode for TV.

Transmission
 [x][v][][Set ID][][Data01][][Data02][Cr]

Data01 : 3D option
 00 : 3D Picture Correction
 01 : 3D Depth (2D to 3D Only)
 02 : 3D Viewpoint

Data02 It has own range for each 3D option determined by Data01.

- 1) When Data01 is 00
 00 : Right to Left
 01 : Left to Right
- 2) When Data01 is 01
 Data Min: 0 to Max: 14
- 3) When Data01 is 02
 Data Min: 0 to Max: 14
 Data Min: 0 to Max: 06

* Refer to 'Real data mapping '. See p.95

Acknowledgement
 [v][][OK][Data01][Data02][x][v][][NG] [Data01][x]

When does switchover happen?

*Copeland switches on October 17, 2007



The exact date you switch depends on the transmitter you are served by. To check when you switch, go to Digital UK's postcode checker on www.digitaluk.co.uk

Check your ITV news service or look at Teletext page 106 to see what TV region you're in.

Visit us at digitaluk.co.uk call us on 0845 6 50 50 50†

†Calls charged at BT rate of 3p per minute daytime and 1p per minute evenings and weekends. Rates may vary for calls from non-BT lines.

Keep this important information about how to re-tune your TV during the digital TV switchover

Keep this leaflet and your instruction manual safe – you'll need them

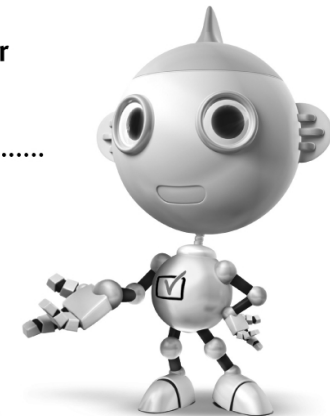

get set for digital 

Television in the UK is going digital, bringing us all more choice and new services. Starting in late 2007 and ending in 2012, television services in the UK will go completely digital, TV region by TV region.

Please see overleaf to find out when your area switches to digital.

Digital UK is the independent, non-profit organisation leading the process of digital TV switchover in the UK. Digital UK provides impartial information on what people need to do to prepare for the move to digital, and when they need to do it.

How the switchover affects your TV equipment:

Your new TV has a digital tuner built in, which means it is ready to receive the Freeview signal by simply plugging it into your aerial socket (check if you can get digital TV through your aerial now, or whether you'll have to wait until switchover, at www.digitaluk.co.uk).

When the TV switchover happens in your area, there are at least two occasions when you will need to re-tune your TV in order to continue receiving your existing TV channels, and also to pick up new ones. Digital UK, the body leading the digital TV switchover, will advise you when you need to re-tune during the switchover.

If you choose to connect your TV to satellite or cable with a digital box then it will not be affected by switchover, and you won't need to re-tune.

How to re-tune:

To find out how to re-tune your TV, check your manufacturer's instructions for details. Or see below for a typical sequence:

1. With your TV in digital TV mode, press 'Menu' on your remote control. (Some TVs will ask you for a code. If you have not already changed it, the default code is usually 0000, or check your instruction book.)
2. From the Menu options on screen, select 'SETUP'. Select 'Auto Tuning'* to re-tune your digital TV (not 'add channels'). You may have to wait a couple of minutes for the re-tune to complete.

*Also sometimes referred to as 'Update', 'Rescan', 'Replace', 'Auto-Tuning', 'Channel Search', 'First Time Install', or 'Store Channels'.

3. If you do not re-tune your channels when advised to do so by Digital UK, you may lose some or all of your channels until you do re-tune. You should re-tune your TV every few months to check for any new channels.

If you are missing any channels, it may be that they are not available in your area, or that your aerial needs upgrading.

If you have any questions, please contact your equipment supplier or call Digital UK on **0845 6 50 50 50** or visit www.digitaluk.co.uk



Make sure to read the Safety Precautions before using the product.

Keep the Owner's Manual (CD) in an accessible place for future reference.

The model and serial number of the TV is located on the back and one side of the TV.

Record it below should you ever need service.

MODEL _____

SERIAL _____