



LG

Life's Good

OWNER'S MANUAL

LED LCD TV / LCD TV

Please read this manual carefully before operating your set and retain it for future reference.

LCD TV MODELS

32LG710H 32LD650H 32LD655H 32LD660H 32LD665H
37LG710H 37LD650H 37LD655H 37LD660H 37LD665H
42LG710H 42LD650H 42LD655H 42LD660H 42LD665H
47LD650H
55LD650H

LED LCD TV MODELS

32LV555H
37LV555H
42LV555H
47LV555H
55LV555H

WARNING / CAUTION



WARNING
RISK OF ELECTRIC SHOCK
DO NOT OPEN



TO REDUCE THE RISK OF ELECTRIC SHOCK
DO NOT REMOVE COVER (OR BACK).
NO USER SERVICEABLE PARTS INSIDE.
REFER TO QUALIFIED SERVICE PERSONNEL.

 The lightning flash with arrowhead symbol, within an equilateral triangle, is intended to alert the user to the presence of uninsulated “dangerous voltage” within the product’s enclosure that may be of sufficient magnitude to constitute a risk of electric shock to persons.

 The exclamation point within an equilateral triangle is intended to alert the user to the presence of important operating and maintenance (servicing) instructions in the literature accompanying the appliance.

WARNING/CAUTION

TO REDUCE THE RISK OF FIRE AND ELECTRIC SHOCK, DO NOT EXPOSE THIS PRODUCT TO RAIN OR MOISTURE.

NOTE TO CABLE/TV INSTALLER

This reminder is provided to call the CATV system installer’s attention to Article 820-40 of the National Electric Code (U.S.A.). The code provides guidelines for proper grounding and, in particular, specifies that the cable ground shall be connected to the grounding system of the building, as close to the point of the cable entry as practical.

WARNING / CAUTION

To prevent fire or shock hazards, do not expose this product to rain or moisture.

FCC NOTICE

Class B digital device

This equipment has been tested and found to comply with the limits for a Class B digital device, pursuant to Part 15 of the FCC Rules. These limits are designed to provide reasonable protection against harmful interference in a residential installation. This equipment generates, uses and can radiate radio frequency energy and, if not installed and used in accordance with the instructions, may cause harmful interference to radio communications. However, there is no guarantee that interference will not occur in a particular installation. If this equipment does cause harmful interference to radio or television reception, which can be determined by turning the equipment off and on, the user is encouraged to try to correct the interference by one or more of the following measures:

- Reorient or relocate the receiving antenna.
- Increase the separation between the equipment and receiver.
- Connect the equipment to an outlet on a circuit different from that to which the receiver is connected.
- Consult the dealer or an experienced radio/TV technician for help.

This device complies with part 15 of the FCC Rules.

Operation is subject to the following two conditions: (1) This device may not cause (harmful) interference, and (2) This device must accept any interference received, including interference that may cause undesired operation (of the device).

Any changes or modifications in construction of this device which are not expressly approved by the party responsible for compliance could void the user’s authority to operate the equipment.

CAUTION

Do not attempt to modify this product in any way without written authorization from LG Electronics. Unauthorized modification could void the user’s authority to operate this product

SAFETY INSTRUCTIONS

IMPORTANT SAFETY INSTRUCTIONS

Read these instructions.
Keep these instructions.
Heed all warnings.
Follow all instructions.



1 Do not use this apparatus near water.

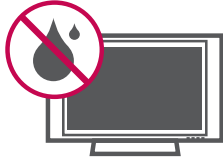

2 Clean only with a dry cloth.



3 Do not block any ventilation openings. Install in accordance with the manufacturer's instructions.



4 Do not install near any heat sources such as radiators, heat registers, stoves, or other apparatus (including amplifiers) that produce heat.



5 Do not defeat the safety purpose of the polarized or grounding-type plug. A polarized plug has two blades with one wider than the other. A grounding type plug has two blades and a third grounding prong. The wide blade or the third prong are provided for your safety. If the provided plug does not fit into your outlet, consult an electrician for replacement of the obsolete outlet.



6 Protect the power cord from being walked on or pinched particularly at plugs, convenience receptacles, and the point where they exit from the apparatus.



7 Only use attachments/accessories specified by the manufacturer.



8 Use only with the cart, stand, tripod, bracket, or table specified by the manufacturer, or sold with the apparatus. When a cart is used, use caution when moving the cart/apparatus combination to avoid injury from tip-over.



S3125A

9 Unplug this apparatus during lightning storms or when unused for long periods of time.

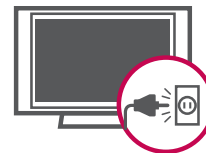

10 Refer all servicing to qualified service personnel. Servicing is required when the apparatus has been damaged in any way, such as power-supply cord or plug is damaged, liquid has been spilled or objects have fallen into the apparatus, the apparatus has been exposed to rain or moisture, does not operate normally, or has been dropped.

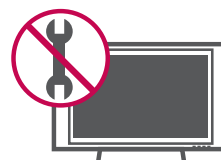

11 Never touch this apparatus or antenna during a thunder or lightning storm.

12 When mounting a TV on the wall, make sure not to install the TV by the hanging power and signal cables on the back of the TV.

13 Do not allow an impact shock or any objects to fall into the product, and do not drop onto the screen with something.

14 **CAUTION** concerning the Power Cord : It is recommend that appliances be placed upon a dedicated circuit; that is, a single outlet circuit which powers only that appliance and has no additional outlets or branch circuits. Check the specification page of this owner's manual to be certain.

Do not connect too many appliances to the same AC power outlet as this could result in fire or electric shock.

Do not overload wall outlets. Overloaded wall outlets, loose or damaged wall outlets, extension cords, frayed power cords, or damaged or cracked wire insulation are dangerous. Any of these conditions could result in electric shock or fire. Periodically examine the cord of your appliance, and if its appearance indicates damage or deterioration, unplug it, discontinue use of the appliance, and have the cord replaced with an exact replacement part by an authorized servicer. Protect the power cord from physical or mechanical abuse, such as being twisted, kinked, pinched, closed in a door, or walked upon. Pay particular attention to plugs, wall outlets, and the point where the cord exits the appliance.

Do not make the TV with the power cord plugged in. Do not use a damaged or loose power cord. Be sure do grasp the plug when unplugging the power cord. Do not pull on the power cord to unplug the TV.



15 **WARNING** - To reduce the risk of fire or electrical shock, do not expose this product to rain, moisture or other liquids. Do not touch the TV with wet hands. Do not install this product near flammable objects such as gasoline or candles or expose the TV to direct air conditioning.



16 As long as this unit is connected to the AC wall outlet, it is not disconnected from the AC power source even if you turn off this unit by SWITCH.

17 Do not expose to dripping or splashing and do not place objects filled with liquids, such as vases, cups, etc. on or over the apparatus (e.g. on shelves above the unit).



18 GROUNDING

Ensure that you connect the earth ground wire to prevent possible electric shock. (i.e. a TV with a three-prong grounded AC plug must be connected to a three-prong grounded AC outlet) If grounding methods are not possible, have a qualified electrician install a separate circuit breaker.

Do not try to ground the unit by connecting it to telephone wires, lightening rods, or gas pipes.

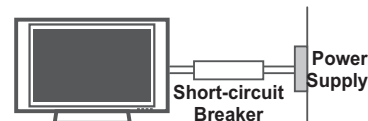

19 DISCONNECTING DEVICE FROM MAINS

Mains plug is the disconnecting device. The plug must remain readily operable.

20 Dot Defect

The Plasma or LCD panel is a high technology product with resolution of two million to six million pixels. In a very few cases, you could see fine dots on the screen while you're viewing the TV. Those dots are deactivated pixels and do not affect the performance and reliability of the TV.

21 Generated Sound

"Cracking" noise: A cracking noise that occurs when watching or turning off the TV is generated by plastic thermal contraction due to temperature and humidity. This noise is common for products where thermal deformation is required.

Electrical circuit humming/panel buzzing: A low level noise is generated from a high-speed switching circuit, which supplies a large amount of current to operate a product. It varies depending on the product.

This generated sound does not affect the performance and reliability of the product.

22 ANTENNAS

Outdoor antenna grounding

If an outdoor antenna is installed, follow the precautions below. An outdoor antenna system should not be located in the vicinity of overhead power lines or other electric light or power circuits, or where it can come in contact with such power lines or circuits as death or serious injury can occur.

Be sure the antenna system is grounded so as to provide some protection against voltage surges and built-up static charges.

Section 810 of the National Electrical Code (NEC) in the U.S.A. provides information with respect to proper grounding of the mast and supporting structure, grounding of the lead-in wire to an antenna discharge unit, size of grounding conductors, location of antenna discharge unit, connection to grounding electrodes and requirements for the grounding electrode.

Antenna grounding according to the National Electrical Code, ANSI/NFPA 70

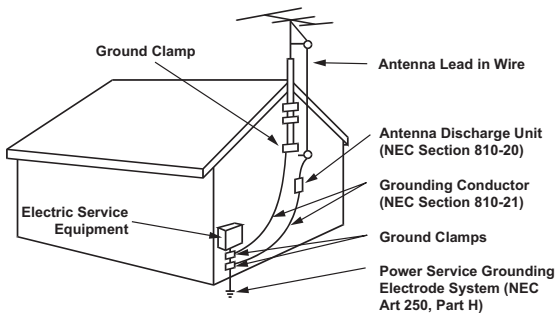

NEC: National Electrical Code

23 Cleaning

When cleaning, unplug the power cord and scrub gently with a soft cloth to prevent scratching. Do not spray water or other liquids directly on the TV as electric shock may occur. Do not clean with chemicals such as alcohol, thinners or benzene.

24 Moving

Make sure the product is turned off, unplugged and all cables have been removed. It may take 2 or more people to carry larger TVs. Do not press against or put stress on the front panel of the TV.

25 Ventilation

Install your TV where there is proper ventilation. Do not install in a confined space such as a bookcase. Do not cover the product with cloth or other materials (e.g.) plastic while plugged in. Do not install in excessively dusty places.

26 Take care not to touch the ventilation openings. When watching the TV for a long period, the ventilation openings may become hot.

27 If you smell smoke or other odors coming from the TV, unplug the power cord contact and authorized service center.

28 Do not press strongly upon the panel with a hand or sharp object such as nail, pencil or pen, or make a scratch on it.

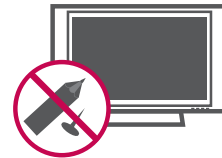

29 Keep the product away from direct sunlight.

30 For LCD TV

If the TV feels cold to the touch, there may be a small "flicker" when it is turned on. This is normal, there is nothing wrong with TV. Some minute dot defects may be visible on the screen, appearing as tiny red, green, or blue spots. However, they have no adverse effect on the monitor's performance.

Avoid touching the LCD screen or holding your finger(s) against it for long periods of time. Doing so may produce some temporary distortion effects on the screen.

ON DISPOSAL

(Only Hg lamp used LCD TV)

The fluorescent lamp used in this product contains a small amount of mercury. Do not dispose of this product with general household waste. Disposal of this product must be carried out in accordance to the regulations of your local authority.

CONTENTS

WARNING / CAUTION	2
SAFETY INSTRUCTIONS	3
FEATURES OF THIS TV	8

PREPARATION

Accessories	9
Front Panel Information	12
Back Panel Information	15
Stand Instructions	19
Cable Management	23
Desktop Pedestal Installation	26
Swivel Stand	26
Attaching the TV to a desk	27
VESA Wall Mounting	29
Securing the TV to the wall to prevent falling When the TV is used on a stand	31
Antenna or Cable Connection	32
MPI Card Slot / PPV Card Installation	33

EXTERNAL EQUIPMENT SETUP

HD Receiver Setup	34
DVD Setup	37
VCR Setup	39
Other A/V Source Setup	41
Audio Out Connection	42
PC Setup	43

WATCHING TV / CHANNEL CONTROL

Remote Control Functions	50
Turning On The TV	52
Channel Selection	53
Volume Adjustment	53
On-Screen Menus Selection	54
Channel Setup	
- Auto Scan (Auto Tuning)	55
- Add / Delete Channel (Manual Tuning) .	56
- Channel Editing	57
Channel Label	58
Input List	59
Example Electronic Program Guide	60

USB

Entry Modes	61
Photo List	64
Music List	68
Extra Contents	70

PICTURE CONTROL

PIP (Picture-In-Picture)	71
Picture Size (Aspect Ratio) Control.	73
Preset Picture Settings (Picture Mode).	75
Manual Picture Adjustment - User Mode	76
Picture Improvement Technology	77
Picture Reset	79
Demo mode.	80

SOUND & LANGUAGE CONTROL

Auto Volume Leveler (Auto Volume)	81
Preset Sound Settings (Sound Mode).	82
Sound Setting Adjustment - User Mode	83
- SRS TruSurround XT.	84
- Infinite Sound	84
Clear Voice II.	86
Balance	87
TV Speakers On/Off Setup.	88
Audio Reset	89
Stereo/SAP Broadcast Setup	90
Audio Language	91
On-Screen Menus Language Selection	92
Caption Mode	
- Analog Broadcasting System Captions . .	93
- Digital Broadcasting System Captions . .	94
- Caption Option	95

TIME SETTING

Clock Setting	
- Auto Clock Setup	96
- Manual Clock Setup	97
Auto On/Off Time Setting	98
Sleep Timer Setting	99
Auto Shut-Off Setting.	100

PARENTAL CONTROL / RATINGS

Set Password & Lock System	102
Channel Blocking	105
Movie & TV Rating.	106
Downloadable Rating.	111
External Input Blocking	112

APPENDIX

Troubleshooting.	113
Maintenance	115
Product Specifications.	116
Programming the Remote Control.	120
IR Codes	123
Open Source License	125

FEATURES OF THIS TV

■ This feature is not available for all models.



High-definition television. High-resolution digital television broadcast and playback system composed of roughly a million or more pixels, 16:9 aspect-ratio screens, and AC3 digital audio. A subset of digital television, HDTV formats include 1080i and 720p resolutions.



Unlike other sensors which can only sense brightness of ambient light, LG's "Intelligent Sensor" uses 4,096 sensing steps to evaluate its surroundings. Using a sophisticated algorithm, the LG processes picture quality elements including brightness, contrast, color, sharpness and white balance. The result is a picture optimized for its surroundings, more pleasing to watch and which can also save up to 50% in power consumption.



LG TV include a unique invisible speaker system, tuned by renowned audio expert, Mr. Mark Levinson. Speakers are embedded in strategic spots behind the front cabinet and use minute vibrations to turn the entire front bezel into the speaker system. The result is a clean, polished look, and enhanced audio by increasing the "sweet spot", giving a wider and richer sound field.



View videos and photos and listen to music on your TV through USB 2.0 ('videos' dependent on model).



Manufactured under license from Dolby Laboratories. "Dolby" and the double-D symbol are trademarks of Dolby Laboratories.



SRS is a trademark of SRS Labs, Inc. TruSurround XT technology is incorporated under license from SRS Labs, Inc.



Automatically enhances and amplifies the sound of human voice frequency range to help keep dialogue audible when background noise swells.



HDMI, the HDMI logo and High-Definition Multimedia Interface are trademarks or registered trademarks of HDMI Licensing LLC."



Matches the original frame rate of the film for a more film-like experience



IMPORTANT INFORMATION TO PREVENT "IMAGE BURN / BURN-IN" ON YOUR TV SCREEN

- When a fixed image (e.g. logos, screen menus, video game, and computer display) is displayed on the TV for an extended period, it can become permanently imprinted on the screen. This phenomenon is known as "image burn" or "burn-in." Image burn is not covered under the manufacturer's warranty.
- In order to prevent image burn, avoid displaying a fixed image on your TV screen for a prolonged period (2 or more hours for LCD, 1 or more hours for Plasma).
- Image burn can also occur on the letterboxed areas of your TV if you use the 4:3 aspect ratio setting for an extended period.

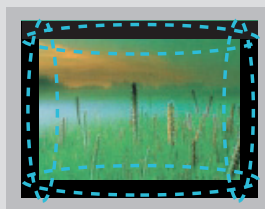

PREPARATION

ACCESSORIES

Ensure that the following accessories are included with your TV. If an accessory is missing, please contact the dealer where you purchased the TV.

The accessories included may differ from the images below.

(For 32/37/42LG710H,
32/37/42/47/55LD650H,
32/37/42LD655H)

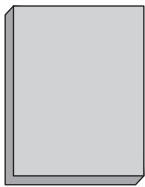

Owner's Manual

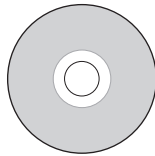

CD Manual

(For 32/37/42LD660H,
32/37/42LD665H
32/37/42/47/55LV555H)

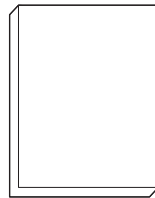

Quick Reference Guide

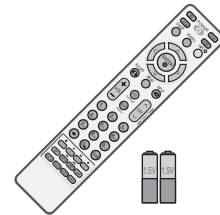

Remote control,
batteries (AAA)

Not included with all models.

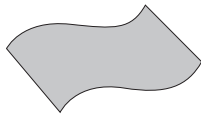

Polishing Cloth

- * Wipe spots on the exterior only with the polishing cloth.
- * Do not wipe roughly when removing stains. Excessive pressure may cause scratches or discoloration.

Optional Extras

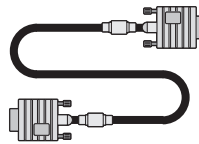

D-sub 15-pin
signal cable

When using the VGA (D-sub 15-pin signal cable) PC connection, the user must use shielded signal interface cables with ferrite cores to maintain standards compliance.

For 32/37/42LG710H

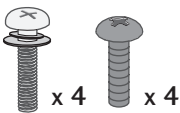

Screws for
stand assembly
(Refer to P.19)



Torx plus
Star-head screw
(Refer to P.19)



Protection cover
(Refer to P.19)



Power cord

(For 32LG710H)



Cable holder
(Refer to P.23)



Plug-in type holder
(Refer to P.23)

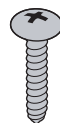

Screw for stand fixing
(Refer to P.27)

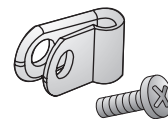

Protective bracket and
screw for power cord
(Refer to P.23)

PREPARATION

PREPARATION

For 32/37/42/47/55LD650H, 32/37/42LD655H, 32/37/42LD660H, 32/37/42LD665H

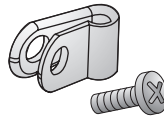
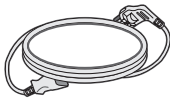
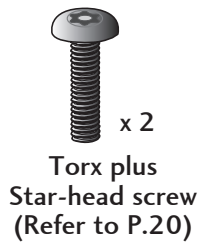
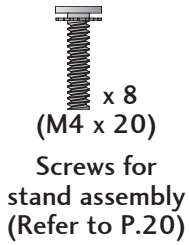

(For 32/37/42LD650H, 32/37/42LD655H, 32/37/42LD660H, 32/37/42LD665H)

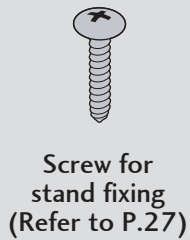
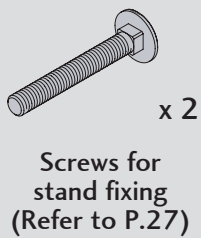
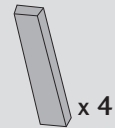
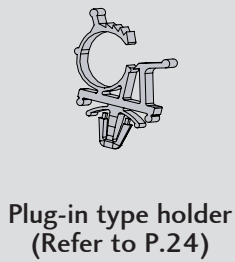

For 32/37/42/47/55LV555H

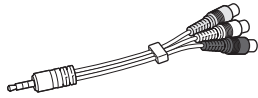

Composite gender cable

(For 47/55LV555H)

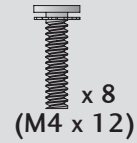

x 8
(M4 x 12)

Screws for stand assembly
(Refer to P.22)

(For 32/37/42LV555H)

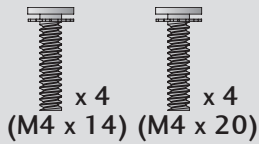

x 4 x 4
(M4 x 14) (M4 x 20)

Screws for
stand assembly
(Refer to P.21)

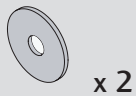

x 2

Washers for
stand fixing
(Refer to P.27)

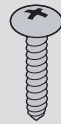

Screw for
stand fixing
(Refer to P.27)



x 2

Nuts for
stand fixing
(Refer to P.27)

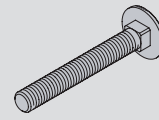

x 2

Screws for
stand fixing
(Refer to P.27)



Rubbers for
stand fixing
(Refer to P.27)

PREPARATION

FRONT PANEL INFORMATION

■ Image shown may differ from your TV.

32/37/42LG710H

PREPARATION

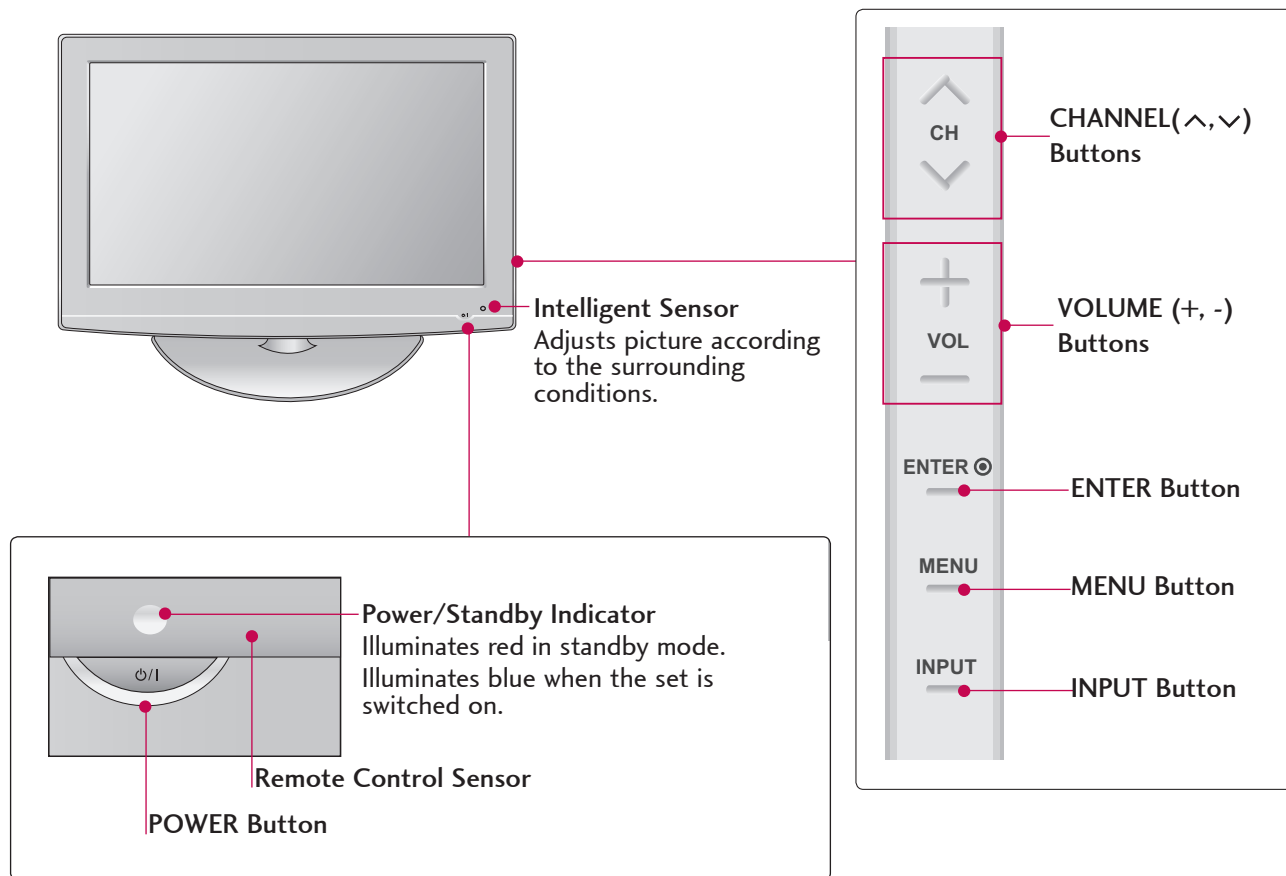

32/37/42/47/55LD650H, 32/37/42LD655H, 32/37/42LD660H, 32/37/42LD665H

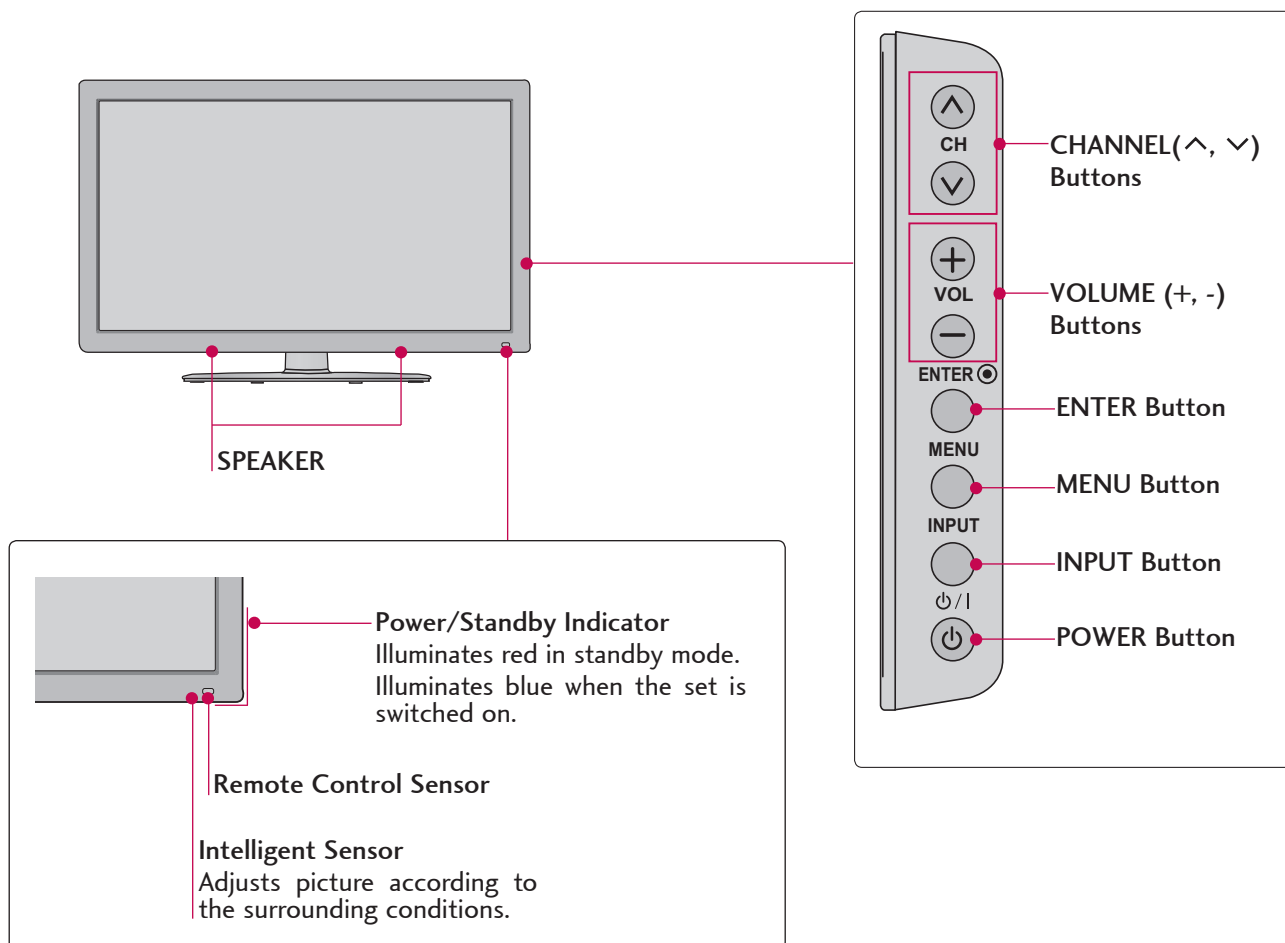

PREPARATION

PREPARATION

32/37/42/47/55LV555H

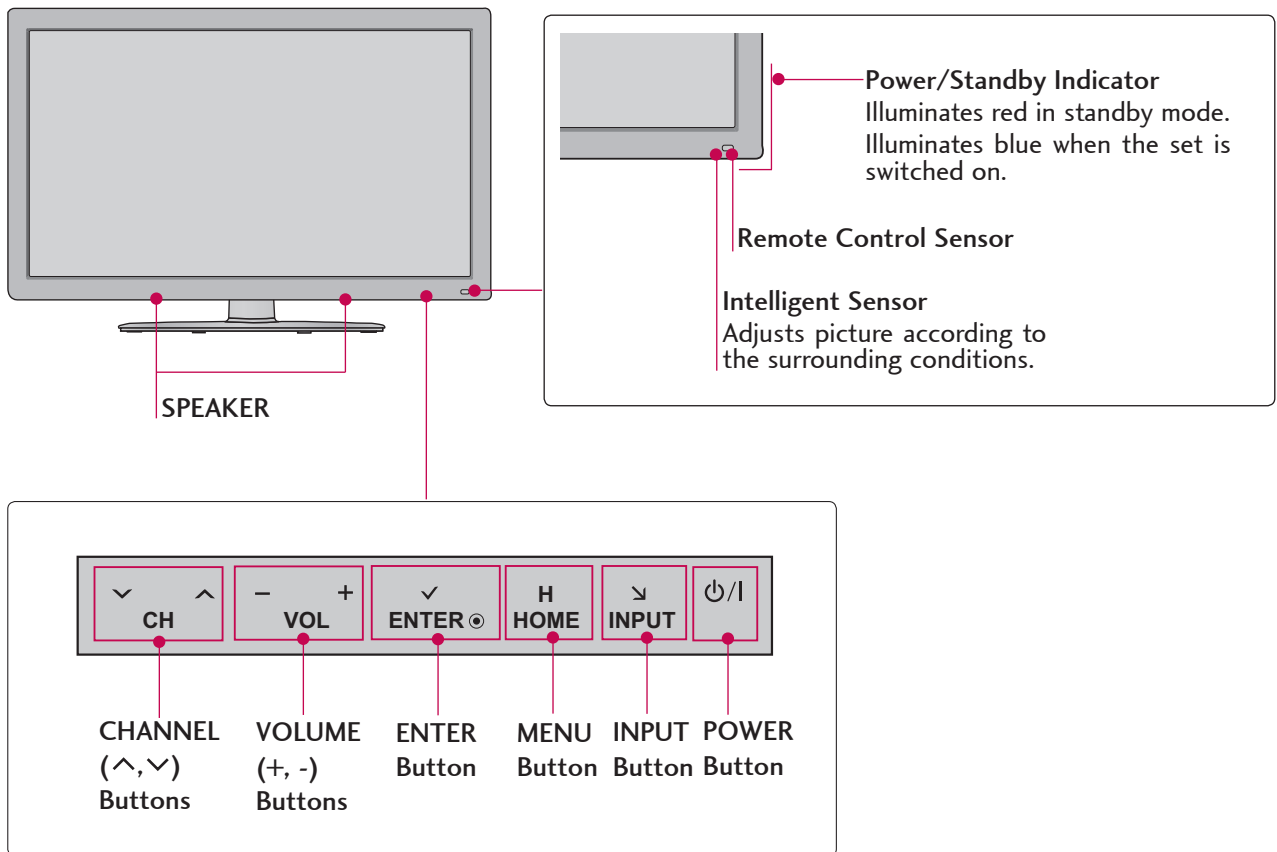

BACK PANEL INFORMATION

■ Image shown may differ from your TV.

32/37/42LG710H

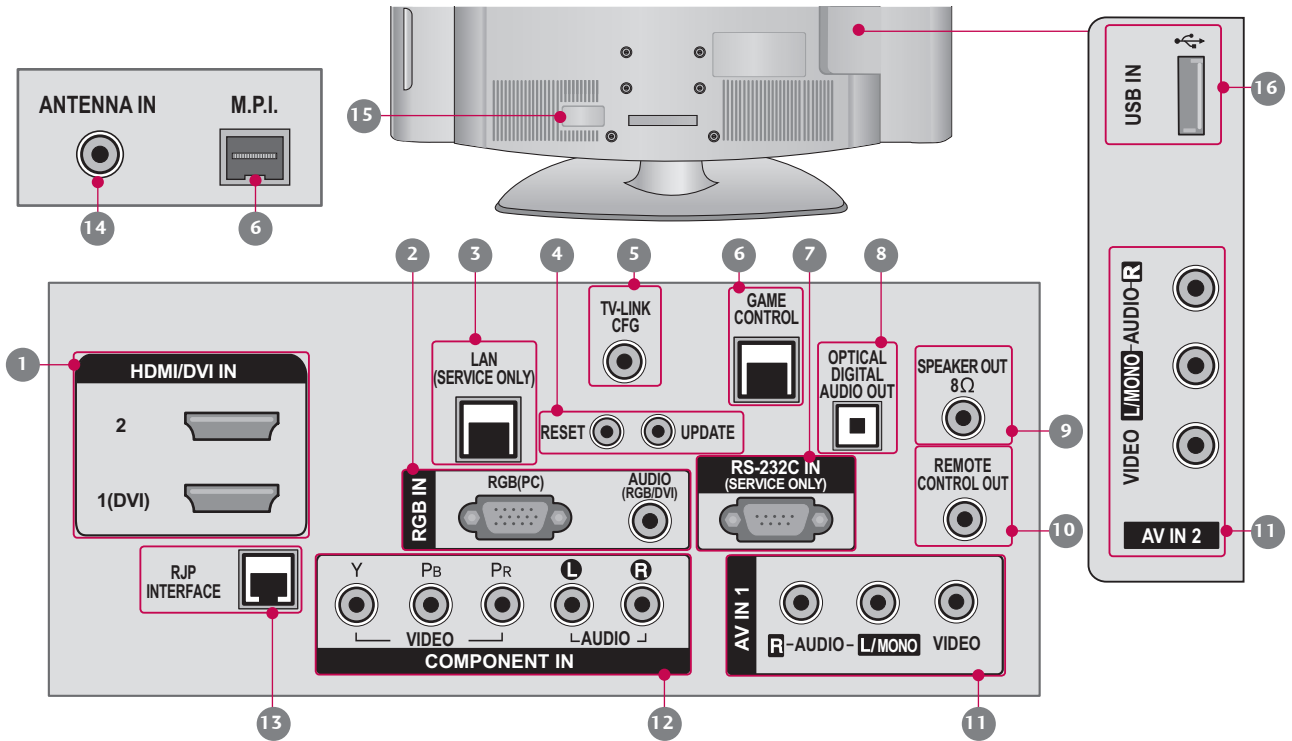

32/37/42LD660H, 32/37/42LD665H

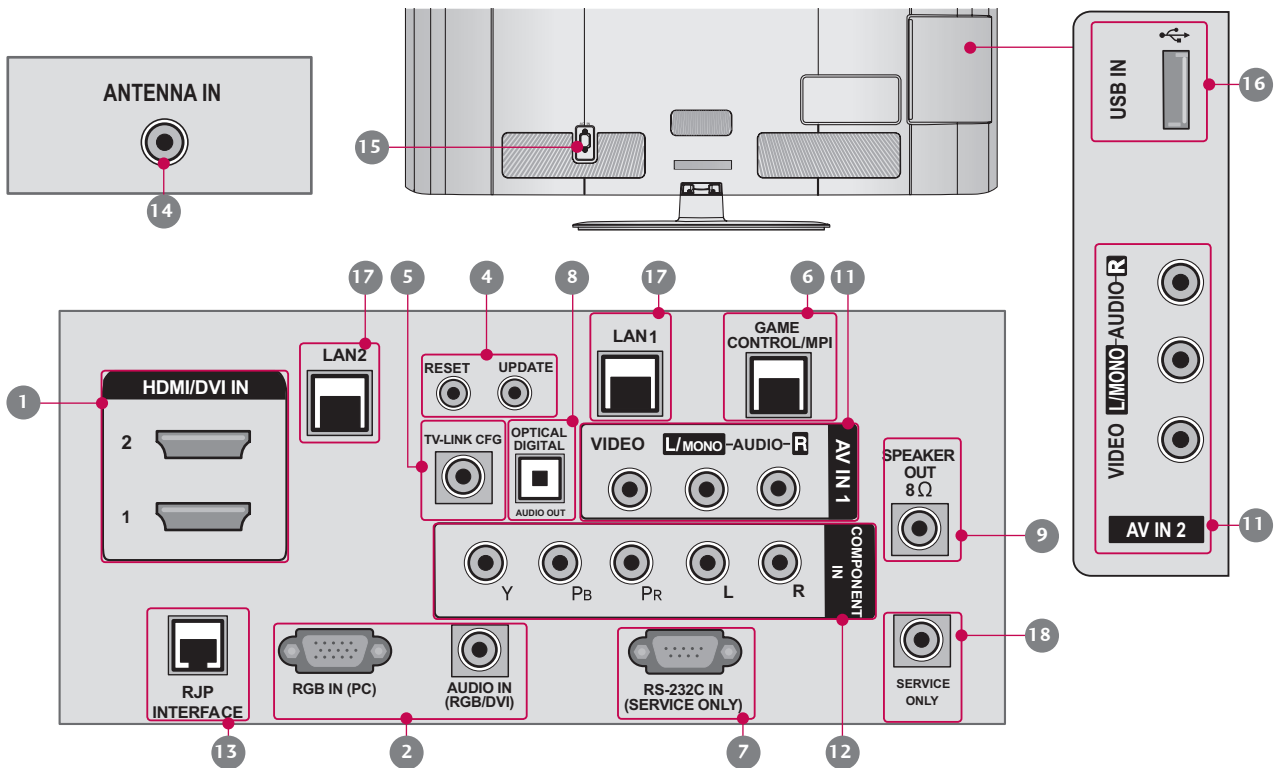

PREPARATION

32/37/42LD650H, 32/37/42LD655H

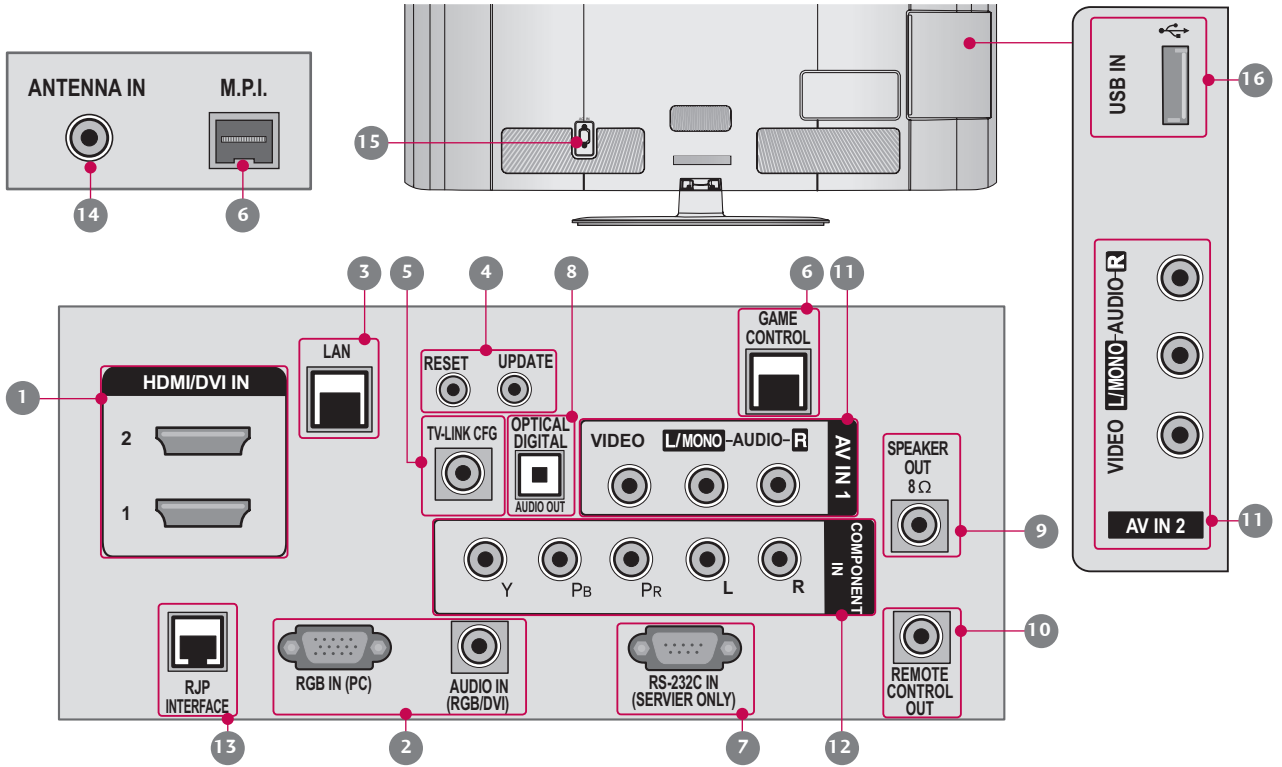

47/55LD650H

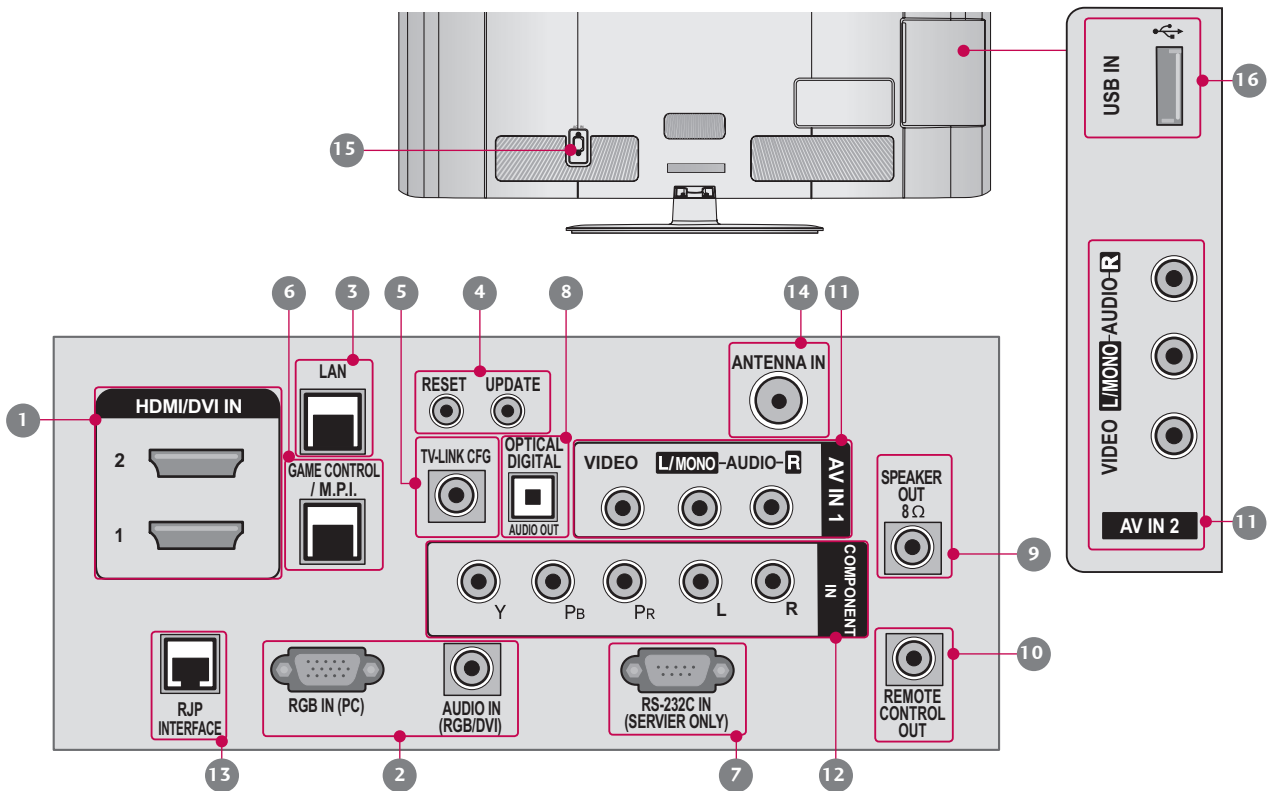

32/37/42/47/55LV555H

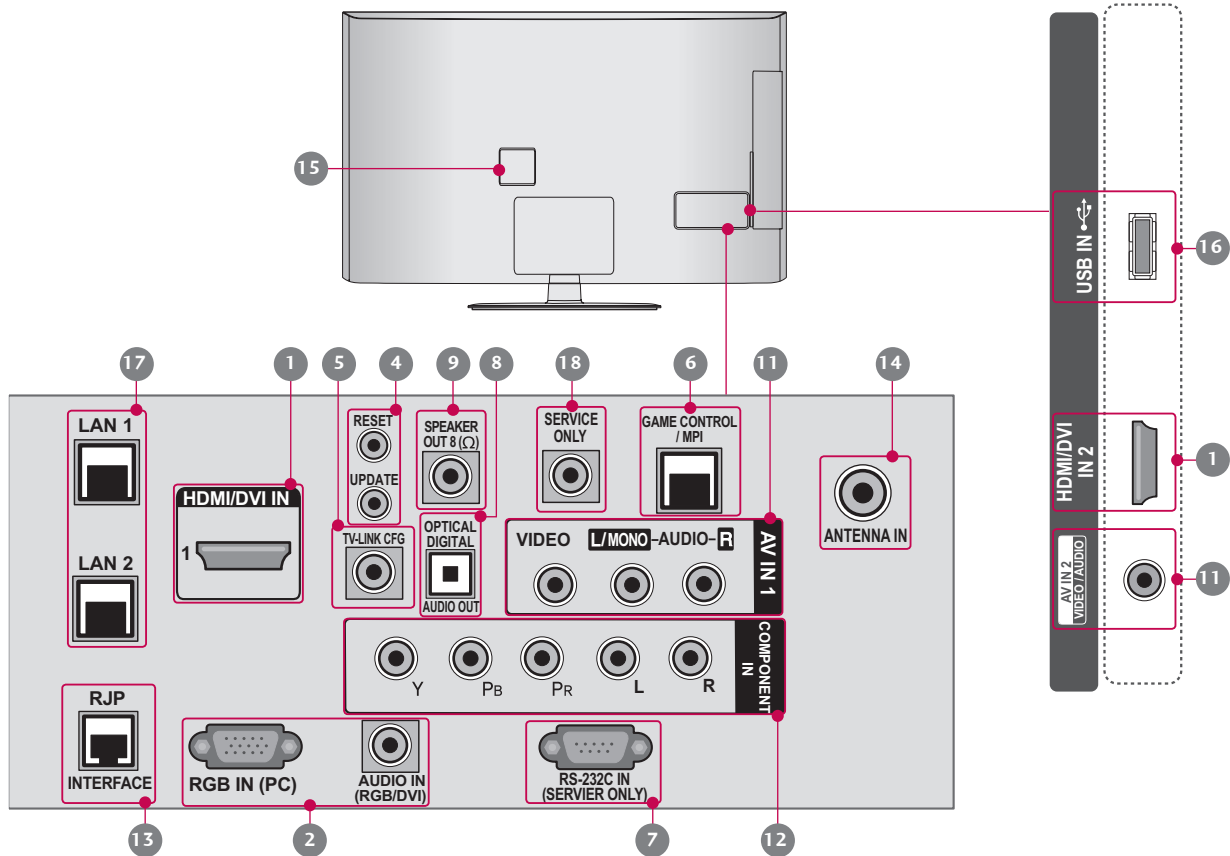

PREPARATION

1 HDMI/DVI IN

Digital Connection.

Supports HD video and Digital audio.

Accepts DVI video using an adapter or HDMI to DVI cable (not included).

2 RGB IN (PC)

Analog PC Connection. Uses a D-sub 15 pin cable (VGA cable).

AUDIO IN (RGB/DVI)

1/8" (0.32 cm) headphone jack for analog PC audio input.

3 LAN (SERVICE ONLY)

For connecting to a control network.

4 RESET

Performs a hardware reset.

UPDATE

Enables/disables software downloads and debug mode.

5 TV - LINK CFG

Computer input for programming Free To Guest services.

6 GAME CONTROL

Input port for third party game Controllers.

M. P. I.

Allows VOD/PPV devices or set-top boxes to control the TV.

7 RS-232C IN (SERVICE ONLY)

Used for software updates.

8 OPTICAL DIGITAL AUDIO OUT

Optical digital audio output for use with amps and home theater systems.

Note: In standby mode, this port doesn't work.

9 SPEAKER OUT (8Ω)

For use with external speakers.

10 REMOTE CONTROL OUT

IR output for controlling an auxiliary device.

11 AV (Audio/Video) IN 1/2

Analog composite connection. Supports standard definition video only (480i).

12 COMPONENT IN

Analog Connection. Supports HD.

Uses a red, green, and blue cable for video & a red and white cable for audio.

13 RJP INTERFACE (REMOTE JACK PACK PORT)

Connect this to an LG remote jack pack system.

14 ANTENNA IN

Connect an antenna to receive over-the-air (OTA) signals.

15 Power Cord Socket

AC power input.

Caution: Never attempt to operate the TV on DC power.

16 USB IN

Used for viewing multimedia files.

17 LAN

For connecting to a control network.

18 SERVICE ONLY

Used for software updates.

STAND INSTRUCTIONS

■ Image shown may differ from your TV.

32/37/42LG710H

INSTALLATION

- 1 Carefully place the TV screen side down on a cushioned surface to protect the screen from damage.

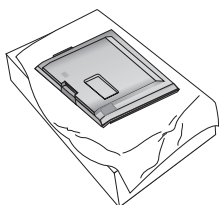

- 2 Assemble the parts of the **STAND BODY** with the **STAND BASE** of the TV.

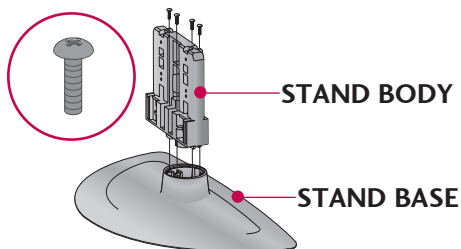

- 3 Insert the stand as shown.

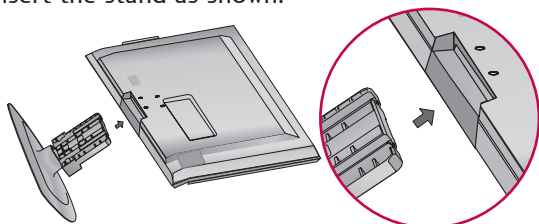

- 4 Tighten the stand with the four screws (provided as parts of the TV).

or

Tighten the two of these four screws and the two Torx plus star head screws (provided as parts of the TV) to secure the TV. Tighten the two Torx plus star head screws with a star head driver bit (not provided as parts of the TV).

NOTE

- ▶ When assembling the desk type stand, make sure the screws are fully tightened (If not tightened fully, the TV can tilt forward after the product installation). Do not over tighten.

DETACHMENT

- 1 Carefully place the TV screen side down on a cushioned surface to protect the screen from damage.

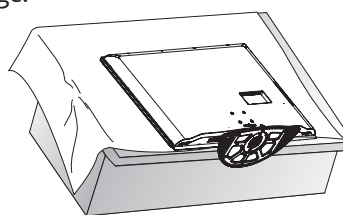

- 2 Remove the four screws that hold the base on.

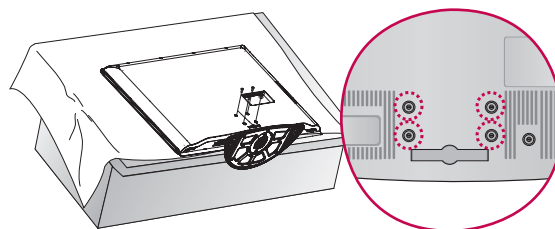

- 3 Detach the stand from the TV.

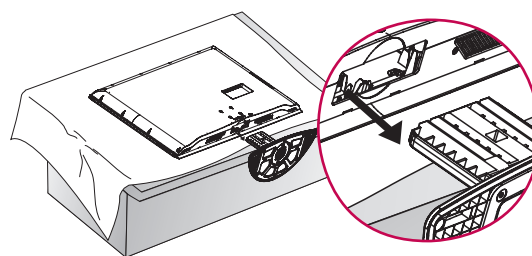

PROTECTION COVER

After removing the stand, install the included **PROTECTION COVER** over the hole for the stand.

Press the **PROTECTION COVER** into the TV until you hear it click.

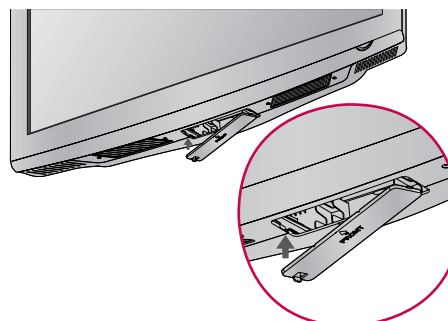

PREPARATION

32/37/42/47/55LD650H, 32/37/42LD655H, 32/37/42LD660H, 32/37/42LD665H

INSTALLATION

- 1 Carefully place the TV screen side down on a cushioned surface to protect the screen from damage.

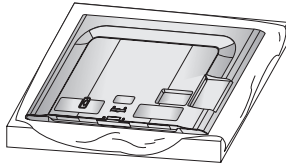

- 2 Assemble the parts of the **STAND BODY** with the **STAND BASE** of the TV.

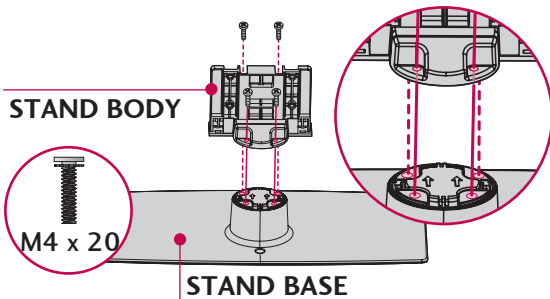

- 3 Insert the stand as shown.

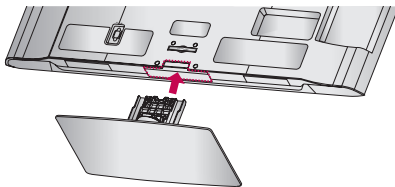

- 4 Tighten the stand with the four screws (provided as parts of the TV).

or

Tighten the two of these four screws and the two Torx plus star head screws (provided as parts of the TV) to secure the TV. Tighten the two Torx plus star head screws with a star head driver bit (not provided as parts of the TV).

! NOTE

- ▶ When assembling the desk type stand, make sure the screws are fully tightened (if not tightened fully, the TV can tilt forward after the product installation). Do not over tighten.

DETACHMENT

- 1 Carefully place the TV screen side down on a cushioned surface to protect the screen from damage.

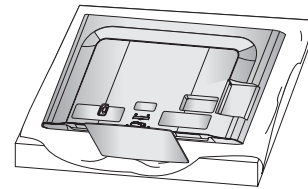

- 2 Remove the four screws that hold the base on.

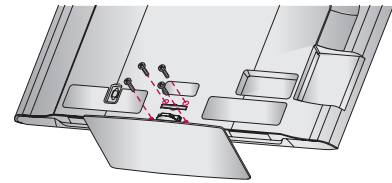

- 3 Detach the stand from the TV.

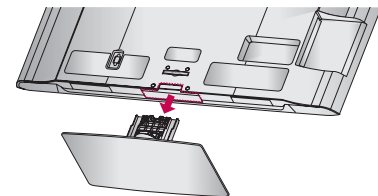

PROTECTION COVER

After removing the stand, install the included **PROTECTION COVER** over the hole for the stand.

Press the **PROTECTION COVER** into the TV until you hear it click.

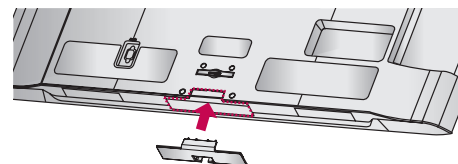

32/37/42LV555H

INSTALLATION

- 1 Carefully place the TV screen side down on a cushioned surface to protect the screen from damage.

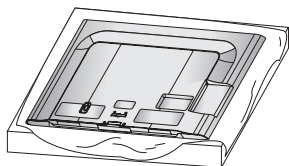

- 2 Assemble the parts of the **STAND BODY** with the **STAND BASE** of the TV.

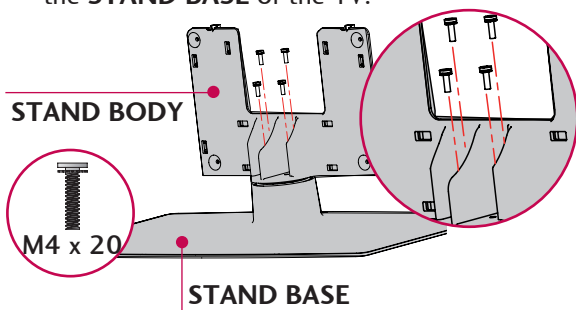

- 3 Insert the stand as shown.

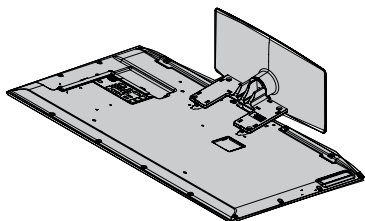

- 4 Install the 4 screws into the holes shown.

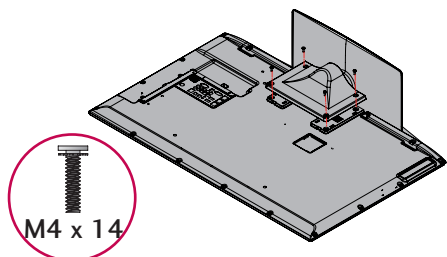

NOTE

- ▶ When assembling the desk type stand, make sure the screws are fully tightened (If not tightened fully, the TV can tilt forward after the product installation). Do not over tighten.

DETACHMENT

- 1 Carefully place the TV screen side down on a cushioned surface to protect the screen from damage.

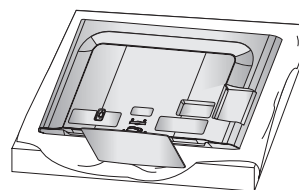

- 2 Remove the four screws that hold the base on.

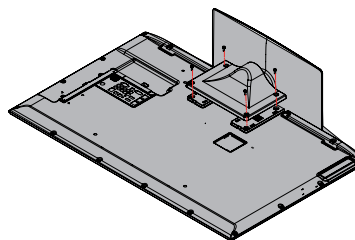

PREPARATION

47/55LV555H

INSTALLATION

- 1 Carefully place the TV screen side down on a cushioned surface to protect the screen from damage.

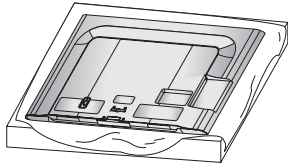

- 2 Assemble the parts of the **STAND BODY** with the **STAND BASE** of the TV.

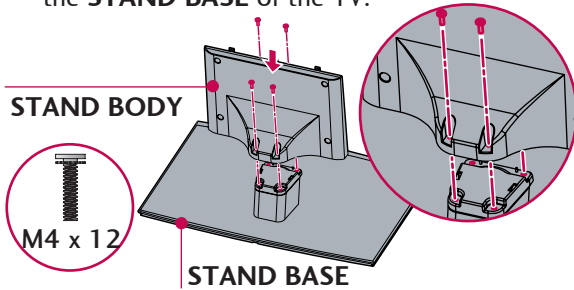

- 3 Insert the stand as shown.

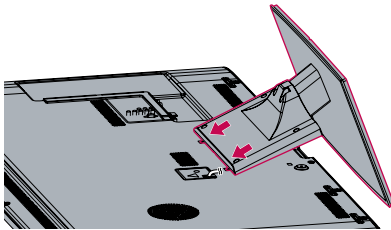

- 4 Install the 4 screws into the holes shown.

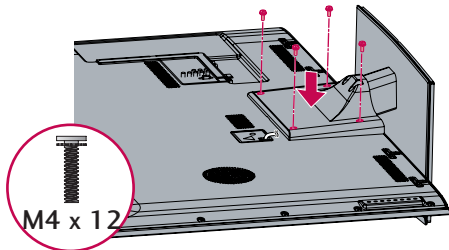

! NOTE

- ▶ When assembling the desk type stand, make sure the screws are fully tightened (If not tightened fully, the TV can tilt forward after the product installation). Do not over tighten.

DETACHMENT

- 1 Carefully place the TV screen side down on a cushioned surface to protect the screen from damage.

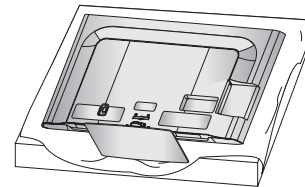

- 2 Remove the four screws that hold the base on.

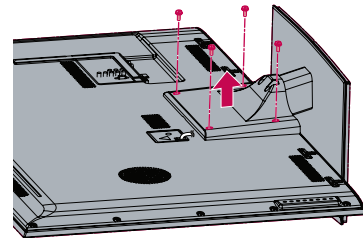

CABLE MANAGEMENT

■ Image shown may differ from your TV.

32/37/42LG710H

- 1 Connect the cables as necessary.
 To connect additional equipment, see the **EXTERNAL EQUIPMENT SETUP** section.
 To help prevent the power cable from being removed by accident, secure the power cable with the included **PROTECTIVE BRACKET/SCREW**.
 The 32LG710H use a **PLUG-IN TYPE HOLDER** instead of using a screw.

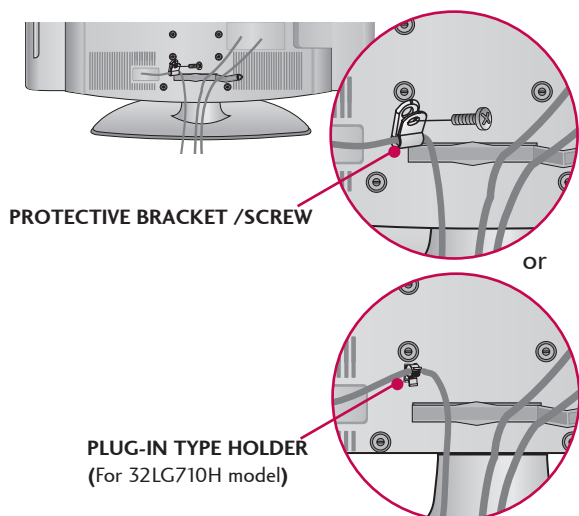

- 2 Open the **CABLE MANAGEMENT CLIP** as shown.
 If a **CABLE HOLDER** was included with your TV, install it as shown.

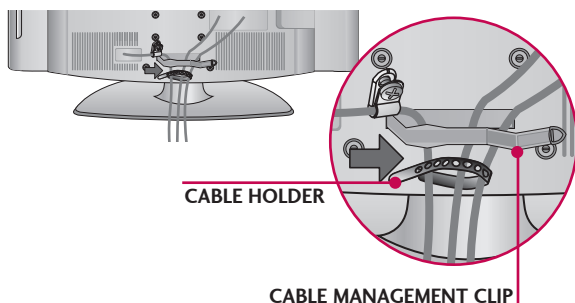

- 3 Put the cables inside the **CABLE MANAGEMENT CLIP** and snap it closed.

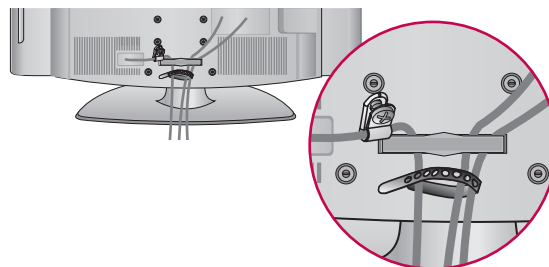

! NOTE

- ▶ Do not hold the **CABLE MANAGEMENT CLIP** when moving the TV.
 - If the TV is dropped, you may be injured or the product may be broken.
- ▶ With some TVs, the **PLUG-IN TYPE HOLDER** and the **CABLE HOLDER** are included. If these holders are inserted into the hole provided on back of the TV, they cannot be removed.

PREPARATION

32/37/42/47/55LD650H, 32/37/42LD655H, 32/37/42LD660H, 32/37/42LD665H

- 1** Connect the cables as necessary.
To connect additional equipment, see the **EXTERNAL EQUIPMENT SETUP** section.
To help prevent the power cable from being removed by accident, secure the power cable with the included **PROTECTIVE BRACKET / SCREW**.
The 32/37/42LD650H, 32/37/42LD655H, 32/37/42LD660H, 32/37/42LD665H use a **PLUG-IN TYPE HOLDER** instead of using a screw.

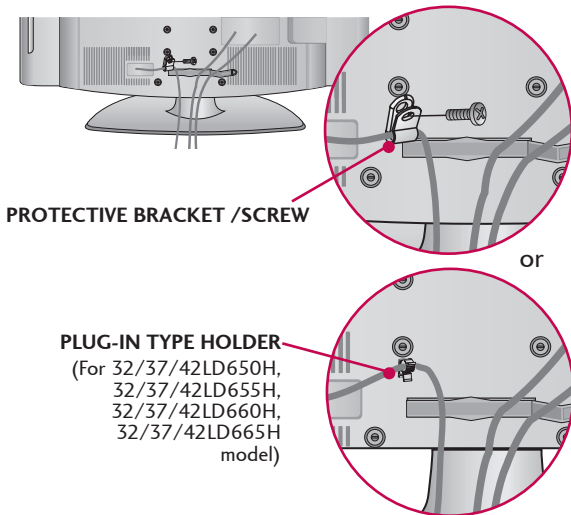

- 2** Open the **CABLE MANAGEMENT CLIP** as shown.
If a **CABLE HOLDER** was included with your TV, install it as shown.

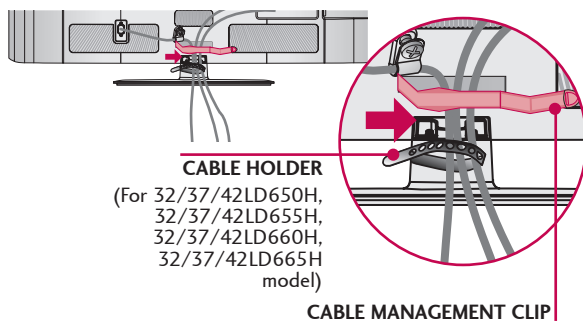

- 3** Put the cables inside the **CABLE MANAGEMENT CLIP** and snap it closed.

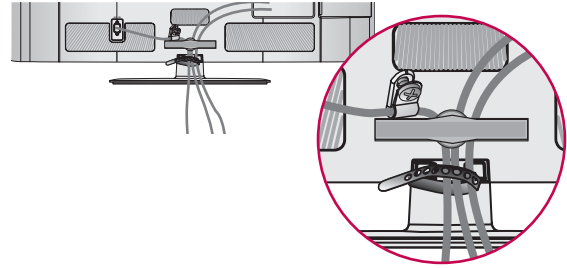

! NOTE

- ▶ Do not hold the **CABLE MANAGEMENT CLIP** when moving the TV.
- If the TV is dropped, you may be injured or the product may be broken.
- ▶ With some TVs, the **PLUG-IN TYPE HOLDER** and the **CABLE HOLDER** are included. If these holders are inserted into the hole provided on back of the TV, they cannot be removed.

32/37/42/47/55LV55H

- 1** Gather and bind the cables with the **CABLE HOLDER** on the TV back cover.

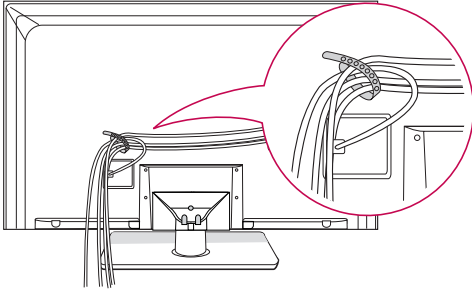

PREPARATION

DESKTOP PEDESTAL INSTALLATION

■ Image shown may differ from your TV.

For proper ventilation, allow a clearance of 4 inches on all four sides from the wall.

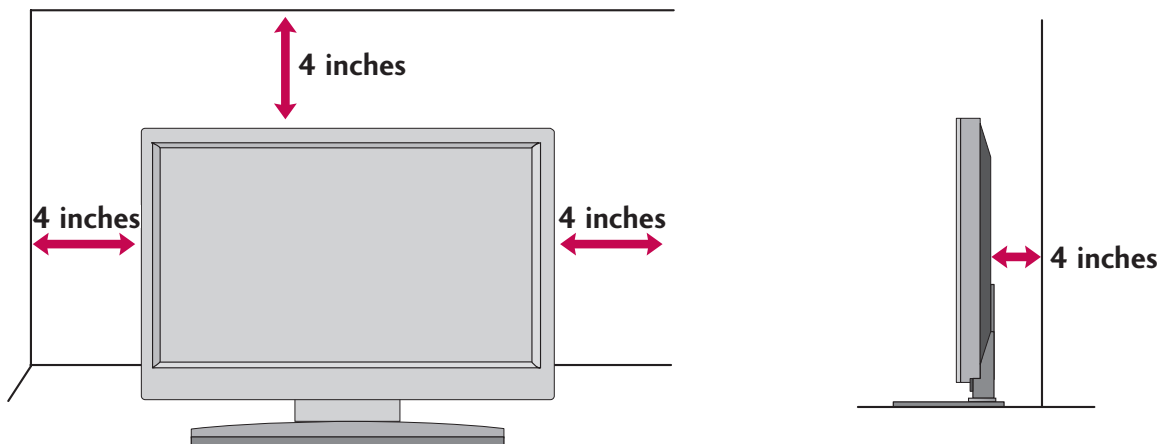

⚠ CAUTION

- ▶ Ensure adequate ventilation by following the clearance recommendations.
- ▶ Do not mount near or above any type of heat source.

SWIVEL STAND

After installing the TV, you can adjust the TV set manually to the left or right direction to suit your viewing position.

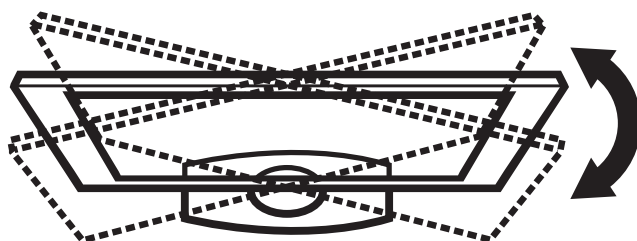

20°: 47/55LD650H,
47/55LV555H
90°: Other Models

ATTACHING THE TV TO A DESK

The TV should be attached to a desk so it cannot be pulled in a forward/backward direction, potentially causing injury or damaging the product.

32/37/42LG710H

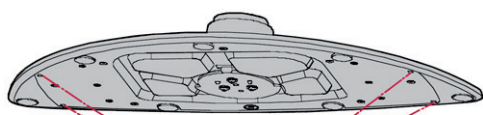

4-Screws
(not provided as parts of the product)

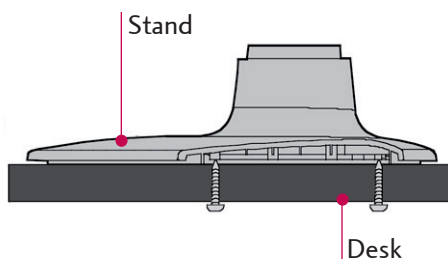

- ▶ Recommended screw size: M5 x L (*L: Table depth + 8f10mm)
- ex) Table depth: 15mm, Screw: M5 x 25

32/37/42LD650H, 32/37/42LD655H, 32/37/42LD660H, 32/37/42LD665H, 32/37/42LV555H

Type 1

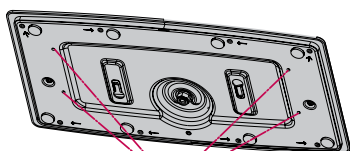

4-Screws
(not provided as parts of the product)

Type 2

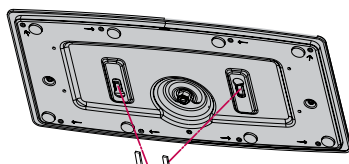

2-Screws, 2-Washers, 2-Nuts, 4-Rubbers
(provided as parts of the product)

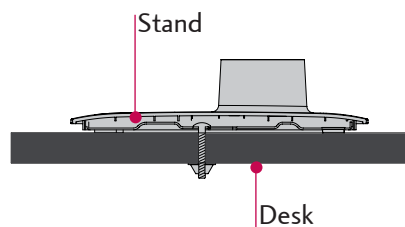

- ▶ You can select any type of attachment (Type 1 or Type 2)
- ▶ Do not over tighten.

PREPARATION

PREPARATION

47/55LD650H, 47/55LV555H

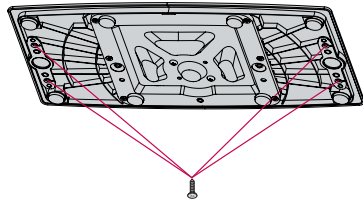

4-Screws
(not provided as parts of the product)

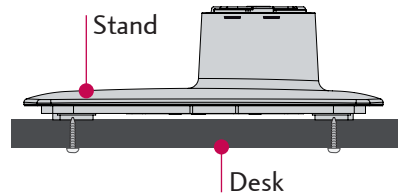

EXCEPT 47/55LD650H, 47/55LV555H

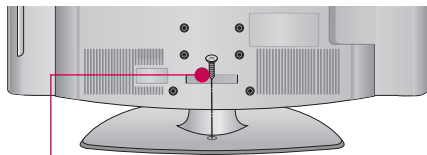

1-Screw
(provided as parts of the product)

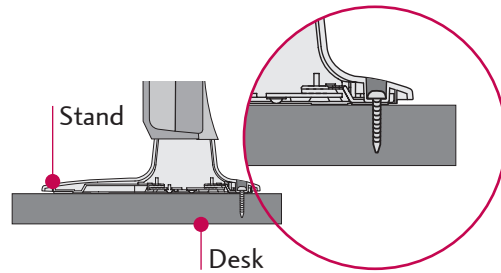

⚠ WARNING

- ▶ To prevent TV from falling over, the TV should be securely attached to the floor/wall per installation instructions. Tipping, shaking, or rocking the TV may cause injury.



VESA WALL MOUNTING

Install your wall mount on a solid wall perpendicular to the floor. When attaching to other building materials, please contact an installer. If installed on a ceiling or slanted wall, it may fall and result in severe personal injury.

We recommend that you use an LG brand wall mount when mounting the TV to a wall.

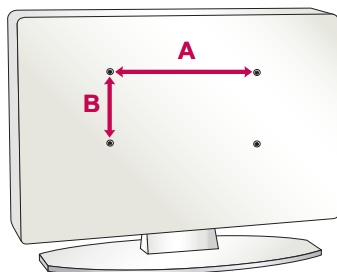
LG recommends that wall mounting be performed by a qualified professional installer.

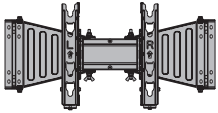
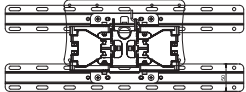
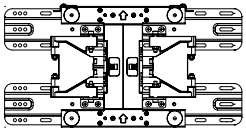
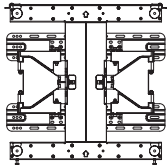

Model	VESA (A * B) 	Standard Screw	Quantity	Wall Mounting Bracket (sold separately)
32LG710H	200 * 100	M4	4	 RW230 AW-47LG30M
37LG710H, 42LG710H	200 * 200	M6	4	 AW-47LG30M
32LD650H, 32LD655H, 32LD660H, 32LD665H, 32LV555H	200 * 100	M4	4	 LSW100B, LSW100BG
37LD650H, 37LD655H, 37LD660H, 37LD665H, 37LV555H, 42LD650H, 42LD655H, 42LD660H, 42LD665H, 47LD650H	200 * 200	M6	4	 LSW200B, LSW200BG
42LV555H, 47LV555H, 55LD650H, 55LV555H	400 * 400	M6	4	 LSW400B, LSW400BG

PREPARATION

! NOTE

- ▶ Screw length needed depends on the wall mount used. For further information, refer to the instructions included with the mount.
- ▶ Standard dimensions for wall mount kits are shown in the table.
- ▶ When purchasing our wall mount kit, a detailed installation manual and all parts necessary for assembly are provided.
- ▶ Do not use screws longer than the standard dimension, as they may cause damage to the inside of the TV.
- ▶ For wall mounts that do not comply with the VESA standard screw specifications, the length of the screws may differ depending on their specifications.
- ▶ Do not use screws that do not comply with the VESA standard screw specifications. Do not use fasten the screws too strongly, this may damage the TV or cause the TV to a fall, leading to personal injury. LG is not liable for these kinds of accidents.
- ▶ LG is not liable for TV damage or personal injury when a non-VESA or non specified wall mount is used or the consumer fails to follow the TV installation instructions.

! CAUTION

- ▶ Do not install your wall mount kit while your TV is turned on. It may result in personal injury due to electric shock.

SECURING THE TV TO THE WALL TO PREVENT FALLING WHEN THE TV IS USED ON A STAND

- You should purchase necessary components to prevent the TV from tipping over (when not using a wall mount).
- Image shown may differ from your TV.

We recommend that you set up the TV close to a wall so it cannot fall over if pushed backwards. Additionally, we recommend that the TV be attached to a wall so it cannot be pulled in a forward direction, potentially causing injury or damaging the product.

Caution: Please make sure that children don't climb on or hang from the TV.

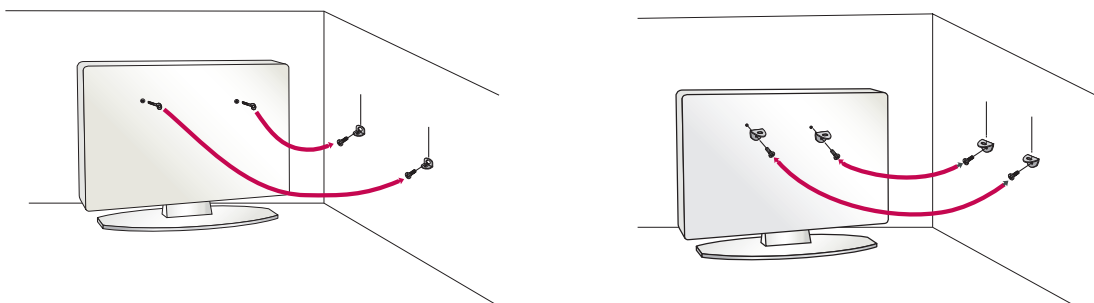

- Insert the eye-bolts (or TV brackets and bolts) to tighten the product to the wall as shown in the picture.
 - * If your product has the bolts in the eye-bolts position before inserting the eye-bolts, loosen the bolts.
 - * Insert the eye-bolts or TV brackets/bolts and tighten them securely in the upper holes. Secure the wall brackets with the bolts (sold separately) to the wall. Match the height of the bracket that is mounted on the wall to the holes in the product. Ensure the eye-bolts or brackets are tightened securely.

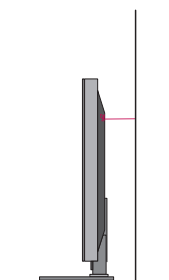

- Use a sturdy rope (sold separately) to tie the product. It is safer to tie the rope so it becomes horizontal between the wall and the product.

NOTE

- ▶ Use a platform or cabinet strong enough and large enough to support the size and weight of the TV.
- ▶ To use the TV safely make sure that the height of the bracket on the wall and the one on the TV are the same.

PREPARATION

- To prevent damage, do not connect to the power outlet until all connections are made between the devices.

ANTENNA OR CABLE CONNECTION

1. Antenna (Analog or Digital)

This image refers to using a Wall Antenna Socket or Outdoor Antenna without a Cable Box Connection.

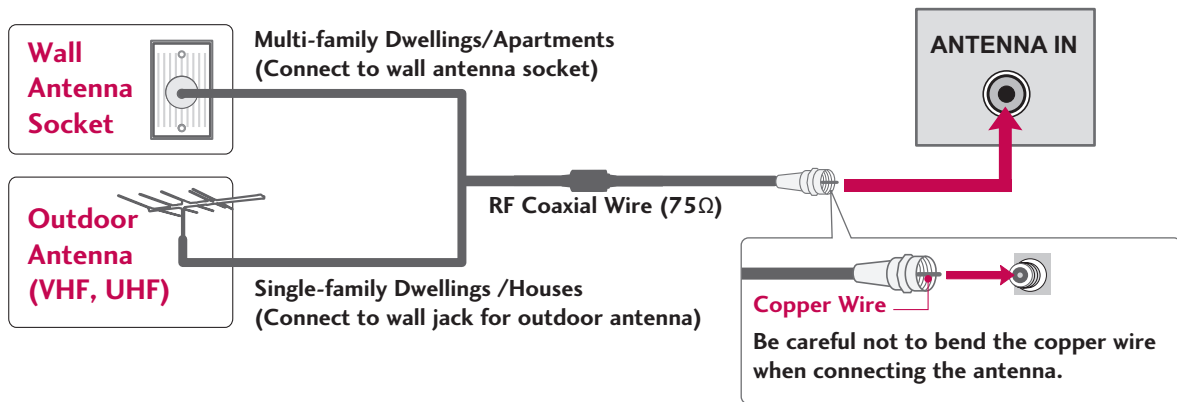

- For optimum picture quality, adjust the antenna direction if needed.
 - To improve the picture quality in a poor signal area, please purchase a signal amplifier and install properly.
 - If the antenna needs to be split for two TV's, install a 2-Way Signal Splitter.
 - If the antenna is not installed properly, contact your dealer for assistance.

2. Cable

This image refers to using a cable connection without a cable box.

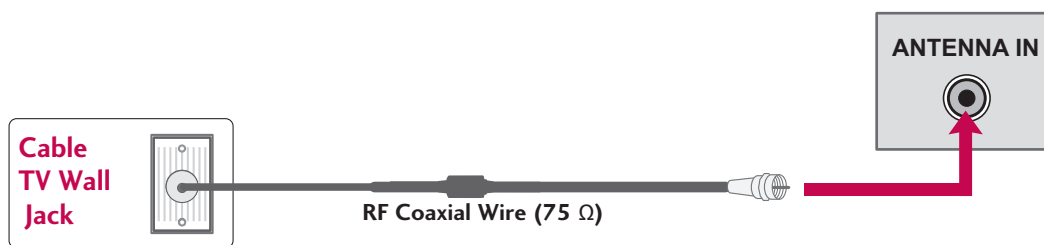

- If you experience a poor signal when using cable, make sure the RF cable is screwed in completely. Contact your cable company if a poor signal persists.

MPI CARD SLOT / PPV CARD INSTALLATION

(Except 47/55LD650H, 32/37/42/47/55LV55H)

The MPI card is equipped with an RF jack for antenna/cable signal source connection. This card can be removed and replaced with a third-party PPV (Pay-Per-View) card.

MPI Card Removal / PPV Card Installation

1. Remove the two MPI card retainer screws.
2. Pull out current MPI card far enough so that the RF cable can be detached from the old card.
3. Detach RF cable.
4. Place new PPV card into slot and slide it in far enough to reconnect RF cable.
5. Insert card all the way into the slot making sure it is fully seated into back plane connector.
6. Replace the two card retainer screws.

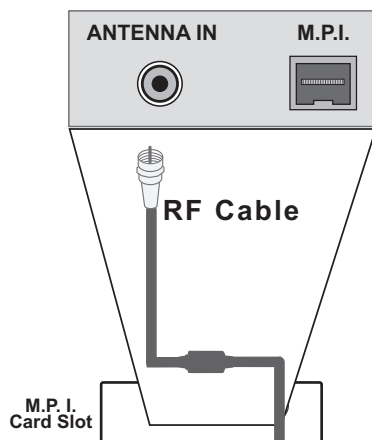

⚠ WARNING

- ▶ There is an RF cable connected to the back of the card. Remove the card slowly.

EXTERNAL EQUIPMENT SETUP

- To prevent the equipment damage, never plug in any power cords until you have finished connecting all equipment.
- Image shown may differ from your TV.

HD RECEIVER SETUP

This TV can receive Digital Over-the-air or Digital Cable signals without an external digital set-top box. However, if you do receive digital signals from a digital set-top box or other digital external device, refer to the figure as shown below.

Component Connection

1. How to connect

- 1 Connect the video outputs (Y, P_B, P_R) of the digital set-top box to the **COMPONENT IN VIDEO** jacks on the TV. Match the jack colors (Y = green, P_B = blue, and P_R = red).
- 2 Connect the audio output of the digital set-top box to the **COMPONENT IN AUDIO** jacks on the TV.

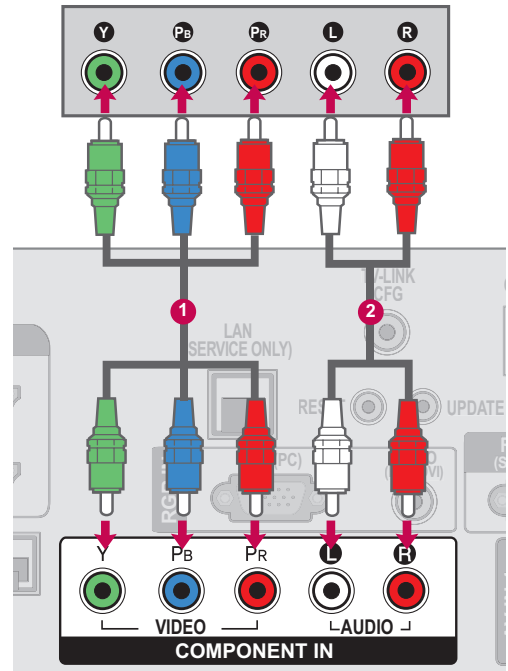

2. How to use

- Turn on the digital set-top box.
(Refer to the owner's manual for the digital set-top box.)
- Select **Component** input source using the **INPUT** button on the remote control.

Supported Resolutions

Signal	Component	HDMI
480i	Yes	No
480p	Yes	Yes
720p	Yes	Yes
1080i	Yes	Yes
1080p	Yes	Yes

Except 32/37/42LG710H, 32LD65H, 32LD655H, 32LD660H, 32LD665H, 32LV555H

Y, CB/PB, CR/PR

Resolution	Horizontal Frequency(kHz)	Vertical Frequency(Hz)
720x480i	15.73	59.94
720x480p	15.73	60.00
720x480p	31.47	59.94
720x480p	31.47	60.00
1280x720p	44.96	59.94
1280x720p	45.00	60.00
1920x1080i	33.72	59.94
1920x1080i	33.75	60.00
1920x1080p	67.50	60.00

Except 32/37/42LG710H, 32LD65H, 32LD655H, 32LD660H, 32LD665H, 32LV555H

HDMI Connection

1. How to connect

- 1 Connect the digital set-top box to **HDMI/DVI IN 1 (DVI)** or **2*** jack on the TV.
- 2 No separate audio connection is necessary.
HDMI supports both audio and video.

2. How to use

- Turn on the digital set-top box.
(Refer to the owner's manual for the digital set-top box.)
- Select **HDMI1** or **HDMI2** input source with using the **INPUT** button on the remote control.

*HDMI2: Except 32/37/42/47/55LV555H

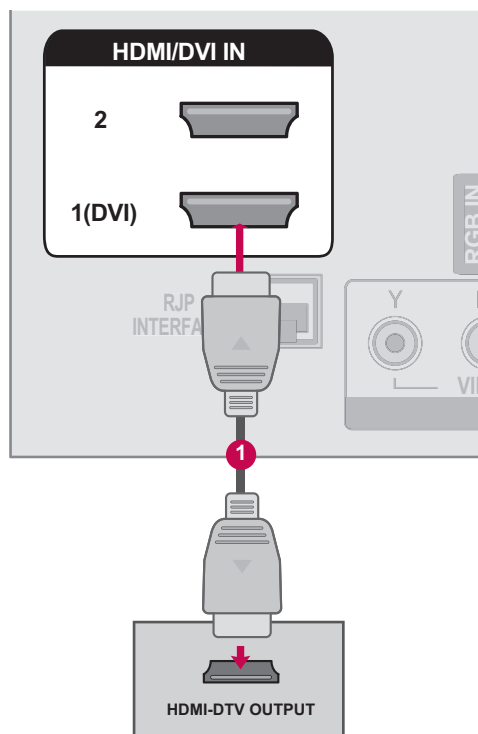

NOTE

- ▶ If the HDMI cables don't support High Speed HDMI, it can cause flickers or no screen display. In this case use the latest cables that support High Speed HDMI.
- ▶ HDMI mode supports PCM, Dolby Digital audio format.

HDMI-DTV

Resolution	Horizontal Frequency(kHz)	Vertical Frequency(Hz)
720x480p	31.47	59.94
	31.47	60.00
1280x720p	44.96	59.94
	45.00	60.00
1920x1080i	33.72	59.94
	33.75	60.00
1920x1080p	26.97	23.94
	27.00	24.00
	33.71	29.97
	33.75	30.00
	67.432	59.939
	67.50	60.00

Except 32/37/42LG710H,32LD65H,
32LD655H, 32LD660H,
32LD665H, 32LV555H

EXTERNAL EQUIPMENT SETUP

DVI to HDMI Connection

1. How to connect

- 1 Connect the DVI output of the digital set-top box to the **HDMI/DVI IN 1 (DVI)** jack on the TV.
- 2 Connect the audio output of the digital set-top box to the **AUDIO (RGB/DVI)** jack on the TV.

2. How to use

- Turn on the digital set-top box.
(Refer to the owner's manual for the digital set-top box.)
- Select the **HDMI 1** input source on the TV using the **INPUT** button on the remote control.

! NOTE

- ▶ A DVI to HDMI cable or adapter is required for this connection. DVI doesn't support audio, so a separate audio connection is necessary.

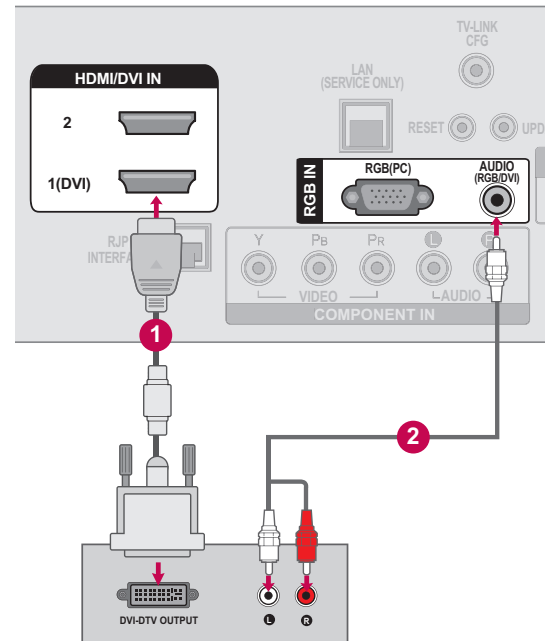

DVD SETUP

Component Connection

1. How to connect

- 1 Connect the video outputs (Y, PB, PR) of the DVD to the **COMPONENT IN VIDEO** jacks on the TV. Match the jack colors (Y = green, PB = blue, and PR = red).
- 2 Connect the audio outputs of the DVD to the **COMPONENT IN AUDIO** jacks on the TV.

2. How to use

- Turn on the DVD player, insert a DVD.
- Select the **Component** input source on the TV using the **INPUT** button on the remote control.
- Refer to the DVD player's manual for operating instructions.

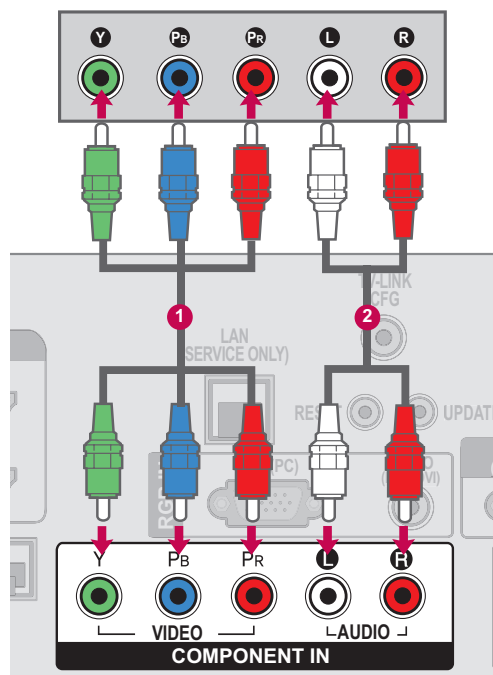

Component Input ports

To get better picture quality, connect a DVD player to the component input ports as shown below.

Component ports on the TV	Y	PB	PR
---------------------------	---	----	----

Video output ports on DVD player	Y	PB	PR
	Y	B-Y	R-Y
	Y	CB	CR
	Y	PB	PR

EXTERNAL EQUIPMENT SETUP

HDMI Connection

1. How to connect

- 1 Connect the HDMI output of the DVD to the **HDMI/DVI IN 1 (DVI)** or **2*** jack on the TV.
- 2 No separate audio connection is necessary. HDMI supports both audio and video.

2. How to use

- Select the **HDMI1** or **HDMI2** input source on the TV using the **INPUT** button on the remote control.
- Refer to the DVD player's manual for operating instructions.

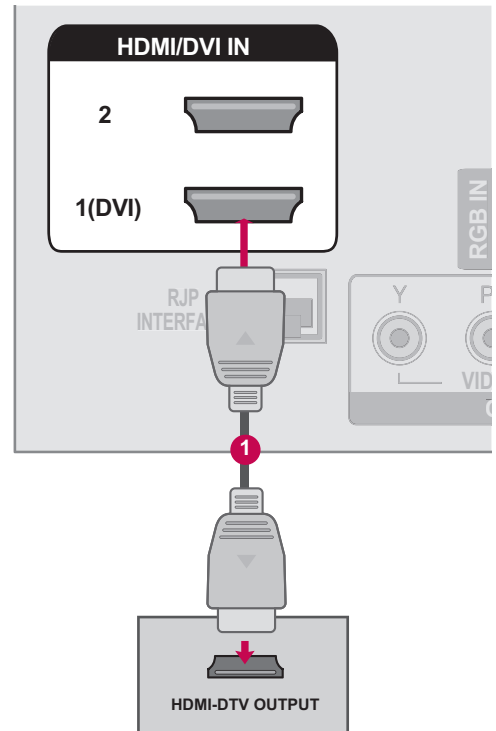

VCR SETUP

- To avoid picture noise (interference), leave an adequate distance between the VCR and TV.

Antenna Connection

1. How to connect

- 1 Connect the RF antenna out socket of the VCR to the **ANTENNA IN** socket on the TV.
- 2 Connect the antenna cable to the RF antenna in socket of the VCR.

2. How to use

- Set VCR output switch to 3 or 4 and then tune TV to the same channel number.
- Insert a video tape into the VCR and press PLAY on the VCR. (Refer to the VCR owner's manual.)

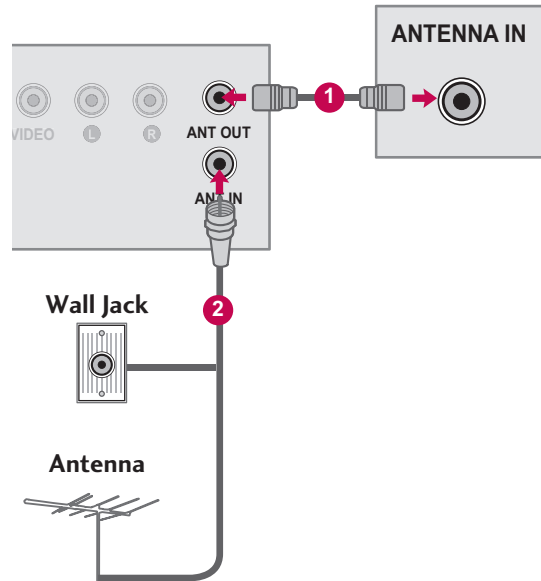

EXTERNAL EQUIPMENT SETUP

Composite (RCA) Connection

1. How to connect

- 1 Connect the **AUDIO/VIDEO** jacks between TV and VCR. Match the jack colors (Video = yellow, Audio Left = white, and Audio Right = red).

2. How to use

- Insert a video tape into the VCR and press PLAY on the VCR. (Refer to the VCR owner's manual.)
- Select the **AV1** input source on the TV using the **INPUT** button on the remote control.
- If connected to **AV IN 2**, select **AV2** input source on the TV.

! NOTE

- ▶ If you have a mono VCR, connect the audio cable from the VCR to the **AUDIO L/MONO** jack of the TV.

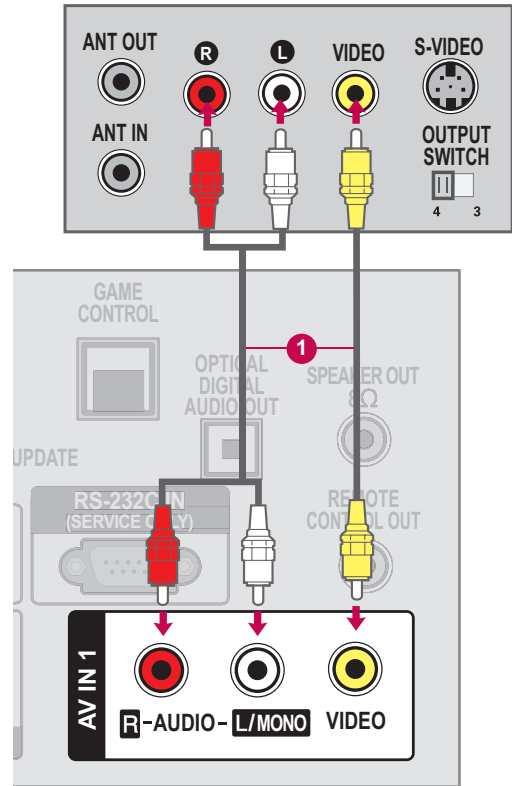

OTHER A/V SOURCE SETUP

1. How to connect

- 1 Connect the **AUDIO/VIDEO** jacks between TV and external equipment. Match the jack colors (Video = yellow, Audio Left = white, and Audio Right = red).

2. How to use

- Select the **AV2** input source on the TV using the **INPUT** button on the remote control.
- If connected to **AV IN 1** input, select the **AV1** input source on the TV.
- Operate the corresponding external equipment.

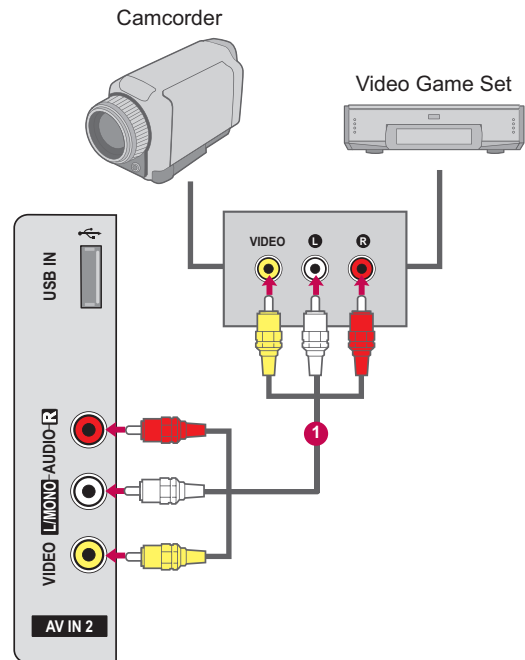

EXTERNAL EQUIPMENT SETUP

AUDIO OUT CONNECTION

Send the TV's audio to external audio equipment via the Audio Output port.

1. How to connect

- 1 Connect one end of the optical cable to the TV's **OPTICAL DIGITAL AUDIO OUT**.
- 2 Connect the other end of the optical cable to the digital audio input on the audio equipment.
- 3 Set the "TV Speaker option - Off" in the AUDIO menu. (▶ p. 88). See the external audio equipment instruction manual for operation.

! NOTE

- ▶ When connecting with external audio equipment, such as amplifiers or speakers, you can turn the TV speakers off in the menu. (▶ p. 88)

! CAUTION

- ▶ Do not look into the optical output port. Looking at the laser beam may damage your vision.
- ▶ Audio with ACP(Audio Copy Protection) function may block digital audio output.

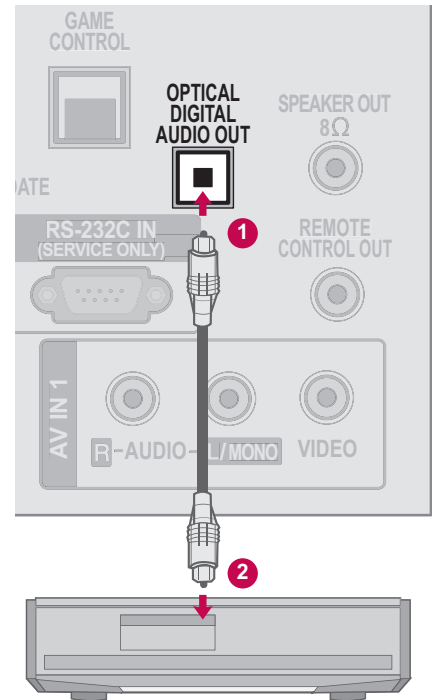

PC SETUP

This TV provides Plug and Play capability, meaning that the PC adjusts automatically to the TV's settings.

VGA (D-Sub 15 pin) Connection

1. How to connect

- 1 Connect the VGA output of the PC to the **RGB (PC)** jack on the TV.
- 2 Connect the PC audio output to the **AUDIO (RGB/DVI)** jack on the TV.

2. How to use

- Turn on the PC and the TV.
- Select the **RGB-PC** input source on the TV using the **INPUT** button on the remote control.

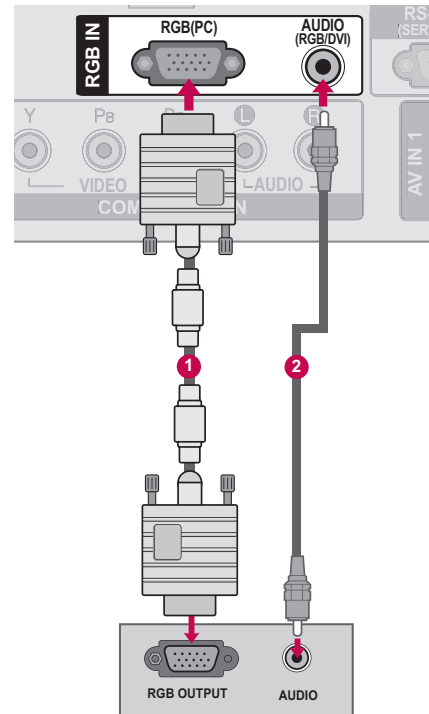

EXTERNAL EQUIPMENT SETUP

DVI to HDMI Connection

1. How to connect

- 1 Connect the DVI output of the PC to the **HDMI/DVI IN 1 (DVI)** jack on the TV.
- 2 Connect the PC audio output to the **AUDIO (RGB/DVI)** jack on the TV.

2. How to use

- Turn on the PC and the TV.
- Select the **HDMI 1** input source on the TV using the **INPUT** button on the remote control.

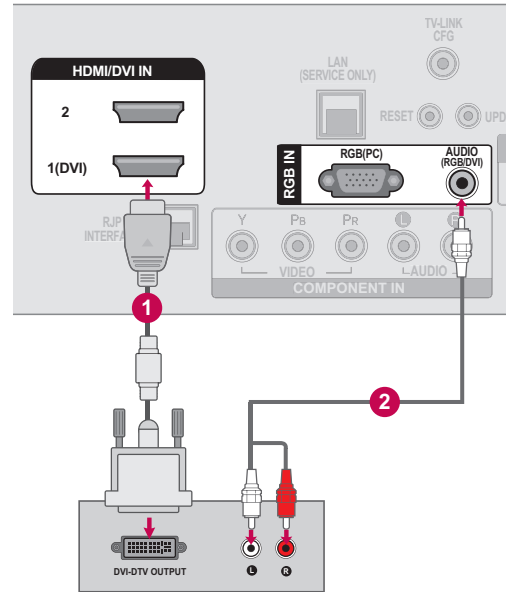

NOTE

- ▶ To get the best picture quality, adjust the PC graphics card to **1360x768** (32/37/42LG710H, 32LD650H, 32LD655H, 32LD660H, 32LD665H, 32LV555H) or **1920x1080** (37/42/47/55LD650H, 37/42LD655H, 37/42LD660H, 37/42LD665H, 37/42/47/55LV555H).
- ▶ Depending on the graphics card, DOS mode may not work if a HDMI to DVI Cable is in use.
- ▶ In PC mode, there may be noise associated with the resolution, vertical pattern, contrast or brightness. If noise is present, change the PC output to another resolution, change the refresh rate to another rate or adjust the brightness and contrast on the PICTURE menu until the picture is clear.
When you use too long RGB-PC cable, there might be a noise on the screen.
- ▶ Avoid keeping a fixed image on the screen for a long period of time. The fixed image could become permanently imprinted on the screen.
- ▶ The synchronization input form for Horizontal and Vertical frequencies is separate.
- ▶ Depending on the graphics card, some resolution settings may not allow the image to be positioned on the screen properly.

Supported Display Specifications**RGB-PC**

Resolution	Horizontal Frequency(kHz)	Vertical Frequency(Hz)
720x400	31.469	70.08
640x480	31.469	59.94
	37.861	72.80
800x600	37.879	60.31
	48.077	72.18
1024x768	48.363	60.00
	56.476	70.06
1280x768	47.776	59.870
	60.289	74.893
1360x768	47.712	60.015
	63.981	60.020
1280x1024	79.976	75.025
1920x1080	66.587	59.934

Except 32/37/42LG710H, 32LD65H,
32LD655H, 32LD660H,
32LD665H, 32LV555H

HDMI-PC

Resolution	Horizontal Frequency(kHz)	Vertical Frequency(Hz)
720x400	31.469	70.08
800x600	35.156	56.25
	37.879	60.31
1024x768	48.363	60.00
1280x768	47.776	59.87
1360x768	47.712	60.015
1280x1024	63.981	60.02
1920x1080	67.500	60.000









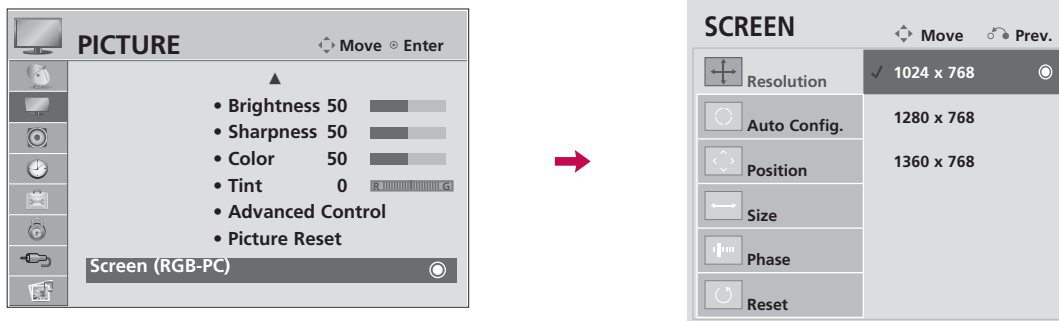

EXTERNAL EQUIPMENT SETUP

Screen Setup for PC mode

Selecting Resolution

When using RGB-PC input, change the resolution in the menus to match the PC's. The Position, Phase, and Size can also be adjusted.









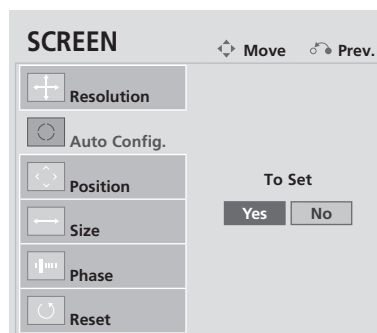
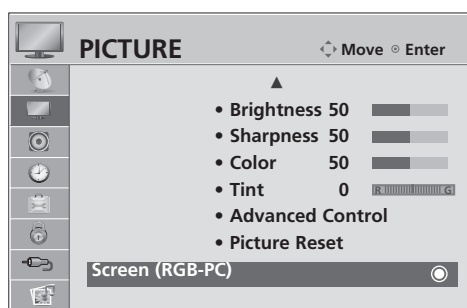



- 1   or   Select **PICTURE**.
- 2   Select **Screen (RGB-PC)**.
- 3   Select **Resolution**.
- 4   Select the desired resolution.
- 5 

Auto Configure

Automatically adjusts picture position and minimizes image instability. After adjustment, if the image is still not correct, try using the manual settings or a different resolution or refresh rate on the PC.



- 1   or   Select **PICTURE**.
- 2   Select **Screen (RGB-PC)**.
- 3   Select **Auto config.**
- 4   Select **Yes**.
- 5 

- If the position of the image is still not correct, try Auto adjustment again.
- If picture needs to be adjusted again after Auto adjustment in RGB-PC, you can adjust the **Position**, **Size** or **Phase**.











EXTERNAL EQUIPMENT SETUP

Adjustment for screen Position, Size, and Phase

If the picture is not clear after auto adjustment and especially if characters are still trembling, adjust the picture phase manually.

This feature operates only in RGB-PC mode.



- 1   or   Select **PICTURE**.
- 2   Select **Screen (RGB-PC)**.
- 3   Select **Position, Size, or Phase**.
- 4   Make appropriate adjustments.
- 5 









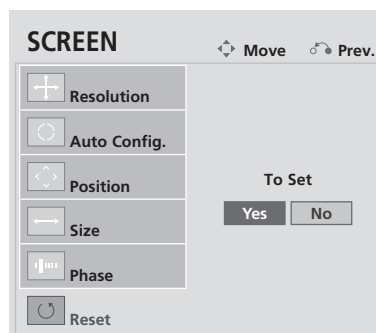
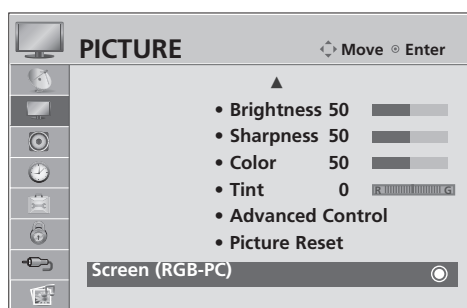



- **Position:** This function is to adjust picture to left/right and up/down as you prefer.
- **Size:** This function is to minimize any vertical bars or stripes visible on the screen background. And the horizontal screen size will also change.
- **Phase:** This function allows you to remove any horizontal noise and clear or sharpen the image of characters.

Screen Reset (Reset to original factory values)

Returns Position, Size, and Phase to the default factory settings.

This feature operates only in RGB-PC mode.



- 1   or   Select **PICTURE**.
- 2   Select **Screen (RGB-PC)**.
- 3   Select **Reset**.
- 4    Select **Yes**.
- 5 

WATCHING TV / CHANNEL CONTROL

REMOTE CONTROL FUNCTIONS

When using the remote control, aim it at the remote control sensor on the TV.

- POWER** Turns your TV or any other programmed equipment on or off, depending on mode.
- TV/STB/DVD/VCR** Selects the remote's operating mode: TV, STB, DVD, or VCR.
- GUIDE** Displays and removes the electronic channel guide. This key works only in GEM or Flash environment.
- PORTAL** Displays and removes the hotel interactive menu. This key works only in GEM or Flash environment.
- INFO** Displays information about the selected or current events. This key works only in GEM or Flash environment.

- NUMBER button** Selects channel numbers or other numbers required. Also supports characters.
- (DASH)** Selects a program number for multiple program channels such as 2-1, 2-2, etc.
- FLASH BK** Tunes to the last channel or input viewed.
- VCR/DVD/USB control buttons** Controls video cassette recorders or DVD players or USB.
- PIP** Toggles through picture-in-picture options.
- RATIO** Changes the aspect ratio. ▶ **p.73**
- TIMER** Turns the TV off in a set amount of time. ▶ **p.100**
- SAP**
 - Analog mode: Selects MTS sound (Mono, Stereo, or a SAP). ▶ **p.90**
 - DTV mode: Changes the audio language.
- PIP CH +/-** Changes the PIP channel.
- PIP SWAP** Exchanges the main/sub images.
- PIP INPUT** Selects the connected input source for the sub-picture.

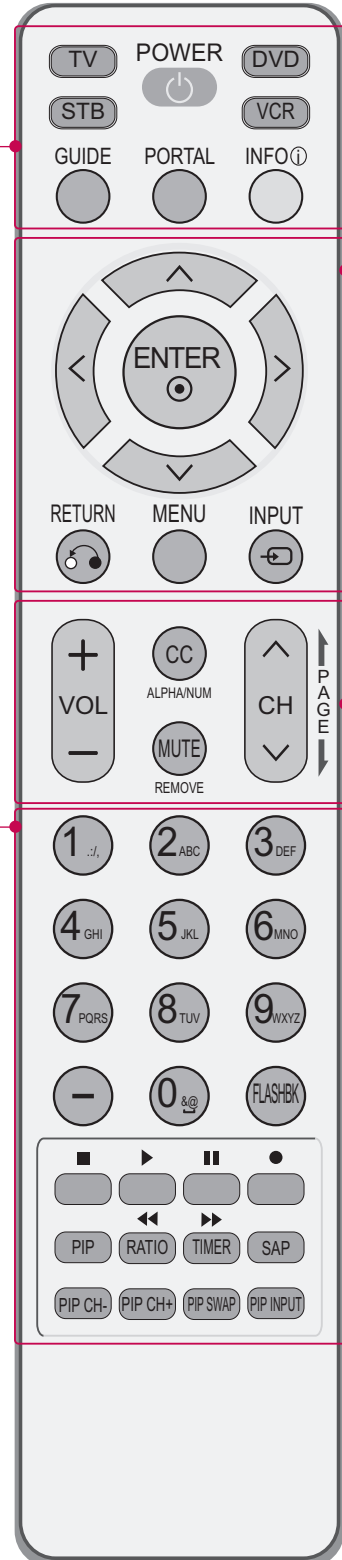

THUMBSTICK (Up/Down/Left Right/ENTER) Navigates the on-screen menus and adjusts the system settings to your preference.

RETURN Clears all on-screen displays and returns to TV viewing from any menu.

MENU Displays the main menu.

INPUT Rotates through inputs.
Also switches the TV on from standby.

VOLUME UP /DOWN Adjusts the volume.

CC Selects a closed caption. ▶ p.93

MUTE Switches the sound on or off. ▶ p.53

CHANNEL UP/DOWN Selects available channels.

PAGE UP/DOWN Moves from one full set of screen information to the next one.

Installing Batteries

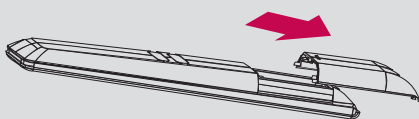

- Open the battery compartment cover on the back side and install the batteries with the correct polarity (+with +,-with -).
- Install two 1.5V AAA batteries. Don't mix old or used batteries with new ones.
- Close cover.

WATCHING TV / CHANNEL CONTROL

TURNING ON THE TV

-
- 1** First, connect the power cord correctly.
At this moment, the TV switches to standby mode.
 - In standby mode to turn TV on, press the **⏻** button on the TV or press the **POWER** button on the remote control.
 - 2** Select the viewing source by using the **INPUT** button on the remote control.
 - 3** When finished using the TV, press the **POWER** button on the remote control. The TV reverts to standby mode.
-

! NOTE

- ▶ If you intend to be away on vacation, disconnect the power plug from the wall power outlet.

CHANNEL SELECTION

-
- 1 Press the **CH**(^ or v) or **NUMBER** buttons to select a channel number.
-

VOLUME ADJUSTMENT

Adjust the volume to suit your personal preference.

-
- 1 Press the **VOL (+ or -)** button to adjust the volume.
 - 2 If you want to switch the sound off, press the **MUTE** button.
 - 3 You can cancel the Mute function by pressing the **MUTE** or **VOL (+ or -)** button.
-

WATCHING TV / CHANNEL CONTROL

ON-SCREEN MENUS SELECTION

Your TV's OSD (On Screen Display) may differ slightly from that shown in this manual.

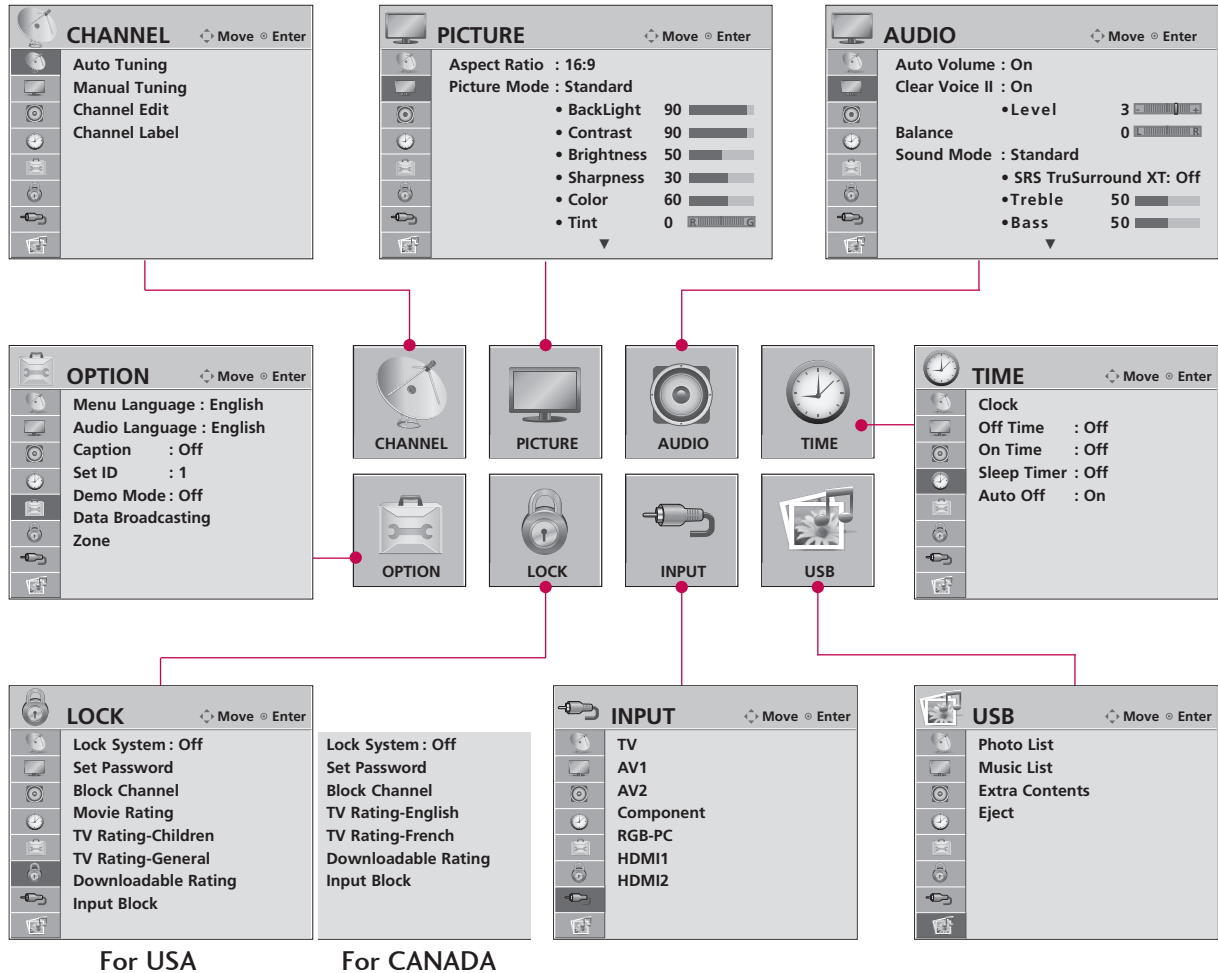

- 1 or Display each menu.
- 2 Select a menu item.
- 3 Accept the current selection.
- 4 or Return to TV viewing.

! NOTE

- ▶ **Infinite Sound:** For 32/37/42/47/55LD650H, 32/37/42LD655H, 32/37/42LD660H, 32/37/42LD665H, 32/37/42/47/55LV555H
- ▶ **Data Broadcasting:** For 32/37/42LG710H, 32/37/42/47/55LD650H, 32/37/42LD655H
- ▶ **Zone:** For 32/37/42LD660H, 32/37/42LD665H, 32/37/42/47/55LV555H









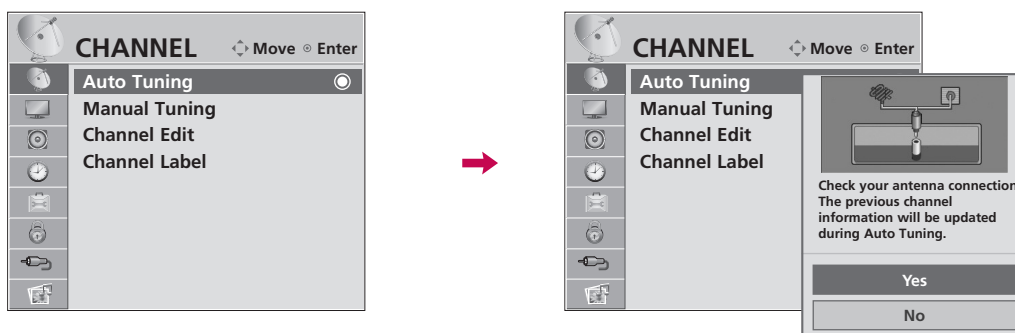



CHANNEL SETUP

Auto Scan (Auto Tuning)

Automatically finds all channels available through antenna or cable inputs and stores them in memory on the channel list.

Run Auto Tuning again after any Antenna/Cable connection changes.



- 1   or   Select **CHANNEL**.
- 2   Select **Auto Tuning**.
- 3   Select **Yes**.
- 4  Run **Auto tuning**.
- 5  Return to the previous menu.
 or  Return to TV viewing.









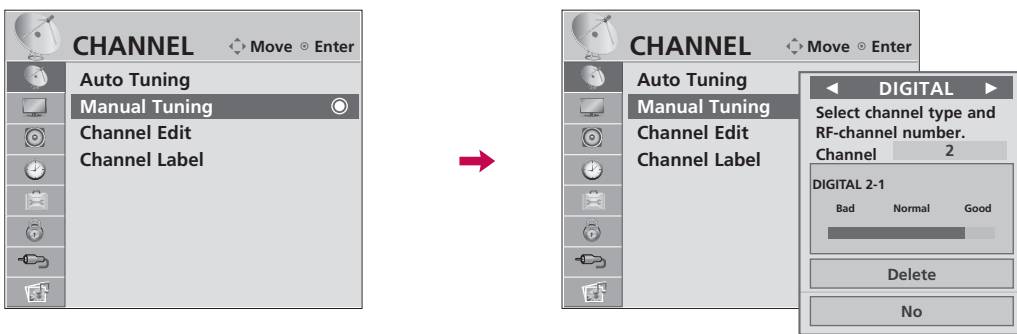





■ A password is required to gain access to Auto Tuning menu if the Lock System is turned on.

WATCHING TV / CHANNEL CONTROL

Add/Delete Channel (Manual Tuning)

If selecting DIGITAL input signal, you can view the on-screen signal strength monitor to see the quality of the signal being received.



- 1   or   Select **CHANNEL**.
- 2   Select **Manual Tuning**.
- 3   Select **DIGITAL** or **ANALOG**.
- 4   Select channel you want to add or delete.
- 5   Select **Add** or **Delete**.
- 6  Return to the previous menu.
 or  Return to TV viewing.









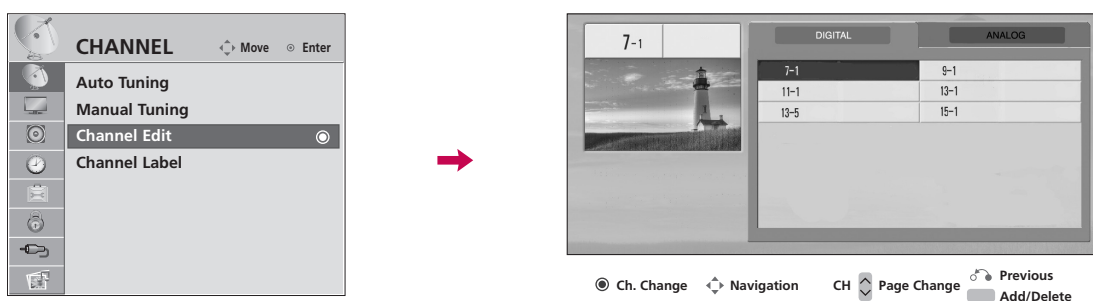



■ A password is required to gain access to Manual Tuning menu if the Lock System is turned on.

Channel Editing

The channels in the Channel Edit List are displayed in black and the channels deleted from the Channel Edit List are displayed in blue.

When a channel number is deleted, it means that you will be unable to select it using **CH** \wedge \vee button during TV viewing. If you wish to select the deleted channel, directly enter the channel number with the **NUMBER** buttons or select it in the **Channel Edit** menu.



- 1   or   Select **CHANNEL**.
 - 2   Select **Channel Edit**.
 - 3   Select a channel.
 - 4  Select channel you want to add or delete.
 - 5  Return to the previous menu.
-  or  Return to TV viewing.









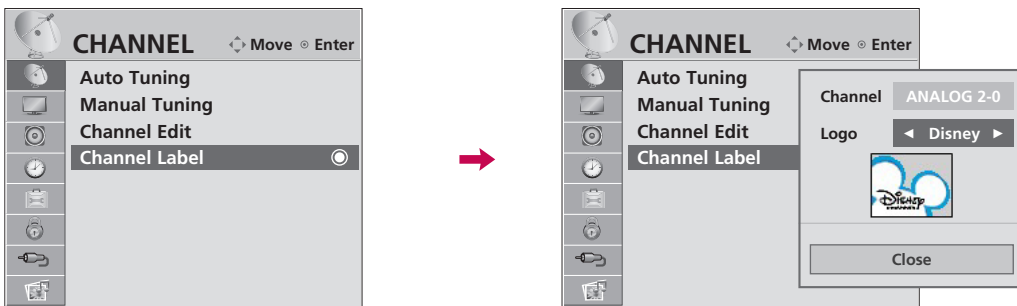





WATCHING TV / CHANNEL CONTROL

CHANNEL LABEL

Choose preset labels for your channels.

If a channel label is provided on the signal from the broadcasting station, the TV displays a short name for a channel even if you didn't preset a label for the channel.



- 1   or   Select **CHANNEL**.
 - 2   Select **Channel Label**.
 - 3   Select a channel.
 - 4  Select a channel to set logo.
 - 5   Select the appropriate logo for the channel.
 - 6  Return to the previous menu.
-  or  Return to TV viewing.

INPUT LIST

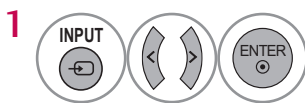

Select the desired input source.

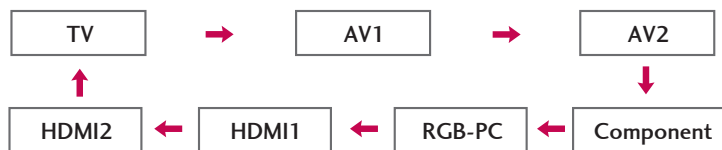



- **TV:** Select it to watch over-the-air, cable and digital cable broadcasts.
- **AV1 -2:** Select them to watch a VCR or other external equipment.
- **Component:** Select them to watch DVD or a Digital set-top box.
- **RGB-PC:** Select it to view PC input.
- **HDMI1 -2:** Select them to watch high definition devices.

WATCHING TV / CHANNEL CONTROL

EXAMPLE ELECTRONIC PROGRAM GUIDE

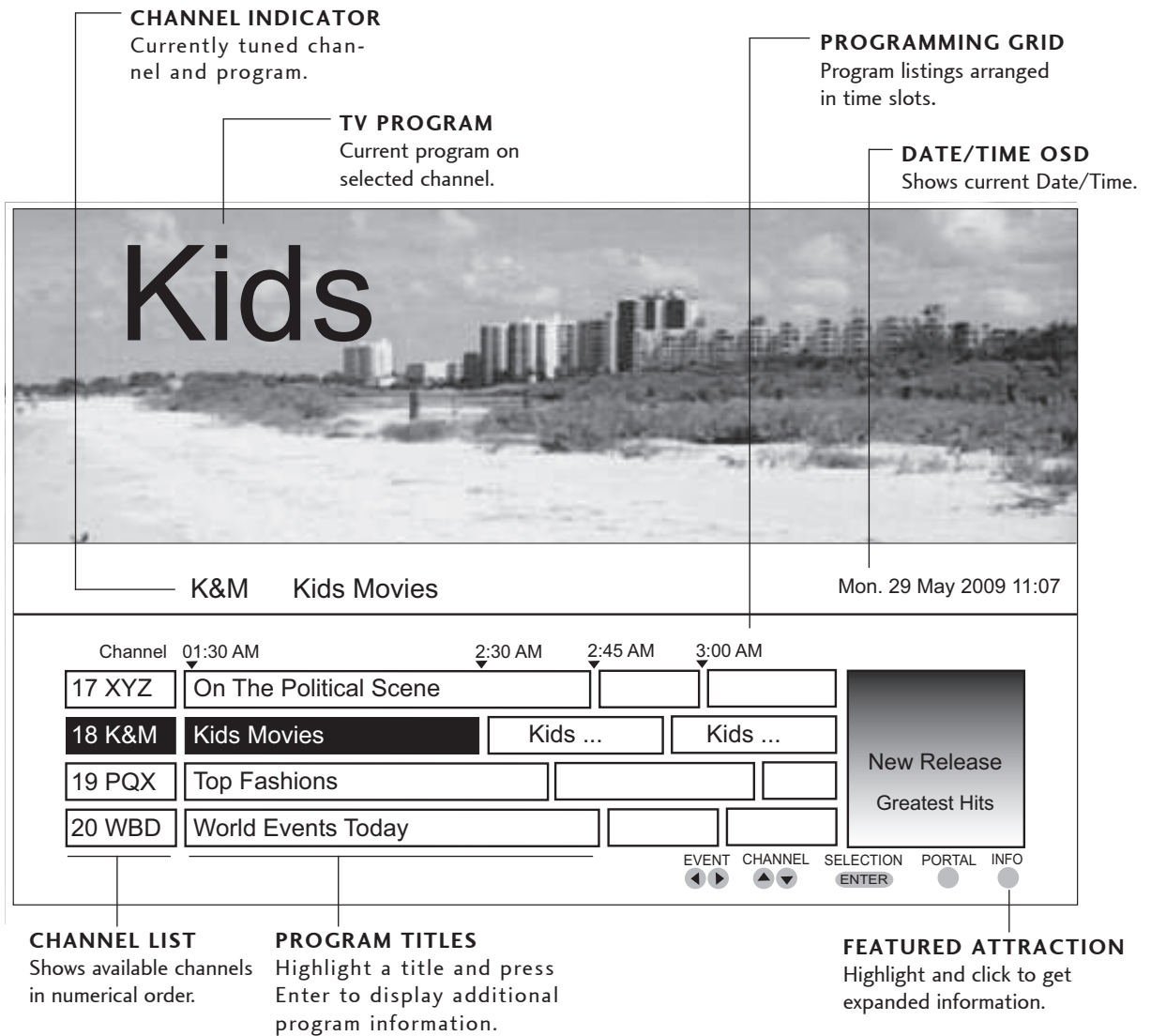
This is an example of a typical TV electronic program guide showing available programming.

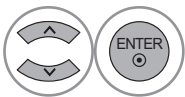

- 1  Select **GUIDE** button to shows available TV programs.
- 2  Select a channel.

USB

■ Image shown may differ from your TV.

ENTRY MODES

When you connect a USB device, this pop-up menu is displayed automatically.

When the Pop-Up menu does not appear, you can select Photo List or Music List on Extra contents.

On a USB device, you can not add a new folder or delete an existing folder.

1 Connect the USB device to the **USB IN** jack on the side of TV.

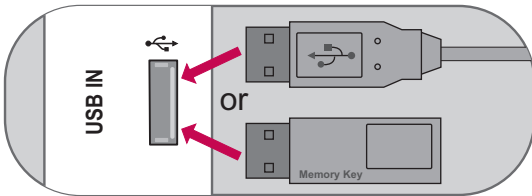

■ This TV supports playback of JPG pictures and MP3 audio.





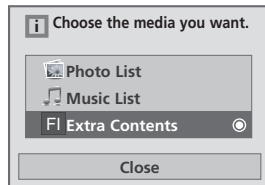



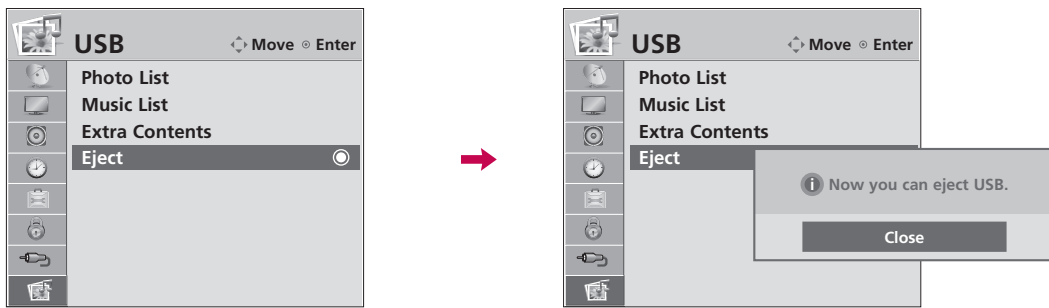



Select **PHOTO LIST**, **MUSIC LIST**, or **EXTRA CONTENTS**.



When removing the USB device



- 1   or   Select **USB**.
- 2   Select **Eject**.
- 3 
- 4  Return to the previous menu.
-  or  Return to TV viewing.

Precautions with USB devices.

- ▶ Only a USB storage device is recognizable.
- ▶ If the USB storage device is connected through a USB hub, the device is not recognizable.
- ▶ A USB storage device using an automatic recognition program may not be recognized.
- ▶ A USB storage device which uses its own driver may not be recognized.
- ▶ The recognition speed of a USB storage device may depend on each device.
- ▶ In case of a card reader, up to four memory cards are concurrently recognizable.
- ▶ Please do not turn off the TV or unplug the USB device when the connected USB storage device is working. When such device is suddenly separated or unplugged, the stored files or the USB storage device may be damaged.
- ▶ Only use a USB storage device which has normal music, image or movie files.
- ▶ Please connect power to a USB storage device (over 0.4A) which requires an external power supply. If not, the device may not be recognized.
- ▶ Please connect a USB storage device with cable is offered by USB maker. If connected with cable is not offered by USB maker or an excessively long cable, the device may not be recognized.
- ▶ Some USB storage devices may not be supported or operate properly.
- ▶ File alignment method of USB storage device is similar to Window XP and filename can recognize up to 100 English characters.
- ▶ Please backup important files because data on the USB device may be damaged. Data management is the consumer's responsibility and as a result, the manufacturer does not cover data damage.
- ▶ Please use only a USB storage device which was formatted as a FAT32, NTFS file system provided with the Windows operating system. In case of a storage device formatted as a different utility programme which is not supported by Windows, it may not be recognized.
- ▶ Data in a USB storage device cannot be deleted in the NTFS file system.
- ▶ If your USB memory device has multiple partitions, or if you use a USB multi-card reader, you can use up to 4 partitions or USB memory devices.
- ▶ The recommended capacity is 1 TB or less for a USB external hard disk and 32GB or less for USB memory.
- ▶ Any device with more than the recommended capacity may not work properly.
- ▶ When using a USB HDD via the USB extending cable, connect a support electric power source.

PHOTO LIST

This TV only supports picture in JPEG(.jpg) format.
The On-Screen Display on your model may be slightly different.

Supported photo file: *.JPG

- You can view JPG files only.
- Only baseline scan is supported among JPG.
- Supported JPG size: 64 pixel (width) x 64 pixel (height) to 15360 pixel (width) x 8640 pixel (height)

Screen Components

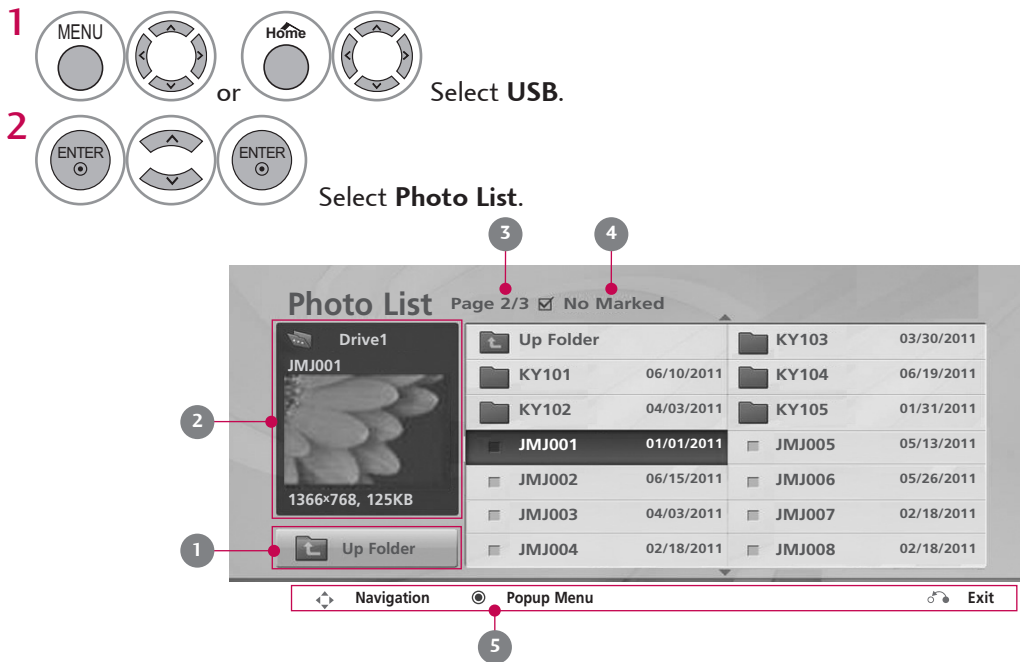

- 1 Moves to upper level folder
- 2 Preview: Displays the thumbnail/folder name of the photo in the selected folder
- 3 Current page/Total pages
- 4 Total number of marked photos
- 5 Corresponding buttons on the remote control

Photo Selection and Pop-up Menu

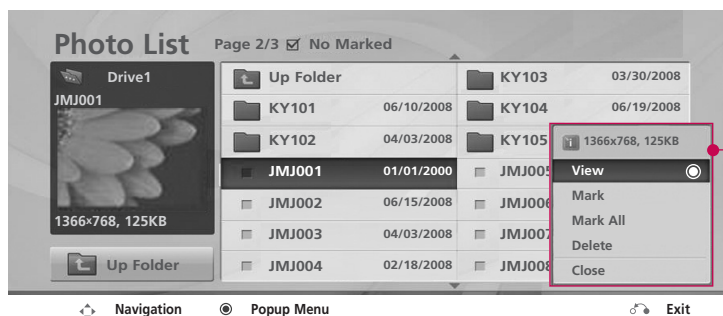
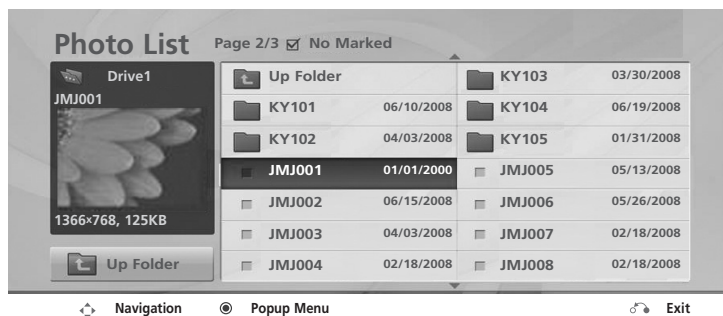

When you select a file (not folder), this Pop-Up menu is displayed.

- ▶ **View:** Display the selected item.
- ▶ **Mark:** Use to mark a photo.
- ▶ **Unmark:** Use to unmark a photo.
- ▶ **Mark All:** Mark all photos on the screen.
- ▶ **Unmark All:** Deselect all marked photos.
- ▶ **Delete or Delete Marked** : Delete the selected photo item.
- ▶ **Close:** Close the pop-up menu.

- 1 Select the target folder or drive.
- 2 Select the desired photos.
- 3 Show the Pop-up menu.
- 4 Select the desired Popup menu.

■ When one or more photos are marked, you can view individual photos or a slide show of the marked photos. If no photos are marked, you can view all photos individually or all photos in the folder in a slide show.

Full Screen Menu

You can change the Photo List view so that it fills the screen. More operations are available in full screen mode.

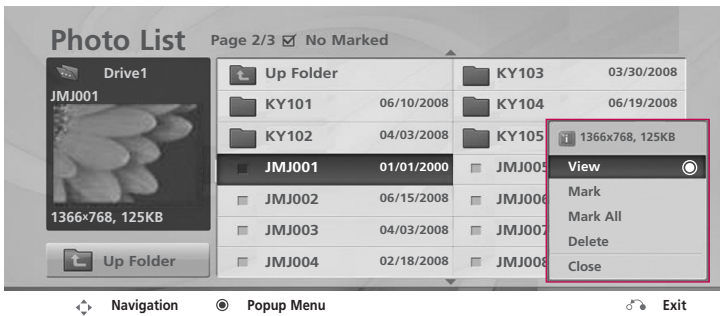
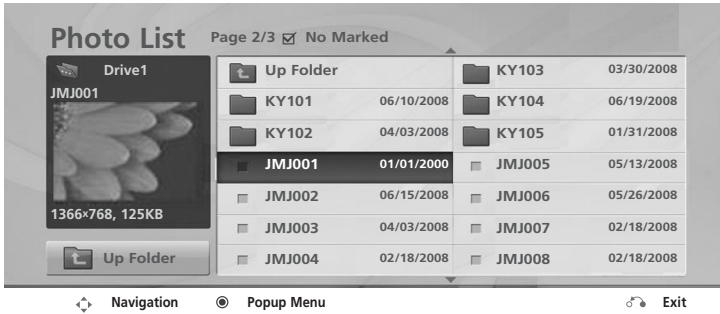

The aspect ratio of a photo may change the size of the photo displayed on the screen in full size. Press the **RETURN** button to move to the previous menu screen.

- 1 Select the target folder or drive.
- 2 Select the desired photos.
- 3 Show the Pop-up menu.
- 4 Select **View**.
- 5 The selected photo is displayed in full size.

■ Use the **CH[^]∨** button to navigate in the photo page.

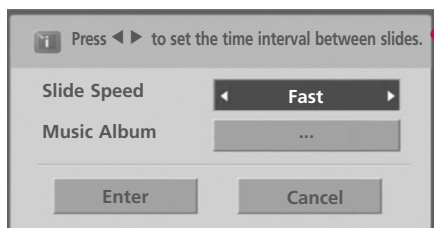

- ▶ **Slideshow:** Selected photos are displayed during the slide show. If no photo is selected, all photos in the current folder are displayed during slide show.
 - Set the time interval of the slide show in **Option**.
- ▶ **BGM:** Listen to music while viewing photos in full size.
 - Set the BGM device and album in **Option**.
- ▶ **⤿ (Rotate):** Rotate photos.
 - Rotates the photo 90°, 180°, 270°, 360° clockwise.
- ▶ **Delete:** Delete photos.
- ▶ **Option:** Set values for **Slide Speed** and **Music Album**.
 - Use ^ v < > button and **ENTER** button to set values. Then go to **Enter** and press **ENTER** to save the settings.
 - You cannot change **Music Album** while BGM is playing.
- ▶ **Hide:** Hide the menu on the full-sized screen.
 - To see the menu again on the full-sized screen, press **ENTER** button to display.

6

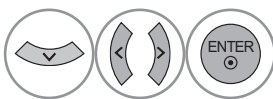

Select the **Slideshow**, **BGM**, **⤿ (Rotate)**, **Delete**, **Option**, or **Hide**.

- Use < > button to select the previous or next photo.
- Use ^ v < > button to select and control the menu on the full-sized screen.

MUSIC LIST

You can use the Music List menu to play MP3 files from a USB storage device.

This TV cannot play back copy-protected files.

The On-Screen Display on your model may be slightly different.

Supported music file: *.MP3

Bit rate range 32 Kbps - 320 Kbps

• Sampling rate (Sampling Frequency)

MPEG1 layer 3: 32 kHz, 44.1 kHz, 48 kHz

MPEG2 layer 3: 16 kHz, 22.05 kHz, 24 kHz

MPEG2.5 layer 3: 8 kHz, 11.025 kHz, 12 kHz

USB

Screen Components

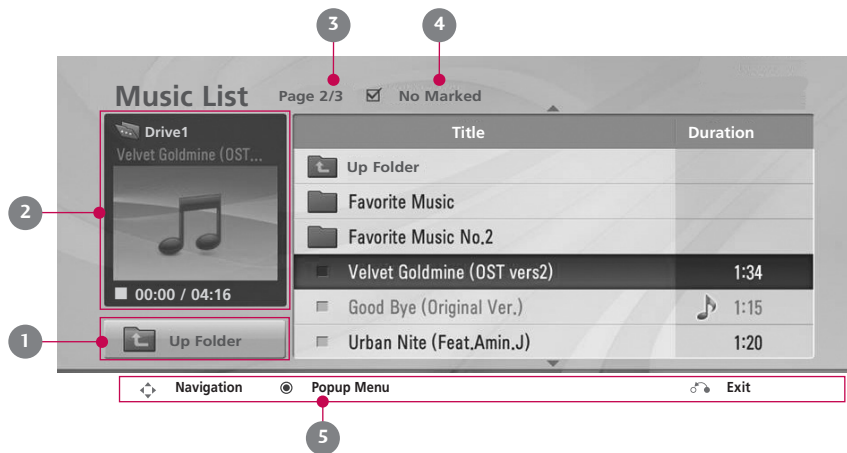
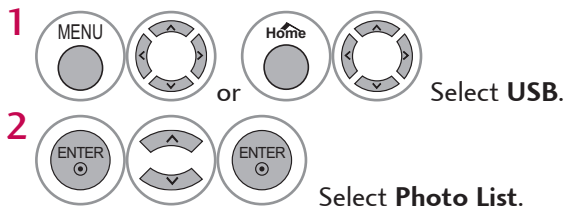



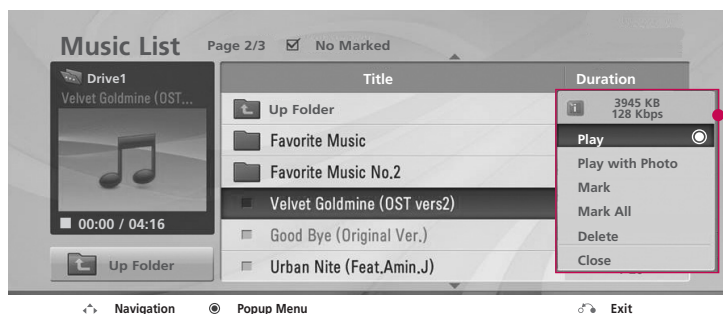
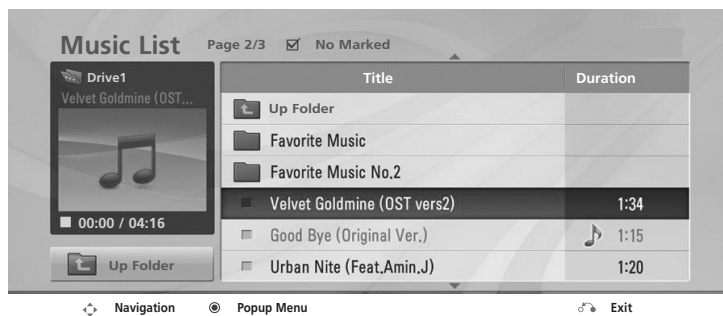

- 1 Moves to upper level folder
- 2 Preview: If a supported picture of the album jacket is in the file, it will be displayed here.
- 3 Current page/Total pages
- 4 Total number of marked files
- 5 Corresponding buttons on the remote control

Music Selection and Pop-up Menu

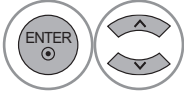

- ▶ **Play** (During stop): Play the selected file. Once a song finishes playing, the next selected one will be played. When there are no selected files to play, the next one in the current folder will be played. If you go to a different folder and press the **ENTER** button, the current song in playback will stop.
- ▶ **Play Marked**: Play the selected files. Once a file finishes playing, the next selected one will be played automatically.
- ▶ **Stop Play** (During playback): Stop the playing files.
- ▶ **Play with Photo**: Start playing the selected files and then move to the Photo List.
- ▶ **Mark**: Use to mark a file.
- ▶ **Unmark**: Use to unmark a file.
- ▶ **Mark All**: Mark all files in the folder.
- ▶ **Unmark All**: Deselect all marked files.
- ▶ **Delete** or **Delete Marked**: Delete the selected files.
- ▶ **Close**: Close the pop-up menu.

- 1  Select the target folder or drive.
- 2  Select the desired musics.
- 3  Show the Pop-up menu.
- 4  Select the desired Pop-up menu.
- 5  Return to TV viewing.

- Use the **CH** ^ v button to navigate in the music page.
- If no music is marked, all the music in the folder will be played in sequence. When one or more music files are marked, the marked music files will be played in sequence. If you want to listen to only one song repeatedly, just mark that one file and play.

- The play information box (as shown below) will automatically move across the screen when there is no user input to prevent a fixed image remaining on the screen for an extended period of time.



NOTE

- ▶ When music is playing, is displayed in front of the music play time.
- ▶ A damaged or corrupted music file that does not play displays 00:00 as the play time.
- ▶ Files downloaded from a paid service with copyright protection are not supported and will not play.
- ▶ Press **ENTER**, **■**, or **RETURN** button to stop the screen saver.

EXTRA CONTENTS

Extra Contents will be activated when Data Channel service is available.

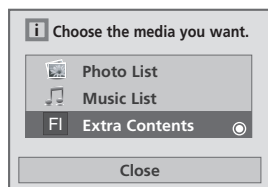

- 1 or Select **USB**.
- 2 Select **Extra Contents**.

NOTE

- ▶ Pro: Centric contents in USB memory stick can be played.
- ▶ For more information, contact to Customer Support.(www.lgcommercial.com)

PICTURE CONTROL

PIP (PICTURE-IN-PICTURE)

PIP enables the end user to view two sources on the screen at the same time. The end user can switch between the Main and Sub picture sizes.

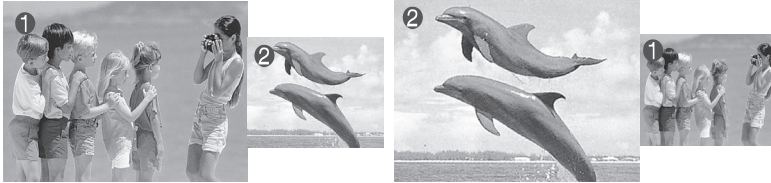

NOTE

► Actual size of Main screen and PIP inset may be different than shown above.

PIP Operation

1. Connect auxiliary source(s) to TV connections panel.
2. Enter Installer menu to be sure source(s) is enabled.
3. Use the interactive remote provided in the room to operate PIP.
4. Press PIP on remote. Use the PIP function keys to operate the available PIP features.
5. To exit PIP mode, simply press PIP.

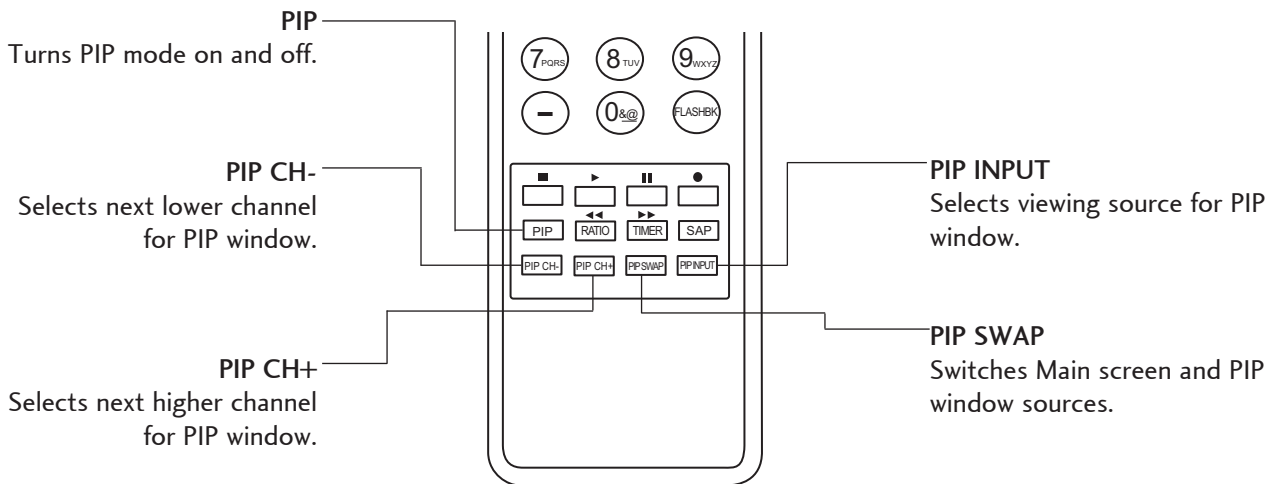

PICTURE CONTROL

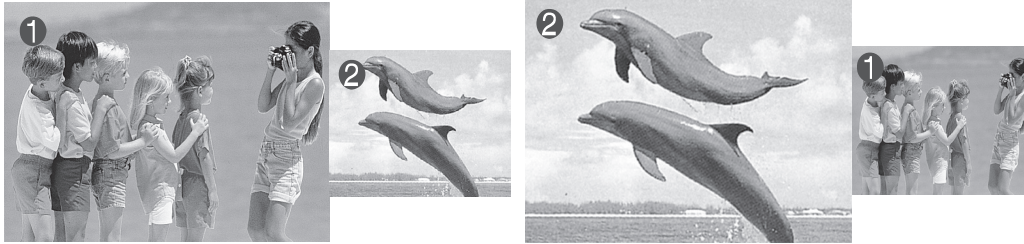



Main Picture Source	Available Sub Picture Sources
TV	AV1, AV2, HDMI1, HDMI2
AV1 or AV2	TV, AV1 or AV2, HDMI1, HDMI2
HDMI1 or HDMI2	TV, AV1, AV2, HDMI1 or HDMI2
Component, RGB-PC	TV, AV1, AV2, HDMI1, HDMI2

PICTURE SIZE (ASPECT RATIO) CONTROL

This feature lets you choose the way an analog picture with a 4:3 aspect ratio is displayed on your TV.

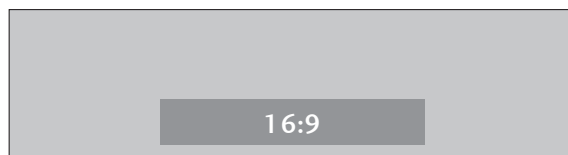
- RGB-PC input source can only use 4:3 or 16:9 aspect ratio.



-  Press the **RATIO** button repeatedly to select the picture options : **Set By Program, 4:3, 16:9, Zoom, Just Scan.**

-  Return to TV viewing.

■ You can also adjust **Aspect Ratio** in the **PICTURE** menu.

PICTURE CONTROL

Set by program

Selects the proper picture proportion to match the source's image.

(4:3 → 4:3)



(16:9 → 16:9)



4:3

Choose 4:3 when you want to view a picture with an original 4:3 aspect ratio.



16:9

Adjust the picture horizontally, in a linear proportion to fill the entire screen.



Zoom

Choose Zoom when you want to view the picture without any alteration. However, the top and bottom portions of the picture will be cropped.

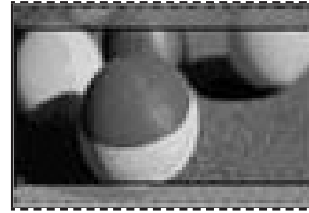

Just Scan

Normally the edges of video signals are cropped 1-2%. Just Scan turns off this cropping and shows the complete video.

Notes: If there is noise on the edges of the original signal, it will be visible when Just Scan is activated.









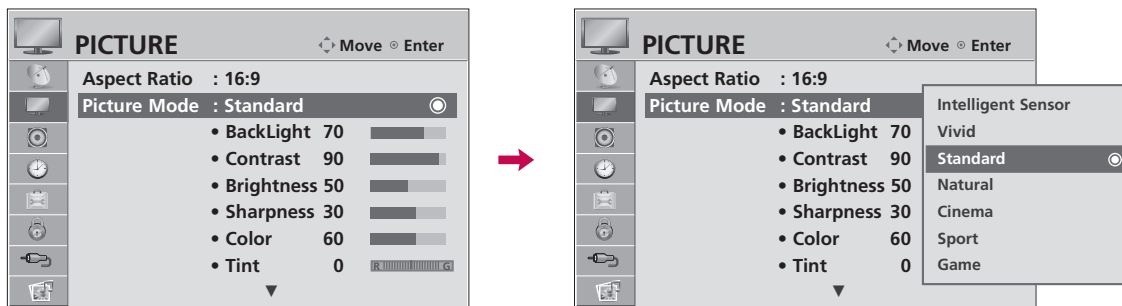

Just Scan operates only with DTV/CADTV/HDMI-DTV/DVI-DTV (720p/1080i), Component(720p/1080i) input sources.



PRESET PICTURE SETTINGS (PICTURE MODE)

There are factory presets for picture settings available in the user menus.
You can use a preset, change each setting manually, or use the Intelligent Sensor.



- 1   or   Select **PICTURE**.
- 2   Select **Picture Mode**.
- 3   Select **Intelligent Sensor, Vivid, Standard, Natural, Cinema, Sport or Game**.
- 4  Return to the previous menu.
 or  Return to TV viewing.









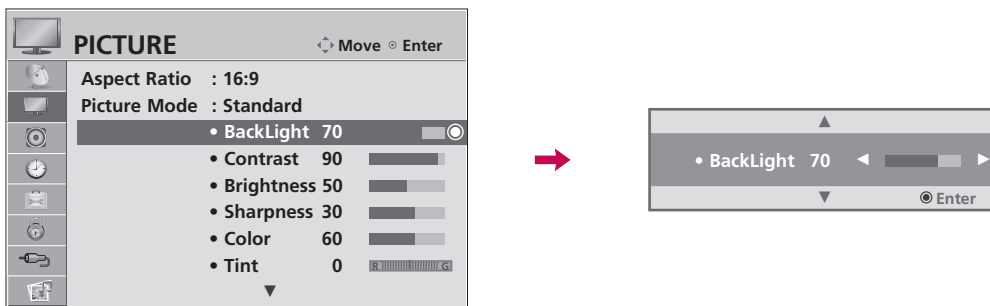





- When selecting **Intelligent Sensor** is changed to **Auto** automatically.
- When selecting **Intelligent Sensor**, it is changed contrast, brightness, sharpness, color and tint automatically.
- **Vivid, Standard, Natural, Cinema, Sport,** and **Game** Settings are preset for the optimum picture quality at the factory.
- **Intelligent Sensor:** The most suitable picture is automatically adjusted according to the surrounding conditions.
- **Vivid:** This is the mode to maximize the effect of the video in the retail store. Strengthen the contrast, brightness, color and sharpness for vivid picture.
- **Standard:** This is the mode to realize optimum viewing condition for the general user.
- **Natural:** This is the mode to display the most natural screen status.
- **Cinema:** This mode optimizes video for watching movies.
- **Sport:** This is the video mode to emphasize dynamic video and primary color (e.g. white, uniform, grass, sky blue etc.) by realizing the optimal screen for sports.
- **Game:** This is the mode to realize fast response speed in a fast gaming screen.

PICTURE CONTROL

MANUAL PICTURE ADJUSTMENT - USER MODE

Adjust the picture appearance to suit your preference and viewing situations.
This feature is disabled in "Picture Mode-Intelligent Sensor".











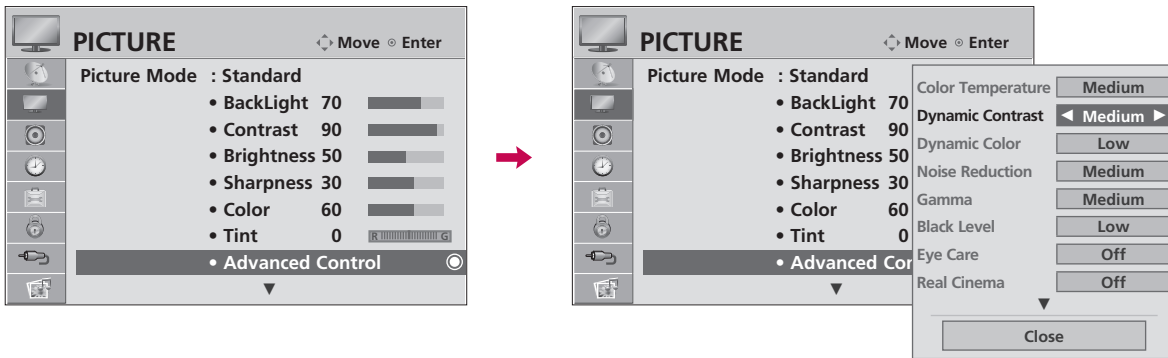



- 1   or   Select **PICTURE**.
- 2   Select **Picture Mode**.
- 3   Select **Vivid, Standard, Natural, Cinema, Sport or Game**.
- 4   Select **Backlight, Contrast, Brightness, Sharpness, Color, or Tint**.
- 5   Make appropriate adjustments.
- 6  Return to the previous menu.
-  or  Return to TV viewing.

- **Backlight:** This function adjusts the brightness of LCD panel, to control the brightness of the screen. Adjusting the backlight is recommended when setting the brightness of the set. When decreasing the backlight, the brightness of the black becomes darker without any loss in video signal and the power consumption is reduced.
- **Contrast:** Increase or decrease the gradient of the video signal. You may use Contrast when the bright part of picture is saturated.
- **Brightness:** Adjusts the base level of the signal in the picture. You may use Brightness when the dark part of the picture is saturated.
- **Sharpness:** Adjusts the level of crispness in the edges between the light and dark areas of the picture. The lower the level, the softer the image.
- **Color:** Adjusts intensity of all colors.
- **Tint:** Adjusts the balance between red and green levels.

PICTURE IMPROVEMENT TECHNOLOGY

You can calibrate the screen for each Picture Mode or set the video value according to the special video screen. You can set the video seeing differently for each input. To reset to the factory default after making adjustments to each input source, execute the **Picture Reset** function for each **Picture Mode**.



- 1   or   Select **PICTURE**.
 - 2   Select **Advanced Control**.
 - 3   Select your desired options.
 - 4  Make appropriate adjustments.
 - 5  Return to the previous menu.
-  or  Return to TV viewing.









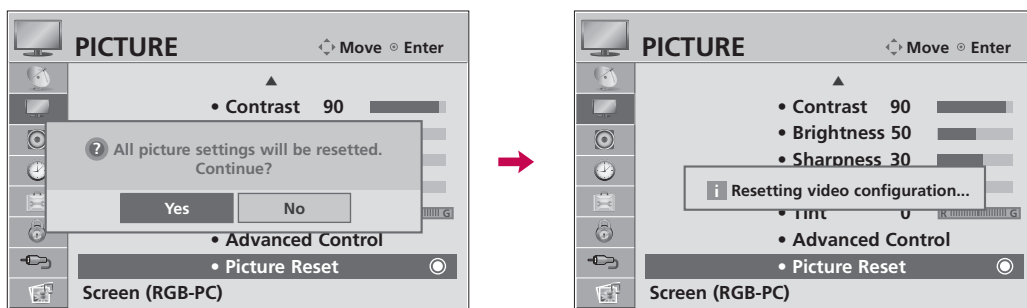

PICTURE CONTROL

Color Temperature	<ul style="list-style-type: none"> ■ Set to warm to enhance hotter colors such as red, or set to cool to enhance cooler colors such as blue.
Dynamic Contrast	<ul style="list-style-type: none"> ■ Adjusts the contrast to keep it at the best level according to the brightness of the screen. The picture is improved by making bright parts brighter and dark parts darker.
Dynamic Color	<ul style="list-style-type: none"> ■ Adjusts screen colors so that they look livelier, richer and clearer. This feature enhances hue, saturation and luminance so that red, blue, green and white look more vivid.
Noise Reduction	<ul style="list-style-type: none"> ■ Reduces screen noise without compromising video quality.
Gamma	<p>Low : Make dark and middle gray level area of the picture brighter. Medium: Express original picture levels. High: Make dark and middle gray level area of the picture darker.</p> <ul style="list-style-type: none"> ■ You can adjust brightness of dark area and middle gray level area of the picture.
Black Level	<p>Low: The reflection of the screen gets darker. High: The reflection of the screen gets brighter.</p> <ul style="list-style-type: none"> ■ Set black level of the screen to proper level. ■ This function enables to select 'Low' or 'High' in the following mode: AV (NTSC-M), HDMI or Component.
Eye Care	<ul style="list-style-type: none"> ■ Adjust the brightness of the screen to prevent the screen from being too bright. Dims extremely bright pictures. ■ This feature is disabled in "Picture Mode-Intelligent Sensor, Vivid, Cinema".
Real Cinema	<ul style="list-style-type: none"> ■ Makes video clips recorded in film look more natural by eliminating judder effect.
TruMotion (Depending on model)	<p>High: Provides smoother picture movement. Low: Provides smooth picture movement. Use this setting for standard use. Off: Turn off TruMotion operation.</p> <ul style="list-style-type: none"> ■ Advance video technology that provides clearer, smoother images, even during fast action scenes creating a more stable structure for a crisper picture. ■ TruMotion works with all inputs except PC mode. ■ If you enable "TruMotion", noise may appear on the screen. If this occurs, set "TruMotion" to "Off". ■ If you select "Picture Mode-Game", set "TruMotion" to "Off".
Color Gamut	<p>Standard: Displays standard set of colors. Wide: Increase number of colors used.</p> <ul style="list-style-type: none"> ■ Maximize the utilization of color to increase color quality.

PICTURE RESET

Settings of the selected picture modes return to the default factory settings.





- 1   or   Select **PICTURE**.
- 2   Select **Picture Reset**.
- 3   Select **Yes**.
- 4  Initialize the adjusted value.
- 5  or  Return to TV viewing.

PICTURE CONTROL

DEMO MODE

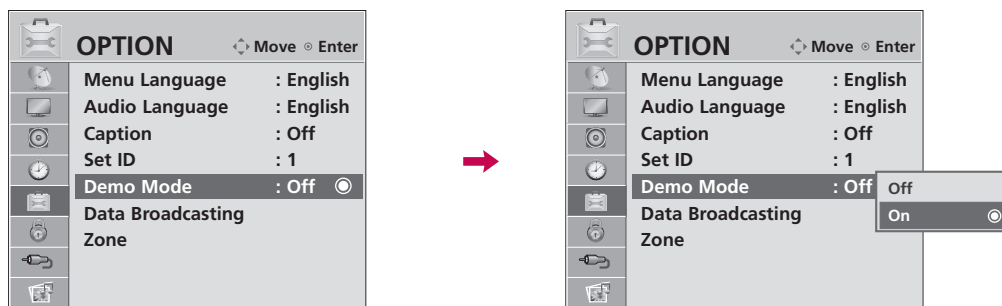
Displays a slide show to explain the various features of this TV.

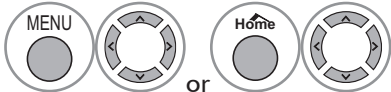
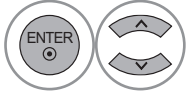

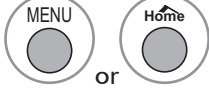
-  Select **OPTION**.
-  Select **Demo Mode**.
-  Select **On** to show the various feature of the TV.
-  Return to TV viewing.
After a while, **Demo Mode** starts.
If you want to stop the demo, press any button
(Except VOL +, - and MUTE button).

! NOTE

- ▶ **Data Broadcasting:** For 32/37/42LG710H, 32/37/42/47/55LD650H, 32/37/42LD655H
- ▶ **Zone:** For 32/37/42LD660H, 32/37/42LD665H, 32/37/42/47/55LV555H









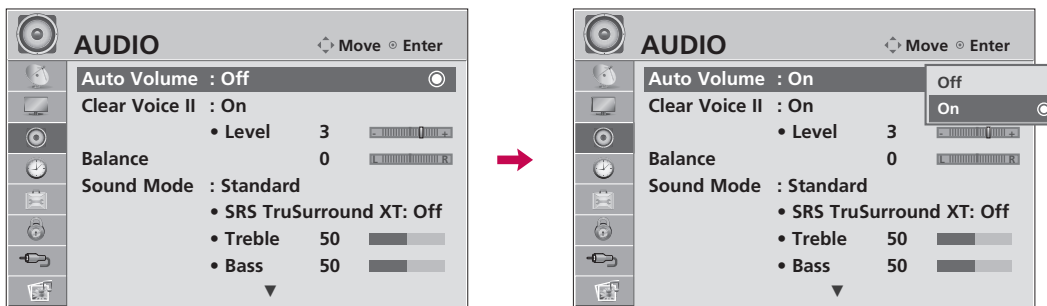

SOUND & LANGUAGE CONTROL

AUTO VOLUME LEVELER (AUTO VOLUME)

Auto Volume makes sure that the volume level remains consistent whether you are watching a commercial or a regular TV program.

Because each broadcasting station has its own signal conditions, volume adjustment may be needed every time the channel is changed. This feature allows users to enjoy stable volume levels by making automatic adjustments for each program.











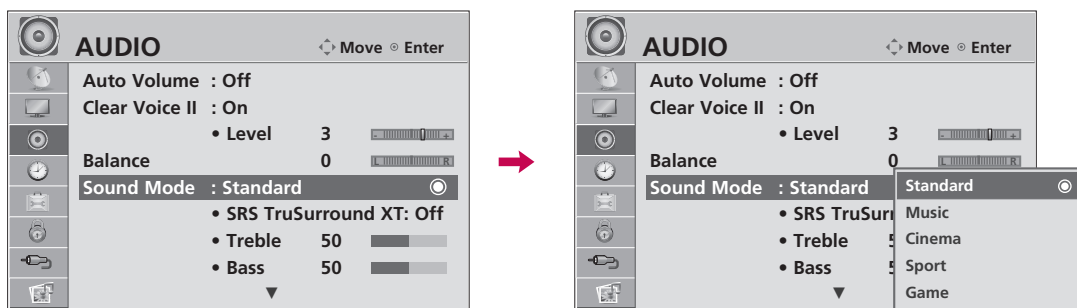



- 1   or   Select **AUDIO**.
- 2   Select **Auto Volume**.
- 3   Select **On** or **Off**.
- 4  Return to the previous menu.
-  or  Return to TV viewing.

SOUND & LANGUAGE CONTROL

PRESET SOUND SETTINGS (SOUND MODE)

Sound Mode lets you enjoy the best sound without any special adjustment as the TV sets the appropriate sound options based on the program content.











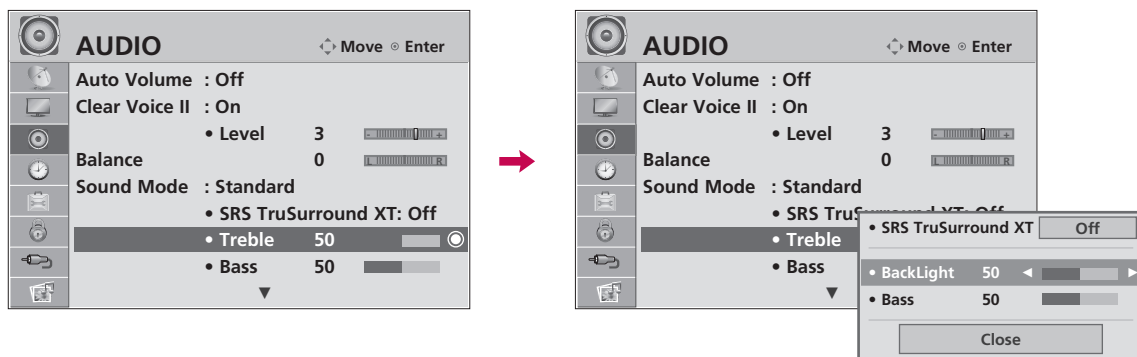







-   or   Select **AUDIO**.
-   Select **Sound Mode**.
-   Select **Standard, Music, Cinema, Sport, or Game**.
-  Return to the previous menu.
 or  Return to TV viewing.

- **Standard, Music, Cinema, Sport, and Game** are preset for optimum sound quality at the factory.
- **Standard:** Offers standard-quality sound.
- **Music:** Optimizes sound for listening to music.
- **Cinema:** Optimizes sound for watching movies.
- **Sport:** Optimizes sound for watching sports events.
- **Game:** Optimizes sound for playing games.

SOUND SETTING ADJUSTMENT - USER MODE

Adjust the sound to suit your taste and room situations.



- 1   or   Select **AUDIO**.
 - 2   Select **Sound Mode**.
 - 3   Select **Standard, Music, Cinema, Sport, or Game**.
 - 4   Select **Treble** or **Bass**.
 - 5   Make appropriate adjustments.
 - 6  Return to the previous menu.
-  or  Return to TV viewing.

SOUND & LANGUAGE CONTROL

SRS TRUSURROUND XT / INFINITE SOUND





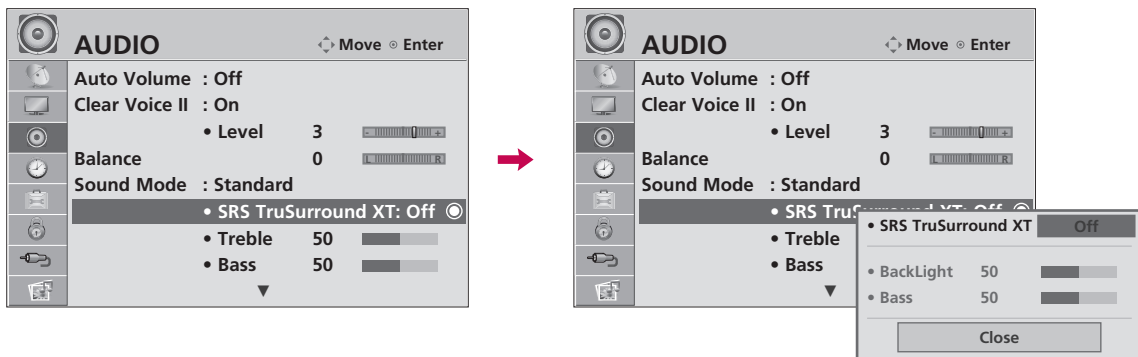



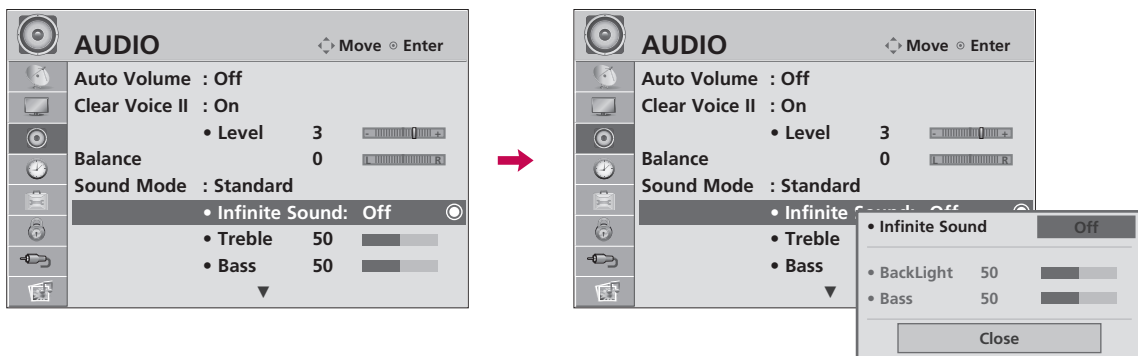

Takes advantage of any multi-channel format without needing to add extra speakers or equipment. Dialog clarity, bass enrichment, and the addition of stereo audio enhancement produces an immersive sound experience from standard stereo material.

32/37/42LG710H



32/37/42/47/55LD650H, 32/37/42LD655H, 32/37/42LD660H, 32/37/42LD665H, 32/37/42/47/55LV555H



- 1   or   Select **AUDIO**.
- 2   Select **SRS TruSurround XT** or **Infinite Sound**.
- 3   Select **On** or **Off**.
- 4  Return to the previous menu.
 or  Return to TV viewing.







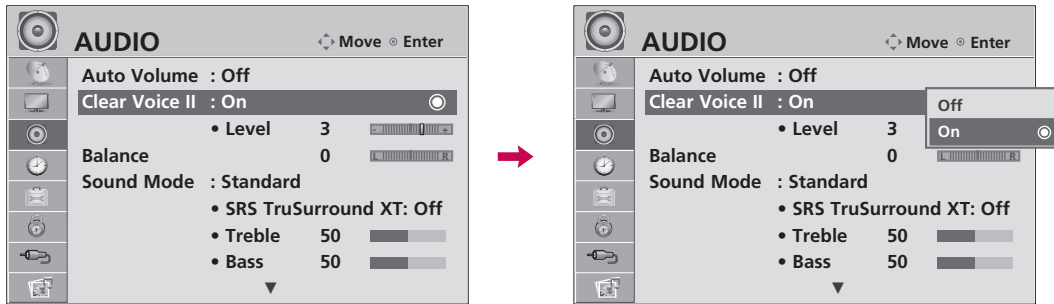

- If sound quality or volume is not at the level you want, it is recommended to use a separate home theater system or amp to cope with different user environments.
- If you select “**Clear Voice II-On**”, **SRS TruSurround XT** feature will not work.
- **SRS TruSurround XT**: TruSurround XT is a patented SRS technology that solves the problem of playing 5.1 multichannel content over two speakers.
- **Infinite Sound**: Infinite Sound is a patented LG proprietary sound processing technology that strives immersive 5.1 surround sound with just two front speakers. (For 32/37/42/47/55LD650H, 32/37/42LD655H, 32/37/42LD660H, 32/37/42LD665H, 32/37/42/47/55LV555H)

SOUND & LANGUAGE CONTROL







CLEAR VOICE II

By differentiating the human sound range from others, it improves the sound quality of voices.



- 1   or   Select **AUDIO**.
- 2   Select **Clear Voice II**.
- 3   Select **On** or **Off**.









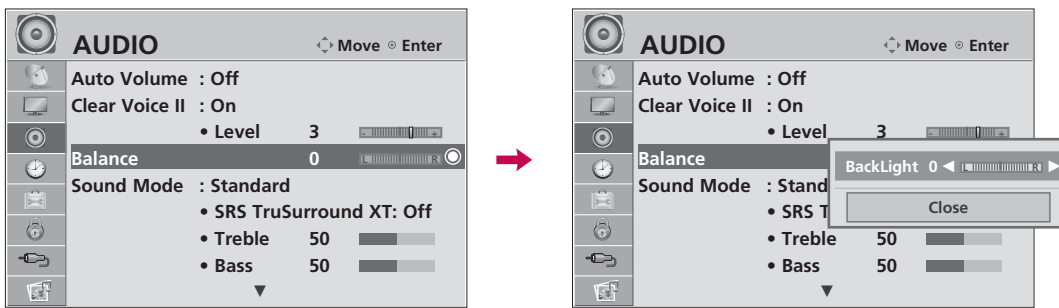

Adjustment for Clear Voice II Level With selecting **On**

- 4   Select **Level**.
- 5   Make appropriate adjustments.
- 6  Return to the previous menu.
 or  Return to TV viewing.

BALANCE

Adjust the left/right sound of speaker to suit your taste and room situations.



- 1   or   Select **AUDIO**.
- 2   Select **Balance**.
- 3   Make appropriate adjustments.
- 4  Return to the previous menu.
-  or  Return to TV viewing.

SOUND & LANGUAGE CONTROL









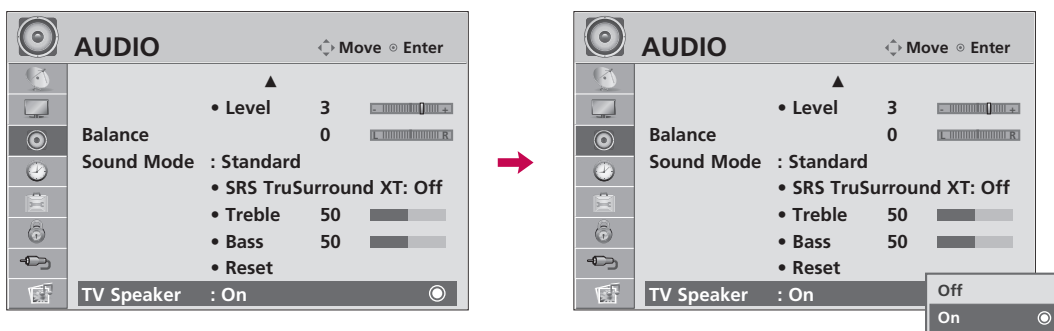

TV SPEAKERS ON/OFF SETUP

If you wish to use an external Hi-Fi system or a SRS System, turn off the TV's internal speakers.

In AV, Component, RGB and HDMI with HDMI to DVI cable, the TV speaker can be operational even when there is no video signal.

Turn the TV speakers off if using external audio equipment.









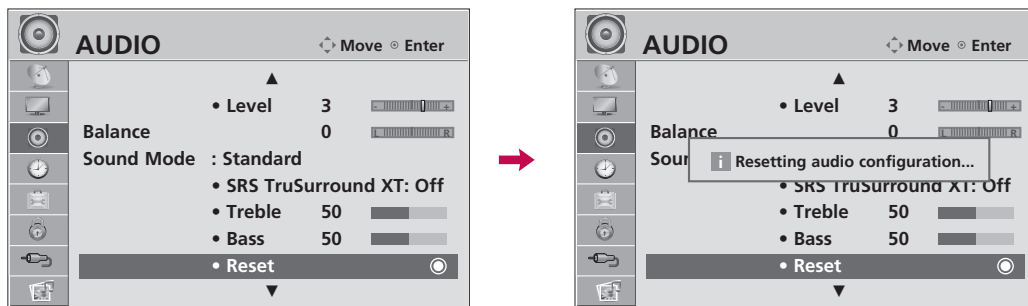

- 1   or   Select **AUDIO**.
 - 2   Select **TV Speaker**.
 - 3   Select **On** or **Off**.
 - 4  Return to the previous menu.
-  or  Return to TV viewing.

AUDIO RESET

Settings of the selected Sound Mode return to the default factory settings.



- 1   or   Select **AUDIO**.
- 2   Select **Reset**.
- 3  Initialize the adjusted value.
- 4  or  Return to TV viewing.



SOUND & LANGUAGE CONTROL

STEREO/SAP BROADCAST SETUP

For Analog only: This TV can receive MTS stereo programs and any SAP (Secondary Audio Program) that accompanies the stereo program if the station transmits an additional sound signal. Mono sound is automatically used if the broadcast is only in Mono.

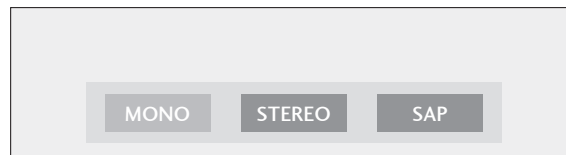
If other languages are available on the digital signal, select them with the SAP button.









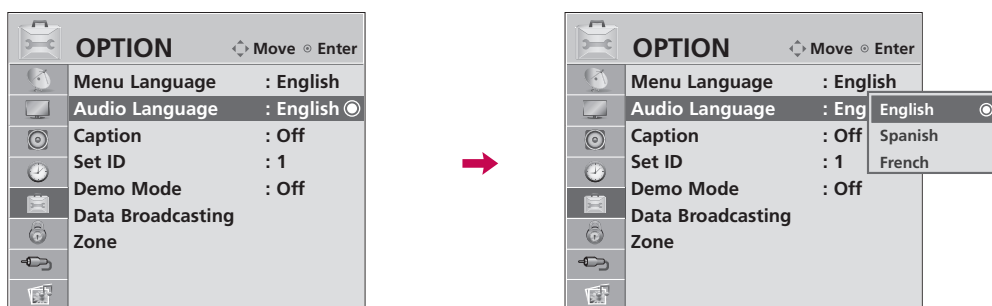



-  Each time you press the **SAP** button, **Mono**, **Stereo**, or **SAP** appear in turn.
-  Return to TV viewing.

AUDIO LANGUAGE

Other languages may be available if a digital signal is provided by the broadcasting station.
This feature operates only in DTV mode.



- 1   or   Select **OPTION**.
 - 2   Select **Audio Language**.
 - 3   Select your desired language.
 - 4  Return to the previous menu.
-  or  Return to TV viewing.

! NOTE









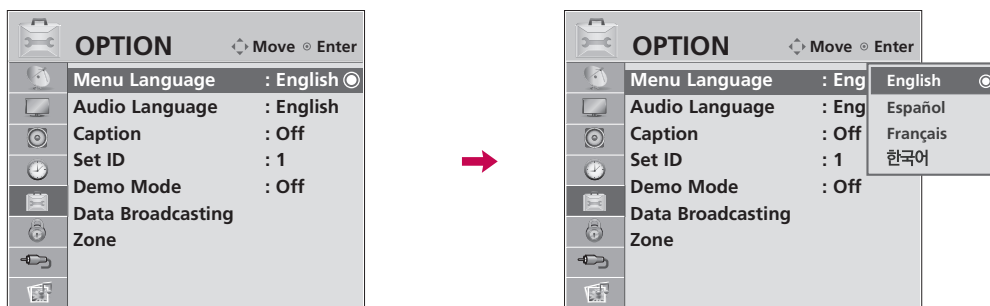

- ▶ **Data Broadcasting:** For 32/37/42LG710H, 32/37/42/47/55LD650H, 32/37/42LD655H
- ▶ **Zone:** For 32/37/42LD660H, 32/37/42LD665H, 32/37/42/47/55LV555H

SOUND & LANGUAGE CONTROL

ON-SCREEN MENUS LANGUAGE SELECTION

The menus can be shown on the screen in the selected language.



-   or   Select **OPTION**.
-   Select **Menu Language**.
-   Select your desired language.
From this point on, the on-screen menus will be shown in the selected language.
-  Return to the previous menu.
 or  Return to TV viewing.

! NOTE









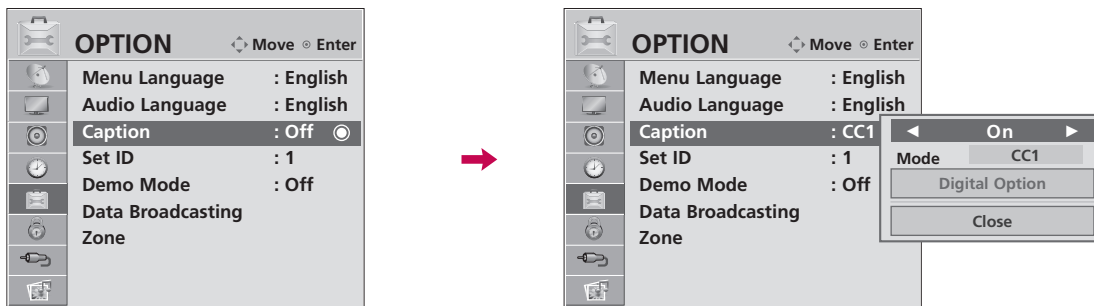



- ▶ **Data Broadcasting:** For 32/37/42LG710H, 32/37/42/47/55LD650H, 32/37/42LD655H
- ▶ **Zone:** For 32/37/42LD660H, 32/37/42LD665H, 32/37/42/47/55LV555H

CAPTION MODE

Analog Broadcasting System Captions

Captions are provided to help the hearing impaired watch TV. Select a caption mode for displaying captioning information if provided on a program. Analog caption displays information at any position on the screen and is usually the program's dialog. Caption/Text, if provided by the broadcaster, would be available for both digital and analog channels on the Antenna/Cable. This TV is programmed to memorize the caption/text mode which was last set when you turned the power off. This function is only available when **Caption Mode** is set **On**.



- 1   or   Select **OPTION**.
 - 2   Select **Caption**.
 - 3   Select **On**.
 - 4   Select **CC1-4** or **Text1-4**.
 - 5  Return to the previous menu.
-  or  Return to TV viewing.

- When selecting **Off**, Sub-menus for Analog, DTV, and Digital Option become disabled.
- **CAPTION**
The term for the words that scroll across the bottom of the TV screen; usually the audio portion of the program provided for the hearing impaired.
- **TEXT**
The term for the words that appear in a large black frame and almost cover the entire screen; usually messages provided by the broadcaster.

- NOTE**
- ▶ **Data Broadcasting:** For 32/37/42LG710H, 32/37/42/47/55LD650H, 32/37/42LD655H
 - ▶ **Zone:** For 32/37/42LD660H, 32/37/42LD665H, 32/37/42/47/55LV555H

SOUND & LANGUAGE CONTROL

Digital Broadcasting System Captions

Choose the language you want the DTV/CADTV Captions to appear in.

Other Languages can be chosen for digital sources only if they are included on the program.

This function is only available when **Caption Mode** is set **On**.

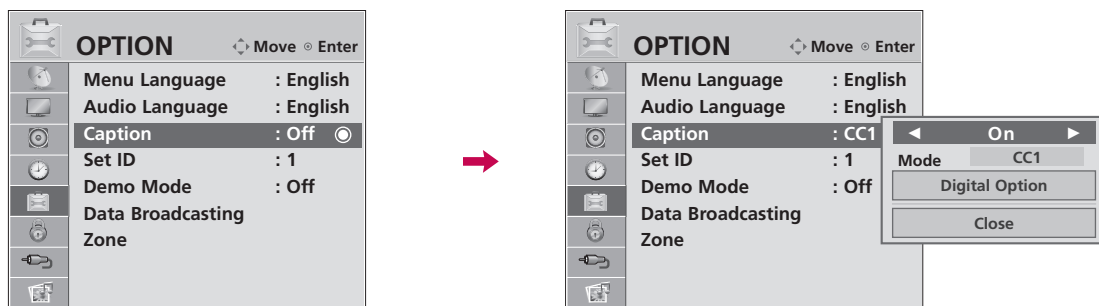

- 1 Select **OPTION**.
- 2 Select **Caption**.
- 3 Select **On**.
- 4 Select **CC1-4, Text1-4, or Service1-6**.
- 5 Return to the previous menu.
 Return to TV viewing.

! NOTE

- ▶ **Data Broadcasting:** For 32/37/42LG710H, 32/37/42/47/55LD650H, 32/37/42LD655H
- ▶ **Zone:** For 32/37/42LD660H, 32/37/42LD665H, 32/37/42/47/55LV555H

Caption Option

Customize the DTV captions that appear on your screen.

This function is only available when **Caption Mode** is set **On**.

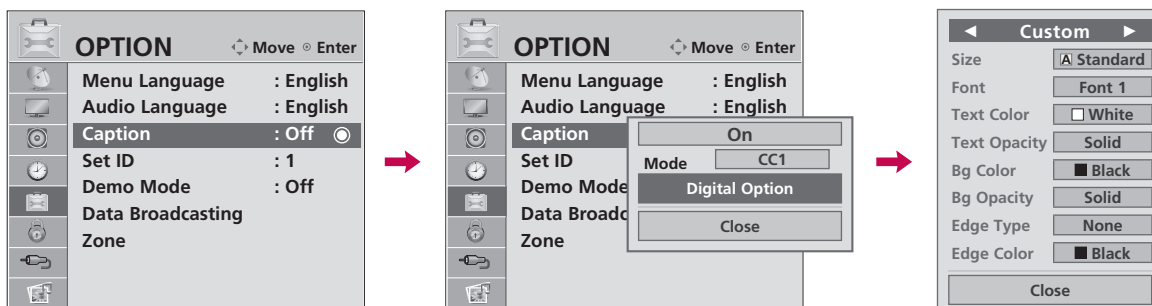

1 or Select **OPTION**.

2 Select **Caption**.

3 Select **On**.

4 Select **Digital Option**.

5 Select **Custom**.

6 Customize the **Size**, **Font**, etc., to your preference.
A preview icon is provided at the bottom of the screen, use it to see the caption language.

7 Return to the previous menu.

or Return to TV viewing.

- **Size:** Set the word size.
- **Font:** Select a typeface for the text.
- **Text Color:** Choose a color for the text.
- **Text Opacity:** Specify the opacity for the text color.
- **Bg (Background) Color:** Select a background color.
- **Bg (Background) Opacity:** Select the opacity for the background color.
- **Edge Type:** Select an edge type.
- **Edge Color:** Select a color for the edges.

NOTE

- ▶ **Data Broadcasting:** For 32/37/42LG710H, 32/37/42/47/55LD650H, 32/37/42LD655H
- ▶ **Zone:** For 32/37/42LD660H, 32/37/42LD665H, 32/37/42/47/55LV555H

TIME SETTING

CLOCK SETTING







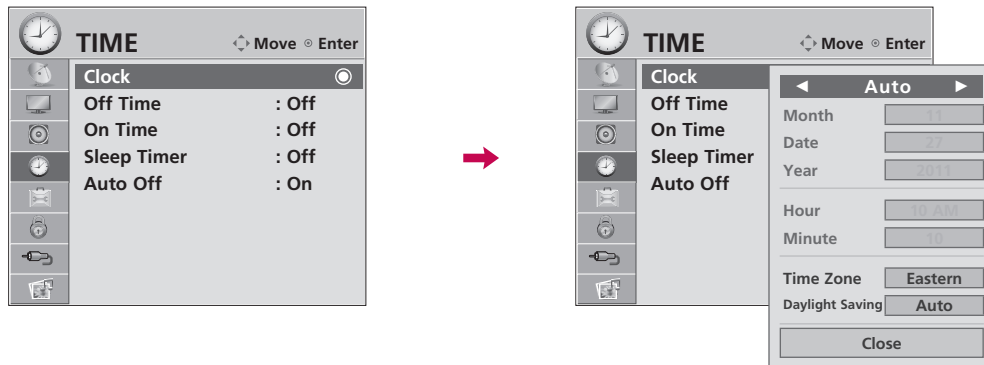

Auto Clock Setup

The time is set automatically from a digital channel signal.

The digital channel signal includes information for the current time provided by the broadcasting station.

Set the clock manually if the current time is set incorrectly by the auto clock function.









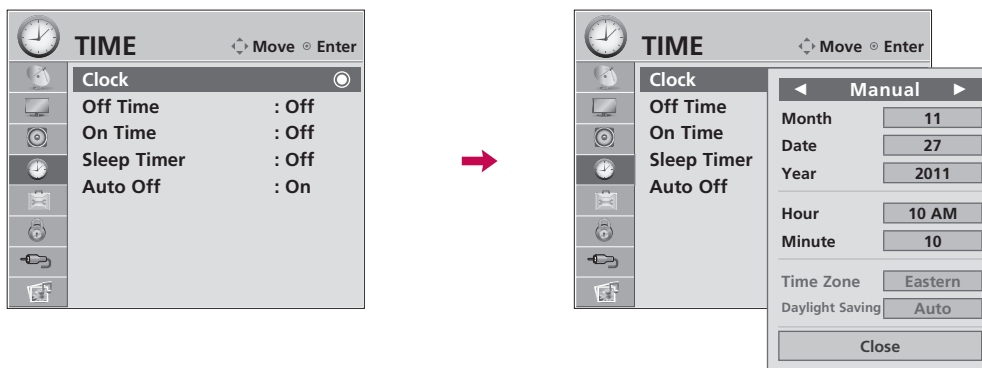





-  or  Select **TIME**.
-  Select **Clock**.
-  Select **Auto**.
-  Select your viewing area time zone.
 - U.S.A: **Eastern, Central, Mountain, Pacific, Alaska, or Hawaii.**
 - Canada: **Eastern, Central, Mountain, Pacific, New F.land, or Atlantic.**
-  Select **Auto, Off, or On** (depending on whether or not your viewing area observes Daylight Saving time).
-  Return to the previous menu.
 or  Return to TV viewing.

Manual Clock Setup

If the current time setting is wrong, reset the clock manually.



- 1   or   Select **TIME**.
 - 2   Select **Clock**.
 - 3   Select **Manual**.
 - 4  Select the Year, Month, Date, Hour, or Minutes option.
 - 5  Set the Year, Month, Date, Hour, or Minutes option.
 - 6  Return to the previous menu.
-  or  Return to TV viewing.

TIME SETTING



AUTO ON/OFF TIME SETTING

This function operates only if the current time has been set.

The Off Time function overrides the On Time function if they are both set to the same time.

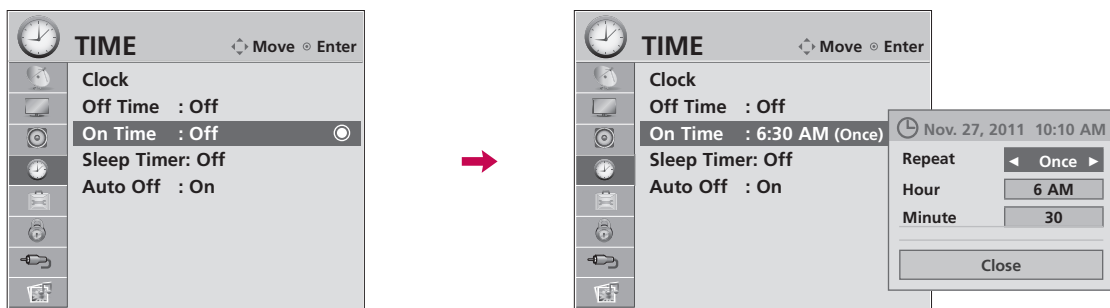
The TV must be in standby mode for the On Time to work.

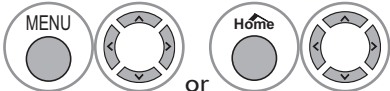
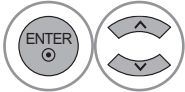

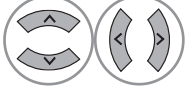
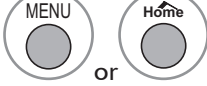





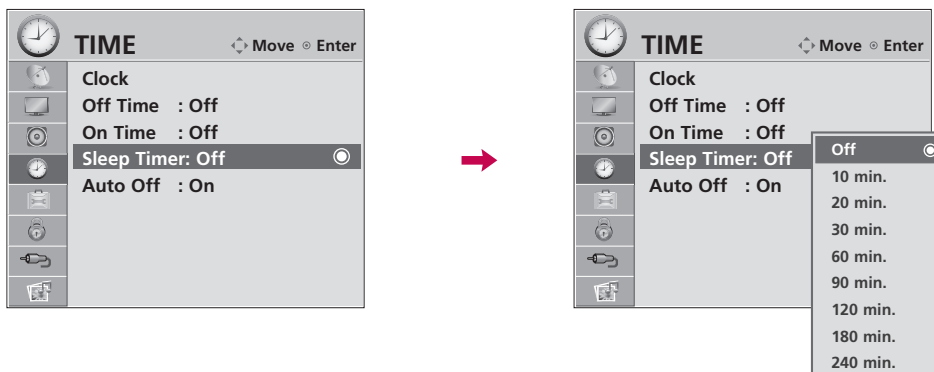



-  Select **TIME**.
-  Select **Off Time** or **On Time**.
-  Select **Repeat**.
-  Select **Off**, **Once**, **Daily**, **Mon.~Fri.**, **Mon.~Sat.**, **Sat.~Sun.**, or **Sun..**
-  Select and set **Hour** or **Minute**.
-  Return to the previous menu.
-  Return to TV viewing.

SLEEP TIMER SETTING

The Sleep Timer turns the TV off at the preset time.
Note that this setting is cleared when the TV is turned off.



- 1   or   Select **TIME**.
- 2   Select **Sleep Timer**.
- 3   Make appropriate adjustments.
- 4  Return to the previous menu.
 or  Return to TV viewing.









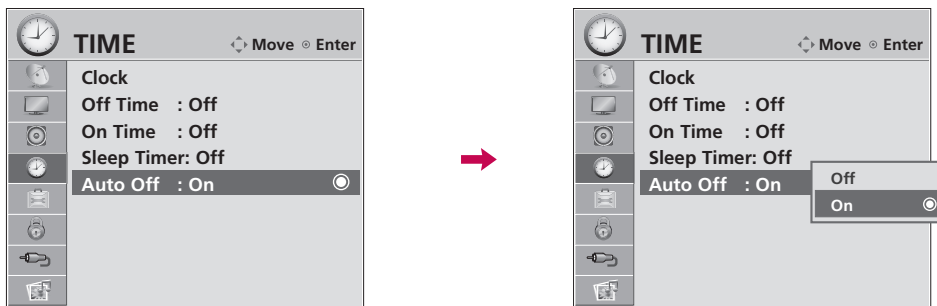

- To cancel the **Sleep Timer**, select **Off**.
- Press the **SLEEP** button repeatedly to select the number of minutes.

TIME SETTING

AUTO SHUT-OFF SETTING

If set to on and there is no input signal, the TV turns off automatically after 15 minutes.



-   or   Select **TIME**.
-   Select **Auto Off**.
-   Select **On** or **Off**.
-  Return to the previous menu.
-  or  Return to TV viewing.

PARENTAL CONTROL / RATINGS

Parental Control can be used to block specific channels, ratings and other viewing sources.

The Parental Control Function (V-Chip) is used to block program viewing based on the ratings sent by the broadcasting station. The default setting is to allow all programs to be viewed. Viewing can be blocked by choosing the type of the program and the categories. It is also possible to block all program viewing for a time period. To use this function, the following must be done:

1. Set ratings and categories to be blocked.
2. Specify a password
3. Enable the lock

V-Chip rating and categories

Rating guidelines are provided by broadcasting stations. Most television programs and television movies can be blocked by TV Rating and/or Individual Categories. Movies that have been shown at the theaters or direct-to-video movies use the Movie Rating System (MPAA) only.

Ratings for Television programs including made-for-TV movies:

- TV-G (General audience)
- TV-PG (Parental guidance suggested)
- TV-14 (Parents strongly cautioned)
- TV-MA (Mature audience only)
- TV-Y (All children)
- TV-Y7 (Children 7 years older)





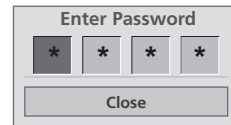
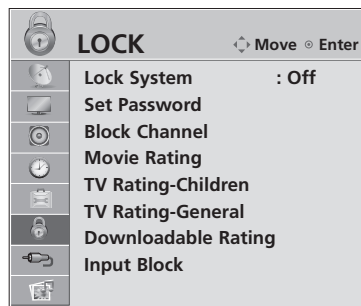

PARENTAL CONTROL / RATINGS

SET PASSWORD & LOCK SYSTEM

Setting up Your Password

Set up blocking schemes to block specific channels, ratings, and external viewing sources. A password is required to gain access to this menu.



- 1   or   Select **LOCK**.
- 2   Input the password.

■ The TV is set up with the initial password "0-0-0-0".

Lock System

Enables or disables the blocking scheme you set up previously.

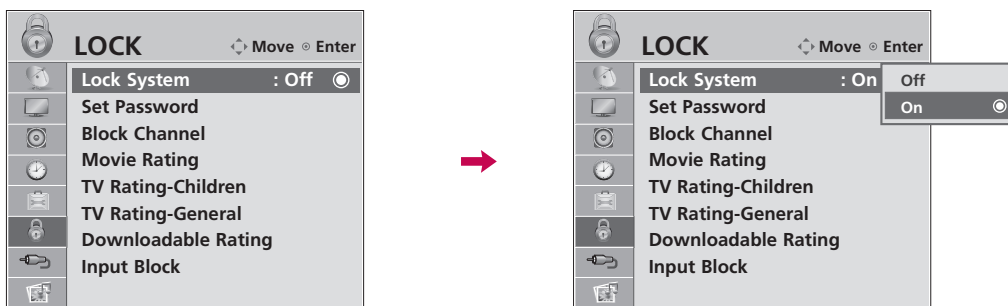

1 MENU or Home Select **LOCK**.

2 ENTER Input the password.

3 ENTER Select **Lock System**.

4 ENTER Select **On** or **Off**.

5 RETURN Return to the previous menu.

MENU or Home Return to TV viewing.









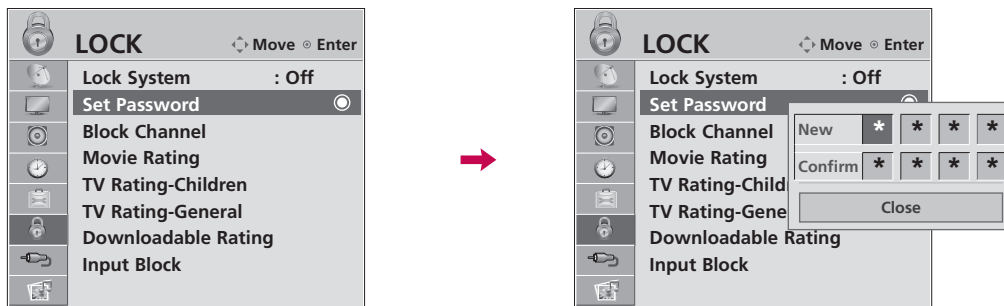



■ When you select **On**, the Lock System is enable.

PARENTAL CONTROL / RATINGS

Set Password

Set up blocking schemes to block specific channels, ratings, and external viewing sources. A password is required to gain access to this menu.









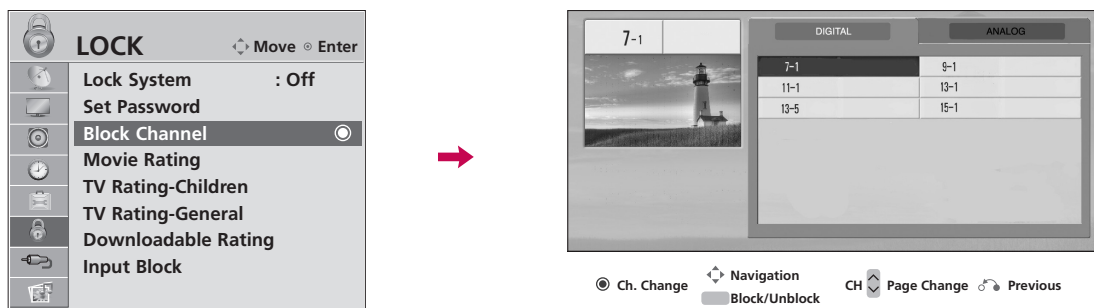





-   or   Select **LOCK**.
-   Input the password.
-  Select **Set Password**.
-   Choose any 4 digits for your **new** password.
As soon as the 4 digits are entered, re-enter the same 4 digits on the **Confirm**.
-  Return to the previous menu.
 or  Return to TV viewing.

CHANNEL BLOCKING

Blocks any channels that you do not want to watch or that you do not want your children to watch.



- 1   or   Select **LOCK**.
 - 2   Input the password.
 - 3  Select **Block Channel**.
 - 4   Select a channel to block or unblock.
 - 5  Block or unblock a channel.
 - 6  Return to the previous menu.
-  or  Return to TV viewing.









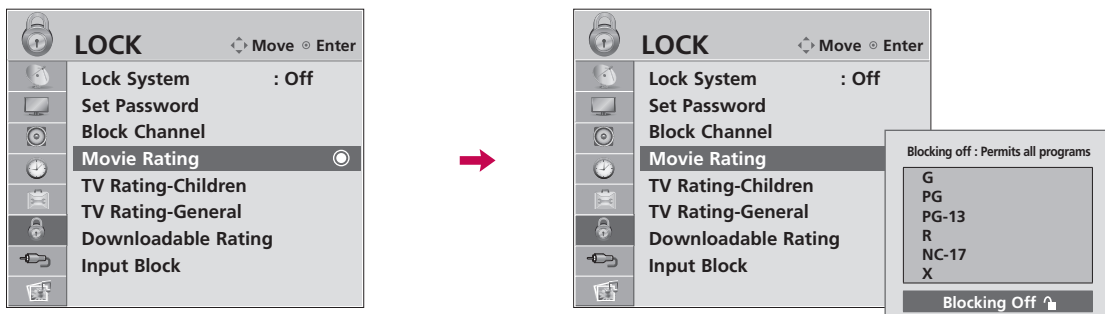



PARENTAL CONTROL / RATINGS

MOVIE & TV RATING

Movie Rating (MPAA) - For USA

Blocks movies according to the movie ratings limits specified, so children cannot view certain movies. You can set the ratings limit by blocking out all the movies with the ratings above a specified level. Keep in mind that the movie ratings limit only applies to movies shown on TV, not TV programs, such as soap operas.



- 1   or   Select **LOCK**.
- 2   Input the password.
- 3  Select **Movie Rating**.
- 4   Select **G, PG, PG-13, R, NC-17, X,** or **Blocking Off**.
- 5  Return to the previous menu.
 or  Return to TV viewing.

- **G** (General audience)
- **PG** (Parental guidance suggested)
- **PG-13** (Parents strongly cautioned)
- **R** (Restricted)
- **NC-17** (No one 17 and under admitted)
- **X** (Adult only)
- **Blocking Off** (Permits all programs)
- If you set PG-13: G and PG movies will be available, PG-13, R, NC-17 and X will be blocked.

TV Rating Children - For USA

Prevents children from watching certain children's TV programs, according to the ratings limit set. The children rating does not apply to other TV programs. Unless you block certain TV programs intended for mature audiences in the TV Rating - sub menu, your children can view those programs.

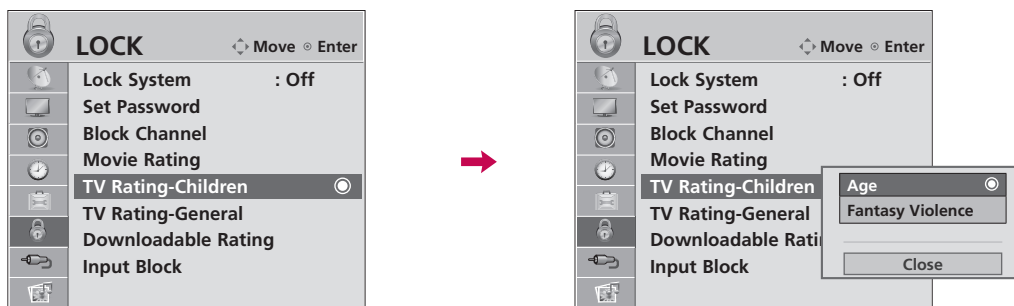

1 MENU or Home Select **LOCK**.

2 ENTER Input the password.

3 Select **TV Rating-Children**.

4 ENTER Select **Age** or **Fantasy Violence**.

5 ENTER Select block options.

6 RETURN Return to the previous menu.

MENU or Home Return to TV viewing.

- **Age** (applies to TV-Y, TV-Y7)
- **Fantasy Violence** (applies to TV-Y7)

PARENTAL CONTROL / RATINGS

TV Rating General - For USA

Based on the ratings, blocks certain TV programs that you and your family do not want to view.

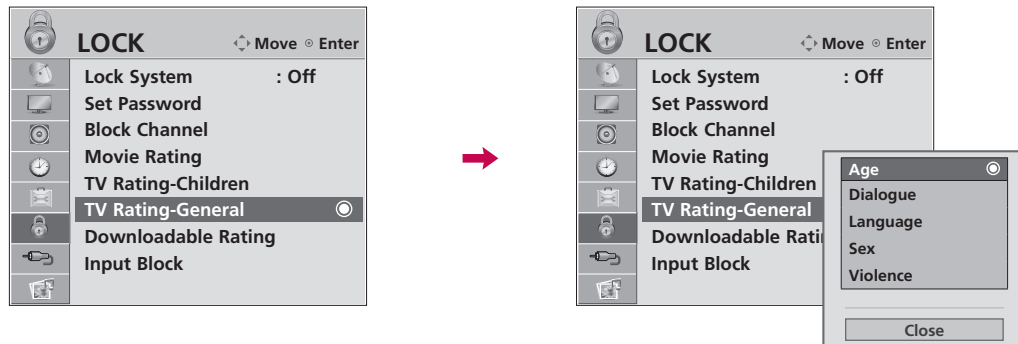

1 or Select **LOCK**.

2 Input the password.

3 Select **TV Rating-General**.

4 Select **Age, Dialogue, Language, Sex or Violence**.

5 Select block options.

6 Return to the previous menu.









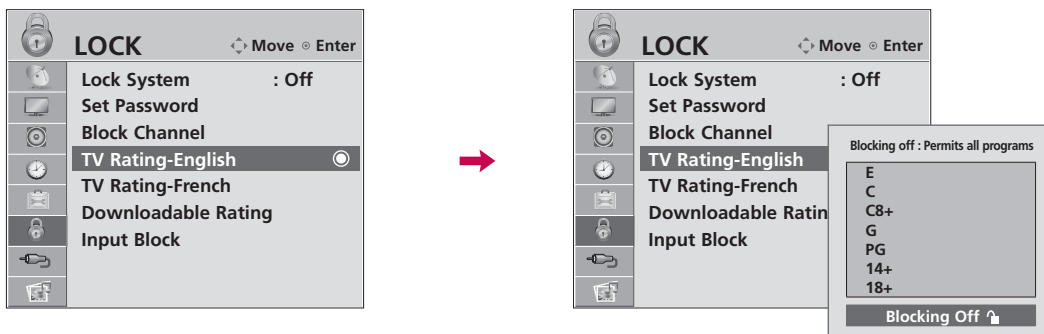



or Return to TV viewing.

- **Age**
(applies to TV-G, TV-PG, TV-14, TV-MA).
- **Dialogue** - sexual dialogue
(applies to TV-PG, TV-14).
- **Language** - adult language
(applies to TV-PG, TV-14, TV-MA).
- **Sex** - sexual situations
(applies to TV-PG, TV-14, TV-MA).
- **Violence**
(applies to TV-PG, TV-14, TV-MA).

TV Rating English - For CANADA

Selecting Canadian English rating system.



- 1   or   Select **LOCK**.
- 2   Input the password.
- 3  Select **TV Rating-English**.
- 4   Select **E, C, C8+, G, PG, 14+, 18+, or Blocking Off**.
- 5  Return to the previous menu.
 or  Return to TV viewing.









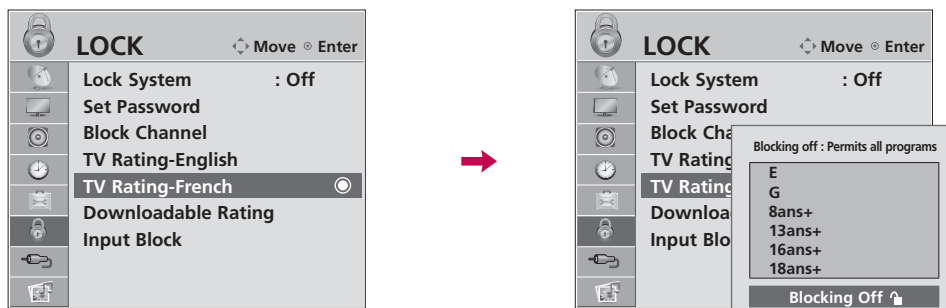



- If **TV Rating-English** or **TV Rating-French** is locked, enter the password to unlock it temporarily.
- **E** (Exempt)
- **C** (Children)
- **C8+** (Children eight years and older)
- **G** (General programming, suitable for all audiences)
- **PG** (Parental Guidance)
- **14+** (Viewers 14 years and older)
- **18+** (Adult programming)
- **Blocking Off** (Permits all programs)

PARENTAL CONTROL / RATINGS

TV Rating French - For CANADA

Selecting Canadian French rating system.



- 1   or   Select **LOCK**.
- 2   Input the password.
- 3  Select **TV Rating-French**.
- 4   Select **E, G, 8ans+, 13ans+, 16ans+, 18ans+, or Blocking off**.
- 5  Return to the previous menu.
 or  Return to TV viewing.

- **E** (Exempt)
- **G** (General)
- **8ans+** (General-Not convenient for little children)
- **13ans+** (Not convenient for children of 13 years and younger)
- **16ans+** (Not convenient for children of 16 years and younger)
- **18ans+** (This programs is only for adults)
- **Blocking off** (Permits all programs)







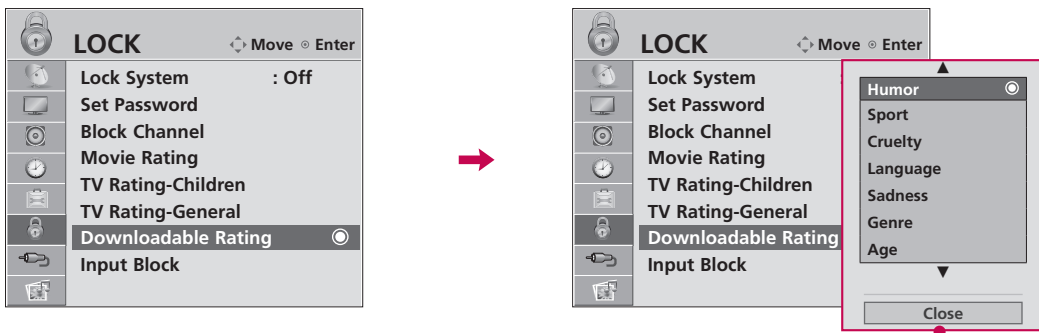









DOWNLOADABLE RATING

This function is available only for digital channels.

This function operates only when TV has received Region5 Rating data.



■ Based on rating table, your TV's OSD (On Screen Display) may differ slightly from what is shown in this manual.









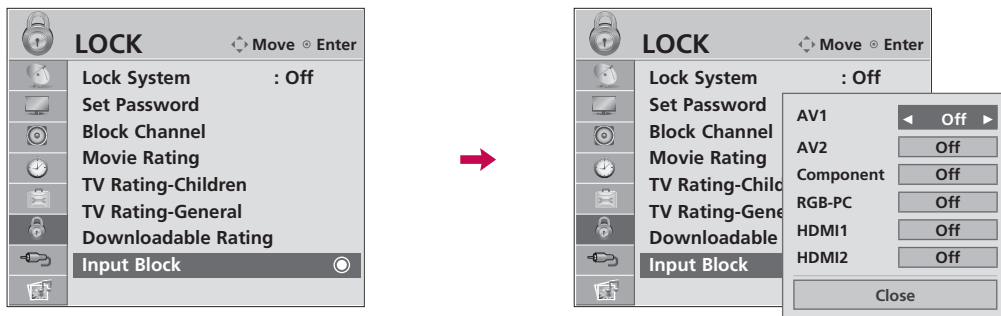



- 1   or   Select **LOCK**.
 - 2   Input the password.
 - 3   Select **Downloadable Rating**.
 - 4    Select desired Downloadable Rating option.
 - 5    Select desired option and block it.
 - 6  Return to the previous menu.
-  or  Return to TV viewing.

PARENTAL CONTROL / RATINGS

EXTERNAL INPUT BLOCKING

Enables you to block an input.



-   or   Select **LOCK**.
-   Input the password.
-  Select **Input Block**.
-   Select input source.
-  Select **On** or **Off**.
-  Return to the previous menu.
 or  Return to TV viewing.

APPENDIX

TROUBLESHOOTING

Abnormal Operation	
The remote control doesn't work	<ul style="list-style-type: none"> ■ Check to see if there is any object between the product and the remote control causing obstruction. Ensure you are pointing the remote control directly at the TV. ■ Ensure that the batteries are installed with correct polarity (+ to +, - to -). ■ Ensure that the correct remote operating mode is set: TV, VCR etc. ■ Install new batteries.
Power is suddenly turned off	<ul style="list-style-type: none"> ■ Is the sleep timer set? ■ Check the power control settings. Power interrupted.

Video Problems	
No picture & No sound	<ul style="list-style-type: none"> ■ Check whether the product is turned on. ■ Try another channel. The problem may be with the broadcast. ■ Is the power cord inserted into wall power outlet? ■ Check your antenna direction and/or location. ■ Test the wall power outlet, plug another product's power cord into the outlet where the product's power cord was plugged in.
Picture appears slowly after switching on	<ul style="list-style-type: none"> ■ This is normal, the image is muted during the product startup process. Please contact your service center, if the picture has not appeared after five minutes.
No or poor color or poor picture	<ul style="list-style-type: none"> ■ Adjust Color in menu option. ■ Try unplugging any others electronics that are near by to see if interference is causing the problem. ■ Try another channel. The problem may be with the broadcast. ■ Are the video cables installed properly? ■ Activate any function to restore the brightness of the picture.
Horizontal/vertical bars or picture shaking	<ul style="list-style-type: none"> ■ Check for local interference such as an electrical appliance or power tool.
Poor reception on some channels	<ul style="list-style-type: none"> ■ Station or cable product experiencing problems, tune to another station. ■ Station signal is weak, reorient antenna. ■ Check for sources of possible interference.
Lines or streaks in pictures	<ul style="list-style-type: none"> ■ Check antenna (Change the direction of the antenna).
No picture when connecting HDMI	<ul style="list-style-type: none"> ■ If the HDMI cables don't support High Speed HDMI, it can cause flickers or no screen display. In this case use the latest cables that support High Speed HDMI.

APPENDIX

Audio Problems	
Picture OK but No sound	<ul style="list-style-type: none"> ■ Press the VOL or VOLUME button. ■ Sound muted? Press the MUTE button. ■ Try another channel. The problem may be with the broadcast. ■ Are the audio cables installed properly?
No output from one of the speakers	<ul style="list-style-type: none"> ■ Adjust Balance in menu option.
Unusual sound from inside the product	<ul style="list-style-type: none"> ■ A change in ambient humidity or temperature may result in an unusual noise when the product is turned on or off and does not indicate a fault with the product.
No sound when connecting HDMI or USB	<ul style="list-style-type: none"> ■ Check High Speed HDMI cable. ■ Check USB cable over version 2.0. ■ Use normal MP3 file. <p style="text-align: right;">*This feature is not available for all models.</p>

PC Mode Problems	
The signal is out of range	<ul style="list-style-type: none"> ■ Adjust resolution, horizontal frequency, or vertical frequency. ■ Check the input source.
Vertical bar or stripe on background & Horizontal Noise & Incorrect position	<ul style="list-style-type: none"> ■ Work the Auto configure or adjust clock, phase, or H/V position. (Option)
Screen color is unstable or single color	<ul style="list-style-type: none"> ■ Check the signal cable. ■ Update video card drivers.

MAINTENANCE

Early malfunctions can be prevented. Careful and regular cleaning can extend the amount of time you can enjoy your new TV.

Caution: Be sure to turn the power off and unplug the power cord before you begin any cleaning.

Cleaning the Screen

- 1 Here's a great way to keep the dust off your screen for a while. Wet a soft cloth in a mixture of lukewarm water and a little fabric softener or dish washing detergent. Wring the cloth until it's almost dry, and then use it to wipe the screen.
- 2 Make sure the excess water is off the screen, and then let it air-dry before you turn on your TV.

WARNING

- ▶ Do not use window/glass cleaner or anything with ammonia to clean the screen.

Cleaning the Cabinet

- To remove dirt or dust, wipe the cabinet with a soft, dry, lint-free cloth.
- Please be sure not to use a wet cloth.

Extended Absence

CAUTION

- ▶ If you expect to leave your TV dormant for a long time (such as a vacation), it's a good idea to unplug the power cord to protect against possible damage from lightning or power surges.

PRODUCT SPECIFICATIONS

MODELS		32LG710H (32LG710H-UA)	37LG710H (37LG710H-UA)	42LG710H (42LG710H-UA)
Dimensions (Width x Height x Depth)	With stand	797 x 597 x 232.5 mm (31.3 x 23.5 x 9.15 inch)	918.6 x 684.8 x 293.4 mm (36.1 x 26.9 x 11.5 inch)	1026.2 x 734.1 x 293.4 mm (40.4 x 28.9 x 11.5 inch)
	Without stand	797 x 558.7 x 109.3 mm (31.3 x 21.9 x 4.3 inch)	918.6 x 635.8 x 111.7 mm (36.1 x 25.0 x 4.39 inch)	1026.2 x 687.9 x 111.8 mm (40.4 x 27.0 x 4.4 inch)
Weight	With stand	12.89 kg (28.41 lbs)	17.97 kg (39.61 lbs)	21.10 kg (46.51 lbs)
	Without stand	11.41 kg (25.15 lbs)	15.41 kg (33.97 lbs)	18.48 kg (40.74 lbs)
Current Value / Power Consumption		1.5A / 150W	1.8A / 180W	2.3A / 230W
Cable Card	MPI card (Width x Height x Depth)	3.1 x 0.9 x 6.3 inch 80.0(+0.6/-0.2) x less than 23.0(including pcb thickness) x less than 162.0(excluding cover thickness) mm		
	Card Bracket Cover (Width x Height)	3.7 x 1.1 inch 94.7(±0.5) x 28.3(±0.5) mm		
Power requirement Television System Program Coverage External Antenna Impedance		AC100-240V ~ 50/60Hz NTSC-M, ATSC, 64 & 256 QAM VHF 2-13, UHF 14-69, CATV 1-135, DTV 2-69, CADTV 1-135 75 Ω		
Environment condition	Operating Temperature	32 ~ 104°F (0 ~ 40°C)		
	Operating Humidity	Less than 80%		
	Storage Temperature	-4 ~ 140°F (-20 ~ 60°C)		
	Storage Humidity	Less than 85%		

■ The specifications shown above may be changed without prior notice for quality improvement.

MODELS		32LD650H (32LD650H-UA) 32LD655H (32LD655H-UA)	37LD650H (37LD650H-UA) 37LD655H (37LD655H-UA)
Dimensions (Width x Height x Depth)	With stand	797.0 mm x 557.7 mm x 207.0 mm (31.3 inch x 21.9 inch x 8.1 inch)	916.0 mm x 626.0 mm x 261.0 mm (36.0 inch x 24.6 inch x 10.2 inch)
	Without stand	797.0 mm x 495.0 mm x 97.1 mm (31.3 inch x 19.4 inch x 3.8 inch)	916.0 mm x 560.0 mm x 88.9 mm (36.0 inch x 22.0 inch x 3.5 inch)
Weight	With stand	11.1 kg (24.4 lbs)	14.6 kg (32.1 lbs)
	Without stand	9.4 kg (20.7 lbs)	12.0 kg (26.4 lbs)
Current Value / Power Consumption		1.5A / 150W	1.7A / 170W
MODELS		42LD650H (42LD650H-UA) 42LD655H (42LD655H-UA)	47LD650H (47LD650H-UA)
Dimensions (Width x Height x Depth)	With stand	1024.0 mm x 686.6 mm x 261.0 mm (40.3 inch x 27.0 inch x 10.2 inch)	1137.0 mm x 758.0 mm x 270.0 mm (44.7 inch x 29.8 inch x 10.6 inch)
	Without stand	1024.0 mm x 621.0 mm x 87.1 mm (40.3 inch x 24.4 inch x 3.4 inch)	1137.0 mm x 685.0 mm x 76.8 mm (44.7 inch x 26.9 inch x 3.0 inch)
Weight	With stand	17.7 kg (39.0 lbs)	20.3 kg (44.7 lbs)
	Without stand	15.1 kg (33.2 lbs)	18.3 kg (40.3 lbs)
Current Value / Power Consumption		2.1A / 210W	2.5A / 250W
MODELS		55LD650H (55LD650H-UA)	
Dimensions (Width x Height x Depth)	With stand	1329.0 mm x 872.0 mm x 330.0 mm (52.3 inch x 34.3inch x 12.9 inch)	
	Without stand	1329.0 mm x 796.0 mm x 96.5 mm (52.3 inch x 31.3 inch x 3.7 inch)	
Weight	With stand	33.0 kg (72.7 lbs)	
	Without stand	29.8 kg (65.6 lbs)	
Current Value / Power Consumption		3.4A / 340W	
Power requirement Television System Program Coverage External Antenna Impedance		AC100-240V ~ 50/60Hz NTSC-M, ATSC, 64 & 256 QAM VHF 2-13, UHF 14-69, CATV 1-135, DTV 2-69, CADTV 1-135 75 Ω	
Environment condition	Operating Temperature Operating Humidity	32 ~ 104°F (0 ~ 40°C) Less than 80%	
	Storage Temperature Storage Humidity	-4 ~ 140°F (-20 ~ 60°C) Less than 85%	

■ The specifications shown above may be changed without prior notice for quality improvement.

APPENDIX

MODELS		32LD660H (32LD660H-UA) 32LD665H (32LD665H-UA)
Dimensions (Width x Height x Depth)	With stand	797.0 mm x 557.7 mm x 207.0 mm (31.3 inch x 21.9 inch x 8.1 inch)
	Without stand	797.0 x 495.0 x 97.1 mm (31.3 inch x 19.4 inch x 3.8 inch)
Weight	With stand	11.1 kg (24.4 lbs)
	Without stand	9.4 kg (20.7 lbs)
Current Value / Power Consumption		1.2A / 120W
MODELS		37LD660H (37LD660H-UA) 37LD665H (37LD665H-UA)
Dimensions (Width x Height x Depth)	With stand	916.0 mm x 626.0 mm x 261.0 mm (36.0 inch x 24.6 inch x 10.2 inch)
	Without stand	916.0 mm x 560.0 mm x 88.9 mm (36.0 inch x 22.0 inch x 3.5 inch)
Weight	With stand	14.6 kg (32.1 lbs)
	Without stand	12.0 kg (26.4 lbs)
Current Value / Power Consumption		1.7A / 170W
MODELS		42LD660H (42LD660H-UA) 42LD665H (42LD665H-UA)
Dimensions (Width x Height x Depth)	With stand	1024.0 mm x 686.6 mm x 261.0 mm (40.3 inch x 27.0 inch x 10.2 inch)
	Without stand	1024.0 mm x 621.0 mm x 87.1 mm (40.3 inch x 24.4 inch x 3.4 inch)
Weight	With stand	17.7 kg (39.0 lbs)
	Without stand	15.1 kg (33.2 lbs)
Current Value / Power Consumption		1.9A / 190W
Power requirement		AC100-240V ~ 50/60Hz
Television System		NTSC-M, ATSC, 64 & 256 QAM
Program Coverage		VHF 2-13, UHF 14-69, CATV 1-135, DTV 2-69, CADTV 1-135
External Antenna Impedance		75 Ω
Environment condition	Operating Temperature	32 ~ 104°F (0 ~ 40°C)
	Operating Humidity	Less than 80%
	Storage Temperature	-4 ~ 140°F (-20 ~ 60°C)
	Storage Humidity	Less than 85%

■ The specifications shown above may be changed without prior notice for quality improvement.

MODELS		32LV555H (32LV555H-UA)	37LV555H (37LV555H-UA)
Dimensions (Width x Height x Depth)	With stand	776.0 mm x 545.59 mm x 260.8 mm (30.5 inch x 21.4 inch x 10.2 inch)	896 mm x 610.9 mm x 260.8 mm (35.7 inch x 24.0 inch x 10.2 inch)
	Without stand	776.0 mm x 485.0 mm x 34.9 mm (30.5 inch x 19.0 inch x 1.3 inch)	896 mm x 553 mm x 34.9 mm (35.2 inch x 21.7 inch x 1.3 inch)
Weight	With stand	12.4 kg (27.3 lbs)	13.5 kg (29.7 lbs)
	Without stand	9.7 kg (21.3 lbs)	10.8 kg (23.8 lbs)
Current Value / Power Consumption		0.8A / 80W	1.0A / 100W
MODELS		42LV555H (42LV555H-UA)	47LV555H (47LV555H-UA)
Dimensions (Width x Height x Depth)	With stand	1012.0 mm x 671.0 mm x 260.8 mm (39.8 inch x 26.4 inch x 10.2 inch)	1121.0 mm x 746.0 mm x 256.0 mm (44.1 inch x 29.3 inch x 10.0 inch)
	Without stand	1012.0 mm x 617.0 mm x 29.9 mm (39.8 inch x 24.2 inch x 1.1 inch)	1121.0 mm x 678.0 mm x 29.9 mm (44.1 inch x 26.6 inch x 1.1 inch)
Weight	With stand	15.9 kg (35.0 lbs)	20.7 kg (45.6 lbs)
	Without stand	13.2 kg (29.1 lbs)	18.4 kg (40.5 lbs)
Current Value / Power Consumption		1.4A / 140W	1.5A / 150W
MODELS		55LV555H (55LV555H-UA)	
Dimensions (Width x Height x Depth)	With stand	1298.0 mm x 849.0 mm x 338.0 mm (51.1 inch x 33.4 inch x 13.3 inch)	
	Without stand	1298.0 mm x 778.0 mm x 29.9 mm (51.1 inch x 30.6 inch x 1.1 inch)	
Weight	With stand	25.8 kg (56.8 lbs)	
	Without stand	21.7 kg (47.8 lbs)	
Current Value / Power Consumption		1.7A / 170W	
Power requirement Television System Program Coverage External Antenna Impedance		AC120V ~ 50 / 60 Hz NTSC-M, ATSC, 64 & 256 QAM VHF 2-13, UHF 14-69, CATV 1-135, DTV 2-69, CADTV 1-135 75 Ω	
Environment condition	Operating Temperature Operating Humidity	32 ~ 104°F (0 ~ 40°C) Less than 80%	
	Storage Temperature Storage Humidity	-4 ~ 140°F (-20 ~ 60°C) Less than 85%	

■ The specifications shown above may be changed without prior notice for quality improvement.

PROGRAMMING THE REMOTE CONTROL

The provided universal remote control can be programmed to operate most remote-controllable devices. Note that the remote may not control all models of other brands.

Programming a code into a remote mode

- 1** Testing your remote control.
To find out whether your remote control can operate other components without programming, turn on a component such as a STB(Set-Top Box) and press the corresponding mode button (such as **STB**) on the remote control, while pointing at the component. Test the **POWER** and **CH** ^ ∨ buttons to see if the component responds correctly. If the component does not operate correctly, the remote control requires programming to operate the device.
- 2** Turn on the component to be programmed, then press the corresponding mode button (such as **STB**) on the remote control. The remote control button of the desired device is illuminated.
- 3** Press the **MENU** and **MUTE** buttons simultaneously, and the remote control is ready to be programmed with the code.
- 4** Enter a code number using the number buttons on the remote control. Programming code numbers for the corresponding component can be found on the following pages. If the code is correct, the device will turn off.
- 5** Press the **MENU** button to store the code.
- 6** Test the remote control functions to see if the component responds correctly. If not, repeat from step 2.

Remote Control Code

VCR

Brand	Codes	Brand	Codes	Brand	Codes
AIWA	034	MAGIN	040	SAMSUNG	032 040 102 104
AKAI	016 043 046 124 125 146	MAGNAVOX	031 033 034 041 067 068		105 107 109 112 113 115 120 122 125
AMPRO	072	MARANTZ	012 031 033 067 069	SANSUI	022 043 048 135
ANAM	031 033 103	MARTA	101	SANYO	003 007 010 014 102 134
AUDIO DYNAMICS	012 023 039 043	MATSUI	027 030	SCOTT	017 037 112 129 131
BROKSONIC	035 037 129	MEI	031 033	SEARS	003 008 009 010 013 014 017 020 031 042 073 081 101
CANON	028 031 033	MEMOREX	003 010 014 031 033 034 053 072 101 102 134 139	SHARP	031 054 149
CAPEHART	108	MGA	045 046 059	SHINTOM	024
CRAIG	003 040 135	MINOLTA	013 020	SONY	003 009 031 052 056 057 058 076 077 078 149
CURTIS MATHES	031 033 041	MITSUBISHI	013 020 045 046 049 051 059 061 151	SOUNDESIGN	034
DAEWOO	005 007 010 064 065 108 110 111 112 116 117 119	MTC	034 040	STS	013
DAYTRON	108	MULTITECH	024 034	SYLVANIA	031 033 034 059 067
DBX	012 023 039 043	NEC	012 023 039 043 048	SYMPHONIC	034
DYNATECH	034 053	NORDMENDE	043	TANDY	010 034
ELECTROHOME	059	OPTONICA	053 054	TATUNG	039 043
EMERSON	006 017 025 027 029 031 034 035 036 037 046 101 129 131 138 153	PANASONIC	066 070 074 083 133 140 145	TEAC	034 039 043
FISHER	003 008 009 010	PENTAX	013 020 031 033 063	TECHNICS	031 033 070
FUNAI	034	PHILCO	031 034 067	TEKNIKA	019 031 033 034 101
GE	031 033 063 072 107 109 144 147	PHILIPS	031 033 034 054 067 071 101	THOMAS	034
GO VIDEO	132 136	PILOT	101	TMK	006
HARMAN KARDON	012 045	PIONEER	013 021 048	TOSHIBA	008 013 042 047 059 082 112 131
HITACHI	004 018 026 034 043 063 137 150	PORTLAND	108	TOTEVISION	040 101
INSTANTREPLAY	031 033	PULSAR	072	UNITECH	040
JCL	031 033	QUARTZ	011 014	VECTOR RESEARCH	012
JCPENNY	012 013 015 033 040 066 101	QUASAR	033 066 075 145	VICTOR	048
JENSEN	043	RCA	013 020 033 034 040 041 062 063 107 109 140 144 145 147	VIDEO CONCEPTS	012 034 046
JVC	012 031 033 043 048 050 055 060 130 150 152	REALISTIC	003 008 010 014 031 033 034 040 053 054 101	VIDEOSONIC	040
KENWOOD	014 034 039 043 047 048	RICO	058	WARDS	003 013 017 024 031 033 034 040 053 054 131
LG (GOLDSTAR)	001 012 013 020 101 106 114 123	RUNCO	148	YAMAHA	012 034 039 043
LLOYD	034	SALORA	014	ZENITH	034 048 056 058 072 080 101
LXI	003 009 013 014 017 034 101 106				

APPENDIX

HDSTB

Brand	Codes	Brand	Codes	Brand	Codes
ALPHASTAR DSR	123	HITACHI	139 140	RCA	066 106
AMPLICA	050	HOUSTON	033 037 039 051	REALISTIC	043 074
ASTRO PHILIPS(ML)	159	TRACKER	057 104	SAMSUNG	123
		HUGHES	068	SATELLITE SERVICE	028 035 047 057
ASTRO	160	HUMAX(SL)	158	CO	085
THOMPSON(ML)		JANIEL	060 147	SCIENTIFIC	032 138
ASTRO NOKIA(ML)	161	JERROLD	061	ATLANTA	
		KATHREIN	108	SKY LIFE	150
BIRDVIEW	051 126 129	LEGEND	057	SONY	103
CHANNEL MASTER	013 014 015 018	LG	001	STARCAST	041
	036 055	LUTRON	132	SUPER GUIDE	020 124 125
CHAPARRAL	008 009 012 077	LUXOR	062 144	SAMART(TH)	156
CITOH	054	MACOM	010 059 063 064	TEECOM	023 026 075 087
CURTIS MATHES	050 145		065		088 090 107 130
DRAKE	005 006 007 010	MEMOREX	057		137
	011 052 112 116	NEXTWAVE	028 124 125	TOSHIBA	002 127
	141	NORSAT	069 070	TRUE VISION(TH)	155
DX ANTENNA	024 046 056 076	PACE SKY SATEL- LITE	143	UNIDEN	016 025 042 043
ECHOSTAR	038 040 057 058	PANASONIC	060 142		044 045 048 049
	093 094 095 096	PANSAT	121		078 079 080 086
	097 098 099 100	PERSONAL CABLE	117	UBC(TH)	101 135 136
	122				153
ELECTRO HOME	089	PHILIPS	071	UBC/SAMART(TH)	154
EUROPLUS	114	PICO	105	VIEWSTAR	115
FUJITSU	017 021 022 027	PRIDENT	019 102	VTC(VN)	162
	133 134	PRIMESTAR	030 110 111	WINEGARD	128 146
GENERAL	003 004 016 029	PROSAT	072	ZENITH	081 082 083 084
INSTRUMENT	031 059 101	PSI(TH)	157		091 120

DVD

Brand	Codes	Brand	Codes	Brand	Codes
APEX DIGITAL	022	MITSUBISHI	002	RCA	005 006
DENON	020 014	NAD	023	SAMSUNG	011 015
GE	005 006	ONKYO	008 017	SONY	007
HARMAN KARDON	027	PANASONIC	003 009	THOMPSON	005 006
JVC	012	PHILIPS	013	TOSHIBA	019 008
LG	001 010 016 025	PIONEER	004 026	YAMAHA	009 018
MAGNAVOX	013	PROCEED	021	ZENITH	010 016 025
MARANTZ	024	PROSCAN	005 006		

IR CODES

1. How to Connect

- Connect your wired remote control to the Remote Control port on the TV.

2. Remote Control IR Codes

- **Output waveform**
Single pulse, modulated with 37.917KHz signal at 455KHz

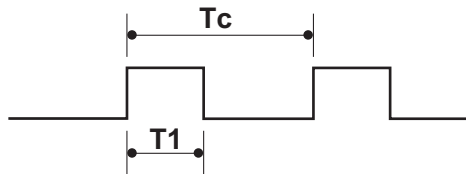

Carrier frequency
 $FCAR = 1/T_c = f_{OSC}/12$
 Duty ratio = $T_1/T_c = 1/3$

■ Configuration of frame

1st frame

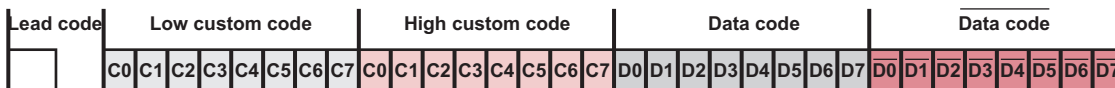

Repeat frame

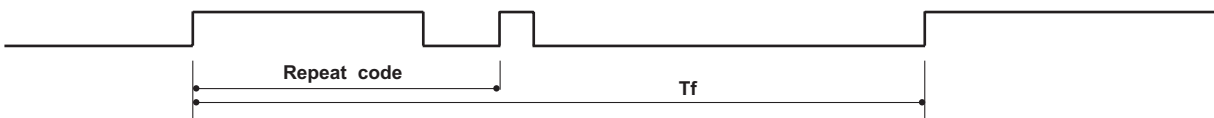

■ Lead code

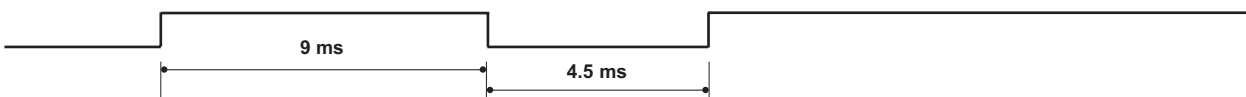

■ Repeat code

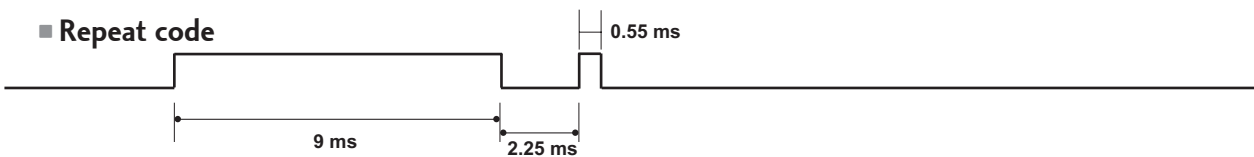

■ Bit description

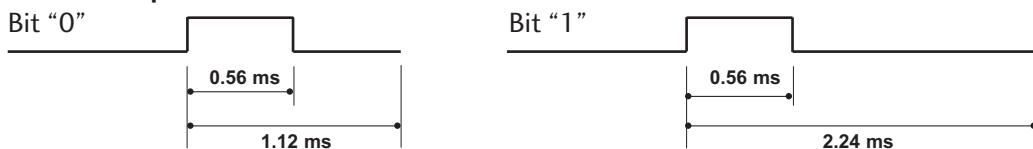

■ Frame interval: T_f

The waveform is transmitted as long as a key is depressed.

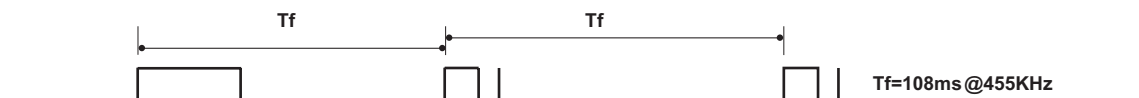

APPENDIX

Code (Hexa)	Function	Note	Code (Hexa)	Function	Note
08	POWER	Remote control Button (Power On/Off)	D6	TV	Discrete IR Code (TV Input Selection)
0F	TV	Remote control Button			
0B	INPUT	Remote control Button	5A	AV1	Discrete IR Code (AV1 Input Selection)
0A	SAP	Remote control Button			
79	◀◀ RATIO	Remote control Button	D0	AV2	Discrete IR Code (AV2 Input Selection)
AB	GUIDE	Remote control Button			
0C	PORTAL	Remote control Button	BF	COMPONENT	Discrete IR Code (COMPONENT Input Selection)
AA	INFO	Remote control Button			
10-19	Number Key 0-9	Remote control Button	D5	RGB-PC	Discrete IR Code (RGB Input Selection)
4C	- (Dash)	Remote control Button			
1A	FLASHBK	Remote control Button	CE	HDMI1	Discrete IR Code (HDMI1 Input Selection)
02	VOL +	Remote control Button			
03	VOL -	Remote control Button	CC	HDMI2	Discrete IR Code (HDMI2 Input Selection)
00	CH ^	Remote control Button			
01	CH v	Remote control Button	76	Ratio 4:3	Discrete IR Code (Only 4:3 Mode)
0E	▶▶ TIMER	Remote control Button			
39	CC	Remote control Button	77	Ratio 16:9	Discrete IR Code (Only 16:9 Mode)
09	MUTE	Remote control Button			
43	MENU or Home	Remote control Button	AF	Ratio Zoom	Discrete IR Code (Only Zoom Mode)
5B	RETURN	Remote control Button			
40	^	Remote control Button	C4	POWER ON	Discrete IR Code (Only Power On)
41	v	Remote control Button			
07	<	Remote control Button	C5	POWER OFF	Discrete IR Code (Only Power Off)
06	>	Remote control Button			
44	ENTER	Remote control Button			
60	PIP	Remote control Button			
71	PIP CH +	Remote control Button			
72	PIP CH-	Remote control Button			
63	PIP SWAP	Remote control Button			
61	PIP INPUT	Remote control Button			
C1	■ (Stop)	Remote control Button			
C0	▶ (Play)	Remote control Button			
C2	(Pause)	Remote control Button			
C3	● (Record)	Remote control Button			

OPEN SOURCE LICENSE

GNU GENERAL PUBLIC LICENSE

Version 2, June 1991

Copyright (C) 1989, 1991 Free Software Foundation, Inc., 51 Franklin Street, Fifth Floor, Boston, MA 02110-1301 USA

Everyone is permitted to copy and distribute verbatim copies of this license document, but changing it is not allowed.

Preamble

The licenses for most software are designed to take away your freedom to share and change it. By contrast, the GNU General Public License is intended to guarantee your freedom to share and change free software - to make sure the software is free for all its users. This General Public License applies to most of the Free Software Foundation's software and to any other program whose authors commit to using it. (Some other free software foundation software is covered by the GNU Lesser General Public License instead.) You can apply it to your programs, too.

When we speak of free software, we are referring to freedom, not price. Our General Public Licenses are designed to make sure that you have the freedom to distribute copies of free software (and charge for this service if you wish), that you receive source code or can get it if you want it, that you can change the software or use pieces of it in new free programs; and that you know you can do these things.

To protect your rights, we need to make restrictions that forbid anyone to deny you these rights or to ask you to surrender the rights. These restrictions translate to certain responsibilities for you if you distribute copies of the software, or if you modify it.

For example, if you distribute copies of such a program, whether gratis or for a fee, you must give the recipients all the rights that you have. You must make sure that they, too, receive or can get the source code. And you must show them these terms so they know their rights.

We protect your rights with two steps: (1) copyright the software, and (2) offer you this license which gives you legal permission to copy, distribute and/or modify the software.

Also, for each author's protection and ours, we want to make certain that everyone understands that there is no warranty for this free software. If the software is modified by someone else and passed on, we want its recipients to know that what they have is not the original, so that any problems introduced by others will not reflect on the original authors' reputations.

Finally, any free program is threatened constantly by software patents. We wish to avoid the danger that redistributors of a free program will individually obtain patent licenses, in effect

making the program proprietary. To prevent this, we have made it clear that any patent must be licensed for everyone's free use or not licensed at all.

The precise terms and conditions for copying, distribution and modification follow.

GNU GENERAL PUBLIC LICENSE

TERMS AND CONDITIONS FOR COPYING, DISTRIBUTION AND MODIFICATION

0. This license applies to any program or other work which contains a notice placed by the copyright holder saying it may be distributed under the terms of this General Public License. The "Program", below, refers to any such program or work, and a "work based on the Program" means either the Program or any derivative work under copyright law: that is to say, a work containing the Program or a portion of it, either verbatim or with modifications and/or translated into another language. (Hereinafter, translation is included without limitation in the term "modification".) Each licensee is addressed as "you".

Activities other than copying, distribution and modification are not covered by this license; they are outside its scope. The act of running the Program is not restricted, and the output from the program is covered only if its contents constitute a work based on the program (independent of having been made by running the program). Whether that is true depends on what the program does.

1. You may copy and distribute verbatim copies of the program's source code as you receive it, in any medium, provided that you conspicuously and appropriately publish on each copy an appropriate copyright notice and disclaimer of warranty; keep intact all the notices that refer to this license and to the absence of any warranty; and give any other recipients of the program a copy of this license along with the Program.

You may charge a fee for the physical act of transferring a copy, and you may at your option offer warranty protection in exchange for a fee.

2. You may modify your copy or copies of the program or any portion of it, thus forming a work based on the Program, and copy and distribute such modifications or work under the terms of section 1 above, provided that you also meet all of these conditions:

APPENDIX

- a) You must cause the modified files to carry prominent notices stating that you changed the files and the date of any change.
- b) You must cause any work that you distribute or publish, that in whole or in part contains or is derived from the Program or any part there of, to be licensed as a whole at no charge to all third parties under the terms of this license.
- c) If the modified program normally reads commands interactively when run, you must cause it, when started running for such interactive use in the most ordinary way, to print or display an announcement including an appropriate copyright notice and a notice that there is no warranty (or else, saying that you provide a warranty) and that users may redistribute the program under these conditions, and telling the user how to view a copy of this license. (Exception: if the Program itself is interactive but does not normally print such an announcement, your work based on the Program is not required to print an announcement.)

These requirements apply to the modified work as a whole. If identifiable sections of that work are not derived from the Program, and can be reasonably considered independent and separate works in themselves, then this license, and its terms, do not apply to those sections when you distribute them as separate works. But when you distribute the same sections as part of a whole which is a work based on the Program, the distribution of the whole must be on the terms of this license, whose permissions for other licensees extend to the entire whole, and thus to each and every part regardless of who wrote it.

Thus, it is not the intent of this section to claim rights or contest your rights to work written entirely by you; rather, the intent is to exercise the right to control the distribution of derivative or collective works based on the program.

In addition, mere aggregation of another work not based on the program with the Program (or with a work based on the program) on a volume of a storage or distribution medium does not bring the other work under the scope of this license.

- 3. You may copy and distribute the program (or a work based on it, under section 2) in object code or executable form under the terms of sections 1 and 2 above provided that you also do one of the following:
 - a) Accompany it with the complete corresponding machine-readable source code, which must be distributed under the terms of sections 1 and 2 above on a medium customarily used for software interchange; or,

- b) Accompany it with a written offer, valid for at least three years, to give any third party, for a charge no more than your cost of physically performing source distribution, a complete machine-readable copy of the corresponding source code, to be distributed under the terms of sections 1 and 2 above on a medium customarily used for software interchange; or,
- c) Accompany it with the information you received as to the offer to distribute corresponding source code. (This alternative is allowed only for noncommercial distribution and only if you received the program in object code or executable form with such an offer, in accord with Subsection b above.)

The source code for a work means the preferred form of the work for making modifications to it. For an executable work, complete source code means all the source code for all modules it contains, plus any associated interface definition files, plus the scripts used to control compilation and installation of the executable. However, as a special exception, the source code distributed need not include anything that is normally distributed (in either source or binary form) with the major components (compiler, kernel, and so on) of the operating system on which the executable runs, unless that component itself accompanies the executable.

If distribution of executable or object code is made by offering access to copy from a designated place, then offering equivalent access to copy the source code from the same place counts as distribution of the source code, even though third parties are not compelled to copy the source along with the object code.

- 4. You may not copy, modify, sublicense, or distribute the Program except as expressly provided under this license. Any attempt otherwise to copy, modify, sublicense or distribute the Program is void, and will automatically terminate your rights under this license. However, parties who have received copies, or rights, from you under this license will not have their licenses terminated so long as such parties remain in full compliance.
- 5. You are not required to accept this license, since you have not signed it. However, nothing else grants you permission to modify or distribute the Program or its derivative works. These actions are prohibited by law if you do not accept this license. Therefore, by modifying or distributing the program (or any work based on the program), you indicate your acceptance of this license to do so, and all its terms and conditions for copying, distributing or modifying the program or works based on it.
- 6. Each time you redistribute the program (or any work based

on the Program), the recipient automatically receives a license from the original licensor to copy, distribute or modify the Program subject to these terms and conditions. You may not impose any further restrictions on the recipients' exercise of the rights granted herein. You are not responsible for enforcing compliance by third parties to this license.

7. If, as a consequence of a court judgment or allegation of patent infringement or for any other reason (not limited to patent issues), conditions are imposed on you (whether by court order, agreement or otherwise) that contradict the conditions of this license, they do not excuse you from the conditions of this license. If you cannot distribute so as to satisfy simultaneously your obligations under this license and any other pertinent obligations, then as a consequence you may not distribute the program at all. For example, if a patent license would not permit royalty-free redistribution of the program by all those who receive copies directly or indirectly through you, then the only way you could satisfy both it and this license would be to refrain entirely from distribution of the program.

If any portion of this section is held invalid or unenforceable under any particular circumstance, the balance of the section is intended to apply and the section as a whole is intended to apply in other circumstances.

It is not the purpose of this section to induce you to infringe any patents or other property right claims or to contest validity of any such claims; this section has the sole purpose of protecting the integrity of the free software distribution system, which is implemented by public license practices. Many people have made generous contributions to the wide range of software distributed through that system in reliance on consistent application of that system; it is up to the author/donor to decide if he or she is willing to distribute software through any other system and a licensee cannot impose that choice.

This section is intended to make thoroughly clear what is believed to be a consequence of the rest of this license.

8. If the distribution and/or use of the program is restricted in certain countries either by patents or by copyrighted interfaces, the original copyright holder who places the program under this license may add an explicit geographical distribution limitation excluding those countries, so that distribution is permitted only in or among countries not thus excluded. In such case, this license incorporates the limitation as if written in the body of this license.
9. The Free Software Foundation may publish revised and/or new versions of the General Public License from time to time. Such new versions will be similar in spirit to the present

version, but may differ in detail to address new problems or concerns.

Each version is given a distinguishing version number. If the program specifies a version number of this license which applies to it and "any later version", you have the option of following the terms and conditions either of that version or of any later version published by the Free Software Foundation. If the program does not specify a version number of this license, you may choose any version ever published by the Free Software Foundation.

10. If you wish to incorporate parts of the program into other free programs whose distribution conditions are different, write to the author to ask for permission. For software which is copyrighted by the Free Software Foundation, write to the Free Software Foundation; we sometimes make exceptions for this. Our decision will be guided by the two goals of preserving the free status of all derivatives of our free software and of promoting the sharing and reuse of software generally.

NO WARRANTY

11. BECAUSE THE PROGRAM IS LICENSED FREE OF CHARGE, THERE IS NO WARRANTY FOR THE PROGRAM, TO THE EXTENT PERMITTED BY APPLICABLE LAW. EXCEPT WHEN OTHERWISE STATED IN WRITING THE COPYRIGHT HOLDERS AND/OR OTHER PARTIES PROVIDE THE PROGRAM "AS IS" WITHOUT WARRANTY OF ANY KIND, EITHER EXPRESSED OR IMPLIED, INCLUDING, BUT NOT LIMITED TO, THE IMPLIED WARRANTIES OF MERCHANTABILITY AND FITNESS FOR A PARTICULAR PURPOSE. THE ENTIRE RISK AS TO THE QUALITY AND PERFORMANCE OF THE PROGRAM IS WITH YOU. SHOULD THE PROGRAM PROVE DEFECTIVE, YOU ASSUME THE COST OF ALL NECESSARY SERVICING, REPAIR OR CORRECTION.

12. IN NO EVENT UNLESS REQUIRED BY APPLICABLE LAW OR AGREED TO IN WRITING WILL ANY COPYRIGHT HOLDER, OR ANY OTHER PARTY WHO MAY MODIFY AND/OR REDISTRIBUTE THE PROGRAM AS PERMITTED ABOVE, BE LIABLE TO YOU FOR DAMAGES, INCLUDING ANY GENERAL, SPECIAL, INCIDENTAL OR CONSEQUENTIAL DAMAGES ARISING OUT OF THE USE OR INABILITY TO USE THE PROGRAM (INCLUDING BUT NOT LIMITED TO LOSS OF DATA OR DATA BEING RENDERED INACCURATE OR LOSSES SUSTAINED BY YOU OR THIRD PARTIES OR A FAILURE OF THE PROGRAM TO OPERATE WITH ANY OTHER PROGRAMS), EVEN IF SUCH HOLDER OR OTHER PARTY HAS BEEN ADVISED OF THE POSSIBILITY OF SUCH DAMAGES.

APPENDIX

END OF TERMS AND CONDITIONS

How to apply these terms to your new programs

If you develop a new program, and you want it to be of the greatest possible use to the public, the best way to achieve this is to make it free software which everyone can redistribute and change under these terms.

To do so, attach the following notices to the program. It is safest to attach them to the start of each source file to most effectively convey the exclusion of warranty; and each file should have at least the "copyright" line and a pointer to where the full notice is found.

one line to give the program's name and a brief idea of what it does.

Copyright (C) <year> <name of author>

This program is free software; you can redistribute it and/or modify it under the terms of the GNU General Public License as published by the Free Software Foundation; either version 2 of the license, or (at your option) any later version.

This program is distributed in the hope that it will be useful, but WITHOUT ANY WARRANTY; without even the implied warranty of MERCHANTABILITY or FITNESS FOR A PARTICULAR PURPOSE. See the GNU General Public License for more details.

You should have received a copy of the GNU General Public License along with this program; if not, write to the Free Software Foundation, Inc., 51 Franklin Street, Fifth Floor, Boston, MA 02110-1301 USA.

Also add information on how to contact you by electronic and paper mail.

If the program is interactive, make it output a short notice like this when it starts in an interactive mode:

Gnomovision version 69, Copyright (C) year name of author
Gnomovision comes with ABSOLUTELY NO WARRANTY; for details type 'show w'. This is free software, and you are welcome to redistribute it under certain conditions; type 'show c' for details.

The hypothetical commands 'show w' and 'show c' should show the appropriate parts of the General Public License. Of course, the commands you use may be called something other than 'show w' and 'show c'; they could even be mouse-clicks or menu items-whatever suits your program.

You should also get your employer (if you work as a programmer) or your school, if any, to sign a "copyright disclaimer" for the program, if necessary. Here is a sample; alter the names:

Yoyodyne, Inc., hereby disclaims all copyright interest in the program 'Gnomovision' (which makes passes at compilers) written by James Hacker.

signature of Ty Coon, 1 April 1989
Ty Coon, President of Vice

This General Public License does not permit incorporating your program into proprietary programs. If your program is a subroutine library, you may consider it more useful to permit linking proprietary applications with the library. If this is what you want to do, use the GNU Lesser General Public License instead of this license.

GNU LESSER GENERAL PUBLIC LICENSE

Version 2.1, February 1999

Copyright (C) 1991, 1999 Free Software Foundation, Inc. 51 Franklin Street, Fifth Floor, Boston, MA 02110-1301 USA Everyone is permitted to copy and distribute verbatim copies of this license document, but changing it is not allowed.

[This is the first released version of the Lesser GPL. It also counts as the successor of the GNU Library Public License, version 2, hence the version number 2.1.]

Preamble

The licenses for most software are designed to take away your freedom to share and change it. By contrast, the GNU General Public Licenses are intended to guarantee your freedom to share and change free software - to make sure the software is free for all its users.

This license, the Lesser General Public License, applies to some specially designated software packages - typically libraries - of the Free Software Foundation and other authors who decide to use it. You can use it too, but we suggest you first think carefully about whether this license or the ordinary General Public License is the better strategy to use in any particular case, based on the explanations below.

When we speak of free software, we are referring to freedom of use, not price. Our General Public Licenses are designed to make sure that you have the freedom to distribute copies of free software (and charge for this service if you wish); that you receive source code or can get it if you want it; that you can change the software and use pieces of it in new free programs; and that you are informed that you can do these things.

To protect your rights, we need to make restrictions that forbid distributors to deny you these rights or to ask you to surrender these rights. These restrictions translate to certain responsibilities for you if you distribute copies of the library or if you modify it.

For example, if you distribute copies of the library, whether gratis or for a fee, you must give the recipients all the rights that we gave you. You must make sure that they, too, receive or can get the source code. If you link other code with the library, you must provide complete object files to the recipients, so that they can relink them with the library after making changes to the library and recompiling it. And you must show them these terms so they know their rights.

We protect your rights with a two-step method: (1) we copyright the library, and (2) we offer you this license, which gives you legal permission to copy, distribute and/or modify the library.

To protect each distributor, we want to make it very clear that there is no warranty for the free library. Also, if the library is modified by someone else and passed on, the recipients should know that what they have is not the original version, so that the original author's reputation will not be affected by problems that might be introduced by others.

Finally, software patents pose a constant threat to the existence of any free program. We wish to make sure that a company cannot effectively restrict the users of a free program by obtaining a restrictive license from a patent holder. Therefore, we insist that any patent license obtained for a version of the library must be consistent with the full freedom of use specified in this license.

Most GNU software, including some libraries, is covered by the ordinary GNU General Public License. This license, the GNU Lesser General Public License, applies to certain designated libraries, and is quite different from the ordinary General Public License. We use this license for certain libraries in order to permit linking those libraries into non-free programs.

When a program is linked with a library, whether statically or using a shared library, the combination of the two is legally speaking a combined work, a derivative of the original library. The ordinary General Public License therefore permits such linking only if the entire combination fits its criteria of freedom. The Lesser General Public License permits more lax criteria for linking other code with the library.

We call this license the "Lesser" General Public License because it does Less to protect the user's freedom than the ordinary General Public License. It also provides other free software developers Less of an advantage over competing non-free programs. These disadvantages are the reason we use the ordinary General Public License for many libraries. However, the Lesser license provides advantages in certain special circumstances.

For example, on rare occasions, there may be a special need to encourage the widest possible use of a certain library, so that it becomes a de-facto standard. To achieve this, non-free programs must be allowed to use the library. A more frequent case is that a free library does the same job as widely used non-free libraries. In this case, there is little to gain by limiting the free library to free software only, so we use the Lesser General Public License.

In other cases, permission to use a particular library in non-free programs enables a greater number of people to use a large body of free software. For example, permission to use the GNU C Library in non-free programs enables many more people to use

APPENDIX

the whole GNU operating system, as well as its variant, the GNU/Linux operating system.

Although the Lesser General Public License is less protective of the users' freedom, it does ensure that the user of a program that is linked with the Library has the freedom and the wherewithal to run that program using a modified version of the Library.

The precise terms and conditions for copying, distribution and modification follow. Pay close attention to the difference between a "work based on the library" and a "work that uses the library". The former contains code derived from the library, whereas the latter must be combined with the library in order to run.

GNU LESSER GENERAL PUBLIC LICENSE

TERMS AND CONDITIONS FOR COPYING, DISTRIBUTION AND MODIFICATION

0. This license agreement applies to any software library or other program which contains a notice placed by the copyright holder or other authorized party saying it may be distributed under the terms of this Lesser General Public License (also called "this license"). Each license is addressed as "you".

A "library" means a collection of software functions and/or data prepared so as to be conveniently linked with application programs (which use some of those functions and data) to form executables.

The "Library", below, refers to any such software library or work which has been distributed under these terms. A "work based on the Library" means either the Library or any derivative work under copyright law: that is to say, a work containing the library or a portion of it, either verbatim or with modifications and/or translated straightforwardly into another language. (Hereinafter, translation is included without limitation in the term "modification".)

"Source code" for a work means the preferred form of the work for making modifications to it. For a library, complete source code means all the source code for all modules it contains, plus any associated interface definition files, plus the scripts used to control compilation and installation of the library.

Activities other than copying, distribution and modification are not covered by this license; they are outside its scope. The act of running a program using the Library is not restricted, and output from such a program is covered only if its contents constitute a work based on the library (independent of the use of the Library in a tool for writing it).

Whether that is true depends on what the library does and what the program that uses the library does.

1. You may copy and distribute verbatim copies of the library's complete source code as you receive it, in any medium, provided that you conspicuously and appropriately publish on each copy an appropriate copyright notice and disclaimer of warranty; keep intact all the notices that refer to this license and to the absence of any warranty; and distribute a copy of this license along with the Library.
You may charge a fee for the physical act of transferring a copy, and you may at your option offer warranty protection in exchange for a fee.
2. You may modify your copy or copies of the Library or any portion of it, thus forming a work based on the Library, and copy and distribute such modifications or work under the terms of section 1 above, provided that you also meet all of these conditions:
 - a) The modified work must itself be a software library.
 - b) You must cause the files modified to carry prominent notices stating that you changed the files and the date of any change.
 - c) You must cause the whole of the work to be licensed at no charge to all third parties under the terms of this license.
 - d) If a facility in the modified Library refers to a function or a table of data to be supplied by an application program that uses the facility, other than as an argument passed when the facility is invoked, then you must make a good faith effort to ensure that, in the event an application does not supply such function or table, the facility still operates, and performs whatever part of its purpose remains meaningful.

(For example, a function in a library to compute square roots has a purpose that is entirely well-defined independent of the application. Therefore, Subsection 2d requires that any application-supplied function or table used by this function must be optional: if the application does not supply it, the square root function must still compute square roots.)

These requirements apply to the modified work as a whole. If identifiable sections of that work are not derived from the library, and can be reasonably considered independent and separate works in themselves, then this license, and its terms, do not apply to those sections when you distribute them as separate works. But when you distribute the same sections as part of a whole which is a work based on the library, the distribution of the whole must be on the terms of this license, whose permissions for other licenses extend to the entire whole, and thus to each and every part regardless of who wrote it.

Thus, it is not the intent of this section to claim rights or contest your rights to work written entirely by you; rather,

the intent is to exercise the right to control the distribution of derivative or collective works based on the library.

In addition, mere aggregation of another work not based on the library with the library (or with a work based on the library) on a volume of a storage or distribution medium does not bring the other work under the scope of this license.

3. You may opt to apply the terms of the ordinary GNU General Public License instead of this License to a given copy of the Library. To do this, you must alter all the notices that refer to this License, so that they refer to the ordinary GNU General Public License, version 2, instead of to this License. (If a newer version than version 2 of the ordinary GNU General Public License has appeared, then you can specify that version instead if you wish.) Do not make any other change in these notices.

Once this change is made in a given copy, it is irreversible for that copy, so the ordinary GNU General Public License applies to all subsequent copies and derivative works made from that copy.

This option is useful when you wish to copy part of the code of the library into a program that is not a library.

4. You may copy and distribute the library (or a portion or derivative of it, under Section 2) in object code or executable form under the terms of Sections 1 and 2 above provided that you accompany it with the complete corresponding machine-readable source code, which must be distributed under the terms of sections 1 and 2 above on a medium customarily used for software interchange.

If distribution of object code is made by offering access to copy from a designated place, then offering equivalent access to copy the source code from the same place satisfies the requirement to distribute the source code, even though third parties are not compelled to copy the source along with the object code.

5. A program that contains no derivative of any portion of the Library, but is designed to work with the Library by being compiled or linked with it, is called a “work that uses the Library”. Such a work, in isolation, is not a derivative work of the Library, and therefore falls outside the scope of this license.

However, linking a “work that uses the library” with the Library creates an executable that is a derivative of the Library (because it contains portions of the library), rather than a “work that uses the library”. The executable is therefore covered by this license. Section 6 states terms for distribution of such executable.

When a “work that uses the library” uses material from a header file that is part of the library, the object code for the work may be a derivative work of the library even though the source code is not.

Whether this is true is especially significant if the work can be linked without the library, or if the work is itself a library. The

threshold for this to be true is not precisely defined by law. If such an object file uses only numerical parameters, data structure layouts and accessories, and small macros and small inline functions (ten lines or less in length), then the use of the object file is unrestricted, regardless of whether it is legally a derivative work. (Executable containing this object code plus portions of the library will still fall under Section 6.) Otherwise, if the work is a derivative of the library, you may distribute the object code for the work under the terms of Section 6. Any executable containing that work also fall under Section 6, whether or not they are linked directly with the library itself.

6. As an exception to the sections above, you may also combine or link a “work that uses the library” with the library to produce a work containing portions of the library, and distribute that work under terms of your choice, provided that the terms permit modification of the work for the customer’s own use and reverse engineering for debugging such modifications.

You must give prominent notice with each copy of the work that the library is used in it and that the Library and its use are covered by this license. You must supply a copy of this license. If the work during execution displays copyright notices, you must include the copyright notice for the library among them, as well as a reference directing the user to the copy of this license. Also, you must do one of these things:

- a) Accompany the work with the complete corresponding machine-readable source code for the library including whatever changes were used in the work (which must be distributed under Sections 1 and 2 above); and, if the work is an executable linked with the Library, with the complete machine-readable “work that uses the Library”, as object code and/or source code, so that the user can modify the library and then relink to produce a modified executable containing the modified library. (It is understood that the user who changes the contents of definitions files in the library will not necessarily be able to recompile the application to use the modified definitions.)
- b) Use a suitable shared library mechanism for linking with the library. A suitable mechanism is one that (1) uses at run time a copy of the library already present on the user’s computer system, rather than copying library functions into the executable, and (2) will operate properly with a modified version of the library, if the user installs one, as long as the modified version is interface-compatible with the version that the work was made with.
- c) Accompany the work with a written offer, valid for at least three years, to give the same user the materials specified in Subsection 6, above, for a charge no more than the cost of performing this distribution.
- d) If distribution of the work is made by offering access to copy from a designated place, offer equivalent access to copy the above specified materials from the same place.

- e) Verify that the user has already received a copy of these materials or that you have already sent this user a copy.

For an executable, the required form of the “work that uses the library” must include any data and utility programs needed for reproducing the executable from it. However, as a special exception, the materials to be distributed need not include anything that is normally distributed (in either source or binary form) with the major components (compiler, kernel, and so on) of the operating system on which the executable runs, unless that component itself accompanies the executable.

It may happen that this requirement contradicts the license restrictions of other proprietary libraries that do not normally accompany the operating system. Such a contradiction means you cannot use both them and the library together in an executable that you distribute.

7. You may place library facilities that are a work based on the library side-by-side in a single library together with other library facilities not covered by this license, and distribute such a combined library, provided that the separate distribution of the work based on the Library and of the other library facilities is otherwise permitted, and provided that you do these two things:
 - a) Accompany the combined library with a copy of the same work based on the Library, uncombined with any other library facilities. This must be distributed under the terms of the sections above.
 - b) Give prominent notice with the combined library of the fact that part of it is a work based on the library, and explaining where to find the accompanying uncombined form of the same work.
8. You may not copy, modify, sublicense, link with, or distribute the library except as expressly provided under this license. Any attempt otherwise to copy, modify, sublicense, link with, or distribute the library is void, and will automatically terminate your rights under this license. However, parties who have received copies, or rights, from you under this license will not have their licenses terminated so long as such parties remain in full compliance.
9. You are not required to accept this license, since you have not signed it. However, nothing else grants you permission to modify or distribute the library or its derivative works. These actions are prohibited by law if you do not accept this license. Therefore, by modifying or distributing the library (or any work based on the library), you indicate your acceptance of this license to do so, and all its terms and conditions for copying, distributing or modifying the library or works based on it.
10. Each time you redistribute the library (or any work based on

the Library), the recipient automatically receives a license from the original licensor to copy, distribute, link with or modify the library subject to these terms and conditions. You may not impose any further restrictions on the recipients’ exercise of the rights granted herein. You are not responsible for enforcing compliance by third parties with this license.

11. If, as a consequence of a court judgment or allegation of patent infringement or for any other reason (not limited to patent issues), conditions are imposed on you (whether by court order, agreement or otherwise) that contradict the conditions of this license, they do not excuse you from the conditions of this license. If you cannot distribute so as to satisfy simultaneously your obligations under this license and any other pertinent obligations, then as a consequence you may not distribute the library at all. For example, if a patent license would not permit royalty-free redistribution of the library by all those who receive copies directly or indirectly through you, then the only way you could satisfy both it and this license would be to refrain entirely from distribution of the library.

If any portion of this section is held invalid or unenforceable under any particular circumstance, the balance of the section is intended to apply, and the section as a whole is intended to apply in other circumstances.

It is not the purpose of this section to induce you to infringe any patents or other property right claims or to contest validity of any such claims; this section has the sole purpose of protecting the integrity of the free software distribution system which is implemented by public license practices. Many people have made generous contributions to the wide range of software distributed through that system in reliance on consistent application of that system; it is up to the author/donor to decide if he or she is willing to distribute software through any other system and a license cannot impose that choice.

This section is intended to make thoroughly clear what is believed to be a consequence of the rest of this license.
12. If the distribution and/or use of the library is restricted in certain countries either by patents or by copyrighted interfaces, the original copyright holder who places the library under this license may add an explicit geographical distribution limitation excluding those countries, so that distribution is permitted only in or among countries not thus excluded. In such case, this license incorporates the limitation as if written in the body of this license.
13. The Free Software Foundation may publish revised and/or new versions of the Lesser General Public License from time to time. Such new versions will be similar in spirit to the present version, but may differ in detail to address new problems or concerns.

Each version is given a distinguishing version number. If the

library specifies a version number of this license which applies to it and “any later version”, you have the option of following the terms and conditions either of that version or of any later version published by the Free Software Foundation.

If the library does not specify a license version number, you may choose any version ever published by the Free Software Foundation.

14. If you wish to incorporate parts of the library into other free programs whose distribution conditions are incompatible with these, write to the author to ask for permission. For software which is copyrighted by the Free Software Foundation, write to the Free Software Foundation; we sometimes make exceptions for this. Our decision will be guided by the two goals of preserving the free status of all derivatives of our free software and of promoting the sharing and reuse of software generally.

NO WARRANTY

15. BECAUSE THE LIBRARY IS LICENSED FREE OF CHARGE, THERE IS NO WARRANTY FOR THE LIBRARY, TO THE EXTENT PERMITTED BY APPLICABLE LAW. EXCEPT WHEN OTHERWISE STATED IN WRITING THE COPYRIGHT HOLDERS AND/OR OTHER PARTIES PROVIDE THE LIBRARY “AS IS” WITHOUT WARRANTY OF ANY KIND, EITHER EXPRESSED OR IMPLIED, INCLUDING, BUT NOT LIMITED TO, THE IMPLIED WARRANTIES OF MERCHANTABILITY AND FITNESS FOR A PARTICULAR PURPOSE. THE ENTIRE RISK AS TO THE QUALITY AND PERFORMANCE OF THE LIBRARY IS WITH YOU. SHOULD THE LIBRARY PROVE DEFECTIVE, YOU ASSUME THE COST OF ALL NECESSARY SERVICING, REPAIR OR CORRECTION.

16. IN NO EVENT UNLESS REQUIRED BY APPLICABLE LAW OR AGREED TO IN WRITING WILL ANY COPYRIGHT HOLDER, OR ANY OTHER PARTY WHO MAY MODIFY AND/OR REDISTRIBUTE THE LIBRARY AS PERMITTED ABOVE, BE LIABLE TO YOU FOR DAMAGES, INCLUDING ANY GENERAL, SPECIAL, INCIDENTAL OR CONSEQUENTIAL DAMAGES ARISING OUT OF THE USE OR INABILITY TO USE THE LIBRARY (INCLUDING BUT NOT LIMITED TO LOSS OF DATA OR DATA BEING RENDERED INACCURATE OR LOSSES SUSTAINED BY YOU OR THIRD PARTIES OR A FAILURE OF THE LIBRARY TO OPERATE WITH ANY OTHER SOFTWARE), EVEN IF SUCH HOLDER OR OTHER PARTY HAS BEEN ADVISED OF THE POSSIBILITY OF SUCH DAMAGES.

END OF TERMS AND CONDITIONS

How to apply these terms to your new libraries

If you develop a new library, and you want it to be of the greatest possible use to the public, we recommend making it free software that everyone can redistribute and change. You can do so by permitting redistribution under these terms (or, alternatively, under the terms of the ordinary General Public License).

To apply these terms, attach the following notices to the library. It is safest to attach them to the start of each source file to most effectively convey the exclusion of warranty; and each file should have at least the “copyright” line and a pointer to where the full notice is found.

one line to give the library’s name and a brief idea of what it does.

Copyright (C) <year> <name of author>

This library is free software; you can redistribute it and/or modify it under the terms of the GNU Lesser General Public License as published by the Free Software Foundation; either version 2.1 of the license, or (at your option) any later version.

This library is distributed in the hope that it will be useful, but WITHOUT ANY WARRANTY; without even the implied warranty of MERCHANTABILITY or FITNESS FOR A PARTICULAR PURPOSE. See the GNU Lesser General Public License for more details.

You should have received a copy of the GNU Lesser General Public License along with this library; if not, write to the Free Software Foundation, Inc., 51 Franklin Street, Fifth Floor, Boston, MA 02110-1301 USA

Also add information on how to contact you by electronic and paper mail.

You should also get your employer (if you work as a programmer) or your school, if any, to sign a “copyright disclaimer” for the library, if necessary. Here is a sample; alter the names:

Yoyodyne, Inc., hereby disclaims all copyright interest in the library ‘Frob’ (a library for tweaking knobs) written by James Random Hacker.

signature of Ty Coon, 1 April 1990

Ty Coon, President of Vice

MOZILLA PUBLIC LICENSE

Version 1.1

1. Definitions.

1.0.1. “Commercial use” means distribution or otherwise making the covered code available to a third party.

1.1. “Contributor” means each entity that creates or contributes to the creation of modifications.

1.2. “Contributor version” means the combination of the original code, prior modifications used by a contributor, and the modifications made by that particular contributor.

1.3. “Covered code” means the original code or modifications or the combination of the original code and modifications, in each case including portions thereof.

1.4. “Electronic distribution mechanism” means a mechanism generally accepted in the software development community for the electronic transfer of data.

1.5. “Executable” means covered code in any form other than source code.

1.6. “Initial developer” means the individual or entity identified as the initial Developer in the Source Code notice required by exhibit A.

1.7. “Larger work” means a work which combines covered code or portions thereof with code not governed by the terms of this License.

1.8. “License” means this document.

1.8.1. “Licensable” means having the right to grant, to the maximum extent possible, whether at the time of the initial grant or subsequently acquired, any and all of the rights conveyed herein.

1.9. “Modifications” means any addition to or deletion from the substance or structure of either the original code or any previous modifications. When covered code is released as a series of files, a modification is:

A. Any addition to or deletion from the contents of a file containing original code or previous modifications.

B. Any new file that contains any part of the original code or previous modifications.

1.10. “Original code” means source code of computer software code which is described in the source code notice required by exhibit as original code, and which, at the time of its release under this license is not already covered code governed by this license.

1.10.1. “Patent claims” means any patent claim(s), now owned or hereafter acquired, including without limitation, method, process, and apparatus claims, in any patent licensable by grantor.

1.11. “Source code” means the preferred form of the covered code for making modifications to it, including all modules it contains, plus any associated interface definition files, scripts used to control compilation and installation of an executable, or source code differential comparisons against either the original code or another well known, available covered code of the contributor’s choice. The source code can be in a compressed or archival form, provided the appropriate decompression or de-archiving software is widely available for no charge.

1.12. “You” (or “Your”) means an individual or a legal entity exercising rights under, and complying with all of the terms of, this license or a future version of this license issued under section 6.1.

For legal entities, “You” includes any entity which controls, is controlled by, or is under common control with You. For purposes of this definition, “control” means (a) the power, direct or indirect, to cause the direction or management of such entity, whether by contract or otherwise, or (b) ownership of more than fifty percent (50%) of the outstanding shares or beneficial ownership of such entity.

2. Source Code License.

2.1. The initial developer grant.

The initial developer hereby grants You a world-wide, royalty-free, non-exclusive license, subject to third party intellectual property claims:

(a) under intellectual property rights (other than patent or trademark) licensable by initial developer to use, reproduce, modify, display, perform, sublicense and distribute the original code (or portions thereof) with or without modifications, and/or as part of a larger work; and

(b) under patents claims infringed by the making, using or selling of original code, to make, have made, use,

- practice, sell, and offer for sale, and/or otherwise dispose of the original code (or portions thereof).
- (c) the licenses granted in this section 2.1(a) and (b) are effective on the date Initial developer first distributes original code under the terms of this license.
 - (d) Notwithstanding section 2.1(b) above, no patent license is granted: 1) for code that You delete from the original Code; 2) separate from the original code; or 3) for infringements caused by: i) the modification of the original code or ii) the combination of the original code with other software or devices.

2.2. Contributor Grant.

Subject to third party intellectual property claims, each contributor hereby grants You a world-wide, royalty-free, non-exclusive license

- (a) under intellectual property rights (other than patent or trademark) licensable by contributor, to use, reproduce, modify, display, perform, sublicense and distribute the modifications created by such contributor (or portions thereof) either on an unmodified basis, with other modifications, as covered code and/or as part of a larger work; and
- (b) under patent claims infringed by the making, using, or selling of modifications made by that contributor either alone and/or in combination with its contributor version (or portions of such combination), to make, use, sell, offer for sale, have made, and/or otherwise dispose of: 1) modifications made by that contributor (or portions thereof); and 2) the combination of modifications made by that contributor with its contributor version (or portions of such combination).
- (c) the licenses granted in sections 2.2(a) and 2.2(b) are effective on the date contributor first makes commercial use of the covered code.
- (d) Notwithstanding section 2.2(b) above, no patent license is granted: 1) for any code that contributor has deleted from the contributor version; 2) separate from the contributor version; 3) for infringements caused by: i) third party modifications of contributor version or ii) the combination of modifications made by that contributor with other software (except as part of the contributor version) or other devices; or 4) under patent claims infringed by covered code in the absence of modifications made by that contributor.

3. Distribution Obligations.

3.1. Application of license.

The modifications which You create or to which you contribute are governed by the terms of this license, including without limitation section 2.2. The source code version of covered code may be distributed only under the terms of this license or a future version of this license released under section 6.1, and you must include a copy of this license with every copy of the source code you distribute. You may not offer or impose any terms on any source code version that alters or restricts the applicable version of this license or the recipients' rights hereunder. However, you may include an additional document offering the additional rights described in section 3.5.

3.2. Availability of source code.

Any modification which you create or to which you contribute must be made available in source code form under the terms of this license either on the same media as an executable version or via an accepted electronic distribution mechanism to anyone to whom you made an executable version available; and if made available via electronic distribution mechanism, must remain available for at least twelve (12) months after the date it initially became available, or at least six (6) months after a subsequent version of that particular modification has been made available to such recipients. You are responsible for ensuring that the source code version remains available even if the electronic distribution mechanism is maintained by a third party.

3.3. Description of modifications.

You must cause all covered code to which you contribute to contain a file documenting the changes You made to create that covered code and the date of any change. You must include a prominent statement that the modification is derived, directly or indirectly, from original code provided by the initial developer and including the name of the initial developer in (a) the source code, and (b) in any notice in an executable version or related documentation in which you describe the origin or ownership of the covered code.

3.4. Intellectual property matters

(a) Third party claims.

If contributor has knowledge that a license under a third party's intellectual property rights is required to exercise the rights granted by such contributor under sections 2.1 or 2.2, contributor must include a text file with the source code distribution titled "LEGAL" which describes the claim and the party making the claim in sufficient detail that a recipient will know whom to

contact. If contributor obtains such knowledge after the modification is made available as described in section 3.2, contributor shall promptly modify the LEGAL file in all copies contributor makes available thereafter and shall take other steps (such as notifying appropriate mailing lists or newsgroups) reasonably calculated to inform those who received the covered code that new knowledge has been obtained.

(b) Contributor APIs.

If contributor's modifications include an application programming interface and contributor has knowledge of patent licenses which are reasonably necessary to implement that API, contributor must also include this information in the LEGAL file.

(c) Representations.

contributor represents that, except as disclosed pursuant to section 3.4(a) above, contributor believes that contributor's modifications are contributor's original creation(s) and/or contributor has sufficient rights to grant the rights conveyed by this license.

3.5. Required notices.

You must duplicate the notice in exhibit A in each file of the source code. If it is not possible to put such notice in a particular source code file due to its structure, then You must include such notice in a location (such as a relevant directory) where a user would be likely to look for such a notice. If You created one or more modification(s), you may add your name as a contributor to the notice described in exhibit A. you must also duplicate this license in any documentation for the source code where You describe recipients' rights or ownership rights relating to covered code. You may choose to offer, and to charge a fee for, warranty, support, indemnity or liability obligations to one or more recipients of covered code. However, you may do so only on your own behalf, and not on behalf of the Initial developer or any contributor. You must make it absolutely clear than any such warranty, support, indemnity or liability obligation is offered by you alone, and You hereby agree to indemnify the Initial developer and every contributor for any liability incurred by the Initial developer or such contributor as a result of warranty, support, indemnity or liability terms you offer.

3.6. Distribution of executable versions.

You may distribute covered code in executable form only if the requirements of section 3.1-3.5 have been met for that covered code, and if you include a notice stating that the source code version of the covered code is available under the terms of this license, including a description of how and where you have fulfilled the obligations of section 3.2. The notice must be conspicuously included in any notice in an executable version, related documentation or collateral

in which you describe recipients' rights relating to the covered code. You may distribute the executable version of covered code or ownership rights under a license of your choice, which may contain terms different from this license, provided that you are in compliance with the terms of this license and that the license for the executable version does not attempt to limit or alter the recipient's rights in the source code version from the rights set forth in this license. If you distribute the executable version under a different license you must make it absolutely clear that any terms which differ from this license are offered by you alone, not by the Initial developer or any contributor. You hereby agree to indemnify the initial developer and every contributor for any liability incurred by the initial developer or such contributor as a result of any such terms You offer.

3.7. Larger works.

You may create a larger work by combining covered code with other code not governed by the terms of this license and distribute the larger work as a single product. In such a case, you must make sure the requirements of this license are fulfilled for the covered code.

4. Inability to comply due to statute or regulation.

If it is impossible for you to comply with any of the terms of this license with respect to some or all of the covered code due to statute, judicial order, or regulation then you must: (a) comply with the terms of this license to the maximum extent possible; and (b) describe the limitations and the code they affect. Such description must be included in the LEGAL file described in section 3.4 and must be included with all distributions of the source code. Except to the extent prohibited by statute or regulation, such description must be sufficiently detailed for a recipient of ordinary skill to be able to understand it.

5. Application of this license.

This license applies to code to which the initial developer has attached the notice in exhibit A and to related covered code.

6. Versions of the license.

6.1. New versions.

Netscape communications corporation ("Netscape") may publish revised and/or new versions of the license from time to time. Each version will be given a distinguishing version number.

6.2. Effect of new versions.

Once covered code has been published under a

particular version of the license, you may always continue to use it under the terms of that version. You may also choose to use such covered code under the terms of any subsequent version of the license published by netscape. No one other than netscape has the right to modify the terms applicable to covered code created under this license.

6.3. Derivative works.

If You create or use a modified version of this license (which you may only do in order to apply it to code which is not already covered code governed by this license), You must (a) rename Your license so that the phrases "Mozilla", "MOZILLAPL", "MOZPL", "Netscape", "MPL", "NPL" or any confusingly similar phrase do not appear in your license (except to note that your license differs from this license) and (b) otherwise make it clear that Your version of the license contains terms which differ from the Mozilla Public license and netscape Public License. (Filling in the name of the initial developer, original code or contributor in the notice described in exhibit A shall not of themselves be deemed to be modifications of this license.)

7. DISCLAIMER OF WARRANTY.

COVERED CODE IS PROVIDED UNDER THIS LICENSE ON AN "AS IS" BASIS, WITHOUT WARRANTY OF ANY KIND, EITHER EXPRESSED OR IMPLIED, INCLUDING, WITHOUT LIMITATION, WARRANTIES THAT THE COVERED CODE IS FREE OF DEFECTS, MERCHANTABILITY, FIT FOR A PARTICULAR PURPOSE OR NON-INFRINGEMENT. THE ENTIRE RISK AS TO THE QUALITY AND PERFORMANCE OF THE COVERED CODE IS WITH YOU. SHOULD ANY COVERED CODE PROVE DEFECTIVE IN ANY RESPECT, YOU (NOT THE INITIAL DEVELOPER OR ANY OTHER CONTRIBUTOR) ASSUME THE COST OF ANY NECESSARY SERVICING, REPAIR OR CORRECTION. THIS DISCLAIMER OF WARRANTY CONSTITUTES AN ESSENTIAL PART OF THIS LICENSE. NO USE OF ANY COVERED CODE IS AUTHORIZED HEREUNDER EXCEPT UNDER THIS DISCLAIMER.

8. TERMINATION.

8.1. This license and the rights granted hereunder will terminate automatically if you fail to comply with terms herein and fail to cure such breach within 30 days of becoming aware of the breach. All sublicenses to the covered code which are properly granted shall survive any termination of this license. Provisions which, by their nature, must remain in effect beyond the termination of this license shall survive.

8.2. If you initiate litigation by asserting a patent

infringement claim (excluding declaratory judgment actions) against initial developer or a contributor (the initial developer or contributor against whom you file such action is referred to as "Participant") alleging that:

(a) such participant's contributor version directly or indirectly infringes any patent, then any and all rights granted by such participant to you under sections 2.1 and/or 2.2 of this license shall, upon 60 days notice from Participant terminate prospectively, unless if within 60 days after receipt of notice you either: (i) agree in writing to pay participant a mutually agreeable reasonable royalty for your past and future use of modifications made by such participant, or (ii) withdraw your litigation claim with respect to the contributor version against such participant. If within 60 days of notice, a reasonable royalty and payment arrangement are not mutually agreed upon in writing by the parties or the litigation claim is not withdrawn, the rights granted by participant to you under sections 2.1 and/or 2.2 automatically terminate at the expiration of the 60 day notice period specified above.

(b) any software, hardware, or device, other than such participant's contributor Version, directly or indirectly infringes any patent, then any rights granted to You by such participant under sections 2.1(b) and 2.2(b) are revoked effective as of the date you first made, used, sold, distributed, or had made, modifications made by that participant.

8.3. If you assert a patent infringement claim against participant alleging that such participant's contributor version directly or indirectly infringes any patent where such claim is resolved (such as by license or settlement) prior to the initiation of patent infringement litigation, then the reasonable value of the licenses granted by such participant under sections 2.1 or 2.2 shall be taken into account in determining the amount or value of any payment or license.

8.4. In the event of termination under sections 8.1 or 8.2 above, all end user license agreements (excluding distributors and resellers) which have been validly granted by you or any distributor hereunder prior to termination shall survive termination.

9. LIMITATION OF LIABILITY.

UNDER NO CIRCUMSTANCES AND UNDER NO LEGAL THEORY, WHETHER TORT (INCLUDING NEGLIGENCE), CONTRACT, OR OTHERWISE, SHALL YOU, THE INITIAL DEVELOPER, ANY OTHER CONTRIBUTOR, OR ANY DISTRIBUTOR OF COVERED

CODE, OR ANY SUPPLIER OF ANY OF SUCH PARTIES, BE LIABLE TO ANY PERSON FOR ANY INDIRECT, SPECIAL, INCIDENTAL, OR CONSEQUENTIAL DAMAGES OF ANY CHARACTER INCLUDING, WITHOUT LIMITATION, DAMAGES FOR LOSS OF GOODWILL, WORK STOPPAGE, COMPUTER FAILURE OR MALFUNCTION, OR ANY AND ALL OTHER COMMERCIAL DAMAGES OR LOSSES, EVEN IF SUCH PARTY SHALL HAVE BEEN INFORMED OF THE POSSIBILITY OF SUCH DAMAGES. THIS LIMITATION OF LIABILITY SHALL NOT APPLY TO LIABILITY FOR DEATH OR PERSONAL INJURY RESULTING FROM SUCH PARTY'S NEGLIGENCE TO THE EXTENT APPLICABLE LAW PROHIBITS SUCH LIMITATION. SOME JURISDICTIONS DO NOT ALLOW THE EXCLUSION OR LIMITATION OF INCIDENTAL OR CONSEQUENTIAL DAMAGES, SO THIS EXCLUSION AND LIMITATION MAY NOT APPLY TO YOU.

10. U.S. GOVERNMENT END USERS.

The covered code is a "commercial item," as that term is defined in 48 C.F.R. 2.101 (Oct. 1995), consisting of "commercial computer software" and "commercial computer software documentation," as such terms are used in 48 C.F.R. 12.212 (Sept. 1995). Consistent with 48 C.F.R. 12.212 and 48 C.F.R. 227.7202-1 through 227.7202-4 (June 1995), all U.S. Government end users acquire covered code with only those rights set forth herein.

11. MISCELLANEOUS.

This license represents the complete agreement concerning subject matter hereof. If any provision of this license is held to be unenforceable, such provision shall be reformed only to the extent necessary to make it enforceable. This License shall be governed by California law provisions (except to the extent applicable law, if any, provides otherwise), excluding its conflict-of-law provisions. With respect to disputes in which at least one party is a citizen of, or an entity chartered or registered to do business in the united states of america, any litigation relating to this License shall be subject to the jurisdiction of the federal courts of the northern district of california, with venue lying in santa clara county, california, with the losing party responsible for costs, including without limitation, court costs and reasonable attorneys' fees and expenses. The application of the united nations convention on contracts for the International sale of goods is expressly excluded. Any law or regulation which provides that the language of a contract shall be construed against the drafter shall not apply to this license.

12. RESPONSIBILITY FOR CLAIMS.

As between initial developer and the contributors, each party is responsible for claims and damages arising, directly or indirectly, out of its utilization of rights under this license and you agree to work with initial developer and contributors to distribute such responsibility on an equitable basis. Nothing herein is intended or shall be deemed to constitute any admission of liability.

13. MULTIPLE-LICENSED CODE.

Initial developer may designate portions of the covered code as "Multiple-Licensed". "Multiple-Licensed" means that the initial developer permits you to utilize portions of the covered code under your choice of the NPL or the alternative licenses, if any, specified by the initial developer in the file described in exhibit A.

EXHIBIT A -Mozilla Public License.

The contents of this file are subject to the Mozilla Public License Version 1.1 (the "license"); you may not use this file except in compliance with the License. You may obtain a copy of the license at <http://www.mozilla.org/MPL/>

Software distributed under the license is distributed on an "AS IS" basis, WITHOUT WARRANTY OF ANY KIND, either express or implied. See the license for the specific language governing rights and limitations under the License.

The Original Code is _____.
The Initial Developer of the Original Code is _____.
Portions created by _____ are Copyright (C) _____.
All Rights Reserved.
Contributor(s): _____.

Alternatively, the contents of this file may be used under the terms of the _____ license (the "[] License"), in which case the provisions of [] license are applicable instead of those above. If you wish to allow use of your version of this file only under the terms of the [] license and not to allow others to use your version of this file under the MPL, indicate your decision by deleting the provisions above and replace them with the notice and other provisions required by the [] license. If you do not delete the provisions above, a recipient may use your version of this file under either the MPL or the [] license."

NOTE: The text of this exhibit A may differ slightly from the text of the notices in the source code files of the original code. You should use the text of this exhibit A rather than the text found in the original code/source code for Your modifications.



The model and serial number of the TV is located on the back and/or on one side of the TV. Record these numbers below should you ever need service.

MODEL _____

SERIAL _____

1-800-243-0000	USA, Consumer User
1-888-865-3026	USA, Commercial User
1-888-542-2623	CANADA

LG Customer Information Center



LG

Life's Good

**32LD660H 37LD660H 42LD660H
32LD665H 37LD665H 42LD665H
32LV555H 37LV555H 42LV555H 47LV555H 55LV555H**

Lodging Guest Interactive Pro:Centric™ TVs

Commercial Mode Setup Guide

Note: Selected features shown in this guide may not be available on all models.

EXPERIENCED INSTALLER

Master TV Setup
pages 11–14

Cloning Information
pages 24–32

FTG Mode of Operation
pages 33–44

For Customer Support/Service, please call:
1-888-865-3026

The latest product information and documentation is available online at:
www.LG solutions.com/products

MODEL and SERIAL NUMBER

The model and serial numbers of this TV are located on the back of the cabinet. For future reference, LG suggests that you record those numbers here:

Model No. _____ Serial No. _____



WARNING:

TO REDUCE THE RISK OF ELECTRIC SHOCK DO NOT REMOVE COVER (OR BACK). NO USER-SERVICEABLE PARTS INSIDE. REFER TO QUALIFIED SERVICE PERSONNEL.



The lightning flash with arrowhead symbol, within an equilateral triangle, is intended to alert the user to the presence of uninsulated “dangerous voltage” within the product’s enclosure that may be of sufficient magnitude to constitute a risk of electric shock to persons.



The exclamation point within an equilateral triangle is intended to alert the user to the presence of important operating and maintenance (servicing) instructions in the literature accompanying the appliance.

WARNING:

TO PREVENT FIRE OR SHOCK HAZARDS, DO NOT EXPOSE THIS PRODUCT TO RAIN OR MOISTURE.

Power Cord Polarization:

This product is equipped with a 3-wire grounding-type alternating current power plug. This plug will fit into the power outlet only one way. This is a safety feature. If you are unable to insert the plug fully into the outlet, contact your electrician to replace your obsolete outlet. Do not defeat the safety purpose of the 3-wire grounding-type plug.

NOTE TO CABLE/TV INSTALLER:

This reminder is provided to call the cable TV system installer’s attention to Article 820-40 of the National Electrical Code (U.S.A.). The code provides guidelines for proper grounding and, in particular, specifies that the cable ground shall be connected to the grounding system of the building, as close to the point of the cable entry as practical.

REGULATORY INFORMATION:

This equipment has been tested and found to comply with the limits for a Class B digital device, pursuant to Part 15 of the FCC Rules. These limits are designed to provide reasonable protection against harmful interference when the equipment is operated in a residential installation. This equipment generates, uses and can radiate radio frequency energy and, if not installed and used in accordance with the instruction manual, may cause harmful interference to radio communications. However, there is no guarantee that interference will not occur in a particular installation. If this equipment does cause harmful interference to radio or television reception, which can be determined by turning the equipment off and on, the user is encouraged to try to correct the interference by one or more of the following measures:

- Reorient or relocate the receiving antenna.
- Increase the separation between the equipment and receiver.
- Connect the equipment to an outlet on a circuit different from that to which the receiver is connected.
- Consult the dealer or an experienced radio/TV technician for help.

CAUTION:

Do not attempt to modify this product in any way without written authorization from LG Electronics U.S.A., Inc. Unauthorized modification could void the user’s authority to operate this product.

COMPLIANCE:

The responsible party for this product’s compliance is: LG Electronics U.S.A., Inc.
1000 Sylvan Avenue, Englewood Cliffs, NJ 07632, USA • Phone: 1-201-816-2000

Marketed and Distributed in the United States by LG Electronics U.S.A., Inc.
1000 Sylvan Avenue, Englewood Cliffs, NJ 07632

IMPORTANT SAFETY INSTRUCTIONS

1. Read these instructions.
2. Keep these instructions.
3. Heed all warnings.
4. Follow all instructions.
5. Do not use this apparatus near water.
6. Clean only with dry cloth.
7. Do not block any ventilation openings. Install in accordance with the manufacturer's instructions.
8. Do not install near any heat sources, such as radiators, heat registers, stoves, or other apparatus (including amplifiers) that produce heat.
9. Do not defeat the safety purpose of the polarized or grounding-type plug. A polarized plug has two blades with one wider than the other. A grounding-type plug has two blades and a third grounding prong. The wide blade or the third prong are provided for your safety. If the provided plug does not fit into your outlet, consult an electrician for replacement of the obsolete outlet.
10. Protect the power cord from being walked on or pinched, particularly at plugs, convenience receptacles, and the point where it exits from the apparatus.
11. Only use attachments/accessories specified by the manufacturer.
12. Use only with the cart, stand, tripod, bracket, or table specified by the manufacturer or sold with the apparatus. When a cart is used, use caution when moving the cart/apparatus combination in order to avoid injury from tip-over.



PORTABLE CART WARNING

13. Refer all servicing to qualified service personnel. Servicing is required when the apparatus has been damaged in any way, such as power-supply cord or plug is damaged, liquid has been spilled or objects have fallen into the apparatus, the apparatus has been exposed to rain or moisture, does not operate normally, or has been dropped.
14. Never touch this apparatus or antenna during a thunder or lightning storm.
15. When mounting a TV on the wall, make sure not to install the TV by the hanging power and signal cables on the back of the TV.
16. Do not allow an impact shock or any objects to fall into the product, and do not drop objects onto the screen.

17. Power Cord

Caution: It is recommended that appliances be placed upon a dedicated circuit; that is, a single outlet circuit which powers only that appliance and has no additional outlets or branch circuits. Check the specification page in the Owner's Manual to be certain.

Periodically examine the cord of your appliance, and if its appearance indicates damage or deterioration, unplug it, discontinue use of the appliance, and have the cord replaced with an exact replacement part by an authorized servicer. Protect the power cord from physical or mechanical abuse, such as twisting, kinking, or pinching or being closed in a door or walked upon. Pay particular attention to plugs, wall outlets, and the point where the cord exits the appliance.

Do not use a damaged or loose power cord. Be sure to grasp the plug when unplugging the power cord. Do not pull on the power cord to unplug the TV.

18. Overloading

Do not connect too many appliances to the same AC power outlet as this could result in fire or electric shock. Do not overload wall outlets. Overloaded wall outlets, loose or damaged wall outlets, extension cords, frayed power cords, or damaged or cracked wire insulation are dangerous. Any of these conditions could result in fire or electric shock.

19. Outdoor Use/Wet Location



Warning: To reduce the risk of fire or electrical shock, do not expose this product to rain, moisture or other liquids.

Do not touch the TV with wet hands. Do not install this product near flammable objects such as gasoline or candles or expose the TV to direct air conditioning.

Do not expose to dripping or splashing and do not place objects filled with liquids, such as vases, cups, etc., on or over the apparatus (e.g., on shelves above the unit).

20. Grounding

Ensure that you connect the earth ground wire to prevent possible electric shock (i.e., a TV with a three-prong grounded AC plug must be connected to a three-prong grounded AC outlet). If grounding methods are not possible, have a qualified electrician install a separate circuit breaker. Do not try to ground the unit by connecting it to telephone wires, lightning rods, or gas pipes.

21. Disconnect Device

The mains plug is the disconnecting device. The plug must remain readily operable.

As long as this unit is connected to the AC wall outlet, it is not disconnected from the AC power source even if you turn off this unit by SWITCH.

(Continued on next page)

IMPORTANT SAFETY INSTRUCTIONS

(Continued from previous page)

22. Outdoor Antenna Grounding

If an outside antenna or cable system is connected to the product, follow the precautions below.

An outdoor antenna system should not be located in the vicinity of overhead power lines or other electric light or power circuits or where it can come into contact with such power lines or circuits as death or serious injury can occur.

Be sure the antenna system is grounded so as to provide some protection against voltage surges and built-up static charges.

Article 810 of the National Electrical Code (NEC) in the U.S.A. provides information with respect to proper grounding of the mast and supporting structure, grounding of the lead-in wire to an antenna-discharge unit, size of grounding conductors, location of antenna-discharge unit, connection to grounding electrodes, and requirements for the grounding electrode.

Antenna Grounding According to NEC, ANSI/NFPA 70

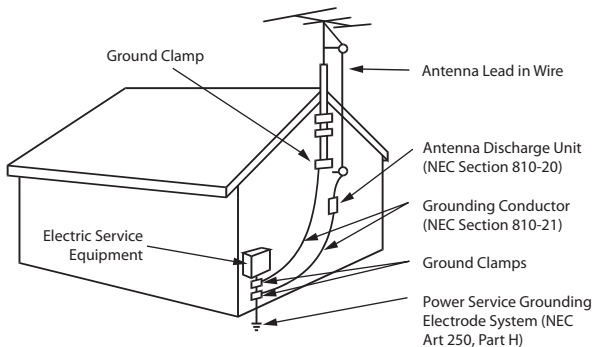

23. Cleaning

When cleaning, unplug the power cord and wipe gently with a soft cloth to prevent scratching. Do not spray water or other liquids directly on the TV as electric shock may occur. Do not clean with chemicals such as alcohol, thinners or benzene.

24. Transporting Product

Make sure the TV is turned Off and unplugged and that all cables have been removed. It may take two or more people to carry larger TVs. Do not press against or put stress on the front panel of the TV during transport.

25. Ventilation

Install the TV where there is proper ventilation. Do not install in a confined space such as a bookcase. Do not cover the product with cloth or other materials (e.g., plastic) while it is plugged in. Do not install in excessively dusty places.

26. Do not touch the ventilation openings, as they may become hot while the TV is operating.
27. If you smell smoke or other odors coming from the TV or hear strange sounds, unplug the power cord, and contact an authorized service center.
28. Do not press against the front panel of the TV with your hand or a sharp object (e.g., a nail, pencil, or pen) or make a scratch on it.
29. Keep the product away from direct sunlight.
30. **Dot Defect**
The LCD panel is a high technology product with resolution of two million to six million pixels. In a very few cases, you could see fine dots on the screen while you are viewing the TV. Those dots are deactivated pixels and do not affect the performance and reliability of the TV.

31. Generated Sound

“Cracking”: A cracking noise that occurs while the TV is On or when it is turned Off is generated by plastic thermal contraction due to temperature and humidity. This noise is common for products where thermal deformation is required.

Electrical circuit humming/panel buzzing: A low level noise is generated from a high-speed switching circuit, which supplies a large amount of current to operate a product. It varies depending on the product. This generated sound does not affect the performance and reliability of the product.

32. For LCD TV

If the TV feels cold to the touch, there may be a small “flicker” when it is turned On. This is normal; there is nothing wrong with the TV. Some minute dot defects may be visible on the screen, appearing as tiny red, green, or blue spots. However, they have no adverse effect on the TV’s performance. Avoid touching the LCD screen or holding your finger(s) against it for long periods of time. Doing so may produce some temporary distortion effects on the screen.

Table of Contents

Safety Warnings	2	FTG Mode via CPU	35–38
Important Safety Instructions	3–4	Creating an FTG Configuration File using the	
Table of Contents	5	FTG File Manager	35
Commercial Mode Overview	6–7	Teaching FTG Configuration to a TV	37
Setup Checklist	6	Learning an FTG Configuration File from a TV	38
Pass-through Mode	6	Optional Manual Configuration / TV Setup	39
FTG Mode	7	FTG Mode via EBL (Local Configuration)	40
Remote Management in FTG Mode	7	FTG File Manager Utilities Overview	41–44
External MPI Control	7	FTG File Manager Main Screen	41
Pro:Centric Operation	8–9	FTG Channel Map Configuration Utility	42
Pro:Centric TV Interactive Menu Features	8	FTG Channel Map Editor	43
Pro:Centric Setup	9	FTG Installer Menu Configuration Utility	44
Pro:Centric Modes of Operation	9	IP Environment Setup	45–46
Installer Remote Control Typical Key Functions	10	Remote Jack Pack / TV Connections & Setup	47
Master TV Setup	11–14	References	
Before You Begin	11	Upgrading TV/PTC Software using a USB Memory	
Cloning Methods	11	Device	48
Clonable TV Setup Menu Features	11	Downloading a Splash Screen using a USB Memory	
Master TV Setup Procedure	12	Device	49
Installer Menu	15–22	Power Consumption Settings	50–51
Accessing the Installer Menu	15	TV Camport Auto Sense Operation	52
Using the Installer Menu	15	TV Aux Input Configuration	53
Exiting the Installer Menu and Activating Updates	15	b-LAN Setup & Overview	54
Channel Icons / Custom Text Labels		RJP Model List and Input Auto-sensing Hierarchy	55
(2-5-4 + MENU Mode)	23	Resetting Factory Defaults on the TV(s)	56
Cloning Overview	24	TV Zone Restrictions	57
USB Cloning Procedures	25–28	LD660H/LD665H Rear Jack Panel	58
Learning / Teaching a Master TV Setup using		LV555H Rear Jack Panel	59
a USB Memory Device / .tlx File	25	Side Connections Panel	60
Learning / Teaching a Master TV Setup using		RF Antenna Connection	61
a USB Memory Device / .tll File	27	Troubleshooting	62–65
Clone Programmer Cloning Procedures	29–32	General Troubleshooting	62
Learning / Teaching a Master TV Setup using		Troubleshooting Flow Chart	63
a TLL-1100A Clone Programmer	29	Commercial Mode Check / FTG Operation	
Learning / Teaching a Master TV Setup using		Troubleshooting	64
an LT2002 Clone Programmer	31	Clone Programmer Troubleshooting	65
FTG Mode of Operation Overview	33–34	Glossary of Terms	66
FTG Mode via CPU or EBL	33	Document Revision History / Notes	67
Determining the TV Operating Mode	34	Back Cover	68

Notes

- Installer Menu content is intended for use primarily by qualified TV electronics technicians.
- Refer to the Owner's Manual for additional information on TV installation, features, specifications, maintenance, and safety instructions.
- Design and specifications subject to change without prior notice.

Commercial Mode Overview

This document describes how to set up LD660H/LD665H and LV555H Pro:Centric™ TVs for Commercial Mode operation. LG commercial TV functionality is based on “ownership” of the Channel Map; that is, the Channel Map resides in the TV’s CPU, Protocol Translator Card (PTC), or embedded *b*-LAN™ (EBL) module, or it resides externally from the TV (i.e., in a device from the solution provider).

Each of these TV models has an EBL module that can be configured either for Pass-through Mode (default) or Free-To-Guest (FTG) Mode. In addition, each of these TVs is capable of FTG Mode operation via the TV CPU when the EBL is in Pass-through Mode.

Setup Checklist

Note: This document provides information specific to Commercial Mode operation. Refer to the Owner’s Manual for detailed information on TV installation and hardware and cable connections.

Installation

- ___ Unpack TV and all accessories.
- ___ Install batteries in the Installer Remote.
- ___ Install TV on VESA mount or stand.
Note: It may be advisable to make all cable connections before installing on VESA mount or stand, as appropriate.

Hardware Connections

- ___ Install any additional hardware as appropriate to your institution, LAN, etc.

Cable Connections

- ___ Make all rear jack panel and MPI card slot connections, as appropriate.

Commercial Mode Setup

- ___ Complete appropriate procedures as described in this document for Commercial Mode operation. See “Pass-through Mode” and “FTG Mode” sections below for further information.

Pass-through Mode

This mode allows you to create a Master TV Setup for cloning purposes for TVs that are to remain in Pass-through Mode. This mode also allows external control via the GAME CONTROL/MPI port on the TV rear jack panel. Use the Installer Remote to configure Installer Menu items as required for TV operation and set up TV features (Channel, Picture, Audio, etc.). See “Master TV Setup” on pages 11 to 14 for detailed information.

Installer Menu

To set up a Master TV for cloning purposes, you will need to know how to enter the commercial controller (PTC) Installer Menu and make changes to the default values as required. If necessary, familiarize yourself with the Installer Menu and how to make and save changes. Refer to pages 15 to 22 for information on accessing the Installer Menu in Pass-through Mode and for detailed descriptions of the Installer Menu items.

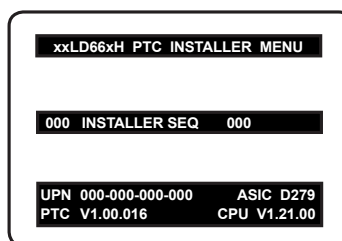

Typical Installer Menu

TV Setup Menus

On-screen setup menus control the features of the TV. Use the Installer Remote to access the TV setup menus, and set the TV features to the desired configuration for the end user. Refer to the Owner’s Manual for detailed information on the TV setup menus.

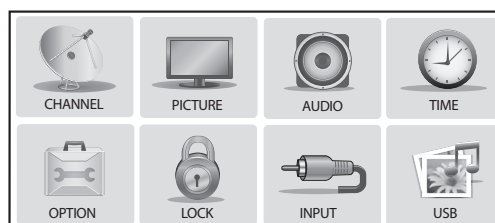

TV Setup Menus

Cloning

Cloning refers to the process of capturing a Master TV Setup and transferring it to a Target TV (both TVs must be in Pass-through Mode). The Master TV's clonable setup menu options should be configured as part of the Master TV Setup. If there are features in the Master TV's setup—channel icons or labels, digital font options, etc.—that are not set or that are set incorrectly, those features also will not be set or will be set incorrectly in the Target TVs. Pages 24 to 32 provide detailed information on cloning requirements and procedures.

FTG Mode

This mode enables Pro:Idiom® decryption and also allows logical channel mapping of physical channels to remove the need for dash tuning. TV operation in FTG Mode is based on which element of the TV owns the FTG Logical Channel Map—the CPU or the EBL. Understanding the application in which the TV will be used is vital in determining the owner.

As indicated above, FTG mode operation in the LD660H/LD665H and LV555H models can be provided either by the TV CPU or EBL. These are two separate and distinct FTG Modes of operation, each with its own unique advantages and requirements as described later in this document. When the TV CPU is configured with an FTG Channel Map, the CPU controls the operation of the TV, and when the EBL is configured with an FTG Channel Map, the EBL controls the operation of the TV.

Once it is determined whether the TV CPU or the EBL will own the FTG Channel Map, configuration can begin. Configuration of either requires a PC application—the LG FTG File Manager for the TV CPU or the LG FTG Device Configuration Application for the EBL. Each application provides utilities that enable you to create/edit an FTG Channel Map and configure Installer Menu settings. See pages 33 to 44 for further information on FTG Mode operation and configuration.

Remote Management in FTG Mode

When the TV is configured for FTG Mode via CPU, remote management of the FTG Channel Map and FTG Installer Menu settings is provided by a Pro:Centric server. Refer to the **Pro:Centric™ Server Admin Client User Guide** for further information.

When the TV is configured for FTG Mode via EBL, the *b*-LAN module, which is internal to the TV, allows hotel/institution head end equipment (for example, an FMA-LG101) with *b*-LAN technology to communicate with the TV to provide remote management of the FTG Channel Map and FTG Installer Menu settings. See Reference section, “*b*-LAN Setup & Overview,” for further information.

External MPI Control

To control the TV using an external MPI control device, you must use the TV's GAME CONTROL/MPI port for communication purposes. In these TVs, Installer Menu item 118 POWER SAVINGS controls the power circuitry for both the embedded *b*-LAN module and the GAME CONTROL/MPI port; therefore, to ensure that the GAME CONTROL/MPI port circuitry is powered, thus enabling MPI communication, Installer Menu item 118 POWER SAVINGS must be set appropriately. See Installer Menu item descriptions as well as Reference section, “*b*-LAN Setup & Overview,” for further information.

Pro:Centric Operation



Pro:Centric TV Interactive Menu Features

The interactive Pro:Centric TV enables guests—from the comfort of their hotel rooms—to view and select from a complete listing of hotel services and amenities. The Pro:Centric TV is connected to the hotel's billing computer, and service/amenities charges are billed at the time of order.

Interactive amenities may include:

- Hotel information, news, and events
- Directory services (tourist attractions, restaurants, etc.)
- Reservation services (business meetings, fitness, spa, etc.)
- Weather and traffic information
- Shopping services (delivery to guest room)
- Room service (menu ordering, memo service, morning wake up call, laundry, etc.)
- Ticketing and gaming services
- Check-out service (in the guest room)
- E-mail resources/account access

Use the Installer Remote to operate both interactive menus and regular TV features. Press **PORTAL** on the Installer Remote to access the interactive menus.

Note: Interactive menu options may vary, depending on Pro:Centric features enabled for the site. The following are default interactive menus.

Channel Guide

Shows available TV networks and logical channels. When available, electronic program guide (EPG) data provides additional channel and program information.

Information

Typically displays hotel information, for example, photos of guest rooms, dining rooms, business centers, facilities, etc., as well as information on local weather and attractions. Information may also include resources, such as local school programs, run in cooperation with the hotel.

Help

Provides help for navigating the interactive menus.

Watch TV

Removes the interactive menu from the screen and returns to the previously tuned TV channel.



Pro:Centric Setup

The Pro:Centric server provides the following functionality:

- Remote management/administration (TV E-Z Installation): The Pro:Centric server Admin Client provides remote management/administration facilities for downloading splash screens and software/firmware updates as well as facilities for downloading FTG Channel Map and FTG Installer Menu settings for TVs that are in FTG Mode via CPU (see also “Remote Management in FTG Mode” on page 7).

The Data Channel must be set appropriately to enable Pro:Centric remote management/administration facilities. The Data Channel can be set either in the Installer Menu (item 119 DATA CHANNEL) or in the Pro:Centric Menu (see “Pro:Centric Setup” on page 46).

- Pro:Centric application: The application comprises the Pro:Centric interactive menus/features described on the previous page. Pro:Centric application settings are managed via the Pro:Centric server Admin Client.

In addition to the Data Channel, the Pro:Centric Application Mode must be set appropriately to enable the Pro:Centric application. The Pro:Centric Application Mode can be set either in the Installer Menu (item 098 PRO:CENTRIC) or in the Pro:Centric Menu (see “Pro:Centric Setup” on page 46).

Administration and management options for the Pro:Centric server are described in detail in the **Pro:Centric™ Server Admin Client User Guide**. This document describes only those settings that must be specified on the TVs.

Pro:Centric Modes of Operation

There are now two modes that enable Pro:Centric operation, as described below.

FTG Mode via CPU

This mode enables Pro:Idiom decryption and also allows logical channel mapping of physical channels as described in the introduction to this document. See pages 33 to 44 for further information on FTG Mode operation and configuration.

Application Tuning Mode

If the TV is not in FTG Mode, but both the Data Channel and the Pro:Centric Application Mode have been set in the Installer Menu or the Pro:Centric Menu, the TV enters Application Tuning Mode. In Application Tuning Mode, the logical channel mapping of physical channels is done in the Pro:Centric application.

Also in Application Tuning Mode, only the Function Menu is available to end users instead of the TV setup menus (see sample display of the Function Menu under “Determining the TV Operating Mode” on page 34). Additionally, all Channel Map updates must be administered from the Pro:Centric server Admin Client; Teach To TV options will not be available from the USB Download Menu.

Note: The Installer Menu remains editable while the TV is in Application Tuning Mode.

Installer Remote Control Typical Key Functions

The LG Installer Remote is supplied with and dedicated to operate the TV. The LG Installer Remote illustrated below and throughout this document shows typical remote control functions and is provided for reference only. This Installer Remote may vary from the Installer Remote supplied with the TV.

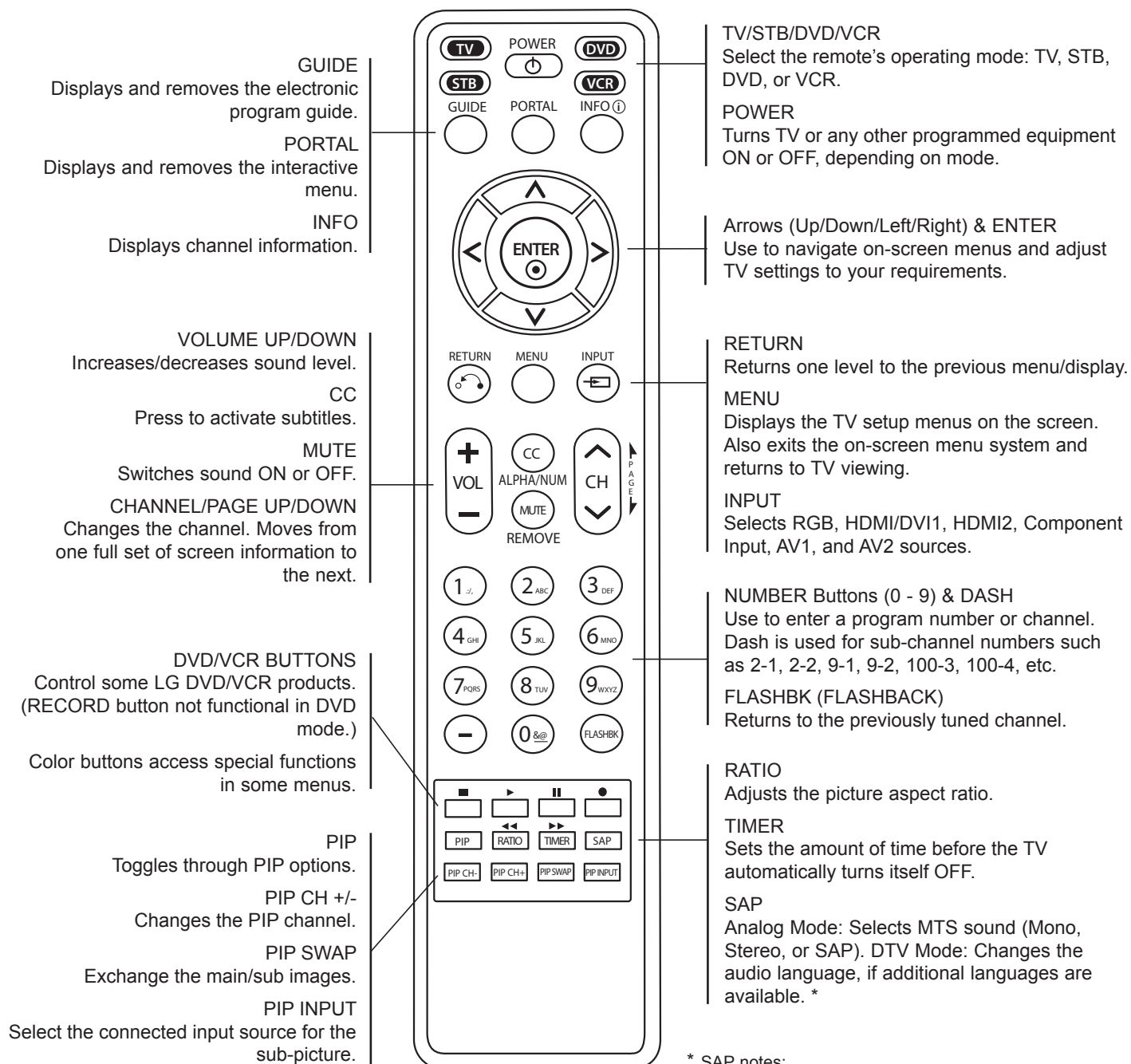

*** SAP notes:**

- If SAP is selected and no SAP is provided, sound may not be heard on channel.
- Each analog channel may have its own SAP setting.
- Digital channels will reset to default audio language with a power off/on.

This section describes how to set up a Master TV for cloning purposes when the TV is in Pass-through Mode.

Note: Refer to FTG Mode information on pages 33 to 44 for details on entering FTG Mode and configuring/editing FTG Channel Map and FTG Installer Menu settings.

Before You Begin

- Disconnect all Aux inputs if you intend to run Auto Tuning (Channel Search). Under certain conditions, Auto Tuning is disabled if there is an Aux input active.
- Determine which cloning tool—USB memory device or clone programmer—is appropriate for your application; several of the Master TV Setup procedure steps are dependent on the cloning tool to be used. See “Cloning Methods” below for further information.
- If you intend to use a USB memory device, determine the type of file—either the new “.tlx” file format or the legacy “.tll” file format—to use for cloning purposes; several of the Master TV Setup procedure steps are dependent on the desired file type. See “Cloning Methods” below for further information.

Cloning Methods

Using a USB Memory Device / .tlx File

- The .tlx file format clones the following menu settings: Installer Menu settings, IP Environment Offset Setup and Pro:Centric Setup settings (see pages 45 and 46), and all TV sources’ (analog, digital, AV1, HDMI, etc.) clonable setup menu settings. See “Clonable TV Setup Menu Features” list below.
- Not intended for cloning an auto-tuned/edited Channel Map, as the channel lineup is converted to a logical FTG Channel Map when saved (Learned) from a TV to a .tlx file. If the .tlx file with the FTG Channel Map is then used for Teaching purposes, all Target TVs will be configured for FTG Mode via CPU.

Using a USB Memory Device / .tll File

The .tll file format clones the contents of the commercial controller (PTC) memory, including an auto-tuned/edited Channel Map, Installer Menu settings, and one TV source’s (analog, digital, or Aux) clonable setup menu settings. See “Clonable TV Setup Menu Features” list below.

Using a Clone Programmer (TLL-1100A or LT2002)

Both the TLL-1100A and LT2002 clone the contents of the commercial controller (PTC) memory, including an auto-tuned/edited Channel Map, Installer Menu settings, and one TV source’s (analog or Aux) clonable setup menu settings. See “Clonable TV Setup Menu Features” list below.

Clonable TV Setup Menu Features

Channel Auto Tuning (Channel Lineup) Manual Tuning Channel Edit Channel Label	Audio Auto Volume Clear Voice Sound Mode Balance TV Speaker	Option Menu Language Audio Language Caption
Picture Aspect Ratio Picture Mode	Time Auto Clock Auto Off (Sleep Timer)	Lock Movie Rating TV Rating – Children TV Rating – General

Note: Some menu options vary between analog and digital channels and Aux inputs.

Master TV Setup (Cont.)

Master TV Setup Procedure

1. Set Installer Menu items.

This step provides specific instruction only on the Installer Menu items that should be set on a Master TV. Refer to pages 15 to 22 for detailed information on all Installer Menu items.

- a) Make sure the TV is ON. Then, use the Installer Remote to enter the PTC Installer Menu: Press **MENU** repeatedly until the on-screen display of the TV setup menus no longer toggles, and then press **9-8-7-6 + ENTER**.
- b) Set Installer Menu item **117 FACT DEFAULT** to **001** and press **ENTER** on the Installer Remote.

This clears all Installer Menu custom settings, channel lineup, etc. and reloads the factory default settings. The value will change back to 0 after the PTC has been restored to factory default condition. This step ensures that the TV Channel Memory will be the active channel lineup.

- c) Set Installer Menu item **003 BAND/AFC**, as appropriate.
 - Broadcast: Set to 000.
 - HRC: Set to 002.
 - CATV: Set to 001 (default).
 - IRC: Set to 003.
- d) Set any other Installer Menu items that affect your TV programming network to the required configuration. For example, enable/disable Aux **inputs**, set a Start Channel, etc.
- e) After you have adjusted all required Installer Menu item settings, press **ENTER** once on the Installer Remote to save your changes; then, press **ENTER** again to exit the menu.

2. Set up TV features.

On-screen setup menus control the features of the TV. Press **MENU** on the Installer Remote to access the TV setup menus, and then set Channel, Picture, Audio, Lock, Time, etc. options to the desired configurations. See also the Clonable TV Setup Menu Features list on page 11.

Note: If you intend to clone the PTC, remember that only one TV source's clonable setup menu settings will be cloned. Thus, for a clone programmer, the TV setup menu settings should be applicable to either an analog channel or Aux input, while for a USB device / .tll file, the TV setup menu settings should be applicable to the analog or digital channel or Aux input to which the Target TV will be set during the Teaching process.

Note: If desired and if appropriate depending on the cloning method you intend to use (see "Cloning Methods" on previous page), you can run Auto Tuning (see step 3) prior to completing this step.

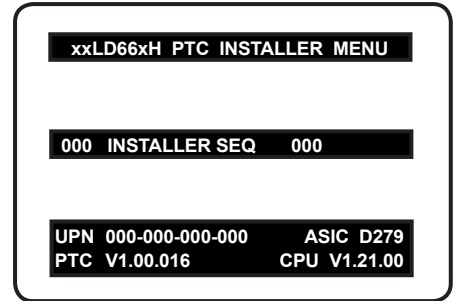

Typical Installer Menu

Note: The Installer Menu header will vary depending on the TV you are setting up.

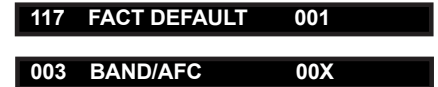

Adjust the settings for these Installer Menu items.

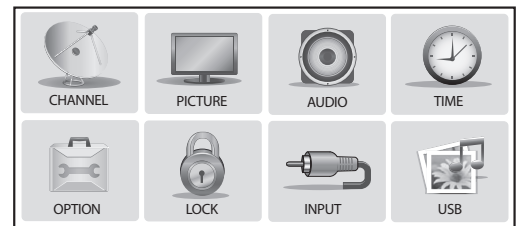

Use the TV setup menus to set the TV features to the desired configuration for the end user.

(Continued on next page)

(Continued from previous page)

3. (Optional) Run Auto Tuning.

Important: If you intend to use a USB memory device / .tlx file for cloning purposes, DO NOT run Auto Tuning. If you Teach a .tlx file with an auto-tuned/edited Channel Map to a Target TV, this will put the Target TV in FTG Mode via CPU. If you run Auto Tuning with the intension to clone the resulting Channel Map, you must use a USB memory device / .tll file or a clone programmer for this cloning purpose.

- a) To search for all available analog and digital channels, go to the Channel Menu, select the **Auto Tuning** option, and follow the on-screen instructions.
- b) Use the **Channel Edit** option in the Channel Menu to edit the channel lineup, as necessary, to include only free to guest (non-encrypted) channels.
 - Add/delete channels per your system requirements.
 - Use the **Channel Label** option in the Channel Menu to select the appropriate trademark/icon for each channel's Channel-Time on-screen display. Icons are available for familiar channels, such as ABC, CBS, NBC, etc. Identifiable labels (icons) should enable the end user to readily know what common networks are available.

Note: If you intend to clone the PTC and Installer Menu item 103 ATSC TUNE MODE is set for Physical Channel tuning (default and recommended setting), channels with minor channel numbers higher than 255 will not transfer correctly in step 5. If item 103 is set for Virtual Channel tuning and either the major or minor channel numbers are higher than 255, the channel(s) will not transfer correctly in step 5.

Note: If you intend to clone the PTC, you can add the channel icons in this step or as described in step 6. Also in step 6, you can add custom text labels for channels without icons.

4. Determine the next appropriate step according to the cloning method you intend to use.

- If using a USB memory device / .tll file or a clone programmer: Continue with step 5. You must perform this step to transfer the TV setup menu settings to the PTC in order to clone the PTC successfully.
- If using a .tlx file: Proceed to step 7 to verify the TV setup. (Steps 5 and 6 are not applicable for .tlx files.)

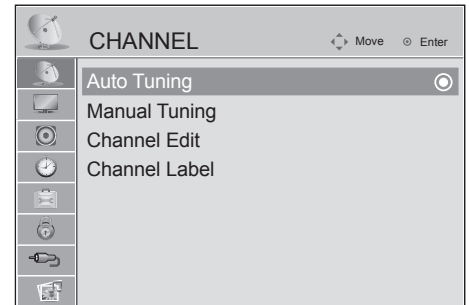

(Optional) Use Channel Menu options to run Auto Tuning, edit channels, and select channel icons.

(Continued on next page)

Master TV Setup (Cont.)

(Continued from previous page)

5. Transfer the TV setup menu settings to the commercial controller (PTC): 2-5-5 + MENU Mode

Important: This step is essential for successful cloning using a USB memory device / .tll file or a clone programmer. Without this step, the PTC will not contain any of the TV setup menu settings.

a) After the TV channel lineup has been edited and channel label icons added, tune to the channel (source) for which you wish to transfer TV setup menu settings.

Note: If you intend to use a clone programmer for cloning purposes, this must be either an analog channel or Aux input.

b) Enter the Installer Menu, and press **2-5-5 + MENU** on the Installer Remote to initiate the transfer of the Master TV Setup to the PTC. The TV exits the Installer Menu and then tunes through the channels in the channel lineup during the transfer. When the transfer is complete, the TV tunes back to the channel that was tuned before the transfer began.

Note: The maximum number of channels that can be transferred is 141. An attempt to transfer more than 141 channels will result in erratic TV tuning operation.

6. (Optional) Add Custom Channel and Aux Labels: 2-5-4 + MENU Mode

Note: This step is applicable only if you intend to clone the PTC. 2-5-4 + MENU Mode enables you to add/edit channel icons and custom text labels in the PTC once the Master TV Setup has been transferred as described in the previous step.

Enter the Installer Menu, and press **2-5-4 + MENU** on the Installer Remote. Add/edit custom text labels and/or change icons for the Channel-Time on-screen displays (see 2-5-4 + MENU procedural information on page 23). Note that broadcast digital channels often already have a broadcaster generated label. When you are finished, press **MENU** to exit 2-5-4 + MENU Mode.

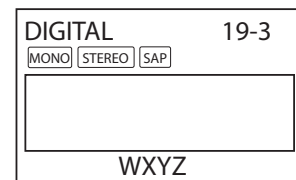

Custom text label "WXYZ" created in 2-5-4 + MENU Mode.

7. Verify the TV setup.

As applicable, verify that the channel lineup, channel icons, and custom text labels are correct. Also, make sure the TV features are set per your requirements.

8. Lock the channel lineup.

Enter the Installer Menu. Set item **028 CH. OVERRIDE** to **000** and press **ENTER** to lock the channel lineup and restrict access to the TV setup menus. Press **ENTER** again to save your changes and exit the Installer Menu.*

The Master TV Setup is now ready to be copied to the predetermined cloning tool—a USB memory device (.tlx or .tll file) or a clone programmer. See cloning procedures in this document.

028 CH. OVERRIDE 000

After verifying the TV Setup, set Installer Menu item 028 CH. OVERRIDE to 000.*

* This step prevents end users from accessing channel settings (i.e., the Channel Menu will be inaccessible/grayed out).

Use the Installer Menu to set up, change, or view operational settings. Refer to the table starting on the next page for brief descriptions of Installer Menu items. More detailed descriptions follow the table listing.

Accessing the Installer Menu

1. Make sure the TV is ON.
2. Using an Installer Remote, press **MENU** repeatedly until the on-screen display of the TV setup menus (if the TV is in Pass-through Mode) or the Function Menu (if the TV is not in Pass-through Mode) no longer toggles, and then press **9-8-7-6 + ENTER** to access the Installer Menu.

The Installer Menu opens with item 000 INSTALLER SEQ 000.

Note: If the password is not entered or registered correctly, you will see the message “ENTER PASSWORD 0000” at the top of the screen instead of the Installer Menu header. Once you re-enter the correct password (i.e., press **9-8-7-6 + ENTER**), the Installer Menu will display.

Note: If the TV is in FTG Mode, the Installer Menu is accessible as read-only. Refer to pages 33 to 43 for information on FTG Mode configuration.

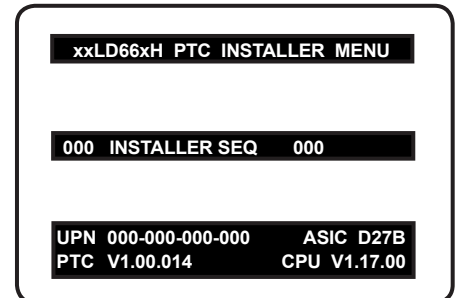

Typical Installer Menu

Using the Installer Menu

Refer to the table on pages 16 and 17 for an overview of the available Installer Menu items, including their item numbers, functions, value ranges, and default values.

Installer Menu items not relevant to this TV series are not present in the Installer Menu; therefore, some numbers are missing. For example, item 006 will not appear. In addition, items that are dependent on other Installer Menu item settings will not be initially accessible. For example, item 046 STRT AUX SRCE will not display in the Installer Menu unless item 004 STRT CHANNEL is set to 0.

Navigation within the Installer Menu

Use the Up/Down arrow keys on the Installer Remote to sequence through the available menu items, or access an item directly by keying in the item number and then pressing **MENU**. For example, to access the SLEEP TIMER option, which is item 015, press 0-1-5 + **MENU**.

Changing Installer Menu Settings

To change an Installer Menu item value, use the Left/Right arrow keys on the Installer Remote, or enter a valid value directly. To save the new setting, press **ENTER**, or use the Up/Down arrow keys to navigate to a new Installer Menu item if you have additional items to edit. Note that invalid values will not be saved.

Exiting the Installer Menu and Activating Updates

After you have adjusted all required Installer Menu item settings, press **ENTER** once on the Installer Remote to save your changes; then, press **ENTER** again to exit the Installer Menu. Any changes you make will be stored in non-volatile memory.

Note: Each time you exit the Installer Menu in Pass-through Mode, all V-Chip (Parental Control) settings in the TV are reset to their default values; that is, the Lock System, if previously enabled from the Lock setup menu (see the Owner’s Manual for additional information), will now be disabled, and the individual Parental Control settings will be restored to default values.

Installer Menu (Cont.)

Installer Menu Items 000 through 073

Menu Item	Function	Value Range	Default Value	Brief Description of Function and Comments
000	INSTALLER SEQ	0 ~ 3	0	Leave default set to 0.
001	POWER MANAGE	0 ~ 7	0	Sets number of hours of no activity before automatic shutoff.
002	AC ON	0 / 1	0	Set to 1 to enable Auto Turn ON when AC power is applied.
003	BAND/AFC	0 ~ 3	1	Selects Tuning Band: 0=Broadcast, 1=CATV, 2=HRC, 3=IRC
004	STRT CHANNEL	0 ~ 127, 253, 255	255	Channel tuned when TV is turned ON. (Set to 255 to tune to channel tuned before TV turned OFF.)
005	CHAN LOCK	0 / 1	0	If set to 1, cannot tune from current channel.
007	STRT VOLUME	0 ~ 63, 255	255	Volume level when TV is turned ON. (Set to 255 to use volume level before TV turned OFF.)
008	MIN VOLUME	0 ~ 63	0	Sets minimum allowable volume setting.
009	MAX VOLUME	0 ~ 63	63	Sets maximum allowable volume setting.
010	MUTE DISABLE	0 / 1	0	Set to 1 to disable Mute Function.
011	KEY DEFEAT	0 / 1	0	Set to 1 to disable menu navigation keys on display panel.
015	SLEEP TIMER	0 / 1	1	Set to 1 to enable Sleep Timer.
016	EN TIMER	0 / 1	0	Set to 1 to enable On/Off Timers.
017	ALARM	0 / 1	1	Set to 1 to enable Alarm.
020	FEATURE LEVEL	0 ~ 1, 16 ~ 24	1	Determines an additional IR code scheme to which the TV will respond.
021	V-CHIP	0 / 1	1	Set to 1 to enable V-Chip (Parental Control) functions.
022	MAX BLK HRS	0 ~ 99	12	Sets number of V-Chip blocking hours.
023	CAPTION LOCK	0 / 1	0	Set to 1 to retain caption setting set before TV turned OFF.
028	CH. OVERRIDE	0 / 1	1	If set to 0, limits direct access to favorite channels.
029	OLD OCV	0 / 1	0	Set to 1 to change MPI operation to OCV.
030	ACK MASK	0 / 1	0	If set to 1, enables ACK feature of MPI.
031	POLL RATE	20 ~ 169	94	Selects poll rate for MPI.
032	TIMING PULSE	186 ~ 227	207	Sets baud rate for MPI.
034	CAMPORT EN	0 / 1	1	Set to 1 to enable Video 2 input.
035	COMPPOINT EN.	0 / 1	1	Set to 0 to disable HDMI 1. Set to 1 enable HDMI 1.
038	YPrPb EN.	0 / 1	1	Set to 1 to enable display panel Component Video 1 input jacks.
039	REAR AUX EN	0 / 1	1	Set to 1 to enable display panel Video 1 input jack.
040	AUTO CAMPORT	0 / 1	1	Set to 1 to automatically switch to Camport. If set to 1, STRT AUX SRCE cannot be set to 2.
046	STRT AUX SRCE	1 ~ 6, 255	6	Sets the starting Aux source (if item 004 STRT CHANNEL is set to 0).
047	AUX STATUS	0 / 1	0	Set to 1 for MPI Aux source to be reported as a channel number instead of Channel 0.
053	DIS. CH-TIME	0 / 1	0	Set to 1 to disable Channel-Time display.
069	EN. CH-T COL.	0 / 1	1	Set to 1 to enable custom color for the Channel-Time display.
070	FOR. CH-TIME	0 ~ 7	2	Chooses custom foreground color for the Channel-Time display.
071	BCK. CH-TIME	0 ~ 7	2	Chooses custom background color for the Channel-Time display.
073	CH NOT AVBLE	0 / 1	0	If set to 1 and item 028 CH. OVERRIDE is set to 0, "NOT AVAILABLE" message is displayed if user direct tunes a channel that is not in the favorite channel list.

Installer Menu Items 075 through 122

Menu Item	Function	Value Range	Default Value	Brief Description of Function and Comments
075	REVERT CH	0 / 1	0	If set to 1 and loss of MPI communication occurs, TV tunes to Start Channel.
078	UPN MSB	0 ~ 255	0	User programmable number, most significant byte.
079	UPN MSB-1	0 ~ 255	0	User programmable number, most significant byte - 1.
080	UPN MSB-2	0 ~ 255	0	User programmable number, most significant byte - 2.
081	UPN LSB	0 ~ 255	0	User programmable number, least significant byte.
082	CHKSM ERROR	0 / 1	1	If set to 1, enforces rigid MPI checksum.
083	HANDSHK TIME	0 ~ 5	5	Relaxes MPI timing to be compatible with PC-based Windows-controlled systems.
084	PERMANENT BLK	0 / 1	0	Removes block hours setting for Parental Control and makes block permanent.
087	REAR RGB EN.	0 / 1 / 17	1	Dependent on item 093 RJP AVAILABLE setting. Set to 0 to disable RGB input. Set to 1 to enable RGB input. Set to 17 for Auto Configure.
088	EN NOISE MUTE	0 / 1	1	If set to 1, audio is muted if no signal is present.
090	KEY LOCK	0 / 1	0	If set to 1, keyboard is locked out, IR is still functional.
091	YPrPb2 EN	0 / 1	1	Set to 1 to enable HDMI 2 input.
093	RJP AVAILABLE	0, 1, 2, 5, 6	0	Set to 0 to disable. Set to 1, 2, 5, or 6 for HDMI or DVI Mode. (See detailed descriptions.)
094	SAP MENU EN	0 / 1	1	Set to 0 to disable feature on Function Menu. Set to 1 to enable feature on Function Menu.
096	DEF. ASP. RATIO	0 ~ 4	2	Sets default aspect ratio at power up. See detailed descriptions and item 106.
098	PRO:CENTRIC	0 ~ 2	0	Set to 0 to disable Pro:Centric operation. Set to 1 for Flash Mode. Set to 2 for GEM (Java Application) Mode.
099	BACK LIGHTING	1 ~ 100, 101 ~ 200, 201, 202, 255	202	Sets the level of the TV picture back lighting. (See detailed descriptions.)
102	ATSC BAND	0 ~ 4	4	Selects ATSC band.
103	ATSC TUNE MODE	0 / 1	1	Set to 1 (default) for Physical Channel scan. Set to 0 for Virtual Channel scan.
104	START MINOR CH	0 ~ 255	0	Selects Minor Start Channel. Set to 0 for NTSC.
106	ASP RATIO LOCK	0 / 1	0	To retain set aspect ratio on power cycle, set to 1. Set to 0 for default ratio on power cycle.
116	VIDEO MUTE EN	0 / 1	0	Set to 0 for Normal. Set to 1 for Blank.
117	FACT DEFAULT	0 / 1	0	Set to 0 for Normal. Set to 1 to load presets for all Installer Menu settings.
118	POWER SAVINGS	1 / 3	3	Set to 3 (default—b-LAN module only powered when TV is turned ON), or set to 1 (b-LAN module is always powered). (See detailed descriptions.)
119	DATA CHANNEL	0 ~ 135, 253	0	Set to 0 to disable. Set to the RF channel number of the data channel for Pro:Centric or TV E-Z Installation data. (See detailed descriptions.)
121	P:C RF WAKE HR	0 ~ 23, 128	128	Sets the hour for Wake On RF. The value "128" is displayed as "OFF." Directly entering 128 turns the Wake On RF feature OFF.
122	P:C RF WAKE MN	0 ~ 59	0	Sets the minute for Wake On RF.



Caution: Installer Menu settings may affect options available from the TV setup menus or the Function Menu.

Installer Menu (Cont.)

Detailed Descriptions of Installer Menu Items

000 - INSTALLER SEQUENCE

Specifies entry sequence to the Installer Menu.

0 = 9876	1 = 4321
2 = 1478	3 = 3698

001 - POWER MANAGE (Power Management)

Determines hours of no activity before automatic shutoff. The Power Management function is for saving energy. If set to 0, Power Manage is Off. Settings range from 0 ~ 7, with 1 ~ 7 representing the hours that the unit will remain ON, unless there has been activity from either the control panel or remote control.

002 - AC ON (AC Power Switchable)

If set to 1, this allows the TV to turn ON when AC power is applied. Pressing the ON button is not necessary. This is desirable if the TV is plugged into a cable box or a power outlet controlled by a wall switch. Use the Left/Right arrow keys to choose 0 or 1, where 0 is the default (OFF), and 1 is ON.

Note: If set to 1 (ON), the TV does not respond to ON/OFF commands from either the remote or the display panel, and the SLEEP TIMER is also nonfunctional.

003 - BAND/AFC (Band/Automatic Frequency Control)

There are four possible settings for this option:

0 = Broadcast	1 = CATV (default)
2 = HRC	3 = IRC

If some channels were not found by Auto Tuning (Channel Search), select the appropriate Band setting here, and add the channels using the Channel Edit option in the Channel Menu.

004 - STRT CHANNEL (Start Channel)

If active, this function allows you to determine the initial Major Start Channel number when the TV is turned ON. This feature is useful for an in-house information channel, since the TV would always select that channel when it is turned ON. Setting this item to 255 causes the last channel viewed when the TV was turned OFF, to be the tuned to channel when the TV is turned ON again.

Note: For a digital Start Channel, always remember to set item 104 to the Minor Start Channel number.

Note: The IP Start Channel shown below can only be set in the FTG File Manager, which is used to configure TV CPUs for FTG Mode. The same applies for 2-byte tuning ranges (128 ~ 135 for Physical 2-byte tuning and 128~999 for Virtual 2-byte tuning). This means that these values, if set, will only be visible in the read-only Installer Menu when the TV is in FTG Mode via CPU. The read-only display also will show additional information about the channel, for example, the IP address and port number, etc.

0 = Aux	127 = Map to Channel 4
1 ~ 125 = Major Ch. #	253 = IP Start Channel
126 = Map to Channel 3	255 = Last Channel

005 - CHAN LOCK (Channel Lock)

Channel Lock is ideal if the system must always be on the same channel. Changing channels with the Channel Up/Down or keypad numbers is impossible. Channel Lock is inactive if set to 0 (default).

Generally, this feature is used in connection with item 004 STRT CHANNEL where the Start Channel may, for example, be set to 3 or 4. If the Start Channel is 3, then the TV will remain locked on channel 3.

NOTE: For items 007, 008, and 009

For legacy reasons, the scale used is 0–63. The PTC software will translate this to the 0–100 scale used by the TV.

To translate a TV volume level to the Installer Menu value, use the following formula:

$$\text{Installer Value} = \frac{\text{TV Value} \times 63}{100}$$

Enter only the whole number (disregard fractions).

007 - STRT VOLUME (Start Volume)

This function allows the Installer to determine the initial volume level setting when the TV is turned ON. This feature is useful for an in-house information channel, since the TV would always select that volume level when it is turned ON. The range of values are 0 - 63, 255. If 255 is selected, the current volume level will be retained in memory when the TV is turned OFF; at turn ON, the volume level will be automatically set at the previous or last level.

008 - MIN VOLUME (Minimum Volume)

This function determines the minimum volume level allowable with the Volume (VOL) Up/Down control. In this way, for example, someone cannot set the volume too low to hear. The value range is from 0 to 63. Use the Left/Right arrow keys to change values. The factory default is 0, which provides the full range of volume control, if item 009 MAX VOLUME is also set to 63. It may be best to set the same value on every TV.

Note: The minimum volume level cannot have a value setting higher than the maximum volume level (described below).

009 - MAX VOLUME (Maximum Volume)

This function determines the maximum volume level allowable with the Volume (VOL) Up/Down control. In this way, for example, someone cannot set the volume level high enough to disturb others. The value range is 0 to 63, with 63 as the default, which gives the user the full range of volume control, if item 008 MIN VOLUME is also set at 0. Use the Left/Right arrow keys to change values. It may be best to set the same value on every TV.

Note: The maximum volume level cannot have a value setting lower than the minimum volume level (described above).

010 - MUTE DISABLE

Enables or disables sound mute function. If set to 1, sound cannot be muted. If set to 0, sound can be muted.

011 - KEY DEFEAT (Keyboard Defeat)

If set to 1, KEY DEFEAT prevents the end user from accessing the on-screen menu(s) from the display panel—MENU, ENTER, and menu navigation keys do not function. If set to 0, those keys do function.

Note: Users can always access the menu(s) by pressing MENU on the remote.

015 - SLEEP TIMER

If set to 1, the Sleep Timer feature may be used. If set to 0, the Sleep Timer is not available.

016 - EN TIMER (Enable On/Off Timers)

If set to 1, the Timer function is available to the end user and enabled continuously. Set to 0 to disable On/Off timers.

Note: Clock must be set in order for timers to be used.

017 - ALARM

Gives the installer the option of making the Alarm function available to the end user. If set to 1, the Alarm function is available to the end user. Set to 0 to disable the Alarm function.

Note: Clock must be set before the Alarm function will work.

020 - FEATURE LEVEL

Determines an additional IR code scheme to which the TV will respond, allowing for the use of unique IR codes based on “bed number” in a multi-TV single room installation. First determine the IR mode; then select the bed number.

IR Mode	Bed #	Values
Legacy (Hospital)	1–2	0–1
Multi-code Remote	1–9	16–24

Note: For further information, see documentation for the accessory package that includes the multi-code remote.

021 - V-CHIP (Parental Control)

Set to 1 to activate V-Chip (Parental Control) and have it available to the end user to filter and control or otherwise restrict programming content that can appear. Set to 0 to turn the V-Chip feature Off (not available to user); no programming restrictions can be set.

022 - MAX BLK HRS (Maximum Block Hours)

Sets hours from 0 to 99 for the maximum V-Chip (Parental Control) block hours. Default setting is for 12 blocking hours.

Note: This item is not available in the Installer Menu unless item 084 PERMANENT BLK is set to 0.

023 - CAPTION LOCK

If set to 0, captions are OFF when the TV is turned ON. Set to 1 to use the caption setting configured before the TV was turned OFF when the TV is turned ON.

028 - CH. OVERRIDE (Channel Override)

If set to 1, the user can select channels with either Channel Up/Down or by direct keypad entry. If set to 0, only those channels that are active in the TV’s memory can be selected.

029 - OLD OCV (On Command Video™)

Set to 1 for operation with systems from On Command Corporation.

030 - ACK MASK

MPI Communication Parameter. When set to 1, enables ACK feature of MPI.

031 - POLL RATE

MPI Communication Parameter. Selects poll rate for MPI. Step size of 16 ms. Changing from default may affect communication via MPI.

032 - TIMING PULSE

MPI Communication Parameter. Sets baud rate for MPI. Step size of 4.3 uS. Changing from default may affect communication via MPI.

034 - CAMPORT EN. (Camera Port Enable)

Set to 1 to enable Video 2 input on display panel. If set to 0, Video 2 input on display panel is not functional.

035 - COMPPORT EN. (Computer Port Enable)

Enable/disable TV display panel HDMI 1 input jack. Set to 0 to disable HDMI 1. Set to 1 to enable HDMI 1.

Note: This setting is ignored if item 093 RJP AVAILABLE is set to 1.

038 - YPrPb EN. (Rear Component Video Enable)

Set to 1 to enable display panel rear Component Video input jacks. Set to 0 to disable display panel rear Component Video input jacks.

039 - REAR AUX EN. (Rear Aux Enable)

Set to 1 to enable display panel rear Aux (Video 1) input. Set to 0 to disable display panel rear Aux (Video 1) input.

040 - AUTO CAMPORT

Set to 1 to automatically switch to Camport when equipment is connected to front Video input. Set to 0 to disable front Video automatic source selection. If set to 1, STRT AUX SRCE cannot be set to 2.

Note: If set to 1, item 093 RJP AVAILABLE is automatically set to 0.

Installer Menu (Cont.)

046 - STRT AUX SRCE (Start Aux Source)

Sets the starting Aux source. When turned ON, the TV will tune to starting Aux source if item 004 STRT CHANNEL is set to 0.

If item 093 RJP AVAILABLE is set to 0 and item 040 AUTO CAMPORT is set to 0:

1 = Video 1	4 = RGB	255 = Last Aux
2 = Video 2	5 = HDMI 2	
3 = HDMI 1	6 = Component	

If item 093 RJP AVAILABLE is set to 1:

2 = Video 2	5 = HDMI 2	6 = Component
-------------	------------	---------------

If item 040 AUTO CAMPORT is set to 1:

1 = Video 1	4 = RGB	6 = Component
3 = HDMI 1	5 = HDMI 2	

Note: This item is not available in the Installer Menu unless item 004 STRT CHANNEL is set to 0.

047 - AUX STATUS

Set to 1 for MPI Aux source to be reported as a channel number instead of channel 0. Set to 0 to disable Aux identification change. Controls MPI status channel response for Aux inputs.

053 - DIS. CH-TIME (Disable Channel-Time)

Set to 1 to disable the Channel-Time display; Channel-Time display will not appear. Set to 0 to enable the Channel-Time display.

069 - EN. CH-T COL. (Enable Channel-Time Custom Color)

Set to 1 to enable custom color for the Channel-Time display. Set to 0 to disable custom color for the Channel-Time display.

070 - FOR. CH-TIME (Channel-Time Display Foreground Color)

Set according to Color Chart:

0 = Black	3 = Cyan	6 = Yellow
1 = Blue	4 = Red	7 = White
2 = Green	5 = Violet	

Note: If foreground color and background color are the same, the menu background will be transparent.

Note: Applies only to "Channel Not Available" message if item 073 CH NOT AVBLE is set to 1 (enabled). Also, items 070 FOR. CH-TIME and 071 BCK. CH-TIME are not available in the Installer Menu when item 069 EN. CH-T COL. is set to 0.

071 - BCK. CH-TIME (Channel-Time Display Background Color)

See description for item 070 FOR. CH-TIME above. The color chart is the same for both items.

073 - CH NOT AVBLE (Channel Not Available)

If set to 1 and item 028 CH. OVERRIDE is set to 0, a "NOT AVAILABLE" message is displayed when a user direct tunes a channel that is not in the channel scan list available in memory.

075 - REVERT CH (Revert to Start Channel)

If set to 1 and loss of MPI communication occurs, TV automatically tunes to the specified Start Channel.

Note: This item is not available in the Installer Menu when item 004 STRT CHANNEL is set to 255.

078 - UPN MSB (UPN Most Significant Byte)

User programmable number, most significant byte readable by MPI command. Note: Not linked to serial number.

079 - UPN MSB-1 (UPN Most Significant Byte-1)

User programmable number, most significant byte-1 readable by MPI command. Note: Not linked to serial number.

080 - UPN MSB-2 (UPN Most Significant Byte-2)

User programmable number, most significant byte-2 readable by MPI command. Note: Not linked to serial number.

081 - UPN LSB (UPN Least Significant Byte)

User programmable number, least significant byte readable by MPI command. Note: Not linked to serial number.

082 - CHKSM ERROR (Checksum Error)

Enforces rigid MPI checksum validation. Set to 1 for validation. Set to 0 to disable (does not check checksum on MPI async port). SPI is always checked.

083 - HANDSHK TIME (Handshake Time)

Adds an additional delay to the handshake time which is 64 msec, thus relaxing MPI timing requirements to be compatible with PC-based Windows controlled systems. Range is 0 - 5. (Timeout = 25.5MS + [25.5 MS* Handshake time].)

084 - PERMANENT BLK (Permanent Block)

Allows Lock (Parental Control) blocking schemes to be permanent by disabling the blocking hours function. Set to 1 to install Parental Control restrictions permanently. Set to 0 for user-specified hours control of blocking schemes.

087 - REAR RGB EN. (Rear RGB Enable)

Controls access to rear RGB input on TV. Set to 0 to disable RGB input. Set to 1 to enable RGB input. Set to 17 to initiate a one-time automatic configuration after an AC power cycle; otherwise, automatic adjustment will be performed each time the RGB input is accessed.

088 - EN NOISE MUTE (Enable Noise Mute)

If set to 1, audio mutes when no signal is present.

090 - KEY LOCK

If set to 1, display panel Channel, Volume, and Caption buttons are disabled, Power button remains enabled. If set to 0, Channel, Volume, Caption, and Power buttons are all enabled.

091 - YPrPb2 EN. (HDMI2 Enable)

Set to 1 to enable display panel HDMI 2 input. Set to 0 to disable display panel HDMI 2 input.

093 - RJP AVAILABLE (Remote Jack Pack Available)

- 0 = Remote jack pack is not available or disabled.
- 1 = Legacy Model RJP: HDMI Mode
Enables RJP feature for use with full cable bundle models. In this mode, when an HDMI source is connected to the RJP, both digital video and audio are expected via the HDMI cable. If no digital audio is present, no audio will be heard.
- 2 = Legacy Model RJP: DVI Mode
Enables RJP feature for use with full cable bundle models. In this mode, when an HDMI/DVI source is connected to the RJP, only digital video is expected via the HDMI cable. Analog audio is provided via a separate cable, from the source, connected to an RJP AUDIO IN. If no analog audio cable is connected, tuner audio will be heard.
- 5 = Scaler Model RJP: HDMI Mode
Enables RJP feature for use with reduced cable bundle models. In this mode, when an HDMI source is connected to the RJP, both digital video and audio are expected via the HDMI cable. If no digital audio is present, no audio will be heard.
- 6 = Scaler Model RJP: DVI Mode
Enables RJP feature for use with reduced cable bundle models. In this mode, when an HDMI/DVI source is connected to the RJP, only digital video is expected via the HDMI cable. Analog audio is provided via separate cable, from the source, connected to an RJP AUDIO IN. If no analog audio cable is connected, tuner audio will be heard.

Notes:

See Reference section, "RJP Model List and Input Auto-sensing Hierarchy." If RJP AVAILABLE is set to 1, 2, 5, or 6, item 040 AUTO CAMPORT is automatically set to 0. Settings 1, 2, 5, and 6 allow the lodge staff to customize each TV's RJP setup based on customer requirements.

094 - SAP MENU EN (2nd Audio Program)

Set to 1 to enable SAP feature on Function Menu, if Function Menu is available (i.e., TV is not in Pass-through Mode). Set to 0 to disable SAP feature on Function Menu, if Function Menu is available.

096 - DEF. ASP. RATIO (Default Aspect Ratio)

Selects default aspect ratio at power up.

- Set to 0 for Set By System.
- Set to 1 for 4:3.
- Set to 2 for 16:9 (Factory Default).
- Set to 3 for Just Scan.
- Set to 4 for Zoom.

Note: This item is not available in the Installer Menu unless item 106 ASP RATIO LOCK is set to 0.

098 - PRO:CENTRIC

Selects the Pro:Centric Application Mode. Set to 0 (default) to disable Pro:Centric operation. Set to 1 for Flash Mode. Set to 2 for GEM (Java Application) Mode.

Note: This item is not available in the Installer Menu when item 119 DATA CHANNEL is set to 0.

Note: When both Pro:Centric items (098 PRO:CENTRIC and 119 DATA CHANNEL) are set, once you exit the Installer Menu, the Function Menu will be available to end users instead of the TV setup menus. Also, only the Learn From TV (TLX) option will be available from the USB Download Menu; the Teach to TV option will not.

099 - BACK LIGHTING

Sets the TV screen brightness at power up. Default setting is 202.

- 1 - 100 Static Back Lighting
(1 = Dimmest picture, 100 = Brightest picture)
- 101 - 200 Dynamic Back Lighting
(101 = Dimmest picture, 200 = Brightest picture)
- 201 Automatic Static Back Lighting
- 202 Automatic Dynamic Back Lighting

If set between 101 and 200, the TV automatically controls back lighting depending upon the picture level of the current program. If set to 201, the TV automatically controls back lighting depending upon external spectral sensitivity. If set to 202, the TV automatically controls back lighting depending upon external spectral sensitivity and the picture level of the current program. If set to 255, back lighting is controlled via the Picture settings in the TV's setup menus.

102 - ATSC BAND

Sets up TV to receive different types of incoming signals:

0 = Broadcast, 1 = CATV, 2 = HRC, 3 = IRC, 4 = Same as NTSC.

103 - ATSC TUNE MODE

Sets ATSC tuning mode: Default set to 1 for Physical Channel scan. Set to 0 for Virtual Channel scan.

Installer Menu (Cont.)

104 - START MINOR CHANNEL

Sets Minor Start Channel number at power up. 0 = NTSC. If not 0, number selected is the digital channel's Minor Start Channel number.

Note: This item is not available in the Installer Menu when item 004 STRT CHANNEL is set to 0, 253, or 255.

106 - ASP RATIO LOCK (Aspect Ratio Lock)

Set to 1 to retain previous aspect ratio with power off. Set to 0 to retain default aspect ratio with power off. See item 096 DEF. ASP. RATIO above.

116 - VIDEO MUTE EN (Video Mute Enable)

Set to 0 for Normal. Set to 1 for Blank.

117 - FACT DEFAULT (Factory Default)

Set to 0 for normal. Set to 1 to load presets of all Installer Menu item settings.



Caution: If set to 1, this will reload the factory defaults and clear the channel lineup, including any assigned channel icons and custom text labels.

Note: See also Reference section, "Resetting Factory Defaults on the TV(s)," for further information.

118 - POWER SAVINGS

Default set to 3—the power circuitry for both the embedded *b*-LAN module and the GAME CONTROL/MPI port is only powered when the TV is turned ON. When the TV is in Standby Mode, the MPI card slot is powered by the Standby power supply and both the embedded *b*-LAN and the GAME CONTROL/MPI port are not powered. When the TV is in Power On Mode, the MPI card slot is powered by the main 12V power supply and both the embedded *b*-LAN and GAME CONTROL/MPI port are powered.

Note that the TV must be turned ON in order to communicate with the embedded *b*-LAN module for configuration and control when POWER SAVINGS is set to 3. If set to 1, the *b*-LAN module is always powered.

Similarly, if MPI communication is required for external MPI control, POWER SAVINGS should be set to 1 so that the GAME CONTROL/MPI port circuitry is always powered.

Note: MPI cards with *b*-LAN technology—LMT7Z5, LMT7Z7, LMT7Z9—are NOT supported on TVs in which *b*-LAN technology is already integrated.

Note: See Reference section, "*b*-LAN Setup & Overview," for further information.

119 - DATA CHANNEL

Set to 0 (default) to disable. Set to the RF channel number of the data channel for Pro:Centric or TV E-Z Installation (splash screen, configuration, and firmware) data.

The TV may take several minutes to load EPG data after AC power is initially applied.

Note: The data channel is automatically set to 253 if Media Type is set to IP in the Pro:Centric Menu on the TV (see "Pro:Centric Setup" on page 45) or if Data Channel is set to IP Address in the FTG File Manager, which is used to configure TV CPUs for FTG Mode operation. It is not possible to change the value to "253" directly.

121 - P:C RF WAKE HR

Set the hour from 0 to 23 for Wake On RF. This item uses the 24-hour clock format. The value "128" is displayed as "OFF." Directly entering 128 turns the Wake On RF feature OFF.

Note: This item is not available in the Installer Menu if item 119 DATA CHANNEL is set to 0 or 253.

122 - P:C RF WAKE MN

Set the minute from 0 to 59 for Wake On RF.

Note: This item is not available in the Installer Menu if item 119 DATA CHANNEL is set to 0 or 253 or if item 121 P:C RF WAKE HR is set to 128/OFF.

Channel Icons / Custom Text Labels (2-5-4 + MENU Mode)

Changing Channel Icons and/or Adding or Editing Custom Text Labels in the Channel-Time Display

If there is no pre-assigned icon for a channel, you can add a custom text label of up to seven (7) characters to help identify the channel or network. Also, if desired, a custom text label can be added to the Channel-Time display in addition to a pre-assigned icon. You may also add text labels for the Aux input sources to clearly identify the devices that are connected to the Aux inputs.

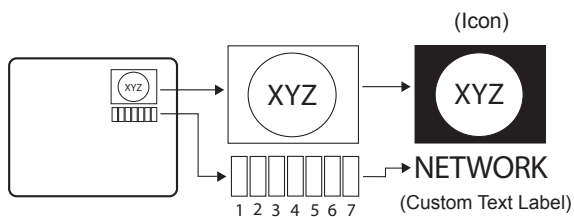

Changing icons and/or adding or editing custom text labels can only be done if there are channels that have been transferred to the TV's PTC either during Master TV Setup (see pages 11 to 14) or by cloning (USB memory device / .tll file or clone programmer only).

Note: A blank letter space is available between “Z” and “!”.

To perform channel editing/labeling:

1. Enter the Installer Menu: Press **MENU** repeatedly until the on-screen display of the TV setup menus no longer toggles, and then press **9-8-7-6 + ENTER**.
2. Press **2-5-4 + MENU** on the Installer Remote to enter the Channel Label Editing Menu.
3. Change channel icons and/or add or edit custom text labels as described in the procedures below. (You can do this more than once.)
4. To exit the menu when you are done, press **MENU**.

Changing a Channel's Icon on the Master TV

1. Use Channel Up/Down to select the desired channel.
2. Use the Left/Right arrow keys to select the thin letter “I” on the Channel-Time display.
3. Use the Up/Down arrow keys to select the icon with which you want to identify the channel. (If you know the icon number, enter the number, and press **ENTER**.)
4. Proceed to add/edit custom text labels, or go to the next channel.

Adding/Editing Channel Labels on the Master TV

1. Use Channel Up/Down to select the desired channel.
2. Press the Left or Right arrow repeatedly until the numbers 1 to 7 appear on the display. The number shows the position of the character that can be changed. Number 1 is the first character, number 2 the second character, etc.
3. Use the Up/Down arrow keys to select the desired character.
4. Proceed to the next number position, or go to the next channel.

Adding/Editing Source Labels on the Master TV

1. Press **INPUT** to select the desired Aux input source: AV1, AV2, RGB, Component, HDMI, or HDMI2.
2. Press the Left or Right arrow repeatedly until the numbers 0 to 9 appear on the display. The number shows the position of the character that can be changed.
3. Use the Up/Down arrow keys to select the desired character.
4. Press **INPUT** for the next Aux input, or use Channel Up/Down to return to channels.

Installer Remote Control Key Functions for Master TV Channel Label Editing Menu

- **Channel Up/Down:** Tunes to the next channel in scan.
- **Left/Right Arrows:** Select the item to change. If “I” is shown, the icon can be changed. If a number is shown, it indicates the position of the character that can be changed.
- **Up/Down Arrows:** Select the icon or the character to be displayed. Tip: Arrows can be held down for fast scrolling.
- **0 – 9:** Use to enter the index number of the icon, if known.
- **ENTER:** Changes the icon after the icon number has been entered.
- **INPUT:** Changes the Aux input label.
- **MENU:** Exits the editing process.

Cloning Overview

IMPORTANT CLONING INFORMATION

Starting with these TV models, there are now four different procedures for cloning a Master TV Setup, each with its own advantages and limitations (see also “Cloning Methods” on page 11):

- Using a USB memory device / .tlx file
- Using a USB memory device / .tll file
- Using a TLL-1100A clone programmer
- Using a LT2002 clone programmer

Each cloning method is described in further detail on the pages that follow. As you perform cloning procedures, be sure to complete each task as indicated. If a procedure or step is omitted or not performed completely, cloning may not work. At each step, pay attention to ensure the TV screen shows the proper message when cloning. If the message indicated does not appear, there is a problem with that step, and cloning may not be successful.



Caution: Copying a blank or incorrect memory into a TV from a clone programmer will cause the TV to operate erratically or become inoperable.



Caution: Do not connect a clone programmer to a PPV card installed in the Master or Target TVs. Also, if the TV is in LodgeNet PPV Mode (check with the site administrator if you are not certain), do not connect a clone programmer to the GAME CONTROL/MPI port. Either of these actions will damage the clone programmer and, if applicable, the PPV card.

Before you begin cloning:

- Complete the Master TV Setup procedure (see pages 11 to 14).
- All equipment should be connected to power and turned ON.
- Both the Master and Target TVs must be in Pass-through Mode.
- Learning and Teaching is only possible between identical model TVs.
- If using a USB memory device, ensure the USB device has been formatted with FAT format.
- If using a USB memory device / .tlx file, ensure that the Master TV Setup does not contain a Channel Map; otherwise, Teaching will result in the Target TV(s) being configured for FTG Mode via CPU.
- For both Master and Target TVs—If using a clone programmer, ensure the TV is tuned to either an Aux input or an analog (not a digital) channel.
- LT2002 only—Make sure the batteries in the clone programmer are fresh. If batteries are removed, the clone programmer clock time (if set) will be lost (see page 32 for information on the clone programmer clock).



Caution: Do not unplug the TV power cord or remove/disconnect the USB memory device/ clone programmer while Learning or Teaching, as doing so may cause the TV to malfunction or harm the USB device/clone programmer, respectively.

Learning / Teaching a Master TV Setup using a USB Memory Device / .tlx File

USB Cloning Notes

- Read the IMPORTANT CLONING INFORMATION on page 24 before beginning any cloning procedures. In particular, ensure that the Master TV Setup does not contain a Channel Map; otherwise, Teaching will result in the Target TV(s) being configured for FTG Mode via CPU.
- You may edit the filename as part of the Learning procedure; however, a file with edited contents will not be recognized.
- It is not possible to clone a Master TV's clock using a USB memory device. Either set a Target TV's clock manually, or use the Auto Clock setting in the TV setup menus.

Learn Setup from Master TV

1. Ensure the Master TV is set up completely and in Pass-through Mode.
2. Plug the USB memory device into the USB IN port on the Master TV.
3. Press **MENU** on the Installer Remote to display the TV setup menus. Use the arrow navigation keys to select/highlight the **Option** menu icon, and then press the number "7" key a total of seven times to display the USB Download Menu.
4. To gain access to the "Learn From TV" option in the USB Download Menu, key in the password used to enter the Installer Menu (Example: Press **9-8-7-6**).
5. Use the Up/Down arrow keys to select **Learn From TV (TLX)**, and then press **ENTER**.
6. To differentiate this .tlx file from others, you can use the Up/Down arrow keys to change the last five digits of the filename. Press **ENTER** when you are ready to initiate Learning. Learning status will be shown on the progress bar. When the Learning process is complete, the USB Download menu will reappear on screen.
7. When Learning is done, remove the USB memory device from the Master TV.

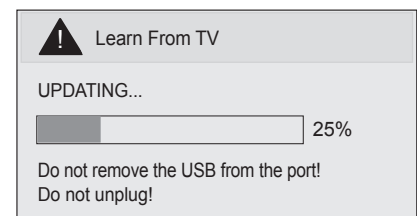
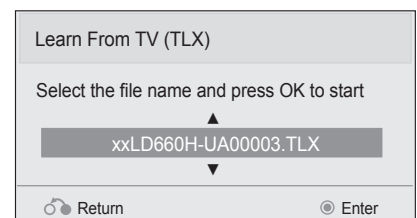
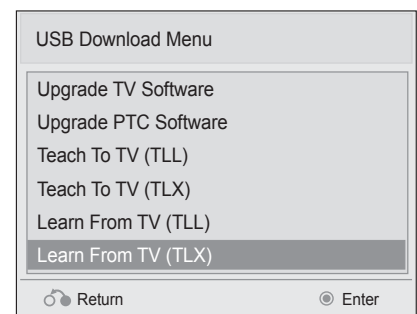

USB Cloning Procedures (Cont.)

Learning / Teaching a Master TV Setup using a USB Memory Device / .tlx File (Cont.)

Teach Master TV Setup to Target TV

1. Ensure the Target TV is in Pass-through Mode, and then use the Installer Remote to enter the Target TV Installer Menu: Press **MENU** repeatedly until the on-screen display of the TV setup menus no longer toggles, and then press **9-8-7-6 + ENTER**.
2. Set Installer Menu item **117 FACT DEFAULT** to **001**, and press **ENTER**. When the value changes back to 0, press **ENTER** again to exit the Installer Menu.
3. Plug the USB memory device with the .tlx file into the Target TV USB IN port.
4. Press **MENU** on the Installer Remote to display the TV setup menus. Use the arrow navigation keys to select/highlight the **Option** menu icon, and then press the number "7" key a total of seven times to display the USB Download Menu.
5. Use the Up/Down arrow keys to select **Teach To TV (TLX)**, and then press **ENTER**.
6. Use the Up/Down arrow keys to select the Master TV Setup you want to install, and then press **ENTER**. Note: Filenames identify the TV and the TLX version (see example at right).
Teaching status will be shown on the progress bar. When the Teaching process is complete, the USB Download menu will reappear on screen.
7. When Teaching is done, remove the USB memory device from the Target TV, turn OFF the TV, and unplug the TV power cord for 15 seconds.
8. Reconnect the TV power cord, and turn ON the TV. The Master TV Setup should be resident on the Target TV.

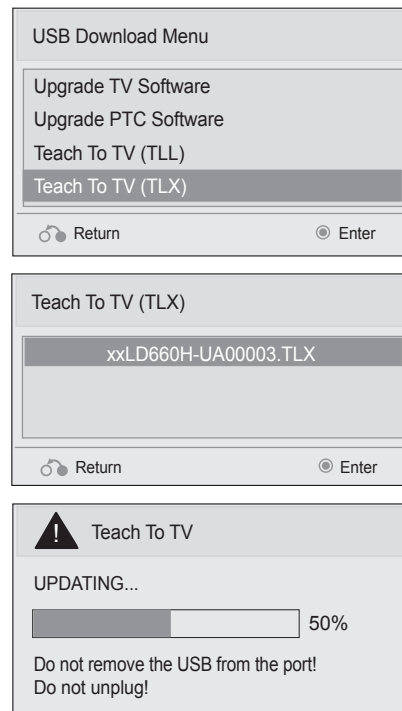

USB Cloning Procedures (Cont.)

Learning / Teaching a Master TV Setup using a USB Memory Device / .tll File

USB Cloning Notes

- Read the IMPORTANT CLONING INFORMATION on page 24 before beginning any cloning procedures.
- You may edit the filename as part of the Learning procedure; however, a file with edited contents will not be recognized.
- It is not possible to clone a Master TV's clock using a USB memory device. Either set a Target TV's clock manually, or use the Auto Clock setting in the TV setup menus.

Learn Setup from Master TV

1. Ensure the Master TV is set up completely and in Pass-through Mode.
2. Plug the USB memory device into the USB IN port on the Master TV.
3. Press **MENU** on the Installer Remote to display the TV setup menus. Use the arrow navigation keys to select/highlight the **Option** menu icon, and then press the number "7" key a total of seven times to display the USB Download Menu.
4. To gain access to the "Learn From TV" option in the USB Download Menu, key in the password used to enter the Installer Menu (Example: Press **9-8-7-6**).
5. Use the Up/Down arrow keys to select **Learn From TV (TLL)**, and then press **ENTER**.
6. To differentiate this .tll file from others, you can use the Up/Down arrow keys to change the last five digits of the filename. Press **ENTER** when you are ready to initiate Learning. Learning status will be shown on the progress bar. When the Learning process is complete, the USB Download menu will reappear on screen.
7. When Learning is done, remove the USB memory device from the Master TV.

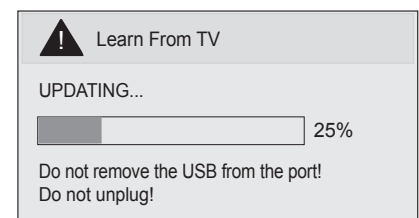
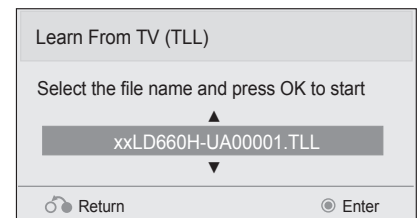
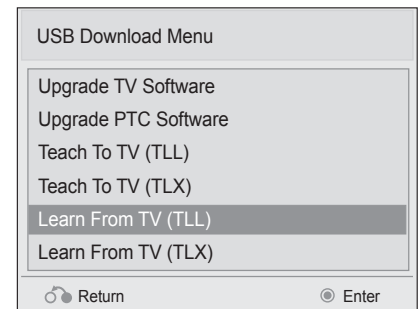

USB Cloning Procedures (Cont.)

Learning / Teaching a Master TV Setup using a USB Memory Device / .tll File (Cont.)

Teach Master TV Setup to Target TV

1. Ensure the Target TV is in Pass-through Mode, and then use the Installer Remote to enter the Target TV Installer Menu: Press **MENU** repeatedly until the on-screen display of the TV setup menus no longer toggles, and then press **9-8-7-6 + ENTER**.
2. Set Installer Menu item **117 FACT DEFAULT** to **001**, and press **ENTER**. When the value changes back to 0, press **ENTER** again to exit the Installer Menu.
3. Tune/set the TV to an analog or digital channel or Aux input, (ideally the same source tuned for 2-5-5 + MENU Mode during the Master TV Setup procedure).
4. Plug the USB memory device with the .tll file into the Target TV USB IN port.
5. Press **MENU** on the Installer Remote to display the TV setup menus. Use the arrow navigation keys to select/highlight the **Option** menu icon, and then press the number "7" key a total of seven times to display the USB Download Menu.
6. Use the Up/Down arrow keys to select **Teach To TV (TLL)**, and then press **ENTER**.
7. Use the Up/Down arrow keys to select the Master TV Setup you want to install, and then press **ENTER**. Note: Filenames identify the TV and the TLL version (see example at right).
Teaching status will be shown on the progress bar. When the Teaching process is complete, the USB Download menu will reappear on screen.
8. When Teaching is done, remove the USB memory device from the Target TV, turn OFF the TV, and unplug the TV power cord for 15 seconds.
9. Reconnect the TV power cord, and turn ON the TV. The Master TV Setup should be resident on the Target TV.

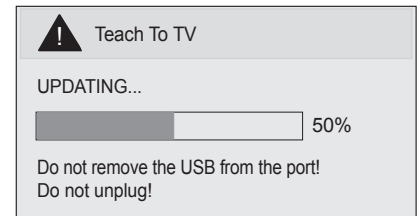
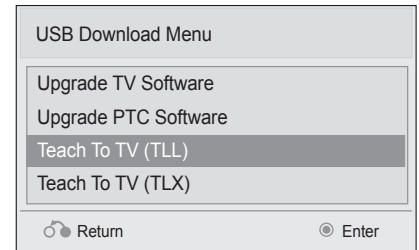

Clone Programmer Cloning Procedures

Learning / Teaching a Master TV Setup using a TLL-1100A Clone Programmer



Caution: Do not connect a clone programmer to a PPV card installed in the Master or Target TVs. Also, if the TV is in LodgeNet PPV Mode (check with the site administrator if you are not certain), do not connect a clone programmer to the GAME CONTROL/MPI port. Either of these actions will damage the clone programmer and, if applicable, the PPV card.

Cloning is accomplished using the TV/clone programmer MPI ports for communication (see figure).

TLL-1100A Cloning Notes

- Read the IMPORTANT CLONING INFORMATION on page 24 before beginning any cloning procedures.
- Ensure the TLL-1100A is either fully charged or connected to AC power.
- Learning and Teaching is only possible between identical model TVs; however, the TLL-1100A can store up to eight different Master TV Setups.

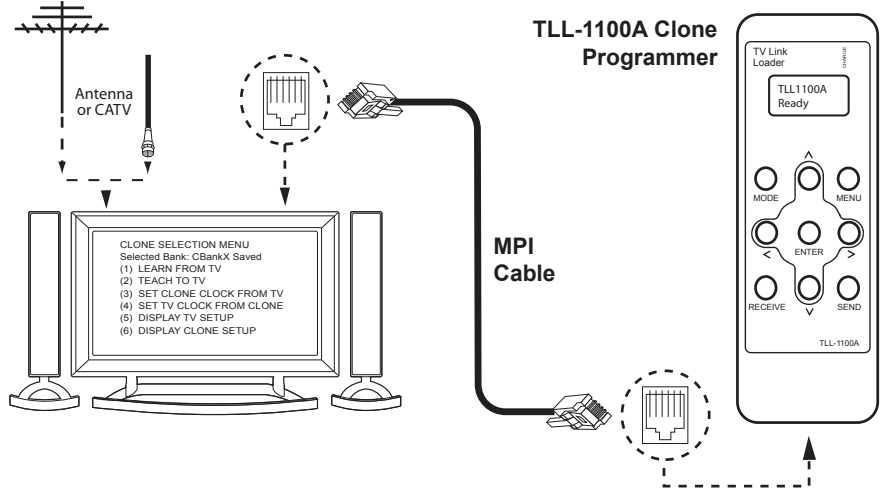

Learn Setup from Master TV

1. Ensure the Master TV is set up completely and in Pass-through Mode.
2. Tune/set the TV to an analog channel or Aux input, and then plug one end of the MPI cable into the TV MPI port.
3. Turn ON the TLL-1100A.
4. Use the **MODE** button on the TLL-1100A to select **Clone Mode**.
5. Use the Left/Right arrows on the TLL-1100A to select the Memory CBank (1 to 8) in which to store the Master TV Setup.
6. Plug the other end of the MPI cable into the MPI port on the bottom of the TLL-1100A. The Clone Selection Menu will display on the TV screen.
7. Press **1** on the Installer Remote to select **LEARN FROM TV** from the Clone Selection Menu. Then, press **ENTER** to transfer the Master TV Setup into CBankX on the TLL-1100A.

Learning usually takes about 90 seconds. "LEARNING IN PROGRESS" will be displayed on the screen while the TLL-1100A copies the Master Setup. When the Learning process is complete, a "LEARNING COMPLETE" message will be displayed.

8. When Learning is complete, disconnect the MPI cable from the Master TV.

CLONE SELECTION MENU
Selected Bank: CBankX Saved
(1) LEARN FROM TV
(2) TEACH TO TV
(3) SET CLONE CLOCK FROM TV
(4) SET TV CLOCK FROM CLONE
(5) DISPLAY TV SETUP
(6) DISPLAY CLONE SETUP

CLONE CLOCK = XX:XX
TV CLOCK = XX:XX
THE CLONE IS VERSION VX.X.X

- To change menu items, press channel keys or digits.
- To execute item, press Enter.

Clone Programmer Cloning Procedures (Cont.)

Learning / Teaching a Master TV Setup using a TLL-1100A Clone Programmer (Cont.)

(Optional) Set the Clock

Set the time on a Master TV's clock. (If the time has already been copied from a TV into the TLL-1100A clone programmer, you can set the Master TV's clock by copying the time from the clone programmer.) The TLL-1100A can copy the current time to both a Master TV and to the clone's internal clock—accurate to within one minute.

Since the TLL-1100A's time cannot be set directly, the current time needs to be copied from an LG TV equipped with an enabled MPI port.

After the time is copied to the TLL-1100A clone programmer, the current time will be maintained and can then be transferred to another TV. (This can be a Master TV or another TV which has already had the features set up.)

CLONE SELECTION MENU
Selected Bank: CBankX Saved
(1) LEARN FROM TV
(2) TEACH TO TV
→ (3) SET CLONE CLOCK FROM TV
→ (4) SET TV CLOCK FROM CLONE
(5) DISPLAY TV SETUP
(6) DISPLAY CLONE SETUP

CLONE CLOCK = XX:XX
TV CLOCK = XX:XX
THE CLONE IS VERSION VX.X.X
- To change menu items, press channel keys or digits.
- To execute item, press Enter.

Teach Master TV Setup to Target TV

1. Ensure the Target TV is in Pass-through Mode, and then use the Installer Remote to enter the Target TV Installer Menu: Press **MENU** repeatedly until the on-screen display of the TV setup menus no longer toggles, and then press **9-8-7-6 + ENTER**.

2. Set Installer Menu item **117 FACT DEFAULT** to **001**, and press **ENTER**. When the value changes back to 0, press **ENTER** again to exit the Installer Menu.

3. Tune/set the TV to an analog channel or Aux input (ideally the same source tuned for 2-5-5 + MENU Mode during the Master TV Setup procedure), and then connect the MPI cable to the MPI port on the Target TV. The Clone Selection Menu will display on the TV screen.

4. Ensure the correct Memory CBank(X) is selected on the TLL-1100A.

5. Press **2** on the Installer Remote to select **TEACH TO TV** from the Clone Selection Menu. Then, press **ENTER** to transfer the Master TV Setup to the Target TV.

Teaching usually takes 3 to 4 minutes. "TEACHING IN PROGRESS" will be displayed on the screen during Teaching. When the Teaching process is complete, a "TEACHING COMPLETE" message will be displayed.

6. When Teaching is done, disconnect the MPI cable from the Target TV, turn OFF the TV, and unplug the TV power cord for 15 seconds.

7. Reconnect the TV power cord, and turn ON the TV. The Master TV Setup should be resident on the Target TV.

CLONE SELECTION MENU
Selected Bank: CBankX Saved
(1) LEARN FROM TV
→ (2) TEACH TO TV
(3) SET CLONE CLOCK FROM TV
(4) SET TV CLOCK FROM CLONE
(5) DISPLAY TV SETUP
(6) DISPLAY CLONE SETUP

CLONE CLOCK = XX:XX
TV CLOCK = XX:XX
THE CLONE IS VERSION VX.X.X
- To change menu items, press channel keys or digits.
- To execute item, press Enter.

Clone Programmer Cloning Procedures (Cont.)

Learning / Teaching a Master TV Setup using an LT2002 Clone Programmer



Caution: Do not connect a clone programmer to a PPV card installed in the Master or Target TVs. Also, if the TV is in LodgeNet PPV Mode (check with the site administrator if you are not certain), do not connect a clone programmer to the GAME CONTROL/MPI port. Either of these actions will damage the clone programmer and, if applicable, the PPV card.

Cloning is accomplished using the TV/clone programmer MPI ports for communication (see figure).

LT2002 Cloning Notes

- Read the IMPORTANT CLONING INFORMATION on page 24 before beginning any cloning procedures.
- A slow flashing green light indicates that there are communication problems between the TV and the LT2002. If this is the case, check for a damaged cable, poor contacts, or other connection troubles.
- If the status indicator is red, the LT2002 batteries are low and should be replaced. Install four (4) high-quality alkaline AA batteries.
- Learning and Teaching is only possible between identical model TVs; however, the LT2002 can store up to three different Master TV Setups.

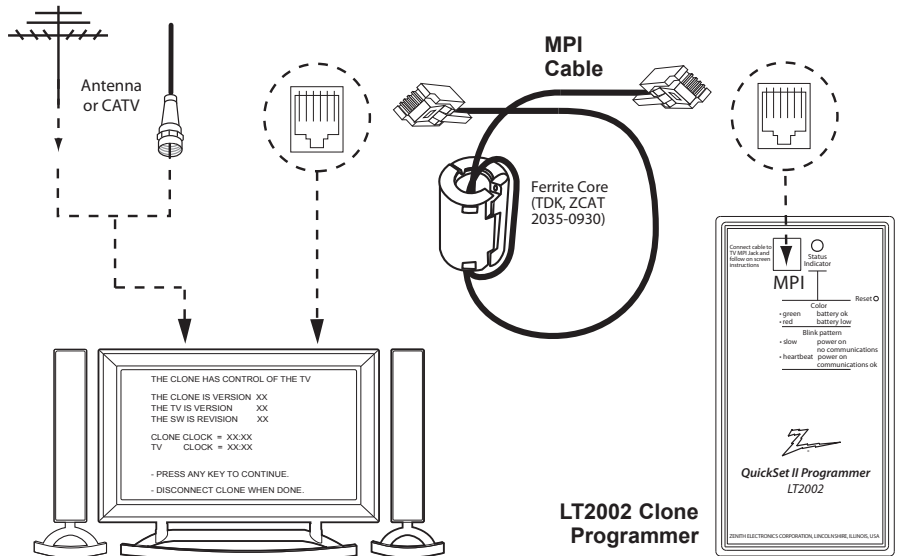

Learn Setup from Master TV

1. Ensure the Master TV is set up completely and in Pass-through Mode.
2. Tune/set the TV to an analog channel or Aux input, and then plug one end of the MPI cable into the TV MPI port.
3. If there is a good connection after the LT2002 is connected to the TV MPI port, "THE CLONE HAS CONTROL OF THE TV" message will appear on the TV screen. Press any key on the Installer Remote to access the LT2002 Clone Selection Menu.
4. Press **1** on the Installer Remote to select **LEARN FROM TV** from the Clone Selection Menu; then press **ENTER** to proceed to the Memory Bank Selection Menu.
5. Press **1, 2, or 3** on the Installer Remote to select the clone Memory Bank in which to store the Master Setup. Then, press **ENTER**.

Note: If you choose a Memory Bank that already has a Master device's setup programmed into it, that setup will be overwritten by the new Master TV Setup.
6. Verify the Learning setup information on the next screen, and then press **POWER** to transfer the Master TV Setup into the selected Memory Bank on the LT2002.

CLONE SELECTION MENU

(1) LEARN FROM TV
 (2) TEACH TO TV
 (3) SET CLONE CLOCK FROM TV
 (4) SET TV CLOCK FROM CLONE
 (5) DISPLAY TV SETUP
 (6) DISPLAY CLONE SETUP

- TO CHANGE MENU ITEMS, PRESS CHANNEL KEYS OR DIGITS.
 - TO EXECUTE ITEM, PRESS ON/OFF, POWER, OR ENTER.

SAVE TV SETUP IN SELECTED CLONE MEMORY

(1) MEMORY 1 VER XX REV XX
 (2) MEMORY 2 VER XX REV XX
 (3) MEMORY 3 VER XX REV XX
 (4) RETURN TO CLONE MENU

- TO CHANGE MENU ITEMS, PRESS CHANNEL KEYS OR DIGITS.
 - TO EXECUTE ITEM, PRESS ON/OFF, POWER, OR ENTER.

(Continued on next page)

Clone Programmer Cloning Procedures (Cont.)

Learning / Teaching a Master TV Setup using an LT2002 Clone Programmer (Cont.)

(Continued from previous page)

Learning usually takes about 90 seconds. “LEARNING IN PROGRESS” will be displayed on the screen while the LT2002 copies the Master Setup. When the Learning process is complete, a “LEARNING COMPLETE” message will be displayed.

7. When Learning is complete, disconnect the MPI cable from the Master TV.

(Optional) Set the Clock

Set the time on a Master TV’s clock. (If the time has already been copied from a TV into the LT2002 clone programmer, you can set the Master TV’s clock by copying the time from the clone programmer.) The LT2002 can copy the current time to both a Master TV and to the clone’s internal clock—accurate to within one minute. (Another reason that the LT2002 should be equipped with fresh, high-quality alkaline batteries, is for it to keep the time as accurately as possible.)

Since the LT2002’s time cannot be set directly, the current time needs to be copied from an LG TV equipped with an enabled MPI port.

After the time is copied to the LT2002 clone programmer, the current time will be maintained and can then be transferred to another TV. (This can be a Master TV or another TV which has already had the features set up.)

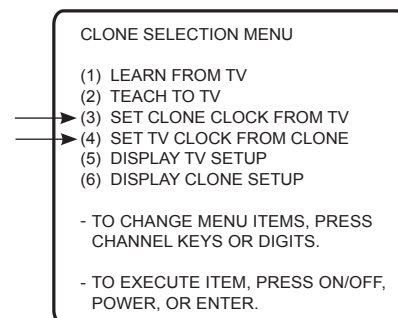

Teach Master TV Setup to Target TV

1. Ensure the Target TV is in Pass-through Mode, and then use the Installer Remote to enter the Target TV Installer Menu: Press **MENU** repeatedly until the on-screen display of the TV setup menus no longer toggles, and then press **9-8-7-6 + ENTER**.

2. Set Installer Menu item **117 FACT DEFAULT** to **001**, and press **ENTER**. When the value changes back to 0, press **ENTER** again to exit the Installer Menu.

3. Tune/set the TV to an analog channel or Aux input (ideally the same source tuned for 2-5-5 + MENU Mode during the Master TV Setup procedure), and then connect the MPI cable to the MPI port on the Target TV.

4. With “THE CLONE HAS CONTROL OF TV” message on display, press **2** on the Installer Remote to select **TEACH TO TV** from the LT2002 Clone Selection Menu. Then, press **ENTER**.

5. Select the LT2002 Memory Bank in which the new Master TV Setup is located, and press **ENTER**.

6. Verify the Teaching setup information on the next screen, and then press **POWER** to transfer the Master TV Setup to the Target TV.

Teaching usually takes 3 to 4 minutes. “TEACHING IN PROGRESS” will be displayed on-screen during Teaching. When the Teaching process is complete, a “TEACHING COMPLETE” message will be displayed.

7. When Teaching is done, disconnect the MPI cable from the Target TV, turn OFF the TV, and unplug the TV power cord for 15 seconds.

8. Reconnect the TV power cord, and turn ON the TV. The Master TV Setup should be resident on the Target TV.

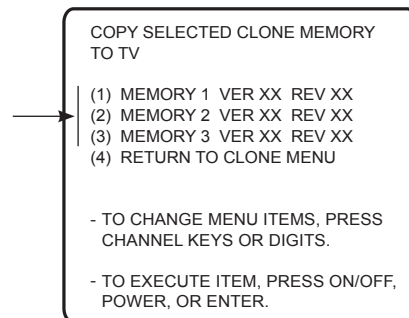
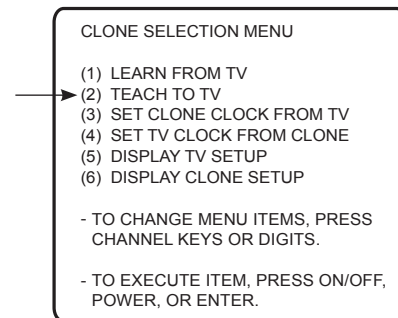

FTG Mode via CPU or EBL

FTG Mode enables Pro:Idiom decryption and also allows logical channel mapping of physical channels.

As indicated in the introduction to this document, there are two separate and distinct methods for configuring LD660H/LD665H and LV555H TVs for FTG Mode of operation: one (new) method is to configure the TV CPU for FTG Mode operation, while the other is to configure the TV EBL for FTG Mode operation. FROM A LOCAL CONFIGURATION STANDPOINT, EACH OF THESE METHODS IS MUTUALLY EXCLUSIVE. IF THE CPU IS IN FTG MODE, THE EBL CANNOT BE SWITCHED TO FTG MODE. LIKEWISE, IF THE EBL IS IN FTG MODE, THE CPU CANNOT BE SWITCHED TO FTG MODE.

FTG Mode via CPU

This mode provides the following features:

- Logical channels mapped to either RF or IP delivered content.
- Digital RF channel minor (program) numbers up to 999.
- FTG Channel Map of up to 600 logical channels.
- Start Channel set for RF, Aux input, or IP delivered content.
- Pro:Centric data delivery over RF or IP.

FTG Mode via CPU requires LG FTG File Manager PC software to create an FTG Configuration (.tlx) file. In this mode, the CPU is the owner of the FTG Channel Map and must be configured with an FTG Channel Map and FTG Installer Menu settings using one of the following processes:

- Local: Configure an individual LD660H/LD665H/LV555H TV via its USB port using an FTG Configuration (.tlx) file on a USB memory device. The “Teach to TV (TLX)” process, along with associated procedures, is described on pages 35 to 39.
- Remote: Configure all LD660H/LD665H/LV555H TVs at the site using a Pro:Centric server head end device (Example: PCS150R). Load an FTG Configuration (.tlx) file on the Pro:Centric server using the TV E-Z Installation “Configuration” option in the Pro:Centric Server Admin Client. Refer to the **Pro:Centric™ Server Admin Client User Guide** for further information.

FTG Mode via EBL

This mode provides the following features:

- Logical channels mapped to RF delivered content.
- Digital RF channel minor (program) numbers up to 255.
- FTG Channel Map of up to 141 logical channels.
- Start Channel set for RF or Aux input delivered content.
- Pro:Centric data delivery over RF.

FTG Mode via EBL requires LG FTG Device Configuration Application PC software to create an FMA Configuration (.fma) file. In this mode, the EBL is the owner of the FTG Channel Map and must be configured with an FTG Channel Map and FTG Installer Menu settings using one of the following processes:

- Local: Configure an individual LD660H/LD665H/LV555H TV's EBL via its TV-LINK CFG jack using a direct PC-to-TV connection and the FTG Device Configuration Application. The “Write” process for an FTG Channel Map and FTG Installer Menu settings is described on page 40.
- Remote: Configure all LD660H/LD665H/LV555H TV EBLs at the site using a Free-To-Guest Management Appliance (FMA) head end device (Example: FMA-LG101). Refer to the **Free-To-Guest (FTG) Configuration Application** manual and/or the Installation & Setup manual for the FMA device for further information.



Caution: (FTG Mode via CPU only) If applicable, IP/network settings must be completed in the IP Environment Menu before a TV is configured for FTG Mode (see page 45 for further information—the default network setting is DHCP). If IP/network requirements change after a TV has been configured for FTG Mode, the TV will need to be reset to Pass-through Mode before the settings can be modified (see Reference section, “Resetting Factory Defaults on the TV(s),” for further information).

FTG Mode of Operation Overview (Cont.)

While the TV is in FTG Mode:

- Users can still access the Installer Menu using an LG Installer Remote; however, all Installer Menu items will be read-only.
- Any FTG configuration changes must be made using either the FTG File Manager (FTG Mode via CPU) or the FTG Device Configuration Application (FTG Mode via EBL). FTG Channel Map Configuration and FTG Installer Menu Configuration Utilities enable you to make changes, respectively, to the FTG Channel Map and FTG Installer Menu settings as necessary. Based on the initial method used to configure the TV for FTG Mode operation (via CPU or EBL), all subsequent changes must be transferred to either the TV or the EBL via a process that is in accordance or compatible with that method (see information on local configuration in this document or refer to documentation for the head end device/server for information on remote management).
- If it becomes necessary to reset the TV to Pass-through Mode, there are several options that will enable you to do so. Refer to Reference section, "Resetting Factory Defaults on the TV(s)," for further information.

Pages 41 to 44 provide overviews of the utilities that comprise the FTG File Manager. Refer to the **Free-To-Guest (FTG) File Manager User Guide** for further information on the FTG File Manager. Refer to the **Free-To-Guest (FTG) Configuration Application** manual for information on the FTG Device Configuration Application.

Determining the TV Operating Mode

To determine the operating mode of the TV, press **MENU** on the Installer Remote. The menu display alternates based on the operating mode. See examples below.

If the end user Function Menu appears, typically the TV is in FTG Mode. If the TV setup menus appear, the TV is in Pass-through Mode.

Note: If the TV is not in FTG Mode, but both the Data Channel and the Pro:Centric Application Mode have been set in the Installer Menu or the Pro:Centric Menu, the TV is in Application Tuning Mode. In Application Tuning Mode, only the Function Menu is available to end users instead of the TV setup menus; however, Installer Menu items remain editable (not read-only).

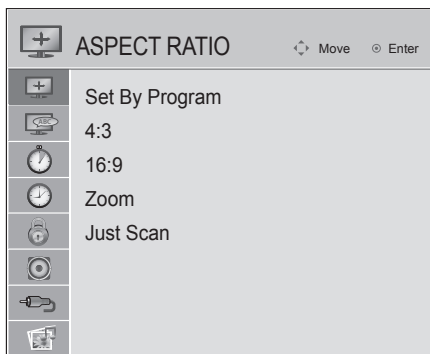

Function Menu

Indicates the TV (CPU or EBL) is not in Pass-through Mode. While the TV is in FTG Mode, Installer Menu settings can be accessed as read-only.

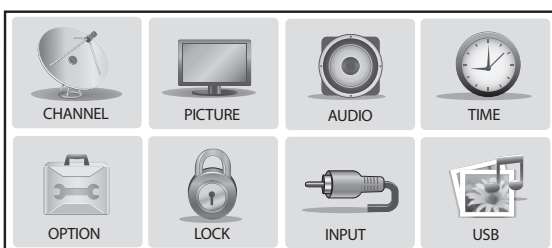

TV Setup Menus

Shows that the TV is in Pass-through Mode.

Creating an FTG Configuration File using the FTG File Manager

This section describes how to create an FTG Configuration (.tlx) file that can be saved to a USB memory device. In order to enable Pro:Idiom decryption, it is recommended that you create an FTG Configuration file using the FTG File Manager.

Notes: • FTG File Manager software is available online at: www.LGcommercial.com/FTGsoftware.

- There is also an option to save (Learn) an FTG Configuration file from a TV, which may be desirable or required in either of the following situations:
 - If you want to save customized TV setup menu settings to the FTG Configuration file (in addition to the FTG Channel Map and FTG Installer Menu settings).
 - If you do not know the RF channels at the site.

See “Learning an FTG Configuration File from a TV” on page 38 for further information. However, if you use this option to save an FTG Configuration file, it is still highly recommended that you open the new FTG Configuration file in the FTG File Manager to verify the file contents/settings and to enable Pro:Idiom decryption by marking Encrypted channels.

The procedure below provides an overview of the steps required to create an FTG Configuration (.tlx) file. Refer to the **Free-To-Guest (FTG) File Manager User Guide** for further information. See also FTG File Manager sample screens on pages 41 to 44.

1. Install (if necessary) and launch the FTG File Manager (v1.0.0 or higher) on the PC that will be used to create the FTG Configuration (.tlx) file.
2. You have a number of options:
 - To view and/or base a new FTG Configuration file on an existing LD660H/LD665H or LV555H FTG Configuration (.tlx) file, click **Open** under the TLX File section of the FTG File Manager main screen, and select the desired (.tlx) file.

A list of the file’s contents will be displayed in the TLX File Contents window. Double-click each item individually or click **Copy All** to transfer all the items listed to the FTG Configuration List and, if applicable, to the TV Setup Menu List, though note that while TV setup menu settings can be included in the new FTG Configuration file, the TV Setup Menu List is not available for editing.

Edit the configuration of the items in the FTG Configuration List as well as the FTG Configuration List, as necessary, to create a new file, and then proceed to step 4 when you are ready to continue.
 - If applicable, you can also open an existing FTG Configuration (.rml) file created in the FTG Device Configuration Application to use its FTG Channel Map and/or FTG Installer Menu settings. Edit the channels and/or settings as necessary.
 - Otherwise, create a new FTG Channel Map using the FTG Channel Map Editor in the FTG Channel Map Configuration Utility. Then, continue with step 3.

Note: Up to 600 logical channels (combined total of both RF and IP mapped channels) can be defined in the FTG Channel Map.
3. If necessary, click **Configure** in the FTG File Manager menu bar, and select **FTG File Manager** to return to the FTG File Manager main screen.

(Continued on next page)

FTG Mode via CPU (Cont.)

(Continued from previous page)

4. To add an FTG Channel Map, click >> under FTG Channel Map to copy the current Mapped RF Channels and Mapped IP Channels to the FTG Configuration List.
Note: If you make any change(s) in the FTG Channel Map Configuration Utility to the current data to be included in the FTG Configuration List, you will need to recopy the FTG Channel Map to the FTG Configuration List.
5. (Optional) Load default FTG Installer Menu settings for the TV:
 - Click the down arrow at the right of the Chassis field under Installer Menu Templates, and select the appropriate option (depending on the TV type) from the drop-down list of available models.
 - Click the **Load** button.
 - Use the FTG Installer Menu Configuration Utility to modify settings, if necessary. Then, return to the FTG File Manager main screen.
6. To add FTG Installer Menu settings, click >> under FTG Installer Menu Settings to copy the current settings to the FTG Configuration List.
Note: If you make any change(s) in the FTG Installer Menu Configuration Utility to the current data to be included in the FTG Configuration List, you will need to recopy the FTG Installer Menu settings to the FTG Configuration List.
7. Click the **Save** button above the FTG Configuration List to save its contents (including TV setup menu settings, if present) to an FTG Configuration (.tlx) file on the PC's hard drive for later use (default folder path is C:\Program Files\Zenith\FTG\TLX).
8. Transfer the FTG Configuration file to a USB memory device, and proceed to "Teaching FTG Configuration to a TV" below to transfer the FTG Configuration file to an LD660H/LD665H or LV555H TV.

Teaching FTG Configuration to a TV

This procedure describes how to “Teach” an FTG Configuration file from a USB memory device to a TV. Ensure you have completed the procedure on the previous page to create the FTG Configuration file before proceeding with the steps below.

- Notes:**
- If the TV is not in FTG Mode, but both Pro:Centric items (098 PRO:CENTRIC and 119 DATA CHANNEL) have already been set in the Installer Menu on a TV, Teach to TV options will not be available from the USB Download Menu.
 - If the TV EBL is already in FTG Mode, you cannot use this procedure to make changes to the FTG Channel Map and FTG Installer Menu settings. You must use a direct PC-to-TV connection as described on page 40 or an FMA head end device to reconfigure the EBL.
 - If either of the preceding conditions applies, but you wish to switch the TV to FTG mode via CPU, refer to Reference section, “Resetting Factory Defaults on the TV(s),” for further information before proceeding.

1. Plug the USB memory device that contains the FTG Configuration file into the Target LD660H/LD665H or LV555H TV USB IN port.
2. Press **MENU** on the Installer Remote to display the TV setup menus (TV is in Pass-through Mode) or the Function Menu (TV is already in FTG Mode).
3. Use the arrow navigation keys to select/highlight either the **Option** menu icon from the TV setup menus or the **Lock** menu icon from the Function Menu. Then, press the number “7” key a total of seven times to display the USB Download Menu.
4. Use the Up/Down arrow keys to select **Teach To TV (TLX)**, and then press **ENTER**.
5. Use the Up/Down arrow keys to select the FTG Configuration file you want to install, and then press **ENTER**.

The TV will show Teaching completion progress in a new window. Do NOT remove the USB device until Teaching is complete. When Teaching is complete, the TV will tune to the first logical channel in the FTG Channel Map.

6. When Teaching is done, remove the USB memory device. The FTG Configuration should be resident on the Target TV. Also, the Target TV CPU is now in FTG Mode (if it was previously in Pass-through Mode).

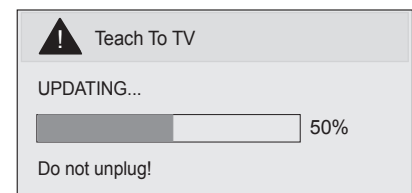
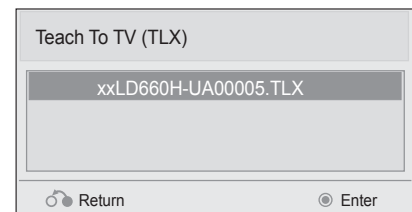
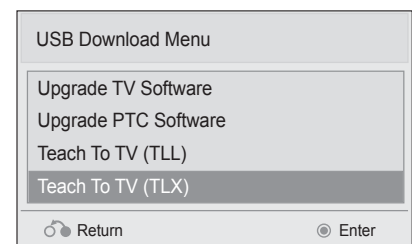

FTG Mode via CPU (Cont.)

Learning an FTG Configuration File from a TV

To ensure that Pro:Idiom decryption is enabled, it is recommended that you create an FTG Configuration file using the FTG File Manager as described on pages 35 to 36. However, if necessary, this option enables you to save (Learn) an FTG Configuration file from an LD660H/LD665H or LV555H TV to a USB memory device.

- Notes:**
- The option to save (Learn) an FTG Configuration file from a TV may be desirable or required in either of the following situations:
 - If you want to save customized TV setup menu settings to the FTG Configuration file (in addition to the FTG Channel Map and FTG Installer Menu settings).
 - If you do not know the RF channels at the site.
 - If the TV is NOT already in FTG Mode, you may need to perform some manual configuration on the TV before you start this procedure (see “Optional Manual Configuration / TV Setup” on following page).

1. Plug a USB memory device into the USB IN port on the TV.
2. Press **MENU** on the Installer Remote to display the TV setup menus (TV is in Pass-through Mode) or the Function Menu (TV is already in FTG Mode).
3. Use the arrow navigation keys to select/highlight either the **Option** menu icon from the TV setup menus or the **Lock** menu icon from the Function Menu. Then, press the number “7” key a total of seven times to display the USB Download Menu.
4. To gain access to the Learn From TV options in the USB Download Menu, key in the password used to enter the Installer Menu (Example: Press **9-8-7-6**).
5. Use the Up/Down arrow keys to select **Learn From TV (TLX)**, and then press **ENTER**.
6. To differentiate this .tlx file from others, you can use the Up/Down arrow keys to change the last five digits of the filename. Press **ENTER** when you are ready to initiate Learning.
The TV will show Learning completion progress in a new window. Do NOT remove the USB device until Learning is complete. When Learning is complete, the USB Download Menu will reappear on screen.
7. When you are finished, remove the USB memory device.

 **Note: It is highly recommended that you open this FTG Configuration file in the FTG File Manager—BEFORE transferring (Teaching) the file to any TVs—to verify FTG Channel Map and FTG Installer Menu settings and enable Pro:Idiom decryption by marking Encrypted channels. This will also enable you to confirm and add channel attributes, labels, etc.**

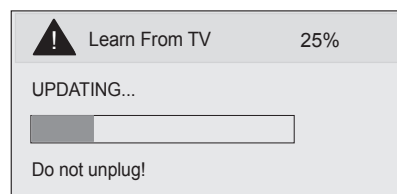
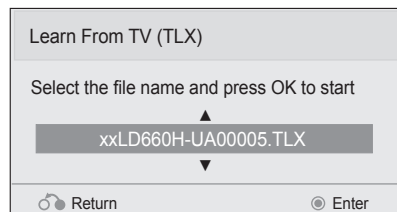
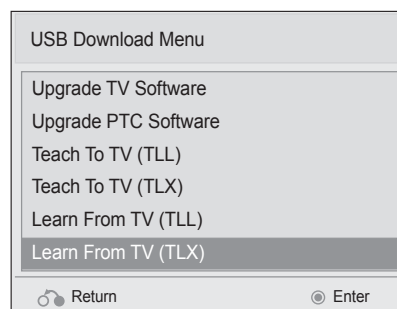

Optional Manual Configuration / TV Setup

The manual configuration procedures below should only be performed if you do not know the RF channels at the site and need to “Learn” an FTG Configuration file from an LD660H/LD665H or LV555H TV as described on the previous page. Ensure the TV is in Pass-through Mode before you begin.

Set Installer Menu Items

These steps provide specific instruction only on the Installer Menu items that should be set on an LD660H/LD665H or LV555H TV. Refer to pages 15 to 22 for detailed information on all Installer Menu items.

1. Make sure the TV is ON. Then, use the Installer Remote to enter the Installer Menu: Press **MENU** repeatedly until the on-screen display of the TV setup menus no longer toggles, and then press **9-8-7-6 + ENTER**.
2. Set Installer Menu item **117 FACT DEFAULT** to **001** and press **ENTER** on the Installer Remote.

This clears all Installer Menu custom settings, the channel lineup, etc. and reloads the factory default settings. The value will change back to 0 after the commercial controller (PTC) has been restored to factory default condition. This step ensures that the TV Channel Memory will be the active channel lineup.

3. Set Installer Menu item **003 BAND/AFC**, as appropriate.
 - Broadcast: Set to 000.
 - CATV: Set to 001 (default).
 - HRC: Set to 002.
 - IRC: Set to 003.
4. Set any other Installer Menu items that affect your TV programming network to the required configuration. For example, enable/disable Aux inputs, set a Start Channel, etc.
5. After you have adjusted all required Installer Menu item settings, press **ENTER** once on the Installer Remote to save your changes; then, press **ENTER** again to exit the menu.

Run Auto Tuning (Channel Search)

Note: In the FTG Configuration file, Logical Channel numbers will automatically be assigned in ascending order, starting with 0 (zero), to the Physical Channels from the TV Channel Map.

Note: Pro:Idiom decryption for encrypted channels will not be enabled unless you use the FTG File Manager to set the channel attributes.

1. Search for all available analog and digital channels: Use the Installer Remote to go to the Channel Menu, select the **Auto Tuning** option, and follow the on-screen instructions.
2. Use the **Channel Edit** option in the Channel Menu to edit the channel lineup, as necessary, to include free to guest channels only. Add/delete channels per your system requirements.

Once you have completed these procedures, return to “Learning an FTG Configuration File from a TV” on the previous page to complete the Learn sequence.

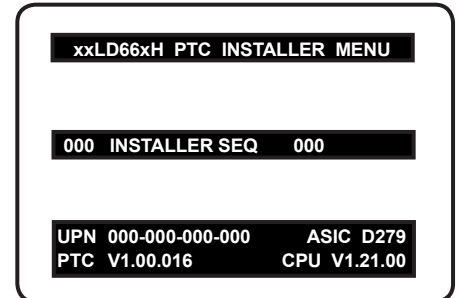

Typical Installer Menu

Note: The Installer Menu header will vary depending on the TV you are setting up.

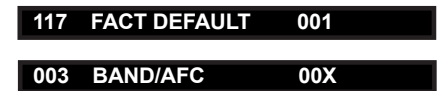

Adjust the settings for these Installer Menu items.

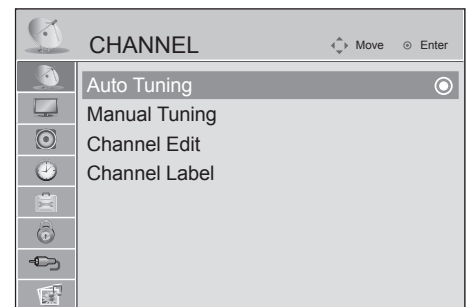

Use Channel Menu options to run Auto Tuning and edit the channel lineup, as necessary.

FTG Mode via EBL (Local Configuration)

The following steps outline local FTG configuration of individual TV EBLs using a direct PC-to-TV connection. Refer to the **Free-To-Guest (FTG) Configuration Application** manual for further information.

- Notes:**
- FTG Device Configuration Application software is available online at: www.LGcommercial.com/FTGsoftware.
 - If the TV CPU is already in FTG Mode, you cannot use this procedure to make changes to the FTG Channel Map and FTG Installer Menu settings. Instead, refer to and use the processes described on pages 35 to 37 to reconfigure the TV CPU.
 - If the preceding condition applies, but you wish to switch the TV to FTG Mode via EBL, refer to Reference section, "Resetting Factory Defaults on the TV(s)," for further information before proceeding.

1. Install (if necessary) and launch the FTG Device Configuration Application (v5.0.0 or higher) on the PC that will be used to configure the EBL.
 2. Build an FTG Channel Map using the FTG Channel Map Editor in the FTG Channel Map Configuration Utility (or, if applicable, open an existing FTG Configuration [.rml] file).
- Note:** Up to 141 logical channels can be defined in the FTG Channel Map.

3. Connect the PC to the TV-LINK CFG jack on the TV's rear connections panel using a USB-to-TTL serial cable (TTL-232R-5V-AJ). If necessary, install the device driver on the PC.
4. Turn ON the TV.

Note: If Installer Menu item 118 POWER SAVINGS is set to 3 (default), the TV must be ON in order for steps 5 and 6 below to be successful.

5. "Write" the FTG Channel Map to the EBL (switches the EBL from Pass-through Mode to FTG Mode).

Note: After a "Write" of new data, the TV will briefly display a green text banner that shows the EBL firmware version and release date.

6. "Read" the current FTG Installer Menu settings from the EBL using the FTG Installer Menu Configuration Utility. If necessary to make changes to Installer Menu items, "Write" them back to the EBL in FTG Mode.
7. Save the FTG Channel Map and FTG Installer Menu settings to an FTG Configuration (.rml) file for future use.
8. Tune the TV to a Logical Channel in the FTG Channel Map.

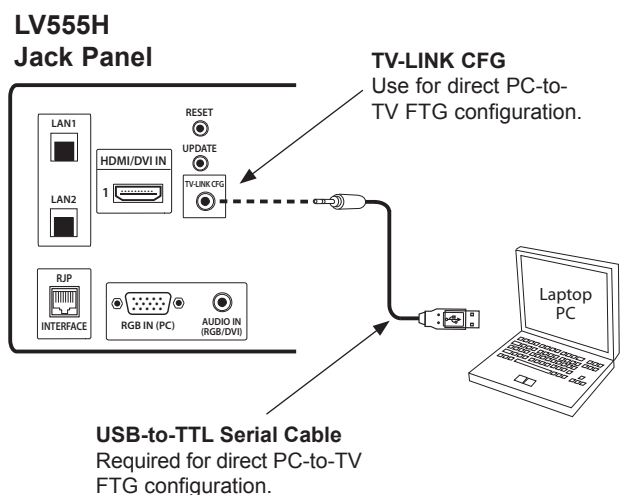
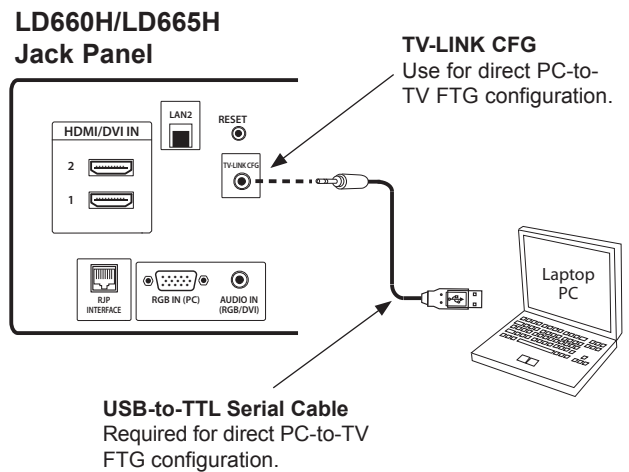

FTG File Manager Main Screen

FTG CONFIGURATION LIST
Data to be saved in FTG Configuration (.tix) file.

CLEAR/SAVE
FTG Configuration List options.

NEW/OPEN
TLX File options.

Filename of opened FTG Configuration (.rml) file created using FTG Device Configuration Application.

Copy FTG Channel Map to and from FTG Configuration List.

Copy FTG Installer Menu settings to and from FTG Configuration List.

Load default FTG Installer Menu for LD660H/ LD665H or LV555H.

TV SETUP MENU LIST
Data to be saved in FTG Configuration file.

TLX FILE CONTENTS
Data contained in opened FTG Configuration (.tix) file.

The screenshot shows the FTG File Manager interface with the following elements:

- FTG File:** A text field for the filename of the opened FTG Configuration (.rml) file.
- FTG Channel Map:** Two sections with arrows for copying data to and from the FTG Configuration List:
 - 21 Mapped RF Channels
 - 0 Mapped IP Channels
- FTG Installer Menu Settings:** A section with a dropdown menu and arrows for copying settings to and from the FTG Configuration List. The dropdown shows "#65-1 - 32/37/42LD660H (Items Default)".
- Installer Menu Templates:** A section with a "Chassis" dropdown menu (set to "Select Model") and a "Load" button. A note states: "Note: A template contains the default settings pertaining to its chassis model".
- List:** A central area with "Clear" and "Save" buttons, and a table titled "FTG Configuration List" containing:

21 Mapped RF Channels	Remove Item
IMS (Items Default) 32/37/42LD660H	
- TLX File:** A right-hand area with "New" and "Open" buttons, and a table titled "TLX File Contents" with a "Copy All" button.
- TV User Menu List:** A table at the bottom with a "Remove Item" button.



Note: The data referenced in the FTG Configuration List is only a snapshot of the current FTG Channel Map and FTG Installer Menu settings when copied to the list. If you make any change(s) to the current data to be included in the FTG Configuration List, you will need to recopy Channel Map and Installer Menu settings to the FTG Configuration List.

FTG File Manager Utilities Overview (Cont.)

FTG Channel Map Configuration Utility

The FTG Channel Map Configuration Utility enables you to build a Channel Map with logical channel numbers. The FTG Channel Map for LD660H/LD665H and LV555H TVs may contain both RF and IP channels. Select the appropriate tab—RF Channel Map or IP Channel Map—as necessary, either in this screen, or in the Channel Map Editor (see next page).

RF Channel Map

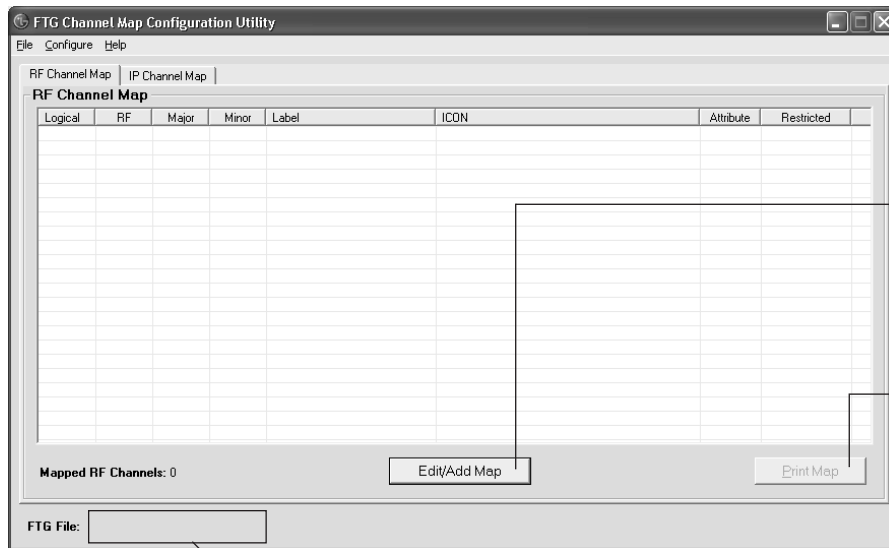

EDIT/ADD MAP

Click to open the FTG Channel Map Editor to create or edit an FTG Channel Map (see next page).

PRINT MAP

Click to display a printable FTG Channel Map Report. The report can also be exported as an HTML or Text file.

Filename of opened FTG Configuration (.rml) file created using FTG Device Configuration Application.

IP Channel Map

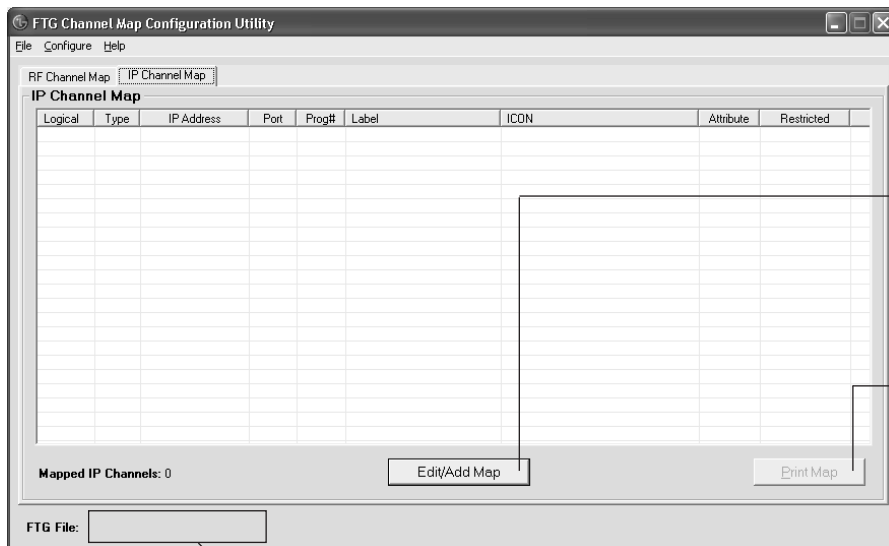

EDIT/ADD MAP

Click to open the FTG Channel Map Editor to create or edit an FTG Channel Map (see next page).

PRINT MAP

Click to display a printable FTG Channel Map Report. The report can also be exported as an HTML or Text file.

Filename of opened FTG Configuration (.rml) file created using FTG Device Configuration Application.

FTG File Manager Utilities Overview (Cont.)

FTG Channel Map Editor

The FTG Channel Map Editor shows a single Logical Channel's data and the FTG Channel Map. Select the appropriate tab—RF Channel Map or IP Channel Map—as necessary, in the bottom panel of the screen.

LOGICAL CHANNEL MAPPING

Select a Logical Channel number. Then, for an RF channel, assign it the RF, Major, and Minor channel numbers to complete the mapping, or for an IP channel, assign it the IP Address, IP Type, Port Address, and Program # to complete the mapping.

CUSTOM CHANNEL LABELS/ICONS

Enter custom labels and select icons by name on menu or by number.

SET CHANNEL ATTRIBUTES

Check/select Encrypted, OSD, or Blank Video.

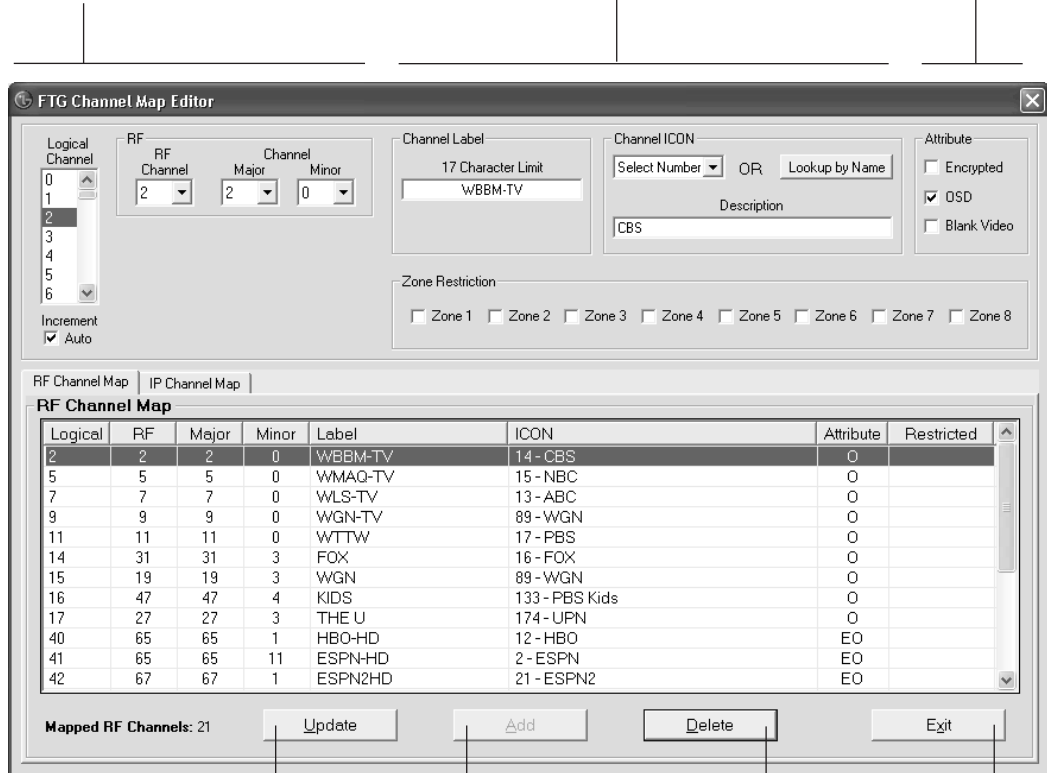

ZONE RESTRICTION
Select Zone restriction for channel. See Reference section, "TV Zone Restrictions," for further information.

ADD
After defining a new Logical Channel, click to add channel to the FTG Channel Map.

EXIT
Click to exit editor and return to FTG Channel Map Configuration Utility.

UPDATE
After editing an existing Logical Channel's data, click to commit the changes in the FTG Channel Map.

DELETE
Click to remove highlighted channel from FTG Channel Map.

FTG File Manager Utilities Overview (Cont.)

FTG Installer Menu Configuration Utility

CONFIGURATION SETTINGS

Select tabs for categories of Installer Menu items to set up TV.

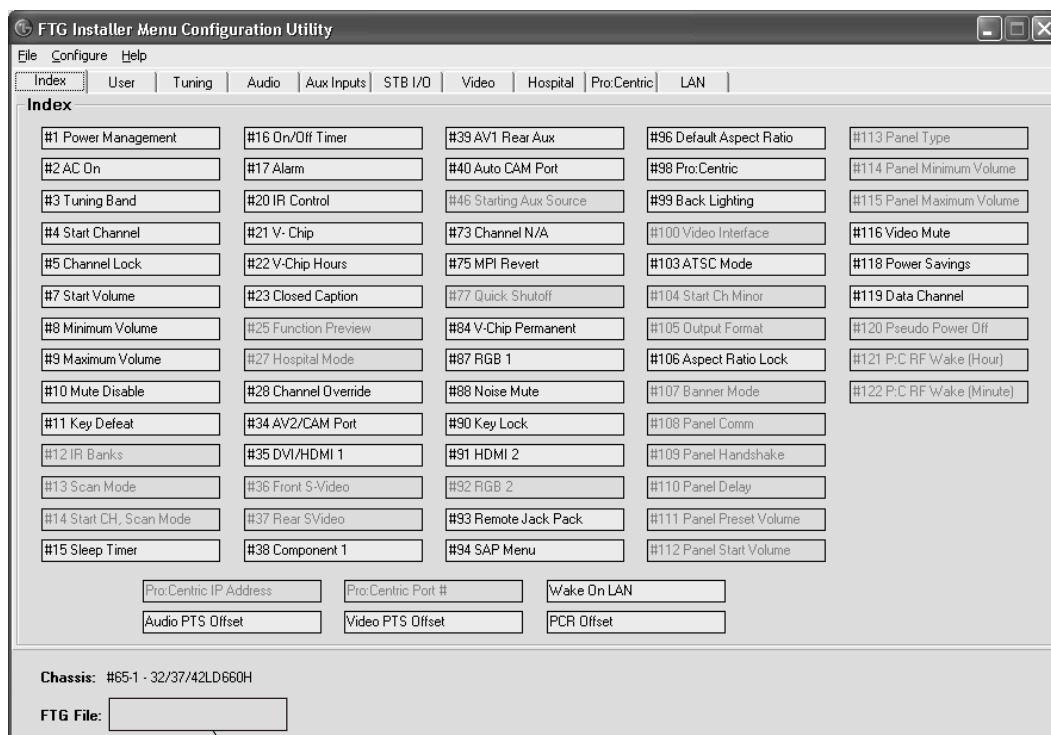

Filename of opened FTG Configuration (.rml) file created using FTG Device Configuration Application.

Notes:

- Pro:Centric and LAN tabs enable you to set up parameters equivalent to the Offset Setup and Pro:Centric Menus described under “IP Environment Setup” on pages 45 and 46 of this document. Refer to the **Free-To-Guest (FTG) File Manager User Guide** for further information on these tabs.
- The Start Channel item (#4) in the Tuning tab for these models allows you to assign an IP start channel.
- The Hospital tab contains setup items that are applicable only for hospital-grade TV models.

The IP Environment Menu enables you to set up network features of the TV. Like the Installer Menu, the IP Environment Menu is editable (with the Installer Remote) only if the TV is in Pass-through or Application Tuning Mode and read-only when the TV is not in either of these modes.

Access the IP Environment Menu

1. Use the Installer Remote to enter the Installer Menu: Press **MENU** repeatedly until the on-screen menu display no longer toggles, and then press **9-8-7-6 + ENTER**.
2. Navigate to Installer Menu item **119 DATA CHANNEL**, and press **2-5-3 + MENU** to launch the IP Environment Menu (see sample displays below).

Use the Up/Down arrow keys on the Installer Remote to select the desired menu option—Network Setup, Offset Setup, or Pro:Centric—and then press **ENTER**. Refer to the following sections for information on each of the IP Environment setup options.

Network Setup

If the TV is connected to a network with a DHCP server, by default the server will automatically assign an IP address to the TV. The Network Setup Menu options enable you to set up static IP/network connections or to revert from static to DHCP settings. Use the Up/Down arrow keys to navigate between fields.

1. With Network Setup selected, use the Left/Right arrow keys on the Installer Remote to select **Static** or **DHCP** in the Mode field.
2. (Static IP/network connections only) Complete the IP Address, Subnet Mask, Gateway, DNS1, and DNS2 fields. Either key in or use the Left/Right arrow keys to select the appropriate values.
3. When you have completed all fields as necessary, navigate to **Apply**, and then press **ENTER**.
4. Press **MENU** to return to TV viewing, or press **RETURN** to return to the previous menu level.

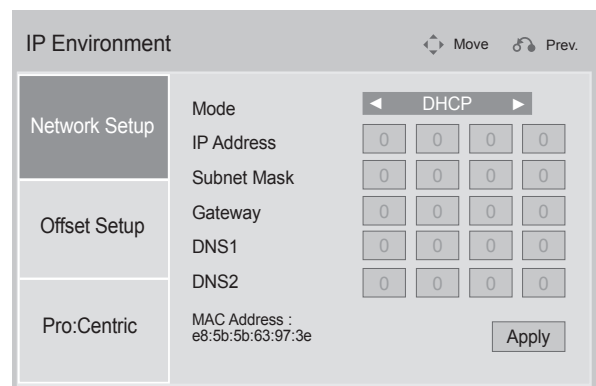

Offset Setup

If necessary, due to an audio and/or video stream delay, the Offset Setup Menu options enable you to compensate for synchronization irregularities by allowing audio PTS, video PTS, and PCR offset modifications. Note that any offset modifications should be performed by qualified personnel only.

1. With Offset Setup selected, use the Up/Down arrow keys on the Installer Remote to navigate to the appropriate field: Audio PTS Offset, Video PTS Offset, or PCR Offset.
2. Use the Left/Right arrow keys to set the appropriate offset value for the selected field. Offset values are represented in 10 ms intervals to 500 ms or -500 ms.
3. When you have completed all modifications as required, press **MENU** to return to TV viewing, or press **RETURN** to return to the previous menu level.

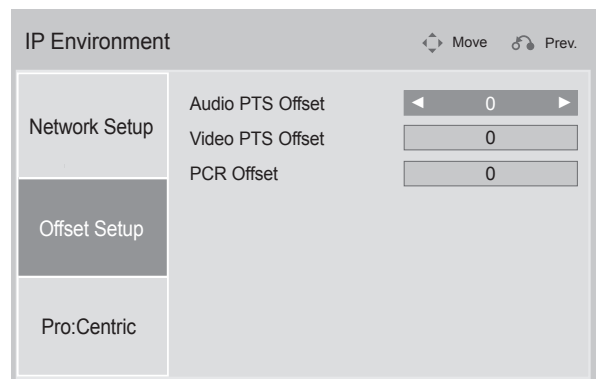

IP Environment Setup (Cont.)

Pro:Centric Setup

The Pro:Centric Menu options enable you to configure Pro:Centric server settings in the TV. With Pro:Centric selected, use the Up/Down arrow keys to navigate between fields.

Note: Options that are initially grayed out/inaccessible in the Pro:Centric Menu are dependent upon other settings in the display. For example, if “IP” is selected in the Media Type field, the Server IP and Port Number fields become accessible.

Note: For those fields that permit direct entry of numerical values (for example, Port Number, Data Channel, etc.), once you key in the maximum number of digits allowed in the highlighted field, the next available field will be highlighted.

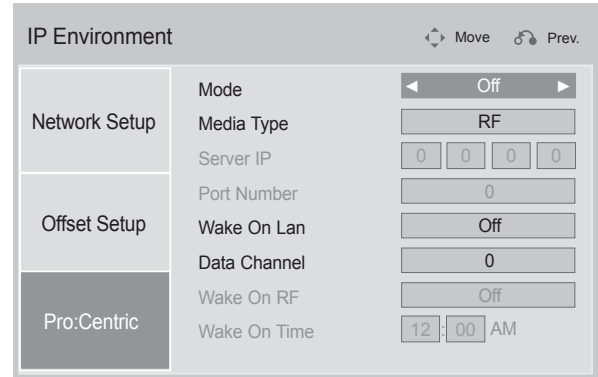

1. To enable/disable Pro:Centric application operation on a TV, use the Left/Right arrow keys on the Installer Remote to select the appropriate setting—**Off**, **FLASH**, or **GEM**—in the Mode field.

Note: If the mode has already been set in the Installer Menu (Installer Menu item 098 PRO:CENTRIC), the specified mode will be reflected in this field. If you change the mode in this menu, Installer Menu item 098 will now reflect the value you entered here.

2. In the Media Type field, use the Left/Right arrow keys to select **IP** or **RF**, as required.

Note: Setting the Media Type to “IP” automatically sets the Data Channel field to “253.” You cannot alter this setting (unless you revert to RF media). It is not possible to direct enter “253” in the Data Channel field.

3. (IP media only) Complete the Server IP and Port Number fields for TV E-Z Installation (splash screen, configuration, and firmware) data. The Server IP must be an IPv4 multicast address within the designated range of 224.0.0.0 to 239.255.255.255.

Either key in or use the Left/Right arrow keys to select the appropriate values in each field. Note that the port number (five digits maximum) must match exactly the port number that has been set in the Pro:Centric RF/IP Configuration display in the Admin Client (refer to the *Pro:Centric™ Server Admin Client User Guide* for further information).

4. In the Wake On LAN field, use the Left/Right arrow keys to select **On** or **Off**, as required. The Wake On LAN feature enables the TV to receive software updates via the LAN while the TV is in standby mode.
5. (RF media only) In the Data Channel field, either key in or use the Left/Right arrow keys to select the RF channel number of the data channel for Pro:Centric or E-Z Installation (splash screen, configuration, or firmware) data. The data channel must be between 0 (disabled) and 135.

The TV may take several minutes to load EPG data after AC power is initially applied.

Note: If the data channel has already been set in the Installer Menu (Installer Menu item 119 DATA CHANNEL), the specified channel will appear in this field. If you change the data channel in this menu, Installer Menu item 119 will now show the value you entered here.

6. (RF media only) In the Wake On RF field, use the Left/Right arrow keys to select **On** or **Off**, as required. The Wake On RF feature enables the TV to receive software updates via RF while the TV is in standby mode. If you set Wake On RF to “On,” specify the appropriate Wake On time in the Wake On Time field. Note that the Wake On time is based on a 12-hour clock. Ensure the AM/PM specification is set accordingly.
7. Once all fields are completed as required, press **MENU** to return to TV viewing, or press **RETURN** to return to the previous menu level.

Remote Jack Pack / TV Connections & Setup

Remote Jack Pack Setup

RJP Available? If you will use a Remote Jack Pack (RJP) in your system, set Installer Menu item **093 RJP AVAILABLE** appropriately (for example, on a legacy model RJP: HDMI Mode, set RJP AVAILABLE to 001). See Installer Menu detailed descriptions for further information.

093 RJP AVAILABLE 001

TV Connections



Make these connections ONLY after Master TV Setup and TV cloning procedures are complete.

Refer to the appropriate figure below, and connect the RJ-45 Control cable from the RJP cable bundle to the RJP INTERFACE port on the TV's jack panel. Then, connect HDMI, RGB, and Composite Video/Audio connectors, as applicable, for the cable bundle.

LD660H/LD665H Jack Panel

HDMI/DVI IN 1
Connect HDMI connector from RJP cable bundle.

RJP INTERFACE
Connect RJ-45 Control cable from RJP cable bundle.

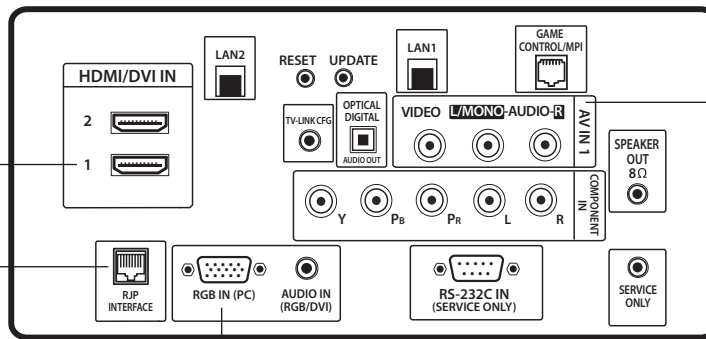

AUDIO/VIDEO IN 1
Connect Composite Video/Audio connectors from RJP cable bundle. (Composite Video on legacy RJP only.)

RGB IN (PC)
Connect RGB connector from RJP cable bundle (legacy RJP only).

LV555H Jack Panel

HDMI/DVI IN 1
Connect HDMI connector from RJP cable bundle.

RJP INTERFACE
Connect RJ-45 Control cable from RJP cable bundle.

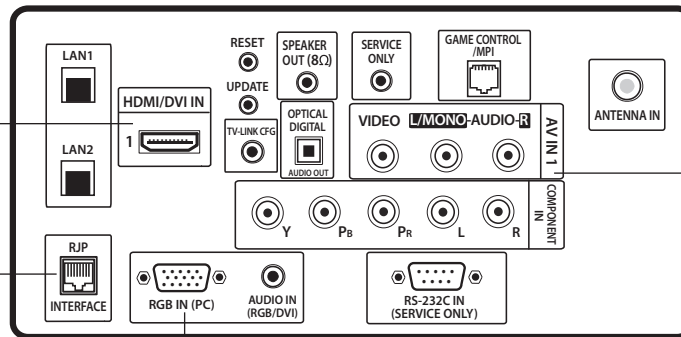

AUDIO/VIDEO IN 1
Connect Composite Video/Audio connectors from RJP cable bundle. (Composite Video on legacy RJP only.)

RGB IN (PC)
Connect RGB connector from RJP cable bundle (legacy RJP only).

Reference: Upgrading TV/PTC Software using a USB Memory Device

Checking the Software Versions

You can check the software versions of the TV by accessing the Installer Menu with the Installer Remote: Press **MENU** repeatedly until the on-screen menu display no longer toggles, and then press **9-8-7-6 + ENTER**.

When you are finished, press **ENTER** again to exit the Installer Menu.

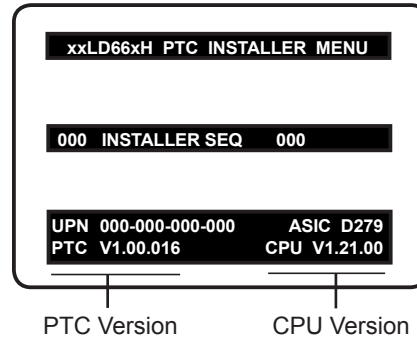

Typical Installer Menu

Upgrading TV/PTC Software

Before you begin, note that the software upgrade files must be stored in a folder named "LG_DTV" in the root directory of the USB memory device. Also, ensure the USB device has been formatted with FAT format.

Note for TV Software Upgrade only: If the TV detects a later version of software on the USB device, it will automatically display a dialog from which you can start the software upgrade immediately. Otherwise, you can close the dialog, and access the USB Download Menu as described below.

1. Turn the TV ON.
2. Plug the USB memory device into the USB IN port on the TV.
3. Press **MENU** on the Installer Remote to display the TV setup menus (TV is in Pass-through Mode) or the Function Menu (TV is not in Pass-through Mode).
4. Use the arrow navigation keys to select/highlight either the **Option** menu icon from the TV setup menus or the **Lock** menu icon from the Function Menu. Then, press the number "7" key a total of seven times to display the USB Download Menu.
5. Use the Up/Down arrow keys to select **Upgrade TV Software** or **Upgrade PTC Software**, as applicable, and press **ENTER**. (See screen samples at right.)
6. Use the Up/Down arrow keys to select the upgrade to install, and then press **ENTER**.

The TV will show update completion progress in a new window. Do NOT remove the USB device until the software upgrade is complete. When a TV software upgrade is complete, the TV will reset itself with an automatic restart. When a PTC upgrade is complete, the TV will turn OFF.

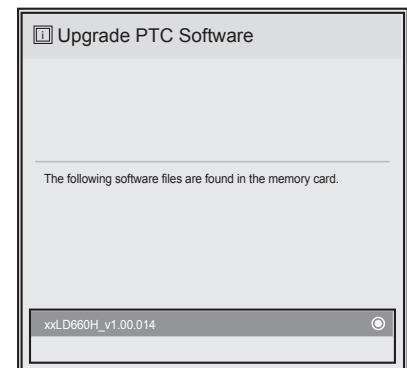
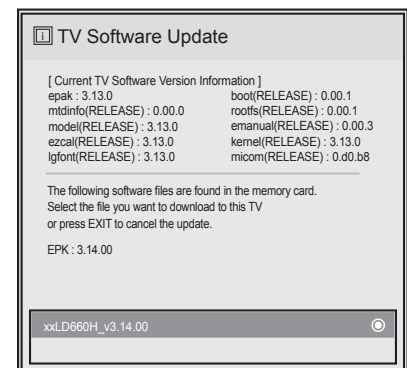
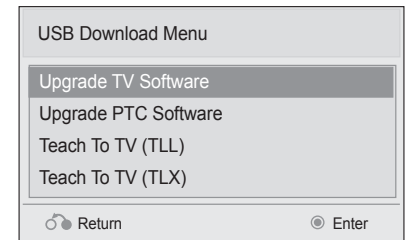

Reference: Downloading a Splash Screen using a USB Memory Device

Splash Screen Image File Guidelines

- The splash screen image must be a 24-bit (RGB 8x8x8) BMP.
- The image should be no larger than 3 MB.
- The ideal resolution for the image is 1366 x 768 pixels or under.
- The image file must be stored in a folder named “LG_DTV” in the root directory of USB memory device.
- Ensure the USB device has been formatted with FAT format.

Downloading a Splash Screen Image

1. Turn the TV ON.
2. Plug the USB memory device into the USB IN port on the TV.
3. Press **MENU** on the Installer Remote to display the TV setup menus (TV is in Pass-through Mode) or the Function Menu (TV is not in Pass-through Mode).
4. Use the arrow navigation keys to select/highlight either the **Option** menu icon from the TV setup menus or the **Lock** menu icon from the Function Menu. Then, press the number “7” key a total of seven times to display the USB Download Menu.
5. Use the Up/Down arrow keys to select **Upgrade TV Software**, and then press **ENTER**.
6. Use the Up/Down arrow keys to select the image file to download, and then press **ENTER**.

The TV will show download completion progress in a new window. Do NOT remove the USB device until the image download is complete. When the image download is complete, the TV will reset itself with an automatic restart. Upon the restart, you should see the new splash screen.

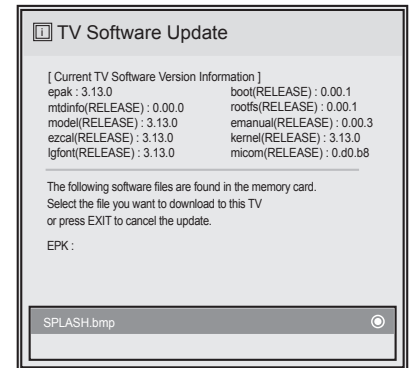
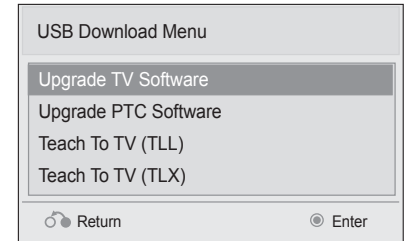

Reference: Power Consumption Settings

32/37/42LD660H & 32/37/42LD665H

The following tables assume that Installer Menu item 118 POWER SAVINGS is set to 3 (default) and Installer Menu item 099 BACK LIGHTING is set as shown below (default value is 202).

Item 099 Back Lighting (Static)	32LD660H / 32LD665H		37LD660H / 37LD665H		42LD660H / 42LD665H	
	Power Consumption (Watts)	Percent Savings	Power Consumption (Watts)	Percent Savings	Power Consumption (Watts)	Percent Savings
100	88.6	0%	100.7	0%	120.5	0%
90	84.1	5%	95.2	5%	113.1	6%
80	79.0	11%	89.1	12%	105.6	12%
70	74.2	16%	83.4	17%	98.2	19%
60	69.4	22%	77.6	23%	90.8	25%
50	64.2	28%	71.3	29%	83.4	31%
40	59.3	33%	65.5	35%	76.2	37%
30	54.6	38%	60.0	40%	69.2	43%
20	49.6	44%	54.0	46%	61.5	49%
10	45.1	49%	48.7	52%	54.8	55%
1	40.4	54%	43.5	57%	48.2	60%

Item 099 Back Lighting (Dynamic)	32LD660H / 32LD665H		37LD660H / 37LD665H		42LD660H / 42LD665H	
	Power Consumption (Watts)	Percent Savings	Power Consumption (Watts)	Percent Savings	Power Consumption (Watts)	Percent Savings
200	53.3	40%	61.3	39%	70.3	42%
190	51.6	42%	59.5	41%	67.6	44%
180	50.5	43%	57.5	43%	65.8	45%
170	48.6	45%	55.6	45%	63.4	47%
160	47.8	46%	53.6	47%	61.1	49%
150	46.6	47%	52.0	48%	59.2	51%
140	45.0	49%	50.2	50%	56.5	53%
130	43.9	50%	47.9	52%	54.1	55%
120	42.3	52%	46.0	54%	51.9	57%
110	41.3	53%	44.5	56%	49.8	59%
101	40.3	55%	43.0	57%	47.9	60%

Note: Values are results of controlled experiments under laboratory conditions.

Reference: Power Consumption Settings (Cont.)

32/37/42/47/55LV555H

Item 099 Back Lighting (Static)	32LV555H		37LV555H		42LV555H		47LV555H		55LV555H	
	Power Consumption (Watts)	Percent Savings	Power Consumption (Watts)	Percent Savings	Power Consumption (Watts)	Percent Savings	Power Consumption (Watts)	Percent Savings	Power Consumption (Watts)	Percent Savings
100	47.6	0%	72.5	0%	105.3	0%	113.1	0%	90.1	0%
90	46.8	2%	69.9	4%	100.3	5%	107.5	5%	87.9	2%
80	46.1	3%	67.0	8%	95.2	10%	101.1	11%	85.7	5%
70	45.4	5%	64.3	11%	90.4	14%	95.7	15%	84.2	7%
60	44.9	6%	61.6	15%	85.7	19%	90.2	20%	82.5	8%
50	43.8	8%	58.8	19%	80.6	23%	84.6	25%	79.4	12%
40	42.7	10%	56.0	23%	75.8	28%	79.2	30%	75.9	16%
30	41.5	13%	53.4	26%	71.1	32%	73.8	35%	72.6	19%
20	40.4	15%	50.6	30%	66.0	37%	68.1	40%	69.5	23%
10	39.4	17%	47.9	34%	61.2	42%	62.8	44%	66.1	27%
1	38.3	20%	45.2	38%	56.5	46%	57.6	49%	62.7	30%

Item 099 Back Lighting (Dynamic)	32LV555H		37LV555H		42LV555H		47LV555H		55LV555H	
	Power Consumption (Watts)	Percent Savings	Power Consumption (Watts)	Percent Savings	Power Consumption (Watts)	Percent Savings	Power Consumption (Watts)	Percent Savings	Power Consumption (Watts)	Percent Savings
200	45.9	4%	53.2	27%	72.5	31%	75.4	33%	85.2	5%
190	45.1	5%	52.4	28%	70.8	33%	73.2	35%	82.3	9%
180	44.3	7%	51.7	29%	69.1	34%	71.4	37%	79.9	11%
170	43.4	9%	50.8	30%	67.4	36%	69.2	39%	77.5	14%
160	42.6	11%	50.2	31%	65.7	38%	67.9	40%	75.1	17%
150	41.9	12%	49.7	31%	64.3	39%	66.0	42%	73.4	19%
140	41.1	14%	48.8	33%	62.0	41%	64.2	43%	71.1	21%
130	40.2	16%	48.1	34%	60.9	42%	62.6	45%	68.7	24%
120	39.4	17%	47.0	35%	59.2	44%	60.4	47%	66.3	26%
110	38.8	18%	46.6	36%	57.9	45%	58.7	48%	64.7	28%
101	38.0	20%	46.0	37%	56.4	46%	57.4	49%	62.6	31%

Note: Values are results of controlled experiments under laboratory conditions.

Reference: TV Camport Auto Sense Operation

The Camport Auto Sense function is enabled when:

1. Installer Menu item 034 CAMPORT EN is set to 1 AND
2. Installer Menu item 040 AUTO CAMPORT is enabled (1).

Selectable: Can be accessed with INPUT key, direct access, etc.

Auto Sense: TV switches to this input when connector is inserted. The Camport (Side [AV IN 2] Video) has the highest priority and will override any commands including tuning to the Start Channel.

CAMPORT (Side Video) Functionality Control

Item 034 CAMPORT EN	Item 040 AUTO CAMPORT	Side (AV IN 2) Video Operation
0	0	Disabled
0	1	Disabled
1	0	Selectable
1	1	Auto Sense

Camport Operation (Pass-through)

When Camport Auto Sense is enabled as above, the TV will switch from its current source to the Side (AV IN 2) Video input whenever a plug is inserted into the AV IN 2 Video input.

When the video plug is removed, the TV will switch back to the previous source that was being displayed before the plug was inserted. However, if any direct access to an Aux channel or RF channel is requested while the Camport is active, then, when the video plug is removed, the TV will switch to the last requested channel. Source changes using any Source keys (INPUT) are ignored. Channel Up/Down and Flashback commands are not Direct Access tuning commands, and they are also ignored.

Previous State Before Inserting CAMPORT	Operation While CAMPORT is Active	State Upon Removal of CAMPORT
Aux or RF Channel	None	Previous Aux or RF Channel
Aux or RF Channel	Direct Access	Last Requested Aux or RF Channel
Aux or RF Channel	Ch Up/Down, Flashback, and Input Keys	Previous Aux or RF Channel

Camport Operation (FTG or PPV)

The operation will be similar to that of the Pass-through Mode. However, when the Channel Map is maintained external to the PTC (i.e., FTG and PPV), Channel Up/Down or Flashback keys are sent as Direct Access tuning commands to the PTC/TV.

Previous State Before Inserting CAMPORT	Operation While CAMPORT is Active	State Upon Removal of CAMPORT
Aux or RF Channel	None	Previous Aux or RF Channel
Aux or RF Channel	Direct Access	Last Requested Aux or RF Channel
Aux or RF Channel	Ch Up/Down, Flashback, and Input Keys	Last Requested Aux or RF Channel

Reference: TV Aux Input Configuration

DIRECT ACCESS Tuning		TV		ENABLE				MPI DATA			START AUX SOURCE ASSIGNMENT
				Installer Menu		MPI DATA STATUS TYPE 0x41 SOURCES ENABLED (R/W)		DATA STATUS TYPE 0xD2 CURRENT AV SOURCE (R)		DATA STATUS TYPE 0x0D AUX SOURCE (R)	
OLD_OCV = 0	OLD_OCV = 1	Source Input	Source Mode	Number	Labeling	Value	Labeling	Value	Labeling		
130	90	Video2 (Side)	CV/SVIDEO	34	CAMPOR_T_EN	0x01	Video Front (Campor)	0	Video Front (Campor)	0 (VIDEO)	2
131	91	Video1 (Rear)	CV/SVIDEO	39	REAR_AUX_EN	0x02	Rear Video (Aux)	1	Rear Video (Aux)	0 (VIDEO)	1
132	92	HDMI2	DTV/PC	91	YPrPb2 EN = 1	0x04	S-Video Rear	2	S-Video Rear	0 (VIDEO)	5
133	93	HDMI1/DVI	DTV/PC	35	COMPPOR_T_EN = 1	0x08	Front Computer	3	Front Computer	0 (VIDEO)	3
134	94	RGB	PC	87	REAR RGB EN = 2	0x10	SVGA Rear Computer	4	SVGA Rear Computer	2 (COMPUTER)	4
136	96	Component		38	YPrPb EN	0x40	Y/UV Component	6	Rear Y/PrPb Component Video	0 (VIDEO)	6

Reference: *b*-LAN Setup & Overview

The *b*-LAN module is internal to the TV. It allows hotel/institution head end equipment with *b*-LAN technology to communicate, via the institution's RF distribution system, with the TV for configuration and control.

Note: MPI cards with *b*-LAN technology—LMT7Z5, LMT7Z7, LMT7Z9—are NOT supported in TVs in which *b*-LAN technology is already integrated.

Installer Menu item 118 POWER SAVINGS controls the power circuitry for both the embedded *b*-LAN module and the GAME CONTROL/MPI port. The default value is 003—the *b*-LAN module as well as the GAME CONTROL/MPI port circuitry is only powered when the TV is turned ON. See chart below.

POWER SAVINGS	TV Standby State	TV Power On State
	<i>b</i> -LAN & GAME CONTROL/MPI Port Power	<i>b</i> -LAN & GAME CONTROL/MPI Port Power
001	On	On
003 (default)	Off	On

A *b*-LAN enabled head end device, such as an LG FMA-LG101, broadcasts over the RF distribution system to communicate to multiple TVs. When the TV is first installed, it must be turned ON in order for its embedded *b*-LAN module to receive communication from the head end device. At this point, if it is desired for the *b*-LAN module to always be powered, including while the TV is in Standby, set Installer Menu item 118 POWER SAVINGS to 001.

Also, if MPI communication is required for external MPI control, set Installer Menu item 118 POWER SAVINGS to 001 so that the GAME CONTROL/MPI port circuitry is always powered.

Reference: RJP Model List and Input Auto-sensing Hierarchy

RJP Model List

Legacy Models	Scaler Models
RJP-101M	RJP-201M
RJP-101ML	N/A
RJP-110F	RJP-210F
RJP-110FW	RJP-210FW
RJP-110W	RJP-210W
RJP-110WBR	RJP-210WBR
RJP-110S	RJP-210S
RJP-120G	RJP-220G
RJP-120T	RJP-220T
RJP-201B	RJP-301B
RJP-202B	RJP-302B

RJP Input Auto-sensing Hierarchy

Priority	Video	Audio
1st (Highest)	Digital Video In	Audio In (3.5mm)
2nd	PC Video In	Audio In (L/R)
3rd	Video In	Digital Video In

Reference: Resetting Factory Defaults on the TV(s)

This section describes how to reset factory defaults either on a single TV that is currently in Pass-through or FTG Mode or on multiple TVs that are currently in FTG Mode.

Note: If the TV(s) is/are currently in FTG Mode, restoring the factory defaults also resets the TV to Pass-through Mode.

Installer Menu Item 117 FACT DEFAULT

If the TV is currently in Pass-through Mode, you can set Installer Menu item 117 FACT DEFAULT to 001 to reload the factory defaults and clear the channel lineup, including any assigned channel icons and custom text labels.

Factory “IN-STOP”

If the TV is currently in FTG Mode, a predefined value for Installer Menu item 117 FACT DEFAULT enables access to initiate a factory “IN-STOP” process that will reset the TV to Pass-through Mode in addition to restoring all factory defaults. Contact technical support for the required value for Installer Menu item 117 and for additional information on performing the IN-STOP from the Installer Menu.

Additional FTG Mode via CPU Options

There are two additional options for resetting Pass-through Mode/factory defaults on TVs that are in FTG Mode via the CPU. The first enables you to reset a single TV to Pass-through Mode, while the second enables you to reset multiple TVs to Pass-through Mode at one time.

- Using a USB memory device, “Teach” an FTG Configuration (.tlx) file that only contains a “0 Mapped Channels” FTG Channel Map to the TV. Refer to “Creating an FTG Configuration File using the FTG File Manager” and “Teaching FTG Configuration to a TV” on pages 35 to 37, respectively, for further information.
- If your system uses a Pro:Centric server for remote management/administration, use the Pro:Centric Admin Client to load an FTG Configuration (.tlx) file that only contains a “0 Mapped Channels” FTG Channel Map on the Pro:Centric server. Refer to the **Pro:Centric™ Server Admin Client User Guide** for further information.

Additional FTG Mode via EBL Options

There are two additional options for resetting Pass-through Mode/factory defaults on TVs that are in FTG Mode via the EBL. The first enables you to reset a single TV to Pass-through Mode, while the second enables you to reset multiple TVs to Pass-through Mode at one time.



Note: While the IN-STOP process described above will clear both the PTC and the CPU, both options below only clear the PTC. Thus, the current Channel Map and TV setup menu settings will remain in the CPU after the reset is completed.

- Using a direct PC-to-TV connection, “Write” an unpopulated Channel Map—that is, a Channel Map with zero channels—to the TV. Refer to the “FTG Mode via EBL” procedure on page 40 and/or the **Free-To-Guest (FTG) Configuration Application** manual for further information.
- If your system uses an FMA for remote management/broadcast configuration, configure the FMA device with an FMA Configuration file that only contains a “0 Mapped Channels” FTG Channel Map to broadcast to the TV EBL(s). Refer to the **Free-To-Guest (FTG) Configuration Application** manual and/or the Installation & Setup manual for the FMA device for further information.

Reference: TV Zone Restrictions

The FTG Channel Map Editor in the FTG File Manager's FTG Channel Map Configuration Utility enables you to assign Zone restrictions to channels that may be deemed unsuitable for certain locations, for example, a hotel lobby. In the FTG Channel Map Editor, a Zone # (for example, "1") must be designated for each channel that is to be restricted.

On location, set the Zone # for all the TVs in a select area, or "Zone" (for example, the lobby) so that the TVs can omit channels that have been restricted in the FTG Channel Map. However, note that while a channel can be restricted from up to eight Zones, a TV can only ever be in (set for) one Zone. TV Zone 0 is the default TV Zone #. When the TV Zone is 0, the TV will ignore any restriction that may be placed on channels in the FTG Channel Map.

See the FTG Channel Map Editor overview on page 43. Also, see the *Free-To-Guest (FTG) File Manager User Guide* for more detailed information on assigning Zone restrictions.

Use the following procedure to specify a Zone designation for a TV.

1. Press **MENU** on the Installer Remote, and use the arrow navigation keys to select/highlight the **OPTION** menu option. Then, press **ENTER**.
2. Use the Up/Down arrows to select **Zone**, and then press **ENTER**.
3. In the Zone pop-up window, use the Left/Right arrows to select the appropriate Zone number. Then, press **ENTER**.
4. Press **MENU** to return to TV viewing, or press **RETURN** to return to the previous menu level.

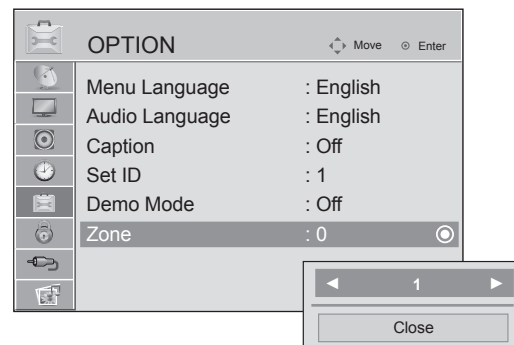

Reference: LD660H/LD665H Rear Jack Panel

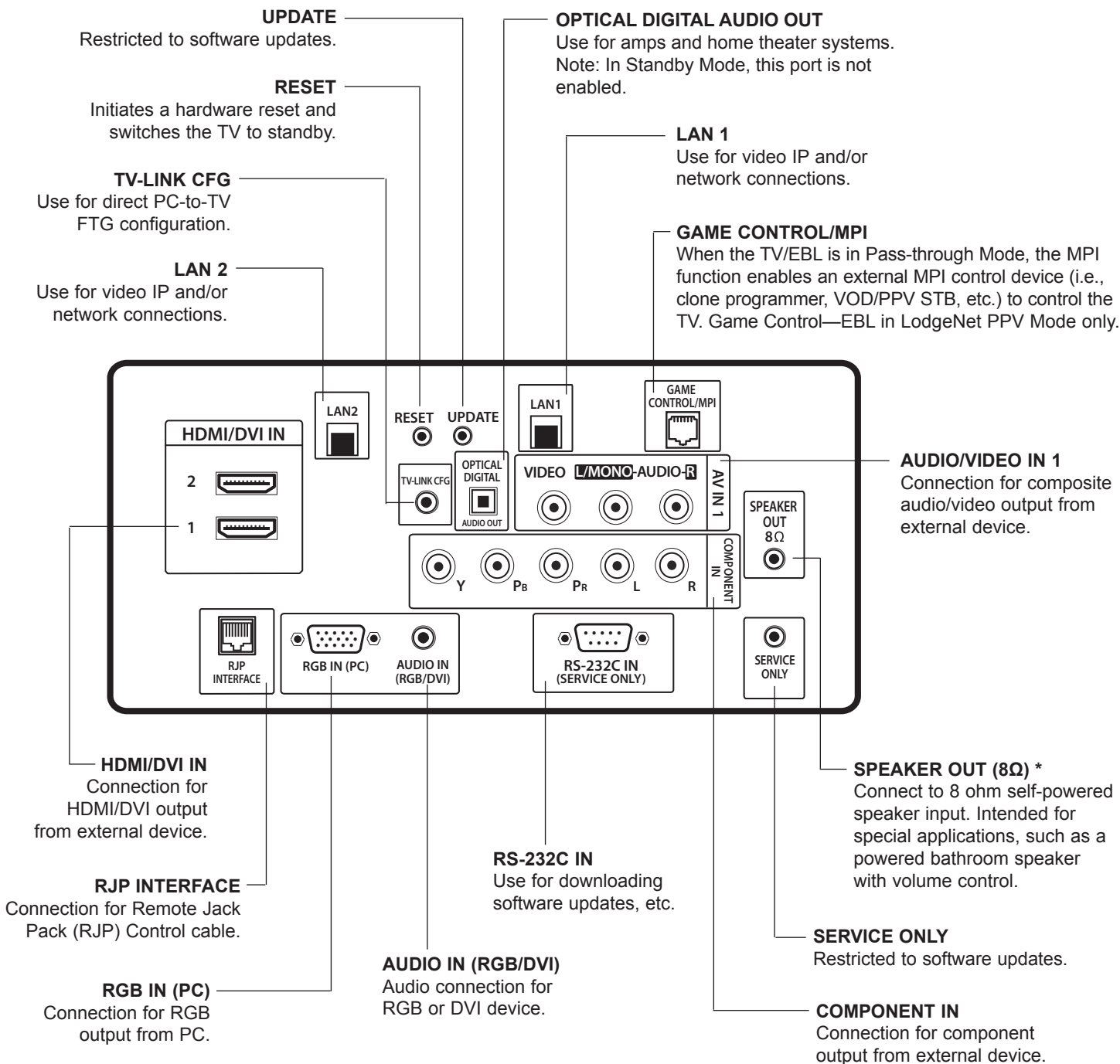

* This stereo jack provides a mono speaker fixed-level, 1 watt output (audio +, audio -, w/ground shield). Do NOT plug in a mono connector, as this may damage the TV.

Reference: LV555H Rear Jack Panel

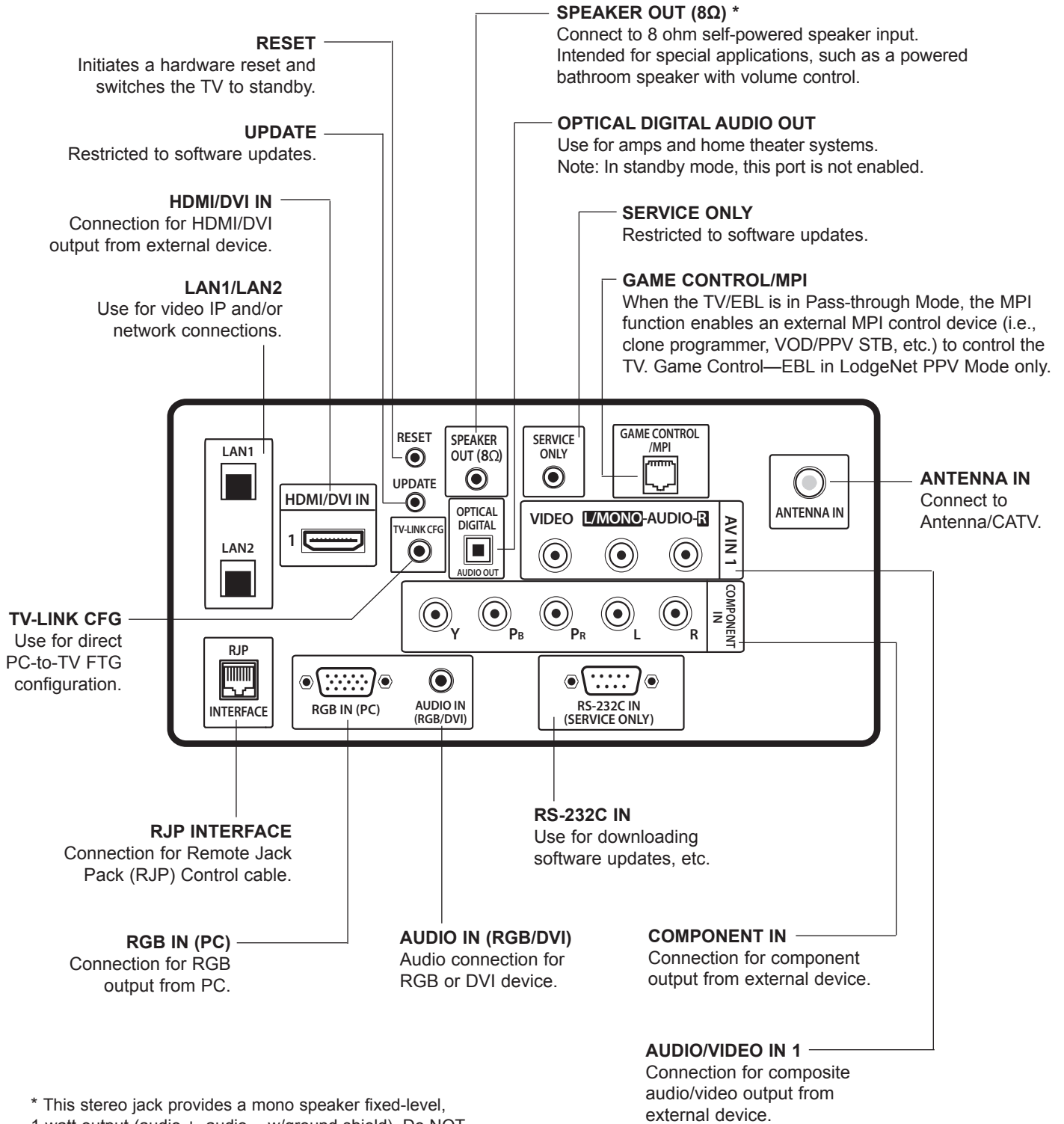

* This stereo jack provides a mono speaker fixed-level, 1 watt output (audio +, audio -, w/ground shield). Do NOT plug in a mono connector, as this may damage the TV.

Reference: Side Connections Panel

LD660H/LD665H TVs

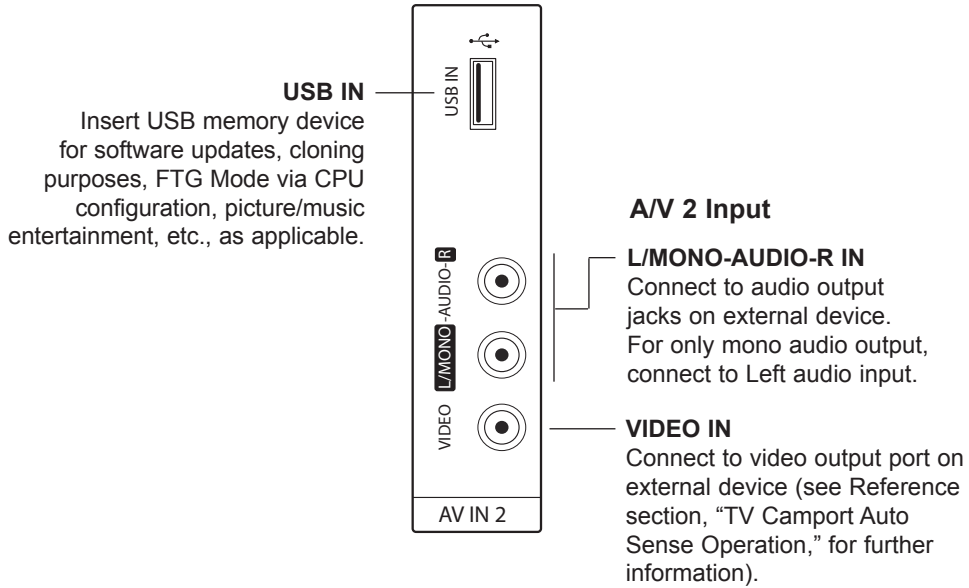

LV555H TVs

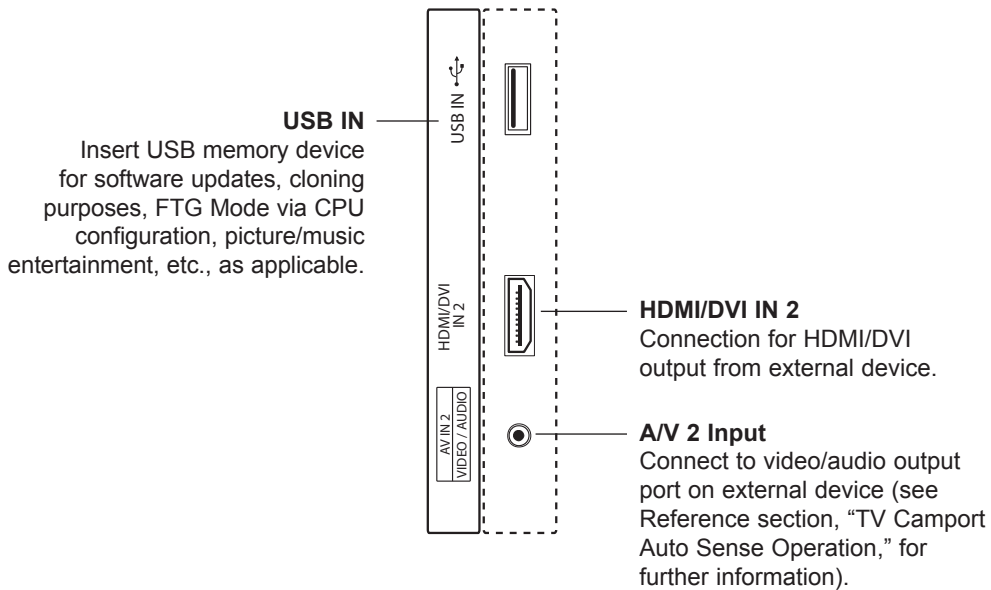

LD660H/LD665H TVs only

Note: The Antenna connection for LV555H TVs is located on the rear jack panel (see page 59).

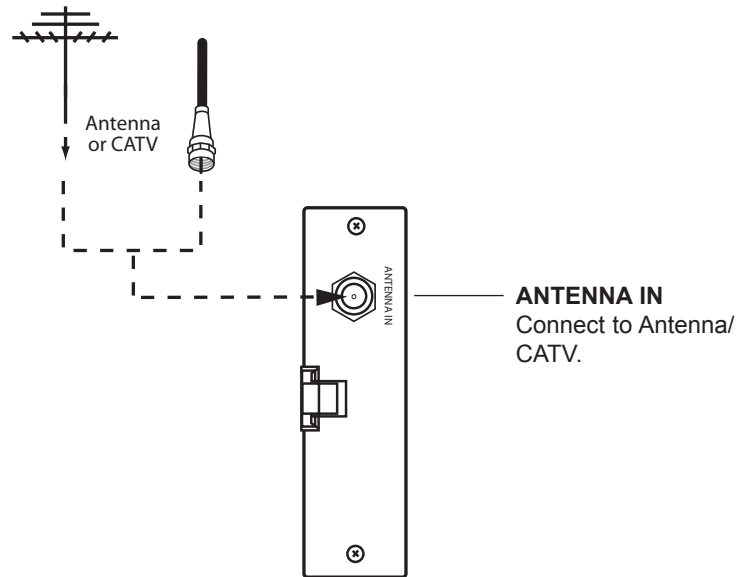

Troubleshooting

General Troubleshooting

Some Quick and Easy Tips for Resolving Problems

Symptom	Possible Cause(s)	Possible Solution(s)
Installation		
Cannot direct enter channel number.	(TV in Pass-through Mode) Installer Menu item 028 CH. OVERRIDE is set to 0, i.e., disabled (recommended setting).	If Installer Menu item 028 CH. OVERRIDE is set to 0, only channels that are active in the TV's channel lineup can be selected. Set CH. OVERRIDE to 1 to allow access for direct keypad entry to all channels.
	(TV in FTG Mode) The channel entered is not part of the FTG Channel Map.	Channel access is restricted to channels included in the FTG Channel Map. If necessary, make changes to the FTG Channel Map using the FTG File Manager or the FTG Device Configuration Application, as appropriate.

Power

No power.	See troubleshooting flow chart on following page.
-----------	---

Display Panel Picture

No picture.	Display panel is turned OFF.	<ul style="list-style-type: none"> • Turn TV ON. • Power failure?
	Antenna/cable not connected.	Connect antenna/cable signal to TV.
	Connections incorrect.	Check connections on TV.
	MPI not connected.	If applicable, connect MPI cable to MPI device.
	Encrypted program.	Try another channel.
	Wrong tuning band.	Adjust Installer Menu settings.

Erratic Operation

Installer Menu setup.	Wrong Installer Menu settings.	Adjust Installer Menu settings as required.
-----------------------	--------------------------------	---

Installer Remote

Remote doesn't work.	Remote not in TV Mode.	Use MODE key to select "TV"; puts remote into TV Mode.
	Not aimed at IR remote sensor.	Point remote at IR receiver on TV.
	Remote too far from IR sensor.	Move remote closer to IR receiver on TV or darken room.
	MPI not connected.	If applicable, connect MPI cable to MPI device.
	IR path to TV's receiver obstructed.	Remove obstructions.
	Weak batteries.	Replace batteries.
	Wrong battery polarity.	Check that "+" and "-" match in battery compartment.
	Too much light in room.	Dim room light.
	Wrong Installer Remote.	Requires compatible Installer Remote. Contact your LG dealer.

Picture Reception

Normal picture, poor or no sound.	Audio muted.	Press MUTE or use Volume Up key to increase sound level.
	Broadcast problem.	Try a different channel.

Note: For other problems not caused by the TV, refer to the other devices' operating guide(s).

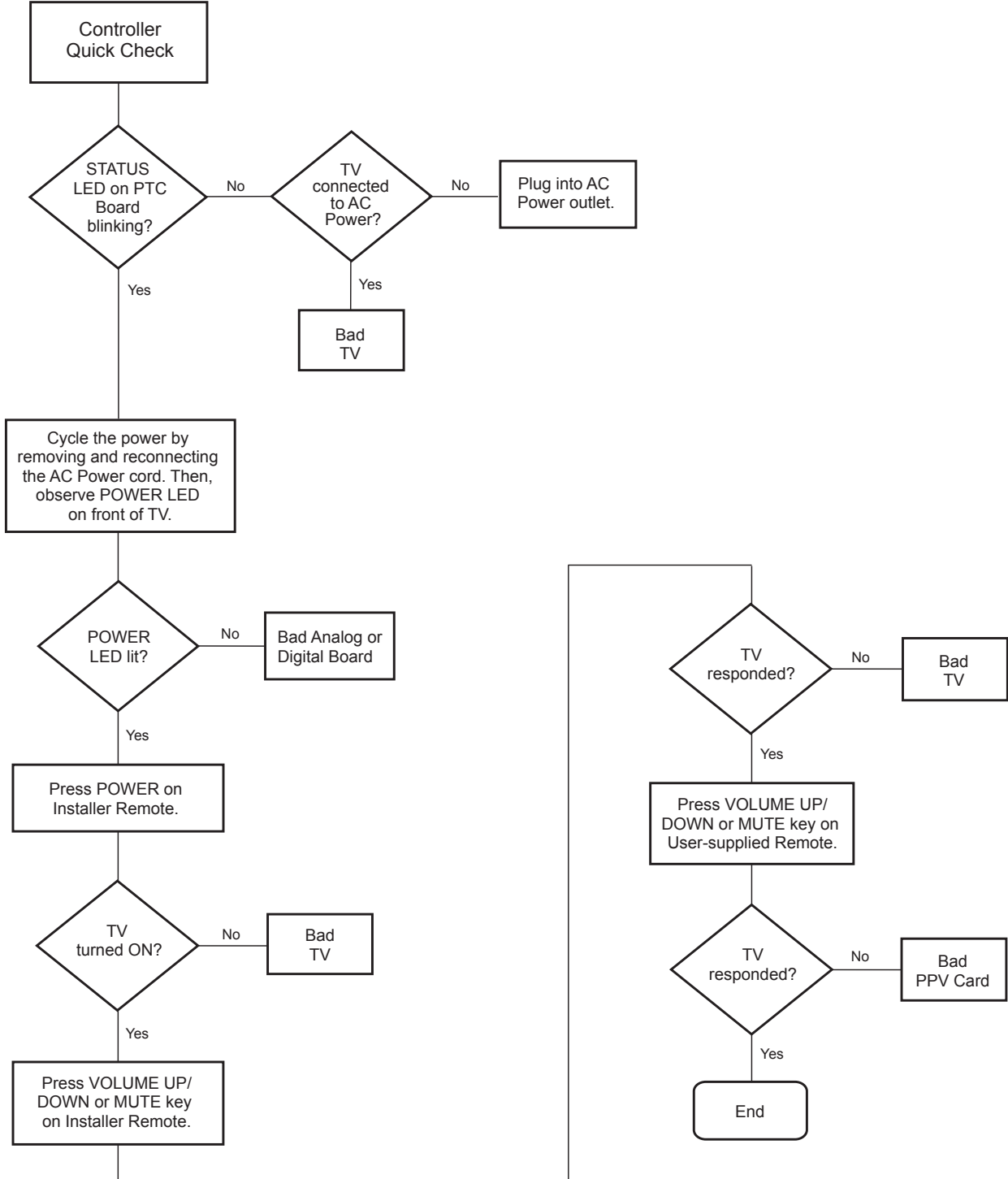

Troubleshooting (Cont.)

Commercial Mode Check / FTG Operation Troubleshooting

Commercial Mode Check

Use this flowchart to determine whether the TV is currently in Commercial Mode.

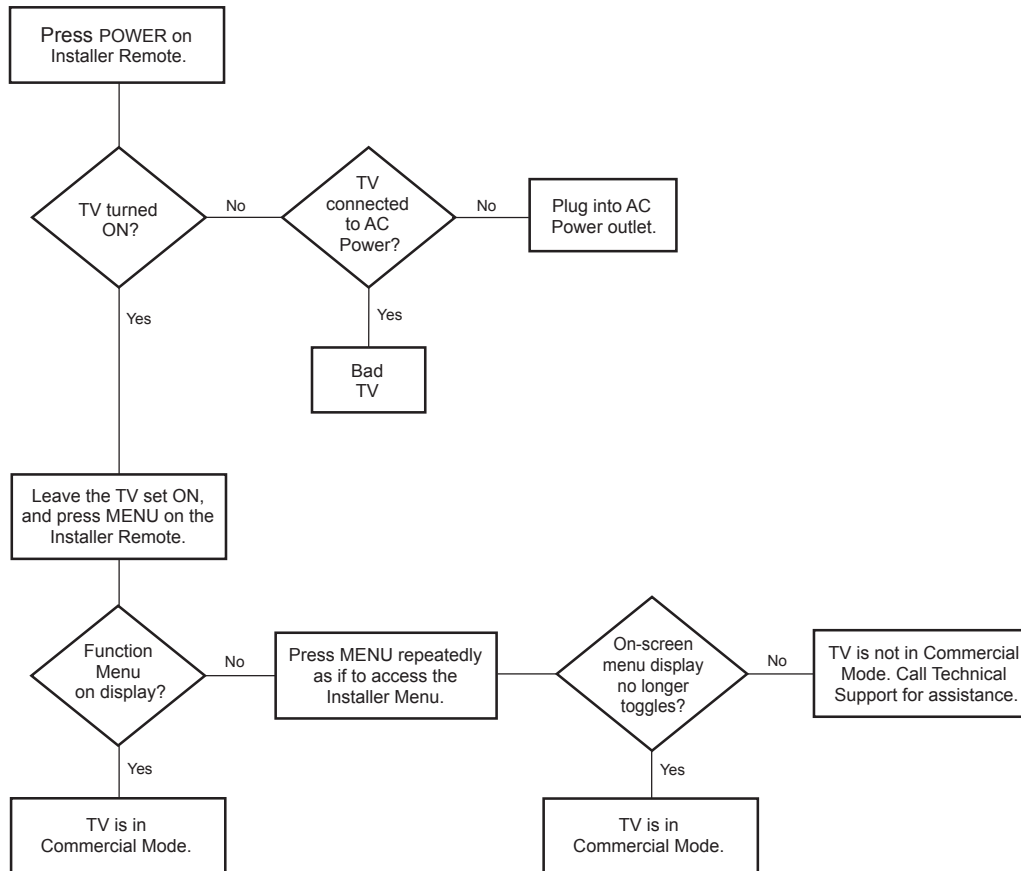

FTG Operation Troubleshooting

The following table provides troubleshooting information for when the EBL is configured in the FTG Mode of operation.

Symptom	Possible Cause(s)	Solution(s)
Communication Error ("Communications Timeout")	Cable(s) not connected. TV not powered. TV not turned ON. Wrong COM (communication) port.	Check and connect communication cables. Check/connect the TV power cord. TV needs to be turned ON (default FTG Mode). In the FTG Device Configuration Application, select the correct COM port for the cable being used.

Clone Programmer Troubleshooting



Caution: Do not connect a clone programmer to a PPV card installed in the Master or Target TVs. Also, if the TV is in LodgeNet PPV Mode (check with the site administrator if you are not certain), do not connect a clone programmer to the GAME CONTROL/MPI port. Either of these actions will damage the clone programmer and, if applicable, the PPV card.

Reset Clone Programmer After Static Shock

After replacing exhausted batteries (LT2002 only), or if the clone programmer behaves strangely after a static shock:

- TLL-1100A: Turn the TLL-1100A OFF and then ON.
- LT2002: Use a paper clip or similar instrument inserted through the small hole marked RESET to activate the internal reset switch and restore normal operation.

After a reset, check the real-time clock setting. It may be necessary to set the clone programmer clock from a TV containing the correct time.

Note: Both the Master and Target TVs must be in Pass-through Mode for cloning purposes. See also IMPORTANT CLONING INFORMATION on page 24.

Clone Programmer

Symptom	Possible Cause(s)	Possible Solution(s)
Clone copies setup in less than 30 seconds.	Not enough time to copy entire TV setup.	TLL-1100A: Turn the TLL-1100A OFF and then ON. LT2002: Press RESET on clone programmer. Then redo Learn/Teach. (Learning usually takes about 90 seconds; Teaching usually takes 3 to 4 minutes.)
Remote does not operate clone programmer.	Wrong Installer Remote.	Only use an LG Installer Remote to operate clone programmer with TV.
Clone menu does not display on TV screen, TLL-1100A shows error message, or LT2002 LED does not blink.	MPI cord not connected.	Connect MPI cord properly, and ensure good connection.
	TV not turned ON.	TV must be powered ON for clone programmer to work.
	(LT2002 only) Weak batteries.	Install four (4) fresh AA high-quality alkaline batteries.
	(TLL-1100A only) No charge.	Ensure the TLL-1100A is fully charged or connected to AC power.
Clone menu hard to read.	Weak signal.	Connect TV to a reliable analog channel signal source.
No time set.	Time not available.	Set time on a TV, and copy time to clone programmer.
Clone not working.	Clone programmer problem.	<ul style="list-style-type: none"> • Try a different clone programmer. • Reset the clone programmer.
Clone scans channels more than once.	Clone should only scan channels once.	Ensure TV is set up correctly, and try cloning again.

Master and Target TVs

Symptom	Possible Cause(s)	Possible Solution(s)
Cloning did not work.	Procedure interrupted.	Wait until procedure complete message is displayed.
	Different TV models.	Cloning is only possible with identical model TVs.
	Step(s) omitted or not performed.	Refer to the applicable cloning procedure(s), and make sure all tasks were performed.
(LT2002 only) Clone time disappeared.	Batteries were removed.	Batteries must remain installed to retain time settings.
New setup not present.	Target TV not reset.	Disconnect Target TV from AC power for 15 seconds.

- After cloning operations are complete, unplug the TLL-1100A/LT2002 from the TV.
- If the TV does not display a picture (blank screen) after a few seconds, just change channels.

Glossary of Terms

A list of definitions for some of the words found in this guide.

75 OHM RF CABLE

The wire that comes from an off-air antenna or cable service provider. The end looks like a hex-shaped nut with a wire through the middle. It screws onto the Antenna/Cable threaded jack on the back of the TV.

300 TO 75 OHM ADAPTER

A small device that connects a 2-wire 300 ohm antenna to a 75 ohm RF jack. It is usually about an inch long with two screws on one end and a round opening with a wire extending out the other end.

A/V CABLES

Audio/Video cables. Three cables bunched together—right audio (red), left audio (white), and video (yellow). A/V cables are used for stereo playback of videocassettes and for higher quality picture and sound from other A/V devices.

A/V DEVICE

Any device that produces video or sound (VCR, DVD, cable box, or television).

AMPLIFIER

An electronic device that amplifies sound from a television, CD player, VCR, DVD player, or other audio/video device.

ANTENNA

The physical receiver of television signals sent over the air. A large metal piece of equipment does not always have to be visible to be using an antenna.

b-LAN

LodgeNet Interactive Corporation proprietary RF communication system used to configure/control TV via RF distribution system.

CABLE

Cable service box. Refers to the descrambler box cable subscribers use to receive cable programming signals.

CATV

Programming provided by a cable service.

COMPONENT VIDEO

Uses three wires for transporting three-color video signals. The end result is usually better video quality.

COMPOSITE VIDEO

Typical video jack, uses one wire for transporting three-color video signals.

DELETE

Lets you remove channels from the list that the end user can scroll through using Channel Up/Down.

DIGITAL TELEVISION

High-resolution, cinema-quality television signals transmitted digitally.

DVI

Digital Video Interface. Accommodates analog and digital interfaces with a single connector.

HDMI

High-definition multi-media interface.

HDSTB

High-definition set top box. Refers to a tuner device that receives high-definition television signals which have higher resolution than ordinary analog TV signals.

HDTV

High-definition television. Refers to television signals that have higher resolution than ordinary analog TV signals.

INPUT

Refers to the input jack that receives a signal from a TV, VCR, DVD player, or other audio/video device.

JACK

An input or output connector on the back of a TV, VCR, DVD player, or other audio/video device.

MONO SOUND

Mono (monaural) sound is one channel of sound. On more than one speaker, all the speakers play the same audio.

OUTPUT

Refers to the output jack that sends a signal out of a VCR, DVD player, or other audio/video device.

PHYSICAL CHANNEL NUMBER

The actual channel number. Analog channels use the Physical Channel number and digital channels can use a Virtual Channel number.

RGB (RED, GREEN, BLUE)

Connection input or output port available for producing a video image using three separate colors: Red, Green, and Blue.

RS-232

Serial communication port through which firmware is downloaded.

2ND AUDIO PROGRAMMING/SAP

Second Audio Programming (SAP) is another, separate audio channel available with some programming. Choosing SAP often refers to listening to audio in another language, such as Spanish or French.

SIGNAL

Picture and sound traveling through a cable, or over the air, to the TV.

STEREO SOUND

Stereo (Stereophonic) sound refers to audio that's divided into right and left sides.

TUNER

Device that picks up the broadcast signal and turns it into picture and sound.

VIRTUAL CHANNEL NUMBER

A re-mapped channel number. Analog channels use the Physical Channel number; however digital channels use a Virtual (or false) Channel number.

XDS

Extended Data Service. Additional program information included on the signal provided at the discretion of the broadcaster.

Note: Refer to www.atsc.org for further information.

Document Revision History

Date	Description
October 2011	Revision A: New document
November 2011	Draft B.2: SI/MPI communication updates

Product documentation is available online at: www.LGolutions.com/products. From the Products page, select **TVs, Systems & Solutions**, then **LCD TVs**, then the applicable TV. Click the **Literature & Downloads** tab at the bottom of the TV page, and select the required document(s) from the Downloads list.

Notes



For Customer Support/Service, please call:

1-888-865-3026

www.LGsolutions.com

Pro:Idiom is a registered trademark of Zenith Electronics LLC. Pro:Centric is a trademark of LG Electronics U.S.A., Inc. b-LAN is a trademark of LodgeNet Interactive Corporation. All other trademarks or registered trademarks are the property of their respective owners.