



ENGLISH

OWNER'S MANUAL CAR CD/MP3/WMA Receiver

Please read this manual carefully before operating your set and retain it for future reference.

LCS510IR/LCS510UR/LCF610IR



MFL67409338

Safety Information



CAUTION: TO REDUCE THE RISK OF ELECTRIC SHOCK DO NOT REMOVE COVER (OR BACK) NO USER-SERVICEABLE PARTS INSIDE REFER SERVICING TO QUALIFIED SERVICE PERSONNEL.



This lightning flash with arrowhead symbol within an equilateral triangle is intended to alert the user to the presence of uninsulated dangerous voltage within the product's enclosure that may be of sufficient magnitude to constitute a risk of electric shock to persons.



The exclamation point within an equilateral triangle is intended to alert the user to the presence of important operating and maintenance (servicing) instructions in the literature accompanying the product.

WARNING: TO PREVENT FIRE OR ELECTRIC SHOCK HAZARD, DO NOT EXPOSE THIS PRODUCT TO RAIN OR MOISTURE.

WARNING: Do not install this equipment in a confined space such as a book case or similar unit.



Always operate the vehicle in a safe manner. Do not become distracted by the vehicle while driving, and always be fully aware of all driving condition. Do not change settings, or any functions. Pull over in a safe and legal manner before attempting such operations.



Do not use for many hours at extremely low or high temperature. (-10 °C to 60 °C)



To reduce the risk of electric shock, do not remove the cover or back of this product. There are no user-serviceable parts inside. Refer servicing to qualified service personnel.



To reduce the risk of fire or electric shock, do not expose this product to dripping or splashing water, rain, or moisture.



The temperature of unit's outside can be extremely high, please use the unit after proper installation in your vehicle.

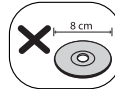

This unit cannot play 8cm disc (use 12cm disc only).



While driving, keep the sound volume at a proper level.



Do not drop it and avoid heavy impacts at anytime.



This unit is for vehicles with a 12-volt battery and negative grounding. Before installing it in a recreational vehicle, lorry or bus, check the battery voltage. To avoid shorts in the electrical system, be sure to disconnect the E battery cable before beginning the installation.

CAUTION: This product employs a Laser System. To ensure proper use of this product, please read this owner's manual carefully and retain it for future reference. Shall the unit require maintenance, contact an authorized service centre.

Use of controls, adjustments or the performance of procedures other than those specified herein may result in hazardous radiation exposure.

To prevent direct exposure to laser beam, do not try to open the enclosure. Visible laser radiation when open. **DO NOT STARE INTO BEAM.**

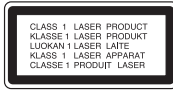

"This device is equipped with a portable battery or accumulator.

Safe way to remove the battery or the battery from the equipment:

Remove the old battery or battery pack, follow the steps in reverse order than the assembly. To prevent contamination of the environment and bring on possible threat to human and animal health, the old battery or the battery put it in the appropriate container at designated collection points. Do not dispose of batteries or battery together with other waste. It is recommended that you use local, free reimbursement systems batteries and accumulators."

The battery shall not be exposed to excessive heat such as sunshine, fire or the like.

You have to set the disc format option to [Mastered] in order to make the discs compatible with the LG players when formatting rewritable discs. When setting the option to Live File System, you cannot use it on LG players.

(Mastered/Live File System : Disc format system for Windows Vista)



Caution

When being connected in a wrong way, the unit displays as follows.

- Antenna / Remote port short : "EXTERNAL ON PORT SHORT CIRCUIT CHECK"

After connecting it again, restart the unit.

Disposal of your old appliance



1. When this crossed-out wheeled bin symbol is attached to a product it means the product is covered by the European Directive 2002/96/EC.
2. All electrical and electronic products shall be disposed of separately from the municipal waste stream via designated collection facilities appointed by the government or the local authorities.
3. The correct disposal of your old appliance will help prevent potential negative consequences for the environment and human health.
4. For more detailed information about disposal of your old appliance, please contact your city office, waste disposal service or the shop where you purchased the product.



LG Electronics hereby declares that this/ these product(s) is/are in compliance with the essential requirements and other relevant provisions of Directive 2006/95/EC and ECE Regulation 10.03 (3.2.9).

European representative :

LG Electronics Service Europe B.V.
Veluwezoom 15, 1327 AE Almere, The Netherlands

(Tel : +31-(0)36-547-8888)

The unit is compatible with the steering wheel remote control. The function allows operation by sending the steering wheel remote control signal to the unit.

For details, consult with your dealer.

Table of Contents

1

1 Getting Started

- 2 Safety Information
- 5 Front panel [LCS510IR/ LCS510UR]
- 6 Front panel [LCF610IR]
- 7 Remote control
- 7 – Battery Installation

3

2 Connecting

- 8 About detachable control panel [LCS510IR/LCS510UR]
 - 8 – Attaching the control panel
 - 8 – Detaching the control panel
- 9 About detachable control panel [LCF610IR]
 - 9 – Attaching the control panel
 - 9 – Detaching the control panel
- 10 Installation
 - 10 – Basic Installation
 - 10 – Removing the existing receiver unit
 - 10 – ISO-DIN Installation
- 11 Connection
 - 11 – Connecting to a car

4

3 Operating

- 12 Operation
 - 12 – Basic operations
 - 12 – Turning off the sound temporarily
 - 12 – Using EQ (Equalizer)
 - 12 – Checking the clock
 - 12 – Turning off the display light
 - 12 – Resetting the unit
- 13 – Adjusting the general settings
- 14 Listening to a CD
 - 14 – Pausing or restarting CD playback
 - 14 – Searching for a section within a track/ file
 - 15 – Skipping to another track/ file
 - 15 – Checking information about your music

- 15 – Playing back tracks/ files in a way you want
- 16 Listening to music from an external device
 - 16 – Preventing radical changes in volume as switching sources
- 17 Listening to the radio
 - 17 – Storing desired frequencies manually
 - 17 – Listening to a preset station
 - 18 – Adjusting TUNER settings
- 19 Using an USB device
 - 19 – Moving to another drive
 - 19 – Quick Search of a desired file
 - 19 – Playable USB device Requirement
 - 19 – Recording to USB from CD or FM tuner
- 20 Listening to music by connecting iPod/ iPhone [LCS510IR/LCF610IR]
 - 20 – Pausing or restarting playback
 - 20 – Searching for a section within a track/ file
 - 20 – Checking information about your music
 - 20 – Playing back tracks/ files in a way you want
- 21 – Playing back files by music menus
- 21 – Compatible iPod models

4 Trouble shooting

- 22 Troubleshooting

5 Appendix

- 23 Specifications

Front panel [LCS510IR/ LCS510UR]

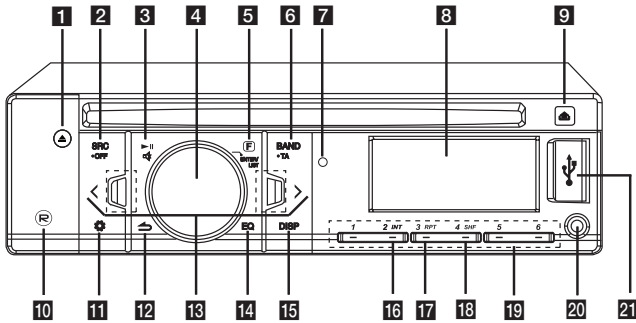

1

Ejects a disc.

2 SRC/ • OFF

- When pressed, selects function sources.
- When pressed and held, powers unit on or off.

3

Plays and pauses playback.



Temporarily stops the sound.

4 Volume knob

- Adjusts volume level.
- Confirms the settings.
- Checks tracks, files or preset stations.

5 **F**

In each mode, sets playback items.

6 BAND

Selects a band in Tuner mode.

• TA (Optional)

Searches stations that have TA/ TP information, when it is pressed and held.

7 Remote Sensor

8 Display window

9

Opens the front panel.

10

Recording to USB.

11

Activates setting menu.

12

Returns to the previous step.

13

Skip/ Search/ Seek/ Tune

14 EQ

Improves sound quality.

- When pressed, selects the EQ function.
- When pressed and held, adjusts the sound level.

15 DISP

- Press it, you can check the clock time.
- Press and hold it, you can turn on/off the display window and the light of LED buttons.

16 INT

Intro scan

17 RPT

Repeats playback

18 SHF

Randoms playback

19 Numeric buttons (1 - 6)

Selects a numbered preset station in TUNER.

20 AUX

If connected to other portable player, you can enjoy musics from it on the unit.

21 USB port

Front panel [LCF610IR]

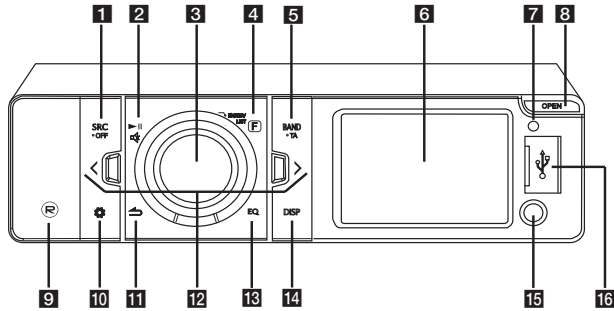

1 SRC/•OFF

- When pressed, selects function sources.
- When pressed and held, powers unit on or off.

2 ▶||

Plays and pauses playback.



Temporarily stops the sound.

3 Volume knob

- Adjusts volume level.
- Confirms the settings.
- Checks tracks, files or preset stations.

4 F

In each mode, sets playback items.

5 BAND

Selects a band in Tuner mode.

• TA (Optional)

Searches stations that have TA/ TP information, when it is pressed and held.

6 Display window

7 Remote Sensor

8 OPEN

Opens the front panel.

9 (R)

Recording to USB.

10 ⚙

Activates setting menu.

11 ↶

Returns to the previous step.

12 </>

Skip/ Search/ Seek/ Tune

13 EQ

Improves sound quality.

- When pressed, selects the EQ function.
- When pressed and held, adjusts the sound level.

14 DISP

- Press it, you can check the clock time.
- Press and hold it, you can turn on/off the display window and the light of LED buttons.

15 AUX

If connected to other portable player, you can enjoy musics from it on the unit.

16 USB port

Remote control

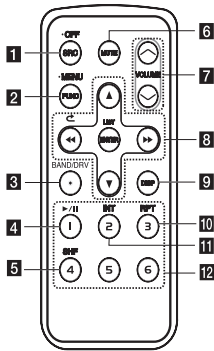

1 SRC/• OFF

- When pressed, selects function sources.
- When pressed and held, powers unit off.

2 FUNC

When pressed, sets playback items in each mode.

• MENU

When pressed and held, activates setting menu.

3 BAND

Selects a band in Tuner mode.

DRV

Moves to next USB drive.

4 ▶/II Plays or pauses playback.

5 SHF Randoms playback

6 MUTE Temporarily stops the sound.

7 VOLUME ▲/▼

Adjusts volume level.

8 ◀/▶

Skip/ Search/ Seek/ Tune



Returns to the previous step.



- List up/ down

- Adjusts settings.

- Moves 10 MP3/WMA tracks backward or forward if there is no folder or one folder on a CD.

- Moves to the previous or next folder if there are more than 2 folders on a CD.

ENTER/ LIST

- Confirms the settings.

- Checks tracks, files or preset stations.

9 DISP

- Press it, you can check the clock time.
- Press and hold it, you can turn on/off the display window and the light of LED buttons.

10 RPT

Repeats playback

11 INT

Intro scan

12 Numeric buttons (1 - 6)

Selects a numbered preset station in TUNER.

Battery Installation

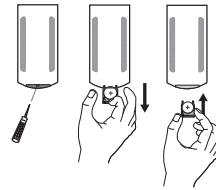

1. Pull out the battery holder with a sharp product like a ball point pen.
2. Put the battery with + and - correctly on the battery holder.
3. Push the battery holder back into its original position.

! Note

- Use only one CR2025 (3V) lithium battery.
- Remove the battery if the remote control is not used for a long period of time.
- Do not leave the product in a hot or humid place.
- Do not handle the battery with metallic tools.
- Do not store the battery with metallic materials.

About detachable control panel [LCS510IR/ LCS510UR]

2

Connecting

Attaching the control panel

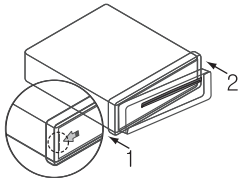

1. Align the left side of the panel with the stopper.
2. Push the right side of panel into the unit until it clicks.

⚠ Caution

- The control buttons may not work properly if the control panel is not attached properly. If this occurs, gently press the display.
- Do not leave the control panel in any area exposed to high temperatures or direct sunlight.
- Do not drop the control panel or otherwise subject it to strong impact.
- Do not allow such volatile agents as benzene, thinner, or insecticides to come into contact with the surface of the control panel.

Detaching the control panel

1. Press the  to open the control panel.

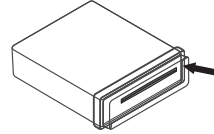

2. Push the control panel to right.

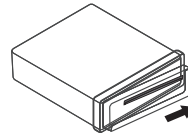

3. Pull the control panel out of the unit.
4. Put the detached control panel into the protective case.

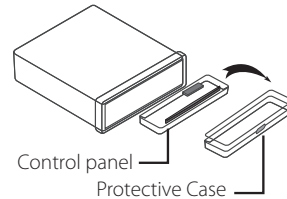

! Note

Periodically wipe the contacts on the back of the control panel with a cotton swab moistened with alcohol. For safety, turn off the ignition before cleaning, and remove the key from the ignition switch.

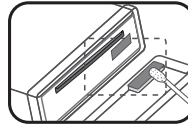

About detachable control panel [LCF610IR]

Attaching the control panel

1. Attach part **A** of the control panel to part **B** of the unit.

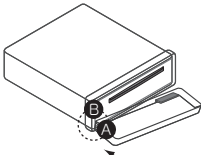

2. Attach part **C** of the control panel to part **D** of the unit while pushing the control panel to left.
3. Close the control panel.

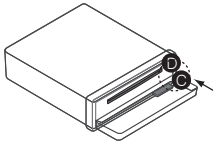

⚠ Caution

- The control buttons may not work properly if the control panel is not attached properly. If this occurs, gently press the display.
- Do not leave the control panel in any area exposed to high temperatures or direct sunlight.
- Do not drop the control panel or otherwise subject it to strong impact.
- Do not allow such volatile agents as benzene, thinner, or insecticides to come into contact with the surface of the control panel.

Detaching the control panel

1. Press the OPEN to open the control panel.

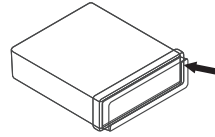

2. Push the control panel to left.

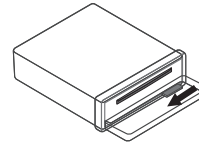

3. Pull the control panel out of the unit.
4. Put the detached control panel into the protective case.

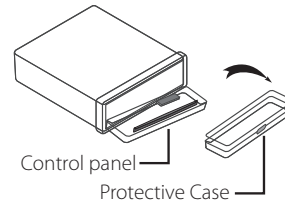

⚠ Note

Periodically wipe the contacts on the back of the control panel with a cotton swab moistened with alcohol. For safety, turn off the ignition before cleaning, and remove the key from the ignition switch.

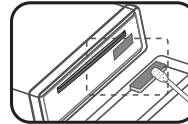

Installation

Basic Installation

Before installing, make sure that the ignition-switch is set to OFF and remove the terminal of the car battery to avoid short-circuiting.

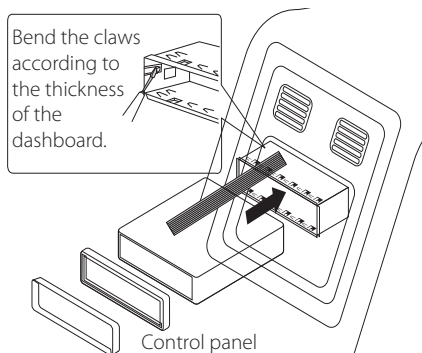

1. Remove the existing receiver unit.
2. Make the necessary connections.
3. Install the installation sleeve.
4. Install the unit into the installation sleeve.

Removing the existing receiver unit

If there is already an installation sleeve for the receiver unit in the dashboard, it must be removed.

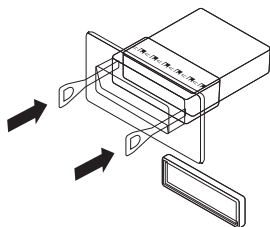

1. Remove the rear support from the unit.
2. Remove the control panel and trim ring from the unit.
3. Insert the lever into the hole on one side of the unit. Perform the same operation on the other side and pull the unit out from the mounting sleeve.

ISO-DIN Installation

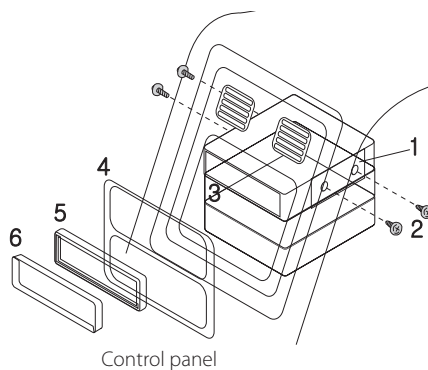

1. Slide the unit into the ISO-DIN frame.
2. Fit screws removed from the old unit.
3. Slide the unit and frame into the dash opening.
4. Install the dash panel or adapter plate.
(According to models, this step may not be needed.)
5. Install the trim ring to the unit.
6. Install the control panel to the unit.

Connection

Connecting to a car

Before installing, make sure that the ignition-switch is set to OFF and remove the terminal of the car battery to avoid short-circuiting.

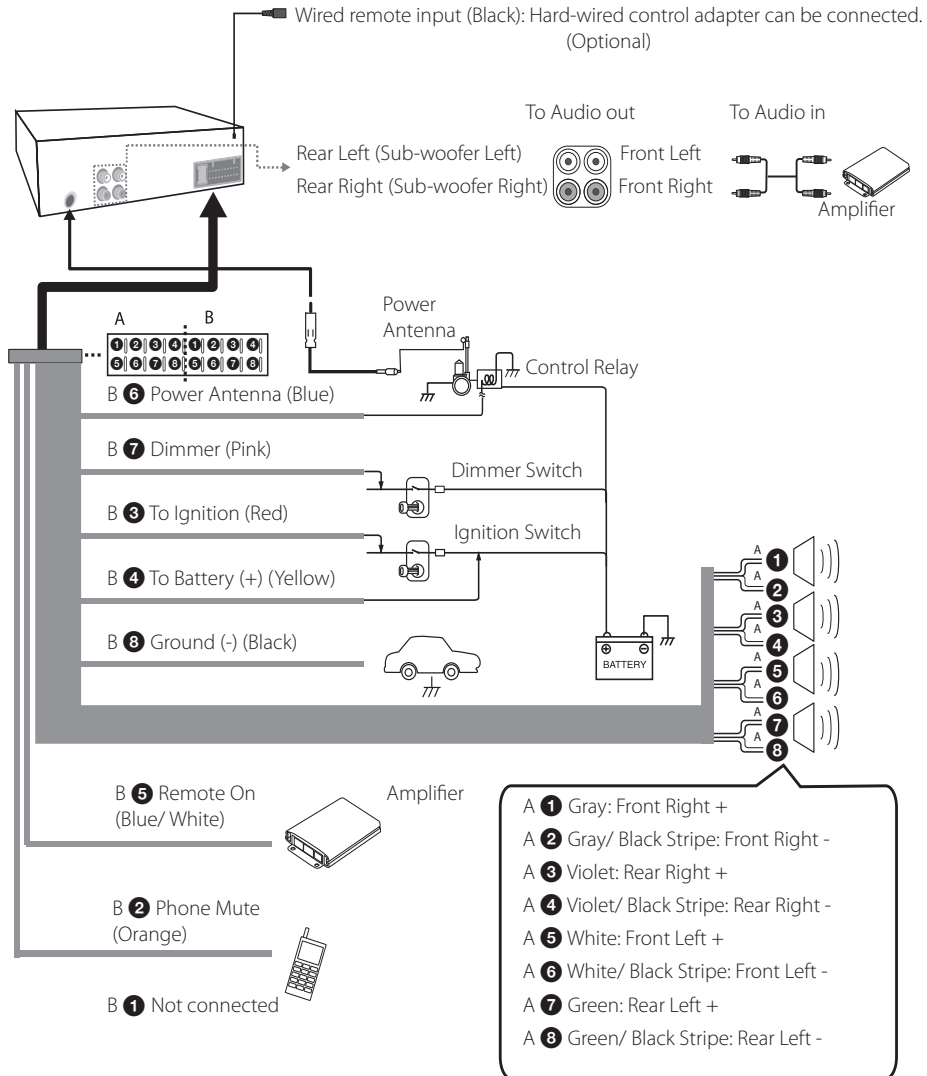

Operation



Basic operations

1. Turn the unit on by pressing any key on the unit.
2. Select a source by pressing SRC.
3. Rotate the volume knob to adjust the volume on the unit.
Or press VOLUME \wedge / \vee on the remote control.

! Note

If a source is not connected to the unit, the source is not recognized.

Turning off the sound temporarily

1. Press  to mute your unit.
Or press MUTE on the remote control.
2. To cancel it, press  again.
Or press MUTE again.

Using EQ (Equalizer)

EQ is to increase or decrease the signal strength of audio frequencies. The function helps you to enjoy sound more plentifully.

Press EQ on the unit repeatedly. The indicator lights up in the following order.

XDSS+ \rightarrow POP \rightarrow CLASSIC \rightarrow ROCK \rightarrow JAZZ \rightarrow
VOCAL \rightarrow SALSA \rightarrow SAMBA \rightarrow REGGAE \rightarrow RUSSY
 \rightarrow USER 1 \rightarrow USER 2 \rightarrow Off (not displayed)

! Note

You can adjust sound level to your preference. Once you select a USER 1/2 mode and press , then adjust the sound level (BASS (bass), MID (middle), TRB (treble), BAL (left/right speaker), FAD (front/rear speaker), S-W (Sub-woofer: optional)), it will be automatically stored for the currently selected USER 1/2 mode. Refer to the "For [SOUND] setting" for USER 1/2 mode on the page 13.

Checking the clock

1. Press DISP to check the clock.
2. Press it again to remove it.

Turning off the display light

1. Press and hold DISP.
2. Press and hold it again to turn it on.

! Note

Under the light-off condition, press any keys, the light is turned on and then off automatically if you don't press it within a few seconds.

Resetting the unit

You can reset the unit when it does not operate properly.

1. Detach the control panel.
Refer to page 8-9 for detaching the control panel.
2. Press the RESET hole with a sharp object.

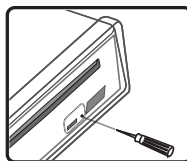

[LCS510IR/ LCS510UR]

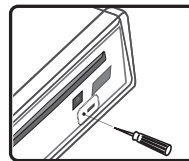



[LCF610IR]

Adjusting the general settings

You can adjust [SOUND], [LIGHT] and [OTHER] settings.

On the unit

1. Press .
2. Rotate the volume knob to select [SOUND], [LIGHT], or [OTHER] and press it.
3. Rotate the volume knob to select the item and press it.
4. Rotate the volume knob clockwise or counterclockwise to adjust the level.
5. Press the volume knob to confirm the setting.
If you want to return to the previous step, press .

On the Remote Control

1. Press and hold FUNC/• MENU.
2. Press ▲ / ▼ to select [SOUND], [LIGHT], or [OTHER] and press ENTER.
3. Press ▲ / ▼ to select the mode and press ENTER.
4. Press ▲ / ▼ to adjust the level.
5. Press ENTER to confirm the setting.
If you want to return to the previous step, press .

For [SOUND] setting

You can adjust sound quality by adjusting the level of BASS (bass), MID (middle), TRB (treble), BAL (left/right speaker), FAD (front/rear speaker) and SWC (Sub woofer control).

- When you set the EQ to USER 1/2 mode.: You can adjust the level of BASS (bass), MID (middle), TRB (treble) BAL (left/right speaker), FAD (front/rear speaker) and SWC (Sub woofer control).

For [LIGHT] setting

You can adjust the light effects by adjusting LED, DIM, or DIM L.

- LED COL1/ COL2/ AUTO: You can change the LED window color.
- DIM (Dimmer) OFF/ ON/ AUTO: You can change the brightness of the display window during the power-on status.

Settings	Description
DIM ON	The display window becomes dark.
DIM OFF	The display window becomes bright.
DIM AUTO	The dimmer operates according to the car dimmer setting.

- DIM L (Dimmer Level): When you set DIM to ON/ AUTO, you can adjust the dimmer level. (-2, -1, 0, +1, +2)

For [OTHER] setting

- AUX (Auxiliary) ON/ OFF
It is possible to use auxiliary equipment with this unit. Activate the auxiliary setting when using auxiliary equipment connected to this unit.
- DEMO OFF/ ON
You can change the initial indication on the display to information name (function name, EQ name, etc...) while listening to a source.
- SW (Subwoofer) OFF/ SW 55 Hz/ SW 85 Hz/ SW 120 Hz
You can enable the subwoofer.
SW OFF <-> SW 55 Hz <-> SW 85 Hz <-> SW 120 Hz.
- A-EQ (Auto EQ) ON/ OFF
AUTO EQ operates only in the music file supported with genre in the device. When you set AUTO EQ to ON, POP, CLASSIC, ROCK, or JAZZ is automatically selected according to the music genre.
- BEEP 2ND/ ALL
BEEP 2ND: The beep is generated when a key is pressed for longer than 2 seconds.
BEEP ALL: The beep is generated when any key is pressed.
- CLK (Clock)
For the model RDS is not supported unit or even for a RDS supported unit.
 - When RDS CT information is not received and then you set CT to OFF, you can adjust the time by yourself. Set the clock as follows ;
 1. Select a source to TUNER.
 2. Press the **F** to select the CT and then set CT to OFF.
(Refer to the " Adjusting TUNER settings " on the pages 18 for setting the CT (Clock Time) ON/ OFF.)
 3. Press **⚙** on the unit to select [OTHER] and then select CLK by rotating the volume knob.
 4. Set the hour by rotating the volume knob.
 5. Press the volume knob to confirm the hour.
 6. Set the minute by rotating the volume knob.
 7. Press the volume knob to confirm the minute.
 - When RDS CT information is received ;
The clock is displayed according to the RDS CT information.
 - When RDS is not supported, set the clock according to 3-7 steps.

Listening to a CD

[LCS510IR/ LCS510UR]

1. Insert a CD.
2. Rotate the volume knob on the unit to adjust the volume.
Or press VOLUME **▲/▼** on the remote control.

[LCF610IR]

1. Press the OPEN to open the control panel.
2. Insert a CD.
3. Close the control panel.
4. Rotate the volume knob on the unit to adjust the volume.
Or press VOLUME **▲/▼** on the remote control.

**! Note**

Make sure to press **▲** after pressing OPEN to eject a disc. Refer to the picture above.

Pausing or restarting CD playback

1. Press **▶||** on the unit to pause playback.
Or press **▶/||** on the remote control.
2. Press it to resume playback.

Searching for a section within a track/ file

1. Press and hold **</>** on the unit for about 1 second during playback.
Or press and hold **◀◀ / ▶▶** on remote control.
2. Press **▶||** on the unit at the point you want.
Or press **▶/||** on the remote control.

Skipping to another track/ file

Press </> on the unit.

Or press ◀▶ on remote control.

Or

1. Press the volume knob on the unit.
Or press ENTER on the remote control.
2. Rotate the volume knob on the unit to select a desired ROOT or folder and press it.
Or press ▲ / ▼ and press ENTER on the remote control.
3. Rotate the volume knob on the unit to select a desired track/ file and press it.
Or press ▲ / ▼ and press ENTER on the remote control.

! Note

To skip to previous track, press briefly < with in 3 seconds of playing time.

Checking information about your music

MP3/WMA files often come with tags. The tag gives the Title, Artist or Album.

Press DISP repeatedly during MP3/WMA/CD TEXT file playback. If there is no information, "NO TEXT" will be shown in the display window.

Playing back tracks/ files in a way you want

For using applicable buttons

1. Press INT/ RPT/ SHF.
2. Press it again to cancel.

Or

Using the FUNC button

On the unit

1. Press **F**.
2. Rotate the volume knob to select an item and press it.
3. Rotate the volume knob to select the option.
4. Press the volume knob to set the option.
If you want to return to the previous step, press **↶**.

On the Remote Control

1. Press FUNC/ • MENU.
2. Press ▲ / ▼ to select an item and press it.
3. Press ▲ / ▼ to select the option.
4. Press ENTER to set the option.
If you want to return to the previous step, press **↶**.

• INT (Intro Scan)

The first 10 seconds of all tracks/ files (INT) or each files in the current selected folder (■ INT) on the disc are played.

• RPT (Repeat)

The current selected tracks/ files (1 RPT) or folder (■ RPT) on the disc is played repeatedly.

• SHF (Shuffle)

Each files in the current selected folder (■ SHF) or all of the tracks/ files (SHF) on the disc is played randomly. During random playback, even if you press <, you won't go back to the previous track.

 Note

- : The icon is displayed during MP3/WMA playback.
- **MP3/WMA Disc compatibility with this unit is limited as follows:**
 1. Sampling Frequency / 8 kHz to 48 kHz (MP3) 22.05 kHz to 48 kHz (WMA).
 2. Bit rate / within 8 kbps to 320 kbps (include VBR) (MP3) 32 kbps to 320 kbps (WMA).
 3. CD-R/CD-RW file system should be "ISO 9660".
 4. If you record MP3/WMA files using software which cannot create a FILE SYSTEM, for example "Direct-CD" etc., it will not be possible to playback MP3/WMA files. We recommend that you use "Easy-CD Creator" which creates an ISO 9660 file system.

You have to set the disc format option to [Mastered] in order to make the discs compatible with the LG players when formatting rewritable discs. When setting the option to Live File System, you cannot use it on LG players.

(Mastered/Live File System: Disc format system for Windows Vista)

Cusotmers should also note that permission is required in order to download MP3/WMA files and music from the Internet. Our company has no right to grant such permission. Permission should always be sought from the copyright owner.

Listening to music from an external device

1. Connect an external device to the AUX jack with line input cable.
2. Select a source to AUX.
3. Play the connected Auxiliary Equipment.
4. Rotate the volume knob on the unit to adjust the volume.
Or press VOLUME ▲/▼ on the remote control.

Preventing radical changes in volume as switching sources

Only when you set AUX to ON as switching sources, you can adjust the volume level of each source to prevent radical changes in volume by selecting GAIN 0/ +6.

1. Press **F** on the unit.
Or press FUNC/ • MENU on the remote control.
2. Rotate the volume knob on unit.
Or press ▲ / ▼ on the remote control to set the option. (GAIN 0/ +6)
3. Press the volume knob on unit.
Or press ENTER on the remote control to confirm the setting.
4. If you want to return to the previous step, press .

Listening to the radio

1. Press SRC repeatedly to select a source to TUNER.
2. Press BAND repeatedly to select a desired band.
3. For manual search, press and hold </> on the unit until "MANUAL" is displayed. Then press it repeatedly to select a desired frequency.
Or press and hold ◀◀ / ▶▶ on the remote control.

For auto search, press </> on the unit until "SEARCH" is displayed.
Or press ◀◀ / ▶▶ on the remote control.
4. Rotate the volume knob on the unit to adjust the volume.
Or press VOLUME ▲/▼ on the remote control.

Storing desired frequencies manually

1. Press BAND to select a desired band you want to store.
2. Press and hold </> on the unit until the beep sound is heard.
Or press and hold ◀◀ / ▶▶ on the remote control.
3. Press it repeatedly to select a desired frequency.
4. Press and hold one of preset buttons among 1 to 6 until the beep sound is heard. (Only LCS510IR/ LCS510UR)
Press the volume knob and rotate the volume knob to select a preset station among 1 to 6 and then press and hold the volume knob until the beep sound is heard. (Only LCF610IR)
5. Repeat steps 1 to 4 to preset other stations.

! Note

When a station is stored on the preset numbers on which another station of the same band has already been preset, the previously preset station is automatically erased.

Listening to a preset station

1. Press BAND repeatedly to select a desired band.
2. Press the volume knob on the unit.
Or press ENTER on the remote control.
3. Rotate the volume knob to select a preset station.
Or press ▲ / ▼ on the remote control.
4. Press the volume knob.
Or press ENTER on the remote control.

Or

Press BAND and then the desired preset button among 1 to 6. (Only LCS510IR/ LCS510UR)

Adjusting TUNER settings

On the unit

1. Press **F**.
2. Rotate the volume knob to select an item and press it.
3. Rotate the volume knob to set the option and press it.
4. If you want to return to the previous step, press **↶**.

On the Remote Control

1. Press **FUNC/•MENU**.
2. Press **▲/▼** to select an item and press **ENTER**.
3. Press **▲/▼** to set the option and press **ENTER**.
4. If you want to return to the previous step, press **↶**.

- **A/S (Auto Store)**

The six strongest broadcasting frequencies will be stored under preset button 1 - 6 in the order of their signal strength. To cancel, press the volume knob (or **ENTER** on the remote control).

- **P/S (Preset scan)**

Each preset station appears. To cancel, press the volume knob (or **ENTER** on the remote control).

- **SENS (Tuner sensitivity) MID/ HI/ LOW**

In an area in which signal reception is weak, it helps the tuner to search more stations. The weaker the reception is, the lower option you should set to.

RDS (OPTIONAL)

- **PTY (Program type)**

It searches the radio stations by program type of FM tuner.

The program types are displayed as follows.

NEWS	FINANCE	EASY M
AFFAIRS	CHILDREN	LIGHT M
INFO	SOCIAL	CLASSICS
SPORT	RELIGION	OTHER M
EDUCATE	PHONE IN	JAZZ
DRAMA	TRAVEL	COUNTRY
CULTURE	LEISURE	NATION M
SCIENCE	DOCUMENT	OLDIES
VARIED	POP M	FOLK M
WEATHER	ROCK M	

- **AF (Alternative frequency) ON/ OFF**

When the reception quality drops, the tuner automatically changes to another station in the network, broadcasting a better reception quality, using the PI and AF codes.

- **REG (Region) ON/ OFF**

REG ON: The unit switches to another station, within the same network, broadcasting the same program when the receiving signals from the current station become weak.

REG OFF: The unit switches to another station, within the same network when the receiving signals from the current station become weak. (In this mode, the program may differ from the one currently received.)

- **TA (Traffic Announcement) ALARM/ SEEK**

TA ALARM: When the tuned station has no TP information for 5 seconds, a double beep sound is output.

TA SEEK: When the tuned station does not receive TP information for 5 seconds, the receiver retunes to the next station that has the TP information.

- **PI (Programme Identification) SOUND/ MUTE**

PI SOUND: When the frequency of a tuned station switches to an AF (Alternative frequency) with an unidentified PI, it keeps the sound.

PI MUTE: When the frequency of a tuned station switches to an AF with an unidentified PI, it mutes the sound until the PI is identified.

- **CT (Clock Time) ON/ OFF**

You can use the RDS CT information to update the time. When RDS CT information is not received and then you set CT to OFF, you can adjust the time by yourself. Refer to the page 14 for setting the clock.

Using an USB device

1. Open the USB cover.
2. Connect the USB device.
3. Press SRC repeatedly to select a source to USB.
4. Rotate the volume knob on the unit to adjust the volume.
Or press VOLUME ▲/▼ on the remote control.

Moving to another drive

When connecting this unit to multi reader, press BAND on the unit (or DRV on remote control) to go the next drive. Each time you press the button, the driver modes change.

Quick Search of a desired file

You can select and play a desired file regardless of the order in USB.

1. Press the volume knob on the unit.
Or press ENTER on the remote control.
2. Rotate the volume knob on the unit to select a desired ROOT or folder and press it.
Or press ▲ / ▼ and press ENTER on the remote control.
3. Rotate the volume knob on the unit to select a desired track/ file and press it.
Or press ▲ / ▼ and press ENTER on the remote control.

! Note

Other functions are same with "Listening to a CD". Refer to page 14 -15.

Playable USB device Requirement

- Do not extract the USB device during operation (play, etc.).
- An USB device which requires additional programme installation when you have connected it to a computer, is not supported.
- Regular back up is recommended to prevent data loss.
- If you use a USB extension cable, USB HUB, USB Multi-reader, or external HDD, the USB device may not be recognized.

- When you connect a partitioned USB device into the unit, only the first partition is recognized on it.
- Some USB device may not work with this unit.
- Digital camera and mobile phone are not supported.
- USB Port of the unit cannot be connected to PC. The unit cannot be used as a storage device.
- Using NTFS file system is not supported. (Only FAT (16/ 32) file system is supported)

Recording to USB from CD or FM tuner

1. Open the USB cover and connect it to the unit.
2. Select CD or FM tuner.
3. Start playback.
4. Press **Ⓜ** to start recording.
For one track CD recording, press it once.
For all tracks recording, press and hold it until the beep is heard.
5. Press it again to stop.

! Note

- Only in CD and FM tuner, recording is available.
- Do not remove the USB device during recording, or an incomplete file may be made and not deleted on PC.
- When USB memory is full, "Not Enough Memory" displays and stops recording.
- For tuner recording, the broadcastings are recorded by 20 moments on a file name.

The making of unauthorized copies of copy-protected material, including computer programs, files, broadcasts and sound recordings, may be an infringement of copyrights and constitute a criminal offense. This equipment should not be used for such purposes.

Be responsible
Respect copyrights

Listening to music by connecting iPod/iPhone [LCS510IR/ LCF610IR]

You can enjoy iPod/iPhone-stored music on the unit by connecting it to the USB connector using the appropriate cable.

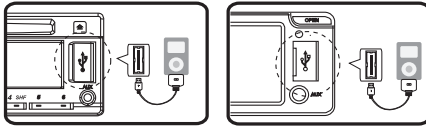

[LCS510IR]

[LCF610IR]

1. Open the USB cover.
2. Connect the iPod/iPhone.
3. Press SRC to select a source to USB.
4. Rotate the volume knob to adjust the volume on the unit.
Or press VOLUME \wedge /V on the remote control.

! Note

Refer to the page 21 to check the compatible iPod model for this unit.

Pausing or restarting playback

1. Press $\blacktriangleright\parallel$ on the unit to pause playback.
Or press $\blacktriangleright\parallel$ on the remote control.
2. Press it to resume playback.

Searching for a section within a track/ file

During playback, press and hold \leftarrow/\rightarrow and then release at a point you want.

Checking information about your music

MP3/WMA files often come with tags. The tag gives the Title, Artist or Album.

Press DISP repeatedly during MP3/WMA file playback. If there is no information, "NO TEXT" will be shown in the display window.

Playing back tracks/ files in a way you want

On the unit

1. Press **F**.
2. Rotate the volume knob to select an item and press it.
3. Rotate the volume knob to select the option.
4. Press the volume knob to set the option.
If you want to return to the previous step, press \leftarrow .

On the Remote Control

1. Press RPT/ SHF.
 2. Press it again to cancel.
- Or
1. Press FUNC/ • MENU.
 2. Press $\blacktriangle/\blacktriangledown$ to select an item and press ENTER.
 3. Press $\blacktriangle/\blacktriangledown$ to select the option.
 4. Press ENTER to set the option.

If you want to return to the previous step, press \leftarrow .

- RPT (Repeat)
The current selected tracks/ files (1 RPT) or folder (■ RPT) on the iPod is played repeatedly.
- SHF (Shuffle)
Each file in the currently selected album (■ SHF) or all of the tracks/ files (SHF) on the iPod are played randomly.
During random playback, even if you press \leftarrow , you won't go back to the previous track.
- SPD (BOOK SPEED)
You can adjust the audiobook speed of iPod to NOR (Normal), SLOW, or FAST.

Playing back files by music menus

You can check files by music menus and play it back.

The music menus are as follows.

PLAYLISTS → ARTISTS → ALBUMS → GENRES
 → SONGS → COMPOSER → AUDIO BOOK →
 PODCAST → ...

1. Press the volume knob on the unit.
Or press ENTER on the remote control.
2. Rotate the volume knob on the unit to select a music menu and press it.
Or press ▲ / ▼ on the remote control.
3. Rotate the volume knob on the unit to select a file.
Or press ▲ / ▼ on the remote control.
4. Press the volume knob on the unit to confirm the setting.
Or press ENTER on the remote control.
If you want to return to the previous step, press ↶.

Compatible iPod models

iPod classic (5th/ 6th generation)
 iPod nano (1st/ 2nd/ 3rd/ 4th/ 5th generation)
 iPod touch (1st/ 2nd/ 3rd generation)
 iPhone
 iPhone 3G
 iPhone 3GS
 iPhone 4

**We recommend that you use the OS
Version 4.2.1 or more.**



“Made for iPod” means that an electronic accessory has been designed to connect specifically to iPod and has been certified by the developer to meet Apple performance standards.

“Works with iPhone” means that an electronic accessory has been designed to connect specifically to iPhone and has been certified by the developer to meet Apple performance standards. Apple is not responsible for the operation of this device or its compliance with safety and regulatory standards.

iPod is a trademark of Apple Inc., registered in the U.S. and other countries.

iPhone is a trademark of Apple Inc.

Troubleshooting

Symptoms	Cause	Solution
Power doesn't turned on. The unit doesn't operate.	Leads and connectors are not properly.	Confirm once more that all connections are correct.
	The fuse is blown.	Rectify the problem that caused the fuse to blow, and then replace it. Be very sure to install the correct fuse with the same rate.
	Noise and other factors are causing the built in microprocessor to operate incorrectly.	Turn the unit off and then on again.
No sound is heard.	Cables are not connected correctly.	Connect the cables correctly.
There's audio skipping.	This unit is not firmly secured.	Secure this unit firmly.
The playback is not possible.	The disc is dirty.	Clean the disc.
	The disc of unplayable type is loaded.	Check what type the disc.
Radio stations cannot be tuned in.	The signal strength of the stations is too weak. (when tuning in with automatic tuning.)	Tuned in the stations manually.
	No station has been preset or preset stations have been cleared. (When tuning by scanning preset stations.)	Preset the stations. (Refer to the page 17.)
iPod/ iPhone does not work.	Check whether iPod/ iPhone is connected to the unit correctly.	Connect it to the unit correctly.
The unit does not operate correctly even when the appropriate remote control buttons are pressed.	Battery power is low.	Load a new battery.

Specifications

General

Output Power: 53 W x 4 CH (Max.)
Power Source: DC 12 V
Speaker impedance: 4 Ω
Ground System: Negative
Dimensions (W x H x D): (178 x 50 x 169) mm
(without Control Panel)
Net Weight: 1.37 kg

TUNER

FM Tuning Range:
87.5 MHz to 108.0 MHz
S/N Ratio: 55 dB
Distortion: 0.7 %
Usable Sensitivity: 12 dB μ V
AM (MW) Tuning Range:
(520 to 1720) kHz or (522 to 1620) kHz
S/N Ratio: 50 dB
Distortion: 1.0 %
Usable Sensitivity: 28 dB μ V

CD

Frequency Response: 20 Hz to 20 kHz
S/N Ratio: 80 dB
Distortion: 0.12 %
Channel Separation (1 kHz): 55 dB

AUX

Frequency Response: 20 Hz to 20 kHz
S/N Ratio: 80 dB
Distortion: 0.1 %
Channel Separation (1 kHz): 45 dB
Max Input Level (1 kHz): 1.1 V

USB

Version: USB 1.1 or USB 2.0 Full Speed
Bus Power Supply (USB): DC 5V $\overline{\text{---}}$ 1A

Line OUT (OPTIONAL)

Frequency Response: 20 Hz to 20 kHz
Output Voltage: 2 V (Max.)

Subwoofer (OPTIONAL)

Frequency Response: 20 Hz to 120 Hz
Output Voltage: 2 V (Max.)

- Design and specifications are subject to change without notice.



	Телефон	Режим работы	Интернет
Россия	8-800-200-7676	Круглосуточно	http://www.lg.com
Беларусь	8-820-0071-1111		
Латвия	8-0003-271		
Литва	8-800-30-800		
Эстония	800-9990		
Украина	0-800-303-000	8:00 - 21:00 (Пн.-Пят.) 9:00 - 18:00 (Суб., Вс.)	
Казахстан	8-8000-805-805	9:00 - 18:00 (Пн.-Пят.) 9:00 - 18:00 (Суб.)	
	2255 (для мобильных телефонов)		
Кыргызстан	8-0000-710-005	Круглосуточно	
Узбекистан			

Импортер LG Electronics RUS

Адрес импортера 143160 Российская Федерация, Московская область,
Рузский район, сельское поселение Дороховское, 86 км. Минского шоссе, д.9

Адрес производителя : ЛГ ЭЛЕКТРОНИКС (КУНШАН) КОМПЬЮТЕР КО., ЛТД
215300, КИТАЙ, ПРОВИНЦИЯ ДЖИАНГ СУ, Г. КУНШАН,
Ш. КИАНДЖИН, Д. 88



Сделано в Китае