



**LG**

Life's Good

# OWNER'S MANUAL

# LCD TV

Please read this manual carefully before operating your set and retain it for future reference.

26LD320H	32LD325H	26LD340H	26LD345H	32LD310H
32LD320H	37LD325H	32LD340H	32LD345H	37LD310H
37LD320H		37LD340H	37LD345H	32LD330H
42LD320H		42LD340H	42LD345H	37LD330H

# WARNING



**WARNING / CAUTION**  
RISK OF ELECTRIC SHOCK  
DO NOT OPEN



TO REDUCE THE RISK OF ELECTRIC SHOCK DO NOT REMOVE COVER (OR BACK). NO USER SERVICEABLE PARTS INSIDE. REFER TO QUALIFIED SERVICE PERSONNEL.



The lightning flash with arrowhead symbol, within an equilateral triangle, is intended to alert the user to the presence of uninsulated "dangerous voltage" within the product's enclosure that may be of sufficient magnitude to constitute a risk of electric shock to persons.



The exclamation point within an equilateral triangle is intended to alert the user to the presence of important operating and maintenance (servicing) instructions in the literature accompanying the appliance.

## WARNING

TO REDUCE THE RISK OF FIRE AND ELECTRIC SHOCK, DO NOT EXPOSE THIS PRODUCT TO RAIN OR MOISTURE.

## NOTE TO CABLE/TV INSTALLER

This reminder is provided to call the CATV system installer's attention to Article 820-40 of the National Electric Code (U.S.A.). The code provides guidelines for proper grounding and, in particular, specifies that the cable ground shall be connected to the grounding system of the building, as close to the point of the cable entry as practical.

# WARNING

To prevent fire or shock hazards, do not expose this product to rain or moisture.

## FCC Notice

### Class B digital device

This equipment has been tested and found to comply with the limits for a Class B digital device, pursuant to Part 15 of the FCC Rules. These limits are designed to provide reasonable protection against harmful interference in a residential installation. This equipment generates, uses and can radiate radio frequency energy and, if not installed and used in accordance with the instructions, may cause harmful interference to radio communications. However, there is no guarantee that interference will not occur in a particular installation. If this equipment does cause harmful interference to radio or television reception, which can be determined by turning the equipment off and on, the user is encouraged to try to correct the interference by one or more of the following measures:

- Reorient or relocate the receiving antenna.
- Increase the separation between the equipment and receiver.
- Connect the equipment to an outlet on a circuit different from that to which the receiver is connected.
- Consult the dealer or an experienced radio/TV technician for help.

This device complies with part 15 of the FCC Rules.

Operation is subject to the following two conditions: (1) This device may not cause (harmful) interference, and (2) this device must accept any interference received, including interference that may cause undesired operation (of the device).

Any changes or modifications in construction of this device which are not expressly approved by the party responsible for compliance could void the user's authority to operate the equipment.

## CAUTION

Do not attempt to modify this product in any way without written authorization from LG Electronics.

Unauthorized modification could void the user's authority to operate this product.

# SAFETY INSTRUCTIONS

## IMPORTANT SAFETY INSTRUCTIONS

Read these instructions.

Keep these instructions.

Heed all warnings.

Follow all instructions.



- 1** Do not use this apparatus near water.



- 2** Clean only with dry cloth.



- 3** Do not block any ventilation openings. Install in accordance with the manufacturer's instructions.



- 4** Do not install near any heat sources such as radiators, heat registers, stoves, or other apparatus (including amplifiers) that produce heat.



- 5** Do not defeat the safety purpose of the polarized or grounding-type plug. A polarized plug has two blades with one wider than the other. A grounding type plug has two blades and a third grounding prong. The wide blade or the third prong are provided for your safety. If the provided plug does not fit into your outlet, consult an electrician for replacement of the obsolete outlet. (Can differ by country)



- 6** Protect the power cord from being walked on or pinched particularly at plugs, convenience receptacles, and the point where they exit from the apparatus.



- 7** Only use attachments/accessories specified by the manufacturer.



- 8** Use only with the cart, stand, tripod, bracket, or table specified by the manufacturer, or sold with the apparatus. When a cart is used, use caution when moving the cart/apparatus combination to avoid injury from tip-over.



S3125A

- 9** Unplug this apparatus during lighting storms or when unused for long periods of time.



- 10** Refer all servicing to qualified service personnel. Servicing is required when the apparatus has been damaged in any way, such as power-supply cord or plug is damaged, liquid has been spilled or objects have fallen into the apparatus, the apparatus has been exposed to rain or moisture, does not operate normally, or has been dropped.



- 11** Never touch this apparatus or antenna during a thunder or lightning storm.

- 12** When mounting a TV on the wall, make sure not to install the TV by the hanging power and signal cables on the back of the TV.

- 13** Do not allow an impact shock or any objects to fall into the product, and do not drop onto the screen with something.

- 14** CAUTION concerning the Power Cord:  
It is recommend that appliances be placed upon a dedicated circuit; that is, a single outlet circuit which powers only that appliance and has no additional outlets or branch circuits. Check the specification page of this owner's manual to be certain.  
Do not connect too many appliances to the same AC power outlet as this could result in fire or electric shock.

Do not overload wall outlets. Overloaded wall outlets, loose or damaged wall outlets, extension cords, frayed power cords, or damaged or cracked wire insulation are dangerous. Any of these conditions could result in electric shock or fire. Periodically examine the cord of your appliance, and if its appearance indicates damage or deterioration, unplug it, discontinue use of the appliance, and have the cord replaced with an exact replacement part by an authorized servicer. Protect the power cord from physical or mechanical abuse, such as being twisted, kinked, pinched, closed in a door, or walked upon. Pay particular attention to plugs, wall outlets, and the point where the cord exits the appliance.

Do not make the TV with the power cord plugged in. Do not use a damaged or loose power cord. Be sure do grasp the plug when unplugging the power cord. Do not pull on the power cord to unplug the TV.



# SAFETY INSTRUCTIONS

- 15** **WARNING** - To reduce the risk of fire or electrical shock, do not expose this product to rain, moisture or other liquids. Do not touch the TV with wet hands. Do not install this product near flammable objects such as gasoline or candles or expose the TV to direct air conditioning.



- 16** Do not expose to dripping or splashing and do not place objects filled with liquids, such as vases, cups, etc. on or over the apparatus (e.g. on shelves above the unit).



## **17** GROUNDING

Ensure that you connect the earth ground wire to prevent possible electric shock (i.e. a TV with a three-prong grounded AC plug must be connected to a three-prong grounded AC outlet). If grounding methods are not possible, have a qualified electrician install a separate circuit breaker.

Do not try to ground the unit by connecting it to telephone wires, lightning rods, or gas pipes.

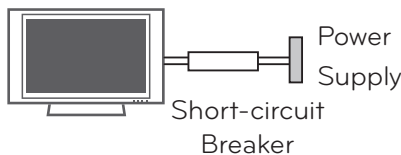

- 18** **DISCONNECTING DEVICE FROM MAINS**  
Mains plug is the disconnecting device. The plug must remain readily operable.

- 19** As long as this unit is connected to the AC wall outlet, it is not disconnected from the AC power source even if you turn off this unit by SWITCH.

- 20** **Cleaning**  
When cleaning, unplug the power cord and scrub gently with a soft cloth to prevent scratching. Do not spray water or other liquids directly on the TV as electric shock may occur. Do not clean with chemicals such as alcohol, thinners or benzene.

- 21** **Moving**  
Make sure the product is turned off, unplugged and all cables have been removed. It may take 2 or more people to carry larger TVs. Do not press against or put stress on the front panel of the TV.

## **22** ANTENNAS **Outdoor antenna grounding**

(Can differ by country) If an outdoor antenna is installed, follow the precautions below. An outdoor antenna system should not be located in the vicinity of overhead power lines or other electric light or power circuits, or where it can come in contact with such power lines or circuits as death or serious injury can occur.

Be sure the antenna system is grounded so as to provide some protection against voltage surges and built-up static charges.

Section 810 of the National Electrical Code (NEC) in the U.S.A. provides information with respect to proper grounding of the mast and supporting structure, grounding of the lead-in wire to an antenna discharge unit, size of grounding conductors, location of antenna discharge unit, connection to grounding electrodes and requirements for the grounding electrode.

### **Antenna grounding according to the National Electrical Code, ANSI/NFPA 70**

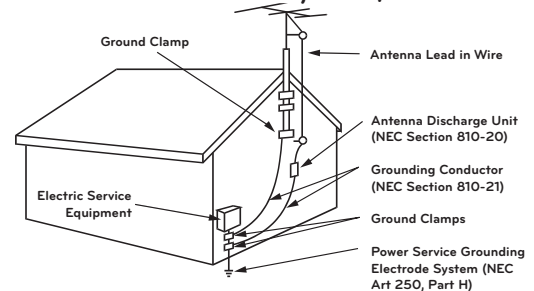

NEC: National Electrical Code

- 23** **Ventilation**  
Install your TV where there is proper ventilation. Do not install in a confined space such as a bookcase. Do not cover the product with cloth or other materials (e.g.) plastic while plugged in. Do not install in excessively dusty places.

- 24** Take care not to touch the ventilation openings. When watching the TV for a long period, the ventilation openings may become hot. This does not affect the performance of the product or cause defects in the product.

- 25** If you smell smoke or other odors coming from the TV, unplug the power cord contact and authorized service center.

- 26** Do not press strongly upon the panel with hand or sharp object such as nail, pencil or pen, or make a scratch on it.



- 27** Keep the product away from direct sunlight.

### **28** Dot Defect

The Plasma or LCD panel is a high technology product with resolution of two million to six million pixels. In a very few cases, you could see fine dots on the screen while you're viewing the TV. Those dots are deactivated pixels and do not affect the performance and reliability of the TV.

---

### **29** Generated Sound

"Cracking" noise: A cracking noise that occurs when watching or turning off the TV is generated by plastic thermal contraction due to temperature and humidity. This noise is common for products where thermal deformation is required.

Electrical circuit humming/panel buzzing: A low level noise is generated from a high-speed switching circuit, which supplies a large amount of current to operate a product. It varies depending on the product.

This generated sound does not affect the performance and reliability of the product.

---

### **30** For LED LCD TV/ LCD TV

If the TV feels cold to the touch, there may be a small "flicker" when it is turned on. This is normal, there is nothing wrong with TV.

Some minute dot defects may be visible on the screen, appearing as tiny red, green, or blue spots. However, they have no adverse effect on the monitor's performance.

Avoid touching the LCD screen or holding your finger(s) against it for long periods of time. Doing so may produce some temporary distortion effects on the screen.

### **ON DISPOSAL**

#### **(Only Hg lamp used LCD TV)**

The fluorescent lamp used in this product contains a small amount of mercury. Do not dispose of this product with general household waste. Disposal of this product must be carried out in accordance to the regulations of your local authority.

# CONTENTS

<b>WARNING</b> .....	2
<b>SAFETY INSTRUCTIONS</b> .....	3
<b>FEATURE OF THIS TV</b> .....	8

## PREPARATION

Accessories .....	9
Front Panel Information .....	10
Back Panel Information .....	11
Stand Instructions .....	14
VESA wall mounting .....	16
Cable Management .....	17
Desktop Pedestal Installation .....	18
Swivel Stand .....	18
Kensington Security System .....	18
Attaching the TV to a Desk .....	19
Securing the TV to the Wall to Prevent Falling when the TV is used on a stand .....	21
Antenna or Cable Connection .....	22

## EXTERNAL EQUIPMENT SETUP

HD Receiver setup .....	23
DVD setup .....	26
VCR SETUP .....	28
Other A/V Source Setup .....	29
USB Connection .....	30
PC Setup .....	31

## WATCHING TV / CHANNEL CONTROL

Remote Control Functions .....	38
Turning on the TV .....	40
Channel Selection .....	40
Volume Adjustment .....	40
On-Screen Menus Selection .....	41
Customer Support	
- Picture Test / Sound Test .....	43
- Product/Service Info .....	44

Channel Setup	
- Auto Scan (Auto Tuning) .....	45
- Add/Delete Channel (Manual Tuning) .....	46
- Channel Editing .....	47
Input List .....	48
Example Electronic Program Guide .....	49
Channel Label .....	50
Demo Mode .....	51

## MY MEDIA

Connection Method .....	52
Entry Mode .....	54
Photo List .....	55
Music List .....	61
Extra Contents .....	65

## PICTURE CONTROL

Picture Size (Aspect Ratio) Control .....	66
Preset Picture Settings (Picture mode) .....	68
Manual Picture Adjustment - User Mode .....	69
Picture Improvement Technology (Advanced Control) .....	70
Picture Reset .....	73

## SOUND & LANGUAGE CONTROL

Auto Volume .....	74
Clear Voice II .....	75
Balance .....	76
Preset Sound Settings (Sound Mode) .....	77
Sound Setting Adjustment - User Mode .....	78
Audio Reset .....	79
TV Speakers On/Off .....	79
Audio Language .....	80
On-screen Menus Language Selection .....	81
Caption Mode	
- Analog Broadcasting System Captions .....	82
- Digital Broadcasting System Captions .....	83
- Caption Option .....	84

## TIME SETTING

Clock Setting	
- Auto Clock Setup .....	85
- Manual Clock Setup .....	86
Auto On/Off Time Setting .....	87
Sleep Timer Setting .....	88
Auto Shut-Off Setting.....	88

## PARENTAL CONTROL / RATINGS

Set Password & Lock System	
- Setting up Your Password .....	89
- Set Password .....	90
- Lock System.....	91
Channel Blocking.....	92
Movie & TV Rating .....	93
Downloadable Rating.....	96
External Input Blocking .....	97

## APPENDIX

Troubleshooting.....	98
Maintenance .....	100
Product Specifications .....	101
IR Code.....	102
Open Source License.....	103

# FEATURE OF THIS TV

- Some of these features are not available on all models.



High-definition television. High-resolution digital television broadcast and playback system composed of roughly a million or more pixels, 16:9 aspect-ratio screens, and AC3 digital audio. A subset of digital television, HDTV formats include 1080i and 720p resolutions.



A unique invisible speaker system tuned by renowned audio expert, Mr. Mark Levinson. Speakers are embedded in strategic spots behind the front cabinet and use minute vibrations to turn the entire front bezel into the speaker system. The result is a clean, polished look, and enhanced audio by increasing the "sweet spot", giving a wider and richer sound field.



Automatically enhances and amplifies the sound of human voice frequency range to help keep dialogue audible when background noise swells.



Manufactured under license from Dolby Laboratories. "Dolby" and the double-D symbol are trademarks of Dolby Laboratories.



HDMI, the HDMI logo and High-Definition Multimedia Interface are trademarks or registered trademarks of HDMI Licensing LLC."



View videos and photos and listen to music on your TV through USB 2.0 ('videos' dependent on model).



## IMPORTANT INFORMATION TO PREVENT "IMAGE BURN / BURN-IN" ON YOUR TV SCREEN

- When a fixed image (e.g. logos, screen menus, video game, and computer display) is displayed on the TV for an extended period, it can become permanently imprinted on the screen. This phenomenon is known as "image burn" or "burn-in." Image burn is not covered under the manufacturer's warranty.
- In order to prevent image burn, avoid displaying a fixed image on your TV screen for a prolonged period (2 or more hours for LCD, 1 or more hours for Plasma).
- Image burn can also occur on the letter-boxed areas of your TV if you use the 4:3 aspect ratio setting for an extended period.

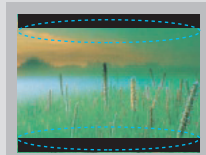
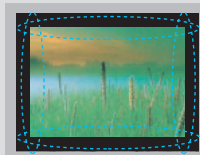
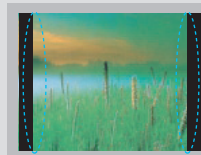



# PREPARATION

## ACCESSORIES

Ensure that the following accessories are included with your TV. If an accessory is missing, please contact the dealer where you purchased the TV.

The accessories included may differ from the images below.

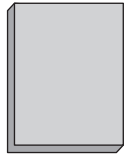

Owner's Manual



CD Manual

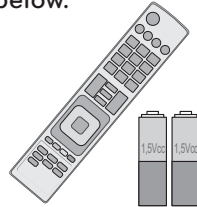

Remote Control,  
Batteries (AAA)

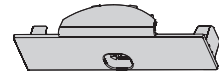

Protection Cover  
(Refer to P.15)



Power Cord



Torx plus Star head  
screw  
(Refer to P.14)

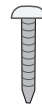

Screw for stand fixing  
(Refer to P.19)

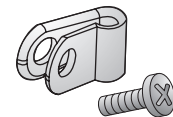

Protective Bracket and  
Screw for Power Cord  
(Refer to P.17)

### Not included with all models

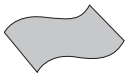

Polishing Cloth

- \* Wipe spots on the exterior only with the polishing cloth.
- \* Do not wipe roughly when removing stains. Excessive pressure may cause scratches or discoloration.

### Option Extras

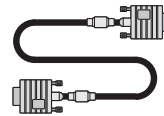

D-sub 15 pin Cable

When using the VGA (D-sub 15 pin cable) PC connection, the user must use shielded signal interface cables with ferrite cores to maintain standards compliance.

### 26/32/37/42LD320H, 32/37LD325H, 26/32/37/42LD340H, 26/32/37/42LD345H

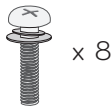

(M4 x 24)  
Screws for stand assembly  
(Refer to P.14)

(Except 26LD320H,  
26LD340H, 26LD345H)

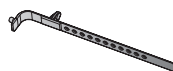

Cable Holder

(Except 26LD320H,  
26LD340H, 26LD345H)



Power Cord Holder  
(Refer to P.17)

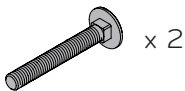

Screws for stand fixing  
(Refer to P.19)



Washers for stand fixing  
(Refer to P.19)

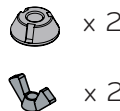

Nuts for stand fixing  
(Refer to P.19)

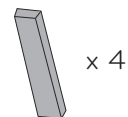

Rubbers for stand  
fixing  
(Refer to P.19)

### 32/37LD310H, 32/37LD330H

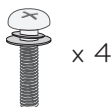

(M4 x 24)  
Screws for stand assembly  
(Refer to P.14)



Cable Holder



Power Cord Holder  
(Refer to P.17)

# PREPARATION

## FRONT PANEL INFORMATION

■ Image shown may differ from your TV.

PREPARATION

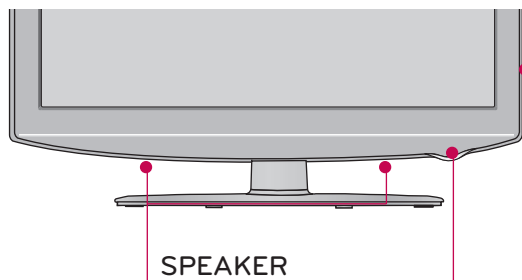

Remote Control Sensor  
Power/Standby Indicator

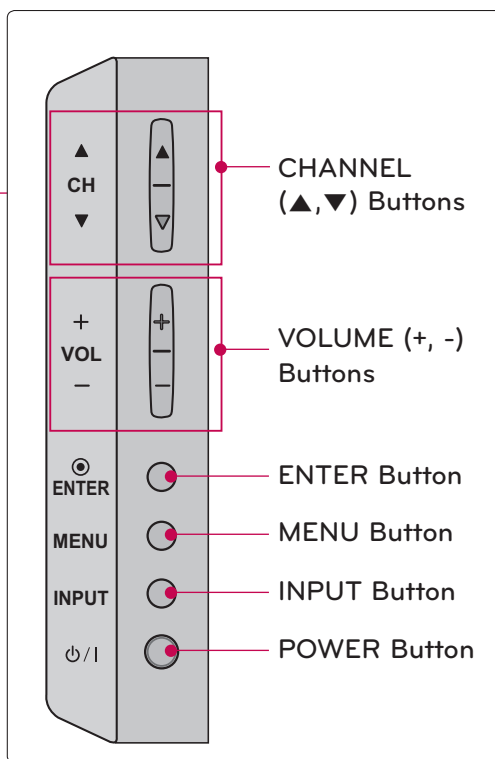

# BACK PANEL INFORMATION

Image shown may differ from your TV.

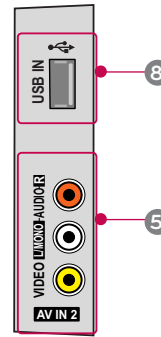
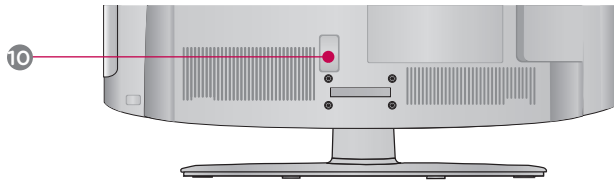

## 32/37/42LD320H, 32/37LD325H

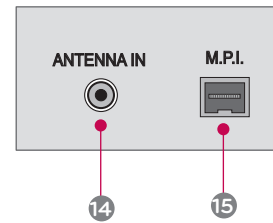
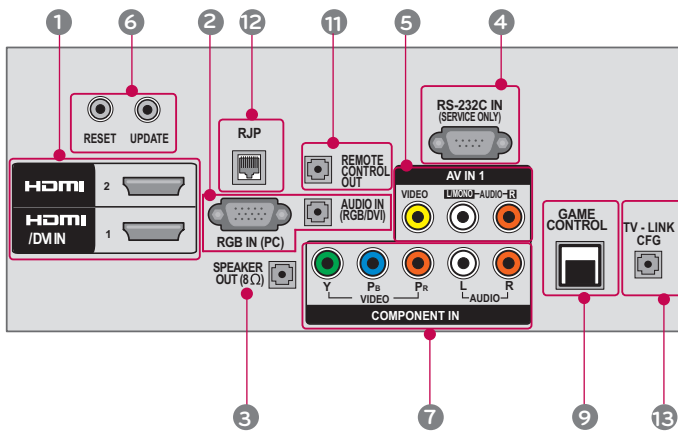

## 32/37/42LD340H, 32/37/42LD345H

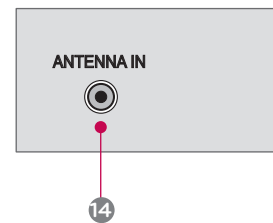
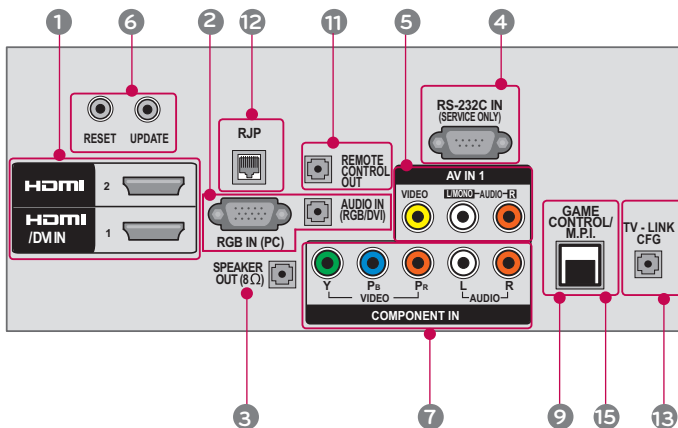

# PREPARATION

PREPARATION

## 32/37LD310H

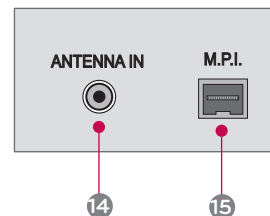
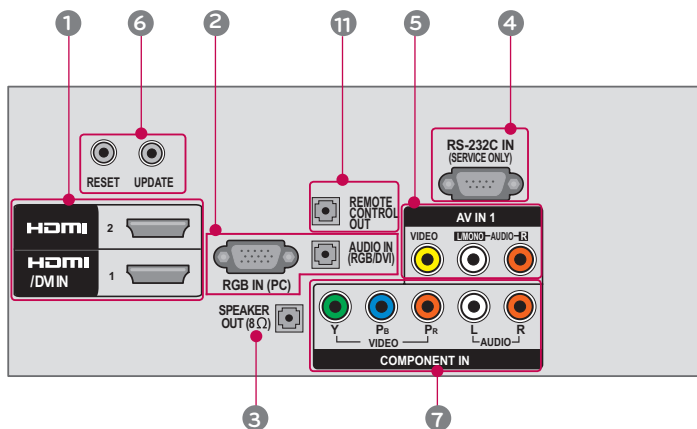

## 32/37LD330H

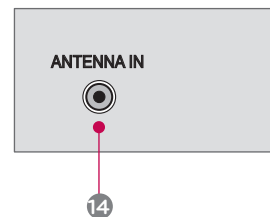
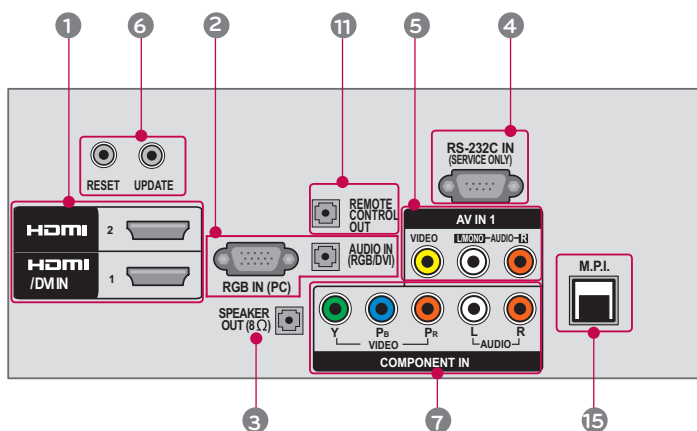

## 26LD320H, 26LD340H, 26LD345H

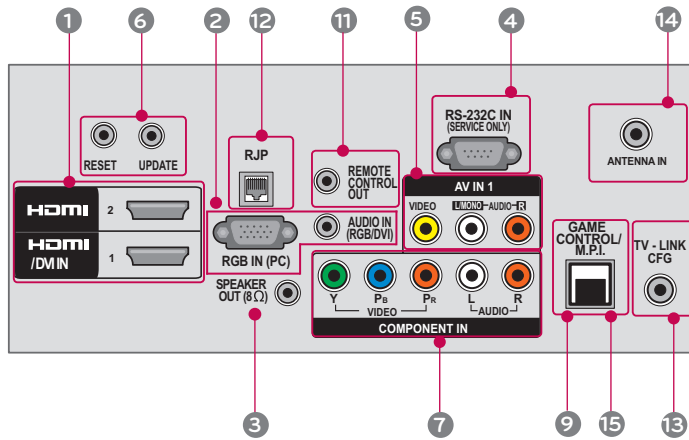

### 1 HDMI/DVI IN, HDMI IN

Digital Connection.

Supports HD video and Digital audio. Doesn't support 480i.

Accepts DVI video using an adapter or HDMI to DVI cable (not included).

### 2 RGB IN (PC)

Analog PC Connection. Uses a D-sub 15 pin cable (VGA cable).

### AUDIO IN (RGB/DVI)

0.32 cm (1/8 inch) headphone jack for analog PC audio input.

### 3 SPEAKER OUT (8Ω)

Connect to external speaker input.

### 4 RS-232C IN (SERVICE ONLY)

Used by third party devices.

This port is used for service or Hotel mode.

### 5 AV (Audio/Video) IN

Analog composite connection. Supports standard definition video only (480i).

### 6 UPDATE

Enables/disables software downloads and debug mode.

### RESET

Performs a hardware reset.

### 7 COMPONENT IN

Analog Connection.

Supports HD.

Uses a red, green, and blue cable for video & red and white for audio.

### 8 USB INPUT

Used for viewing videos, photos and listening to MP3s.

### 9 GAME CONTROL

Control port

### 10 Power Cord Socket

For operation with AC power.

Caution: Never attempt to operate the TV on DC power.

### 11 REMOTE CONTROL OUT

IR output for controlling an auxiliary device.

### 12 RJP (REMOTE JACK PACK PORT)

Connect to remote jack pack control output port.

### 13 TV - LINK CFG

Used for FTG Configuration

### 14 ANTENNA IN

Connect over the air signals th this jack.

### 15 M. P. I.

Control port.

# PREPARATION

## STAND INSTRUCTIONS

- Image shown may differ from your TV.

PREPARATION

### INSTALLATION

- Carefully place the TV screen side down on a cushioned surface to protect the screen from damage.

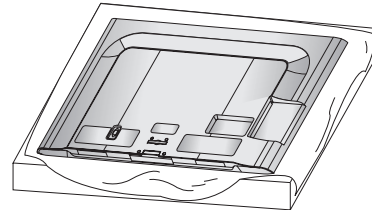

- Assemble the parts of the STAND BODY with the STAND BASE of the TV. (Except 32/37LD310H, 32/37LD330H)

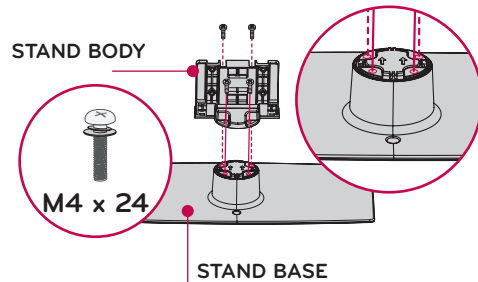

- Assemble the TV as shown.

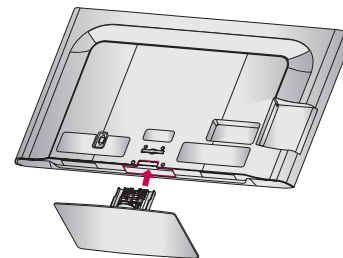

- Tighten the stand with the four screws (provided as parts of the TV).



or

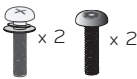

- Tighten the two of these four screws and the two Torx plus star head screws (provided as parts of the TV) to secure the TV. Tighten the two Torx plus star head screws with a star head driver bit (not provided as parts of the TV).

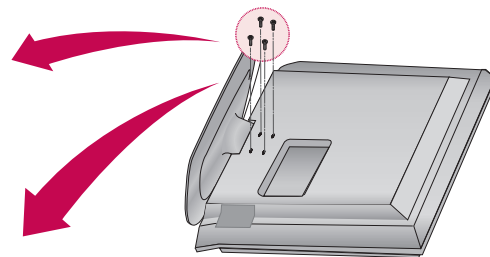

### NOTE

- When assembling the desk type stand, make sure the screws are fully tightened (If not tightened fully, the TV can tilt forward after the product installation). Do not over tighten.

- Image shown may differ from your TV.

## DETACHMENT

- 1 Carefully place the TV screen side down on a cushioned surface to protect the screen from damage.

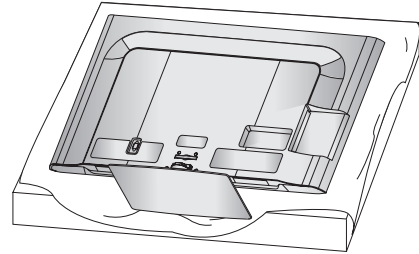

- 2 Remove the screws from the TV.

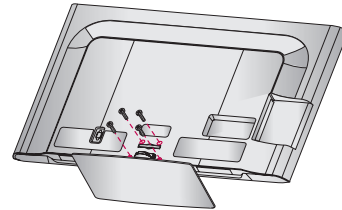

- 3 Detach the stand from TV.

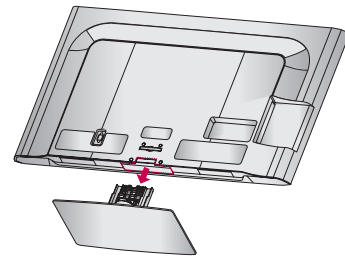

## PROTECTION COVER

After removing the stand, install the included **PROTECTION COVER** over the hole for the stand.

Press the **PROTECTION COVER** into the TV until you hear it click.

When installing the wall mounting bracket, use the **PROTECTION COVER**.

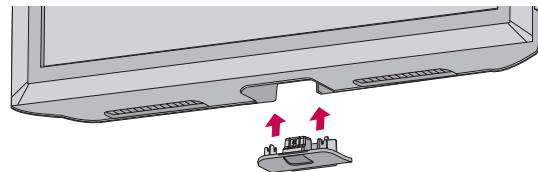

# PREPARATION

## VESA WALL MOUNTING

Install your wall mount on a solid wall perpendicular to the floor. When attaching to other building materials, please contact your nearest installer.

If installed on a ceiling or slanted wall, it may fall and result in severe personal injury.

We recommend that you use an LG brand wall mount when mounting the TV to a wall.

LG recommends that wall mounting be performed by a qualified professional installer.

PREPARATION

Model	VESA (A * B) 	Standard Screw	Quantity	Wall Mounting Bracket (sold separately)
26LD320H, 32LD320H, 32LD325H, 32LD310H, 26LD340H, 32LD340H, 26LD345H, 32LD345H, 32LD330H	200 * 100	M4	4	LSW100B, LSW100BG 
37LD320H, 42LD320H, 37LD325H, 37LD310H, 37LD340H, 42LD340H, 37LD345H, 42LD345H, 37LD330H	200 * 200	M6	4	LSW200B, LSW200BG 

### NOTE

- ▶ Screw length needed depends on the wall mount used. For further information, refer to the instructions included with the mount.
- ▶ Standard dimensions for wall mount kits are shown in the table.
- ▶ When purchasing our wall mount kit, a detailed installation manual and all parts necessary for assembly are provided.
- ▶ Do not use screws longer than the standard dimension, as they may cause damage to the inside to the TV.
- ▶ For wall mounts that do not comply with the VESA standard screw specifications, the length of the screws may differ depending on their specifications.
- ▶ Do not use screws that do not comply with the VESA standard screw specifications. Do not use fasten the screws too strongly, this may damage the TV or cause the TV to a fall, leading to personal injury. LG is not liable for these kinds of accidents.
- ▶ LG is not liable for TV damage or personal injury when a non-VESA or non specified wall mount is used or the consumer fails to follow the TV installation instructions.

### CAUTION

- ▶ Do not install your wall mount kit while your TV is turned on. It may result in personal injury due to electric shock.



# CABLE MANAGEMENT

■ Image shown may differ from your TV.

- 1 Connect the cables as necessary.  
 To connect additional equipment, see the **EXTERNAL EQUIPMENT SETUP** section.  
 Secure the power cord with the **PROTECTIVE BRACKET/SCREW** or the **POWER CORD HOLDER**.  
 It will help prevent the power cable from being removed by accident.

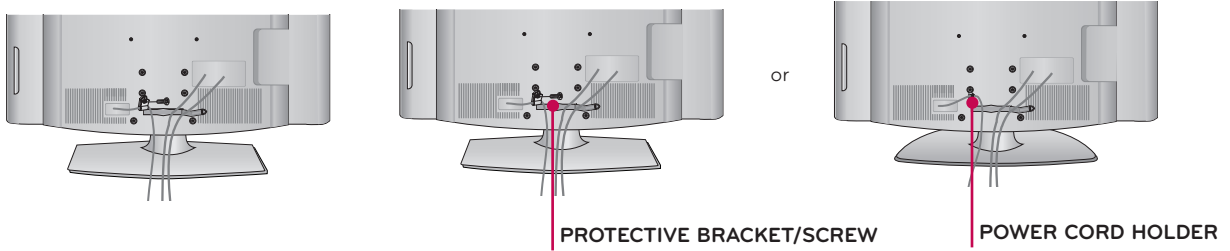

- 2 Install the **CABLE MANAGEMENT CLIP** as shown. If your TV has the **CABLE HOLDER**, install it as shown and bundle the cables.

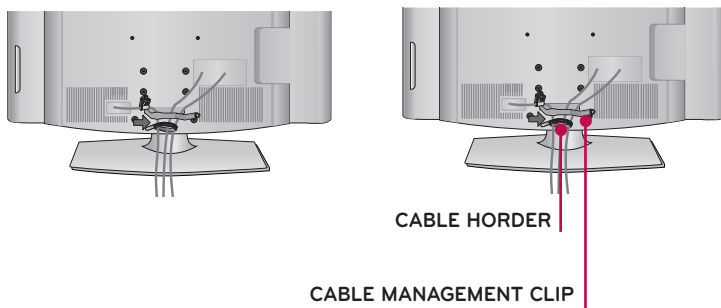

- 3 Put the cables inside the **CABLE MANAGEMENT CLIP** and snap it closed.

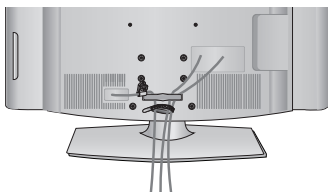

# PREPARATION

## DESKTOP PEDESTAL INSTALLATION

- Image shown may differ from your TV.

For proper ventilation, allow a clearance of 10.1 cm (4 inch) on all four sides from the wall.

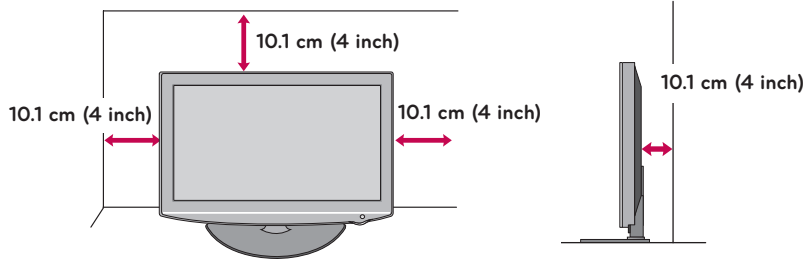

### ⚠ CAUTION

- ▶ Ensure adequate ventilation by following the clearance recommendations.
- ▶ Do not mount near or above any type of heat source.

## SWIVEL STAND

After installing the TV, you can adjust the TV set manually to the left or right direction by 90 ° to suit your viewing position.

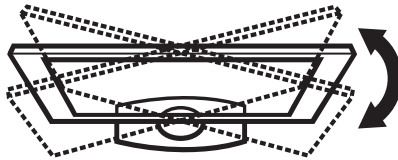

## KENSINGTON SECURITY SYSTEM

- This feature is not available for all models.
  - The TV is equipped with a Kensington Security System connector on the back panel. Connect the Kensington Security System cable as shown below.
  - For the detailed installation and use of the Kensington Security System, refer to the user's guide provided with the Kensington Security System.
- For further information, contact <http://www.kensington.com>, the internet homepage of the Kensington company. Kensington sells security systems for expensive electronic equipment such as notebook PCs and LCD projectors.
- NOTE: The Kensington Security System is an optional accessory.

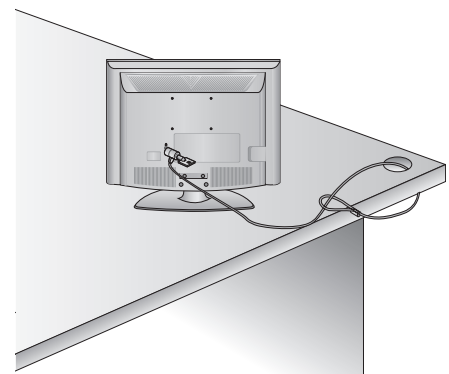

## ATTACHING THE TV TO A DESK

- Image shown may differ from your TV.

The TV must be attached to a desk so it cannot be pulled in a forward/backward direction, potentially causing injury or damaging the product.

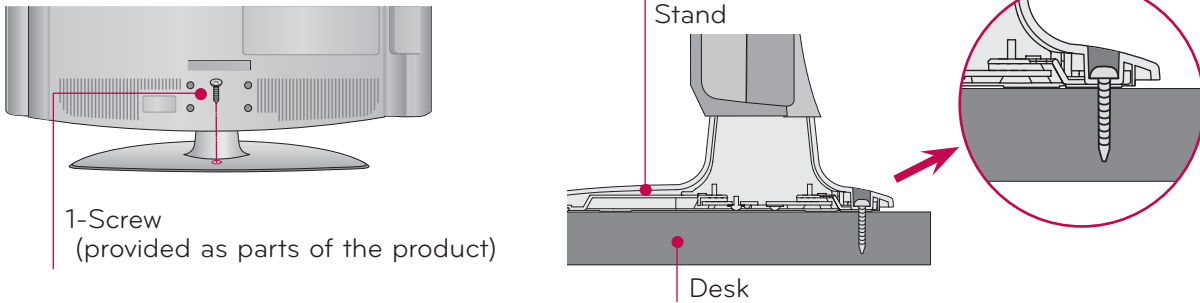

26/32/37/42LD320H, 26/32/37/42LD340H, 26/32/37/42LD345H, 32/37LD325H

TYPE 1

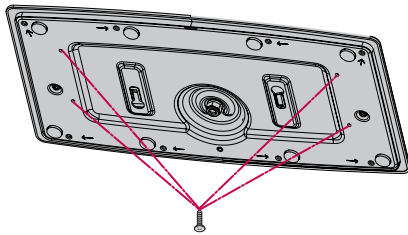

4-Screws  
(not provided as parts of the product)

(For TYPE 1)

- ▶ Screw: M5 x L (\*L: Table depth + 8~10 mm)  
ex) Table depth: 15mm, Screw: M5 x 25

TYPE 2

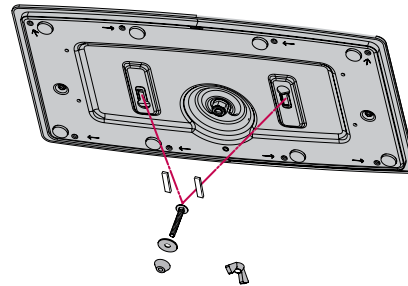

2-Screws, 2-Washers, 2-Nuts,  
4-Rubbers  
(provided as parts of the product)

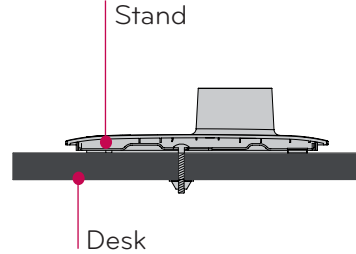
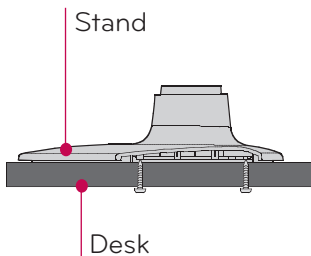

- ▶ You can select any type of attachment (Type 1 or Type 2).
- ▶ Do not over tighten.

# PREPARATION

PREPARATION

## 32/37LD310H, 32/37LD330H

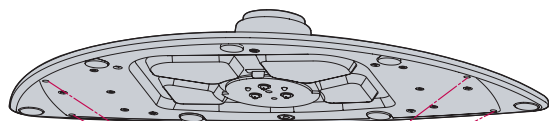

4-Screws  
(not provided as parts  
of the product)

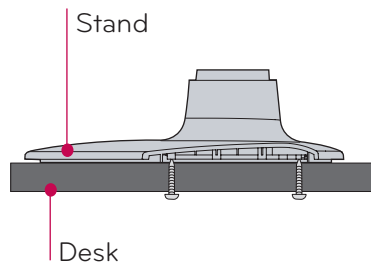

► Screw: M5 x L (\*L: Table depth + 8~10 mm) ex) Table depth: 15mm, Screw: M5 x 25

### **⚠ WARNING**

► To prevent TV from falling over, the TV should be securely attached to the floor/wall per installation instructions. Tipping, shaking, or rocking the machine may cause injury.

# SECURING THE TV TO THE WALL TO PREVENT FALLING WHEN THE TV IS USED ON A STAND

- You should purchase necessary components to prevent the TV from tipping over (when not using a wall mount).
- Image shown may differ from your TV.

We recommend that you set up the TV close to a wall so it cannot fall over if pushed backwards. Additionally, we recommend that the TV be attached to a wall so it cannot be pulled in a forward direction, potentially causing injury or damaging the product.

Caution: Please make sure that children don't climb on or hang from the TV.

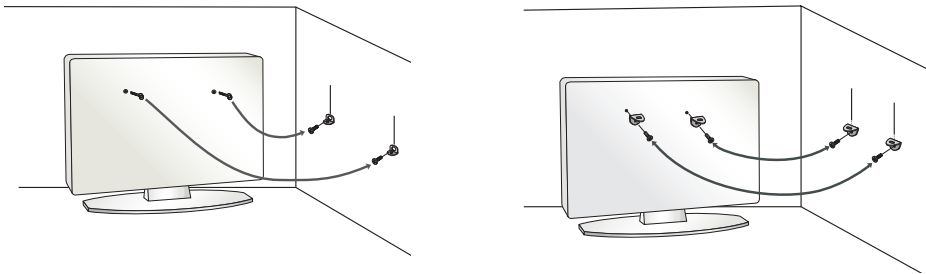

- Insert the eye-bolts (or TV brackets and bolts) to tighten the product to the wall as shown in the picture.

\* If your product has the bolts in the eye-bolts position before inserting the eye-bolts, loosen the bolts.

\* Insert the eye-bolts or TV brackets/bolts and tighten them securely in the upper holes.

Secure the wall brackets with the bolts (sold separately) to the wall. Match the height of the bracket that is mounted on the wall to the holes in the product.

Ensure the eye-bolts or brackets are tightened securely.

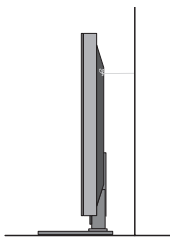

- Use a sturdy rope (sold separately) to tie the product. It is safer to tie the rope so it becomes horizontal between the wall and the product.

## NOTE

- ▶ Use a platform or cabinet strong enough and large enough to support the size and weight of the TV.
- ▶ To use the TV safely make sure that the height of the bracket on the wall and the one on the TV are the same.

# PREPARATION

- To prevent damage do not connect to the power outlet until all connections are made between the devices.
- Image shown may differ from your TV.

## ANTENNA OR CABLE CONNECTION

### 1. Antenna (Analog or Digital)

Wall Antenna Socket or Outdoor Antenna without a Cable Box Connections.

For optimum picture quality, adjust antenna direction if needed.

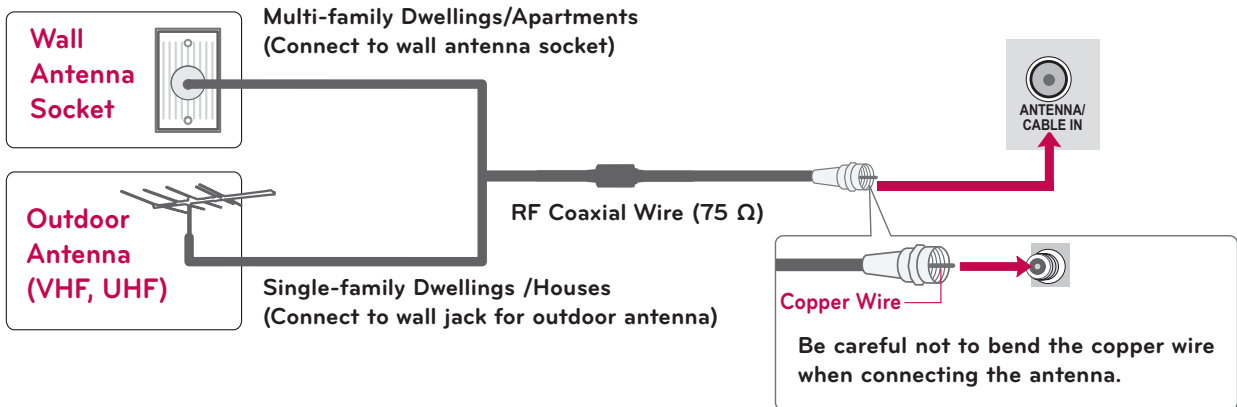

### 2. Cable

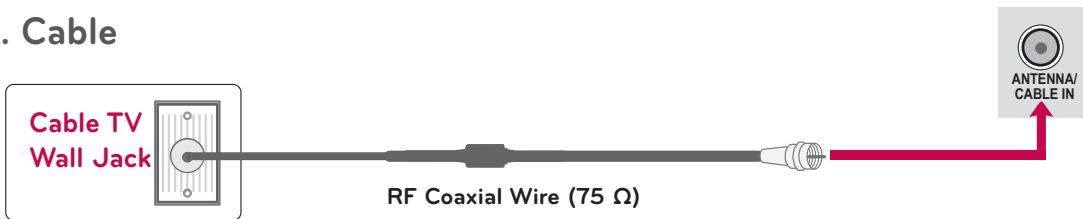

- If the antenna needs to be split for two TV's, install a 2-Way Signal Splitter.
- For much more information about antennas visit our Knowledgebase at <http://lgknowledgebase.com>. Search for antenna.

# EXTERNAL EQUIPMENT SETUP

- To prevent the equipment damage, never plug in any power cords until you have finished connecting all equipment.
- This part of EXTERNAL EQUIPMENT SETUP mainly use picture of for 32/37/42LD320H.

## HD RECEIVER SETUP

This TV can receive digital over-the-air/digital cable signals without an external digital set-top box. However, if you do receive digital signals from a digital set-top box or other digital external device.

## Component Connection

### 1. How to connect

- 1 Connect the video outputs (Y, PB, PR) of the digital set-top box to the **COMPONENT IN VIDEO** jacks on the TV. Match the jack colors (Y = green, PB = blue, and PR = red).
- 2 Connect the audio output of the digital set-top box to the **COMPONENT IN AUDIO** jacks on the TV.

### 2. How to use

- Turn on the digital set-top box.  
(Refer to the owner's manual for the digital set-top box operation.)
- Select the **Component** input source on the TV using the **INPUT** button on the remote control.

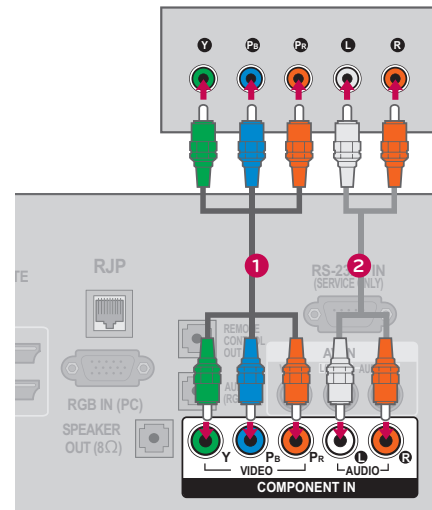

Y, CB/PB, CR/PR

Resolution	Horizontal Frequency(kHz)	Vertical Frequency(Hz)
720x480i	15.73	59.94
	15.73	60.00
720x480p	31.47	59.94
	31.50	60.00
1280x720p	44.96	59.94
	45.00	60.00
1920x1080i	33.72	59.94
	33.75	60.00
1920x1080p	26.97	23.976
	27.00	24.00
	33.71	29.97
	33.75	30.00
	67.432	59.94
	67.50	60.00

# EXTERNAL EQUIPMENT SETUP

## HDMI Connection

### 1. How to connect

- 1 Connect the digital set-top box to **HDMI/DVI IN 1** or **HDMI 2** jack on the TV.
- 2 No separate audio connection is necessary. HDMI supports both audio and video.

### 2. How to use

- Turn on the digital set-top box.  
(Refer to the owner's manual for the digital set-top box.)
- Select the **HDMI1** or **HDMI2** input source on the TV using the **INPUT** button on the remote control.

#### NOTE

- ▶ If an HDMI cable doesn't support High Speed HDMI, it can cause flickers or no screen display. In this case use the latest cables that support High Speed HDMI.
- ▶ HDMI Audio Supported Format: Dolby Digital (32 kHz, 44.1 kHz, 48 kHz), Linear PCM (32 kHz, 44.1 kHz, 48 kHz)

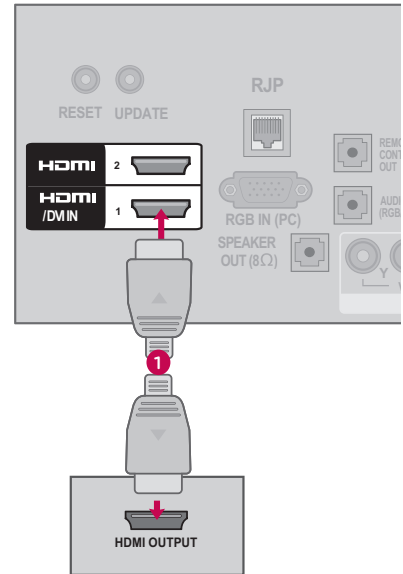

### HDMI-DTV

Resolution	Horizontal Frequency(kHz)	Vertical Frequency(Hz)
720x480p	31.47	59.94
	31.50	60.00
1280x720p	44.96	59.94
	45.00	60.00
1920x1080i	33.72	59.94
	33.75	60.00
1920x1080p	26.97	23.976
	27.00	24.00
	33.71	29.97
	33.75	30.00
	67.432	59.939
	67.50	60.00



## DVI to HDMI Connection

### 1. How to connect

- 1 Connect the DVI output of the digital set-top box to the **HDMI/DVI IN 1** jack on the TV.
- 2 Connect the digital set-top box audio output to the **AUDIO IN (RGB/DVI)** jack on the TV.

### 2. How to use

- Turn on the digital set-top box.  
(Refer to the owner's manual for the digital set-top box.)
- Select the **HDMI** input source on the TV using the **INPUT** button on the remote control.

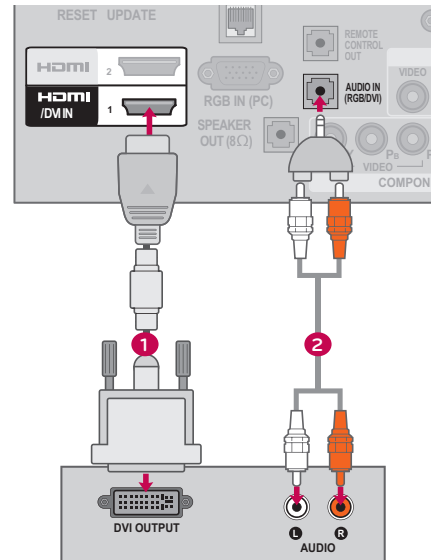

#### NOTE

- ▶ A DVI to HDMI cable or adapter is required for this connection. DVI doesn't support audio, so a separate audio connection is necessary.

# EXTERNAL EQUIPMENT SETUP

## DVD SETUP

### Component Connection

#### 1. How to connect

- 1 Connect the video outputs (Y, PB, PR) of the DVD to the **COMPONENT IN VIDEO** jacks on the TV. Match the jack colors (Y = green, PB = blue, and PR = red).
- 2 Connect the audio outputs of the DVD to the **COMPONENT IN AUDIO** jacks on the TV.

#### 2. How to use

- Turn on the DVD player, insert a DVD.
- Select the **Component** input source on the TV using the **INPUT** button on the remote control.
- Refer to the DVD player's manual for operating instructions.

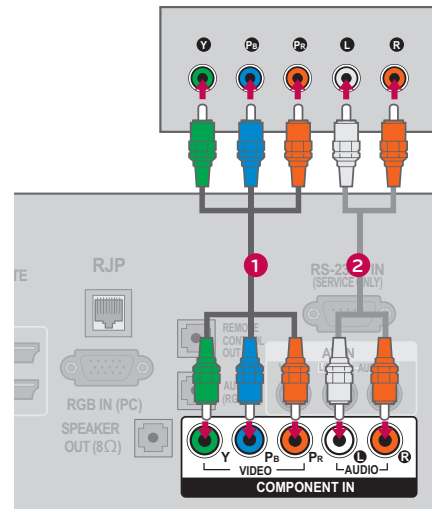

#### Component Input ports

To get better picture quality, connect a DVD player to the component input ports as shown below.

Component ports on the TV	Y	P <sub>B</sub>	P <sub>R</sub>
Video output ports on DVD player	Y	B-Y	R-Y
	Y	C <sub>b</sub>	C <sub>r</sub>
	Y	P <sub>b</sub>	P <sub>r</sub>

## Composite (RCA) Connection

### 1. How to connect

- 1 Connect the **AUDIO/VIDEO** jacks between TV and DVD. Match the jack colors (Video = yellow, Audio Left = white, and Audio Right = red)

### 2. How to use

- Turn on the DVD player, insert a DVD.
- Select the **AV1** or **AV2** input source on the TV using the **INPUT** button on the remote control.
- Refer to the DVD player's manual for operating instructions.

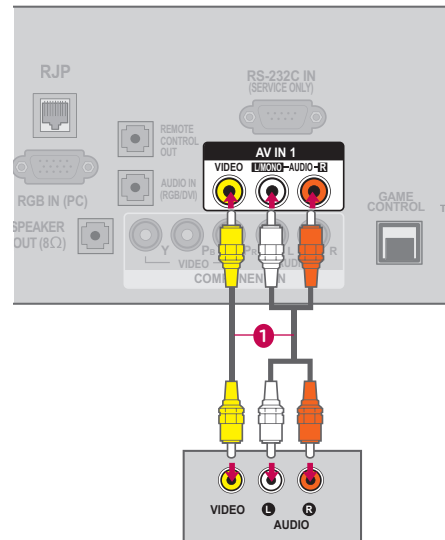

## HDMI Connection

### 1. How to connect

- 1 Connect the HDMI output of the DVD to the **HDMI/DVI IN 1** or **HDMI 2** jack on the TV.
- 2 No separate audio connection is necessary. HDMI supports both audio and video.

### 2. How to use

- Select the **HDMI1** or **HDMI2** input source on the TV using the **INPUT** button on the remote control.
- Refer to the DVD player's manual for operating instructions.

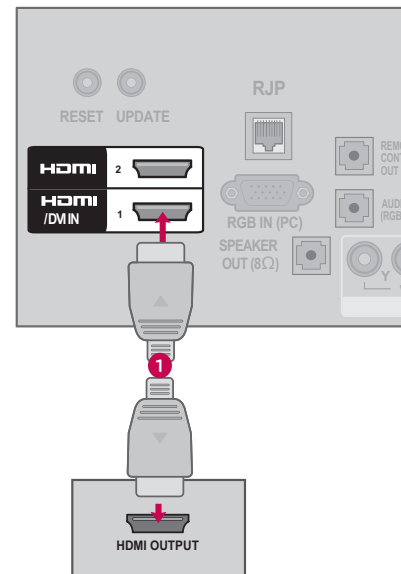

### NOTE

- ▶ If an HDMI cable doesn't support High Speed HDMI, it can cause flickers or no screen display. In this case use the latest cables that support High Speed HDMI.
- ▶ HDMI Audio Supported Format: Dolby Digital (32 kHz, 44.1 kHz, 48 kHz), Linear PCM (32 kHz, 44.1 kHz, 48 kHz)

# EXTERNAL EQUIPMENT SETUP

## VCR SETUP

### Antenna Connection

#### 1. How to connect

- 1 Connect the RF antenna out socket of the VCR to the **ANTENNA/ CABLE IN** socket on the TV.
- 2 Connect the antenna cable to the RF antenna in socket of the VCR.

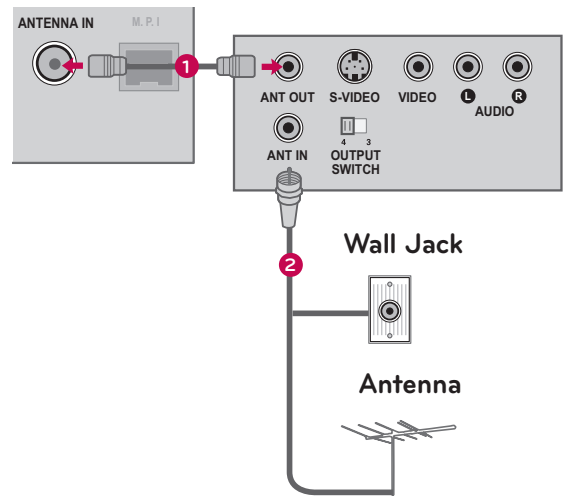

#### 2. How to use

- Set VCR output switch to 3 or 4 and then tune TV to the same channel number.
- Insert a video tape into the VCR and press PLAY on the VCR (Refer to the VCR owner's manual).

### Composite (RCA) Connection

#### 1. How to connect

- 1 Connect the **AUDIO/VIDEO** jacks between TV and VCR. Match the jack colors (Video = yellow, Audio Left = white, and Audio Right = red)

#### 2. How to use

- Insert a video tape into the VCR and press PLAY on the VCR. (Refer to the VCR owner's manual.)
- Select the **AV1** or **AV2** input source on the TV using the **INPUT** button on the remote control.

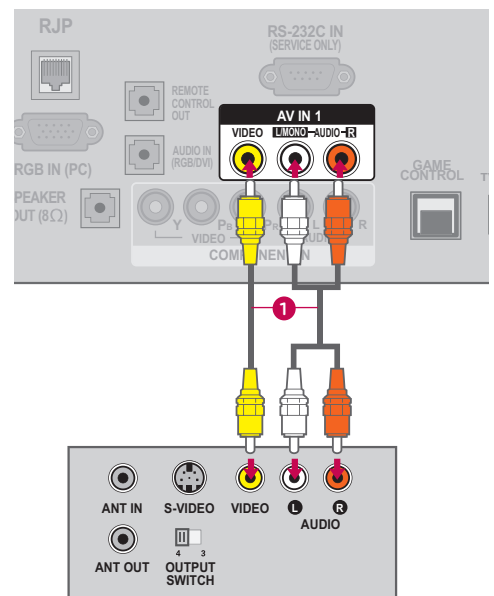

#### NOTE

- ▶ If you have a mono VCR, connect the audio cable from the VCR to the **AUDIO L(MONO)** jack of the TV.

# OTHER A/V SOURCE SETUP

## 1. How to connect

- 1 Connect the **AUDIO/VIDEO** jacks between TV and external equipment. Match the jack colors. (Video = yellow, Audio Left = white, and Audio Right = red)

## 2. How to use

- Select the **AV1** or **AV2** input source on the TV using the **INPUT** button on the remote control.
- Operate the corresponding external equipment.

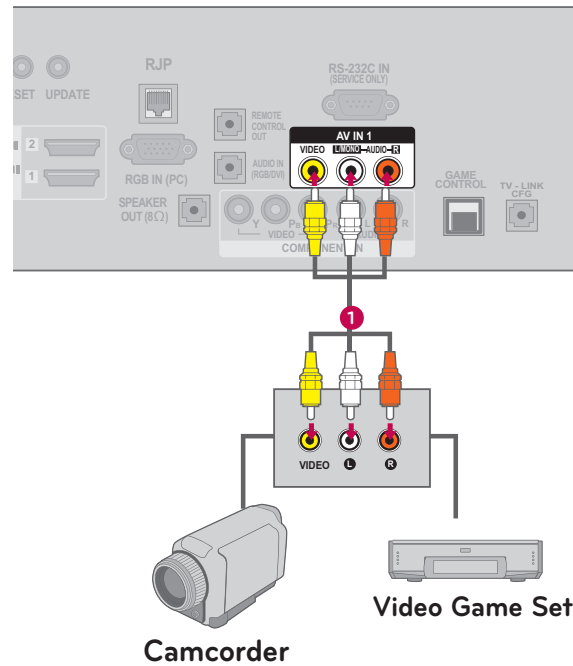

# EXTERNAL EQUIPMENT SETUP

## USB CONNECTION

### 1. How to connect

- 1 Connect the USB device to the **USB IN** jack on the side of TV.

### 2. How to use

- After connecting the **USB IN** jack, you use the USB function.

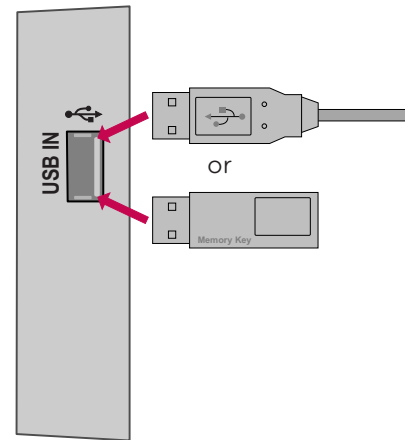

# PC SETUP

## VGA (D-Sub 15 Pin) Connection

### 1. How to connect

- 1 Connect the VGA output of the PC to the **RGB IN (PC)** jack on the TV.
- 2 Connect PC audio output to the **AUDIO IN (RGB/DVI)** jack on the TV.

### 2. How to use

- Turn on the PC and the TV.
- Select the **RGB-PC** input source on the TV using the **INPUT** button on the remote control.

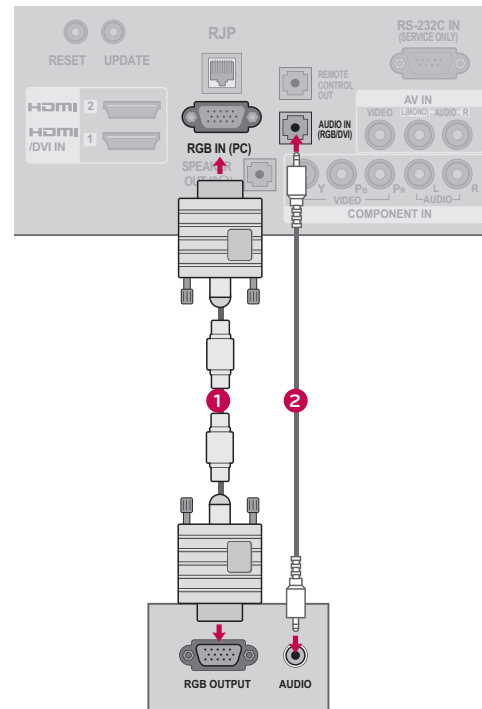

# EXTERNAL EQUIPMENT SETUP

## DVI to HDMI Connection

### 1. How to connect

- 1 Connect the DVI output of the PC to the **HDMI/DVI IN 1** jack on the TV.
- 2 Connect the PC audio output to the **AUDIO IN (RGB/DVI)** jack on the TV.

### 2. How to use

- Turn on the PC and the TV.
- Select the **HDMI1** input source on the TV using the **INPUT** button on the remote control.

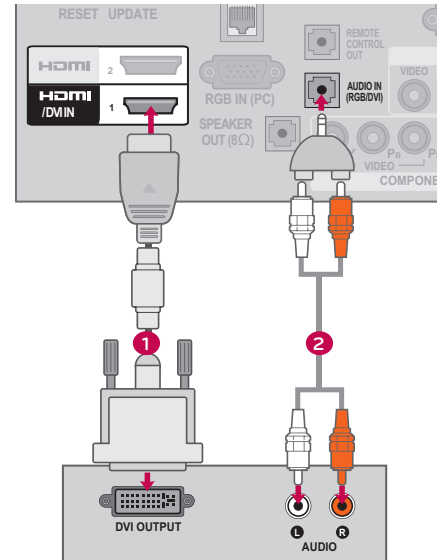



**NOTE**

- ▶ To get the the best picture quality, adjust the PC graphics card to **1920 x 1080** (Other models), **1360 x 768** (26/32LD320H, 32LD325H, 26/32LD340H, 26/32LD345H, 32LD310H, 32LD330H).
- ▶ Depending on the graphics card, DOS mode may not work if a HDMI to DVI Cable is in use.
- ▶ In PC mode, there may be noise associated with the resolution, vertical pattern, contrast or brightness. If noise is present, change the PC output to another resolution, change the refresh rate to another rate or adjust the brightness and contrast on the PICTURE menu until the picture is clear.
- ▶ Avoid keeping a fixed image on the screen for a long period of time. The fixed image may become permanently imprinted on the screen.
- ▶ The synchronization input form for Horizontal and Vertical frequencies is separate.
- ▶ Depending on the graphics card, some resolution settings may not allow the image to be positioned on the screen properly.
- ▶ When selecting HDMI-PC, set the "Input Label - PC" in the OPTION menu.

**Supported Display Specifications (RGB-PC, HDMI-PC)**

Resolution	Horizontal Frequency(kHz)	Vertical Frequency(Hz)
640x350	31.468	70.09
720x400	31.469	70.08
640x480	31.469	59.94
800x600	37.879	60.31
1024x768	48.363	60.00
1280x768	47.776	59.87
1360x768	47.712	60.015
1280x1024	63.981	60.02
1600x1200	75.00	60.00
1920x1080 RGB-PC	66.587	59.934
1920x1080 HDMI-PC	67.50	60.00

Except 26/32LD320H, 32LD325H, 26/32LD340H, 26/32LD345H, 32LD310H, 32LD330H

# EXTERNAL EQUIPMENT SETUP

## Screen Setup for PC mode







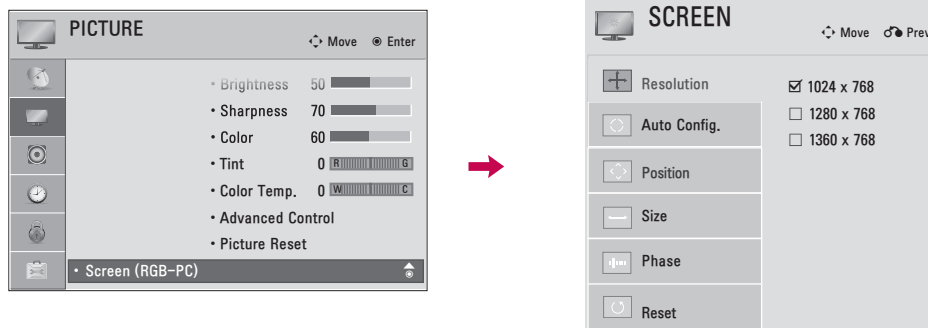

### Selecting Resolution

You can choose the resolution in RGB-PC mode.

The Position, Phase, and Size can also be adjusted.

You can choose this option only when the PC resolution is set to 1024X768, 1280X768 or 1360X768.









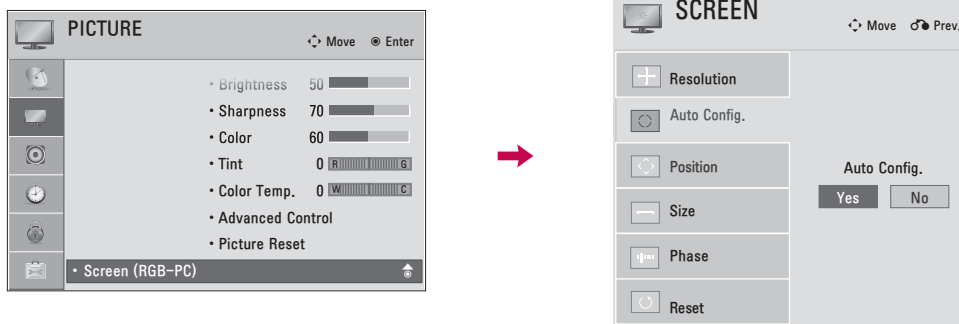

- 1   Select **PICTURE**.
- 2   Select **Screen (RGB-PC)**.
- 3   Select **Resolution**.
- 4   Select the desired resolution.
- 5 

## Auto Configure

Automatically adjusts picture position and minimizes image instability. After adjustment, if the image is still not correct, try using the manual settings or a different resolution or refresh rate on the PC.



- 1   Select **PICTURE**.
- 2   Select **Screen (RGB-PC)**.
- 3   Select **Auto Config..**
- 4   Select **Yes**.
- 5  Start Auto Configuration.







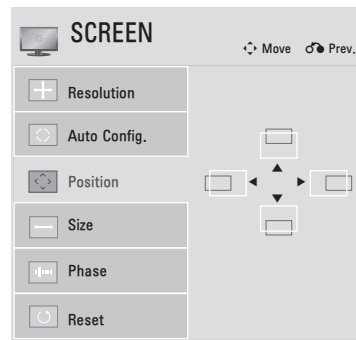
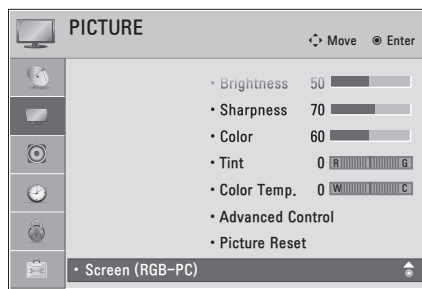

- If the position of the image is still not correct, try Auto adjustment again.
- If picture needs to be adjusted again after Auto adjustment in RGB-PC, you can adjust the **Position**, **Size** or **Phase**.

# EXTERNAL EQUIPMENT SETUP

## Adjustment for screen Position, Size, and Phase

If the picture is not clear after auto adjustment or if text is shaking, adjust the picture phase manually. This feature operates only in RGB-PC mode.











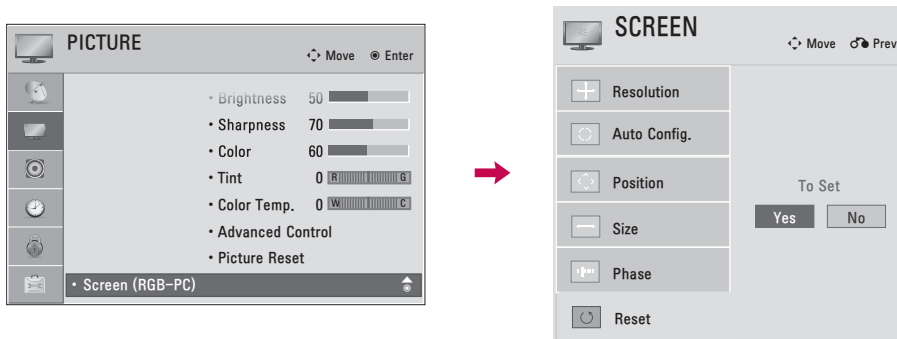

-   Select **PICTURE**.
-   Select **Screen (RGB-PC)**.
-   Select **Position, Size, or Phase**.
-   Make appropriate adjustments.
- 

- **Position:** This function is to adjust picture to left/right and up/down as you prefer.
- **Size:** This function is to minimize any vertical bars or stripes visible on the screen background. And the horizontal screen size will also change.
- **Phase:** This function allows you to remove any horizontal noise and clear or sharpen the image of characters.

## Screen Reset (Reset to original initial values)

Returns **Position**, **Size**, and **Phase** to the default initial settings.  
This feature operates only in RGB-PC mode.



- 1   Select **PICTURE**.
- 2   Select **Screen (RGB-PC)**.
- 3   Select **Reset**.
- 4   Select **Yes**.
- 5  Start **Reset**.

# WATCHING TV / CHANNEL CONTROL

## REMOTE CONTROL FUNCTIONS

When using the remote control, aim it at the remote control sensor on the TV.  
The remote control may differ from the images below.

<b>POWER</b>	Turns the TV on from standby or off to standby.
<b>ALARM</b>	Set the time that the TV will automatically turn itself on.
<b>TIMER</b>	Select the amount of time before your TV turns off automatically.
<b>INPUT</b>	Rotates through inputs. Also switches the TV on from standby.
<b>TV</b>	Returns to the last TV channel.

<b>NUMBER button</b>	
<b>- (DASH)</b>	Used to enter a program number for multiple program channels such as 2-1, 2-2, etc.
<b>FLASHBK</b>	Tunes to the last channel viewed.

<b>MENU</b>	Displays the main menu or clears all on-screen displays and return to TV viewing.
<b>SAP</b>	Analog mode: Selects MTS sound (Mono, Stereo, or a SAP) DTV mode: Changes the audio language.
<b>CC</b>	Select a closed caption.
<b>THUMBSTICK (Up/Down/Left Right/ENTER)</b>	Navigates the on-screen menus and adjusts the system settings to your preference.
<b>RETURN</b>	Allows the user to move return one step in an interactive application or other user interaction function.
<b>GUIDE</b>	Show Channel schedule.
<b>EXIT</b>	Clears all on-screen displays and return to TV viewing.

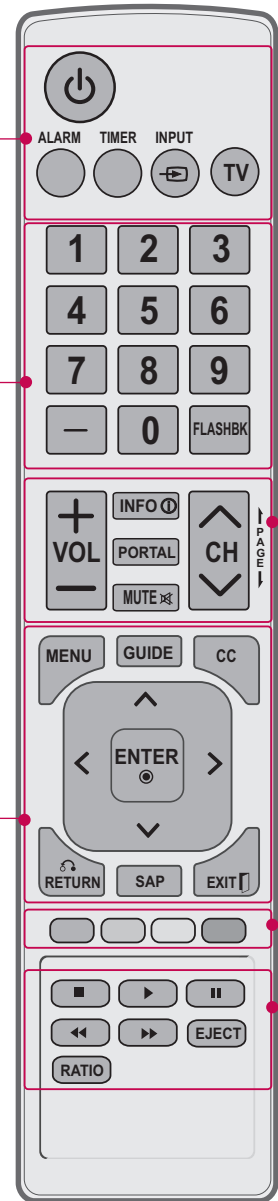

**VOLUME UP/DOWN**

Adjusts the volume.

**INFO**

Displays channel information at the bottom of the screen.

**PORTAL**

Displays and removes the hotel interactive menu.

**MUTE**

Switches the sound on or off.

**CHANNEL UP/DOWN**

Changes the channel.

**PAGE UP/DOWN**

Moves from one full set of screen information to the next one.

**COLOR BUTTON**

Access special functions in some menus.

**VCR/DVD**

Control video cassette recorders or DVD players.

**control buttons****EJECT**

Eject the USB device.

**RATIO**

Change the aspect ratio.

## Installing Batteries

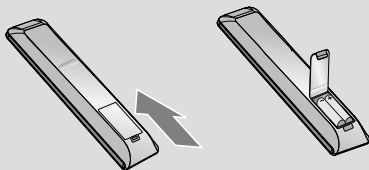

- Open the battery compartment cover on the back side and install the batteries matching correct polarity.
- Install two 1.5V AAA batteries. Don't mix old or used batteries with new ones.
- Close cover.

# WATCHING TV / CHANNEL CONTROL

## TURNING ON THE TV

- 1 First, connect power cord correctly.  
At this moment, the TV switches to standby mode.
  - In standby mode to turn TV on, press the **⏻ / I** button on the TV or press the **⏻ (POWER)** button on the remote control.
- 2 Select the viewing source by using the **INPUT** button on the remote control.
- 3 When finished using the TV, press the **⏻ (POWER)** button on the remote control. The TV reverts to standby mode.

### NOTE

- ▶ If you intend to be away on vacation, disconnect the power plug from the wall power outlet.

## CHANNEL SELECTION

- 1 Press the **CH (▲ or ▼)** or **NUMBER** buttons to select a channel number.

## VOLUME ADJUSTMENT

Adjust the volume to suit your personal preference.

- 1 Press the **VOL (+ or -)** button to adjust the volume.
- 2 If you want to switch the sound off, press the **MUTE** button.
- 3 You can cancel the Mute function by pressing the **MUTE** or **VOL (+ or -)** button.





# ON-SCREEN MENUS SELECTION

Your TV's OSD (On Screen Display) may differ slightly from that shown in this manual.

**1**   Display each menu.

**2**   Select a menu item.

**3**  Accept the current selection.

**4**  Return to TV viewing.

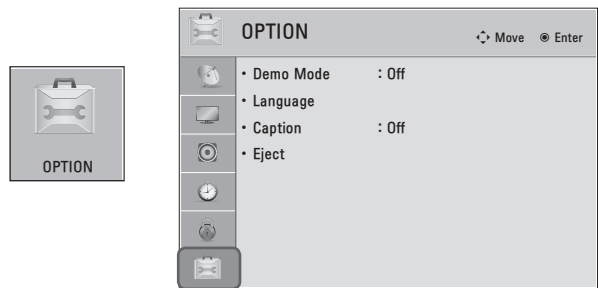
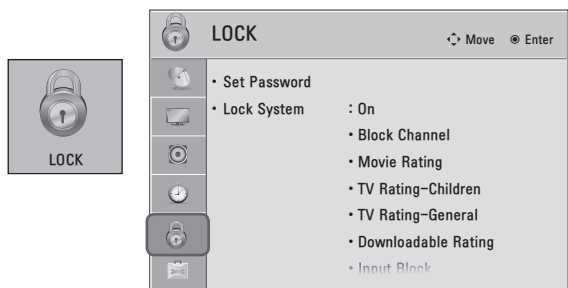
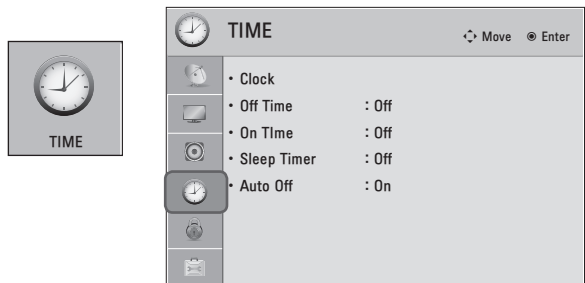
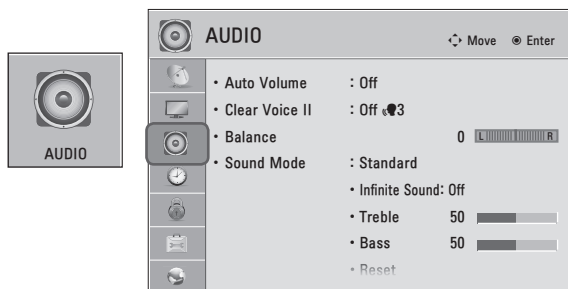
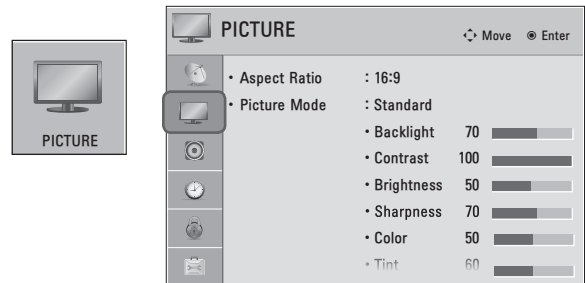
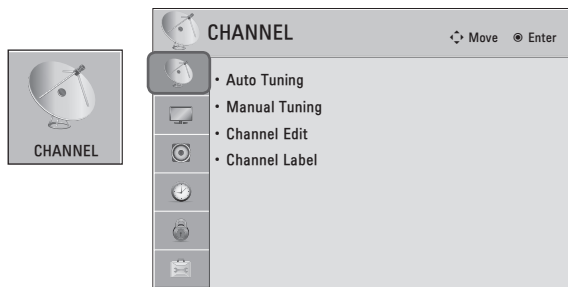

# WATCHING TV / CHANNEL CONTROL

WATCHING TV / CHANNEL CONTROL

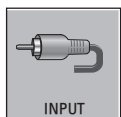

i.e)

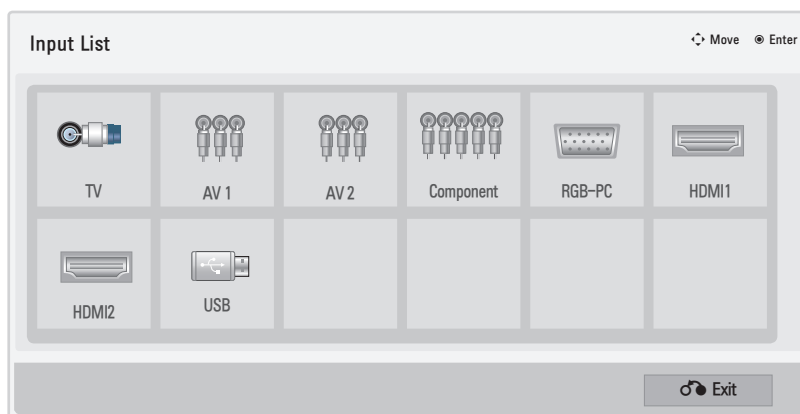

For LD320H, LD325H, LD310H series

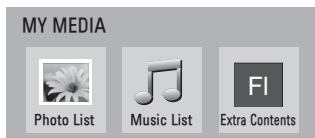

For LD340H, LD345H, LD330H series

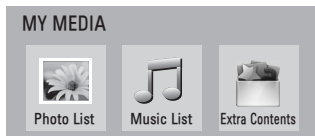







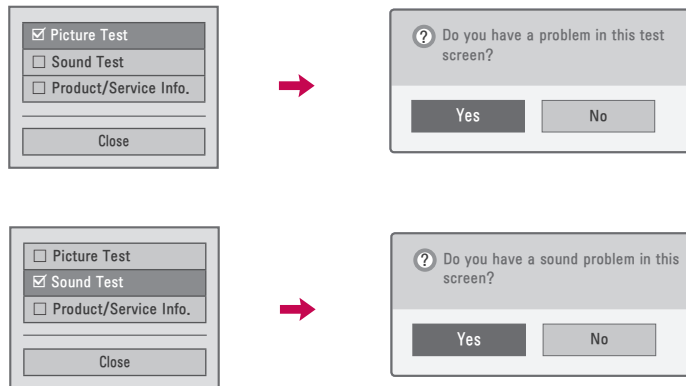

# CUSTOMER SUPPORT

## Picture Test / Sound Test

This function is a customer support function that can execute picture and sound tests.







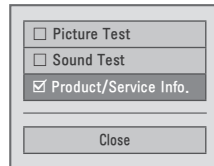

- 1   Select **Customer Support**.
- 2   Select **Picture Test** or **Sound Test**.
- 3   Select **Yes**.
- 4  Return to the previous menu.
-  Return to TV viewing.

# WATCHING TV / CHANNEL CONTROL

## Product/Service Info.

This function shows support and product information.  
Customer Service Center can differ by country.



-   Select **Customer Support**.
-   Select **Product/Service Info..**  
You can check the various product/Service information based on your model.
-  Return to the previous menu.
-  Return to TV viewing.

# CHANNEL SETUP







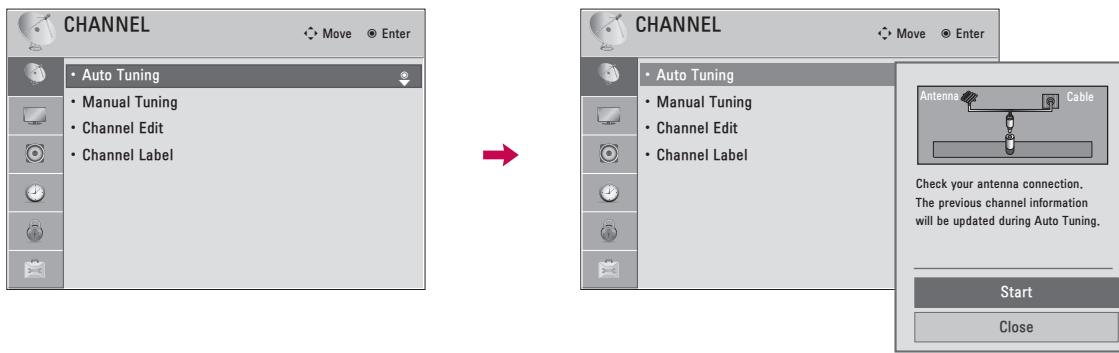

## Auto Scan (Auto Tuning)

Automatically finds all channels available through antenna or cable inputs, and stores them in memory on the channel list.

Run this function if you change your residence or move the TV.

Auto Tuning memorizes only the channels available at the time.











- 1   Select **CHANNEL**.
- 2   Select **Auto Tuning**.
- 3   Select **Start**.
- 4  Run **Auto tuning**.
- 5  Return to the previous menu.
-  Return to TV viewing.

# WATCHING TV / CHANNEL CONTROL

## Add/Delete Channel (Manual Tuning)

When selecting DTV or Cable DTV input signal in **Manual Tuning**, you can view the on-screen signal strength monitor to see the quality of the signal being received.

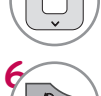
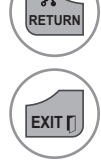

-   Select **CHANNEL**.
-   Select **Manual Tuning**.
-   Select **DIGITAL**, or **ANALOG**.
-   Select channel you want to add or delete.
-   Select **Add** or **Delete**.
-  Return to the previous menu.
-  Return to TV viewing.

- The TV will ask for a password if parental control has been activated (LOCK Menu). Use the password you set up in the LOCK Menu to allow a channel search.
- The maximum number of channels the TV can store is 900.

## Channel Editing

The channels in the Channel Edit List are displayed in black and the channels deleted from the Channel Edit List are displayed in blue.

When a channel number is deleted, it means that you will be unable to select it using CH  $\wedge$  V button during TV viewing. If you wish to select the deleted channel, directly enter the channel number with the NUMBER buttons or select it in the Channel Edit menu.

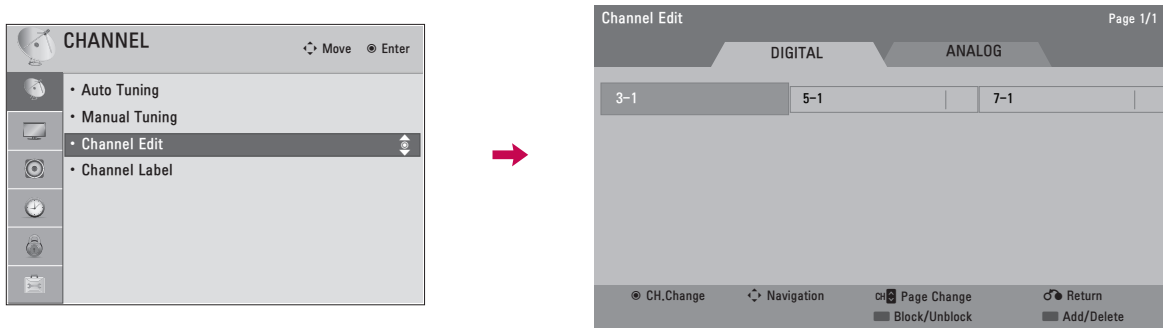

1   Select **CHANNEL**.

2   Select **Channel Edit**.

3   Select a channel.

4  Add or delete a channel.

Block or unblock the channel.

 You can block/unblock channels even if you select "Lock system-Off" in the LOCK menu.

 Switch to the chosen channel number.

 Move the pages when the channel list is too long.

5  Return to the previous menu.

 Return to TV viewing.

# WATCHING TV / CHANNEL CONTROL

## INPUT LIST

Only these input signals which are connected to a TV can be activated and selected.

ie)

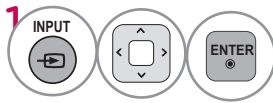
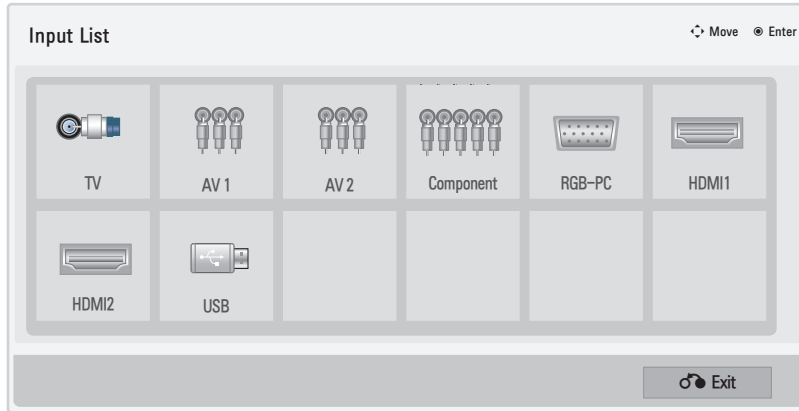

Select the desired input source.

- **TV:** Select it to watch over-the-air, cable and digital cable broadcasts.
- **AV:** Select them to watch a VCR or other external equipment.
- **Component:** Select them to watch DVD or a Digital set-top box.
- **RGB-PC:** Select it to view PC input.
- **HDMI:** Select them to watch high definition devices.



# EXAMPLE ELECTRONIC PROGRAM GUIDE

This is an example of a typical TV electronic program guide showing available programming.

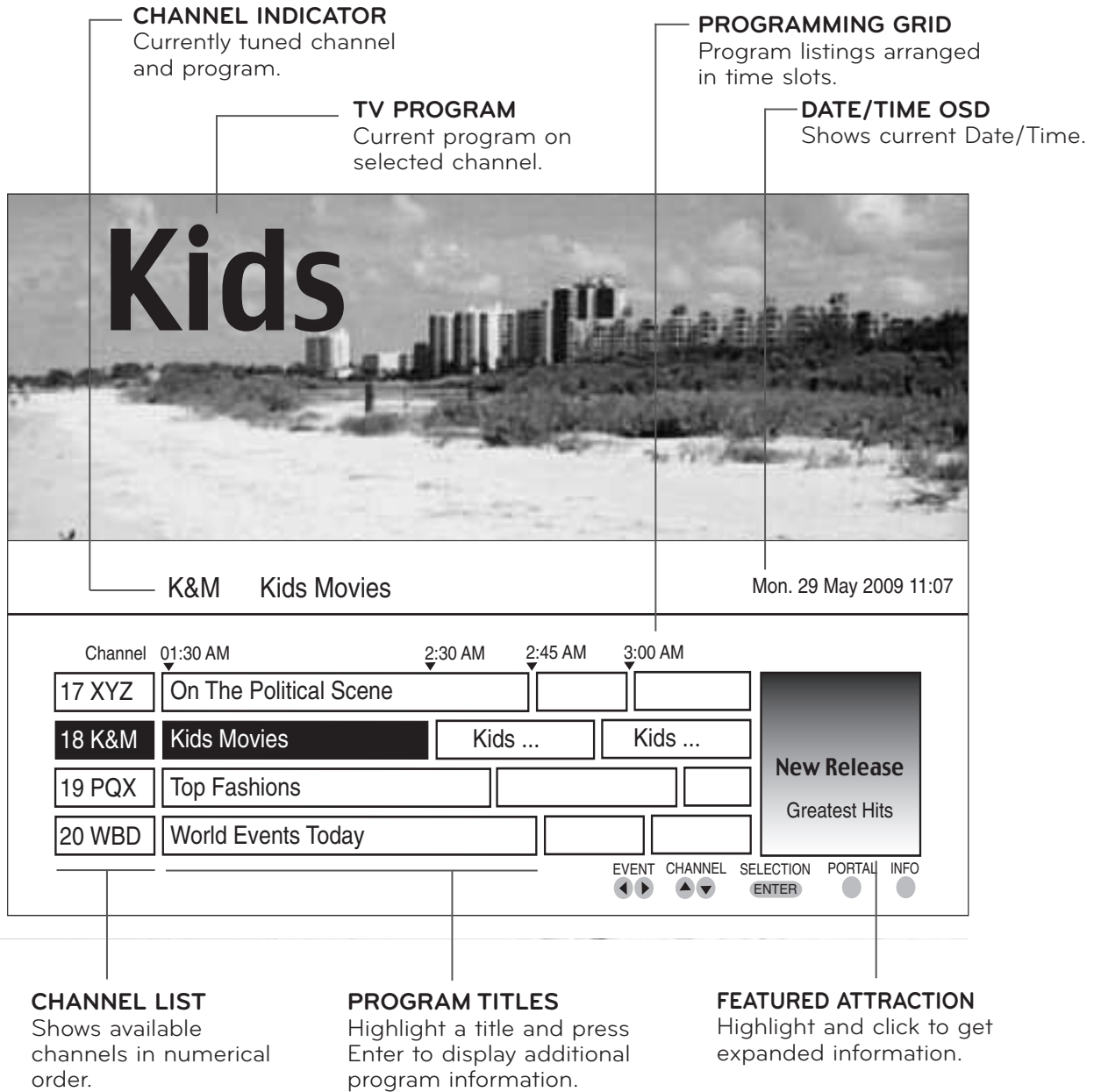

**1**  Select GUIDE button to shows available TV programs.

**2**  Select a Channel.









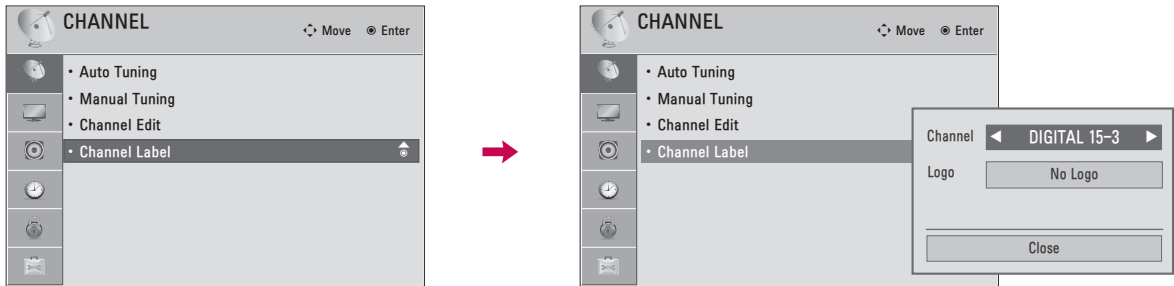

# WATCHING TV / CHANNEL CONTROL

## CHANNEL LABEL

Choose preset labels for your channels.

If a channel label is provided on the signal from the broadcasting station, the TV displays a short name for a channel even if you didn't preset a label for the channel.







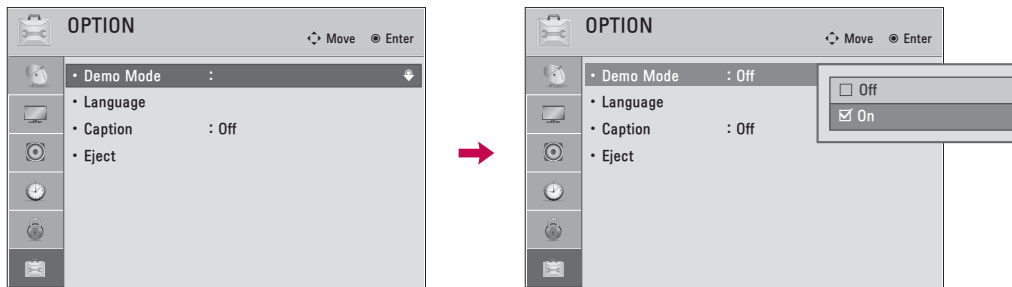

-   Select **CHANNEL**.
-   Select **Channel Label**.
-   Select a Channel.
-  Select a channel to set logo.
-   Select the appropriate logo for the channel.
-  Return to the previous menu.
-  Return to TV viewing.

# DEMO MODE

Displays a slide show to explain the various feature of this TV.



-   Select **OPTION**.
-   Select **Demo Mode**.
-   Select On to show the various feature of the TV.
-  Return to TV viewing.  
After a while, **Demo Mode** starts.  
If you want to stop the demo, press any button (Except VOL +, - and MUTE button).

# MY MEDIA

## CONNECTION METHOD

### USB Connection

- 1 Connect the USB device to the **USB IN** jack on the side of TV.

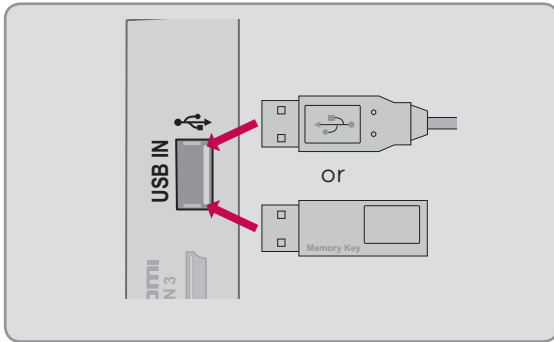

## Precautions when using the USB device

- ▶ Only a USB storage device is recognizable.
- ▶ Connecting a USB storage device through a USB hub is not supported.
- ▶ A USB storage device which uses its own driver may not be recognized.
- ▶ The recognition speed of a USB storage device may depend on each device.
- ▶ Please do not turn off the TV or unplug the USB device when the connected USB storage device is working. When such device is suddenly separated or unplugged, the stored files or the USB storage device may be damaged.
- ▶ Only use a USB storage device which has normal music files, image files, or movie files.
- ▶ Please use only a USB storage device which was formatted as a FAT 32 or NTFS file system provided with the Windows operating system. Others may not be recognized.
- ▶ Some USB storage devices require a power adapter. The power adapter must be connected in order to be seen by the TV.
- ▶ If a device is not recognized by the TV, try a different cable. Excessively long cables are not supported.
- ▶ Some USB storage devices may not be supported or operate properly.
- ▶ Please backup important files because data on USB device could be damaged. Data management is consumer's responsibility and as a result, the manufacturer does not cover data damage.
- ▶ If your USB memory device has multiple partitions, or if you use a USB multi-card reader, you can use up to 4 partitions or USB memory devices.
- ▶ In case of USB storage devices formatted as NTFS, deletion is not supported.
- ▶ File alignment method of USB storage device is similar to Window XP and file names can be up to 100 English characters.
- ▶ The recommended capacity is 1TB or less for a USB external hard disk and 32 GB or less for USB memory.
- ▶ If a USB external hard disk with a "Energy Saving" function doesn't work, turn the hard disk off and on again to make it work properly. Refer to the user manual of the USB external hard disk.
- ▶ USB storage devices below USB 2.0 are supported as well. But they may not work properly in the movie list.

# MY MEDIA

## ENTRY MODE

The My Media menu will open automatically when you insert a USB drive. My Media can also be accessed by choosing My Media in the user menu.



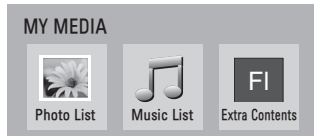

On USB device, you can not add a new folder or delete the existing folder.

For LD320H, LD325H, LD310H series

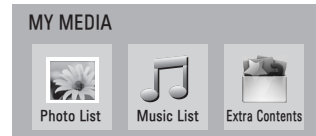

For LD340H, LD345H, LD330H series



-   Select **MY MEDIA**.
-   Select **Photo List**, **Music List**, or **Extra Contents**.
- 

- This TV can view JPG image files or play MP3 audio files.

# PHOTO LIST

The On-Screen Display on your model may be slightly different.

## Supported photo file: \*.JPG

- Baseline: 64 pixel (width) x 64 pixel (height) to 15360 pixel (width) x 8640 pixel (height)
- Progressive: 64 pixel (width) x 64 pixel (height) to 1920 pixel (width) x 1440 pixel (height)
- You can play JPEG files only.
- Non-supported files are displayed in the form of predefined icon.

## Screen Components



- 1 Moves to upper level folder.
- 2 Current page/total pages.
- 3 Corresponding buttons on the remote control.
- 4 Contents under the folder focused on 1.
- 5 Current page/total pages of contents.

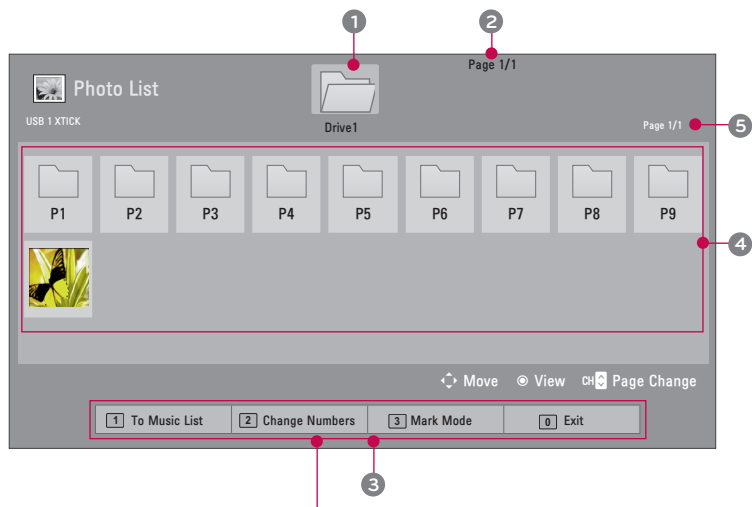



<b>1</b>	Move to <b>Music List</b> .
<b>2</b>	<b>Change Numbers:</b> Changes the number of thumbnails displayed at a time.
<b>3</b>	Allows you to mark certain files.
<b>0</b>	Return to TV viewing.

# MY MEDIA

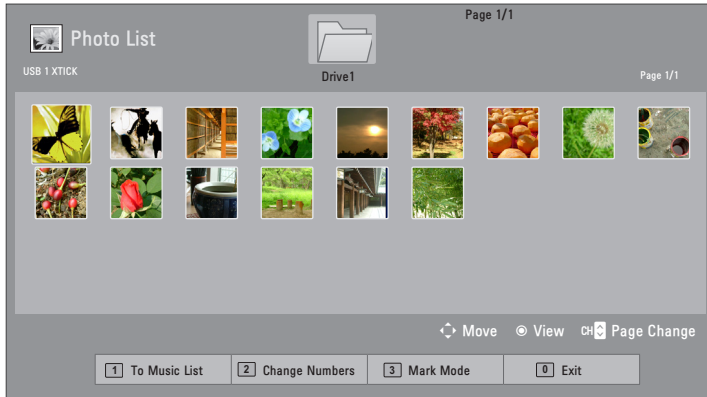
## Photo Selection





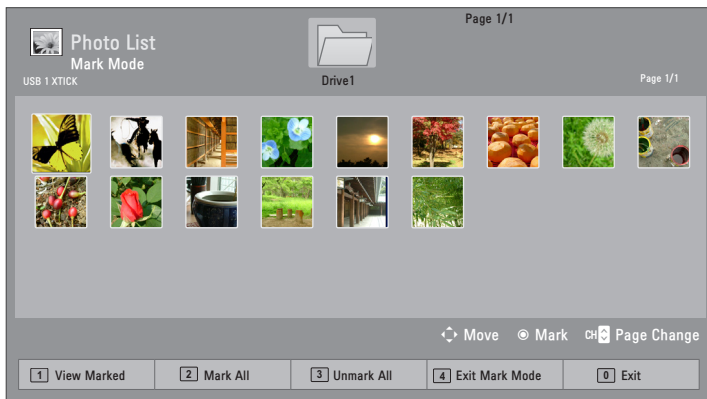

- 1  Select the target folder or drive.
- 2   Select the desired photos.
- 3  Photo file is displayed.

■ Use the CH (^ v) button to navigate in the photo page.

## Mark Mode



- 1  Select the target folder or drive.
- 2   Select the desired photo files.
- 3  Mark your desired photo files.
- 4  View the marked photo files.

**1** **View Marked:** Display the selected photo.

**2** **Mark All:** Mark all photos on the screen.

**3** **Unmark All:** Deselect all marked photos.

**4** Exit the Mark Mode.

■ When one or more photos are marked, you can view individual photos or a slide show of the marked photos. If no photos are marked, you can view all photos individually or all photos in the folder in a slide show.





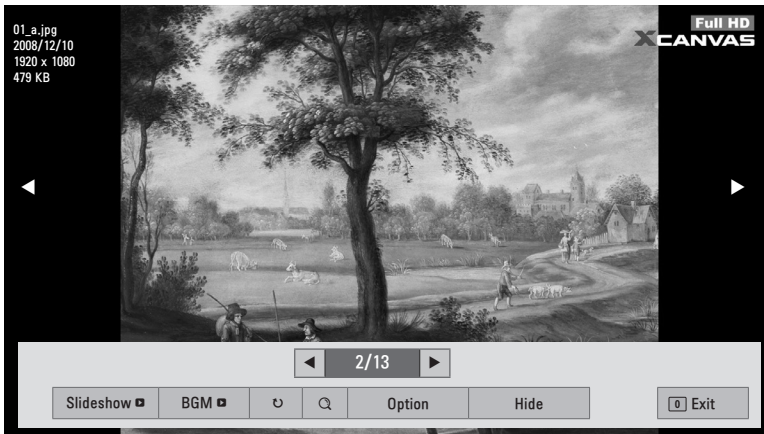
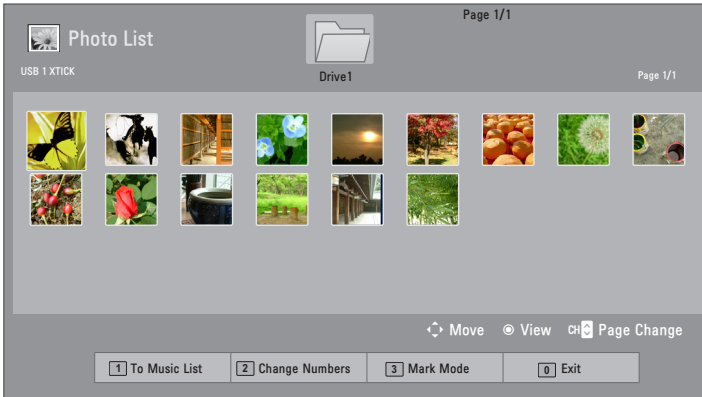

## Full Screen Menu

More operations are available in full screen mode.



The aspect ratio of a photo may change the size of the photo displayed on the screen in full size.

- 1  Select the target folder or drive.
- 2   Select the desired photos.
- 3  The selected photo is displayed in full size.

- Use the CH (^ v) button to navigate in the photo page.

# MY MEDIA

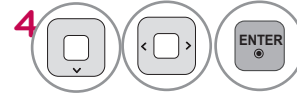
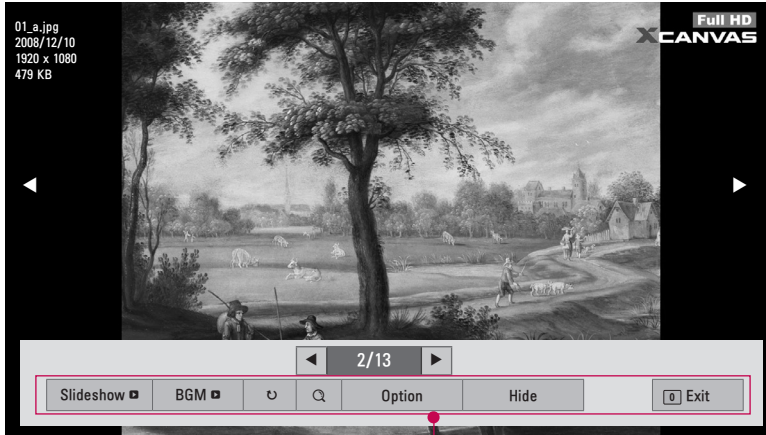





4 Select the **Slideshow**, **BGM**, **⤵ (Rotate)**, **🔍 (Zoom In)**, **Option**, or **Hide**.

- Use **< >** button to select the previous or next photo.

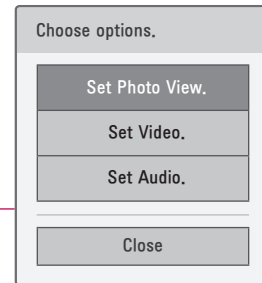
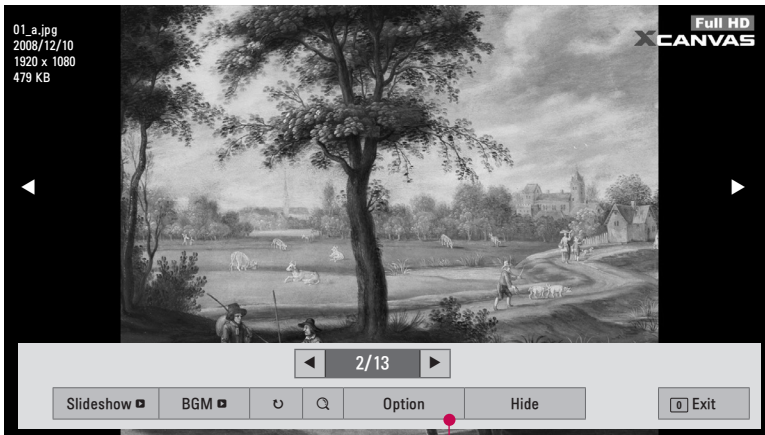
- ▶ **Slideshow**: Selected photos are displayed during the slide show. If no photo is selected, all photos in the current folder are displayed during slide show.
  - Set the time interval of the slide show in **Option-Set Photo View** menu.
- ▶ **BGM (Background Music)**: Listen to music while viewing photos in full size.
  - Set the BGM device and album in **Option-Set Photo View** menu.
- ▶ **⤵ (Rotate)**: Rotate photos.
  - Rotates the photo 90 °, 180 °, 270 °, 360 ° clockwise.
  - Photos cannot be rotated if its width is greater than the available supported resolution height.
- ▶ **🔍 (Zoom In)**: View the photo by zoom in 2, 4 times by using **1** key button.
- ▶ **Option**: Set values for **Slide Speed** and **Music Album**.
  - You cannot change **Music Album** while BGM is playing.
  - You can only select the MP3 folder saved on the device that currently displays the photo.
- ▶ **Hide**: Hide the menu on the full-sized screen.
  - To see the menu again on the full-sized screen, press **ENTER** button to display.
- ▶ **Exit**: Move to the previous menu screen.

## Using the Photo List Function





- 1   Show the **Option** menu.
- 2   Select **Set Photo View**, **Set Video**, or **Set Audio**.

### NOTE

- ▶ Option values changed in Photo List do not affect Music List.

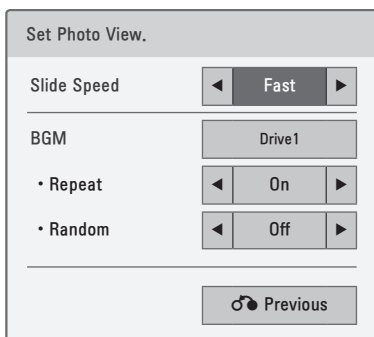
## Set Photo View Menu Options



- 1  Select **Slide Speed** or **BGM**.
- 2  Make appropriate adjustments.

# MY MEDIA

■ Image shown may differ from your TV.

## Set Video Menu Options

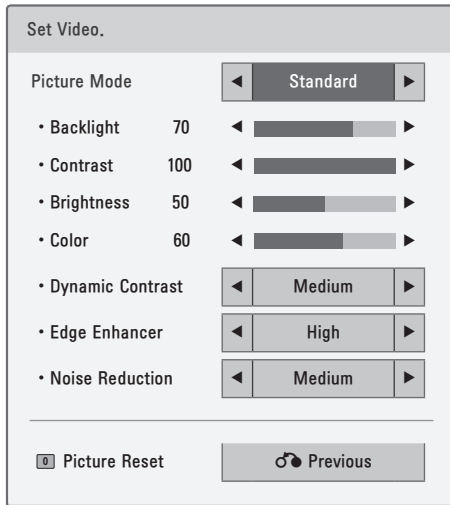

1 Select **Picture Mode**.



2 Make appropriate adjustments.

## Set Audio Menu Options

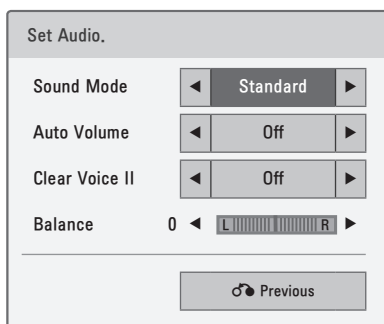

1 Select **Sound Mode**, **Auto Volume**, **Clear Voice II**, or **Balance**.



2 Make appropriate adjustments.

# MUSIC LIST

This TV cannot play back copy-protected files.  
 The On-Screen Display on your model may be slightly different.

MUSIC (\*.MP3) supporting file  
 Bit rate 32 Kbps - 320 Kbps

- Sampling rate MPEG1 Layer3: 32 kHz, 44.1 kHz, 48 kHz
- Sampling rate MPEG2 Layer3: 16 kHz, 22.05 kHz, 24 kHz
- Sampling rate MPEG2.5 Layer3: 8 kHz, 11.025 kHz, 12 kHz

## Screen Components

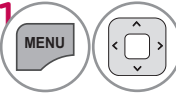
**1**  Select **MY MEDIA**.

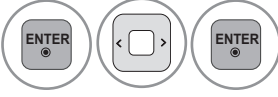
**2**  Select **Music List**.

- 1** Preview: If any album jacket for the file (Album Art Image) exists, this picture is displayed.
- 2** Moves to upper level folder.
- 3** Current page/Total pages.
- 4** Corresponding buttons on the remote control.
- 5** Contents under the folder focused on **1**.
- 6** Current page/total pages of contents.

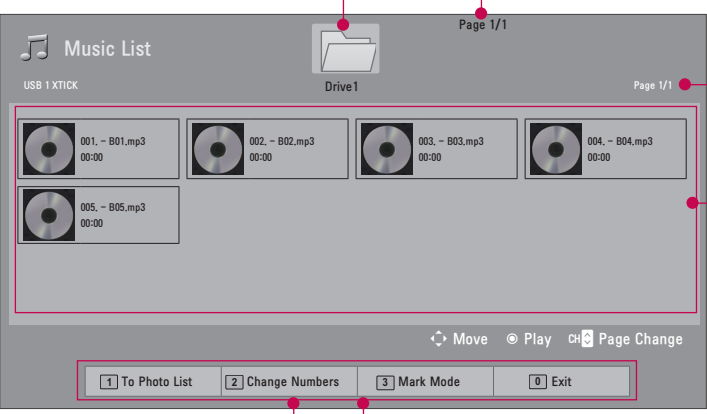



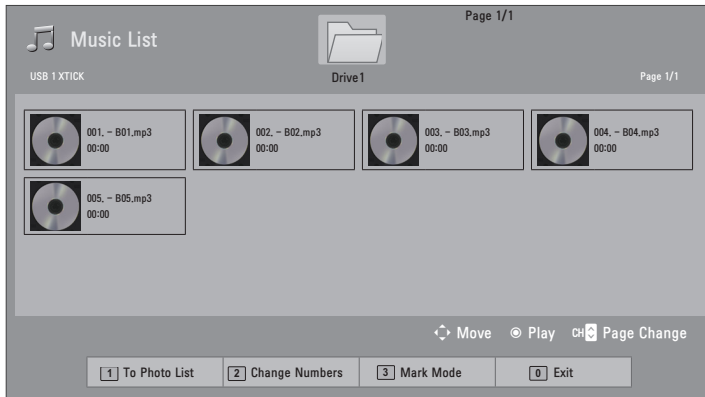

<b>1</b>	Move to <b>Photo List</b> .
<b>2</b>	<b>Change Numbers:</b> Changes the number or thumbnails displayed at a time.
<b>3</b>	Allows you to mark certain files.
<b>0</b>	Return to TV viewing.

# MY MEDIA

## Music Selection





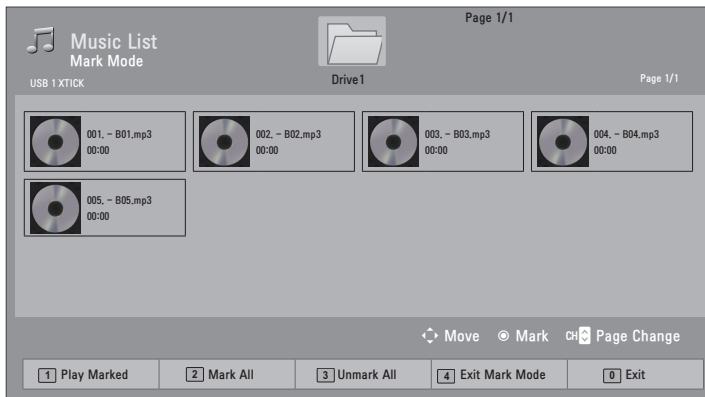

- 1  Select the target folder or drive.
- 2   Select the desired music file.
- 3  Music files are played.

■ Use the CH (^ v) button to navigate in the music page.

## Mark Mode



- 1  Select the target folder or drive.
- 2   Select the desired music file.
- 3  Mark your desired music file.
- 4  Play the marked music file.

1

**Play Marked:** Play the selected songs. Once a song finishes playing, the next selected one will be played automatically.

2

**Mark All:** Mark all songs in the folder.

3

**Unmark All:** Deselect all marked song.





4

Exit the Mark Mode.

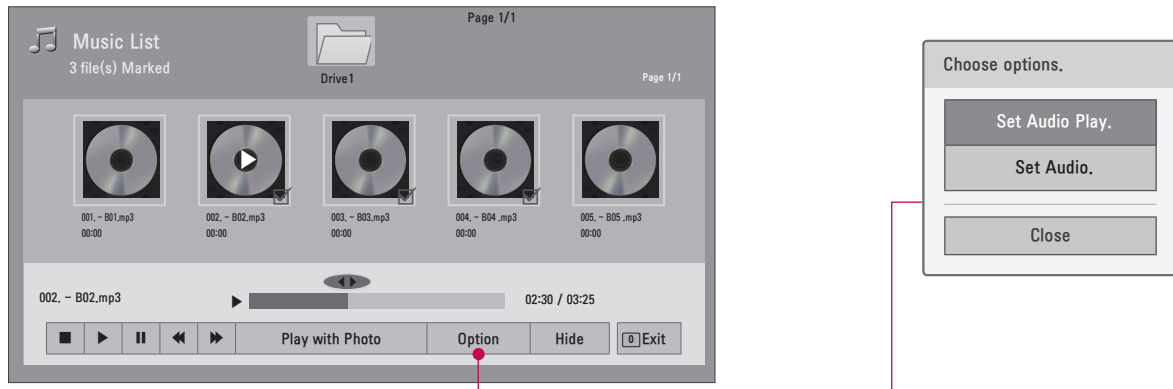
■ When one or more music files are marked, the marked music files will be played in sequence.

## Using the Music List Function









- 1   Show the **Option** menu.
- 2   Select **Set Audio Play** or **Set Audio**.

### NOTE

- ▶ Option values changed in Music List does not affect Photo List.
- ▶ You can listen to the music only within the device currently played.

## Using the remote control

	Stop playback.
	Return to normal playback.
	Paused playback.
	Select the previous or next song.
	A cursor indicating the position can be played on the screen.
	Move to the previous menu screen.

# MY MEDIA

## Set Audio Play Menu Options



1 Select **Repeat** or **Random**.



2 Make appropriate adjustments.

## Set Audio Menu Options

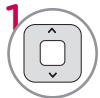
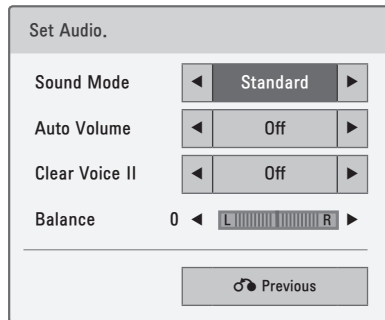

1 Select **Sound Mode**, **Auto Volume**, **Clear Voice II**, or **Balance**.



2 Make appropriate adjustments.



- If you don't press any buttons for a while, the play information box will float across the screen. This prevents screen pixel damage due to a fixed image remaining on the screen for a extended period of time.

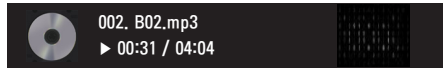

**NOTE**

- ▶ Music files with copy-protection will not play.
- ▶ Press ENTER or  button to stop the screen saver.

## EXTRA CONTENTS

Extra Contents will be activated when Data Channel service is available.

You can play application files from USB device.

Application file on your USB device can be played by this TV.

For LD320H, LD325H, LD310H series

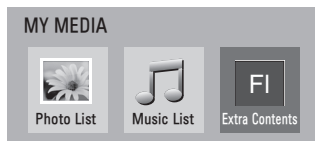

For LD340H, LD345H, LD330H series

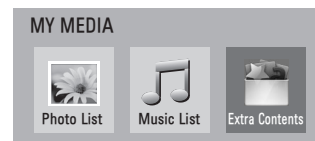

1   Select **MY MEDIA**.

2    Select **Extra Contents**.

**NOTE**







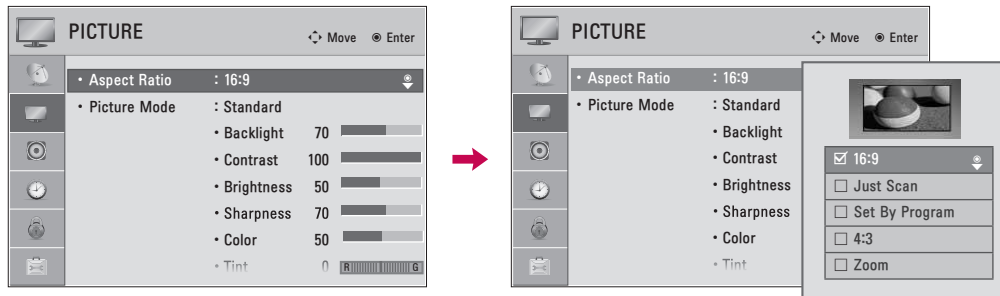

- ▶ Pro: Centric contents in USB memory stick can be played.
- ▶ For more information, contact to Customer Support. ([www.lgcommercial.com](http://www.lgcommercial.com))

# PICTURE CONTROL

## PICTURE SIZE (ASPECT RATIO) CONTROL

This feature lets you choose the way an analog picture with a 4:3 aspect ratio is displayed on your TV. You can select a different aspect ratio depending on input source (analog broadcasting, digital broadcasting, aux).



-   Select **PICTURE**.
-   Select **Aspect Ratio**.
-   Select the desired picture format.
-  Return to the previous menu.
-  Return to TV viewing.

## 16:9

Adjust the picture horizontally, in a linear proportion to fill the entire screen.



## Just Scan

Normally the edges of video signals are cropped 1-2%. Just Scan turns off this cropping and shows the complete video.

Notes: If there is noise on the edges of the original signal, it will be visible when Just Scan is activated.

**Just Scan** operates only in DTV/Cable DTV/Component/HDMI-DTV/DVI-DTV (720p/1080i/1080p) input source.



## Set By Program

Selects the proper picture proportion to match the source's image.

(4:3 → 4:3)



(16:9 → 16:9)



## 4:3

Choose 4:3 when you want to view a picture with an original 4:3 aspect ratio.



## Zoom

Choose Zoom when you want to view the picture without any alteration. However, the top and bottom portions of the picture will be cropped.

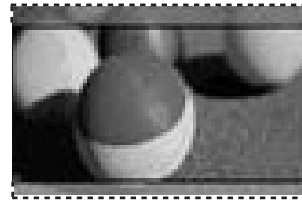







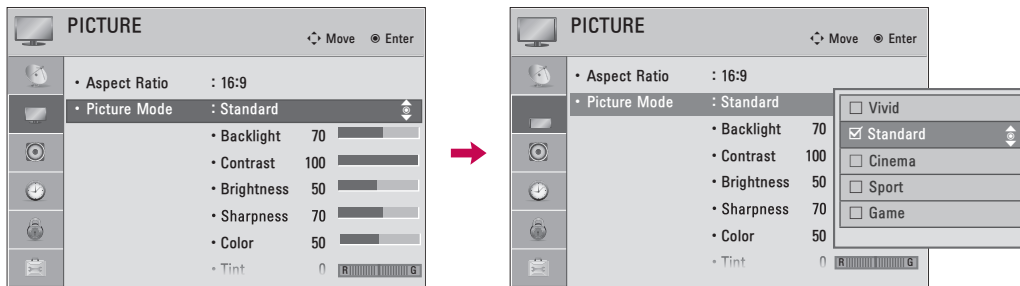

# PICTURE CONTROL

## PRESET PICTURE SETTINGS (PICTURE MODE)

There are factory presets for picture settings available in the user menus. You can use a preset, change each setting manually.











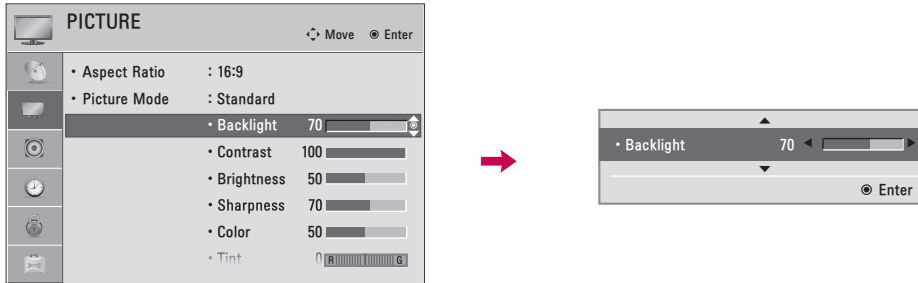



-   Select **PICTURE**.
-   Select **Picture Mode**.
-   Select **Vivid**, **Standard**, **Cinema**, **Sport**, or **Game**.
-  Return to the previous menu.
-  Return to TV viewing.

- **Vivid, Standard, Cinema, Sport, and Game** Settings are preset for the optimum picture quality at the factory.
- **Vivid:** This is the mode to maximize the effect of the video in the retail store. Strengthen the contrast, brightness, color and sharpness for vivid picture.
- **Standard:** This is the mode to realize optimum viewing condition for the general user.
- **Cinema:** This mode optimizes video for watching movies.
- **Sport:** This is the video mode to emphasize dynamic video and primary color (e.g, white, uniform, grass, sky blue etc.) by realizing the optimal screen for sports.
- **Game:** This is the mode to realize fast response speed in a fast gaming screen.

# MANUAL PICTURE ADJUSTMENT - USER MODE

Adjust the picture appearance to suit your preference and viewing situations.



- 1   Select **PICTURE**.
- 2   Select **Picture Mode**.
- 3   Select **Vivid, Standard, Cinema, Sport, or Game**.
- 4   Select **Backlight, Contrast, Brightness, Sharpness, Color, Tint, Color Temp., or Advanced Control**.
- 5   Make appropriate adjustments.
- 6  Return to the previous menu.
-  Return to TV viewing.







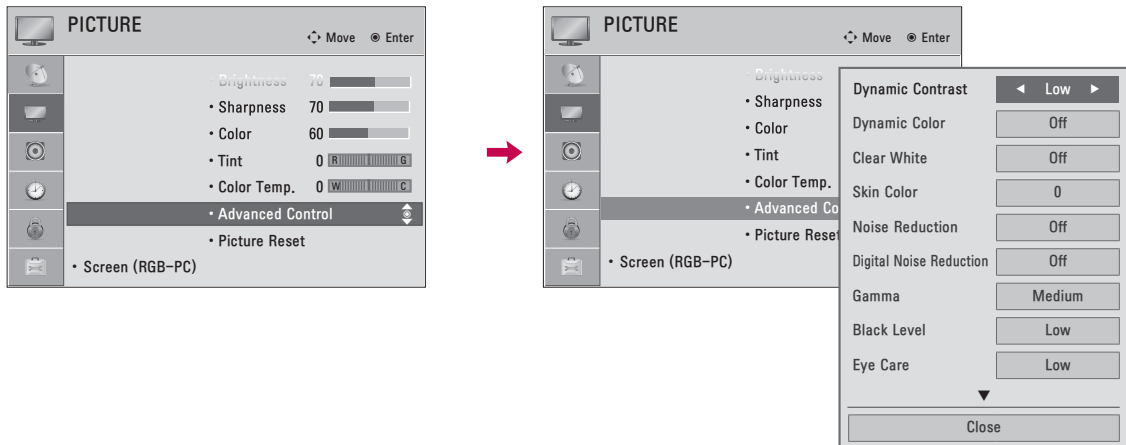

- **Backlight:** This function adjusts the brightness of the backlight behind the LCD screen. Adjusting the backlight is recommended when setting the brightness of the TV. When decreasing the backlight, the brightness of the black becomes darker without any loss in video signal and the power consumption is reduced.
- **Contrast:** Increase or decrease the gradient of the video signal. You may use Contrast when the bright part of the picture is saturated.
- **Brightness:** Adjusts the base level of the signal in the picture. You may use Brightness when the dark part of the picture is saturated.
- **Sharpness:** Adjusts the level of crispness in the edges between the light and dark areas of the picture. The lower the level, the softer the image.
- **Color:** Adjusts intensity of all colors.
- **Tint:** Adjusts the balance between red and green levels.
- **Color Temp.:** Set to warm to enhance hotter colors such as red, or set to cool to enhance cooler colors such as blue.

# PICTURE CONTROL

## PICTURE IMPROVEMENT TECHNOLOGY (ADVANCED CONTROL)

Advanced Control allows you to adjust some of the advanced features of your LG display. To reset to the factory default after making adjustments to each input source, execute the **Picture Reset** function for each Picture Mode.

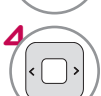

-   Select **PICTURE**.
-   Select **Advanced Control**.
-   Select your desired menu option.
-  Make appropriate adjustments.
-  Return to the previous menu.
-  Return to TV viewing.

\*This feature is not available for all models.

Dynamic Contrast	<ul style="list-style-type: none"> <li>Adjusts the contrast to keep it at the best level according to the brightness of the screen. The picture is improved by making bright parts brighter and dark parts darker.</li> </ul>
Dynamic Color	<ul style="list-style-type: none"> <li>Adjusts screen colors so that they look livelier, richer and clearer. This feature enhances hue, saturation and luminance so that red, blue and green white look more vivid.</li> </ul>
Skin Color	<ul style="list-style-type: none"> <li>It detects the skin area of video and adjusts it to express a natural skin color.</li> </ul>
Noise Reduction	<ul style="list-style-type: none"> <li>Reduces screen noise without compromising video quality.</li> </ul>
Digital Noise Reduction	<ul style="list-style-type: none"> <li>Removes noise caused by compressing video.</li> </ul>
Gamma	<ul style="list-style-type: none"> <li>You can adjust brightness of dark areas and middle gray level areas of the picture.</li> </ul> <p>Low : Make brighter and middle gray level areas of the picture brighter.          Medium : Express original picture levels.          High: Make dark and middle gray level areas of the picture darker.</p>
Black Level	<p>Low: The reflection of the screen gets darker.          High: The reflection of the screen gets brighter.          Auto: Realizing the black level of the screen and set it to High or Low automatically.</p> <ul style="list-style-type: none"> <li>Set black level of the screen to proper level.</li> <li>This function is available in the following modes: AV (NTSC-M), HDMI or Component. Otherwise, "Black level" is set to "Auto".</li> </ul>
Clear White	<ul style="list-style-type: none"> <li>Make the white area of screen brighter and more white.</li> </ul>
Eye Care	<ul style="list-style-type: none"> <li>Adjust the brightness of the screen to prevent the screen from being too bright. Dims extremely bright pictures.</li> <li>This feature is enabled in "<b>Picture Mode-Standard, Sports, Game</b>".</li> </ul>
Real Cinema	<ul style="list-style-type: none"> <li>Makes video clips recorded in film look more natural by eliminating judder effect.</li> <li>DVD and Blu-ray movies are filmed at 24 frames per second (fps). With LG Real Cinema, every frame is consistently processed 5 times in 1/24 of a second producing 120 fps with TruMotion or 2 times in 1/24 of a second producing 48 fps without TruMotion, thus totally eliminating the judder effect.</li> </ul>
Color Gamut	<p><b>Advanced Control</b></p> <ul style="list-style-type: none"> <li>Maximize the utilization of colors to increase color quality.</li> </ul> <p>Standard: Displays standard set of colors.          Wide: Increase number of colors used.</p>
	<p><b>Expert Control</b></p> <ul style="list-style-type: none"> <li>Displays color domain of the signal.</li> </ul> <p>Standard: Displays standard set of colors.          Wide: Increase number of colors used.          EBU: Mode to display EBU standard color area.          SMPTE: Mode to display SMPTE standard color area.          BT709: Mode to display BT709 standard color area.</p>

# PICTURE CONTROL

xvYCC







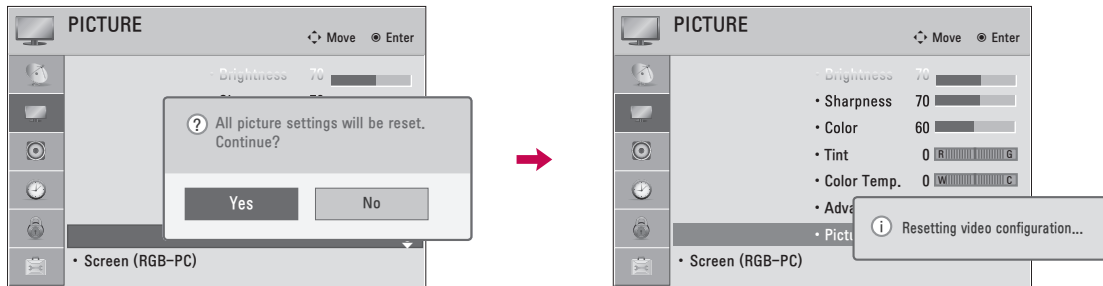

- This is produces richer colors.
- This feature represents rich color as much as conventional video signal.
- This function is enabled in "**Picture Mode - Cinema, Expert**" when a xvYCC signal is inputted through HDMI.



# PICTURE RESET

Settings of the selected picture modes return to the default factory settings.



- 1   Select **PICTURE**.
- 2   Select **Picture Reset**.
- 3   Select **Yes**.
- 4  Initialize the adjusted value.
-  Return to TV viewing.





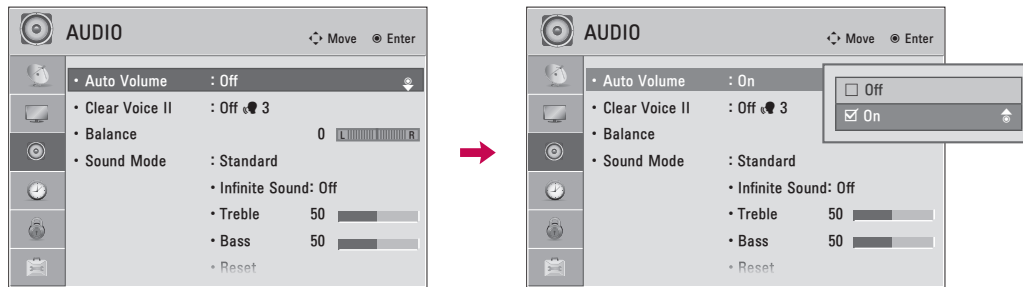

# SOUND & LANGUAGE CONTROL

## AUTO VOLUME

Auto Volume makes sure that the volume level remains consistent whether you are watching a commercial or a regular TV program.

Because each broadcasting station has its own signal conditions, volume adjustment may be needed every time the channel is changed. This feature allows users to enjoy stable volume levels by making automatic adjustments for each program.



-   Select **AUDIO**.
-   Select **Auto Volume**.
-   Select **On** or **Off**.
-  Return to the previous menu.
-  Return to TV viewing.

# CLEAR VOICE II

By differentiating the human sound range from others, it improves the sound quality of voices.

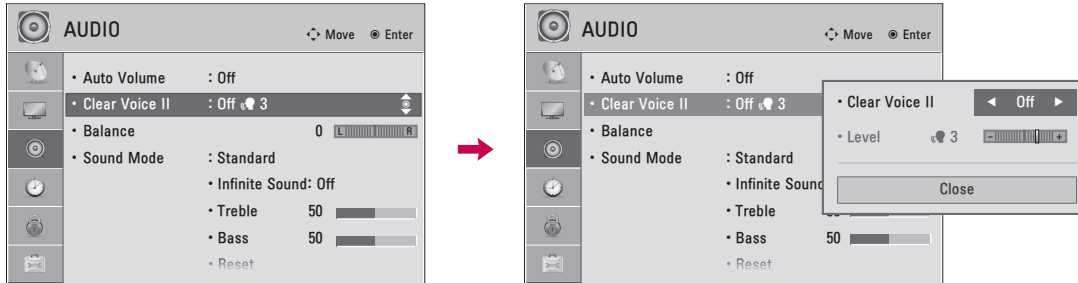

1   Select **AUDIO**.

2   Select **Clear Voice II**.

3   Select **On** or **Off**.

## Adjustment for Clear Voice Level with selecting On

4  Select **Level**.

5  Make appropriate adjustments.

6  Return to the previous menu.



 Return to TV viewing.

# SOUND & LANGUAGE CONTROL

## BALANCE

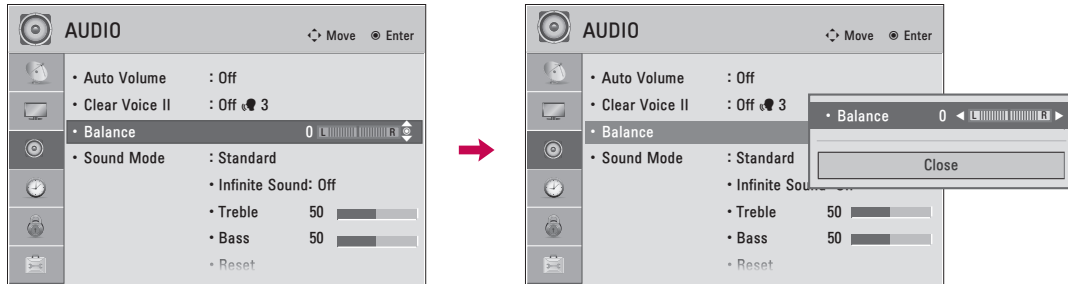
Adjust the left/right sound of speaker to suit your taste and room situations.









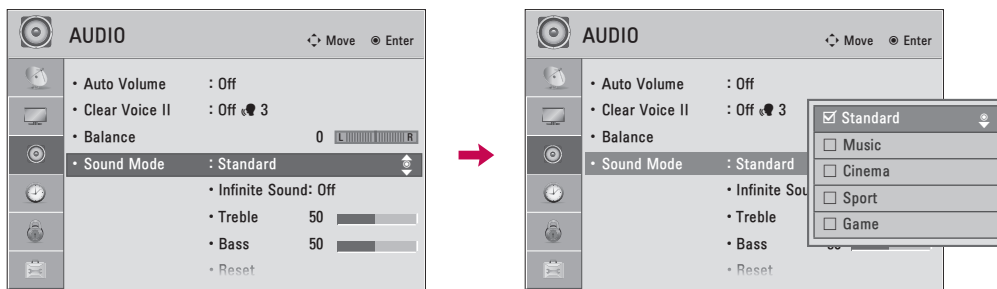

- 1   Select **AUDIO**.
- 2   Select **Balance**.
- 3   Make appropriate adjustments.
- 4  Return to the previous menu.
-  Return to TV viewing.

## PRESET SOUND SETTINGS (SOUND MODE)

Sound Mode lets you enjoy the best sound without any special adjustment using factory presets.



- 1   Select **AUDIO**.
- 2   Select **Sound Mode**.
- 3   Select **Standard, Music, Cinema, Sport, or Game**.
- 4  Return to the previous menu.
-  Return to TV viewing.









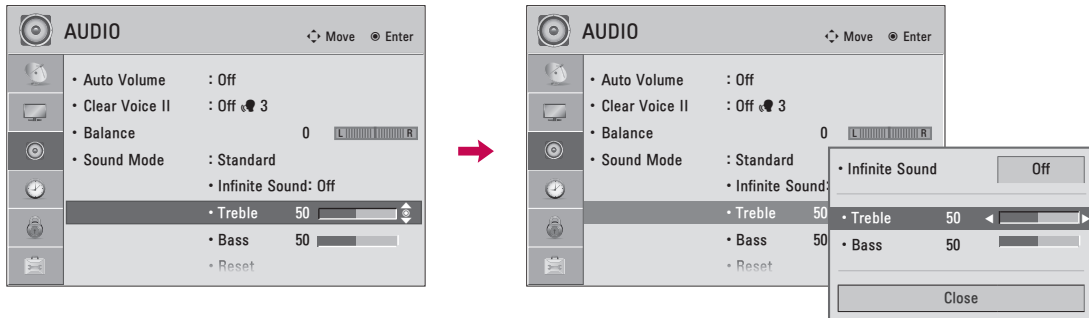



- **Standard, Music, Cinema, Sport, and Game** are preset for optimum sound quality at the factory.
- You can also adjust **Sound Mode** in the **Q.MENU**.
- **Standard**: Offers standard-quality sound.
- **Music**: Optimizes sound for listening to music.
- **Cinema**: Optimizes sound for watching movies.
- **Sport**: Optimizes sound for watching sports events.
- **Game**: Optimizes sound for playing games.

# SOUND & LANGUAGE CONTROL

## SOUND SETTING ADJUSTMENT - USER MODE

Adjust the sound to suit your taste and room situations.



- 1   Select **AUDIO**.
- 2   Select **Sound Mode**.
- 3   Select **Standard, Music, Cinema, Sport, or Game**.
- 4   Select **Infinite Sound, Treble, or Bass**.
- 5   Make appropriate adjustments.
- 6  Return to the previous menu.
-  Return to TV viewing.

- If sound quality or volume is not at the level you want, it is recommended to use a separate home theater system or amp to cope with different user environments.
- If you select "**Clear Voice II-On**", the **Infinite Sound** feature will not operate.
- **Infinite Sound**: Infinite Sound is a patented LG proprietary sound processing technology that strives immersive 5.1 surround sound with just two front speakers.

## AUDIO RESET

Settings of the selected Sound Mode return to the default factory settings.

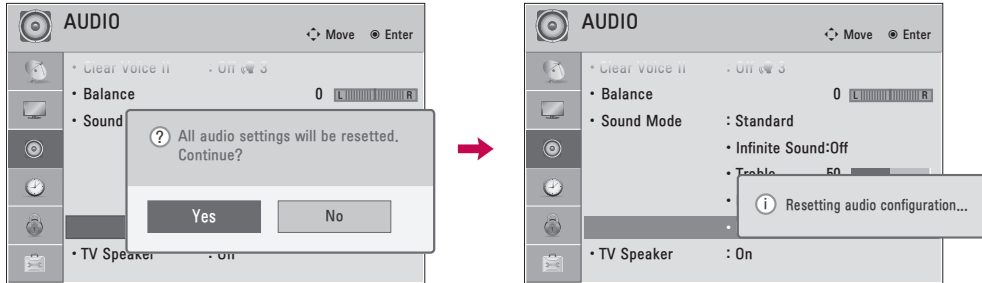

1 Select **AUDIO**.

2 Select **Reset**.

3 Select **Yes**.

4 Initialize the adjusted value.

Return to TV viewing.

## TV SPEAKERS ON/OFF SETUP

If you wish to use an external Hi-Fi system, turn off the TV's internal speakers.

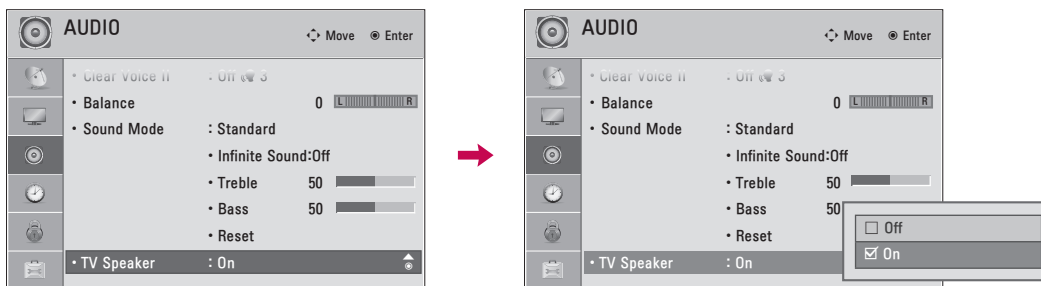

1 Select **AUDIO**.

2 Select **TV Speaker**.

3 Select **On** or **Off**.

4 Return to the previous menu.







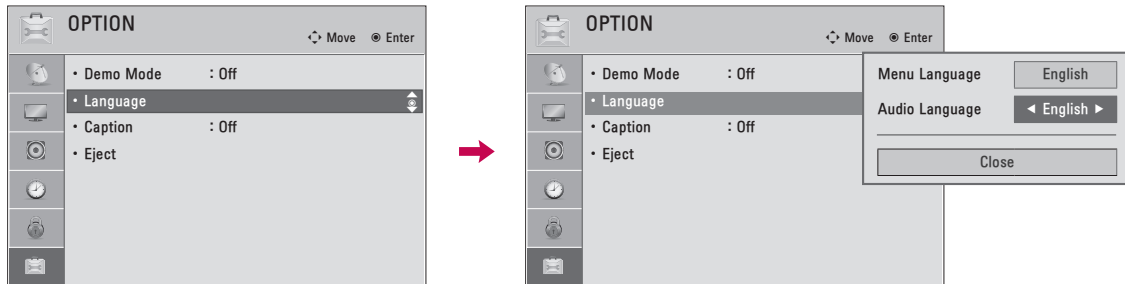

Return to TV viewing.

# SOUND & LANGUAGE CONTROL

## AUDIO LANGUAGE

This feature operates only in DTV/Cable DTV mode.











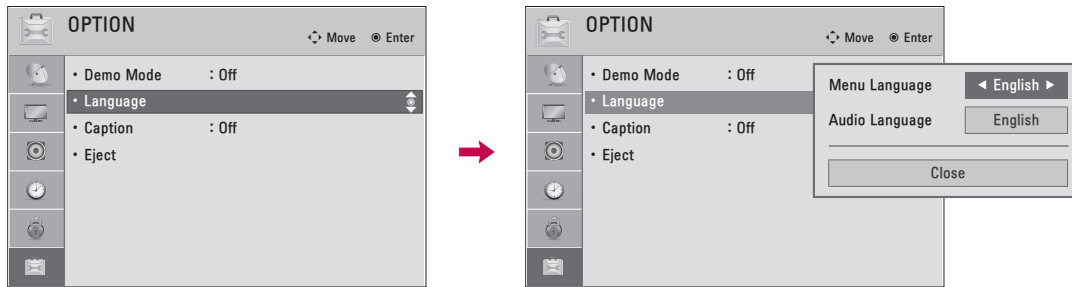

-   Select **OPTION**.
-   Select **Language**.
-   Select **Audio Language**.
-  Select your desired language.
-  Return to the previous menu.
-  Return to TV viewing.



# ON-SCREEN MENUS LANGUAGE SELECTION

The menus can be shown on the screen in the selected language.



-   Select **OPTION**.
-   Select **Language**.
-   Select **Menu Language**.
-  Select your desired language.  
From this point on, the on-screen menus will be shown in the selected language.
-  Return to the previous menu.
-  Return to TV viewing.









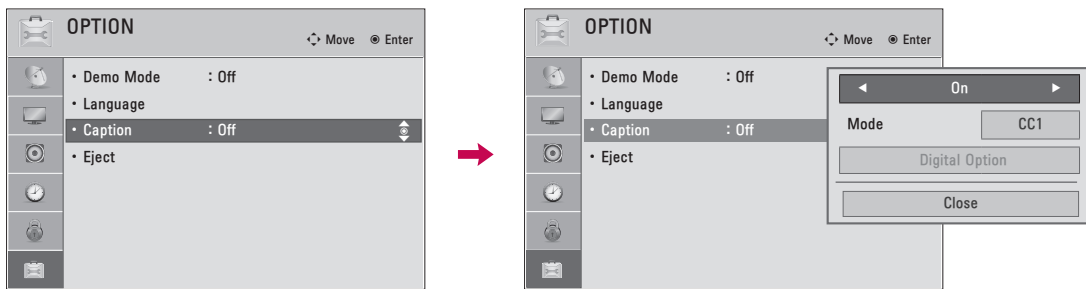

# SOUND & LANGUAGE CONTROL

## CAPTION MODE

### Analog Broadcasting System Captions

Captions are provided to help the hearing impaired watch TV. Select a caption mode for displaying captioning information if provided on a program. Analog caption displays information at any position on the screen and is usually the program's dialog. Caption/Text, if provided by the broadcaster, would be available for both digital and analog channels on the Antenna/Cable. This TV is programmed to memorize the caption/text mode which was last set when you turned the power off. This function is only available when **Caption Mode** is set **On**.



- 1   Select **OPTION**.
- 2   Select **Caption**.
- 3   Select **On**.
- 4   Select **CC1-4** or **Text1-4**.
- 5  Return to the previous menu.
-  Return to TV viewing.

- When selecting **Off**, Sub-menus for Analog, DTV, and Digital Option become disabled.
- **Caption**  
The term for the words that scroll across the bottom of the TV screen; usually the audio portion of the program provided for the hearing impaired.
- **Text**  
The term for the words that appear in a large black frame and almost cover the entire screen; usually messages provided by the broadcaster.









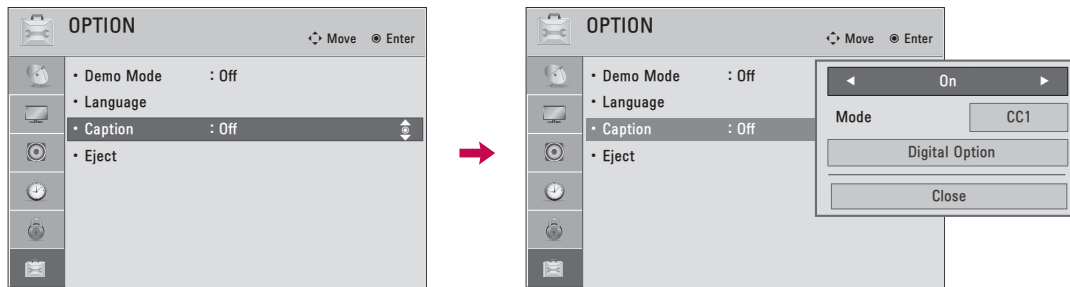

## Digital Broadcasting System Captions

Choose the language you want the DTV/Cable DTV Captions to appear in.

Other Languages can be chosen for digital sources only if they are included on the program.

This function is only available when **Caption Mode** is set **On**.



- 1   Select **OPTION**.
  - 2   Select **Caption**.
  - 3   Select **On**.
  - 4   Select **CC1-4, Text1-4, or Service1 - 6**.
  - 5  Return to the previous menu.
-  Return to TV viewing.

# SOUND & LANGUAGE CONTROL

## Caption Option

Customize the DTV/Cable DTV captions that appear on your screen.

This function is only available when **Caption Mode** is set **On**.

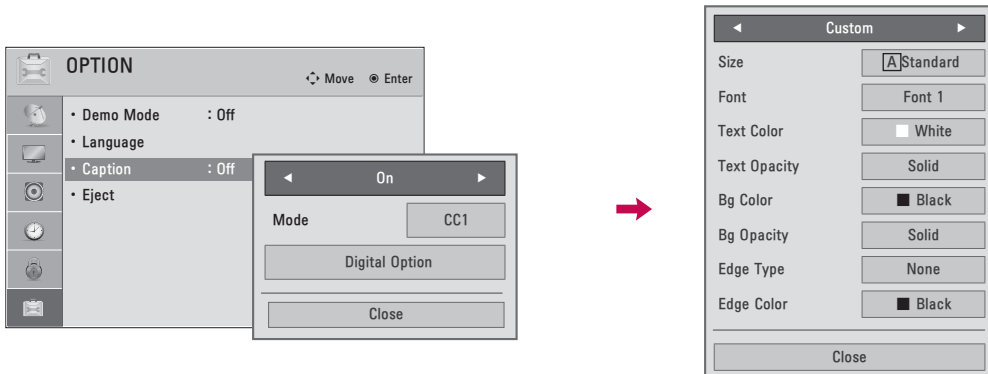

**1** Select **OPTION**.

**2** Select **Caption**.

**3** Select **On**.

**4** Select **Digital Option**.

**5** Select **Custom**.

**6** Customize the **Size**, **Font**, etc., to your preference. A preview icon is provided at the bottom of the screen, use it to see the caption language.

**7** Return to the previous menu.

Return to TV viewing.

- **Size:** Set the word size.
- **Font:** Select a typeface for the text.
- **Text Color:** Choose a color for the text.
- **Text Opacity:** Specify the opacity for the text color.
- **Bg (Background) Color:** Select a background color.
- **Bg (Background) Opacity:** Select the opacity for the background color.
- **Edge Type:** Select an edge type.
- **Edge Color:** Select a color for the edges.

# TIME SETTING

## CLOCK SETTING









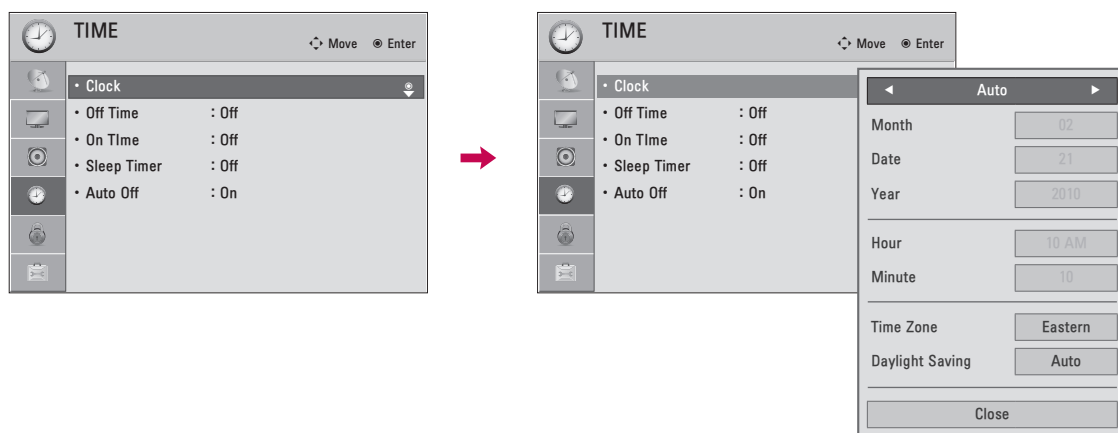



### Auto Clock Setup

The time is set automatically from a digital channel signal.

The digital channel signal includes information for the current time provided by the broadcasting station.

Set the clock manually if the current time is set incorrectly by the auto clock function.











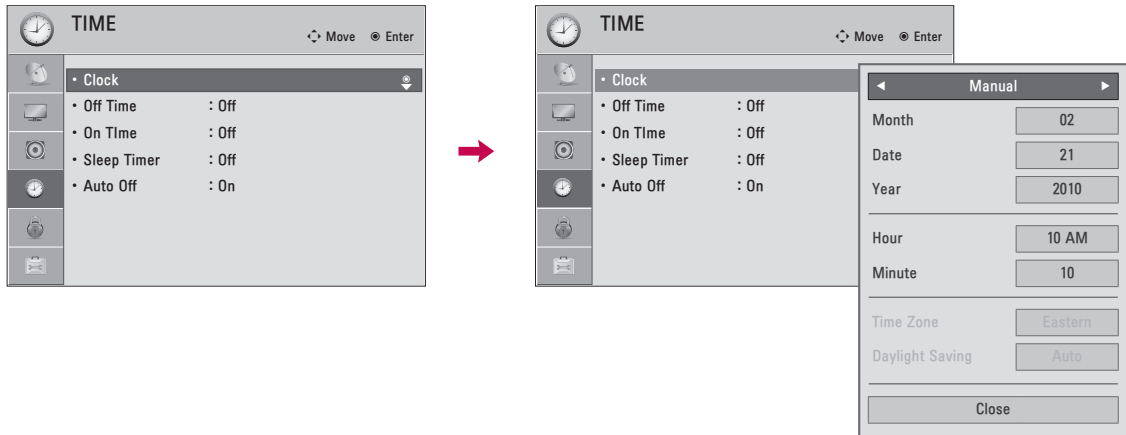

- 1   Select **TIME**.
- 2   Select **Clock**.
- 3   Select **Auto**.
- 4   Select your viewing area time zone.
- 5   Select **Auto**, **Off**, or **On** (depending on whether or not your viewing area observes Daylight Saving time).
- 6  Return to the previous menu.
-  Return to TV viewing.

# TIME SETTING

## Manual Clock Setup

If the current time setting is wrong, reset the clock manually.



-   Select **TIME**.
-   Select **Clock**.
-   Select **Manual**.
-  Select the Year, Month, Date, Hour, or Minute option.
-  Set the Year, Month, Date, Hour, or Minute option.
-  Return to the previous menu.
-  Return to TV viewing.









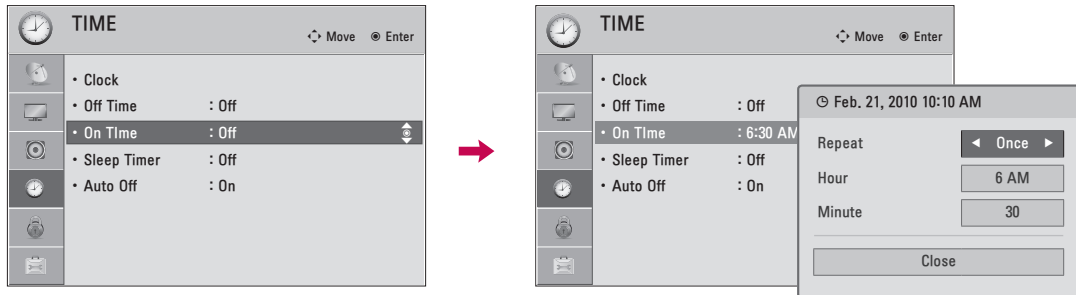

# AUTO ON/OFF TIME SETTING

This function operates only if the current time has been set.

The **Off Time** function overrides the **On Time** function if they are both set to the same time.

The TV must be in standby mode for the **On Time** to work.



-   Select **TIME**.
-   Select **Off Time** or **On Time**.
-   Select **Repeat**.
-  Select **Off**, **Once**, **Daily**, **Mon.~Fri.**, **Mon.~Sat**, **Sat.~ Sun.**, or **Sun.**.
-   Select and set **Hour** or **Minute**.
-  Return to the previous menu.
-  Return to TV viewing.

# TIME SETTING

## SLEEP TIMER SETTING

The Sleep Timer turns the TV off at the preset time.

Note that this setting is cleared when the TV is turned off.

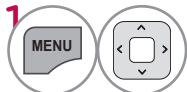
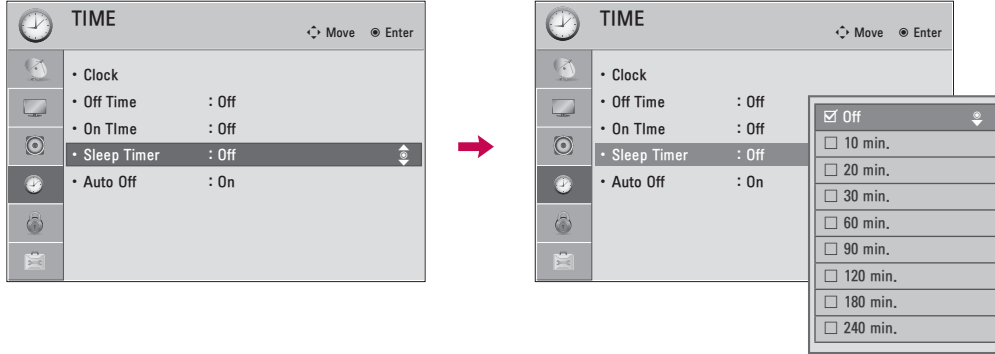

Select **TIME**.

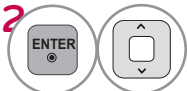

Select **Sleep Timer**.

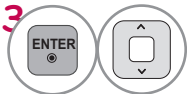

Make appropriate adjustments.



Return to the previous menu.



Return to TV viewing.

■ To cancel the **Sleep Timer**, select **Off**.

## AUTO SHUT-OFF SETTING

If set to on and there is no input signal, the TV turns off automatically after 15 minutes.

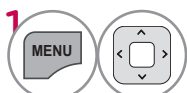
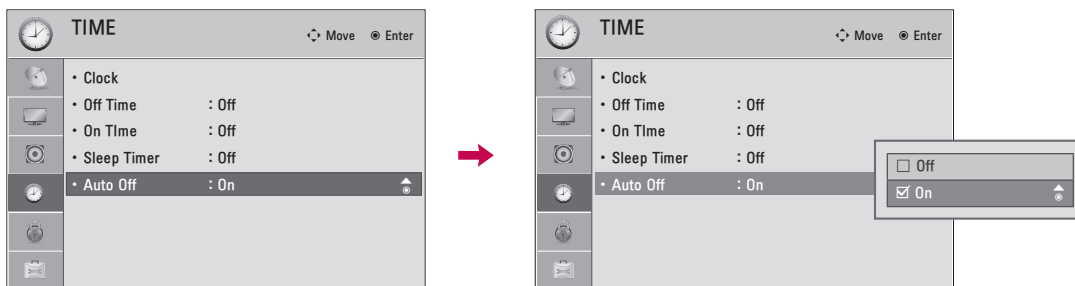

Select **TIME**.



Select **Auto Off**



Select **On** or **Off**.



Return to the previous menu.



Return to TV viewing.



# PARENTAL CONTROL / RATINGS

Parental Control can be used to block specific channels, ratings and other viewing sources.

The Parental Control Function (V-Chip) is used to block program viewing based on the ratings sent by the broadcasting station. The default setting is to allow all programs to be viewed. Viewing can be blocked by choosing the type of the program and the categories. It is also possible to block all program viewing for a time period. To use this function, the following must be done :

1. Set ratings and categories to be blocked.
2. Specify a password
3. Enable the lock

## V-Chip rating and categories

Rating guidelines are provided by broadcasting stations. Most television programs and television movies can be blocked by TV Rating and/or Individual Categories. Movies that have been shown at the theaters or direct-to-video movies use the Movie Rating System (MPAA) only.

## Ratings for Television programs including made-for-TV movies:





- TV-G (General audience)
- TV-PG (Parental guidance suggested)
- TV-14 (Parents strongly cautioned)
- TV-MA (Mature audience only)
- TV-Y (All children)
- TV-Y7 (Children 7 years older)

# SET PASSWORD & LOCK SYSTEM

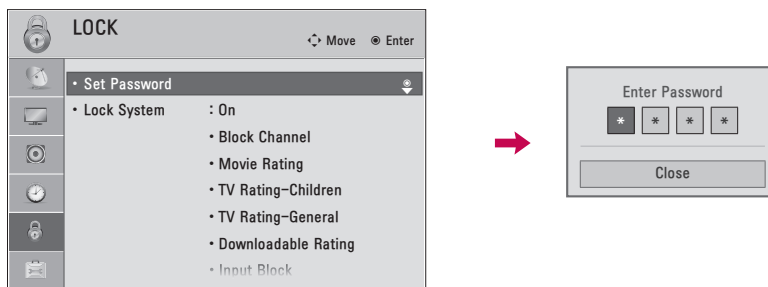
## Setting up Your Password

Set up blocking schemes to block specific channels, ratings, and external viewing sources. A password is required to gain access to this menu.



1.    Select **LOCK**.
2.  Input the password.

- Enter the password as requested.
- The TV is set up with the initial password "0-0-0-0".
- If you forget your password, press "0-3-2-5" on the remote control.

# PARENTAL CONTROL / RATINGS

## Set Password

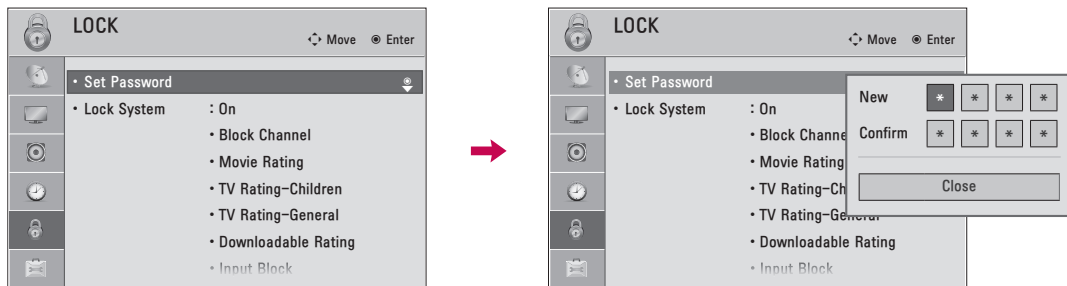

Change the password by inputting a new password twice.





1    Select **LOCK**.

2  Input the password.

3  Select **Set Password**.

4   Choose any 4 digits for your **new** password.  
As soon as the 4 digits are entered, re-enter the same 4 digits on the **Confirm**.

5  Return to the previous menu.

 Return to TV viewing.

## Lock System

Enables or disables the blocking scheme you set up previously.

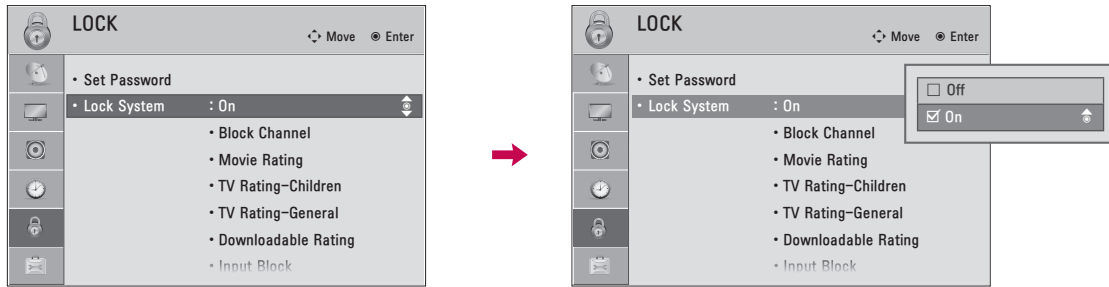



1    Select **LOCK**.

2  Input the password.

3  Select **Lock System**.

4   Select **On** or **Off**.

5  Return to the previous menu.

 Return to TV viewing.







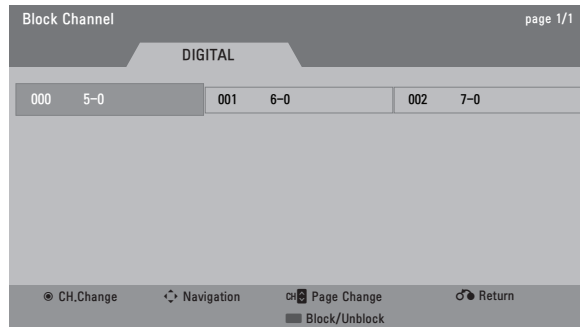
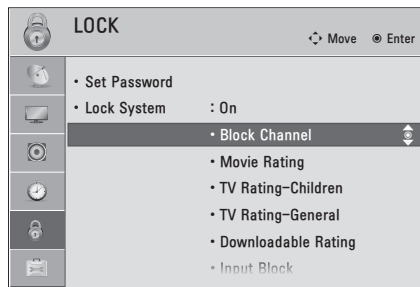

■ When you select **On**, the Lock System is enable.

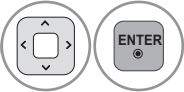
# PARENTAL CONTROL / RATINGS

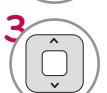
## CHANNEL BLOCKING

Blocks any channels that you do not want to watch or that you do not want your children to watch.



- 1    Select **LOCK**.
- 2  Input the password.
- 3  Select **Block Channel**.
- 4   Select a channel to block or unblock.
- 5  Block or unblock a channel.
- 6  Return to the previous menu.
-  Return to TV viewing.

■ If a channel is locked, enter the password to unlock it temporarily.

# MOVIE & TV RATING

## Movie Rating (MPAA)

Blocks movies according to the movie ratings limits specified, so children cannot view certain movies. You can set the ratings limit by blocking out all the movies with the ratings above a specified level. Keep in mind that the movie ratings limit only applies to movies shown on TV, not TV programs, such as soap operas.

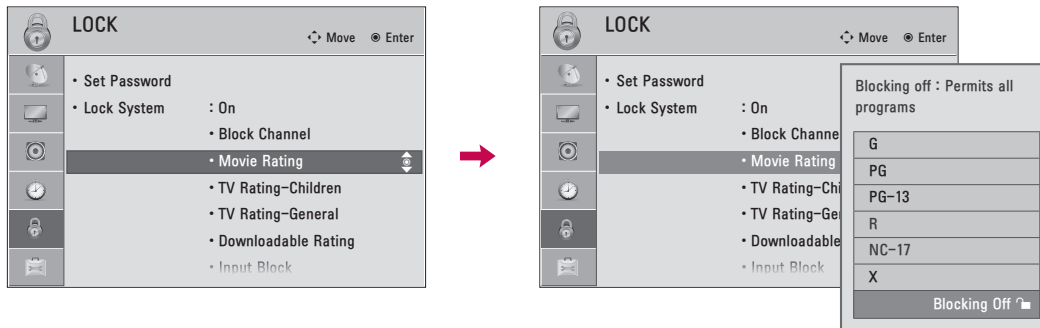

- 1 Select **LOCK**.
- 2 Input the password.
- 3 Select **Movie Rating**.
- 4 Select **G**, **PG**, **PG-13**, **R**, **NC-17**, **X**, or **Blocking Off**.
- 5 Return to the previous menu.
- Return to TV viewing.



- If **Movie Rating**, **TV Rating-Children** or **TV Rating-General** is locked, enter the password to unlock it temporarily.
- **G** (General audience)
- **PG** (Parental guidance suggested)
- **PG-13** (Parents strongly cautioned)
- **R** (Restricted)
- **NC-17** (No one 17 and under admitted)
- **X** (Adult only)
- **Blocking Off** (Permits all programs)
- If you set PG-13: G and PG movies will be available, PG-13, R, NC-17 and X will be blocked.

# PARENTAL CONTROL / RATINGS

## TV Rating Children

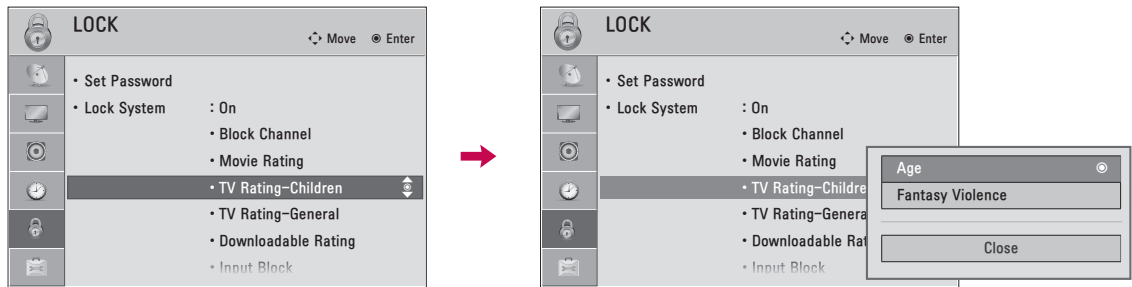
Prevents children from watching certain children's TV programs, according to the ratings limit set. The children rating does not apply to other TV programs. Unless you block certain TV programs intended for mature audiences in the TV Rating - sub menu, your children can view those programs.



1    Select **LOCK**.

2  Input the password.

3  Select **TV Rating-Children**.

4   Select **Age** or **Fantasy Violence**.

5   Select block options.

6  Return to the previous menu.

 Return to TV viewing.

- **Age** (applies to TV-Y, TV-Y7)
- **Fantasy Violence** (applies to TV-Y7)

## TV Rating General

Based on the ratings, blocks certain TV programs that you and your family do not want to view.

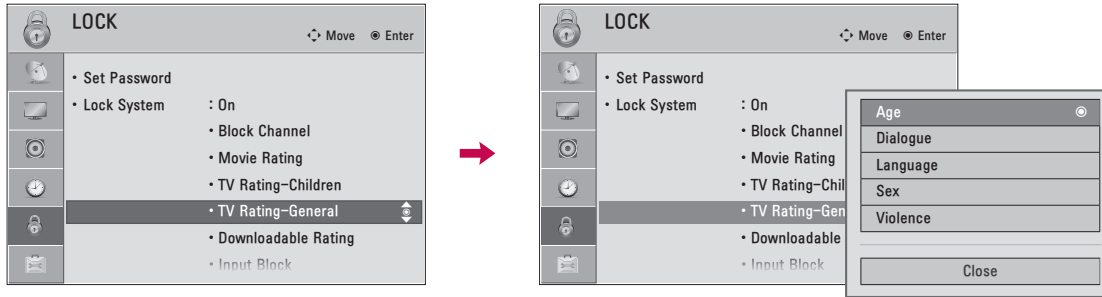

1    Select **LOCK**.

2  Input the password.

3  Select **TV Rating-General**.

4   Select **Age, Dialogue, Language, Sex, or Violence**.

5   Select block options.

6  Return to the previous menu.

 Return to TV viewing.

- **Age** (applies to TV-G,TV-PG,TV-14,TV-MA).
- **Dialogue**-sexual dialogue (applies to TV-PG,TV-14).
- **Language**-adult language (applies to TV-PG, TV-14, TV-MA).
- **Sex**-sexual situations (applies to TV-PG, TV-14, TV-MA).
- **Violence** (applies to TV-PG, TV-14, TV-MA).

# PARENTAL CONTROL / RATINGS







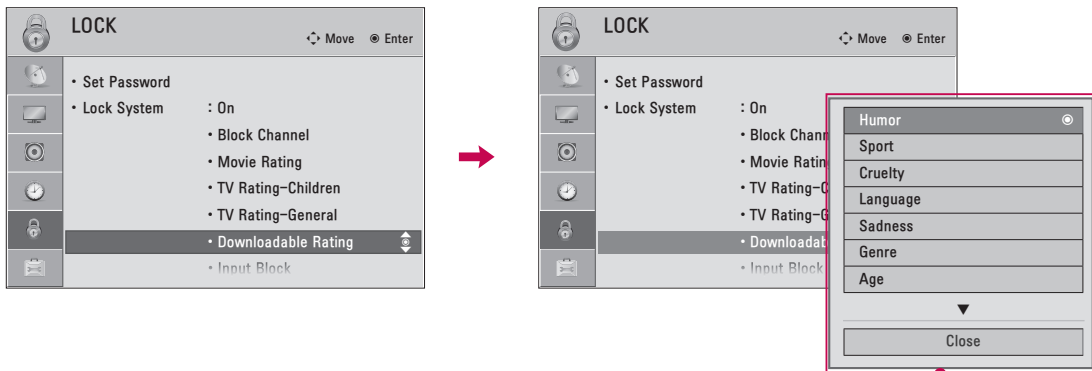

## DOWNLOADABLE RATING

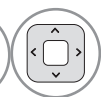
This function is available only for digital channels.

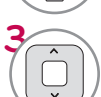
This function operates only when TV has received Region5 Rating data.

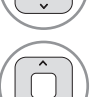

■ Based on rating table, your TV's OSD (On Screen Display) may differ slightly from what is shown in this manual.

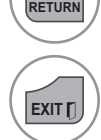
-    Select **LOCK**.
-  Input the password.
-  Select **Downloadable Rating**.
-   Select desired **Downloadable Rating** option.
-   Select desired option and block it.
-  Return to the previous menu.
-  Return to TV viewing.

■ If a Downloadable rating is locked, enter the password to unlock it temporarily.





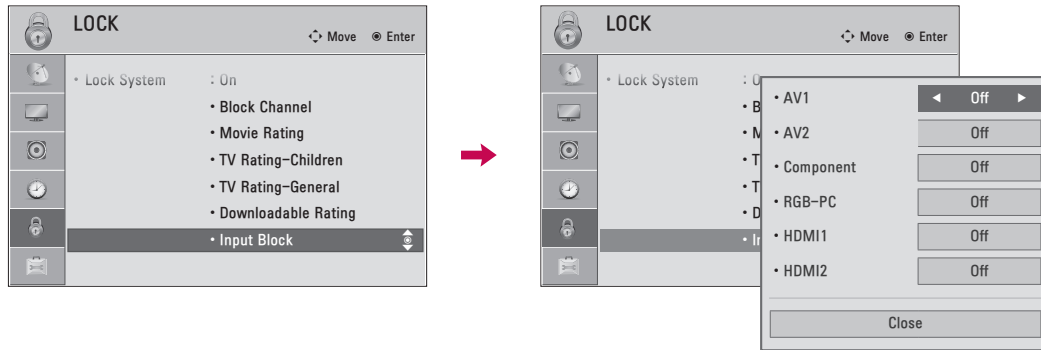

# EXTERNAL INPUT BLOCKING

Enables you to block an input.



i.e)

1    Select **LOCK**.

2  Input the password.

3  Select **Input Block**.

4   Select input source.

5  Select **On** or **Off**.

6  Return to the previous menu.

 Return to TV viewing.

# APPENDIX

## TROUBLESHOOTING

Abnormal Operation	
The remote control doesn't work	<ul style="list-style-type: none"> <li>Check to see if there is any object between the product and the remote control causing obstruction. Ensure you are pointing the remote control directly at the TV.</li> <li>Ensure that the batteries are installed with correct polarity (+ to +, - to -).</li> <li>Ensure that the correct remote operating mode is set: TV, VCR etc.</li> <li>Install new batteries. <small>*This feature is not available for all models.</small></li> </ul>
TV turns off suddenly	<ul style="list-style-type: none"> <li>Is the sleep timer set?</li> <li>Check the power control settings. Power interrupted.</li> </ul>

Video Problems	
No picture & No sound	<ul style="list-style-type: none"> <li>Check whether the product is turned on.</li> <li>Try another channel. The problem may be with the broadcast.</li> <li>Is the power cord inserted into wall power outlet?</li> <li>Check your antenna direction and/or location.</li> <li>Test the wall power outlet, plug another product's power cord into the outlet where the product's power cord was plugged in.</li> </ul>
Picture appears slowly after switching on	<ul style="list-style-type: none"> <li>This is normal, the image is muted during the product startup process. Please contact your service center, if the picture has not appeared after five minutes.</li> </ul>
No or poor color or poor picture	<ul style="list-style-type: none"> <li>Adjust Color in menu option.</li> <li>Keep a sufficient distance between the product and the VCR.</li> <li>Try another channel. The problem may be with the broadcast.</li> <li>Are the video cables installed properly?</li> <li>Activate any function to restore the brightness of the picture.</li> </ul>
Horizontal/vertical bars or picture shaking	<ul style="list-style-type: none"> <li>Check for local interference such as an electrical appliance or power tool.</li> </ul>
Poor reception on some channels	<ul style="list-style-type: none"> <li>Station or cable product experiencing problems, tune to another station.</li> <li>Station signal is weak, reorient antenna to receive weaker station.</li> <li>Check for sources of possible interference.</li> </ul>
Lines or streaks in pictures	<ul style="list-style-type: none"> <li>Check antenna (Change the direction of the antenna).</li> </ul>
No picture when connecting HDMI	<ul style="list-style-type: none"> <li>If an HDMI cable doesn't support High Speed HDMI, it can cause flickers or no screen display. In this case use the latest cables that support High Speed HDMI.</li> </ul>

Audio Problems	
No output from one of the speakers	<ul style="list-style-type: none"> <li>Adjust Balance in menu option.</li> </ul>
Unusual sound from inside the product	<ul style="list-style-type: none"> <li>A change in ambient humidity or temperature may result in an unusual noise when the product is turned on or off and does not indicate a fault with the product.</li> </ul>
No sound when connecting HDMI/USB	<ul style="list-style-type: none"> <li>Check High Speed HDMI cable.</li> <li>Check USB cable over version 2.0.</li> <li>Use normal MP3 file. <small>*This feature is not available for all models.</small></li> </ul>

PC Mode Problems	
The signal is out of range	<ul style="list-style-type: none"> <li>Adjust resolution, horizontal frequency, or vertical frequency on the PC.</li> <li>Check the input source.</li> </ul>
Vertical bar or stripe on background & Horizontal Noise & Incorrect position	<ul style="list-style-type: none"> <li>Activate the Auto configure feature or adjust size, phase, or H/V position. (Option)</li> </ul>
Screen color is unstable or single color	<ul style="list-style-type: none"> <li>Check the signal cable.</li> <li>Reinstall the PC video card.</li> </ul>
When connecting the HDMI cable to the PC, there is no audio.	<ul style="list-style-type: none"> <li>Check the manual for the video card in the PC to see if it supports HDMI audio and how to set it up properly.</li> </ul>

# APPENDIX

## MAINTENANCE

Early malfunctions can be prevented. Careful and regular cleaning can extend the amount of time you can enjoy your new TV.

Caution: Be sure to turn the power off and unplug the power cord before you begin any cleaning.

### Cleaning the Screen

- 1 Here's a great way to keep the dust off your screen for a while. Wet a soft cloth in a mixture of lukewarm water and a little fabric softener or dish washing detergent. Wring the cloth until it's almost dry, and then use it to wipe the screen.
- 2 Make sure the excess water is off the screen, and then let it air-dry before you turn on your TV.

### Cleaning the Cabinet

- To remove dirt or dust, wipe the cabinet with a soft, dry, lint-free cloth.
- Please be sure not to use a wet cloth.

### Extended Absence

#### CAUTION

- ▶ If you expect to leave your TV dormant for a long time (such as a vacation), it's a good idea to unplug the power cord to protect against possible damage from lightning or power surges.

# PRODUCT SPECIFICATIONS

MODELS		<b>26LD320H</b> (26LD320H-UA), <b>26LD340H</b> (26LD340H-UA), <b>26LD345H</b> (26LD345H-UA)	<b>32LD320H</b> (32LD320H-UA), <b>32LD325H</b> (32LD325H-UA), <b>32LD340H</b> (32LD340H-UA), <b>32LD345H</b> (32LD345H-UA)
Dimensions (Width x Height x Depth)	With stand	667.0 mm x 502.7 mm x 206.8 mm (26.2 inch x 19.7 inch x 8.1 inch)	805.0 mm x 585.0 mm x 206.8 mm (31.6 inch x 23.0 inch x 8.1 inch)
	Without stand	667.0 mm x 446.2 mm x 80.0 mm (26.2 inch x 17.5 inch x 3.1 inch)	805.0 mm x 528.2 mm x 108.9 mm (31.6 inch x 20.7 inch x 4.2 inch)
Weight	With stand	9.4 kg (20.7 lbs)	13.1 kg (28.8 lbs)
	Without stand	7.7 kg (16.9 lbs)	11.4 kg (25.1 lbs)
Current Value / Power consumption		1.0 A / 100 W	1.2 A / 120 W

MODELS		<b>37LD320H</b> (37LD320H-UA), <b>37LD325H</b> (37LD325H-UA), <b>37LD340H</b> (37LD340H-UA), <b>37LD345H</b> (37LD345H-UA)	<b>42LD320H</b> (42LD320H-UA), <b>42LD340H</b> (42LD340H-UA), <b>42LD345H</b> (42LD345H-UA)
Dimensions (Width x Height x Depth)	With stand	922.0 mm x 650.0 mm x 260.8 mm (36.2 inch x 25.5 inch x 10.2 inch)	1028.0 mm x 706.4 mm x 260.8 mm (40.4 inch x 27.8 inch x 10.2 inch)
	Without stand	922.0 mm x 595.0 mm x 88.0 mm (36.2 inch x 23.4 inch x 3.4 inch)	1028.0 mm x 655.0 mm x 88.7 mm (40.4 inch x 25.7 inch x 3.4 inch)
Weight	With stand	15.6 kg (34.3 lbs)	17.9 kg (39.4 lbs)
	Without stand	13.0 kg (28.6 lbs)	15.3 kg (33.7 lbs)
Current Value / Power consumption		1.7 A / 170 W	2.1 A / 210 W

MODELS		<b>32LD310H</b> (32LD310H-UA), <b>32LD330H</b> (32LD330H-UA)	<b>37LD310H</b> (37LD310H-UA), <b>37LD330H</b> (37LD330H-UA)
Dimensions (Width x Height x Depth)	With stand	805.0 mm x 583.0 mm x 223.8 mm (31.6 inch x 22.9 inch x 8.8 inch)	922.0 mm x 659.0 mm x 297.0 mm (36.2 inch x 25.9 inch x 11.6 inch)
	Without stand	805.0 mm x 528.2 mm x 108.9 mm (31.6 inch x 20.7 inch x 4.2 inch)	922.0 mm x 595.0 mm x 88.0 mm (36.2 inch x 23.4 inch x 3.4 inch)
Weight	With stand	12.6 kg (27.7 lbs)	15.0 kg (33.0 lbs)
	Without stand	11.4 kg (25.1 lbs)	13.2 kg (29.1 lbs)
Current Value / Power consumption		1.2 A / 120 W	1.7 A / 170 W

Power Requirement		AC 100-240 V ~ 50 / 60 Hz
Television System		NTSC-M, ATSC, 64 & 256 QAM
Program Coverage		VHF 2-13, UHF 14-69, CATV 1-135, DTV 2-69, CADTV 1-135
External Antenna Impedance		75 Ω
Environment condition	Operating Temperature	0 °C to 40 °C (32 °F to 104 °F)
	Operating Humidity	Less than 80 %
	Storage Temperature	-20 °C to 60 °C (-4 °F to 140 °F)
	Storage Humidity	Less than 85 %

■ The specifications shown above may be changed without prior notice for quality improvement.

# APPENDIX

## IR CODE

Code (Hexa)	Function	Note	Code (Hexa)	Function	Note
00	CH ^	Remote Control Button	B0	▶	Remote Control Button
01	CH v	Remote Control Button	B1	■	Remote Control Button
02	VOL +	Remote Control Button	BA		Remote Control Button
03	VOL -	Remote Control Button	D6	TV	Discrete IR Code (TV Input Selection)
06	➤	Remote Control Button	C4	POWER ON	Discrete IR Code (Only Power On)
07	➤	Remote Control Button	C5	POWER OFF	Discrete IR Code (Only Power Off)
08	⏻	Remote Control Button (Power On/Off)	5A	AV or AV1	Discrete IR Code (AV1 Input Selection)
09	MUTE	Remote Control Button	D0	AV2	Discrete IR Code (AV2 Input Selection)
0B	INPUT	Remote Control Button	BF	COMPONENT	Discrete IR Code (Component Input Selection)
0F	TV	Remote Control Button	D5	RGB-PC	Discrete IR Code (RGB-PC Input Selection)
10-19	Number 0-9	Remote Control Button	CE	HDMI1	Discrete IR Code (HDMI1 Input Selection)
1A	FLASHBK	Remote Control Button	CC	HDMI2	Discrete IR Code (HDMI2 Input Selection)
AA	INFO	Remote Control Button	E9	HDMI3	Discrete IR Code (HDMI3 Input Selection)
28	RETURN	Remote Control Button	DA	HDMI4	Discrete IR Code (HDMI4 Input Selection)
E8	ALAM	Remote Control Button	76	Ratio 4:3	Discrete IR Code (Only 4:3 Mode)
40	^	Remote Control Button	77	Ratio 16:9	Discrete IR Code (Only 16:9 Mode)
41	v	Remote Control Button	AF	Ratio Zoom	Discrete IR Code (Only Zoom Mode)
43	MENU	Remote Control Button			
44	ENTER	Remote Control Button			
0E	TIMER	Remote Control Button			
4C	- (Dash)	Remote Control Button			
5B	EXIT	Remote Control Button			
C3 or 61	BLUE	Remote Control Button			
C2 or 63	YELLOW	Remote Control Button			
C0 or 71	GREEN	Remote Control Button			
C1 or 72	RED	Remote Control Button			
79	RATIO	Remote Control Button			
0C	PORTAL	Remote Control Button			
8E	▶▶	Remote Control Button			
8F	◀◀	Remote Control Button			
AB	GUIDE	Remote Control Button			
39	CC	Remote Control Button			
CA	EJECT	Remote Control Button			
0A	SAP	Remote Control Button			

■ Use this feature depending on your models.

# OPEN SOURCE LICENSE

## GNU GENERAL PUBLIC LICENSE

Version 2, June 1991

Copyright (C) 1989, 1991 Free Software Foundation, Inc., 51 Franklin Street, Fifth Floor, Boston, MA 02110-1301 USA

Everyone is permitted to copy and distribute verbatim copies of this license document, but changing it is not allowed.

### Preamble

The licenses for most software are designed to take away your freedom to share and change it. By contrast, the GNU General Public License is intended to guarantee your freedom to share and change free software - to make sure the software is free for all its users. This General Public License applies to most of the Free Software Foundation's software and to any other program whose authors commit to using it. (Some other free software foundation software is covered by the GNU Lesser General Public License instead.) You can apply it to your programs, too.

When we speak of free software, we are referring to freedom, not price. Our General Public Licenses are designed to make sure that you have the freedom to distribute copies of free software (and charge for this service if you wish), that you receive source code or can get it if you want it, that you can change the software or use pieces of it in new free programs; and that you know you can do these things.

To protect your rights, we need to make restrictions that forbid anyone to deny you these rights or to ask you to surrender the rights. These restrictions translate to certain responsibilities for you if you distribute copies of the software, or if you modify it.

For example, if you distribute copies of such a program, whether gratis or for a fee, you must give the recipients all the rights that you have. You must make sure that they, too, receive or can get the source code. And you must show them these terms so they know their rights.

We protect your rights with two steps: (1) copyright the software, and (2) offer you this license which gives you legal permission to copy, distribute and/or modify the software.

Also, for each author's protection and ours, we want to make certain that everyone understands that there is no warranty for this free software. If the software is modified by someone else and passed on, we want its recipients to know that what they have is not the original, so that any problems introduced by others will not reflect on the original authors' reputations.

Finally, any free program is threatened constantly by software patents. We wish to avoid the danger that redistributors of a free program will individually obtain patent licenses, in effect making the program proprietary. To prevent this, we have made it clear that any patent must be

licensed for everyone's free use or not licensed at all.

The precise terms and conditions for copying, distribution and modification follow.

### GNU GENERAL PUBLIC LICENSE TERMS AND CONDITIONS FOR COPYING, DISTRIBUTION AND MODIFICATION

0. This license applies to any program or other work which contains a notice placed by the copyright holder saying it may be distributed under the terms of this General Public License. The "Program", below, refers to any such program or work, and a "work based on the Program" means either the Program or any derivative work under copyright law: that is to say, a work containing the Program or a portion of it, either verbatim or with modifications and/or translated into another language. (Hereinafter, translation is included without limitation in the term "modification".) Each licensee is addressed as "you".

Activities other than copying, distribution and modification are not covered by this license; they are outside its scope. The act of running the Program is not restricted, and the output from the program is covered only if its contents constitute a work based on the program (independent of having been made by running the program). Whether that is true depends on what the program does.

1. You may copy and distribute verbatim copies of the program's source code as you receive it, in any medium, provided that you conspicuously and appropriately publish on each copy an appropriate copyright notice and disclaimer of warranty; keep intact all the notices that refer to this license and to the absence of any warranty; and give any other recipients of the program a copy of this license along with the Program.

You may charge a fee for the physical act of transferring a copy, and you may at your option offer warranty protection in exchange for a fee.

2. You may modify your copy or copies of the program or any portion of it, thus forming a work based on the Program, and copy and distribute such modifications or work under the terms of section 1 above, provided that you also meet all of these conditions:

a) You must cause the modified files to carry prominent notices stating that you changed the files and the date of any change.

# APPENDIX

- b) You must cause any work that you distribute or publish, that in whole or in part contains or is derived from the Program or any part thereof, to be licensed as a whole at no charge to all third parties under the terms of this license.
- c) If the modified program normally reads commands interactively when run, you must cause it, when started running for such interactive use in the most ordinary way, to print or display an announcement including an appropriate copyright notice and a notice that there is no warranty (or else, saying that you provide a warranty) and that users may redistribute the program under these conditions, and telling the user how to view a copy of this license. (Exception: if the Program itself is interactive but does not normally print such an announcement, your work based on the Program is not required to print an announcement.)

These requirements apply to the modified work as a whole. If identifiable sections of that work are not derived from the Program, and can be reasonably considered independent and separate works in themselves, then this license, and its terms, do not apply to those sections when you distribute them as separate works. But when you distribute the same sections as part of a whole which is a work based on the Program, the distribution of the whole must be on the terms of this license, whose permissions for other licensees extend to the entire whole, and thus to each and every part regardless of who wrote it.

Thus, it is not the intent of this section to claim rights or contest your rights to work written entirely by you; rather, the intent is to exercise the right to control the distribution of derivative or collective works based on the program.

In addition, mere aggregation of another work not based on the program with the Program (or with a work based on the program) on a volume of a storage or distribution medium does not bring the other work under the scope of this license.

- 3. You may copy and distribute the program (or a work based on it, under section 2) in object code or executable form under the terms of sections 1 and 2 above provided that you also do one of the following:
  - a) Accompany it with the complete corresponding machine-readable source code, which must be distributed under the terms of sections 1 and 2 above on a medium customarily used for software interchange; or,
  - b) Accompany it with a written offer, valid for at least three years, to give any third party, for a charge no more than your cost of physically performing source distribution, a complete machine-readable copy of the corresponding source code, to be distributed under the terms of sections 1 and 2 above on a medium customarily used for software interchange; or,

- c) Accompany it with the information you received as to the offer to distribute corresponding source code. (This alternative is allowed only for noncommercial distribution and only if you received the program in object code or executable form with such an offer, in accord with Subsection b above.)

The source code for a work means the preferred form of the work for making modifications to it. For an executable work, complete source code means all the source code for all modules it contains, plus any associated interface definition files, plus the scripts used to control compilation and installation of the executable. However, as a special exception, the source code distributed need not include anything that is normally distributed (in either source or binary form) with the major components (compiler, kernel, and so on) of the operating system on which the executable runs, unless that component itself accompanies the executable.

If distribution of executable or object code is made by offering access to copy from a designated place, then offering equivalent access to copy the source code from the same place counts as distribution of the source code, even though third parties are not compelled to copy the source along with the object code.

- 4. You may not copy, modify, sublicense, or distribute the Program except as expressly provided under this license. Any attempt otherwise to copy, modify, sublicense or distribute the Program is void, and will automatically terminate your rights under this license. However, parties who have received copies, or rights, from you under this license will not have their licenses terminated so long as such parties remain in full compliance.
- 5. You are not required to accept this license, since you have not signed it. However, nothing else grants you permission to modify or distribute the Program or its derivative works. These actions are prohibited by law if you do not accept this license. Therefore, by modifying or distributing the program (or any work based on the program), you indicate your acceptance of this license to do so, and all its terms and conditions for copying, distributing or modifying the program or works based on it.
- 6. Each time you redistribute the program (or any work based on the Program), the recipient automatically receives a license from the original licensor to copy, distribute or modify the Program subject to these terms and conditions. You may not impose any further restrictions on the recipients' exercise of the rights granted herein. You are not responsible for enforcing compliance by third parties to this license.



7. If, as a consequence of a court judgment or allegation of patent infringement or for any other reason (not limited to patent issues), conditions are imposed on you (whether by court order, agreement or otherwise) that contradict the conditions of this license, they do not excuse you from the conditions of this license. If you cannot distribute so as to satisfy simultaneously your obligations under this license and any other pertinent obligations, then as a consequence you may not distribute the program at all. For example, if a patent license would not permit royalty-free redistribution of the program by all those who receive copies directly or indirectly through you, then the only way you could satisfy both it and this license would be to refrain entirely from distribution of the program.

If any portion of this section is held invalid or unenforceable under any particular circumstance, the balance of the section is intended to apply and the section as a whole is intended to apply in other circumstances.

It is not the purpose of this section to induce you to infringe any patents or other property right claims or to contest validity of any such claims; this section has the sole purpose of protecting the integrity of the free software distribution system, which is implemented by public license practices. Many people have made generous contributions to the wide range of software distributed through that system in reliance on consistent application of that system; it is up to the author/donor to decide if he or she is willing to distribute software through any other system and a licensee cannot impose that choice.

This section is intended to make thoroughly clear what is believed to be a consequence of the rest of this license.

8. If the distribution and/or use of the program is restricted in certain countries either by patents or by copyrighted interfaces, the original copyright holder who places the program under this license may add an explicit geographical distribution limitation excluding those countries, so that distribution is permitted only in or among countries not thus excluded. In such case, this license incorporates the limitation as if written in the body of this license.
9. The Free Software Foundation may publish revised and/or new versions of the General Public License from time to time. Such new versions will be similar in spirit to the present version, but may differ in detail to address new problems or concerns.

Each version is given a distinguishing version number. If

the program specifies a version number of this license which applies to it and "any later version", you have the option of following the terms and conditions either of that version or of any later version published by the Free Software Foundation. If the program does not specify a version number of this license, you may choose any version ever published by the Free Software Foundation.

10. If you wish to incorporate parts of the program into other free programs whose distribution conditions are different, write to the author to ask for permission. For software which is copyrighted by the Free Software Foundation, write to the Free Software Foundation; we sometimes make exceptions for this. Our decision will be guided by the two goals of preserving the free status of all derivatives of our free software and of promoting the sharing and reuse of software generally.

#### NO WARRANTY

11. BECAUSE THE PROGRAM IS LICENSED FREE OF CHARGE, THERE IS NO WARRANTY FOR THE PROGRAM, TO THE EXTENT PERMITTED BY APPLICABLE LAW. EXCEPT WHEN OTHERWISE STATED IN WRITING THE COPYRIGHT HOLDERS AND/OR OTHER PARTIES PROVIDE THE PROGRAM "AS IS" WITHOUT WARRANTY OF ANY KIND, EITHER EXPRESSED OR IMPLIED, INCLUDING, BUT NOT LIMITED TO, THE IMPLIED WARRANTIES OF MERCHANTABILITY AND FITNESS FOR A PARTICULAR PURPOSE. THE ENTIRE RISK AS TO THE QUALITY AND PERFORMANCE OF THE PROGRAM IS WITH YOU. SHOULD THE PROGRAM PROVE DEFECTIVE, YOU ASSUME THE COST OF ALL NECESSARY SERVICING, REPAIR OR CORRECTION.
12. IN NO EVENT UNLESS REQUIRED BY APPLICABLE LAW OR AGREED TO IN WRITING WILL ANY COPYRIGHT HOLDER, OR ANY OTHER PARTY WHO MAY MODIFY AND/OR REDISTRIBUTE THE PROGRAM AS PERMITTED ABOVE, BE LIABLE TO YOU FOR DAMAGES, INCLUDING ANY GENERAL, SPECIAL, INCIDENTAL OR CONSEQUENTIAL DAMAGES ARISING OUT OF THE USE OR INABILITY TO USE THE PROGRAM (INCLUDING BUT NOT LIMITED TO LOSS OF DATA OR DATA BEING RENDERED INACCURATE OR LOSSES SUSTAINED BY YOU OR THIRD PARTIES OR A FAILURE OF THE PROGRAM TO OPERATE WITH ANY OTHER PROGRAMS), EVEN IF SUCH HOLDER OR OTHER PARTY HAS BEEN ADVISED OF THE POSSIBILITY OF SUCH DAMAGES.

# APPENDIX

## END OF TERMS AND CONDITIONS

### How to apply these terms to your new programs

If you develop a new program, and you want it to be of the greatest possible use to the public, the best way to achieve this is to make it free software which everyone can redistribute and change under these terms.

To do so, attach the following notices to the program. It is safest to attach them to the start of each source file to most effectively convey the exclusion of warranty; and each file should have at least the "copyright" line and a pointer to where the full notice is found.

one line to give the program's name and a brief idea of what it does.

Copyright (C) <year> <name of author>

This program is free software; you can redistribute it and/or modify it under the terms of the GNU General Public License as published by the Free Software Foundation; either version 2 of the license, or (at your option) any later version.

This program is distributed in the hope that it will be useful, but WITHOUT ANY WARRANTY; without even the implied warranty of MERCHANTABILITY or FITNESS FOR A PARTICULAR PURPOSE. See the GNU General Public License for more details.

You should have received a copy of the GNU General Public License along with this program; if not, write to the Free Software Foundation, Inc., 51 Franklin Street, Fifth Floor, Boston, MA 02110-1301 USA.

Also add information on how to contact you by electronic and paper mail.

If the program is interactive, make it output a short notice like this when it starts in an interactive mode:

Gnomovision version 69, Copyright (C) year name of author  
Gnomovision comes with ABSOLUTELY NO WARRANTY;  
for details type 'show w'. This is free software, and you are  
welcome to redistribute it under certain conditions; type  
'show c' for details.

The hypothetical commands 'show w' and 'show c' should show the appropriate parts of the General Public License. Of course, the commands you use may be called something other than 'show w' and 'show c'; they could even be mouse-clicks or menu items-whatever suits your program.

You should also get your employer (if you work as a programmer) or your school, if any, to sign a "copyright disclaimer" for the program, if necessary. Here is a sample; alter the names:

Yoyodyne, Inc., hereby disclaims all copyright interest in the program 'Gnomovision' (which makes passes at compilers) written by James Hacker.

signature of Ty Coon, 1 April 1989  
Ty Coon, President of Vice

This General Public License does not permit incorporating your program into proprietary programs. If your program is a subroutine library, you may consider it more useful to permit linking proprietary applications with the library. If this is what you want to do, use the GNU Lesser General Public License instead of this license.

# GNU LESSER GENERAL PUBLIC LICENSE

Version 2.1, February 1999

Copyright (C) 1991, 1999 Free Software Foundation, Inc. 51 Franklin Street, Fifth Floor, Boston, MA 02110-1301 USA  
Everyone is permitted to copy and distribute verbatim copies of this license document, but changing it is not allowed.

[This is the first released version of the Lesser GPL. It also counts as the successor of the GNU Library Public License, version 2, hence the version number 2.1.]

## Preamble

The licenses for most software are designed to take away your freedom to share and change it. By contrast, the GNU General Public Licenses are intended to guarantee your freedom to share and change free software - to make sure the software is free for all its users.

This license, the Lesser General Public License, applies to some specially designated software packages - typically libraries - of the Free Software Foundation and other authors who decide to use it. You can use it too, but we suggest you first think carefully about whether this license or the ordinary General Public License is the better strategy to use in any particular case, based on the explanations below.

When we speak of free software, we are referring to freedom of use, not price. Our General Public Licenses are designed to make sure that you have the freedom to distribute copies of free software (and charge for this service if you wish); that you receive source code or can get it if you want it; that you can change the software and use pieces of it in new free programs; and that you are informed that you can do these things.

To protect your rights, we need to make restrictions that forbid distributors to deny you these rights or to ask you to surrender these rights. These restrictions translate to certain responsibilities for you if you distribute copies of the library or if you modify it.

For example, if you distribute copies of the library, whether gratis or for a fee, you must give the recipients all the rights that we gave you. You must make sure that they, too, receive or can get the source code. If you link other code with the library, you must provide complete object files to the recipients, so that they can relink them with the library after making changes to the library and recompiling it. And you must show them these terms so they know their rights.

We protect your rights with a two-step method: (1) we copy-right the library, and (2) we offer you this license, which gives you legal permission to copy, distribute and/or modify the library.

To protect each distributor, we want to make it very clear

that there is no warranty for the free library. Also, if the library is modified by someone else and passed on, the recipients should know that what they have is not the original version, so that the original author's reputation will not be affected by problems that might be introduced by others.

Finally, software patents pose a constant threat to the existence of any free program. We wish to make sure that a company cannot effectively restrict the users of a free program by obtaining a restrictive license from a patent holder. Therefore, we insist that any patent license obtained for a version of the library must be consistent with the full freedom of use specified in this license.

Most GNU software, including some libraries, is covered by the ordinary GNU General Public License. This license, the GNU Lesser General Public License, applies to certain designated libraries, and is quite different from the ordinary General Public License. We use this license for certain libraries in order to permit linking those libraries into non-free programs.

When a program is linked with a library, whether statically or using a shared library, the combination of the two is legally speaking a combined work, a derivative of the original library. The ordinary General Public License therefore permits such linking only if the entire combination fits its criteria of freedom. The Lesser General Public License permits more lax criteria for linking other code with the library.

We call this license the "Lesser" General Public License because it does Less to protect the user's freedom than the ordinary General Public License. It also provides other free software developers Less of an advantage over competing non-free programs. These disadvantages are the reason we use the ordinary General Public License for many libraries. However, the Lesser license provides advantages in certain special circumstances.

For example, on rare occasions, there may be a special need to encourage the widest possible use of a certain library, so that it becomes a de-facto standard. To achieve this, non-free programs must be allowed to use the library. A more frequent case is that a free library does the same job as widely used non-free libraries. In this case, there is little to gain by limiting the free library to free software only, so we use the Lesser General Public License.

In other cases, permission to use a particular library in non-free programs enables a greater number of people to use a large body of free software. For example, permission to use the GNU C Library in non-free programs enables many more people to use the whole GNU operating system, as well as its variant, the GNU/Linux operating system.

# APPENDIX

Although the Lesser General Public License is less protective of the users' freedom, it does ensure that the user of a program that is linked with the Library has the freedom and the wherewithal to run that program using a modified version of the Library.

The precise terms and conditions for copying, distribution and modification follow. Pay close attention to the difference between a "work based on the library" and a "work that uses the library". The former contains code derived from the library, whereas the latter must be combined with the library in order to run.

## GNU LESSER GENERAL PUBLIC LICENSE TERMS AND CONDITIONS FOR COPYING, DISTRIBUTION AND MODIFICATION

0. This license agreement applies to any software library or other program which contains a notice placed by the copyright holder or other authorized party saying it may be distributed under the terms of this Lesser General Public License (also called "this license"). Each license is addressed as "you".

A "library" means a collection of software functions and/or data prepared so as to be conveniently linked with application programs (which use some of those functions and data) to form executables.

The "Library", below, refers to any such software library or work which has been distributed under these terms. A "work based on the Library" means either the Library or any derivative work under copyright law: that is to say, a work containing the library or a portion of it, either verbatim or with modifications and/or translated straightforwardly into another language. (Hereinafter, translation is included without limitation in the term "modification".)

"Source code" for a work means the preferred form of the work for making modifications to it. For a library, complete source code means all the source code for all modules it contains, plus any associated interface definition files, plus the scripts used to control compilation and installation of the library.

Activities other than copying, distribution and modification are not covered by this license; they are outside its scope. The act of running a program using the Library is not restricted, and output from such a program is covered only if its contents constitute a work based on the library (independent of the use of the Library in a tool for writing it). Whether that is true depends on what the library does and what the program that uses the library does.

1. You may copy and distribute verbatim copies of the library's complete source code as you receive it, in any medium, provided that you conspicuously and appropriately publish on each copy an appropriate copyright notice and disclaimer of warranty; keep intact all the

notices that refer to this license and to the absence of any warranty; and distribute a copy of this license along with the Library.

You may charge a fee for the physical act of transferring a copy, and you may at your option offer warranty protection in exchange for a fee.

2. You may modify your copy or copies of the Library or any portion of it, thus forming a work based on the Library, and copy and distribute such modifications or work under the terms of section 1 above, provided that you also meet all of these conditions:
- The modified work must itself be a software library.
  - You must cause the files modified to carry prominent notices stating that you changed the files and the date of any change.
  - You must cause the whole of the work to be licensed at no charge to all third parties under the terms of this license.
  - If a facility in the modified Library refers to a function or a table of data to be supplied by an application program that uses the facility, other than as an argument passed when the facility is invoked, then you must make a good faith effort to ensure that, in the event an application does not supply such function or table, the facility still operates, and performs whatever part of its purpose remains meaningful.

(For example, a function in a library to compute square roots has a purpose that is entirely well-defined independent of the application. Therefore, Subsection 2d requires that any application-supplied function or table used by this function must be optional: if the application does not supply it, the square root function must still compute square roots.)

These requirements apply to the modified work as a whole. If identifiable sections of that work are not derived from the library, and can be reasonably considered independent and separate works in themselves, then this license, and its terms, do not apply to those sections when you distribute them as separate works. But when you distribute the same sections as part of a whole which is a work based on the library, the distribution of the whole must be on the terms of this license, whose permissions for other licenses extend to the entire whole, and thus to each and every part regardless of who wrote it.

Thus, it is not the intent of this section to claim rights or contest your rights to work written entirely by you; rather, the intent is to exercise the right to control the distribution of derivative or collective works based on the library.

In addition, mere aggregation of another work not based on the library with the library (or with a work based on the library) on a volume of a storage or distribution medium does not bring the other work under the scope of this license.

3. You may opt to apply the terms of the ordinary GNU General Public License instead of this License to a given copy of the Library. To do this, you must alter all the notices that refer to this License, so that they refer to the ordinary GNU General Public License, version 2, instead of to this License. (If a newer version than version 2 of the ordinary GNU General Public License has appeared, then you can specify that version instead if you wish.) Do not make any other change in these notices. Once this change is made in a given copy, it is irreversible for that copy, so the ordinary GNU General Public License applies to all subsequent copies and derivative works made from that copy. This option is useful when you wish to copy part of the code of the library into a program that is not a library.
4. You may copy and distribute the library (or a portion or derivative of it, under Section 2) in object code or executable form under the terms of Sections 1 and 2 above provided that you accompany it with the complete corresponding machine-readable source code, which must be distributed under the terms of sections 1 and 2 above on a medium customarily used for software interchange. If distribution of object code is made by offering access to copy from a designated place, then offering equivalent access to copy the source code from the same place satisfies the requirement to distribute the source code, even though third parties are not compelled to copy the source along with the object code.
5. A program that contains no derivative of any portion of the Library, but is designed to work with the Library by being compiled or linked with it, is called a "work that uses the Library". Such a work, in isolation, is not a derivative work of the Library, and therefore falls outside the scope of this license.

However, linking a "work that uses the library" with the Library creates an executable that is a derivative of the Library (because it contains portions of the library), rather than a "work that uses the library". The executable is therefore covered by this license. Section 6 states terms for distribution of such executable.

When a "work that uses the library" uses material from a header file that is part of the library, the object code for the work may be a derivative work of the library even though the source code is not. Whether this is true is especially significant if the work can be linked without the library, or if the work is itself a library. The threshold for this to be true is not precisely defined by law.

If such an object file uses only numerical parameters, data structure layouts and accessories, and small macros and small inline functions (ten lines or less in length), then the use of the object file is unrestricted, regardless of whether it is legally a derivative work. (Executable containing this object code plus portions of

the library will still fall under Section 6.)

Otherwise, if the work is a derivative of the library, you may distribute the object code for the work under the terms of Section 6. Any executable containing that work also fall under Section 6, whether or not they are linked directly with the library itself.

6. As an exception to the sections above, you may also combine or link a "work that uses the library" with the library to produce a work containing portions of the library, and distribute that work under terms of your choice, provided that the terms permit modification of the work for the customer's own use and reverse engineering for debugging such modifications.

You must give prominent notice with each copy of the work that the library is used in it and that the Library and its use are covered by this license. You must supply a copy of this license. If the work during execution displays copyright notices, you must include the copyright notice for the library among them, as well as a reference directing the user to the copy of this license. Also, you must do one of these things:

- a) Accompany the work with the complete corresponding machine-readable source code for the library including whatever changes were used in the work (which must be distributed under Sections 1 and 2 above); and, if the work is an executable linked with the Library, with the complete machine-readable "work that uses the Library", as object code and/or source code, so that the user can modify the library and then relink to produce a modified executable containing the modified library. (It is understood that the user who changes the contents of definitions files in the library will not necessarily be able to recompile the application to use the modified definitions.)
- b) Use a suitable shared library mechanism for linking with the library. A suitable mechanism is one that (1) uses at run time a copy of the library already present on the user's computer system, rather than copying library functions into the executable, and (2) will operate properly with a modified version of the library, if the user installs one, as long as the modified version is interface-compatible with the version that the work was made with.
- c) Accompany the work with a written offer, valid for at least three years, to give the same user the materials specified in Subsection 6, above, for a charge no more than the cost of performing this distribution.
- d) If distribution of the work is made by offering access to copy from a designated place, offer equivalent access to copy the above specified materials from the same place.
- e) Verify that the user has already received a copy of these materials or that you have already sent this user a copy.

# APPENDIX

For an executable, the required form of the "work that uses the library" must include any data and utility programs needed for reproducing the executable from it. However, as a special exception, the materials to be distributed need not include anything that is normally distributed (in either source or binary form) with the major components (compiler, kernel, and so on) of the operating system on which the executable runs, unless that component itself accompanies the executable.

It may happen that this requirement contradicts the license restrictions of other proprietary libraries that do not normally accompany the operating system. Such a contradiction means you cannot use both them and the library together in an executable that you distribute.

7. You may place library facilities that are a work based on the library side-by-side in a single library together with other library facilities not covered by this license, and distribute such a combined library, provided that the separate distribution of the work based on the Library and of the other library facilities is otherwise permitted, and provided that you do these two things:
  - a) Accompany the combined library with a copy of the same work based on the Library, uncombined with any other library facilities. This must be distributed under the terms of the sections above.
  - b) Give prominent notice with the combined library of the fact that part of it is a work based on the library, and explaining where to find the accompanying uncombined form of the same work.
8. You may not copy, modify, sublicense, link with, or distribute the library except as expressly provided under this license. Any attempt otherwise to copy, modify, sublicense, link with, or distribute the library is void, and will automatically terminate your rights under this license. However, parties who have received copies, or rights, from you under this license will not have their licenses terminated so long as such parties remain in full compliance.
9. You are not required to accept this license, since you have not signed it. However, nothing else grants you permission to modify or distribute the library or its derivative works. These actions are prohibited by law if you do not accept this license. Therefore, by modifying or distributing the library (or any work based on the library), you indicate your acceptance of this license to do so, and all its terms and conditions for copying, distributing or modifying the library or works based on it.
10. Each time you redistribute the library (or any work based on the Library), the recipient automatically receives a license from the original licensor to copy, distribute, link with or modify the library subject to these terms and conditions. You may not impose any further restrictions on the recipients' exercise of the rights granted herein.

You are not responsible for enforcing compliance by third parties with this license.

11. If, as a consequence of a court judgment or allegation of patent infringement or for any other reason (not limited to patent issues), conditions are imposed on you (whether by court order, agreement or otherwise) that contradict the conditions of this license, they do not excuse you from the conditions of this license. If you cannot distribute so as to satisfy simultaneously your obligations under this license and any other pertinent obligations, then as a consequence you may not distribute the library at all. For example, if a patent license would not permit royalty-free redistribution of the library by all those who receive copies directly or indirectly through you, then the only way you could satisfy both it and this license would be to refrain entirely from distribution of the library.

If any portion of this section is held invalid or unenforceable under any particular circumstance, the balance of the section is intended to apply, and the section as a whole is intended to apply in other circumstances.

It is not the purpose of this section to induce you to infringe any patents or other property right claims or to contest validity of any such claims; this section has the sole purpose of protecting the integrity of the free software distribution system which is implemented by public license practices. Many people have made generous contributions to the wide range of software distributed through that system in reliance on consistent application of that system; it is up to the author/donor to decide if he or she is willing to distribute software through any other system and a license cannot impose that choice.

This section is intended to make thoroughly clear what is believed to be a consequence of the rest of this license.
12. If the distribution and/or use of the library is restricted in certain countries either by patents or by copyrighted interfaces, the original copyright holder who places the library under this license may add an explicit geographical distribution limitation excluding those countries, so that distribution is permitted only in or among countries not thus excluded. In such case, this license incorporates the limitation as if written in the body of this license.
13. The Free Software Foundation may publish revised and/or new versions of the Lesser General Public License from time to time. Such new versions will be similar in spirit to the present version, but may differ in detail to address new problems or concerns.

Each version is given a distinguishing version number. If the library specifies a version number of this license which applies to it and "any later version", you have the option of following the terms and conditions either of that version or of any later version published by the Free Software Foundation.

If the library does not specify a license version number, you may choose any version ever published by the Free Software Foundation.

14. If you wish to incorporate parts of the library into other free programs whose distribution conditions are incompatible with these, write to the author to ask for permission. For software which is copyrighted by the Free Software Foundation, write to the Free Software Foundation; we sometimes make exceptions for this. Our decision will be guided by the two goals of preserving the free status of all derivatives of our free software and of promoting the sharing and reuse of software generally.

#### NO WARRANTY

15. BECAUSE THE LIBRARY IS LICENSED FREE OF CHARGE, THERE IS NO WARRANTY FOR THE LIBRARY, TO THE EXTENT PERMITTED BY APPLICABLE LAW. EXCEPT WHEN OTHERWISE STATED IN WRITING THE COPYRIGHT HOLDERS AND/OR OTHER PARTIES PROVIDE THE LIBRARY "AS IS" WITHOUT WARRANTY OF ANY KIND, EITHER EXPRESSED OR IMPLIED, INCLUDING, BUT NOT LIMITED TO, THE IMPLIED WARRANTIES OF MERCHANTABILITY AND FITNESS FOR A PARTICULAR PURPOSE. THE ENTIRE RISK AS TO THE QUALITY AND PERFORMANCE OF THE LIBRARY IS WITH YOU. SHOULD THE LIBRARY PROVE DEFECTIVE, YOU ASSUME THE COST OF ALL NECESSARY SERVICING, REPAIR OR CORRECTION.

16. IN NO EVENT UNLESS REQUIRED BY APPLICABLE LAW OR AGREED TO IN WRITING WILL ANY COPYRIGHT HOLDER, OR ANY OTHER PARTY WHO MAY MODIFY AND/OR REDISTRIBUTE THE LIBRARY AS PERMITTED ABOVE, BE LIABLE TO YOU FOR DAMAGES, INCLUDING ANY GENERAL, SPECIAL, INCIDENTAL OR CONSEQUENTIAL DAMAGES ARISING OUT OF THE USE OR INABILITY TO USE THE LIBRARY (INCLUDING BUT NOT LIMITED TO LOSS OF DATA OR DATA BEING RENDERED INACCURATE OR LOSSES SUSTAINED BY YOU OR THIRD PARTIES OR A FAILURE OF THE LIBRARY TO OPERATE WITH ANY OTHER SOFTWARE), EVEN IF SUCH HOLDER OR OTHER PARTY HAS BEEN ADVISED OF THE POSSIBILITY OF SUCH DAMAGES.

#### END OF TERMS AND CONDITIONS

How to apply these terms to your new libraries

If you develop a new library, and you want it to be of the greatest possible use to the public, we recommend making

it free software that everyone can redistribute and change. You can do so by permitting redistribution under these terms (or, alternatively, under the terms of the ordinary General Public License).

To apply these terms, attach the following notices to the library. It is safest to attach them to the start of each source file to most effectively convey the exclusion of warranty; and each file should have at least the "copyright" line and a pointer to where the full notice is found.

one line to give the library's name and a brief idea of what it does.

Copyright (C) <year> <name of author>

This library is free software; you can redistribute it and/or modify it under the terms of the GNU Lesser General Public License as published by the Free Software Foundation; either version 2.1 of the license, or (at your option) any later version.

This library is distributed in the hope that it will be useful, but WITHOUT ANY WARRANTY; without even the implied warranty of MERCHANTABILITY or FITNESS FOR A PARTICULAR PURPOSE. See the GNU Lesser General Public License for more details.

You should have received a copy of the GNU Lesser General Public License along with this library; if not, write to the Free Software Foundation, Inc., 51 Franklin Street, Fifth Floor, Boston, MA 02110-1301 USA

Also add information on how to contact you by electronic and paper mail.

You should also get your employer (if you work as a programmer) or your school, if any, to sign a "copyright disclaimer" for the library, if necessary. Here is a sample; alter the names:

Yoyodyne, Inc., hereby disclaims all copyright interest in the library 'Frob' (a library for tweaking knobs) written by James Random Hacker.

signature of Ty Coon, 1 April 1990

Ty Coon, President of Vice

## MOZILLA PUBLIC LICENSE

Version 1.1

### 1. Definitions.

1.0.1. "Commercial use" means distribution or otherwise making the covered code available to a third party.

1.1. "Contributor" means each entity that creates or contributes to the creation of modifications.

1.2. "Contributor version" means the combination of the original code, prior modifications used by a contributor, and the modifications made by that particular contributor.

1.3. "Covered code" means the original code or modifications or the combination of the original code and modifications, in each case including portions thereof.

1.4. "Electronic distribution mechanism" means a mechanism generally accepted in the software development community for the electronic transfer of data.

1.5. "Executable" means covered code in any form other than source code.

1.6. "Initial developer" means the individual or entity identified as the initial Developer in the Source Code notice required by exhibit A.

1.7. "Larger work" means a work which combines covered code or portions thereof with code not governed by the terms of this License.

1.8. "License" means this document.

1.8.1. "Licensable" means having the right to grant, to the maximum extent possible, whether at the time of the initial grant or subsequently acquired, any and all of the rights conveyed herein.

1.9. "Modifications" means any addition to or deletion from the substance or structure of either the original code or any previous modifications. When covered code is released as a series of files, a modification is:

A. Any addition to or deletion from the contents of a file containing original code or previous modifications.

B. Any new file that contains any part of the original code or previous modifications.

1.10. "Original code" means source code of computer software code which is described in the source code notice required by exhibit as original code, and

which, at the time of its release under this license is not already covered code governed by this license.

1.10.1. "Patent claims" means any patent claim(s), now owned or hereafter acquired, including without limitation, method, process, and apparatus claims, in any patent licensable by grantor.

1.11. "Source code" means the preferred form of the covered code for making modifications to it, including all modules it contains, plus any associated interface definition files, scripts used to control compilation and installation of an executable, or source code differential comparisons against either the original code or another well known, available covered code of the contributor's choice. The source code can be in a compressed or archival form, provided the appropriate decompression or de-archiving software is widely available for no charge.

1.12. "You" (or "Your") means an individual or a legal entity exercising rights under, and complying with all of the terms of, this license or a future version of this license issued under section 6.1.

For legal entities, "You" includes any entity which controls, is controlled by, or is under common control with You. For purposes of this definition, "control" means (a) the power, direct or indirect, to cause the direction or management of such entity, whether by contract or otherwise, or (b) ownership of more than fifty percent (50%) of the outstanding shares or beneficial ownership of such entity.

### 2. Source Code License.

2.1. The initial developer grant.

The initial developer hereby grants You a world-wide, royalty-free, non-exclusive license, subject to third party intellectual property claims:

a) under intellectual property rights (other than patent or trademark) licensable by initial developer to use, reproduce, modify, display, perform, sublicense and distribute the original code (or portions thereof) with or without modifications, and/or as part of a larger work; and

(b) under patents claims infringed by the making, using or selling of original code, to make, have made, use, practice, sell, and offer for sale, and/or otherwise dispose of the original code (or portions thereof).



- (c) the licenses granted in this section 2.1(a) and (b) are effective on the date Initial developer first distributes original code under the terms of this license.
- (d) Notwithstanding section 2.1(b) above, no patent license is granted: 1) for code that You delete from the original Code; 2) separate from the original code; or 3) for infringements caused by: i) the modification of the original code or ii) the combination of the original code with other software or devices.

## 2.2. Contributor Grant.

Subject to third party intellectual property claims, each contributor hereby grants You a world-wide, royalty-free, non-exclusive license

- (a) under intellectual property rights (other than patent or trademark) licensable by contributor, to use, reproduce, modify, display, perform, sublicense and distribute the modifications created by such contributor (or portions thereof) either on an unmodified basis, with other modifications, as covered code and/or as part of a larger work; and
- (b) under patent claims infringed by the making, using, or selling of modifications made by that contributor either alone and/or in combination with its contributor version (or portions of such combination), to make, use, sell, offer for sale, have made, and/or otherwise dispose of: 1) modifications made by that contributor (or portions thereof); and 2) the combination of modifications made by that contributor with its contributor version (or portions of such combination).
- (c) the licenses granted in sections 2.2(a) and 2.2(b) are effective on the date contributor first makes commercial use of the covered code.
- (d) Notwithstanding section 2.2(b) above, no patent license is granted: 1) for any code that contributor has deleted from the contributor version; 2) separate from the contributor version; 3) for infringements caused by: i) third party modifications of contributor version or ii) the combination of modifications made by that contributor with other software (except as part of the contributor version) or other devices; or 4) under patent claims infringed by covered code in the absence of modifications made by that contributor.

## 3. Distribution Obligations.

### 3.1. Application of license.

The modifications which You create or to which you contribute are governed by the terms of this license, including without limitation section 2.2. The source code version of covered code may be distributed only under the terms of this license or a future version of this license released under section 6.1, and you must include a copy of this license with every copy of the source code you distribute. You may not

offer or impose any terms on any source code version that alters or restricts the applicable version of this license or the recipients' rights hereunder. However, you may include an additional document offering the additional rights described in section 3.5.

### 3.2. Availability of source code.

Any modification which you create or to which you contribute must be made available in source code form under the terms of this license either on the same media as an executable version or via an accepted electronic distribution mechanism to anyone to whom you made an executable version available; and if made available via electronic distribution mechanism, must remain available for at least twelve (12) months after the date it initially became available, or at least six (6) months after a subsequent version of that particular modification has been made available to such recipients. You are responsible for ensuring that the source code version remains available even if the electronic distribution mechanism is maintained by a third party.

### 3.3. Description of modifications.

You must cause all covered code to which you contribute to contain a file documenting the changes You made to create that covered code and the date of any change. You must include a prominent statement that the modification is derived, directly or indirectly, from original code provided by the initial developer and including the name of the initial developer in (a) the source code, and (b) in any notice in an executable version or related documentation in which you describe the origin or ownership of the covered code.

### 3.4. Intellectual property matters

#### (a) Third party claims.

If contributor has knowledge that a license under a third party's intellectual property rights is required to exercise the rights granted by such contributor under sections 2.1 or 2.2, contributor must include a text file with the source code distribution titled "LEGAL" which describes the claim and the party making the claim in sufficient detail that a recipient will know whom to contact. If contributor obtains such knowledge after the modification is made available as described in section 3.2, contributor shall promptly modify the LEGAL file in all copies contributor makes available thereafter and shall take other steps (such as notifying appropriate mailing lists or newsgroups) reasonably calculated to inform those who received the covered code that new knowledge has been obtained.

#### (b) Contributor APIs.

If contributor's modifications include an application programming interface and contributor has knowledge of patent licenses which are reasonably necessary to implement that API, contributor must also include this information in the LEGAL file.

# APPENDIX

## (c) Representations.

contributor represents that, except as disclosed pursuant to section 3.4(a) above, contributor believes that contributor's modifications are contributor's original creation(s) and/or contributor has sufficient rights to grant the rights conveyed by this license.

## 3.5. Required notices.

You must duplicate the notice in exhibit A in each file of the source code. If it is not possible to put such notice in a particular source code file due to its structure, then You must include such notice in a location (such as a relevant directory) where a user would be likely to look for such a notice. If You created one or more modification(s), you may add your name as a contributor to the notice described in exhibit A. you must also duplicate this license in any documentation for the source code where You describe recipients' rights or ownership rights relating to covered code. You may choose to offer, and to charge a fee for, warranty, support, indemnity or liability obligations to one or more recipients of covered code. However, you may do so only on your own behalf, and not on behalf of the Initial developer or any contributor. You must make it absolutely clear than any such warranty, support, indemnity or liability obligation is offered by you alone, and You hereby agree to indemnify the Initial developer and every contributor for any liability incurred by the Initial developer or such contributor as a result of warranty, support, indemnity or liability terms you offer.

## 3.6. Distribution of executable versions.

You may distribute covered code in executable form only if the requirements of section 3.1-3.5 have been met for that covered code, and if you include a notice stating that the source code version of the covered code is available under the terms of this license, including a description of how and where you have fulfilled the obligations of section 3.2. The notice must be conspicuously included in any notice in an executable version, related documentation or collateral in which you describe recipients' rights relating to the covered code. You may distribute the executable version of covered code or ownership rights under a license of your choice, which may contain terms different from this license, provided that you are in compliance with the terms of this license and that the license for the executable version does not attempt to limit or alter the recipient's rights in the source code version from the rights set forth in this license. If you distribute the executable version under a different license you must make it absolutely clear that any terms which differ from this license are offered by you alone, not by the Initial developer or any contributor. You hereby agree to indemnify the initial developer and every contributor for any liability incurred by the initial developer or such contributor as a result of any such terms You offer.

## 3.7. Larger works.

You may create a larger work by combining covered

code with other code not governed by the terms of this license and distribute the larger work as a single product. In such a case, you must make sure the requirements of this license are fulfilled for the covered code.

## 4. Inability to comply due to statute or regulation.

If it is impossible for you to comply with any of the terms of this license with respect to some or all of the covered code due to statute, judicial order, or regulation then you must: (a) comply with the terms of this license to the maximum extent possible; and (b) describe the limitations and the code they affect. Such description must be included in the LEGAL file described in section 3.4 and must be included with all distributions of the source code. Except to the extent prohibited by statute or regulation, such description must be sufficiently detailed for a recipient of ordinary skill to be able to understand it.

## 5. Application of this license.

This license applies to code to which the initial developer has attached the notice in exhibit A and to related covered code.

## 6. Versions of the license.

### 6.1. New versions.

Netscape communications corporation ("Netscape") may publish revised and/or new versions of the license from time to time. Each version will be given a distinguishing version number.

### 6.2. Effect of new versions.

Once covered code has been published under a particular version of the license, you may always continue to use it under the terms of that version. You may also choose to use such covered code under the terms of any subsequent version of the license published by netscape. No one other than netscape has the right to modify the terms applicable to covered code created under this license.

### 6.3. Derivative works.

If You create or use a modified version of this license (which you may only do in order to apply it to code which is not already covered code governed by this license), You must (a) rename Your license so that the phrases "Mozilla", "MOZILLAPL", "MOZPL", "Netscape", "MPL", "NPL" or any confusingly similar phrase do not appear in your license (except to note that your license differs from this license) and (b) otherwise make it clear that Your version of the license contains terms which differ from the Mozilla Public license and netscape Public License. (Filling in the name of the initial developer, original code or contributor in the notice described in exhibit A shall not of themselves be deemed to be modifications of this license.)

## 7. DISCLAIMER OF WARRANTY.

COVERED CODE IS PROVIDED UNDER THIS LICENSE ON AN "AS IS" BASIS, WITHOUT WARRANTY OF ANY KIND, EITHER EXPRESSED OR IMPLIED, INCLUDING, WITHOUT LIMITATION, WARRANTIES THAT THE COVERED CODE IS FREE OF DEFECTS, MERCHANTABILITY, FIT FOR A PARTICULAR PURPOSE OR NON-INFRINGEMENT. THE ENTIRE RISK AS TO THE QUALITY AND PERFORMANCE OF THE COVERED CODE IS WITH YOU. SHOULD ANY COVERED CODE PROVE DEFECTIVE IN ANY RESPECT, YOU (NOT THE INITIAL DEVELOPER OR ANY OTHER CONTRIBUTOR) ASSUME THE COST OF ANY NECESSARY SERVICING, REPAIR OR CORRECTION. THIS DISCLAIMER OF WARRANTY CONSTITUTES AN ESSENTIAL PART OF THIS LICENSE. NO USE OF ANY COVERED CODE IS AUTHORIZED HEREUNDER EXCEPT UNDER THIS DISCLAIMER.

## 8. TERMINATION.

- 8.1. This license and the rights granted hereunder will terminate automatically if you fail to comply with terms herein and fail to cure such breach within 30 days of becoming aware of the breach. All sublicenses to the covered code which are properly granted shall survive any termination of this license. Provisions which, by their nature, must remain in effect beyond the termination of this license shall survive.
- 8.2. If you initiate litigation by asserting a patent infringement claim (excluding declaratory judgment actions) against initial developer or a contributor (the initial developer or contributor against whom you file such action is referred to as "Participant") alleging that:
- (a) such participant's contributor version directly or indirectly infringes any patent, then any and all rights granted by such participant to you under sections 2.1 and/or 2.2 of this license shall, upon 60 days notice from Participant terminate prospectively, unless if within 60 days after receipt of notice you either: (i) agree in writing to pay participant a mutually agreeable reasonable royalty for your past and future use of modifications made by such participant, or (ii) withdraw your litigation claim with respect to the contributor version against such participant. If within 60 days of notice, a reasonable royalty and payment arrangement are not mutually agreed upon in writing by the parties or the litigation claim is not withdrawn, the rights granted by participant to you under sections 2.1 and/or 2.2 automatically terminate at the expiration of the 60 day notice period specified above.
  - (b) any software, hardware, or device, other than such participant's contributor Version, directly or indirectly infringes any patent, then any rights grant-

ed to You by such participant under sections 2.1(b) and 2.2(b) are revoked effective as of the date you first made, used, sold, distributed, or had made, modifications made by that participant.

- 8.3. If you assert a patent infringement claim against participant alleging that such participant's contributor version directly or indirectly infringes any patent where such claim is resolved (such as by license or settlement) prior to the initiation of patent infringement litigation, then the reasonable value of the licenses granted by such participant under sections 2.1 or 2.2 shall be taken into account in determining the amount or value of any payment or license.
- 8.4. In the event of termination under sections 8.1 or 8.2 above, all end user license agreements (excluding distributors and resellers) which have been validly granted by you or any distributor hereunder prior to termination shall survive termination.

## 9. LIMITATION OF LIABILITY.

UNDER NO CIRCUMSTANCES AND UNDER NO LEGAL THEORY, WHETHER TORT (INCLUDING NEGLIGENCE), CONTRACT, OR OTHERWISE, SHALL YOU, THE INITIAL DEVELOPER, ANY OTHER CONTRIBUTOR, OR ANY DISTRIBUTOR OF COVERED CODE, OR ANY SUPPLIER OF ANY OF SUCH PARTIES, BE LIABLE TO ANY PERSON FOR ANY INDIRECT, SPECIAL, INCIDENTAL, OR CONSEQUENTIAL DAMAGES OF ANY CHARACTER INCLUDING, WITHOUT LIMITATION, DAMAGES FOR LOSS OF GOODWILL, WORK STOPPAGE, COMPUTER FAILURE OR MALFUNCTION, OR ANY AND ALL OTHER COMMERCIAL DAMAGES OR LOSSES, EVEN IF SUCH PARTY SHALL HAVE BEEN INFORMED OF THE POSSIBILITY OF SUCH DAMAGES. THIS LIMITATION OF LIABILITY SHALL NOT APPLY TO LIABILITY FOR DEATH OR PERSONAL INJURY RESULTING FROM SUCH PARTY'S NEGLIGENCE TO THE EXTENT APPLICABLE LAW PROHIBITS SUCH LIMITATION. SOME JURISDICTIONS DO NOT ALLOW THE EXCLUSION OR LIMITATION OF INCIDENTAL OR CONSEQUENTIAL DAMAGES, SO THIS EXCLUSION AND LIMITATION MAY NOT APPLY TO YOU.

## 10. U.S. GOVERNMENT END USERS.

The covered code is a "commercial item," as that term is defined in 48 C.F.R. 2.101 (Oct. 1995), consisting of "commercial computer software" and "commercial computer software documentation," as such terms are used in 48 C.F.R. 12.212 (Sept. 1995). Consistent with 48 C.F.R. 12.212 and 48 C.F.R. 227.7202-1 through 227.7202-4 (June 1995), all U.S. Government end users acquire covered code with only those rights set forth herein.

# APPENDIX

## 11. MISCELLANEOUS.

This license represents the complete agreement concerning subject matter hereof. If any provision of this license is held to be unenforceable, such provision shall be reformed only to the extent necessary to make it enforceable. This License shall be governed by California law provisions (except to the extent applicable law, if any, provides otherwise), excluding its conflict-of-law provisions. With respect to disputes in which at least one party is a citizen of, or an entity chartered or registered to do business in the united states of america, any litigation relating to this License shall be subject to the jurisdiction of the federal courts of the northern district of california, with venue lying in santa clara county, california, with the losing party responsible for costs, including without limitation, court costs and reasonable attorneys' fees and expenses. The application of the united nations convention on contracts for the International sale of goods is expressly excluded. Any law or regulation which provides that the language of a contract shall be construed against the drafter shall not apply to this license.

## 12. RESPONSIBILITY FOR CLAIMS.

As between initial developer and the contributors, each party is responsible for claims and damages arising, directly or indirectly, out of its utilization of rights under this license and you agree to work with initial developer and contributors to distribute such responsibility on an equitable basis. Nothing herein is intended or shall be deemed to constitute any admission of liability.

## 13. MULTIPLE-LICENSED CODE.

Initial developer may designate portions of the covered code as "Multiple-Licensed". "Multiple-Licensed" means that the initial developer permits you to utilize portions of the covered code under your choice of the NPL or the alternative licenses, if any, specified by the initial developer in the file described in exhibit A.

## EXHIBIT A -Mozilla Public License.

The contents of this file are subject to the Mozilla Public License Version 1.1 (the "license"); you may not use this file except in compliance with the License. You may obtain a copy of the license at <http://www.mozilla.org/MPL/>

Software distributed under the license is distributed on an "AS IS" basis, WITHOUT WARRANTY OF ANY KIND, either express or implied. See the license for the specific language governing rights and limitations under the License.

The Original Code is \_\_\_\_\_  
.

The Initial Developer of the Original Code is \_\_\_\_\_.

Portions created by \_\_\_\_\_ are Copyright (C) \_\_\_\_\_. All Rights Reserved.

Contributor(s): \_\_\_\_\_.

Alternatively, the contents of this file may be used under the terms of the \_\_\_\_ license (the "[ ] License"), in which case the provisions of [ ] license are applicable instead of those above. If you wish to allow use of your version of this file only under the terms of the [ ] license and not to allow others to use your version of this file under the MPL, indicate your decision by deleting the provisions above and replace them with the notice and other provisions required by the [ ] license. If you do not delete the provisions above, a recipient may use your version of this file under either the MPL or the [ ] license."

NOTE: The text of this exhibit A may differ slightly from the text of the notices in the source code files of the original code. You should use the text of this exhibit A rather than the text found in the original code/source code for Your modifications.



The model and serial number of the TV is located on the back and one side of the TV.  
Record it below should you ever need service.

MODEL \_\_\_\_\_

SERIAL \_\_\_\_\_



**26LD320H 32LD320H 37LD320H 42LD320H  
32LD325H 37LD325H**

**Lodging Guest Interactive Pro:Centric™ TVs**

---

## **Commercial Mode Setup Guide**

Note: Selected features shown in this guide may not be available on all models.

### **EXPERIENCED INSTALLER**

Commercial Mode Setup  
pages 12–13

Cloning Information  
pages 27–32

*b*-LAN™ Setup & Overview  
page 39

For Customer Support/Service, please call:  
**1-888-865-3026**

The latest product information and documentation is available online at:  
**www.LG solutions.com/products**

MODEL and SERIAL NUMBER

The model and serial numbers of this TV are located on the back of the cabinet. For future reference, LG suggests that you record those numbers here:

Model No. \_\_\_\_\_ Serial No. \_\_\_\_\_



**WARNING:**

TO REDUCE THE RISK OF ELECTRIC SHOCK DO NOT REMOVE COVER (OR BACK). NO USER-SERVICEABLE PARTS INSIDE. REFER TO QUALIFIED SERVICE PERSONNEL.



The lightning flash with arrowhead symbol, within an equilateral triangle, is intended to alert the user to the presence of uninsulated “dangerous voltage” within the product’s enclosure that may be of sufficient magnitude to constitute a risk of electric shock to persons.



The exclamation point within an equilateral triangle is intended to alert the user to the presence of important operating and maintenance (servicing) instructions in the literature accompanying the appliance.

**WARNING:**

TO PREVENT FIRE OR SHOCK HAZARDS, DO NOT EXPOSE THIS PRODUCT TO RAIN OR MOISTURE.

**POWER CORD POLARIZATION:**

This product is equipped with a 3-wire grounding-type alternating current power plug. This plug will fit into the power outlet only one way. This is a safety feature. If you are unable to insert the plug fully into the outlet, contact your electrician to replace your obsolete outlet. Do not defeat the safety purpose of the 3-wire grounding-type plug.

**NOTE TO CABLE/TV INSTALLER:**

This reminder is provided to call the cable TV system installer’s attention to Article 820-40 of the National Electric Code (U.S.A.). The code provides guidelines for proper grounding and, in particular, specifies that the cable ground shall be connected to the grounding system of the building, as close to the point of the cable entry as practical.

**REGULATORY INFORMATION:**

This equipment has been tested and found to comply with the limits for a Class B digital device, pursuant to Part 15 of the FCC Rules. These limits are designed to provide reasonable protection against harmful interference when the equipment is operated in a residential installation. This equipment generates, uses and can radiate radio frequency energy and, if not installed and used in accordance with the instruction manual, may cause harmful interference to radio communications. However, there is no guarantee that interference will not occur in a particular installation. If this equipment does cause harmful interference to radio or television reception, which can be determined by turning the equipment off and on, the user is encouraged to try to correct the interference by one or more of the following measures:

- Reorient or relocate the receiving antenna.
- Increase the separation between the equipment and receiver.
- Connect the equipment to an outlet on a circuit different from that to which the receiver is connected.
- Consult the dealer or an experienced radio/TV technician for help.

**CAUTION:**

Do not attempt to modify this product in any way without written authorization from LG Electronics U.S.A., Inc. Unauthorized modification could void the user’s authority to operate this product.

**COMPLIANCE:**

The responsible party for this product’s compliance is: LG Electronics U.S.A., Inc.  
1000 Sylvan Avenue, Englewood Cliffs, NJ 07632, USA • Phone: 1-201-816-2000

Marketed and Distributed in the United States by LG Electronics U.S.A., Inc.  
1000 Sylvan Avenue, Englewood Cliffs, NJ 07632

# IMPORTANT SAFETY INSTRUCTIONS

1. Read these instructions.
2. Keep these instructions.
3. Heed all warnings.
4. Follow all instructions.
5. Do not use this apparatus near water.
6. Clean only with dry cloth.
7. Do not block any ventilation openings. Install in accordance with the manufacturer's instructions.
8. Do not install near any heat sources, such as radiators, heat registers, stoves, or other apparatus (including amplifiers) that produce heat.
9. Do not defeat the safety purpose of the polarized or grounding-type plug. A polarized plug has two blades with one wider than the other. A grounding-type plug has two blades and a third grounding prong. The wide blade or the third prong are provided for your safety. If the provided plug does not fit into your outlet, consult an electrician for replacement of the obsolete outlet.
10. Protect the power cord from being walked on or pinched, particularly at plugs, convenience receptacles, and the point where it exits from the apparatus.
11. Only use attachments/accessories specified by the manufacturer.
12. Use only with the cart, stand, tripod, bracket, or table specified by the manufacturer or sold with the apparatus. When a cart is used, use caution when moving the cart/apparatus combination in order to avoid injury from tip-over.



PORTABLE CART WARNING

13. Refer all servicing to qualified service personnel. Servicing is required when the apparatus has been damaged in any way, such as power-supply cord or plug is damaged, liquid has been spilled or objects have fallen into the apparatus, the apparatus has been exposed to rain or moisture, does not operate normally, or has been dropped.
14. Never touch this apparatus or antenna during a thunder or lightning storm.
15. When mounting a TV on the wall, make sure not to install the TV by the hanging power and signal cables on the back of the TV.
16. Do not allow an impact shock or any objects to fall into the product, and do not drop objects onto the screen.

## 17. Power Cord

**Caution: It is recommended that appliances be placed upon a dedicated circuit; that is, a single outlet circuit which powers only that appliance and has no additional outlets or branch circuits. Check the specification page of the Owner's Manual to be certain.**

Periodically examine the cord of your appliance, and if its appearance indicates damage or deterioration, unplug it, discontinue use of the appliance, and have the cord replaced with an exact replacement part by an authorized servicer. Protect the power cord from physical or mechanical abuse, such as twisting, kinking, or pinching or being closed in a door or walked upon. Pay particular attention to plugs, wall outlets, and the point where the cord exits the appliance.

Do not use a damaged or loose power cord. Be sure to grasp the plug when unplugging the power cord. Do not pull on the power cord to unplug the TV.

## 18. Overloading

Do not connect too many appliances to the same AC power outlet as this could result in fire or electric shock. Do not overload wall outlets. Overloaded wall outlets, loose or damaged wall outlets, extension cords, frayed power cords, or damaged or cracked wire insulation are dangerous. Any of these conditions could result in fire or electric shock.

## 19. Outdoor Use/Wet Location

 **Warning: To reduce the risk of fire or electrical shock, do not expose this product to rain, moisture or other liquids.**

Do not touch the TV with wet hands. Do not install this product near flammable objects such as gasoline or candles or expose the TV to direct air conditioning.

Do not expose to dripping or splashing and do not place objects filled with liquids, such as vases, cups, etc., on or over the apparatus (e.g., on shelves above the unit).

## 20. Grounding

Ensure that you connect the earth ground wire to prevent possible electric shock (i.e., a TV with a three-prong grounded AC plug must be connected to a three-prong grounded AC outlet). If grounding methods are not possible, have a qualified electrician install a separate circuit breaker. Do not try to ground the unit by connecting it to telephone wires, lightning rods, or gas pipes.

## 21. Disconnect Device

The mains plug is the disconnecting device. The plug must remain readily operable.

As long as this unit is connected to the AC wall outlet, it is not disconnected from the AC power source even if you turn off this unit by SWITCH.

(Continued on next page)



# IMPORTANT SAFETY INSTRUCTIONS

(Continued from previous page)

## 22. Outdoor Antenna Grounding

If an outside antenna or cable system is connected to the product, follow the precautions below.

An outdoor antenna system should not be located in the vicinity of overhead power lines or other electric light or power circuits or where it can come into contact with such power lines or circuits as death or serious injury can occur.

Be sure the antenna system is grounded so as to provide some protection against voltage surges and built-up static charges.

Article 810 of the National Electrical Code (NEC) in the U.S.A. provides information with respect to proper grounding of the mast and supporting structure, grounding of the lead-in wire to an antenna-discharge unit, size of grounding conductors, location of antenna-discharge unit, connection to grounding electrodes, and requirements for the grounding electrode.

### Antenna Grounding According to NEC, ANSI/NFPA 70

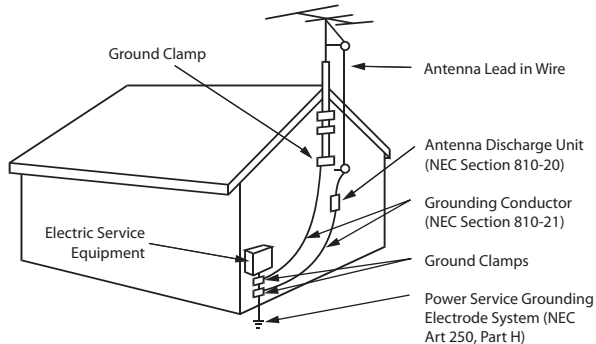

## 23. Cleaning

When cleaning, unplug the power cord and rub gently with a soft cloth to prevent scratching. Do not spray water or other liquids directly on the TV as electric shock may occur. Do not clean with chemicals such as alcohol, thinners or benzene.

## 24. Transporting Product

Make sure the product is turned Off and unplugged and that all cables have been removed. It may take two or more people to carry larger TVs. Do not press against or put stress on the front panel of the TV.

## 25. Ventilation

Install the TV where there is proper ventilation. Do not install in a confined space such as a bookcase. Do not cover the product with cloth or other materials (e.g., plastic) while it is plugged in. Do not install in excessively dusty places.

26. Do not touch the ventilation openings, as they may become hot while the TV is operating.

27. If you smell smoke or other odors coming from the TV or hear strange sounds, unplug the power cord, and contact an authorized service center.

28. Do not press strongly on the panel with a hand or sharp object (e.g., a nail, pencil, or pen) or make a scratch on it.

29. Keep the product away from direct sunlight.

## 30. Dot Defect

The Plasma or LCD panel is a high technology product with resolution of two million to six million pixels. In a very few cases, you could see fine dots on the screen while you're viewing the TV. Those dots are deactivated pixels and do not affect the performance and reliability of the TV.

## 31. Generated Sound

"Cracking": A cracking noise that occurs while the TV is On or when it is turned Off is generated by plastic thermal contraction due to temperature and humidity. This noise is common for products where thermal deformation is required.

Electrical circuit humming/panel buzzing: A low level noise is generated from a high-speed switching circuit, which supplies a large amount of current to operate a product. It varies depending on the product. This generated sound does not affect the performance and reliability of the product.

## 32. For LCD TV

If the TV feels cold to the touch, there may be a small "flicker" when it is turned On. This is normal; there is nothing wrong with TV. Some minute dot defects may be visible on the screen, appearing as tiny red, green, or blue spots. However, they have no adverse effect on the monitor's performance. Avoid touching the LCD screen or holding your finger(s) against it for long periods of time. Doing so may produce some temporary distortion effects on the screen.

# Table of Contents

---

Safety Warnings . . . . .	2	Learning / Teaching a Master TV Setup using a TLL-1100A Clone Programmer . . . . .	29–30
Important Safety Instructions . . . . .	3–4	Learning / Teaching a Master TV Setup using an LT2002 Clone Programmer . . . . .	31–32
Table of Contents . . . . .	5	Remote Jack Pack / TV Connections & Setup . . . . .	33
Setup Checklist / Overview . . . . .	6	<b>References</b>	
Pro:Centric TV Interactive Menu Features . . . . .	7	Upgrading TV/PTC Software using a USB Memory Device . . . . .	34
LD320H/LD325H Rear Jack Panel . . . . .	8	Downloading a Splash Screen using a USB Memory Device . . . . .	35
Side Connections Panel / RF Antenna & MPI Connections . . . . .	9	Power Consumption Settings . . . . .	36
Installer Overview . . . . .	10	TV Camport Auto Sense Operation . . . . .	37
Installer Remote Control Typical Key Functions . . . . .	11	TV Aux Input Configuration . . . . .	38
Commercial Mode Setup for Master TV . . . . .	12–13	<i>b</i> -LAN Setup & Overview . . . . .	39
Installer Menu . . . . .	14–20	RJP Model List and Input Auto-sensing Hierarchy . . . . .	40
TV Setup Menus Overview . . . . .	21	Troubleshooting . . . . .	41–44
Adding Channel Icons / Custom Channel Labels (2-5-4 + MENU Mode) . . . . .	22	General Troubleshooting . . . . .	41
FTG Mode of Operation . . . . .	23–26	Troubleshooting Flow Chart . . . . .	42
FTG Setup Overview . . . . .	23	Commercial Mode Check / FTG Operating Troubleshooting . . . . .	43
Determining the TV Operating Mode / FTG Channel Map Configuration Utility Overview . . . . .	24	Clone Programmer Troubleshooting . . . . .	44
FTG Channel Map Configuration Utility / FTG Channel Map Editor Overview . . . . .	25	Glossary of Terms . . . . .	45
FTG Installer Menu Configuration Utility Overview . . . . .	26	Document Revision History / Notes . . . . .	46
Cloning Overview / Clonable Menu Features . . . . .	27	Back Cover . . . . .	47
Cloning Procedures . . . . .	28–32		
Learning / Teaching a Master TV Setup using a USB Memory Device . . . . .	28		

---

## Notes

- Installer Menu content is intended for use primarily by qualified TV electronics technicians.
- Refer to the Owner's Manual for additional information on TV features, specifications, maintenance, and safety instructions.
- For additional information, contact your LG representative.

For Customer Support/Service, please call:

**1-888-865-3026**

[www.LGSolutions.com](http://www.LGSolutions.com)

Note: Design and specifications subject to change without prior notice.

# Setup Checklist / Overview

---

## Setup Checklist

### Installation and Setup Checklist

- \_\_\_ Unpack TV and all accessories.
  - \_\_\_ Install batteries in remote control.
  - \_\_\_ Install TV on VESA mount or stand.
- Note:** It may be advisable to make all cable connections before installing on VESA mount or stand, as appropriate.

### Hardware Connections

- \_\_\_ Install any additional hardware as appropriate to your institution, LAN, etc.

### Cable Connections

- \_\_\_ Make all connections to rear jack panel and RF antenna on MPI/PPV card.
  - \_\_\_ Make all connections to signal, interactive resources, and Aux sources, as appropriate.
- 

### Commercial Mode Setup

- \_\_\_ Complete Commercial Mode Setup (configure all relevant Installer Menu items as required of your institution and configure display features for the end user).

### Software Installation

- \_\_\_ Install or configure any software, as applicable, for example, PPV, etc.

## Commercial Mode Setup Overview

This document describes how to set up LD320H and LD325H Pro:Centric™ TVs for Commercial Mode either while in the Embedded *b*-LAN™ (EBL) module's Pass-through Mode or its Free-To-Guest (FTG) Mode.

**Note:** The *b*-LAN module is internal to the TV and allows the hotel/institution head end equipment to communicate with the TV for configuration and control. See Reference section, "*b*-LAN Setup & Overview," for further information.

### Pass-through Mode

This mode allows you to configure a Master TV Setup for cloning purposes as well as external VOD/PPV control. Use the Installer Remote to configure Installer Menu items as required for TV operation and set up TV features (Channel, Picture, Audio, etc.). See pages 12 to 13 for detailed information.

### FTG Mode

This mode enables Pro:Idiom® decryption and also allows logical channel mapping of physical channels to remove the need for dash tuning. FTG Configuration Application software is used to configure and/or edit Channel Map and Installer Menu settings. See pages 23 to 26 for further information on FTG Mode and local configuration using a PC with the FTG Configuration Application. Since these TV models are equipped with the EBL Module, they can also be broadcast configured in FTG Mode by a Free-To-Guest Management Appliance (FMA) head end device. Refer to the **Free-To-Guest (FTG) Configuration Application** manual and/or the Installation & Setup manual for the FMA device.

# Pro:Centric TV Interactive Menu Features

Channel Guide  
Information  
Remote Help  
Watch TV

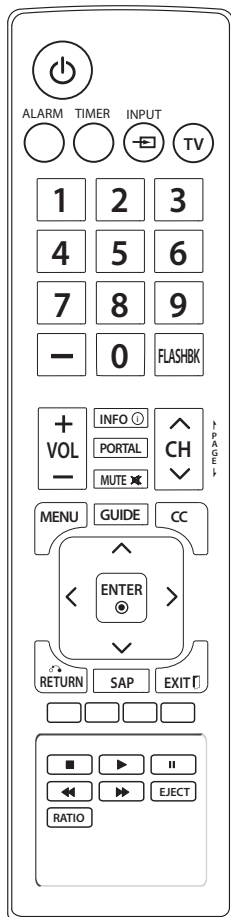

**Important: Pro:Centric operation requires that Installer Menu items 098 PRO:CENTRIC and 119 DATA CHANNEL be set appropriately and that the TV be in PPV or FTG Mode.**

The interactive Pro:Centric TV enables guests—from the comfort of their hotel rooms—to view and select from a complete listing of hotel services and amenities. The Pro:Centric TV is connected to the hotel's billing computer, and service/amenities charges are billed at the time of order.

Interactive amenities may include:

- Hotel information, news, and events
- Directory services (tourist attractions, restaurants, etc.)
- Reservation services (business meetings, fitness, spa, etc.)
- Weather and traffic information
- Shopping services (delivery to guest room)
- Room service (menu ordering, memo service, morning wake up call, laundry, etc.)
- Ticketing services
- Check-out service (in the guest room)
- Gaming services
- E-mail resources/account access

Use the Installer Remote to operate both interactive menus and regular TV features. Press **PORTAL** on the Installer Remote to access the interactive menus.

**Note:** Interactive menu options may vary, depending on Pro:Centric features enabled for the site. The following are default interactive menus.

## Channel Guide

Shows available TV networks and channels. When available, Electronic Program Guide (EPG) data indicates the channel and the program start and finish times.

## Information

Typically displays hotel information, for example, photos of guest rooms, dining rooms, business centers, fitness and pool facilities, etc. Information may also include resources, such as local school programs, run in cooperation with the hotel.

## Remote Help

Provides help for navigating the interactive menus.

## Watch TV

Removes the interactive menu from the screen and returns to the previously tuned TV channel.

# LD320H/LD325H Rear Jack Panel

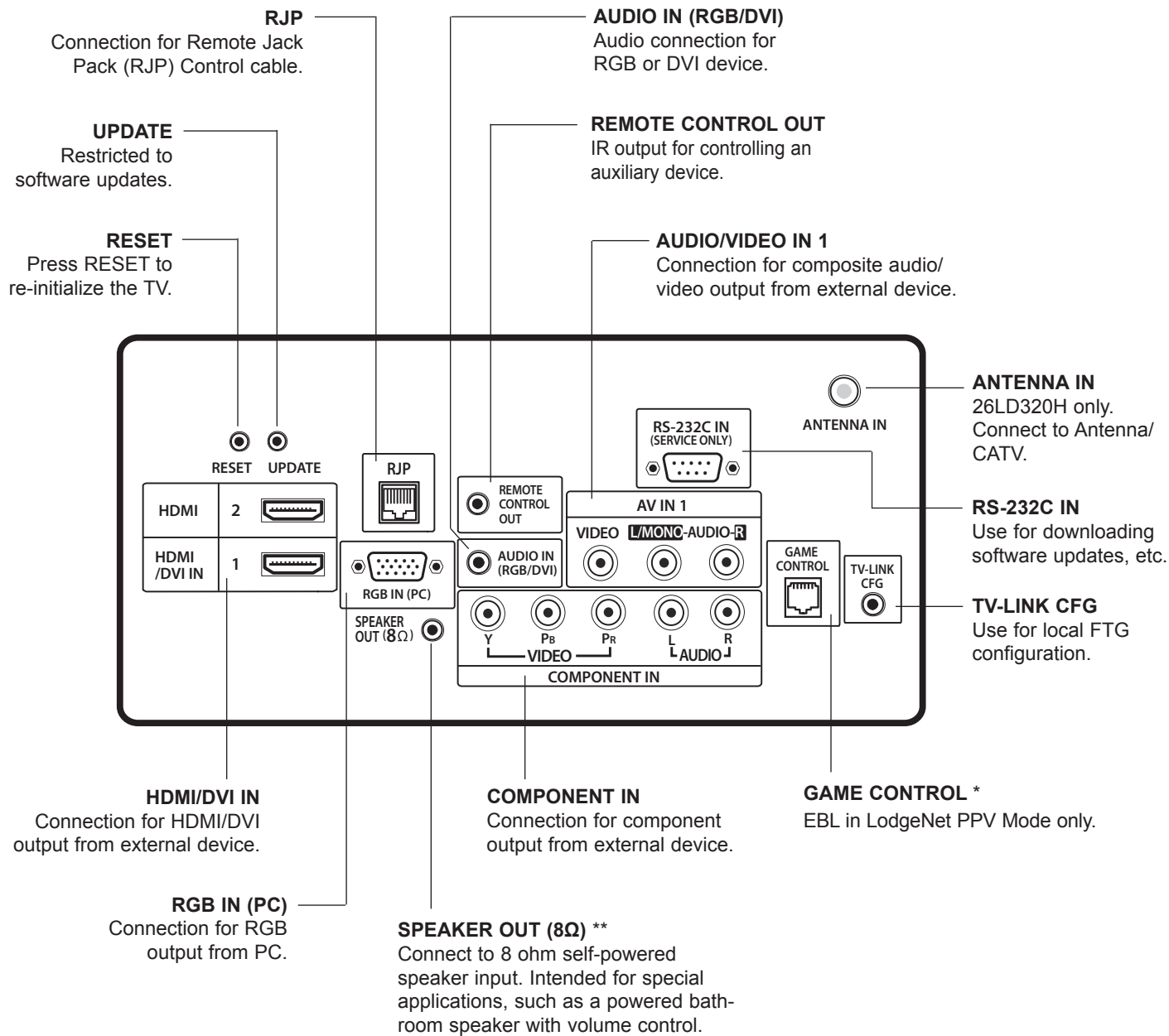

\* For 26LD320H TVs, this is a GAME CONTROL/MPI port. GAME CONTROL function as described above. When the EBL is in Pass-through Mode, the MPI function enables an external MPI control device (i.e., clone programmer, VOD/PPV STB, etc.) to control the TV.

\*\* This stereo jack provides a mono speaker fixed-level, 1 watt output (audio +, audio -, w/ground shield). Do NOT plug in a mono connector, as this may damage the TV.

# Side Connections Panel / RF Antenna & MPI Connections

## Side Connections Panel

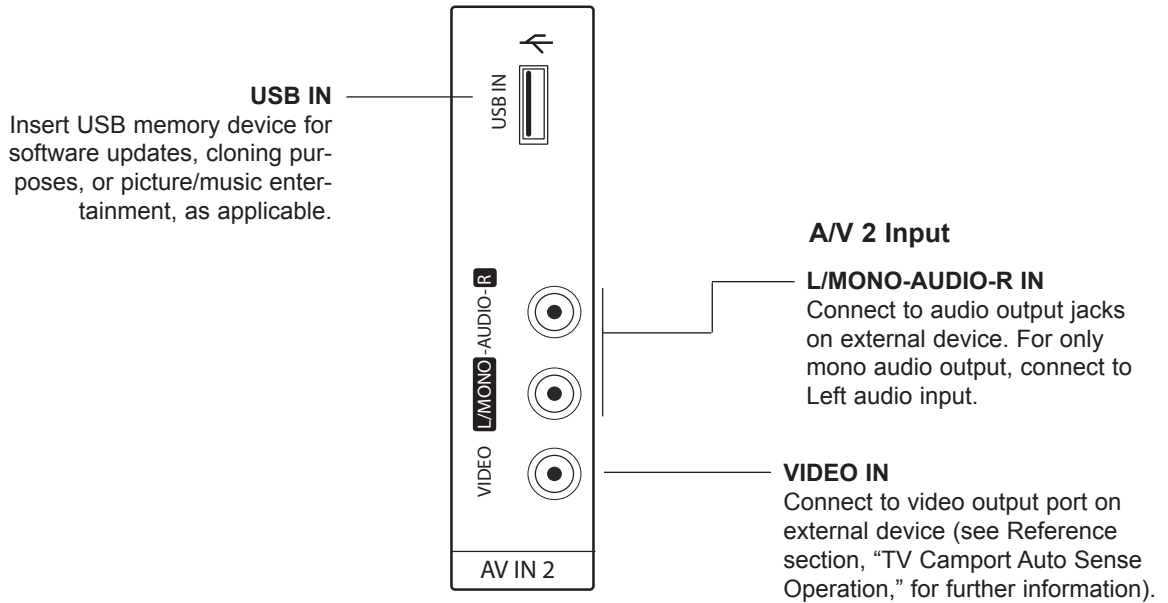

## RF Antenna & MPI Connections

(32/37/42LD320H and 32/37LD325H TVs)

**Note:** 26LD320H Antenna and MPI connections are on the rear jack panel (see previous page).

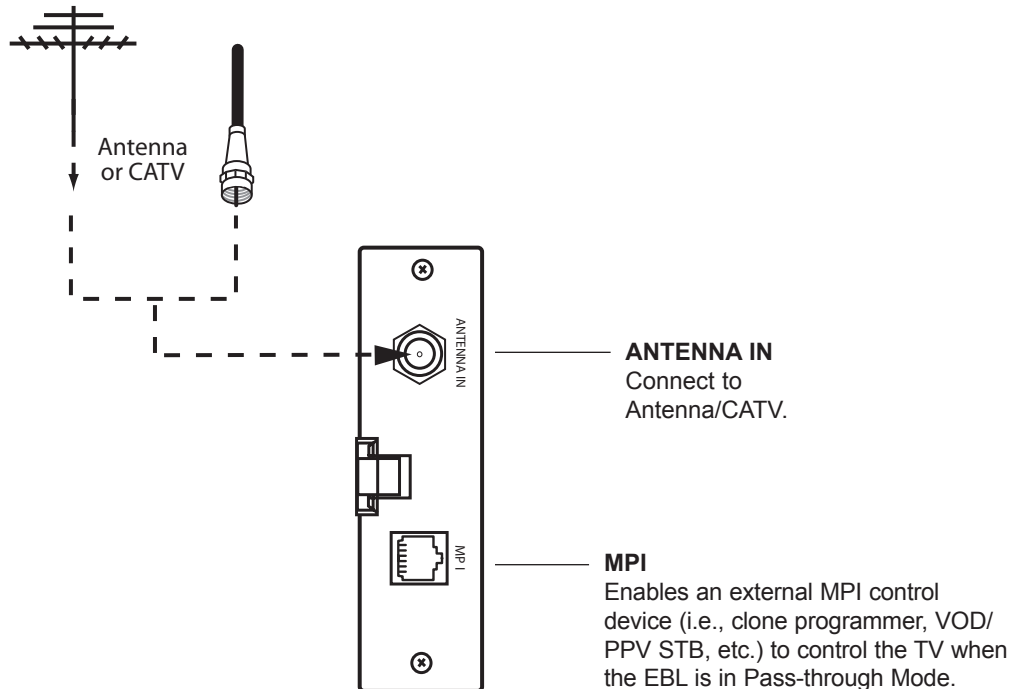

# Installer Overview

This is the Commercial Mode Setup Guide only.

## Installer Menu / Commercial Mode Setup

To set up a Master TV, you will need to know how to enter the TV Installer Menu and make changes to the default values as required. Similarly, to configure a single TV's Installer Menu settings in FTG Mode, you will need to know how to access and use the FTG Configuration Application utilities. If necessary, familiarize yourself with the Installer Menu and how to make and save changes. Refer to page 14 for information on accessing the Installer Menu in Pass-through Mode. Refer to page 23 for information on accessing the FTG Installer Menu Configuration Utility in the FTG Configuration Application. Pages 15 to 20 describe Installer Menu items in detail.

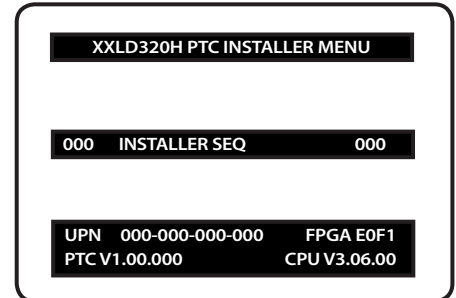

Typical Installer Menu

## Installer Remote

The LG Installer Remote is supplied with and dedicated to operate the TV. See next page for typical key functions in TV operating mode. Some DVD and VCR controls may be available for selected LG DVD/VCR products.

## Cloning

Cloning refers to the process of capturing a Master TV Setup and transferring it to a Target TV. The Master TV's clonable features need to be configured as part of the Commercial Mode Setup. This is a critical step. If the Master TV's clonable features—channel icons or labels, digital font options, etc.—are not set up correctly, the cloned TVs will all have problems. Pages 27 to 32 provide detailed information on cloning requirements and procedures.

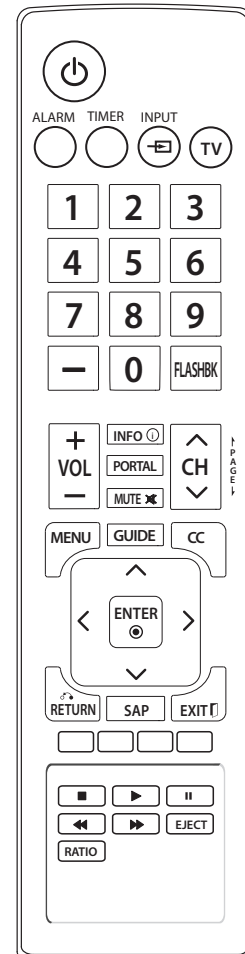
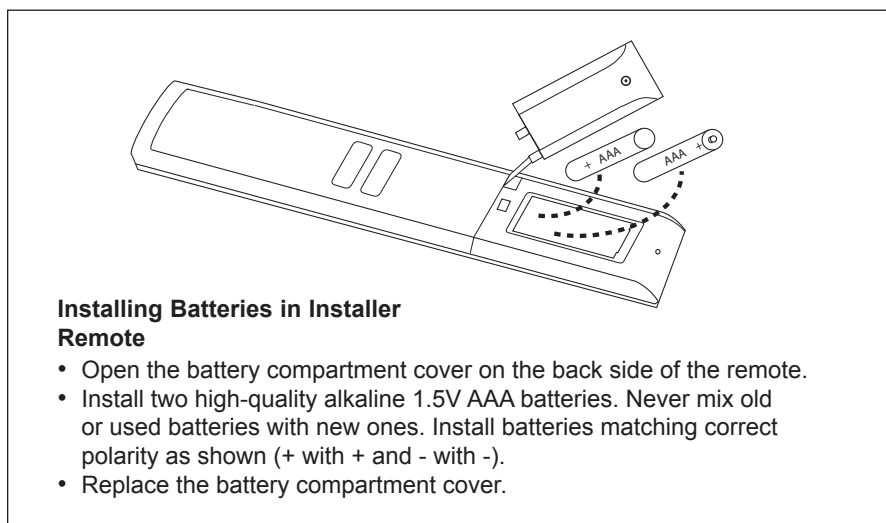

# Installer Remote Control Typical Key Functions

The LG Installer Remote illustrated below and throughout this document shows typical remote control functions and is provided for reference only. This Installer Remote may vary from the Installer Remote supplied with the TV.

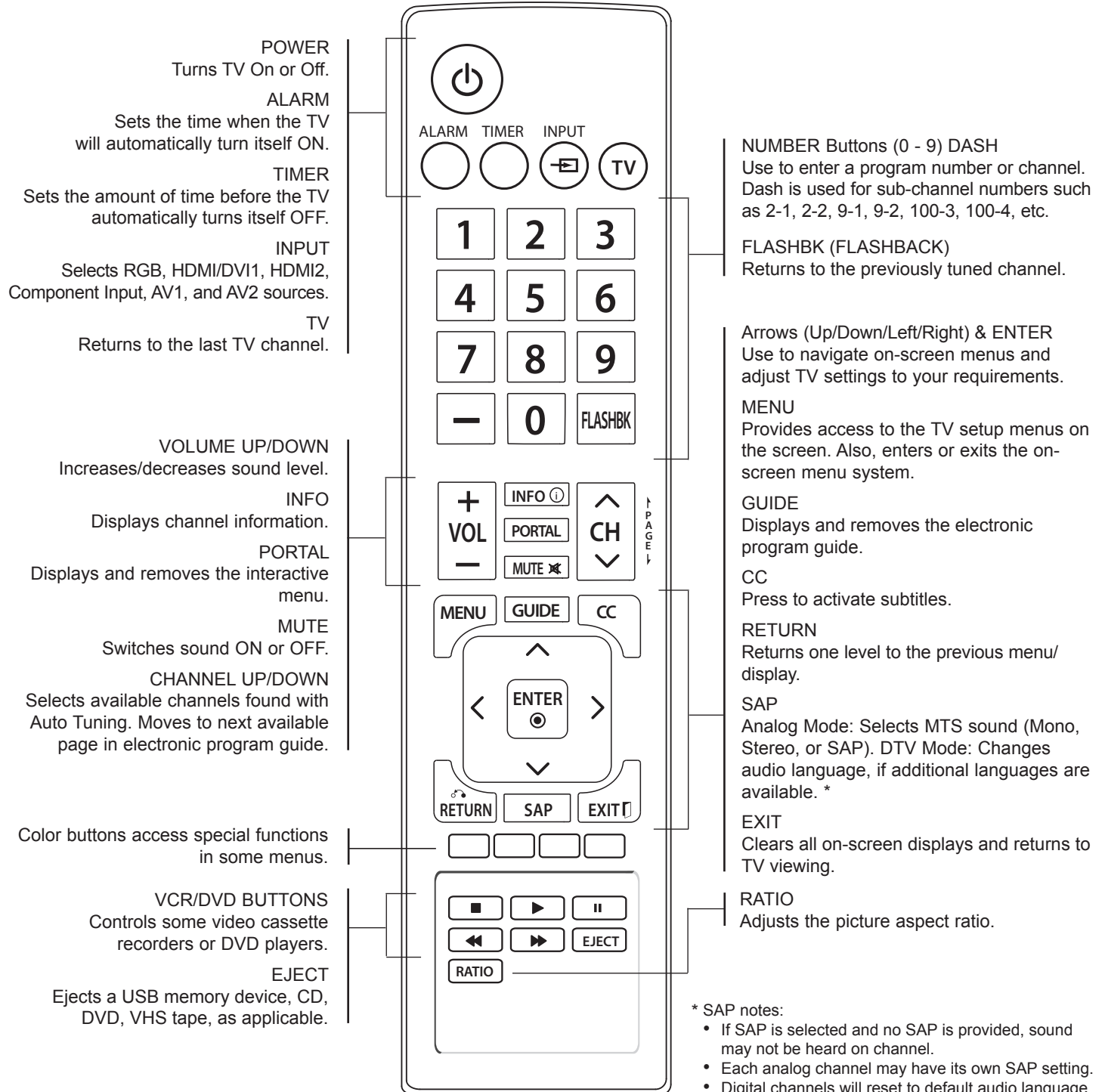

\* SAP notes:

- If SAP is selected and no SAP is provided, sound may not be heard on channel.
- Each analog channel may have its own SAP setting.
- Digital channels will reset to default audio language with a power off/on.



# Commercial Mode Setup for Master TV

This section describes how to set up a Master TV when the EBL is in Pass-through Mode.

**Note:** Disconnect all Aux inputs. Under certain conditions, Auto Tuning (Channel Search) is disabled if there is an Aux input active.

**Note:** Refer to “FTG Mode of Operation” on pages 23 to 26 for information on configuring/editing Channel Map and Installer Menu settings for an individual TV in FTG Mode.

## 1. Set Installer Menu items.

- a) Use the Installer Remote to enter the TV Installer Menu: Press **MENU** repeatedly until the on-screen menu locks up, and then press **9-8-7-6 + ENTER**. Refer to pages 14 to 20 for detailed information on Installer Menu items.
- b) Set Installer Menu item **117 FACT DEFAULT** to **001** and press **ENTER** on the Installer Remote.  
 This clears all Installer Menu custom settings, channel labels/icons, etc. and reloads the factory default settings. The value will change back to 0 after the internal TV controller (Protocol Translator Card [PTC]) has been restored to factory default condition. This step ensures that the TV Channel Memory will be the active Channel List.
- c) Set Installer Menu item **003 BAND/AFC**, as appropriate.
  - Broadcast: Set to 000.
  - CATV: Set to 001 (default).
  - HRC: Set to 002.
  - IRC: Set to 003.
- d) Set any other Installer Menu items that affect your TV programming network to the required configuration. For example, enable/disable Aux sources, set a Start Channel, etc.
- e) After you have adjusted all required Installer Menu item settings, press **ENTER** on the Installer Remote to exit the menu and save your changes.

## 2. Set up TV features.

On-screen setup menus control the features of the TV (see page 21). Press **MENU** on the Installer Remote to access the setup menus, and then set Channel, Picture, Audio, Lock, Time, etc. options to the desired configurations. See also the Clonable Menu Features list on page 27.

**Note:** If desired, you can run Auto Tuning (see step 3) prior to completing this step.

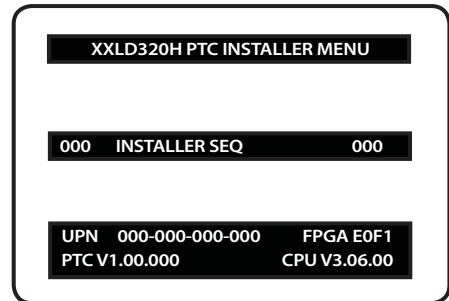

Typical TV Installer Menu

Note: The Installer Menu header will vary depending on the TV you are setting up.

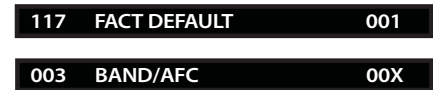

Adjust the settings for these Installer Menu items.

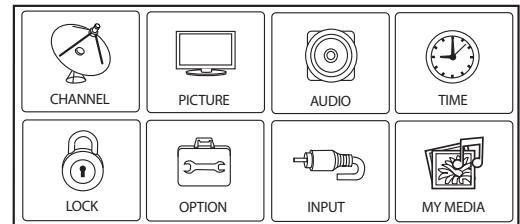

Set the TV features to the desired configuration for the end user.

(Continued on next page)

# Commercial Mode Setup for Master TV (Cont.)

(Continued from previous page)

## 3. Run Auto Tuning (Channel Search).

- a) Search for all available analog and digital channels: Go to the Channel Menu, select the **Auto Tuning** option, and follow the on-screen instructions.
- b) Use the **Channel Edit** option in the Channel Menu to edit the channel lineup, as necessary, to include free to guest channels only.
  - Add/delete channels per your system requirements. Note that physical channel numbers are used to identify virtual channels. Also, channel numbers cannot be higher than 255.
  - Use the **Channel Label** option in the Channel Menu to add familiar channel trademarks/logos such as ABC, CBS, NBC, etc. to the Channel-Time on-screen display. Identifiable labels (logos) should enable the end user to readily know what common networks are available. (You can add the channel labels in this step, or you can add channel logos or labels for channels without icons in step 5.)

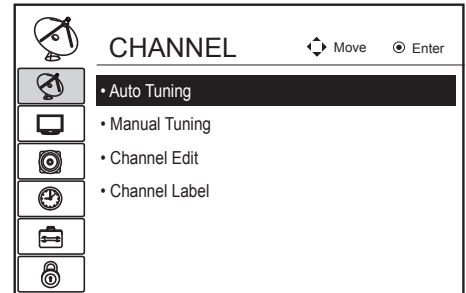

Run Auto Tuning, edit channels, and select familiar channel trademarks/logos using Channel Menu options.

## 4. Transfer the TV Setup to the internal TV Controller (PTC): 2-5-5 + MENU Mode

After the TV channel lineup has been edited and channel label icons added, enter the Installer Menu. Once in the Installer Menu, press **2-5-5 + MENU** on the Installer Remote to initiate the transfer of the Master TV Setup to the PTC. Once the transfer is complete, the TV will exit the Installer Menu.

**Note:** The maximum number of active channels that can be transferred is 141. Total channels numbering more than 141 will result in erratic TV operation.

## 5. Add Custom Channel and Aux Source Labels for Analog Channels: 2-5-4 + MENU Mode

Enter the Installer Menu, and press **2-5-4 + MENU** on the Installer Remote. Add/edit custom text labels to channel on-screen displays. Note that digital channels often have a broadcaster generated label (see 2-5-4 + MENU procedural information on page 22). When you are finished, press **MENU** to exit 2-5-4 + MENU Mode.

## 6. Verify the TV setup.

At this point, verify that the channel lineup, channel icons, and custom labels are correct. Make sure the TV features are set per your requirements.

## 7. Lock the channel lineup.

Enter the Installer Menu, and set item **028 CH. OVERRIDE** to **000** to lock the channel lineup and restrict access to the TV setup menus.\* Press **ENTER** to exit the Installer Menu and save your changes.

The Master TV Setup is now ready to be copied to a clone programmer (see cloning information in this document).

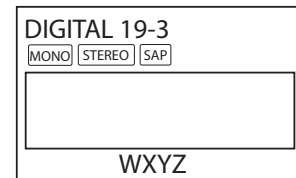

Custom Text Label "WXYZ" created in 2-5-4 + MENU (Add Channel Label) Mode.

**028 CH. OVERRIDE 000**

After verifying the TV Setup, set Installer Menu item 028 CH. OVERRIDE to 000.\*

\* This step prevents end users from accessing channel settings (i.e., the Channel Menu will be inaccessible/grayed out).

# Installer Menu

---

Use the Installer Menu to set up or change operational settings. Refer to the table starting on the next page for brief descriptions of Installer Menu items. More detailed descriptions follow the table listing.

## Accessing the Installer Menu

Make sure the TV is ON. Using an Installer Remote, press **MENU** repeatedly until the on-screen setup menus lock up, and then press **9-8-7-6 + ENTER** to access the Installer Menu.

The Installer Menu opens with item 000 INSTALLER SEQ 000. Use the Up/Down arrow keys to sequence through the available menu items, or access an item directly by keying in the line number and then pressing **MENU**. For example, to access the SLEEP TIMER option, which is item 015, press 0-1-5 + MENU. To change a setting, use the Left/Right arrow keys, or enter a value directly.

## Using the Installer Menu

Items 000 ~ 119 are immediately accessible only upon entering the Installer Menu. Refer to the table on pages 15 and 16 for an overview of Installer Menu items, including item numbers, functions, ranges, and default values. Installer Menu items not relevant to these TV series are not present on the Installer Menu; therefore, some numbers are missing. For example, item 006 will not appear.

## Exiting the Installer Menu and Activating Updates

To exit the Installer Menu, press **ENTER** again. Any changes you make will be stored in non-volatile memory.

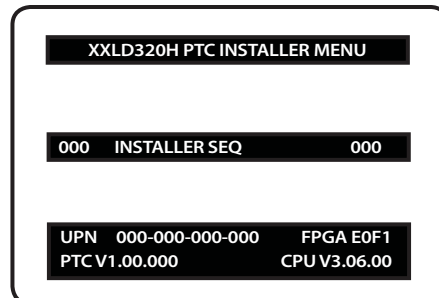

Typical TV Installer Menu

# Installer Menu (Cont.)

## Installer Menu Items 000 through 071

Menu Item	Function	Value Range	Default Value	Brief Description of Function and Comments
000	INSTALLER SEQ	0 ~ 3	0	Leave default set to 0.
001	POWER MANAGE	0 ~ 7	0	Sets number of hours of no activity before automatic shutoff.
002	AC ON	0 / 1	0	Set to 1 to enable Auto Turn ON when AC power is applied.
003	BAND/AFC	0 ~ 3	1	Selects Tuning Band: 0=Broadcast, 1=CATV, 2=HRC, 3=IRC
004	STRT CHANNEL	0 ~ 127, 255	255	Channel tuned when TV is turned ON. (Set to 255 to tune to channel tuned before TV turned OFF.)
005	CHAN LOCK	0 / 1	0	If set to 1, cannot tune from current channel.
007	STRT VOLUME	0 ~ 63, 255	255	Volume level when TV is turned ON. (Set to 255 to use volume level before TV turned OFF.)
008	MIN VOLUME	0 ~ 63	0	Sets minimum allowable volume setting.
009	MAX VOLUME	0 ~ 63	63	Sets maximum allowable volume setting.
010	MUTE DISABLE	0 / 1	0	Set to 1 to disable Mute Function.
011	KEY DEFEAT	0 / 1	0	Set to 1 to disable menu navigation keys on display panel.
015	SLEEP TIMER	0 / 1	1	Set to 1 to enable Sleep Timer.
016	EN TIMER	0 / 1	0	Set to 1 to enable On/Off Timers.
017	ALARM	0 / 1	1	Set to 1 to enable Alarm.
020	FEATURE LEVEL	0 ~ 1, 16 ~ 24	1	Determines the IR code scheme to which the TV will respond.
021	V-CHIP	0 / 1	1	Set to 1 to enable V-Chip (Parental Control) functions.
022	MAX BLK HRS	0 ~ 99	12	Sets number of V-Chip blocking hours.
023	CAPTION LOCK	0 / 1	0	Set to 1 to retain caption setting set before TV turned OFF.
028	CH. OVERRIDE	0 / 1	1	If set to 0, limits direct access to favorite channels.
029	OLD OCV	0 / 1	0	Set to 1 to change MPI operation to OCV.
030	ACK MASK	0 / 1	0	If set to 1, changes MPI for some OCV boxes.
031	POLL RATE	20 ~ 169	94	Selects poll rate for MPI.
032	TIMING PULSE	186 ~ 227	207	Sets baud rate for MPI.
034	CAMPORT EN	0 / 1	1	Set to 1 to enable Video 2 input.
035	COMPPOINT EN.	0 / 1	1	Set to 0 to disable HDMI 1. Set to 1 enable HDMI 1.
038	YPrPb EN.	0 / 1	1	Set to 1 to enable display panel Component Video 1 input jacks.
039	REAR AUX EN	0 / 1	1	Set to 1 to enable display panel Video 1 input jack.
040	AUTO CAMPORT	0 / 1	1	Set to 1 to automatically switch to Camport. If set to 1, STRT AUX SRCE cannot be set to 2.
046	STRT AUX SRCE	1 ~ 6, 255	6	Sets the starting Aux source (if item 004 STRT CHANNEL is set to 0).
047	AUX STATUS	0 / 1	0	Set to 1 for MPI Aux source to be reported as a channel number instead of Channel 0.
053	DIS. CH-TIME	0 / 1	0	Set to 1 to disable Channel-Time display.
069	EN. CH-T COL.	0 / 1	1	Set to 1 to enable custom color for the Channel-Time display.
070	FOR. CH-TIME	0 ~ 7	2	Chooses custom foreground color for the Channel-Time display.
071	BCK. CH-TIME	0 ~ 7	2	Chooses custom background color for the Channel-Time display.

# Installer Menu (Cont.)

## Installer Menu Items 073 through 119

Menu Item	Function	Value Range	Default Value	Brief Description of Function and Comments
073	CH NOT AVBLE	0 / 1	0	If set to 1 and Channel Override is 0, "NOT AVAILABLE" message is displayed when directly accessing a channel not in the favorite Channel List.
075	REVERT CH	0 / 1	0	If set to 1 and loss of MPI communication occurs, TV tunes to Start Channel.
078	UPN MSB	0 ~ 255	0	User programmable number, most significant byte.
079	UPN MSB-1	0 ~ 255	0	User programmable number, most significant byte - 1.
080	UPN MSB-2	0 ~ 255	0	User programmable number, most significant byte - 2.
081	UPN LSB	0 ~ 255	0	User programmable number, least significant byte.
082	CHKSM ERROR	0 / 1	1	Enforces rigid MPI checksum.
083	HANDSHK TIME	0 ~ 5	5	Relaxes MPI timing to be compatible with PC-based Windows-controlled systems.
084	PERMANENT BLK	0 / 1	0	Removes block hours setting for Parental Control and makes block permanent.
087	REAR RGB EN.	0/1/17	1	Dependent on item 093 RJP AVAILABLE setting. Set to 0 to disable RGB1. Set to 1 to enable for RGB PC. Set to 17 for Auto Configure.
088	EN NOISE MUTE	0 / 1	1	If set to 1, audio is muted if no signal is present.
090	KEY LOCK	0 / 1	0	If set to 1, keyboard is locked out, IR is still functional.
091	YPrPb2 EN	0 / 1	1	Set to 1 to enable HDMI 2 input.
093	RJP AVAILABLE	0, 1, 2, 5, 6	0	Set to 0 to disable. Set to 1, 2, 5, or 6 for HDMI or DVI Mode. (See detailed descriptions.)
094	SAP MENU EN	0 / 1	1	Set to 0 to disable feature on Function Menu. Set to 1 to enable feature on Function Menu.
096	DEF. ASP. RATIO	0 ~ 4	2	Sets default aspect ratio at power up. See detailed descriptions and item 106.
098	PRO:CENTRIC	0 ~ 2	0	Set to 0 to disable Pro:Centric operation. Set to 1 for Flash Mode. Set to 2 for GEM (Java Application) Mode.
099	BACK LIGHTING	1 ~ 100, 101 ~ 200, 255	100	Sets the level of the TV picture back lighting. (See detailed descriptions.)
102	ATSC BAND	0 ~ 4	4	Selects ATSC band.
103	ATSC TUNE MODE	0 / 1	1	Set to 1 (default) for Physical Channel scan. Set to 0 for Virtual Channel scan.
104	START MINOR CH	0 ~ 255	0	Selects Minor Start Channel. Set to 0 for NTSC.
106	ASP RATIO LOCK	0 / 1	0	To retain set aspect ratio on power cycle, set to 1. Set to 0 for default ratio on power cycle.
116	VIDEO MUTE EN	0 / 1	0	Set to 0 for Normal. Set to 1 for Blank.
117	FACT DEFAULT	0 / 1	0	Set to 0 for Normal. Set to 1 to load presets for all Installer Menu settings.
118	POWER SAVINGS	1 / 3 / 7	3	If set to 1, the b-LAN module is always powered. If set to 3, the b-LAN module is only powered when TV is turned ON. If set to 7, the b-LAN module is never powered.
119	DATA CHANNEL	0 ~ 135	0	Set to 0 to disable. Set to the RF channel number of the Data Channel for Pro:Centric or E-Z Installation data. (See detailed descriptions.)

## Detailed Descriptions of Installer Menu Items

### 000 - INSTALLER SEQUENCE

Specifies entry sequence to the Installer Menu.

0 = 9876	1 = 4321
2 = 1478	3 = 3698

### 001 - POWER MANAGE (Power Management)

Determines hours of no activity before automatic shutoff. The Power Management function is for saving energy. If set to 0, Power Manage is Off. Settings range from 0 ~ 7, with 1 ~ 7 representing the hours that the unit will remain ON, unless there has been activity from either the control panel or remote control.

### 002 - AC ON (AC Power Switchable)

If set to 1, this allows the TV to turn ON when AC power is applied. Pressing the ON button is not necessary. This is desirable if the TV is plugged into a cable box or a power outlet controlled by a wall switch. Use the Left/Right arrow keys to choose 0 or 1, where 0 is the default (OFF), and 1 is ON.

**Note:** If set to 1 (ON), the TV does not respond to On/Off commands from either the remote or the display control panel, and the SLEEP TIMER is also nonfunctional.

### 003 - BAND/AFC (Band/Automatic Frequency Control)

There are four possible settings for this option:

0 = Broadcast	1 = CATV (default)
2 = HRC	3 = IRC

If some channels were not found by Auto Tuning (Channel Search), select the appropriate Band setting here, and add the channels using the Channel Edit option in the Channel Menu.

### 004 - STRT CHANNEL (Start Channel)

If active, this function allows you to determine the initial Major Start Channel number when the TV is turned ON. This feature is useful for an in-house information channel, since the TV would always select that channel when it is turned ON. Setting this item to 255 causes the last channel viewed when the TV was turned OFF, to be the tuned to channel when the TV is turned ON again.

**Note:** For a digital Start Channel, always remember to set item 104 to the Minor Start Channel number.

255 = Last channel	1 ~ 125 = Major Ch. #	0 = Aux
126 = Map to Channel 3	127 = Map to Channel 4	

### 005 - CHAN LOCK (Channel Lock)

Channel Lock is ideal if the system must always be on the same channel. Changing channels with the Channel Up/Down or keypad numbers is impossible. Channel Lock is inactive if set to 0 (default).

Generally, this feature is used in connection with STRT CHANNEL (Installer Menu item 004) where the Start Channel may, for example, be set to 3 or 4. If the Start Channel is 3, then the TV will remain locked on channel 3.

**NOTE:** For items 007, 008, and 009

For legacy reasons, the scale used is 0–63. The PTC software will translate this to the 0–100 scale used by the TV.

To translate a TV volume level to the Installer Menu value, use the following formula:

$$\text{Installer Value} = \frac{\text{TV Value} \times 63}{100}$$

Enter only the whole number (disregard fractions).

### 007 - STRT VOLUME (Start Volume)

This function allows the Installer to determine the initial volume level setting when the TV is turned ON. This feature is useful for an in-house information channel, since the TV would always select that volume level when it is turned ON. The range of values are 0 - 63, 255. If 255 is selected, the current volume level will be retained in memory when the TV is turned OFF; at turn ON, the volume level will be automatically set at the previous or last level.

### 008 - MIN VOLUME (Minimum Volume)

This function determines the minimum volume level allowable with the Volume (VOL) Up/Down control. In this way, for example, someone cannot set the volume too low to hear. The value range is from 0 to 63. Use the Left/Right arrow keys to change values. The factory default is 0, which provides the full range of volume control, if item 009 MAX VOLUME is also set to 63. It may be best to set the same value on every TV.

**Note:** The minimum volume level cannot have a value setting higher than the maximum volume level (described below).

### 009 - MAX VOLUME (Maximum Volume)

This function determines the maximum volume level allowable with the Volume (VOL) Up/Down control. In this way, for example, someone cannot set the volume level high enough to disturb others. The value range is 0 to 63, with 63 as the default, which gives the user the full range of volume control, if item 008 MIN VOLUME is also set at 0. Use the Left/Right arrow keys to change values. It may be best to set the same value on every TV.

**Note:** The maximum volume level cannot have a value setting lower than the minimum volume level (described above).

### 010 - MUTE DISABLE

Enables or disables sound mute function. If set to 1, sound cannot be muted. If set to 0, sound can be muted.

### 011 - KEY DEFEAT (Keyboard Defeat)

If set to 1, KEY DEFEAT prevents the end user from accessing the on-screen menus from the display panel—MENU, ENTER, and menu navigation keys do not function. If set to 0, those keys do function.

**Note:** Users can always access the menus by pressing MENU on the remote.

# Installer Menu (Cont.)

## 015 - SLEEP TIMER

If set to 1, the Sleep Timer feature may be used. If set to 0, the Sleep Timer is not available.

## 016 - EN TIMER (Enable On/Off Timers) \*

If set to 1, the Timer function is available to the end user and enabled continuously. Set to 0 to disable On/Off timers.

**Note:** Clock must be set in order to use timers.

## 017 - ALARM \*



Gives the installer the option of making the Alarm function available to the end user. If set to 1, the Alarm function is available to the end user. Set to 0 to disable the Alarm function.

**Note:** Clock must be set before the Alarm function will work.

## 020 - FEATURE LEVEL

Determines the IR code scheme to which the TV will respond, allowing for the use of unique IR codes based on "bed number" in a multi-TV single room installation. First determine the IR mode; then select the bed number.

IR Mode 0 = Legacy

IR Mode 1 = Multi-code remote

**Note:** For further information, see documentation for the accessory package that includes the multi-code remote.

## 021 - V-CHIP (Parental Control) \*

Set to 1 to activate V-Chip (Parental Control) and have it available to the end user to filter and control or otherwise restrict programming content that can appear. Set to 0 to turn the V-Chip feature Off (not available to user); no programming restrictions can be set.

## 022 - MAX BLK HRS (Maximum Block Hours) \*

Sets hours from 0 to 99 for the maximum V-Chip (Parental Control) block hours. Default setting is for 12 blocking hours.

## 023 - CAPTION LOCK

If set to 0, captions are OFF when the TV is turned ON. Set to 1 to use the caption setting configured before the TV was turned OFF when the TV is turned ON.

## 028 - CH. OVERRIDE (Channel Override)

If set to 1, the user can select channels with either Channel Up/Down or by direct keypad entry. If set to 0, only those channels that are active in the TV's memory can be selected.

## 029 - OLD OCV (On Command Video™)

Set to 1 for operation with systems from On Command Corporation.

\* Only affects Function Menu if enabled by some PPV providers.

## 030 - ACK MASK

MPI Communication Parameter. Leave at default setting unless changed by PPV provider. When set to 1, changes MPI for some OCV boxes.

## 031 - POLL RATE

MPI Communication Parameter. Selects Poll Rate for MPI. Leave at default setting unless changed by Pay-Per-View provider. Step size of 16 ms.

## 032 - TIMING PULSE

MPI Communication Parameter. Leave at default setting unless changed by Pay-Per-View provider. Sets baud rate. Step size of 4.3 uS.

## 034 - CAMPORT EN. (Camera Port Enable)

Set to 1 to enable Video 2 input on display panel. If set to 0, Video 2 input on display panel is not functional.

## 035 - COMPPORT EN. (Computer Port Enable)

Enable/disable TV display panel HDMI 1 input jack. Set to 0 to disable HDMI1. Set to 1 to enable HDMI1.

**Note:** This setting is ignored if item 093 RJP AVAILABLE is set to 1.

## 038 - YPrPb EN. (Rear Component Video Enable)

Set to 1 to enable display panel rear Component Video input jacks. Set to 0 to disable display panel rear Component Video input jacks.

## 039 - REAR AUX EN. (Rear Aux Enable)

Set to 1 to enable display panel rear Aux (Video 1) input. Set to 0 to disable display panel rear Aux (Video 1) input.

## 040 - AUTO CAMPORT

Set to 1 to automatically switch to Camport when equipment is connected to front Video input. Set to 0 to disable front Video automatic source selection.

**Note:** If set to 1, item 093 RJP AVAILABLE is automatically set to 0.

## 046 - STRT AUX SRCE (Start Aux Source)

Sets the starting Aux source. When turned ON, the TV will tune to starting Aux source if item 004 STRT CHANNEL is set to 0.

If item 093 RJP AVAILABLE is set to 0 and item 040 AUTO CAMPORT is set to 0:

1 = Video 1	4 = RGB	255 = Last Aux
2 = Video 2	5 = HDMI 2	
3 = HDMI 1	6 = Component	

If item 093 RJP AVAILABLE is set to 1:

2 = Video 2	5 = HDMI 2	6 = Component
-------------	------------	---------------

If item 040 AUTO CAMPORT is set to 1:

1 = Video 1	4 = RGB	6 = Component
3 = HDMI 1	5 = HDMI 2	

## 047 - AUX STATUS

Set to 1 for MPI Aux source to be reported as a channel number instead of channel 0. Set to 0 to disable Aux identification change. Controls MPI status channel response for Aux inputs.

## 053 - DIS. CH-TIME (Disable Channel-Time)

Set to 1 to disable the Channel-Time display; Channel-Time display will not appear. Set to 0 to enable the Channel-Time display.

## 069 - EN. CH-T COL. (Enable Channel-Time Custom Color)

Set to 1 to enable custom color for the Channel-Time display. Set to 0 to disable custom color for the Channel-Time display.

## 070 - FOR. CH-TIME (Channel-Time Display Foreground Color)

Set according to Color Chart:

0 = Black	3 = Cyan	6 = Yellow
1 = Blue	4 = Red	7 = White
2 = Green	5 = Violet	

**Note:** Applies only to "Channel Not Available" message if item 073 is set to 1 (enabled). If foreground color and background color are the same, the menu background will be transparent.

## 071 - BCK. CH-TIME (Channel-Time Display Background Color)

Set according to Color Chart:

0 = Black	3 = Cyan	6 = Yellow
1 = Blue	4 = Red	7 = White
2 = Green	5 = Violet	

**Note:** Applies only to "Channel Not Available" message if item 073 is set to 1 (enabled). If foreground color and background color are the same, the menu background will be transparent.

## 073 - CH NOT AVBLE (Channel Not Available)

If set to 1 and item 028 CH. OVERRIDE is set to 0, a "NOT AVAILABLE" message is displayed when directly accessing a channel not in the channel scan list available in memory.

## 075 - REVERT CH (Revert to Start Channel)

If set to 1 and loss of MPI communication occurs, TV automatically tunes to the specified Start Channel.

## 078 - UPN MSB (UPN Most Significant Byte)

User programmable number, most significant byte readable by MPI command. Not linked to serial number.

## 079 - UPN MSB-1 (UPN Most Significant Byte-1)

User programmable number, most significant byte-1 readable by MPI command. Not linked to serial number.

## 080 - UPN MSB-2 (UPN Most Significant Byte-2)

User programmable number, most significant byte-2 readable by MPI command. Note: Not linked to serial number.

## 081 - UPN LSB (UPN Least Significant Byte)

User programmable number, least significant byte readable by MPI command. Note: Not linked to serial number.

## 082 - CHKSM ERROR (Checksum Error)

Enforces rigid MPI checksum validation. Set to 1 for validation. Set to 0 to disable (does not check checksum on MPI async port). SPI is always checked.

## 083 - HANDSHK TIME (Handshake Time)

Adds an additional delay to the handshake time which is 64 msec, thus relaxing MPI timing requirements to be compatible with PC-based Windows controlled systems. Range is 0 - 5. (Timeout = 25.5MS + [25.5 MS\* Handshake time].)

## 084 - PERMANENT BLK (Permanent Block)

Allows Lock (Parental Control) blocking schemes to be permanent by disabling the blocking hours function. Set to 1 to install Parental Control restrictions permanently. Set to 0 for user-specified hours control of blocking schemes.

## 087 - REAR RGB EN. (Rear RGB Enable)

Controls access to rear RGB input on TV. Set to 0 to disable RGB input. Set to 1 to enable for PC RGB input. Set to 17 to initiate a one-time automatic configuration after an AC power cycle; otherwise, automatic adjustment will be performed each time the RGB input is accessed.

## 088 - EN NOISE MUTE (Enable Noise Mute)

If set to 1, audio mutes if no signal is present.

## 090 - KEY LOCK

If set to 1, front keyboard Channel, Volume, and Captions buttons are disabled, Power button remains enabled. If set to 0, the Channel, Volume, Captions, and Power buttons are all enabled.

## 091 - YPrPb2 EN. (HDMI2 Enable)

Set to 0 to disable display panel HDMI2 input. Set to 1 to enable DTV mode. Set to 2 to enable PC mode.

## 093 - RJP AVAILABLE (Remote Jack Pack Available)

- 0 = Remote jack pack is not available or disabled.
- 1 = Legacy Model RJPs: HDMI Mode  
Enables RJP feature for use with full cable bundle models. In this mode, when an HDMI source is connected to the RJP, both digital video and audio are expected via the HDMI cable. If no digital audio is present, no audio will be heard.
- 2 = Legacy Model RJPs: DVI Mode  
Enables RJP feature for use with full cable bundle models. In this mode, when an HDMI/DVI source is connected to the RJP, only digital video is expected via the HDMI cable. Analog audio is provided via a separate cable, from the source, connected to an RJP AUDIO IN. If no analog audio cable is connected, tuner audio will be heard.
- 5 = Scaler Model RJPs: HDMI Mode  
Enables RJP feature for use with reduced cable bundle models. In this mode, when an HDMI source is connected to the RJP, both digital video and audio are expected via the HDMI cable. If no digital audio is present, no audio will be heard.



# Installer Menu (Cont.)

- **6 = Scaler Model RJP: DVI Mode**  
Enables RJP feature for use with reduced cable bundle models. In this mode, when an HDMI/DVI source is connected to the RJP, only digital video is expected via the HDMI cable. Analog audio is provided via separate cable, from the source, connected to an RJP AUDIO IN. If no analog audio cable is connected, tuner audio will be heard.

## Notes:

See Reference section, "RJP Model List and Input Auto-sensing Hierarchy." If RJP AVAILABLE is set to 1, 2, 5, or 6, item 040 AUTO CAMPORT is automatically set to 0. Settings 1, 2, 5, and 6 allow the lodge staff to customize each TV's RJP setup based on customer requirements.

### 094 - SAP MENU EN (2nd Audio Program)

Set to 1 to enable SAP feature on Function Menu, if Function Menu is available. Set to 0 to disable SAP feature on Function Menu, if Function Menu is available.

### 096 - DEF. ASP. RATIO (Default Aspect Ratio)

Selects default aspect ratio at power up.

- Set to 0 for Set By System.
- Set to 1 for 4:3.
- Set to 2 for 16:9 (Factory Default).
- Set to 3 for Just Scan.
- Set to 4 for Zoom.

**Note:** Only applies if item 106 ASP RATIO LOCK is disabled, set to 0.

### 098 - PRO:CENTRIC

Selects the Pro:Centric Mode. Set to 0 (default) to disable Pro:Centric operation. Set to 1 for Flash Mode. Set to 2 for GEM (Java Application) Mode.

### 099 - BACK LIGHTING

Sets the TV screen brightness at power up. Default setting is 100.

- 1 - 100 Static Back Lighting  
(1 = Dimmest picture, 100 = Brightest picture)
- 101 - 200 Dynamic Back Lighting  
(101 = Dimmest picture, 200 = Brightest picture)

If set between 101 and 200, the TV automatically controls back lighting depending upon the picture level of the current program. If set to 255, back lighting is controlled via the Picture settings in the TV's setup menus.

### 102 - ATSC BAND

Sets up TV to receive different types of incoming signals: 0 = Broadcast, 1 = CATV, 2 = HRC, 3 = IRC, 4 = Same as NTSC.

### 103 - ATSC TUNE MODE

Sets ATSC tuning mode: Default set to 1 for Physical Channel scan. Set to 0 for Virtual Channel scan.

### 104 - START MINOR CHANNEL

Sets Minor Start Channel number at power up. 0 = NTSC. If not 0, number selected is the digital channel's Minor Start Channel number.

### 106 - ASP RATIO LOCK (Aspect Ratio Lock)

Set to 1 to retain previous aspect ratio with power off. Set to 0 to retain default aspect ratio with power off. See item 096 DEF. ASP. RATIO above.

### 116 - VIDEO MUTE EN (Video Mute Enable)

Set to 0 for Normal. Set to 1 for Blank.

### 117 - FACT DEFAULT (Factory Default)

Set to 0 for normal. Set to 1 to load presets of all Installer Menu item settings.



**Warning: If set to 1, this will reload the factory defaults and clear the Channel List, including any assigned channel icons and custom channel labels.**

### 118 - POWER SAVINGS

Default is set to 3. When the TV is in Standby mode, the MPI card slot is powered by the Standby power supply and embedded *b*-LAN is not powered. When the TV is in Power On mode, the MPI card slot is powered by the main 12V power supply and embedded *b*-LAN is powered. Note that the TV must be turned ON in order to communicate with the Embedded *b*-LAN module for configuration and control when POWER SAVINGS is set to 3.

**Note:** MPI cards with *b*-LAN technology—LMT7Z5, LMT7Z7, LMT7Z9—are NOT supported on TVs in which the *b*-LAN module is embedded.

- 1 = MPI card slot Standby Mode power provided from Standby power supply, and Embedded *b*-LAN is always powered.
- 3 = MPI card slot Standby Mode power provided from Standby power supply, and Embedded *b*-LAN is only powered when the TV is turned ON.
- 7 = MPI card slot Standby Mode power provided from Standby power supply, and Embedded *b*-LAN (including the Pro:Centric data tuner) is never powered.

**Note:** See Reference section, "*b*-LAN Setup & Overview," for further information.

### 119 - DATA CHANNEL

Set to 0 (default) to disable. Set to the RF channel number of the Data Channel for Pro:Centric or E-Z Installation (splash screen, configuration, or firmware) data.

**Note:** Pro:Centric updates are downloaded from the Pro:Centric server to the TV when the TV is turned OFF. Also, while Pro:Centric updates are in progress, it is not possible to turn the TV ON. The TV may take several minutes to load EPG data after the initial download of the Pro:Centric application. Subsequent updates generally will take less than one minute.

# TV Setup Menus Overview

---

On-screen setup menus control the features of the TV. Press **MENU** on the Installer Remote to access the TV setup menus, and set the TV features to the desired configuration for the end user.

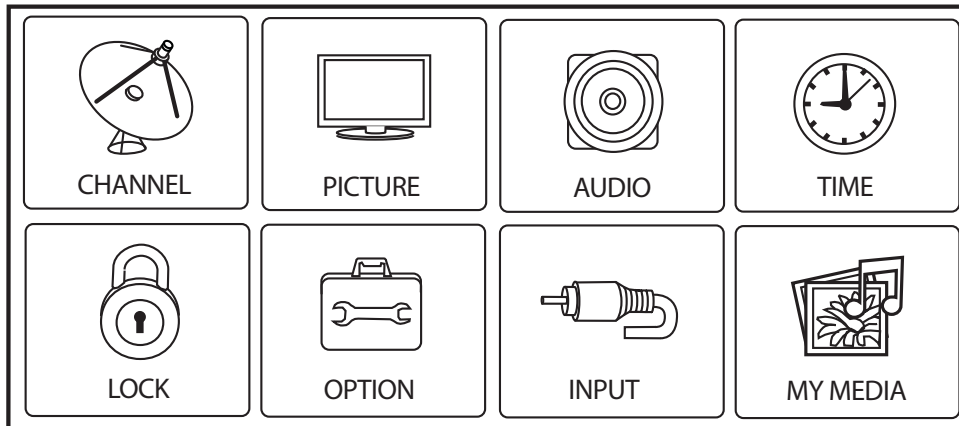

Refer to the Owner's Manual for further information on the TV setup menus.

# Adding Channel Label Icons / Custom Channel Labels (2-5-4 + MENU Mode)

## Editing/Adding Channel Icons and/or Labels

If there is no pre-assigned icon, you can make a custom channel label of up to seven (7) characters to help identify a channel or network. If desired, channel labels can also be added in addition to a pre-assigned icon. You may also add labels for the Aux input sources to clearly identify the devices that are connected to the Aux inputs.

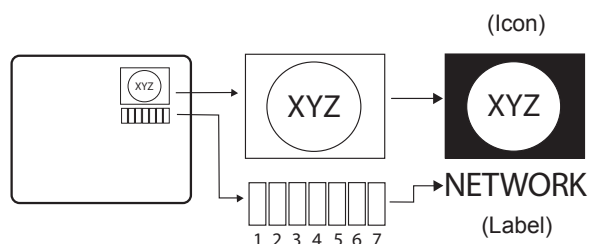

Editing and adding the labels can only be done if there are channels entered into the TV's Channel Map either during Commercial Mode Setup (see pages 12 to 13), by cloning, or by using some PPV provider's master remote controls. **Note:** A blank letter space is available between "Z" and "!".

## To perform channel editing/labeling:

1. Enter the TV Installer Menu.
2. Press **2-5-4 + MENU** on the Installer Remote to enter the Channel Label Editing Mode.
3. Add channel icons and channel labels as described in the procedures below. (You can do this more than once.)
4. To exit the menu when you are done, press **MENU**.

## Changing a Channel's Icon on the Master TV

1. Use Channel Up/Down to select the channel for which to change the icon.
2. Use the Left/Right arrow keys to select the thin letter "I" on the Channel ID display.
3. Use the Up/Down arrow keys to select the icon with which you want to identify the channel. (If you know the icon number, enter the number, and press **ENTER**.)
4. Proceed to change/add channel labels, or go to the next channel.

## Changing/Adding Channel Labels on the Master TV

1. Use Channel Up/Down to select the desired channel.
2. Press the Left/Right arrow repeatedly until the numbers 1 to 7 appear on the display. The number shows the position of the character that can be changed. Number 1 is the first character, number 2 the second character, etc.
3. Use the Up/Down arrow keys to select the desired character.
4. Proceed to the next number position, or use Channel Up/Down to go to the next channel.

## Changing Source Labels on the Master TV

1. Press **INPUT** to select the desired Aux input source: A/V 1, A/V 2, HDMI Component, RGB, etc.
2. Press the Left/Right arrow repeatedly until the numbers 0 to 9 appear on the display. The number shows the position of the character that can be changed.
3. Use the Up/Down arrow keys to select the desired character.
4. Press **INPUT** for the next Aux source, or proceed to change an icon or change/add labels. Use Channel Up/Down to return to channels.

## Installer Remote Control Key Functions for Master TV Channel Editing/Labeling Menu

- **Channel Up/Down:** Tunes in the next channel in scan.
- **Left/Right Arrows:** Select the item to change. If "I" is shown, the icon can be changed. If a number is shown, it indicates the position of the character that can be changed.
- **Up/Down Arrows:** Select the icon or the character to be displayed. Tip: Arrows can be held down for fast scrolling.
- **0 – 9:** Use to enter the index number of the icon, if known.
- **ENTER:** Changes the icon after the number has been entered.
- **INPUT:** Changes the Aux input label.
- **MENU:** Exits the editing process.

The following steps outline local FTG configuration of individual TVs. Since these models are equipped with the EBL module, they can also be broadcast configured in FTG Mode by a Free-To-Guest Management Appliance (FMA) head end device. Refer to the **Free-To-Guest (FTG) Configuration Application** manual and/or the Installation & Setup manual for the FMA device for further information.

**Note:** FTG Configuration Application software is available online at: [www.LGcommercial.com/FTGsoftware](http://www.LGcommercial.com/FTGsoftware).

1. Install (if necessary) and launch the FTG Configuration Application (v5.0.0 or higher) on the PC that will be used to configure the EBL.
2. Build a Channel Map using the FTG Channel Map Editor in the FTG Channel Map Configuration Utility (or, if applicable, open an existing FTG Configuration (.rml) file).
3. Connect the PC to the TV-LINK CFG jack on the rear connections panel using a USB-to-TTL serial cable (TTL-232R-5V-AJ). If necessary, install the device driver on the PC.
4. Turn ON the TV. Note: The TV will briefly display a green text banner that shows the EBL firmware version and release date.
5. "Write" the FTG Channel Map to the EBL (converts EBL from Pass-through Mode to FTG Mode).
6. "Read" the current FTG Installer Menu settings from the EBL using the FTG Installer Menu Configuration Utility. If necessary to make changes to Installer Menu items, "Write" them back to the EBL in FTG Mode.
7. Save the FTG Channel Map and FTG Installer Menu settings to an FTG Configuration (.rml) file for future use.
8. Tune the TV to a Logical Channel in the FTG Channel Map.

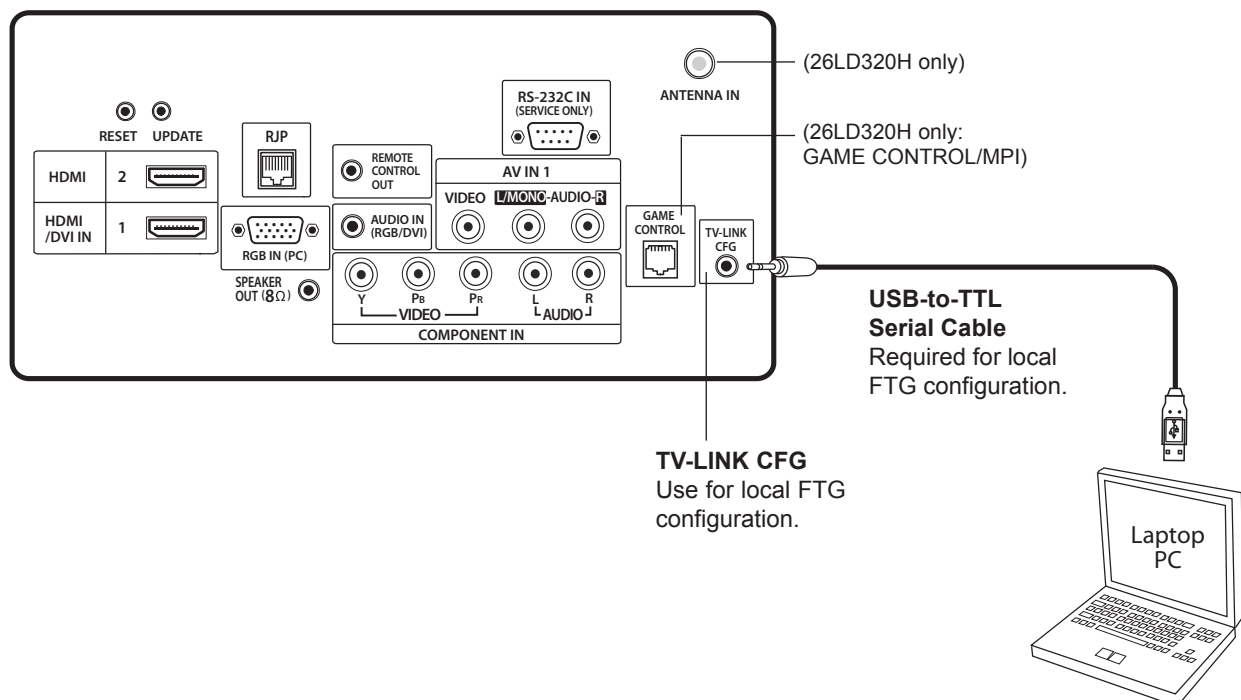

# FTG Mode of Operation (Cont.)

## Determining the TV Operating Mode / FTG Channel Map Configuration Utility Overview

To determine the operating mode of the TV, press **MENU** on the Installer Remote. If the end user Function Menu (showing aspect ratio options—see below) appears, the TV/EBL is in FTG Mode. If the TV setup menus appear, the EBL is in Pass-through Mode.

The following pages provide overviews of the FTG Channel Map and FTG Installer Menu Configuration Utilities that comprise the FTG Configuration Application. Refer to the **Free-To-Guest (FTG) Configuration Application** manual for further information.

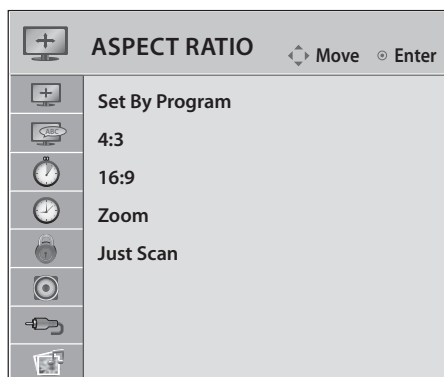

### Function Menu

Shows that the EBL is in FTG Mode. While this menu is present on-screen, Installer Menu settings can **ONLY** be accessed/changed using the FTG Configuration Application.

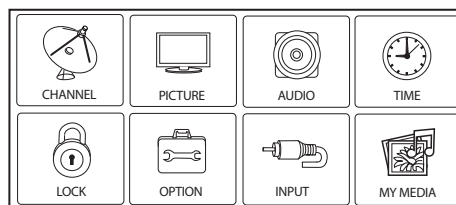

### TV Setup Menus

Shows that the EBL is in Pass-through Mode.

Writing an FTG Channel Map into the EBL will switch the EBL from Pass-through Mode to FTG Mode.

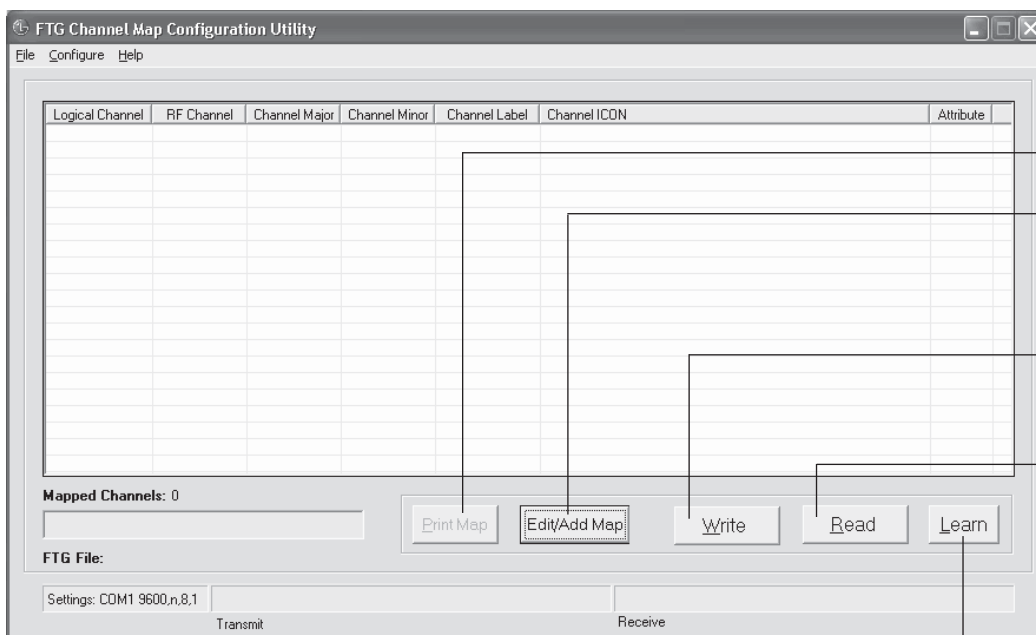

### PRINT MAP

Click to display a printable FTG Channel Map Report. The report can also be exported as an HTML or Text file.

### EDIT/ADD MAP

Click to open the FTG Channel Map Editor to create or edit an FTG Channel Map (see next page).

### WRITE

Click to transfer the FTG Channel Map to the EBL.

### READ

Click to transfer the FTG Channel Map from the EBL to the FTG Configuration Application.

### FTG CHANNEL MAP CONFIGURATION UTILITY

### LEARN

Click to transfer the TV Channel Map from the PTC to the EBL and the FTG Configuration Application. (Requires that 2-5-5 + MENU was performed to transfer TV Channel Map to PTC.) \*

\* Logical Channel numbers will automatically be assigned in ascending order, starting with 0 (zero), to the Physical Channels from the TV Channel Map.

## FTG Channel Map Configuration Utility / FTG Channel Map Editor Overview

The FTG Channel Map Editor shows a single Logical Channel's Data and the FTG Channel Map.

### LOGICAL CHANNEL MAPPING

Select a Logical Channel number, then assign it the RF, Major, and Minor channel numbers to complete the mapping.

### CUSTOM CHANNEL LABELS/ICONS

Enter custom labels and select icons by name on menu or by number.

### SET CHANNEL ATTRIBUTES

Check/select Encrypted, OSD, or Blank Video.

Logical Channel	RF Channel	Channel Major	Channel Minor	Channel Label	Channel ICON	Attribute
2	2	2	0	WBBM-TV	14 - CBS	0
5	5	5	0	WMAQ-TV	15 - NBC	0
7	7	7	0	WLS-TV	13 - ABC	0
9	9	9	0	WGN-TV	89 - WGN	0
11	11	11	0	WTTW	17 - PBS	0
14	31	31	3	FOX	16 - FOX	0
15	19	19	3	WGN	89 - WGN	0
16	47	47	4	KIDS	133 - PBS Kids	0
17	27	27	3	THE U	174 - UPN	0
40	65	65	1	HBO-HD	12 - HBO	EO
41	66	66	1	ESPN-HD	2 - ESPN	EO
42	67	67	1	ESPN2HD	21 - ESPN2	EO
43	68	68	1	TNT-HD	4 - TNT	EO
44	69	69	1	HDNET	161 - HDNet	EO
52	74	74	1	STARZHD	33 - Starz	EO
53	75	75	1	HISTHD	58 - History	EO
54	76	76	1	M&X-HD	47 - Cinemax	EO

### UPDATE

After editing an existing Logical Channel's data, click to commit the changes in the FTG Channel Map.

### ADD

After defining a new Logical Channel, click to add channel to the FTG Channel Map.

### DELETE

Click to remove highlighted channel from FTG Channel Map.

### EXIT

Click to exit editor and return to FTG Channel Map Configuration Utility.

# FTG Mode of Operation (Cont.)

## FTG Installer Menu Configuration Utility Overview

### CONFIGURATION SETTINGS

Select tabs for categories of Installer Menu items to set up TV.

### HOSPITAL-GRADE TV ONLY

Set Hospital items on Installer Menu for hospital-grade TVs.

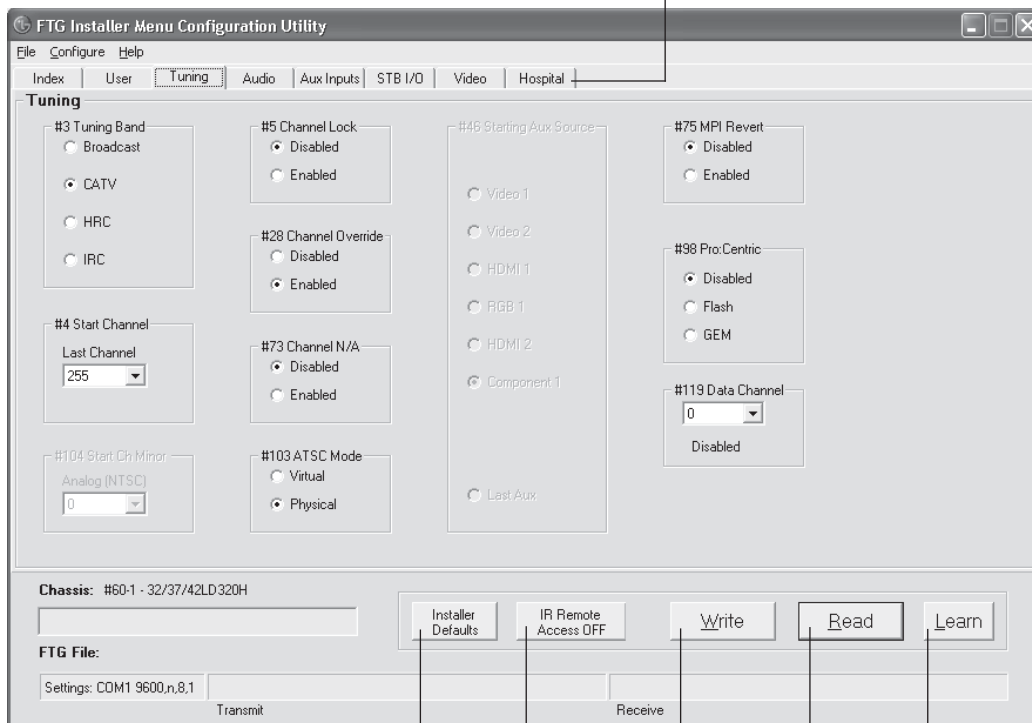

### INSTALLER DEFAULTS

Click to reset FTG Installer Menu items shown in the FTG Configuration Application to defaults.

### IR REMOTE ACCESS

Toggle IR Remote Access to ON to obtain access to TV setup menus and Installer Menu.

### WRITE

Click to transfer the FTG Installer Menu settings to the EBL.

### LEARN

Click to transfer Installer Menu settings from the PTC to the EBL and FTG Configuration Application. \*

### READ

Click to transfer the Installer Menu settings in the EBL to the FTG Configuration Application.

\* Logical Channel numbers will automatically be assigned in ascending order, starting with 0 (zero), to the Physical Channels from the TV Channel Map.

# Cloning Overview / Clonable Menu Features

## IMPORTANT CLONING INFORMATION

There are three options for cloning a Master TV Setup:

- Using a USB memory device
- Using a TLL-1100A clone programmer
- Using a LT2002 clone programmer

Each option is described in further detail on the pages that follow. As you perform cloning procedures, be sure to complete each task as indicated. If a procedure or step is omitted or not performed completely, cloning may not work. At each step, pay attention to ensure the TV screen shows the proper message when cloning. If the message indicated does not appear, there is a problem with that step, and cloning may not be successful.



**Warning: Copying a blank or incorrect memory into a TV will cause the TV to operate erratically or become inoperable.**



**Warning: Do not connect a clone programmer to a PPV card installed in the Master or Target TVs. Also, if the TV is in LodgeNet PPV Mode (check with the site administrator if you are not certain), do not connect a clone programmer to the GAME CONTROL/MPI port. Either of these actions will damage the clone programmer and, if applicable, the PPV card.**

### Before you begin cloning:

- Complete the Commercial Mode Setup procedure on pages 12 to 13.
- All equipment should be connected to power and turned ON.
- Learning and Teaching is only possible between identical model TVs.
- For both Master and Target TVs—The TV EBL must be in Pass-through Mode.
- If using a USB memory device, ensure the USB device has been formatted with FAT format.
- For both Master and Target TVs—If using a clone programmer, ensure the TV signal source is either an Aux or TV (RF) source. If a TV (RF) source, the TV must be tuned to an analog (not a digital) channel.
- LT2002 only—Make sure the batteries in the clone programmer are fresh. If batteries are removed, the clone programmer clock time (if set) will be lost (see page 32 for information on the clone programmer clock).
- Do not unplug the TV power cord or remove/disconnect the USB memory device/clone programmer while Learning or Teaching, as doing so may cause the TV to malfunction or harm the USB device/clone programmer, respectively.

## Clonable Menu Features

### Installer Menu

Installer Menu item settings

### Channel

Auto Tuning (Channel Lineup)  
Manual Tuning  
Channel Edit  
Channel Label

### Picture

Aspect Ratio  
Picture Mode  
Advanced Control

### Audio

Auto Volume  
Clear Voice  
Sound Mode  
Balance  
TV Speaker

### Option

Menu Language  
Audio Language  
Caption  
Caption Mode  
Digital Caption Options

### Lock

Movie Rating  
TV Rating – Children  
TV Rating – General  
Input Block

### Time

Auto Clock  
Manual Clock  
Off Time  
On Time  
Auto Off (Sleep Timer)

**Note:** Some menu options vary between analog and digital channels and Aux sources.



# Cloning Procedures

## Learning / Teaching a Master TV Setup using a USB Memory Device

### USB Cloning Notes

- Read the IMPORTANT CLONING INFORMATION on page 27 before beginning any cloning procedures.
- You may edit a file name as part of the Learning procedure; however, a file with edited contents will not be recognized.
- It is not possible to clone a Master TV's clock using a USB memory device. Either set a Target TV's clock manually, or use the Auto Clock setting in the TV setup menus.

### Learn Setup from Master TV

1. Ensure the Master TV is set up completely and the EBL is in Pass-through Mode.
2. Plug the USB memory device into the USB IN port on the Master TV.
3. Press **MENU** to display the TV setup menus.
4. Use the arrow navigation keys to select/highlight the **Option** menu icon; then, press the number "7" key a total of seven times to display the USB Download Menu.
5. To gain access to the Learn From TV option in the USB Download Menu, key in the password used to enter the Installer Menu (Example: Press **9-8-7-6**).
6. Use the Up/Down arrow keys to select **Learn From TV** and press **ENTER**.
7. To identify the profile from others, you can use the Up/Down arrow keys to change the last five digits of the file name. Press **ENTER** when you are ready to initiate Learning.  
Learning status will be shown on the progress bar. When the Learning process is complete, the USB Download menu will reappear on screen.
8. Remove the USB memory device.

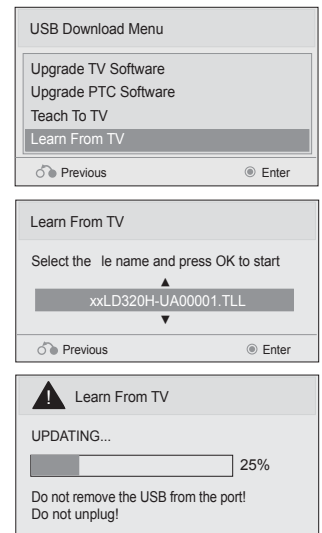

### Teach Master TV Setup to Target TV

1. Ensure the Target TV EBL is in Pass-through Mode, and then plug the USB memory device with the Master TV Setup file into the Target TV USB IN port.
2. Press **MENU** to display the TV setup menus.
3. Use the arrow navigation keys to select/highlight the **Option** menu icon; then, press the number "7" key a total of seven times to display the USB Download Menu.
4. Use the Up/Down arrow keys to select **Teach To TV** and press **ENTER**.
5. Use the Up/Down arrow keys to select/highlight the Master TV Setup you want to install and press **ENTER**. Note: Filenames identify the TV and the TLL version (see example at right).  
Teaching status will be shown on the progress bar. When the Teaching process is complete, the USB Download menu will reappear on screen.
6. When Teaching is done, remove the USB memory device, turn OFF the TV, and unplug the TV power cord for 15 seconds.
7. Reconnect the TV power cord, and turn ON the TV. The Master TV Setup should be resident on the Target TV.

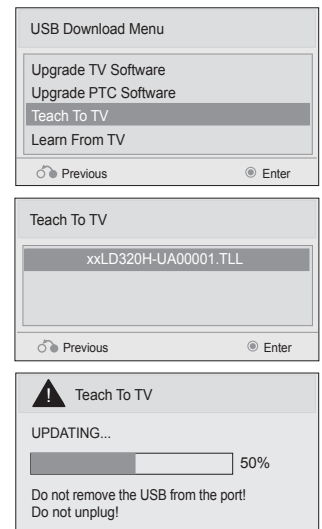

## Learning / Teaching a Master TV Setup using a TLL-1100A Clone Programmer



**Warning: Do not connect a clone programmer to a PPV card installed in the Master or Target TVs. Also, if the TV is in LodgeNet PPV Mode (check with the site administrator if you are not certain), do not connect a clone programmer to the GAME CONTROL/MPI port. Either of these actions will damage the clone programmer and, if applicable, the PPV card.**

Cloning is accomplished using the TV/clone programmer MPI ports for communication (see figure).

### TLL-1100A Cloning Notes

- Read the IMPORTANT CLONING INFORMATION on page 27 before beginning any cloning procedures.
- Ensure the TLL-1100A is either fully charged or connected to AC power.
- Learning and Teaching is only possible between identical model TVs; however, the TLL-1100A clone programmer can store up to eight different Master TV Setups.

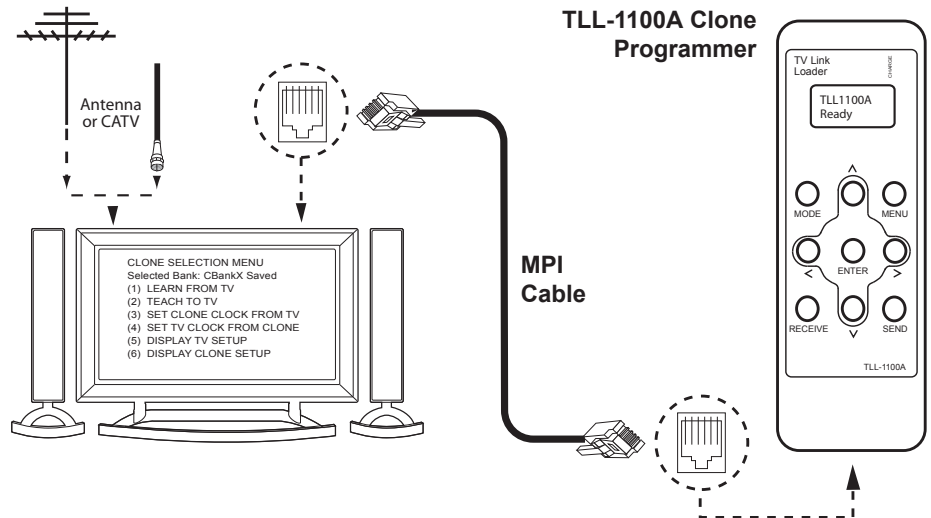

### Learn Setup from Master TV

1. Ensure the Master TV is set up completely and the EBL is in Pass-through Mode.
2. If an analog channel is not available, direct tune the TV to an Aux source, or select an Aux source, such as AV-1, from the Input Menu. Then, plug one end of the MPI cable into the TV MPI port.
3. Turn ON the TLL-1100A.
4. Use the **MODE** button on the TLL-1100A to select **Clone Mode**.
5. Use the Left/Right arrows on the TLL-1100A to select the Memory CBank (1 to 8) in which to store the Master TV Setup.
6. Plug the other end of the MPI cable into the MPI port on the bottom of the TLL-1100A. The Clone Selection Menu will display on the TV screen.
7. Press **1** on the Installer Remote to select **LEARN FROM TV** from the Clone Selection Menu. Then, press **ENTER** to transfer the Master TV Setup into CBankX on the TLL-1100A.

Learning usually takes about 90 seconds. "LEARNING IN PROGRESS" will be displayed on the screen while the TLL-1100A copies the Master Setup. When the Learning process is complete, a "LEARNING COMPLETE" message will be displayed.

CLONE SELECTION MENU  
Selected Bank: CBankX Saved  
(1) LEARN FROM TV  
(2) TEACH TO TV  
(3) SET CLONE CLOCK FROM TV  
(4) SET TV CLOCK FROM CLONE  
(5) DISPLAY TV SETUP  
(6) DISPLAY CLONE SETUP

CLONE CLOCK = XX:XX  
TV CLOCK = XX:XX  
THE CLONE IS VERSION VX.X.X  
- To change menu items, press channel keys or digits.  
- To execute item, press Enter.

# Cloning Procedures (Cont.)

## Learning / Teaching a Master TV Setup using a TLL-1100A Clone Programmer (Cont.)

---

### (Optional) Set the Clock

Set the time on a Master TV's clock. (If the time has already been copied from a TV into the TLL-1100A clone programmer, you can set the Master TV's clock by copying the time from the clone programmer.) The TLL-1100A can copy the current time to both a Master TV and to the clone's internal clock—accurate to within one minute.

Since the TLL-1100A's time cannot be set directly, the current time needs to be copied from an LG TV equipped with an enabled MPI port.

After the time is copied to the TLL-1100A clone programmer, the current time will be maintained and can then be transferred to another TV. (This can be a Master TV or another TV which has already had the features set up.)

```
CLONE SELECTION MENU
Selected Bank: CBankX Saved
(1) LEARN FROM TV
(2) TEACH TO TV
(3) SET CLONE CLOCK FROM TV
(4) SET TV CLOCK FROM CLONE
(5) DISPLAY TV SETUP
(6) DISPLAY CLONE SETUP

CLONE CLOCK = XX:XX
TV    CLOCK = XX:XX
THE CLONE IS VERSION VX.X.X
- To change menu items, press
  channel keys or digits.
- To execute item, press Enter.
```

### Teach Master TV Setup to Target TV

1. When Learning is complete, disconnect the MPI cable from the Master TV.
2. Ensure the Target TV EBL is in Pass-through Mode and the TV is tuned/ set to an analog channel or Aux source, and then connect the MPI cable to the MPI port on the Target TV. The Clone Selection Menu will display on the TV screen.
3. Ensure the correct Memory CBank(X) is selected on the TLL-1100A.
4. Press **2** on the Installer Remote to select **TEACH TO TV** from the Clone Selection Menu. Then, press **ENTER** to transfer the Master TV Setup to the Target TV.

Teaching usually takes 3 to 4 minutes. "TEACHING IN PROGRESS" will be displayed on the screen during Teaching. When the Teaching process is complete, a "TEACHING COMPLETE" message will be displayed.

5. When Teaching is done, disconnect the MPI cable from the Target TV, turn OFF the TV, and unplug the TV power cord for 15 seconds.
6. Reconnect the TV power cord, and turn ON the TV. The Master TV Setup should be resident on the Target TV.

```
CLONE SELECTION MENU
Selected Bank: CBankX Saved
(1) LEARN FROM TV
(2) TEACH TO TV
(3) SET CLONE CLOCK FROM TV
(4) SET TV CLOCK FROM CLONE
(5) DISPLAY TV SETUP
(6) DISPLAY CLONE SETUP

CLONE CLOCK = XX:XX
TV    CLOCK = XX:XX
THE CLONE IS VERSION VX.X.X
- To change menu items, press
  channel keys or digits.
- To execute item, press Enter.
```

## Learning / Teaching a Master TV Setup using an LT2002 Clone Programmer



**Warning: Do not connect a clone programmer to a PPV card installed in the Master or Target TVs. Also, if the TV is in LodgeNet PPV Mode (check with the site administrator if you are not certain), do not connect a clone programmer to the GAME CONTROL/MPI port. Either of these actions will damage the clone programmer and, if applicable, the PPV card.**

Cloning is accomplished using the TV/clone programmer MPI ports for communication (see figure).

### LT2002 Cloning Notes

- Read the IMPORTANT CLONING INFORMATION on page 27 before beginning any cloning procedures.
- A slow flashing green light indicates that there are communication problems between the TV and the LT2002 clone programmer. If this is the case, check for a damaged cable, poor contacts, or other connection troubles.
- If the status indicator is red, the LT2002 batteries are low and should be replaced. Install four (4) high-quality alkaline AA batteries.
- Learning and Teaching is only possible between identical model TVs; however, the LT2002 clone programmer can store up to three different Master TV Setups.

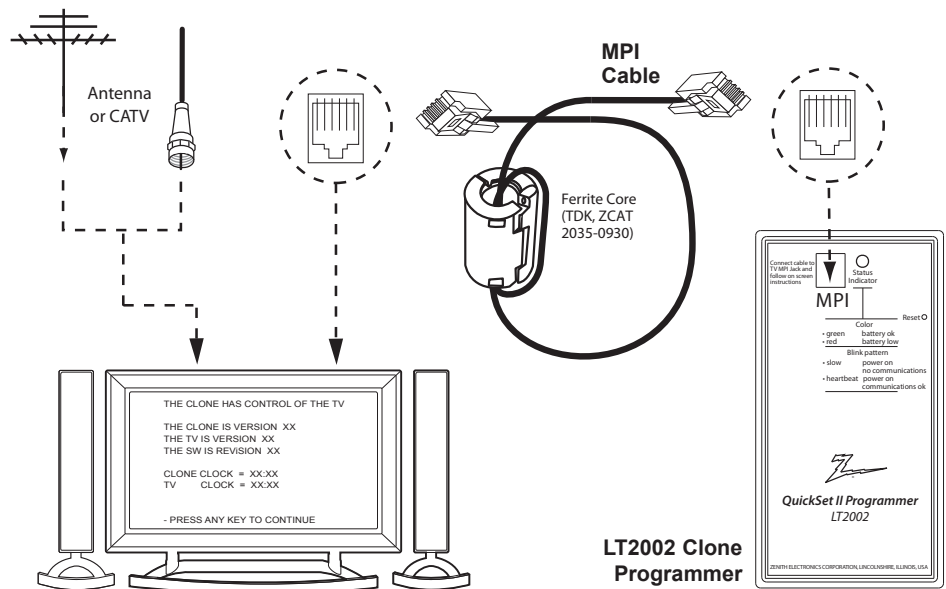

### Learn Setup from Master TV

1. Ensure the Master TV is set up completely and the EBL is in Pass-through Mode.
2. If an analog channel is not available, direct tune the TV to an Aux source, or select an Aux source, such as AV-1, from the Input Menu. Then, plug one end of the MPI cable into the TV MPI port.
3. If there is a good connection after the LT2002 is connected to the TV MPI port, "THE CLONE HAS CONTROL OF THE TV" message will appear on the TV screen. Press any key on the Installer Remote to access the LT2002 Clone Selection Menu.
4. Press **1** on the Installer Remote to select **LEARN FROM TV** from the Clone Selection Menu; then press **ENTER** to proceed to the Memory Bank Selection Menu (see sample screen on next page).
5. Select the clone Memory Bank in which to store the Master Setup by pressing either Channel key repeatedly to choose Memory Bank 1, 2, or 3. Note: If you choose a Memory Bank that already has a Master device's setup programmed into it, that setup will be overwritten by the new Master TV Setup.

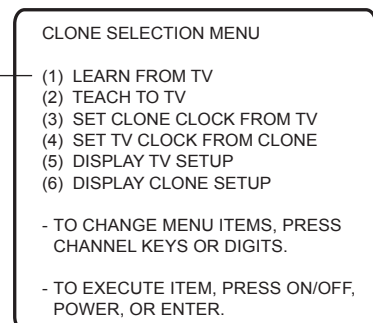
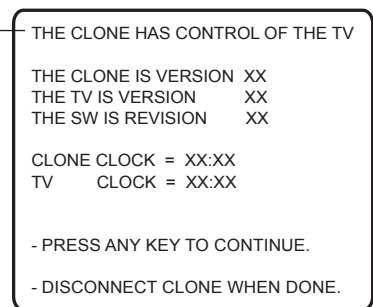

(Continued on next page)

# Cloning Procedures (Cont.)

## Learning / Teaching a Master TV Setup using an LT2002 Clone Programmer (Cont.)

(Continued from previous page)

6. Once you select the clone Memory Bank, press **ENTER** on the Installer Remote. The Memory Bank you selected will be shown.
7. Press **POWER** to transfer the Master TV Setup into the selected Memory Bank on the LT2002.

Learning usually takes about 90 seconds. "LEARNING IN PROGRESS" will be displayed on the screen while the LT2002 copies the Master Setup. When the Learning process is complete, a "LEARNING COMPLETE" message will be displayed.

SAVE TV SETUP IN SELECTED CLONE MEMORY

- (1) MEMORY 1 VER XX REV XX
- (2) MEMORY 2 VER XX REV XX
- (3) MEMORY 3 VER XX REV XX
- (4) RETURN TO CLONE MENU

- TO CHANGE MENU ITEMS, PRESS CHANNEL KEYS OR DIGITS.

- TO EXECUTE ITEM, PRESS ON/OFF, POWER, OR ENTER.

### (Optional) Set the Clock

Set the time on a Master TV's clock. (If the time has already been copied from a TV into the LT2002 clone programmer, you can set the Master TV's clock by copying the time from the clone programmer.) The LT2002 can copy the current time to both a Master TV and to the clone's internal clock—accurate to within one minute. (Another reason that the LT2002 should be equipped with fresh, high-quality alkaline batteries, is for it to keep the time as accurately as possible.)

Since the LT2002's time cannot be set directly, the current time needs to be copied from an LG TV equipped with an enabled MPI port.

After the time is copied to the LT2002 clone programmer, the current time will be maintained and can then be transferred to another TV. (This can be a Master TV or another TV which has already had the features set up.)

CLONE SELECTION MENU

- (1) LEARN FROM TV
- (2) TEACH TO TV
- (3) SET CLONE CLOCK FROM TV
- (4) SET TV CLOCK FROM CLONE
- (5) DISPLAY TV SETUP
- (6) DISPLAY CLONE SETUP

- TO CHANGE MENU ITEMS, PRESS CHANNEL KEYS OR DIGITS.

- TO EXECUTE ITEM, PRESS ON/OFF, POWER, OR ENTER.

### Teach Master TV Setup to Target TV

1. When Learning is complete, disconnect the MPI cable from the Master TV.
2. Ensure the Target TV EBL is in Pass-through Mode and the TV is tuned/set to an analog channel or Aux source, and then connect the MPI cable to the MPI port on the Target TV.
3. With "THE CLONE HAS CONTROL OF TV" message on display, press **2** on the Installer Remote to select **TEACH TO TV** from the LT2002 Clone Selection Menu. Then, press **ENTER**.

4. Select the LT2002 Memory Bank in which the new setup is located. Then, press **POWER** to transfer the Master TV Setup to the Target TV.

Teaching usually takes 3 to 4 minutes. "TEACHING IN PROGRESS" will be displayed on the screen during Teaching. When the Teaching process is complete, a "TEACHING COMPLETE" message will be displayed.

5. When Teaching is done, press any key on the Installer Remote to return to the Clone Selection Menu. Then, press **ENTER**.
6. Disconnect the MPI cable from the Target TV, turn OFF the TV, and unplug the TV power cord for 15 seconds.
7. Reconnect the TV power cord, and turn ON the TV. The Master TV Setup should be resident on the Target TV.

CLONE SELECTION MENU

- (1) LEARN FROM TV
- (2) TEACH TO TV
- (3) SET CLONE CLOCK FROM TV
- (4) SET TV CLOCK FROM CLONE
- (5) DISPLAY TV SETUP
- (6) DISPLAY CLONE SETUP

- TO CHANGE MENU ITEMS, PRESS CHANNEL KEYS OR DIGITS.

- TO EXECUTE ITEM, PRESS ON/OFF, POWER, OR ENTER.

COPY SELECTED CLONE MEMORY TO TV

- (1) MEMORY 1 VER XX REV XX
- (2) MEMORY 2 VER XX REV XX
- (3) MEMORY 3 VER XX REV XX
- (4) RETURN TO CLONE MENU

- TO CHANGE MENU ITEMS, PRESS CHANNEL KEYS OR DIGITS.

- TO EXECUTE ITEM, PRESS ON/OFF, POWER, OR ENTER.

# Remote Jack Pack / TV Connections & Setup

## Remote Jack Pack Setup

RJP Available? If you will use a Remote Jack Pack (RJP) in your system, set Installer Menu item **093 RJP AVAILABLE** appropriately (for example, on a legacy model RJP: HDMI Mode, set RJP AVAILABLE to 001). See Installer Menu detailed descriptions for further information.

093 RJP AVAILABLE 001

## TV Connections



**Make these connections ONLY after Commercial Mode Setup and Cloning Master TV procedures are complete.**

Refer to the figure below, and connect the RJ-45 Control cable from the RJP cable bundle to the RJP INTERFACE port on the TV's jack panel. Then, connect HDMI, RGB, and Composite Video/Audio connectors, as applicable, for the cable bundle.

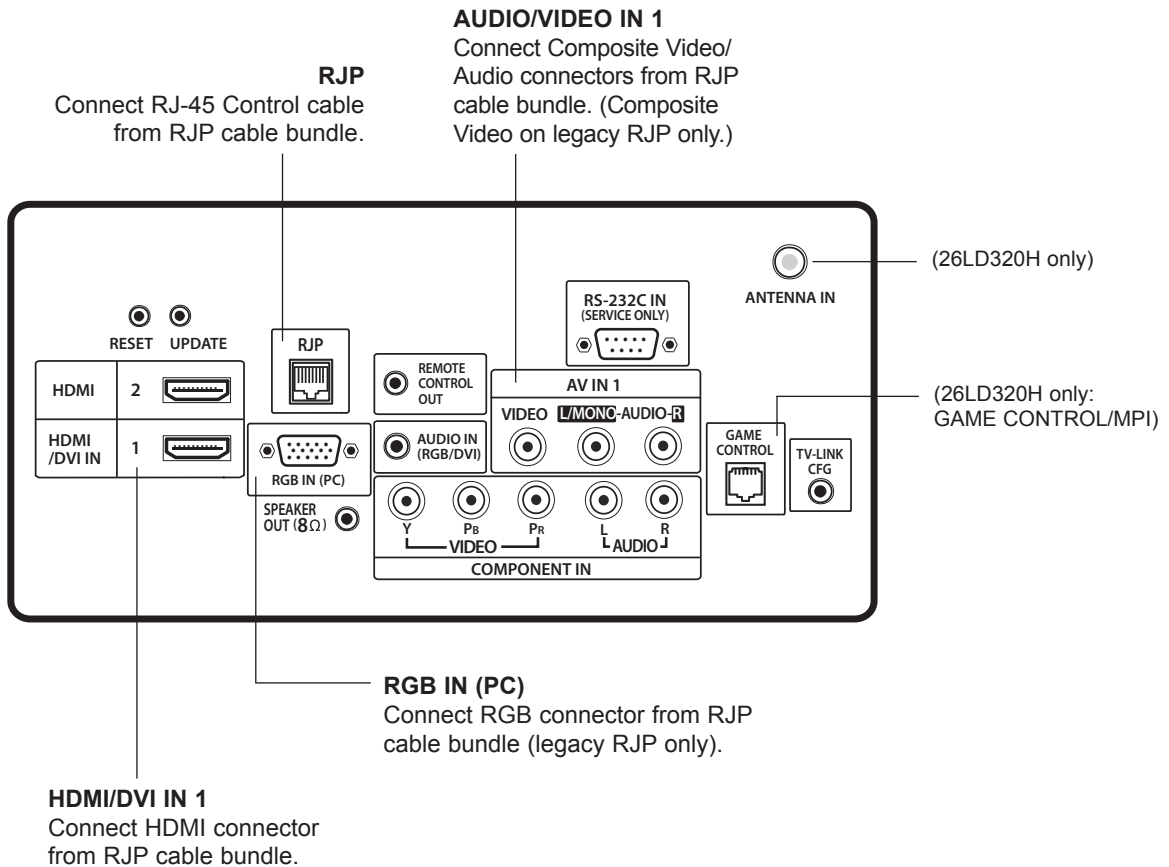

# Reference: Upgrading TV/PTC Software using a USB Memory Device

## Checking the Software Versions

**Note:** This function is not accessible while the TV is in FTG or PPV Mode.

You can check the software versions of the TV by accessing the Installer Menu with the Installer Remote: Press **MENU** repeatedly until the on-screen setup menus lock up, and then press **9-8-7-6 + ENTER**. When you are finished, press **ENTER** again to exit the Installer Menu.

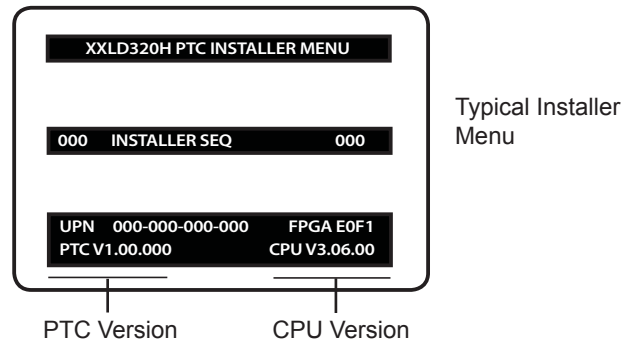

## Upgrading TV/PTC Software

Before you begin, note that the software upgrade files must be stored in a folder named "LG\_DTV" in the root directory of the USB memory device. Also, ensure the USB device has been formatted with FAT format.

**Note for TV Software Upgrade only:** If the TV detects a later version of software on the USB device, it will automatically display a dialog from which you can start the software upgrade immediately. Otherwise, you can close the dialog, and access the USB Download Menu as described below.

1. Turn the TV ON.
2. Plug the USB memory device into the USB IN port on the TV.
3. Press **MENU** on the Installer Remote to display the TV setup menus.
4. Use the arrow navigation keys to select/highlight either the **Option** (if EBL is in Pass-through Mode) or **Lock** (if TV is in FTG or LodgeNet PPV Mode) menu icon; then, press the number "7" key a total of seven times to display the USB Download Menu.
5. Use the Up/Down arrow keys to select **Upgrade TV Software** or **Upgrade PTC Software**, as applicable, and press **ENTER**.
6. Select the appropriate option(s), depending on the type of upgrade you are performing:
  - **TV Software Upgrade:** (See screen samples at right.) Select **TV Software Update** from the first TV Software Update window. In the second TV Software Update window, select/highlight the update file to install and press **ENTER**.  
**Note:** Do not select Forced Update options unless you have been specifically instructed to do so or have previous experience with Expert Software Updates.
  - **PTC Software Upgrade:** In the PTC Software Update window, select/highlight the update file to install and press **ENTER**.  
**Note:** The PTC Software Update window is similar to the second TV Software Update window, though there are no Forced Update options. Current software version information is shown at the top and update files on the USB device are listed at the bottom of the window.

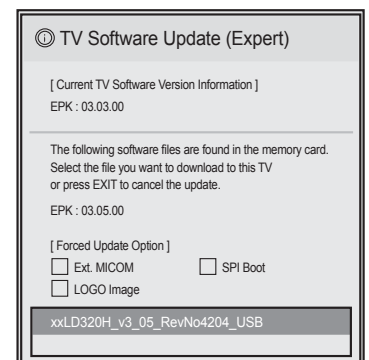
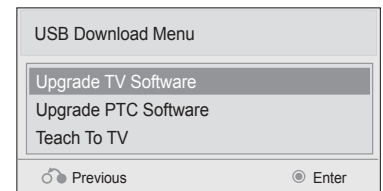

The TV will show update completion progress in a new window. Do NOT remove the USB device until the software upgrade is complete. When a TV software upgrade is complete, the TV will reset itself with an automatic restart. When a PTC upgrade is complete, the TV will turn OFF.

# Reference: Downloading a Splash Screen using a USB Memory Device

## Splash Screen Image File Guidelines

- The splash screen image must be a baseline (not progressive) JPEG.
- The image should be no larger than 1 MB.
- The ideal size for the image is 1366 x 768 pixels or under.
- The image file must be stored in a folder named “LG\_DTV” in the root directory of USB memory device.
- Ensure the USB device has been formatted with FAT format.

## Downloading a Splash Screen Image

1. Turn the TV ON.
2. Plug the USB memory device into the USB IN port on the TV.
3. Press **MENU** on the Installer Remote to display the TV setup menus.
4. Use the arrow navigation keys to select/highlight either the **Option** (if EBL is in Pass-through Mode) or **Lock** (if TV is in FTG or LodgeNet PPV Mode) menu icon; then, press the number “7” key a total of seven times to display the USB Download Menu.
5. Use the Up/Down arrow keys to select **Upgrade TV Software** and then press **ENTER**.
6. Select **LOGO Image Download** from the first TV Software Update window.
7. In the second TV Software Update window, select/highlight the image file to download and press **ENTER**.

The TV will show download completion progress in a new window. Do NOT remove the USB device until the image download is complete. When the image download is complete, the TV will reset itself with an automatic restart. Upon the restart, you should see the new splash screen.

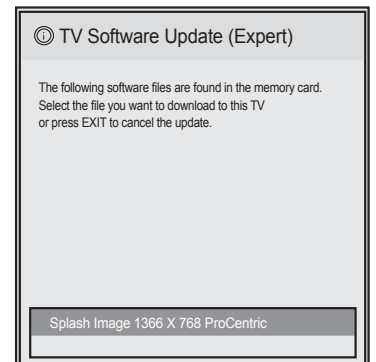
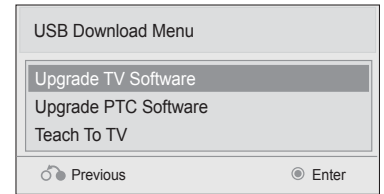



## Reference: Power Consumption Settings

The following tables assume that Installer Menu item 118 POWER SAVINGS is set to 003 (default) and Installer Menu item 099 BACK LIGHTING is set as shown below (default value is 100).

Item 099 Back Lighting (Static)	26LD320H		32LD320H / 32LD325H		37LD320H / 37LD325H		42LD320H	
	Power Consumption (Watts)	Percent Savings	Power Consumption (Watts)	Percent Savings	Power Consumption (Watts)	Percent Savings	Power Consumption (Watts)	Percent Savings
100	56.82	0.00%	72.97	0.00%	88.92	0.00%	107.53	0.00%
90	51.98	8.52%	63.82	12.54%	84.19	5.32%	86.68	19.39%
80	47.09	17.13%	58.53	19.78%	77.84	12.46%	78.79	26.73%
70	42.06	25.97%	53.58	26.57%	72.19	18.81%	72.81	32.29%
60	39.71	30.12%	44.24	39.38%	66.28	25.46%	66.78	37.89%
50	37.36	34.25%	41.27	43.45%	60.90	31.51%	60.61	43.63%
40	36.31	36.10%	38.71	46.95%	56.58	36.37%	56.35	47.60%
30	35.12	38.19%	36.20	50.39%	52.35	41.13%	52.90	50.81%
20	32.59	42.64%	33.51	54.07%	47.75	46.30%	47.71	55.63%
10	30.23	46.80%	31.01	57.51%	43.68	50.88%	43.04	59.98%
1	27.95	50.82%	28.55	60.87%	39.62	55.44%	38.86	63.86%

Item 099 Back Lighting (Dynamic)	26LD320H		32LD320H / 32LD325H		37LD320H / 37LD325H		42LD320H	
	Power Consumption (Watts)	Percent Savings	Power Consumption (Watts)	Percent Savings	Power Consumption (Watts)	Percent Savings	Power Consumption (Watts)	Percent Savings
200	72.19	0.00%	75.45	0.00%	110.86	0.00%	125.41	0.00%
190	68.21	5.51%	69.23	8.25%	99.05	10.65%	111.41	11.16%
180	63.72	11.74%	65.26	13.51%	92.33	16.72%	103.30	17.63%
170	59.21	17.99%	60.72	19.53%	85.39	22.98%	95.29	24.02%
160	55.04	23.76%	56.29	25.40%	78.61	29.10%	87.64	30.11%
150	50.81	29.62%	51.82	31.33%	71.70	35.32%	79.71	36.44%
140	46.03	36.24%	46.62	38.21%	63.53	42.69%	70.73	43.60%
130	41.49	42.53%	41.67	44.78%	55.65	49.80%	61.80	50.72%
120	36.32	49.69%	36.14	52.10%	47.34	57.30%	51.86	58.65%
110	31.52	56.34%	31.11	58.76%	39.90	64.01%	42.90	65.79%
101	26.95	62.67%	26.41	65.00%	33.00	70.24%	34.52	72.47%

Note: Values are results of controlled experiments under laboratory conditions.

# Reference: TV Camport Auto Sense Operation

The Camport Auto Sense function is enabled when:

1. Installer Menu item 034 CAMPORT EN is set to 1 AND
2. Installer Menu item 040 AUTO CAMPORT is enabled (1).

**Selectable:** Can be accessed with INPUT key, direct access, etc.

**Auto Sense:** TV switches to this input when connector is inserted. The Camport (Side [AV IN 2] Video) has the highest priority and will override any commands including tuning to the Start Channel.

## CAMPORT (Side Video) Functionality Control

Item 034 CAMPORT EN	Item 040 AUTO CAMPORT	Side (AV IN 2) Video Operation
0	0	Disabled
0	1	Disabled
1	0	Selectable
1	1	Auto Sense

## Campport Operation (Stand-alone)

When Campport Auto Sense is enabled as above, the TV's source will switch to the Side (AV IN 2) Video Aux source whenever a plug is inserted into the AV IN 2 Video input.

When the plug is removed, the TV will switch back to the previous channel or input source that was being displayed before the plug was inserted. However, if any direct access to an RF channel or Aux channel is requested while the Campport is active, then, when the video plug is removed, the TV will switch to the last requested channel. Source changes using any Source keys (INPUT) are ignored. Channel Up/Down and Flashback commands are not direct access tuning commands, and they are also ignored.

Previous State Before Inserting CAMPORT	Operation While CAMPORT is Active	State Upon Removal of CAMPORT
Aux or RF Channel	None	Previous Aux or RF Channel
Aux or RF Channel	Direct Access	Last Requested Aux or RF Channel
Aux or RF Channel	Ch Up/Down, Flashback, and Input Keys	Previous Aux or RF Channel

## Campport Operation (FTG or PPV)

The operation will be similar to that of the Stand-alone Mode. However, when the Channel Map is maintained external to the PTC (i.e., FTG and PPV), Channel Up/Down or Flashback keys are sent as Direct Access tuning commands to the PTC/TV.

Previous State Before Inserting CAMPORT	Operation While CAMPORT is Active	State Upon Removal of CAMPORT
Aux or RF Channel	None	Previous Aux or RF Channel
Aux or RF Channel	Direct Access	Last Requested Aux or RF Channel
Aux or RF Channel	Ch Up/Down, Flashback, and Input Keys	Last Requested Aux or RF Channel

# Reference: TV Aux Input Configuration

DIRECT ACCESS Tuning		TV		ENABLE				MPI DATA			START AUX SOURCE ASSIGNMENT
				Installer Menu		MPI DATA STATUS TYPE 0x41 SOURCES ENABLED (R/W)		DATA STATUS TYPE 0xD2 CURRENT AV SOURCE (R)		DATA STATUS TYPE 0x0D AUX SOURCE (R)	
OLD_OCV = 0	OLD_OCV = 1	Source Input	Source Mode	Number	Labeling	Value	Labeling	Value	Labeling		
130	90	Video2 (Side)	CV	34	CAMPORT_EN	0x01	Video Front (Camport)	0	Video Front (Camport)	0 (VIDEO)	2
131	91	Video1 (Rear)	CV	39	REAR_AUX_EN	0x02	Rear Video (Aux)	1	Rear Video (Aux)	0 (VIDEO)	1
132	92	HDMI2	DTV/PC	91	YPrPb2 EN = 1	0x04	S-Video Rear	2	S-Video Rear	0 (VIDEO)	5
133	93	HDMI1/DVI	DTV/PC	35	COMPPOINT_EN = 1	0x08	Front Computer	3	Front Computer	0 (VIDEO)	3
134	94	RGB	PC	87	REAR RGB EN = 2	0x10	SVGA Rear Computer	4	SVGA Rear Computer	2 (COMPUTER)	4
136	96	Component		38	YPrPb EN	0x40	Y/UV Component	6	Rear Y/PrPb Component Video	0 (VIDEO)	6

## Reference: *b*-LAN Setup & Overview

---

The *b*-LAN module is internal to the TV. It allows the hotel/institution head end equipment to communicate, via the institution's RF distribution system, with the TV for configuration and control.

**Note:** MPI cards with *b*-LAN technology—LMT7Z5, LMT7Z7, LMT7Z9—are NOT supported on TVs in which the *b*-LAN module is embedded.

Power to the *b*-LAN module is controlled by Installer Menu item 118 POWER SAVINGS. The default value is 003—the *b*-LAN module is only powered when the TV is turned ON. See chart below.

POWER SAVINGS	TV Standby State	TV Power On State
	<i>b</i> -LAN Power	<i>b</i> -LAN Power
001	On	On
003 (default)	Off	On
007	Off	Off

The control device at the head end, for example, an LG FMA-LG101, can control multiple TVs. When the TV is first installed, it must be turned ON in order for the head end to be able to communicate with the *b*-LAN. At this point, if it is desired for the *b*-LAN to always be powered, including while the TV is in Standby, set Installer Menu item 118 POWER SAVINGS to 001.

If the embedded *b*-LAN will not be used, enable maximum power savings in both Standby and TV Power On Mode by setting Installer Menu item 118 POWER SAVINGS to 007.

## Reference: RJP Model List and Input Auto-sensing Hierarchy

---

### RJP Model List

<b>Legacy Models</b>	<b>Scaler Models</b>
RJP-101M	N/A
RJP-101ML	N/A
RJP-110F	RJP-210F
RJP-110FW	RJP-210FW
RJP-110W	RJP-210W
RJP-110WBR	RJP-210WBR
RJP-110S	RJP-210S
RJP-120G	RJP-220G
RJP-120T	RJP-220T
RJP-201B	RJP-301B
RJP-202B	RJP-302B

### RJP Input Auto-sensing Hierarchy

<b>Priority</b>	<b>Video</b>	<b>Audio</b>
1st (Highest)	Digital Video In	Audio In (3.5mm)
2nd	PC Video In	Audio In (L/R)
3rd	Video In	Digital Video In

### Some Quick and Easy Tips for Resolving Problems

Symptom	Possible Cause(s)	Possible Solution(s)
<b>Software Problems</b>		
Cannot direct enter channel number or “No Signal” appears.	Channel not included in channel lineup in TV controller.	After 2-5-5 + MENU, only channels included in TV controller will appear. If channel is available, it can be added to channel lineup. If it is not available, the “No Signal” message appears on the TV screen.
<b>Power</b>		
No power.	See troubleshooting flow chart on following page.	
<b>Display Panel Picture</b>		
No picture.	Display panel is turned off.	<ul style="list-style-type: none"> <li>• Turn TV ON.</li> <li>• Power failure?</li> </ul>
	Antenna/cable not connected.	Connect antenna/cable signal to TV.
	Connections incorrect.	Check connections on TV.
	MPI not connected.	If applicable, connect MPI cable to MPI device.
	Encrypted program.	Try another channel.
Wrong tuning band.	Adjust Installer Menu settings.	
<b>Erratic Operation</b>		
Installer Menu setup.	Wrong Installer Menu settings.	Adjust Installer Menu settings as required.
<b>Installer Remote</b>		
Remote doesn't work.	Remote not in TV Mode.	Use MODE key to select “TV”; puts remote into TV Mode.
	Not aimed at IR remote sensor.	Point remote at TV's IR receiver on TV.
	Remote too far from IR sensor.	Move remote closer to TV's IR receiver or darken room.
	MPI not connected.	If applicable, connect MPI cable to MPI device.
	IR path to TV's receiver obstructed.	Remove obstructions.
	Weak batteries.	Replace batteries.
	Wrong battery polarity.	Check that “+” and “-” match in battery compartment.
	Too much light in room.	Dim room light.
Wrong Installer Remote.	Requires compatible Installer Remote. Contact your LG dealer.	
<b>Picture Reception</b>		
Normal picture, poor or no sound.	Audio muted.	Press MUTE or use Volume Up key to increase sound level.
	Broadcast problem.	Try a different channel.

**Note:** For other problems not caused by the TV, refer to the other devices' operating guide(s).

# Troubleshooting (Cont.)

## Troubleshooting Flow Chart

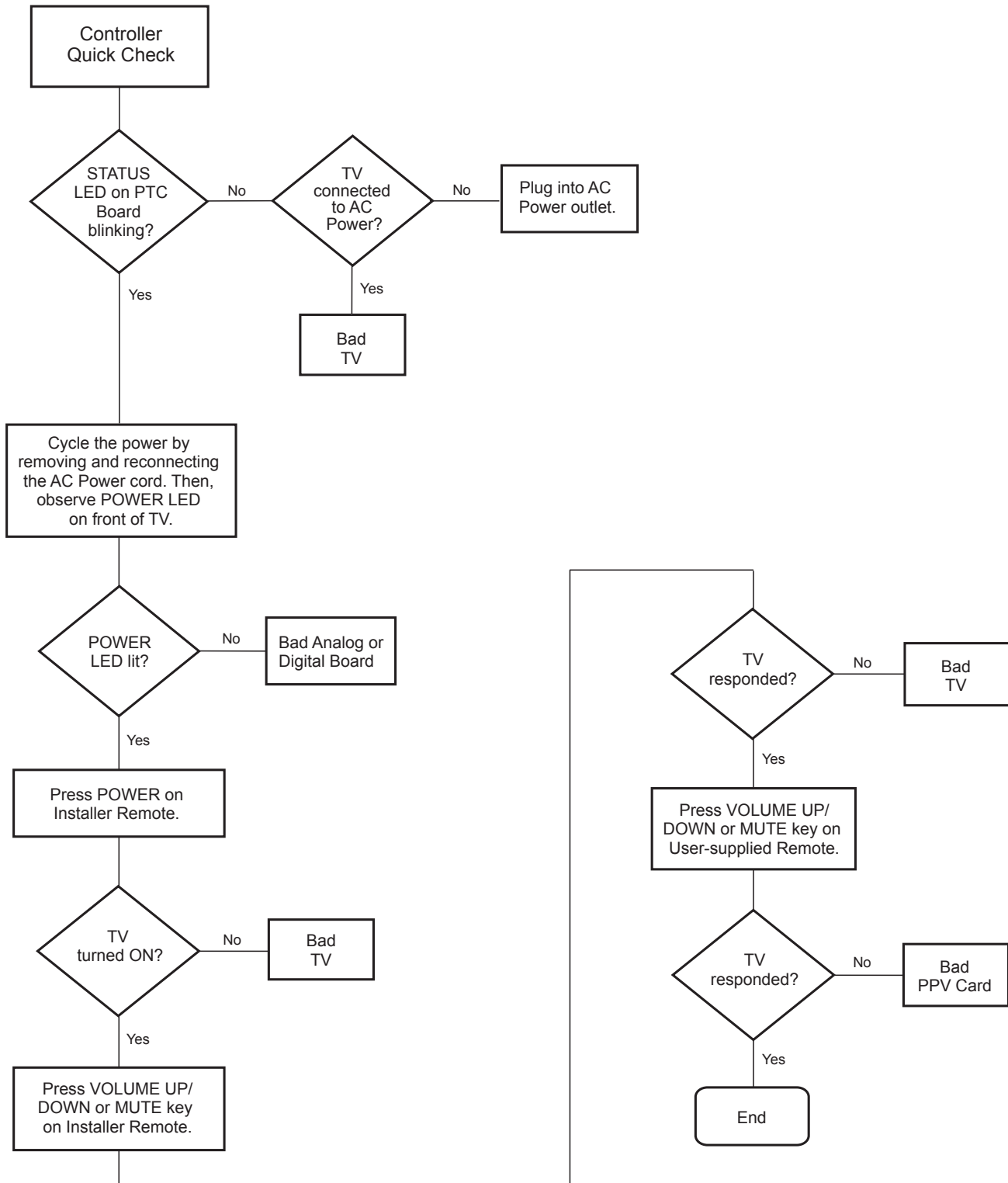

## Commercial Mode Check / FTG Operation Troubleshooting

### Commercial Mode Check

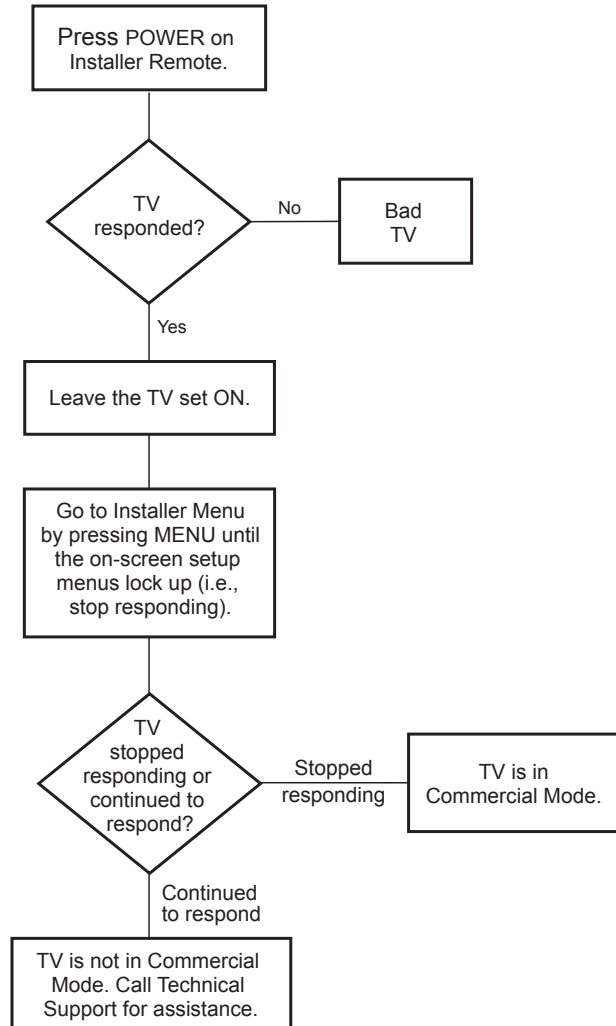

### FTG Operation Troubleshooting

The following table provides troubleshooting information for when the EBL is configured in the FTG Mode of operation.

Symptom	Possible Cause(s)	Solution(s)
Communication Error ("Communications Timeout")	Cable(s) not connected.	Check and connect communication cables.
	TV not powered.	Check/connect the TV power cord.
	TV not turned ON.	TV needs to be turned ON (default FTG Mode).
	Wrong COM (communication) port.	In the FTG Configuration Application, select the correct COM port for the cable being used.



# Troubleshooting (Cont.)

## Clone Programmer Troubleshooting



**Warning: Do not connect a clone programmer to a PPV card installed in the Master or Target TVs. Also, if the TV is in LodgeNet PPV Mode (check with the site administrator if you are not certain), do not connect a clone programmer to the GAME CONTROL/ MPI port. Either of these actions will damage the clone programmer and, if applicable, the PPV card.**

### Reset Clone Programmer After Static Shock

After replacing exhausted batteries (LT2002 only), or if the clone programmer behaves strangely after a static shock:

- TLL-1100A: Turn the TLL-1100A OFF and then ON.
- LT2002: Use a paper clip or similar instrument inserted through the small hole marked RESET to activate the internal reset switch and restore normal operation.

After a reset, check the real-time clock setting. It may be necessary to set the clone programmer clock from a TV containing the correct time.

### Notes

- The TLL-1100A and LT2002 clone programmers are designed to be used with TVs containing the 221-01006 and later processors. Use with earlier TVs may give unpredictable results. Processors used before the 221-01006-04 have a limited screen display capability; they cannot display entire screens as shown in the setup instructions accompanying the clone programmer. Use the printed menu illustrations in the documentation as an aid to making your programming choices.
- For both Master and Target TVs—The TV EBL must be in Pass-through Mode for cloning purposes. See also IMPORTANT CLONING INFORMATION on page 27.

Symptom	Possible Cause(s)	Possible Solution(s)
<b>Clone Programmer</b>		
Clone copies setup in less than 30 seconds.	Not enough time to copy entire TV setup.	TLL-1100A: Turn the TLL-1100A Off and then ON. LT2002: Press RESET on clone programmer. Then redo Learn/Teach. (Learning usually takes about 90 seconds; Teaching usually takes 3 to 4 minutes.)
Remote does not operate clone programmer.	Wrong Installer Remote.	Only use an LG Installer Remote to operate clone programmer with TV.
Clone menu does not display on TV screen, TLL-1100A shows error message, or LT2002 LED does not blink.	MPI cord not connected. TV not turned ON. (LT2002 only) Weak batteries. (TLL-1100A only) No charge.	Connect MPI cord properly, and ensure good connection. TV must be powered ON for clone programmer to work. Install four (4) fresh AA high-quality alkaline batteries. Ensure the TLL-1100A is fully charged or connected to AC power.
Clone menu hard to read.	Weak signal.	Connect TV to a reliable analog channel signal source.
No time set.	Time not available.	Set time on a TV, and copy time to clone programmer.
Clone not working.	Clone programmer problem.	<ul style="list-style-type: none"> <li>• Try a different clone programmer.</li> <li>• Reset the clone programmer.</li> </ul>
Clone scans channels more than once.	Clone should only scan channels once.	Ensure TV is set up correctly, and try cloning again.

### Master and Target TVs

Cloning did not work.	Procedure interrupted.	Wait until procedure complete message is displayed.
	Different TV models. Step(s) omitted or not performed.	Cloning is only possible with identical model TVs. Refer to the applicable cloning procedure(s), and make sure all tasks were performed.
(LT2002 only) Clone time disappeared.	Batteries were removed.	Batteries must remain installed to retain time settings.
New setup not present.	Target TV not reset.	Disconnect Target TV from AC power for fifteen (15) seconds.

- After cloning operations are complete, unplug the TLL-1100A/LT2002 from the TV.
- If the TV does not display a picture (blank screen) after a few seconds, just change channels.

A list of definitions for some of the words found in this guide.

## **75 OHM RF CABLE**

The wire that comes from an off-air antenna or cable service provider. The end looks like a hex-shaped nut with a wire through the middle. It screws onto the Antenna/Cable threaded jack on the back of the TV.

## **300 TO 75 OHM ADAPTER**

A small device that connects a 2-wire 300 ohm antenna to a 75 ohm RF jack. It is usually about an inch long with two screws on one end and a round opening with a wire extending out the other end.

## **A/V CABLES**

Audio/Video cables. Three cables bunched together—right audio (red), left audio (white), and video (yellow). A/V cables are used for stereo playback of videocassettes and for higher quality picture and sound from other A/V devices.

## **A/V DEVICE**

Any device that produces video or sound (VCR, DVD, cable box, or television).

## **AMPLIFIER**

An electronic device that amplifies sound from a television, CD player, VCR, DVD player, or other Audio/Video device.

## **ANTENNA**

The physical receiver of television signals sent over the air. A large metal piece of equipment does not always have to be visible to be using an antenna.

## **b-LAN**

Licensed proprietary RF communication system used to configure/control TV via RF distribution system.

## **CABLE**

Cable service box. Refers to the descrambler box cable subscribers use to receive cable programming signals.

## **CATV**

Programming provided by a cable service.

## **COMPONENT VIDEO**

Uses three wires for transporting three-color video signals. The end result is usually better video quality.

## **COMPOSITE VIDEO**

Typical video jack, uses one wire for transporting three-color video signals.

## **DELETE**

Lets you remove channels from the list that the end user can scroll through using Channel Up/Down.

## **DIGITAL TELEVISION**

High-resolution, cinema-quality television signals transmitted digitally.

## **DVI**

Digital Video Interface. Accommodates analog and digital interfaces with a single connector.

## **HDMI**

High-definition multi-media interface.

## **HDSTB**

High-definition set top box. Refers to a tuner device that receives high-definition television signals which have higher resolution than ordinary analog TV signals.

## **HDTV**

High-definition television. Refers to television signals that have higher resolution than ordinary analog TV signals.

## **INPUT**

Refers to the input jack that receives a signal from a TV, VCR, DVD Player or other Audio/Video device.

## **JACK**

An input or output connector on the back of a TV, VCR, DVD Player or other Audio/Video device.

## **MONO SOUND**

Mono (monaural) sound is one channel of sound. On more than one speaker, all the speakers play the same audio.

## **OUTPUT**

Refers to the output jack that sends a signal out of a VCR, DVD, or other A/V device.

## **PHYSICAL CHANNEL NUMBER**

The actual channel number. Analog channels use the Physical Channel number and digital channels can use a Virtual Channel number.

## **RGB (RED, GREEN, BLUE)**

Connection input or output port available for producing a video image using three separate colors: Red, Green, and Blue.

## **RS-232**

Serial communication port through which firmware is downloaded.

## **2ND AUDIO PROGRAMMING/SAP**

Second Audio Programming (SAP) is another, separate audio channel available with some programming. Choosing SAP often refers to listening to audio in another language, such as Spanish or French.

## **SIGNAL**

Picture and sound traveling through a cable, or over the air, to the TV.

## **STEREO SOUND**

Stereo (Stereophonic) sound refers to audio that's divided into right and left sides.

## **TUNER**

Device that picks up the broadcast signal and turns it into picture and sound.

## **VIRTUAL CHANNEL NUMBER**

A re-mapped channel number. Analog channels use the Physical Channel number; however digital channels use a Virtual (or false) Channel number.

## **XDS**

Extended Data Service. Additional program information included on the signal provided at the discretion of the broadcaster.

Note: Refer to [www.atsc.org](http://www.atsc.org) for further information.

# Document Revision History / Notes

---

## Document Revision History

<b>Date</b>	<b>Description</b>
December 2010	Revision A: New Document
January 2011	Revision B: Includes LD325H TVs

Product documentation is available online at: [www.LGolutions.com/products](http://www.LGolutions.com/products). From the Products page, select **TVs, Systems & Solutions**, then **LCD TVs**, then the applicable TV. Click the **Literature & Downloads** tab at the bottom of the TV page, and select the required document(s) from the Downloads list.

---

## Notes



---

For Customer Support/Service, please call:

**1-888-865-3026**

[www.LGsolutions.com](http://www.LGsolutions.com)

Pro:Idiom is a registered trademark of Zenith Electronics LLC. Pro:Centric is a trademark of LG Electronics U.S.A., Inc. *b*-LAN is a trademark of LodgeNet Interactive Corporation. All other trademarks or registered trademarks are the property of their respective owners.



**32LD310H**  
**37LD310H**

## **Lodging Guest Interactive Pro:Centric™ TVs**

---

# **Commercial Mode Setup Guide**

Note: Selected features shown in this guide may not be available on all models.

### **EXPERIENCED INSTALLER**

Commercial Mode Setup  
pages 12–13

Cloning Information  
pages 23–28

FTG Mode of Operation  
pages 29–36

For Customer Support/Service, please call:  
**1-888-865-3026**

The latest product information and documentation is available online at:  
**www.LG solutions.com/products**

MODEL and SERIAL NUMBER  
The model and serial numbers of this TV are located on the back of the cabinet. For future reference, LG suggests that you record those numbers here:

Model No. \_\_\_\_\_ Serial No. \_\_\_\_\_



**WARNING:**

TO REDUCE THE RISK OF ELECTRIC SHOCK DO NOT REMOVE COVER (OR BACK). NO USER-SERVICEABLE PARTS INSIDE. REFER TO QUALIFIED SERVICE PERSONNEL.



The lightning flash with arrowhead symbol, within an equilateral triangle, is intended to alert the user to the presence of uninsulated “dangerous voltage” within the product’s enclosure that may be of sufficient magnitude to constitute a risk of electric shock to persons.



The exclamation point within an equilateral triangle is intended to alert the user to the presence of important operating and maintenance (servicing) instructions in the literature accompanying the appliance.

**WARNING:**

TO PREVENT FIRE OR SHOCK HAZARDS, DO NOT EXPOSE THIS PRODUCT TO RAIN OR MOISTURE.

**POWER CORD POLARIZATION:**

This product is equipped with a 3-wire grounding-type alternating current power plug. This plug will fit into the power outlet only one way. This is a safety feature. If you are unable to insert the plug fully into the outlet, contact your electrician to replace your obsolete outlet. Do not defeat the safety purpose of the 3-wire grounding-type plug.

**NOTE TO CABLE/TV INSTALLER:**

This reminder is provided to call the cable TV system installer’s attention to Article 820-40 of the National Electric Code (U.S.A.). The code provides guidelines for proper grounding and, in particular, specifies that the cable ground shall be connected to the grounding system of the building, as close to the point of the cable entry as practical.

**REGULATORY INFORMATION:**

This equipment has been tested and found to comply with the limits for a Class B digital device, pursuant to Part 15 of the FCC Rules. These limits are designed to provide reasonable protection against harmful interference when the equipment is operated in a residential installation. This equipment generates, uses and can radiate radio frequency energy and, if not installed and used in accordance with the instruction manual, may cause harmful interference to radio communications. However, there is no guarantee that interference will not occur in a particular installation. If this equipment does cause harmful interference to radio or television reception, which can be determined by turning the equipment off and on, the user is encouraged to try to correct the interference by one or more of the following measures:

- Reorient or relocate the receiving antenna.
- Increase the separation between the equipment and receiver.
- Connect the equipment to an outlet on a circuit different from that to which the receiver is connected.
- Consult the dealer or an experienced radio/TV technician for help.

**CAUTION:**

Do not attempt to modify this product in any way without written authorization from LG Electronics U.S.A., Inc. Unauthorized modification could void the user’s authority to operate this product.

**COMPLIANCE:**

The responsible party for this product’s compliance is: LG Electronics U.S.A., Inc.  
1000 Sylvan Avenue, Englewood Cliffs, NJ 07632, USA • Phone: 1-201-816-2000

Marketed and Distributed in the United States by LG Electronics U.S.A., Inc.  
1000 Sylvan Avenue, Englewood Cliffs, NJ 07632

# IMPORTANT SAFETY INSTRUCTIONS

1. Read these instructions.
2. Keep these instructions.
3. Heed all warnings.
4. Follow all instructions.
5. Do not use this apparatus near water.
6. Clean only with dry cloth.
7. Do not block any ventilation openings. Install in accordance with the manufacturer's instructions.
8. Do not install near any heat sources, such as radiators, heat registers, stoves, or other apparatus (including amplifiers) that produce heat.
9. Do not defeat the safety purpose of the polarized or grounding-type plug. A polarized plug has two blades with one wider than the other. A grounding-type plug has two blades and a third grounding prong. The wide blade or the third prong are provided for your safety. If the provided plug does not fit into your outlet, consult an electrician for replacement of the obsolete outlet.
10. Protect the power cord from being walked on or pinched, particularly at plugs, convenience receptacles, and the point where it exits from the apparatus.
11. Only use attachments/accessories specified by the manufacturer.
12. Use only with the cart, stand, tripod, bracket, or table specified by the manufacturer or sold with the apparatus. When a cart is used, use caution when moving the cart/apparatus combination in order to avoid injury from tip-over.



13. Refer all servicing to qualified service personnel. Servicing is required when the apparatus has been damaged in any way, such as power-supply cord or plug is damaged, liquid has been spilled or objects have fallen into the apparatus, the apparatus has been exposed to rain or moisture, does not operate normally, or has been dropped.
14. Never touch this apparatus or antenna during a thunder or lightning storm.
15. When mounting a TV on the wall, make sure not to install the TV by the hanging power and signal cables on the back of the TV.
16. Do not allow an impact shock or any objects to fall into the product, and do not drop objects onto the screen.

## 17. Power Cord

**Caution: It is recommended that appliances be placed upon a dedicated circuit; that is, a single outlet circuit which powers only that appliance and has no additional outlets or branch circuits. Check the specification page of the Owner's Manual to be certain.**

Periodically examine the cord of your appliance, and if its appearance indicates damage or deterioration, unplug it, discontinue use of the appliance, and have the cord replaced with an exact replacement part by an authorized servicer. Protect the power cord from physical or mechanical abuse, such as twisting, kinking, or pinching or being closed in a door or walked upon. Pay particular attention to plugs, wall outlets, and the point where the cord exits the appliance.

Do not use a damaged or loose power cord. Be sure to grasp the plug when unplugging the power cord. Do not pull on the power cord to unplug the TV.

## 18. Overloading

Do not connect too many appliances to the same AC power outlet as this could result in fire or electric shock. Do not overload wall outlets. Overloaded wall outlets, loose or damaged wall outlets, extension cords, frayed power cords, or damaged or cracked wire insulation are dangerous. Any of these conditions could result in fire or electric shock.

## 19. Outdoor Use/Wet Location



**Warning: To reduce the risk of fire or electrical shock, do not expose this product to rain, moisture or other liquids.**

Do not touch the TV with wet hands. Do not install this product near flammable objects such as gasoline or candles or expose the TV to direct air conditioning.

Do not expose to dripping or splashing and do not place objects filled with liquids, such as vases, cups, etc., on or over the apparatus (e.g., on shelves above the unit).

## 20. Grounding

Ensure that you connect the earth ground wire to prevent possible electric shock (i.e., a TV with a three-prong grounded AC plug must be connected to a three-prong grounded AC outlet). If grounding methods are not possible, have a qualified electrician install a separate circuit breaker. Do not try to ground the unit by connecting it to telephone wires, lightning rods, or gas pipes.

## 21. Disconnect Device

The mains plug is the disconnecting device. The plug must remain readily operable.

As long as this unit is connected to the AC wall outlet, it is not disconnected from the AC power source even if you turn off this unit by SWITCH.

(Continued on next page)

# IMPORTANT SAFETY INSTRUCTIONS

(Continued from previous page)

## 22. Outdoor Antenna Grounding

If an outside antenna or cable system is connected to the product, follow the precautions below.

An outdoor antenna system should not be located in the vicinity of overhead power lines or other electric light or power circuits or where it can come into contact with such power lines or circuits as death or serious injury can occur.

Be sure the antenna system is grounded so as to provide some protection against voltage surges and built-up static charges.

Article 810 of the National Electrical Code (NEC) in the U.S.A. provides information with respect to proper grounding of the mast and supporting structure, grounding of the lead-in wire to an antenna-discharge unit, size of grounding conductors, location of antenna-discharge unit, connection to grounding electrodes, and requirements for the grounding electrode.

### Antenna Grounding According to NEC, ANSI/NFPA 70

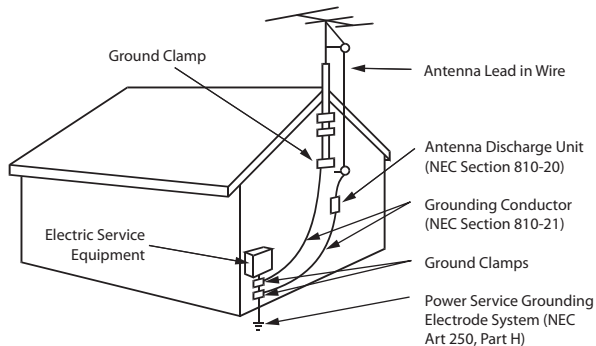

## 23. Cleaning

When cleaning, unplug the power cord and rub gently with a soft cloth to prevent scratching. Do not spray water or other liquids directly on the TV as electric shock may occur. Do not clean with chemicals such as alcohol, thinners or benzene.

## 24. Transporting Product

Make sure the product is turned Off and unplugged and that all cables have been removed. It may take two or more people to carry larger TVs. Do not press against or put stress on the front panel of the TV.

## 25. Ventilation

Install the TV where there is proper ventilation. Do not install in a confined space such as a bookcase. Do not cover the product with cloth or other materials (e.g., plastic) while it is plugged in. Do not install in excessively dusty places.

26. Do not touch the ventilation openings, as they may become hot while the TV is operating.

27. If you smell smoke or other odors coming from the TV or hear strange sounds, unplug the power cord, and contact an authorized service center.

28. Do not press strongly on the panel with a hand or sharp object (e.g., a nail, pencil, or pen) or make a scratch on it.

29. Keep the product away from direct sunlight.

## 30. Dot Defect

The Plasma or LCD panel is a high technology product with resolution of two million to six million pixels. In a very few cases, you could see fine dots on the screen while you're viewing the TV. Those dots are deactivated pixels and do not affect the performance and reliability of the TV.

## 31. Generated Sound

"Cracking": A cracking noise that occurs while the TV is On or when it is turned Off is generated by plastic thermal contraction due to temperature and humidity. This noise is common for products where thermal deformation is required.

Electrical circuit humming/panel buzzing: A low level noise is generated from a high-speed switching circuit, which supplies a large amount of current to operate a product. It varies depending on the product. This generated sound does not affect the performance and reliability of the product.

## 32. For LCD TV

If the TV feels cold to the touch, there may be a small "flicker" when it is turned On. This is normal; there is nothing wrong with TV. Some minute dot defects may be visible on the screen, appearing as tiny red, green, or blue spots. However, they have no adverse effect on the monitor's performance. Avoid touching the LCD screen or holding your finger(s) against it for long periods of time. Doing so may produce some temporary distortion effects on the screen.



# Table of Contents

---

Safety Warnings . . . . .	2	Teaching FMA Configuration to a TV . . . . .	31
Important Safety Instructions . . . . .	3–4	Learning an FMA Configuration File from a TV . . . . .	31
Table of Contents . . . . .	5	Optional Manual Configuration / Setup for a TV . . . . .	32
Setup Checklist / Commercial Mode Setup Overview . . . . .	6	FTG Channel Map Configuration Utility Overview . . . . .	33
Pro:Centric TV Interactive Menu Features . . . . .	7	FTG Channel Map Editor Overview . . . . .	34
LD310H Rear Jack Panel . . . . .	8	FTG Installer Menu Configuration Utility Overview . . . . .	35
Side Connections Panel / RF Antenna & MPI Connections . . . . .	9	FMA Configuration Utility Overview . . . . .	36
Installer Overview . . . . .	10	<b>References</b>	
Installer Remote Control Typical Key Functions . . . . .	11	Upgrading TV/PTC Software using a USB Memory Device . . . . .	37
<b>Commercial Mode Setup for Master TV</b> . . . . .	12–13	Downloading a Splash Screen using a USB Memory Device . . . . .	38
<b>Installer Menu</b> . . . . .	14–20	Power Consumption Settings . . . . .	39
TV Setup Menus Overview . . . . .	21	TV Camport Auto Sense Operation . . . . .	40
Adding Channel Icons / Custom Channel Labels (2-5-4 + MENU Mode) . . . . .	22	TV Aux Input Configuration . . . . .	41
<b>Cloning Overview / Clonable Menu Features</b> . . . . .	23	Troubleshooting . . . . .	42–45
<b>Cloning Procedures</b> . . . . .	24–28	General Troubleshooting . . . . .	42
Learning / Teaching a Master TV Setup using a USB Memory Device . . . . .	24	Troubleshooting Flow Chart . . . . .	43
Learning / Teaching a Master TV Setup using a TLL-1100A Clone Programmer . . . . .	25–26	Commercial Mode Check / FTG Operation Troubleshooting . . . . .	44
Learning / Teaching a Master TV Setup using an LT2002 Clone Programmer . . . . .	27–28	Clone Programmer Troubleshooting . . . . .	45
<b>FTG Mode of Operation</b> . . . . .	29–36	Glossary of Terms . . . . .	46
FTG Mode Overview / Determining the TV Operating Mode . . . . .	29	Document Revision History / Notes . . . . .	47
Creating an FMA Configuration File using the FTG Configuration Application . . . . .	30	Back Cover . . . . .	48

---

## Notes

- Installer Menu content is intended for use primarily by qualified TV electronics technicians.
- Refer to the Owner's Manual for additional information on TV features, specifications, maintenance, and safety instructions.
- For additional information, contact your LG representative.

For Customer Support/Service, please call:

**1-888-865-3026**

[www.LGolutions.com](http://www.LGolutions.com)

Note: Design and specifications subject to change without prior notice.

# Setup Checklist / Commercial Mode Setup Overview

---

## Setup Checklist

### Installation and Setup Checklist

- \_\_\_ Unpack TV and all accessories.
- \_\_\_ Install batteries in remote control.
- \_\_\_ Install TV on VESA mount or stand.
- \_\_\_ **Note:** It may be advisable to make all cable connections before installing on VESA mount or stand, as appropriate.

### Hardware Connections

- \_\_\_ Install any additional hardware as appropriate to your institution, LAN, etc.

### Cable Connections

- \_\_\_ Make all connections to rear jack panel and RF antenna on MPI/PPV card.
- \_\_\_ Make all connections to signal, interactive resources, and Aux sources, as appropriate.

### Commercial Mode Setup

- \_\_\_ Complete Commercial Mode Setup (configure all relevant Installer Menu items as required of your institution and configure display features for the end user).

### Software Installation

- \_\_\_ Install or configure any software, as applicable, for example, PPV, etc.

---

## Commercial Mode Setup Overview

This document describes how to set up LD310H Pro:Centric™ TVs for Commercial Mode either while in Pass-through Mode or Free-To-Guest (FTG) Mode.

### Pass-through Mode

This mode allows you to configure a Master TV Setup for cloning purposes as well as external VOD/PPV control. Use the Installer Remote to configure Installer Menu items as required for TV operation and set up TV features (Channel, Picture, Audio, etc.). See pages 12 to 13 for detailed information.

### FTG Mode

This mode enables Pro:Idiom® decryption and also allows logical channel mapping of physical channels to remove the need for dash tuning. FTG Configuration Application software is used to configure and/or edit FTG Channel Map and FTG Installer Menu settings. See pages 29 to 36 for basic information on FTG Mode and using a PC with the FTG Configuration Application to create an FMA Configuration file. Refer to the **Free-To-Guest (FTG) Configuration Application** manual for further details.

# Pro:Centric TV Interactive Menu Features

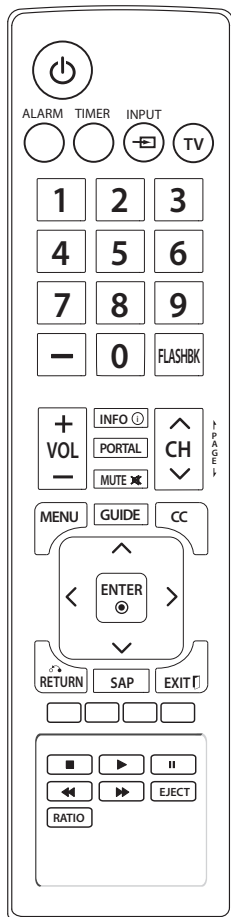
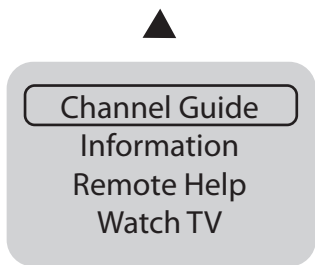

**Important: Pro:Centric operation requires that Installer Menu items 098 PRO:CENTRIC and 119 DATA CHANNEL be set appropriately and that the TV be in PPV or FTG Mode.**

The interactive Pro:Centric TV enables guests—from the comfort of their hotel rooms—to view and select from a complete listing of hotel services and amenities. The Pro:Centric TV is connected to the hotel's billing computer, and service/amenities charges are billed at the time of order.

Interactive amenities may include:

- Hotel information, news, and events
- Directory services (tourist attractions, restaurants, etc.)
- Reservation services (business meetings, fitness, spa, etc.)
- Weather and traffic information
- Shopping services (delivery to guest room)
- Room service (menu ordering, memo service, morning wake up call, laundry, etc.)
- Ticketing services
- Check-out service (in the guest room)
- Gaming services
- E-mail resources/account access

Use the Installer Remote to operate both interactive menus and regular TV features. Press **PORTAL** on the Installer Remote to access the interactive menus.

**Note:** Interactive menu options may vary, depending on Pro:Centric features enabled for the site. The following are default interactive menus.

## Channel Guide

Shows available TV networks and channels. When available, Electronic Program Guide (EPG) data indicates the channel and the program start and finish times.

## Information

Typically displays hotel information, for example, photos of guest rooms, dining rooms, business centers, fitness and pool facilities, etc. Information may also include resources, such as local school programs, run in cooperation with the hotel.

## Remote Help

Provides help for navigating the interactive menus.

## Watch TV

Removes the interactive menu from the screen and returns to the previously tuned TV channel.

# LD310H Rear Jack Panel

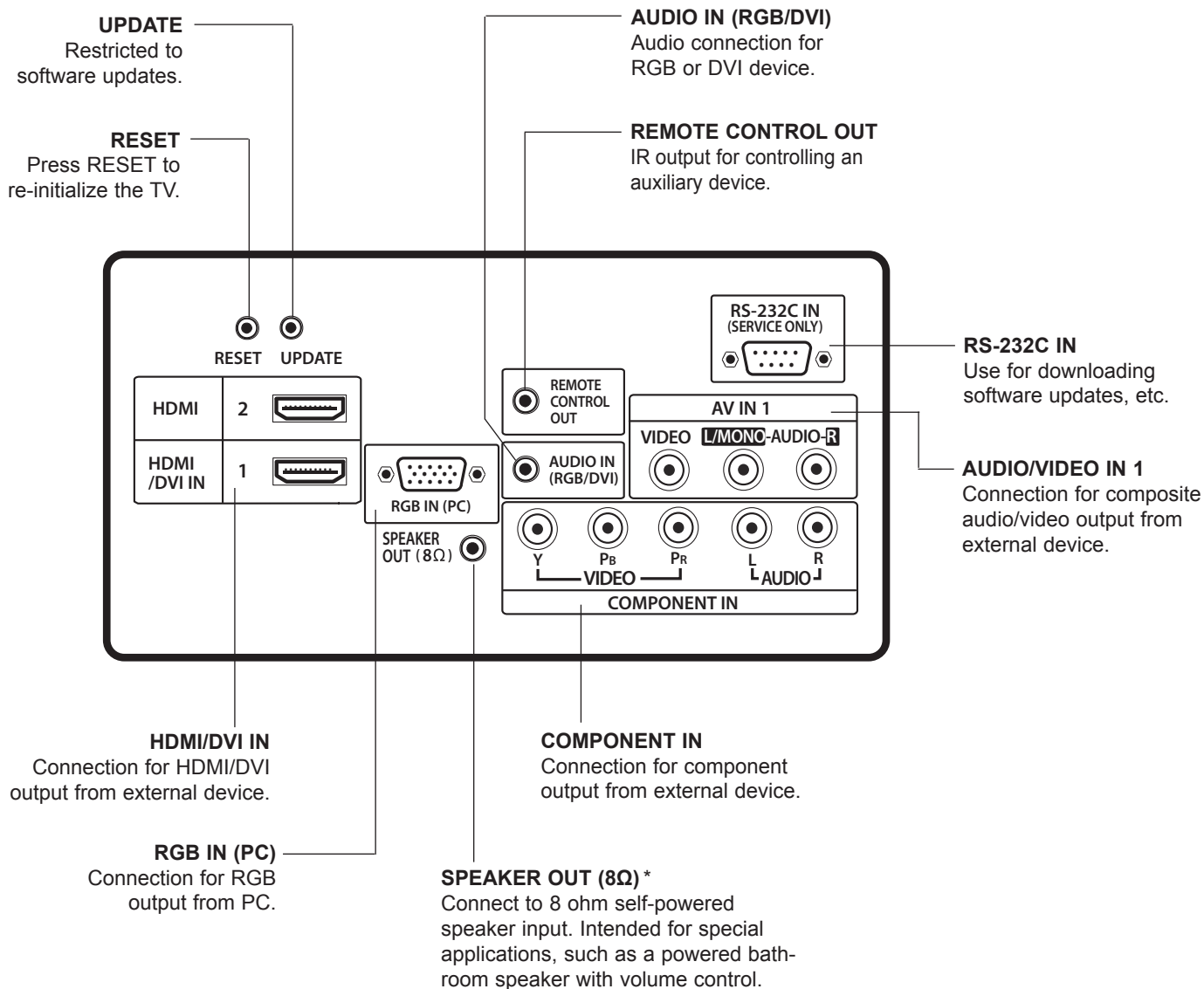

\* This stereo jack provides a mono speaker fixed-level, 1 watt output (audio +, audio -, w/ground shield). Do NOT plug in a mono connector, as this may damage the TV.

# Side Connections Panel / RF Antenna & MPI Connections

## Side Connections Panel

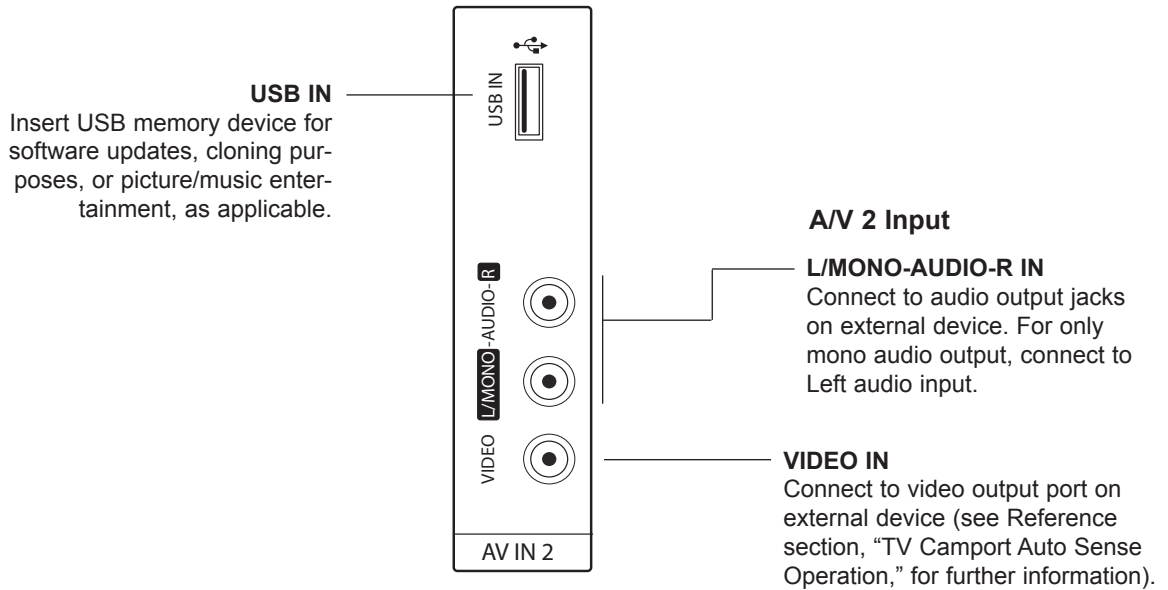

## RF Antenna & MPI Connections

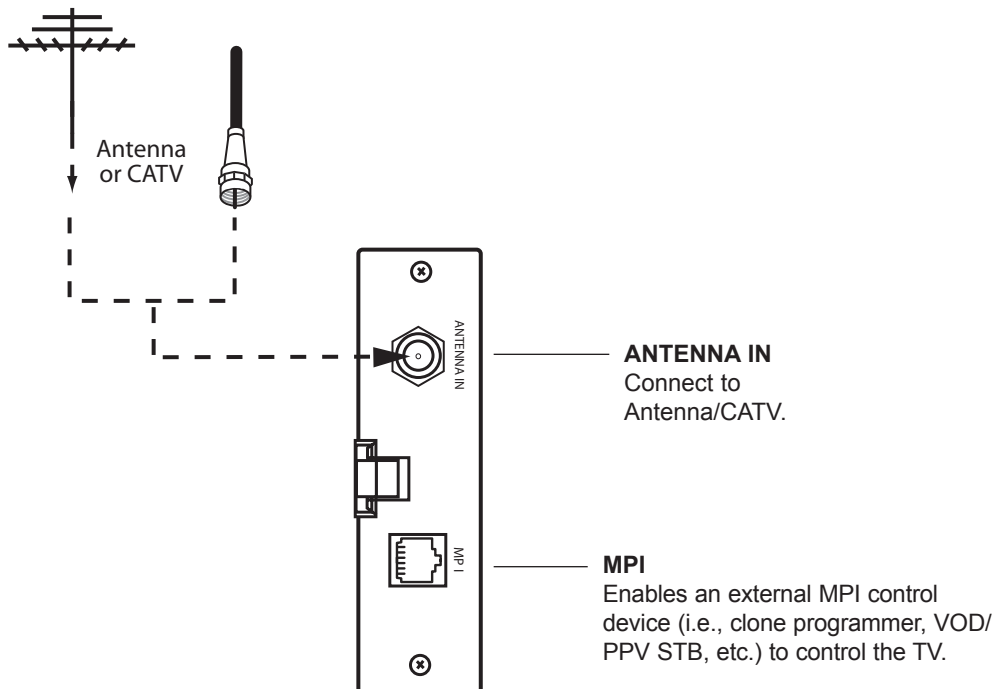

# Installer Overview

This is the Commercial Mode Setup Guide only.

## Installer Menu / Commercial Mode Setup

To set up a Master TV for cloning purposes, you will need to know how to enter the TV Installer Menu and make changes to the default values as required. Similarly, to configure a TV's Installer Menu settings in FTG Mode, you will need to know how to access and use the FTG Configuration Application utilities. If necessary, familiarize yourself with the Installer Menu and how to make and save changes. Refer to page 14 for information on accessing the Installer Menu in Pass-through Mode. Pages 15 to 20 describe Installer Menu items in detail. Refer to pages 29 to 36 for information on entering FTG Mode and using the FTG Configuration Application utilities.

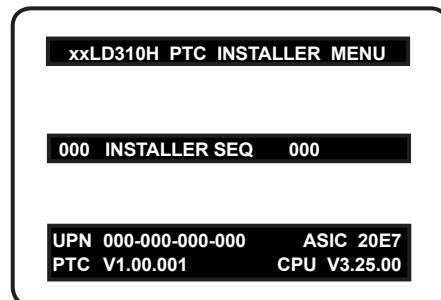

Typical Installer Menu

## Installer Remote

The LG Installer Remote is supplied with and dedicated to operate the TV. See next page for typical key functions in TV operating mode. Some DVD and VCR controls may be available for selected LG DVD/VCR products.

## Cloning

Cloning refers to the process of capturing a Master TV Setup and transferring it to a Target TV. The Master TV's clonable features need to be configured as part of the Commercial Mode Setup. This is a critical step. If the Master TV's clonable features—channel icons or labels, digital font options, etc.—are not set up correctly, the cloned TVs will all have problems. Pages 23 to 28 provide detailed information on cloning requirements and procedures.

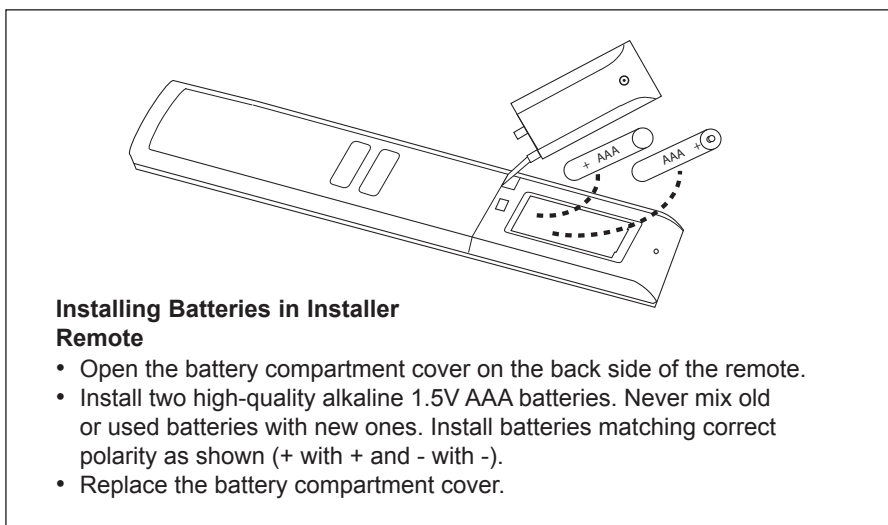
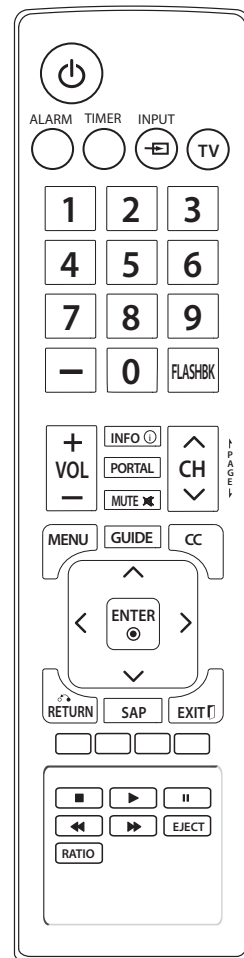

### Installing Batteries in Installer Remote

- Open the battery compartment cover on the back side of the remote.
- Install two high-quality alkaline 1.5V AAA batteries. Never mix old or used batteries with new ones. Install batteries matching correct polarity as shown (+ with + and - with -).
- Replace the battery compartment cover.

# Installer Remote Control Typical Key Functions

The LG Installer Remote illustrated below and throughout this document shows typical remote control functions and is provided for reference only. This Installer Remote may vary from the Installer Remote supplied with the TV.

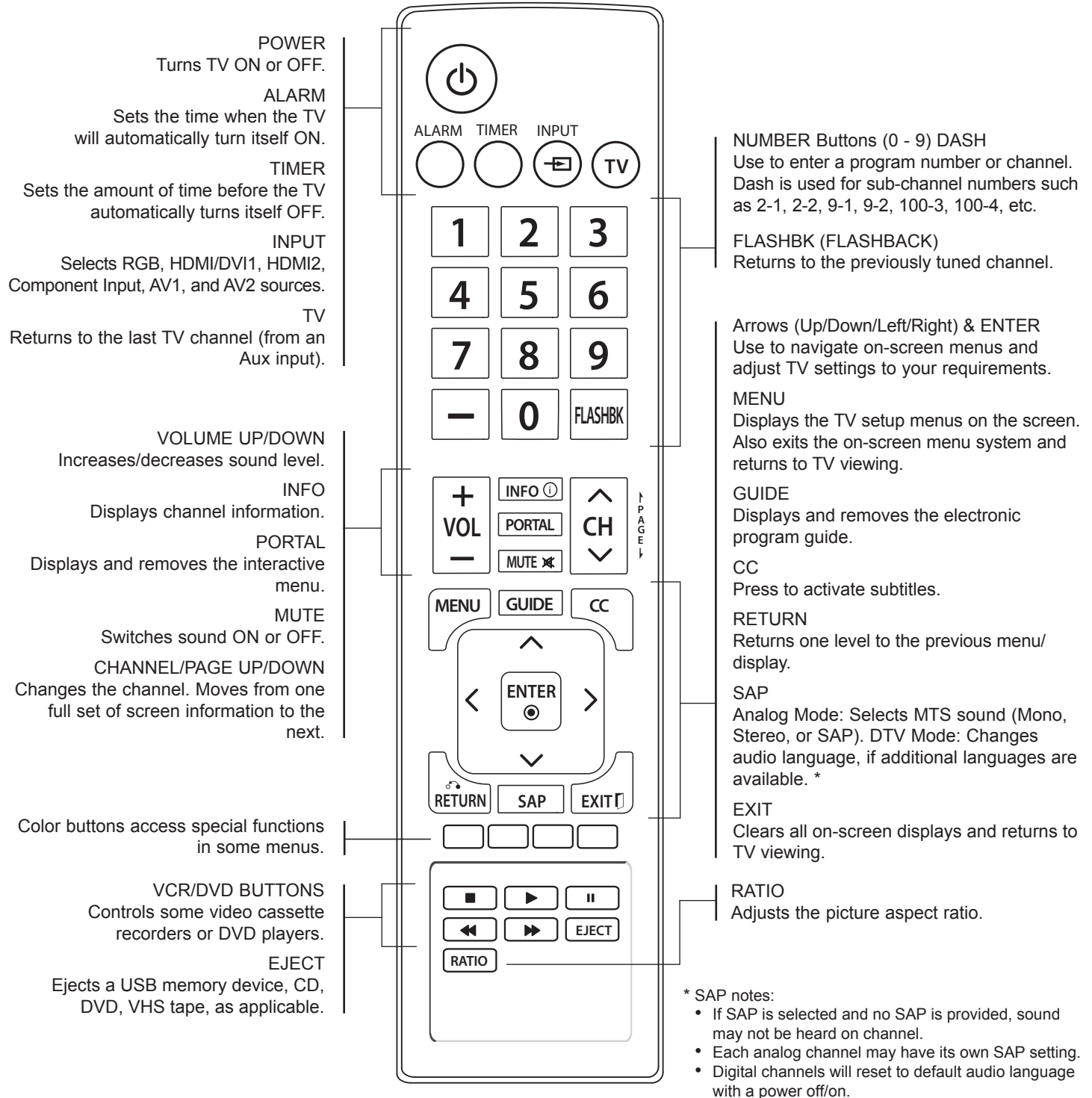

# Commercial Mode Setup for Master TV

This section describes how to set up a Master TV for cloning purposes when the TV is in Pass-through Mode.

**Note:** Disconnect all Aux inputs. Under certain conditions, Auto Tuning (Channel Search) is disabled if there is an Aux input active.

**Note:** Refer to “FTG Mode of Operation” on pages 29 to 36 for information on entering FTG Mode and configuring/editing FTG Channel Map and Installer Menu settings using the FTG Configuration Application.

## 1. Set Installer Menu items.

This step provides specific instruction only on the Installer Menu items that should be set on a Master TV. Refer to pages 14 to 20 for detailed information on all Installer Menu items.

- a) Make sure the TV is ON. Then, use the Installer Remote to enter the TV Installer Menu: Press **MENU** repeatedly until the on-screen setup menus lock up, and then press **9-8-7-6 + ENTER**.
- b) Set Installer Menu item **117 FACT DEFAULT** to **001** and press **ENTER** on the Installer Remote.

This clears all Installer Menu custom settings, the channel lineup, etc. and reloads the factory default settings. The value will change back to 0 after the internal TV controller (Protocol Translator Card [PTC]) has been restored to factory default condition. This step ensures that the TV Channel Memory will be the active channel lineup.

- c) Set Installer Menu item **003 BAND/AFC**, as appropriate.
  - Broadcast: Set to 000.      • HRC: Set to 002.
  - CATV: Set to 001 (default).      • IRC: Set to 003.
- d) Set any other Installer Menu items that affect your TV programming network to the required configuration. For example, enable/disable Aux sources, set a Start Channel, etc.
- e) After you have adjusted all required Installer Menu item settings, press **ENTER** once on the Installer Remote to save your changes; then, press **ENTER** again to exit the menu.

## 2. Set up TV features.

On-screen setup menus control the features of the TV (see page 21). Press **MENU** on the Installer Remote to access the setup menus, and then set Channel, Picture, Audio, Lock, Time, etc. options to the desired configurations. See also the Clonable Menu Features list on page 23.

**Note:** If desired, you can run Auto Tuning (see step 3) prior to completing this step.

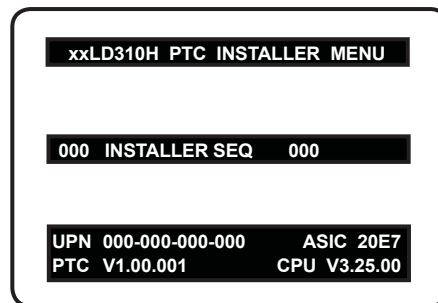

Typical TV Installer Menu

Note: The Installer Menu header will vary depending on the TV you are setting up.

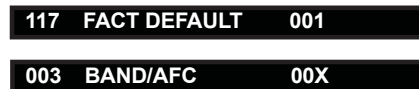

Adjust the settings for these Installer Menu items.

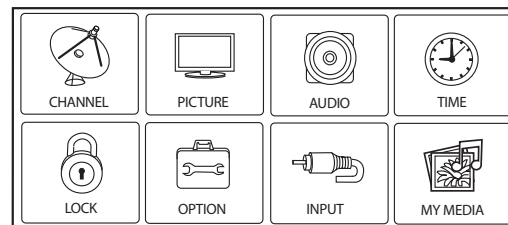

Set the TV features to the desired configuration for the end user.

(Continued on next page)



# Commercial Mode Setup for Master TV (Cont.)

(Continued from previous page)

### 3. Run Auto Tuning (Channel Search).

- a) Search for all available analog and digital channels: Go to the Channel Menu, select the **Auto Tuning** option, and follow the on-screen instructions.
- b) Use the **Channel Edit** option in the Channel Menu to edit the channel lineup, as necessary, to include free to guest channels only.
  - Add/delete channels per your system requirements. Note that physical channel numbers are used to identify virtual channels. Also, channel numbers cannot be higher than 255.
  - Use the **Channel Label** option in the Channel Menu to add familiar channel trademarks/logos such as ABC, CBS, NBC, etc. to the Channel-Time on-screen display. Identifiable labels (logos) should enable the end user to readily know what common networks are available. (You can add the channel labels in this step, or you can add channel labels or logos for channels without icons in step 5.)

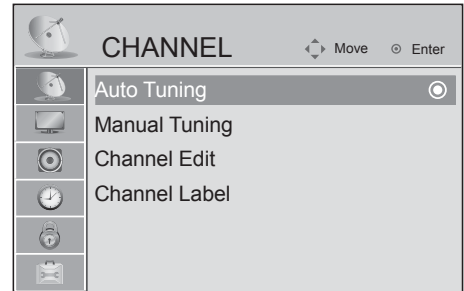

Run Auto Tuning, edit channels, and select familiar channel trademarks/logos using Channel Menu options.

### 4. Transfer the TV Setup to the internal TV Controller (PTC): 2-5-5 + MENU Mode

After the TV channel lineup has been edited and channel label icons added, enter the Installer Menu. Once in the Installer Menu, press **2-5-5 + MENU** on the Installer Remote to initiate the transfer of the Master TV Setup to the PTC. The TV exits the Installer Menu and then tunes through the channels in the channel lineup during the transfer. When the transfer is complete, the TV tunes back to the channel that was tuned before the transfer began.

**Note:** The maximum number of active channels that can be transferred is 141. Total channels numbering more than 141 will result in erratic TV operation.

### 5. Add Custom Channel and Aux Source Labels for Analog Channels: 2-5-4 + MENU Mode

Enter the Installer Menu, and press **2-5-4 + MENU** on the Installer Remote. Add/edit custom text labels to channel on-screen displays. Note that digital channels often have a broadcaster generated label (see 2-5-4 + MENU procedural information on page 22). When you are finished, press **MENU** to exit 2-5-4 + MENU Mode.

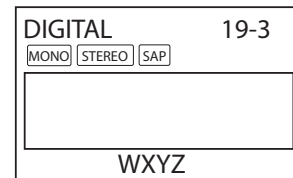

Custom Text Label "WXYZ" created in 2-5-4 + MENU (Add Channel Label) Mode.

**028 CH. OVERRIDE 000**

After verifying the TV Setup, set Installer Menu item 028 CH. OVERRIDE to 000.\*

\* This step prevents end users from accessing channel settings (i.e., the Channel Menu will be inaccessible/grayed out).

### 6. Verify the TV setup.

At this point, verify that the channel lineup, channel icons, and custom labels are correct. Make sure the TV features are set per your requirements.

### 7. Lock the channel lineup.

Enter the Installer Menu. Set item **028 CH. OVERRIDE** to **000** and press **ENTER** to lock the channel lineup and restrict access to the TV setup menus. Press **ENTER** again to save your changes and exit the Installer Menu.\*

The Master TV Setup is now ready to be copied to a USB memory device or a clone programmer (see cloning information in this document).

# Installer Menu

---

Use the Installer Menu to set up or change operational settings. Refer to the table starting on the next page for brief descriptions of Installer Menu items. More detailed descriptions follow the table listing.

## Accessing the Installer Menu

1. Make sure the TV is ON.
2. Using an Installer Remote, press **MENU** repeatedly until the on-screen setup menus lock up, and then press **9-8-7-6 + ENTER** to access the Installer Menu.

The Installer Menu opens with item 000 INSTALLER SEQ 000.

## Using the Installer Menu

Items 000 ~ 119 are accessible only upon entering the Installer Menu. Refer to the table on pages 15 and 16 for an overview of Installer Menu items, including item numbers, functions, ranges, and default values. Installer Menu items not relevant to this TV series are not present on the Installer Menu; therefore, some numbers are missing. For example, item 006 will not appear.

### Navigation within the Installer Menu

Use the Up/Down arrow keys on the Installer Remote to sequence through the available menu items, or access an item directly by keying in the line number and then pressing **MENU**. For example, to access the SLEEP TIMER option, which is item 015, press 0-1-5 + MENU.

### Changing Installer Menu Settings

To change an Installer Menu item setting, use the Left/Right arrow keys on the Installer Remote, or enter a value directly. Press **ENTER** to save the new setting, or use the Up/Down arrow keys to navigate to a new Installer Menu item if you have additional items to edit.

## Exiting the Installer Menu and Activating Updates

After you have adjusted all required Installer Menu item settings, press **ENTER** once on the Installer Remote to save your changes; then, press **ENTER** again to exit the Installer Menu. Any changes you make will be stored in non-volatile memory.

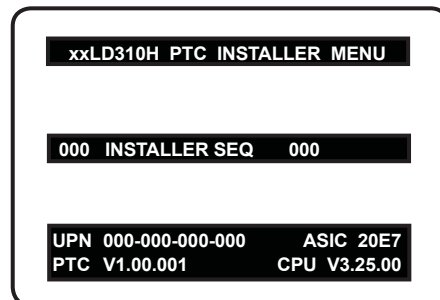

Typical TV Installer Menu

## Installer Menu Items 000 through 071

Menu Item	Function	Value Range	Default Value	Brief Description of Function and Comments
000	INSTALLER SEQ	0 ~ 3	0	Leave default set to 0.
001	POWER MANAGE	0 ~ 7	0	Sets number of hours of no activity before automatic shutoff.
002	AC ON	0 / 1	0	Set to 1 to enable Auto Turn ON when AC power is applied.
003	BAND/AFC	0 ~ 3	1	Selects Tuning Band: 0=Broadcast, 1=CATV, 2=HRC, 3=IRC
004	STRT CHANNEL	0 ~ 127, 255	255	Channel tuned when TV is turned ON. (Set to 255 to tune to channel tuned before TV turned OFF.)
005	CHAN LOCK	0 / 1	0	If set to 1, cannot tune from current channel.
007	STRT VOLUME	0 ~ 63, 255	255	Volume level when TV is turned ON. (Set to 255 to use volume level before TV turned OFF.)
008	MIN VOLUME	0 ~ 63	0	Sets minimum allowable volume setting.
009	MAX VOLUME	0 ~ 63	63	Sets maximum allowable volume setting.
010	MUTE DISABLE	0 / 1	0	Set to 1 to disable Mute Function.
011	KEY DEFEAT	0 / 1	0	Set to 1 to disable menu navigation keys on display panel.
015	SLEEP TIMER	0 / 1	1	Set to 1 to enable Sleep Timer.
016	EN TIMER	0 / 1	0	Set to 1 to enable On/Off Timers.
017	ALARM	0 / 1	1	Set to 1 to enable Alarm.
020	FEATURE LEVEL	0 ~ 1, 16 ~ 24	1	Determines the IR code scheme to which the TV will respond.
021	V-CHIP	0 / 1	1	Set to 1 to enable V-Chip (Parental Control) functions.
022	MAX BLK HRS	0 ~ 99	12	Sets number of V-Chip blocking hours.
023	CAPTION LOCK	0 / 1	0	Set to 1 to retain caption setting set before TV turned OFF.
028	CH. OVERRIDE	0 / 1	1	If set to 0, limits direct access to favorite channels.
029	OLD OCV	0 / 1	0	Set to 1 to change MPI operation to OCV.
030	ACK MASK	0 / 1	0	If set to 1, changes MPI for some OCV boxes.
031	POLL RATE	20 ~ 169	94	Selects poll rate for MPI.
032	TIMING PULSE	186 ~ 227	207	Sets baud rate for MPI.
034	CAMPORT EN	0 / 1	1	Set to 1 to enable Video 2 input.
035	COMPPOINT EN.	0 / 1	1	Set to 0 to disable HDMI 1. Set to 1 enable HDMI 1.
038	YPrPb EN.	0 / 1	1	Set to 1 to enable display panel Component Video 1 input jacks.
039	REAR AUX EN	0 / 1	1	Set to 1 to enable display panel Video 1 input jack.
040	AUTO CAMPORT	0 / 1	1	Set to 1 to automatically switch to Camport. If set to 1, STRT AUX SRCE cannot be set to 2.
046	STRT AUX SRCE	1 ~ 6, 255	6	Sets the starting Aux source (if item 004 STRT CHANNEL is set to 0).
047	AUX STATUS	0 / 1	0	Set to 1 for MPI Aux source to be reported as a channel number instead of Channel 0.
053	DIS. CH-TIME	0 / 1	0	Set to 1 to disable Channel-Time display.
069	EN. CH-T COL.	0 / 1	1	Set to 1 to enable custom color for the Channel-Time display.
070	FOR. CH-TIME	0 ~ 7	2	Chooses custom foreground color for the Channel-Time display.
071	BCK. CH-TIME	0 ~ 7	2	Chooses custom background color for the Channel-Time display.

# Installer Menu (Cont.)

## Installer Menu Items 073 through 119

Menu Item	Function	Value Range	Default Value	Brief Description of Function and Comments
073	CH NOT AVBLE	0 / 1	0	If set to 1 and Channel Override is 0, "NOT AVAILABLE" message is displayed when directly accessing a channel not in the favorite Channel List.
075	REVERT CH	0 / 1	0	If set to 1 and loss of MPI communication occurs, TV tunes to Start Channel.
078	UPN MSB	0 ~ 255	0	User programmable number, most significant byte.
079	UPN MSB-1	0 ~ 255	0	User programmable number, most significant byte - 1.
080	UPN MSB-2	0 ~ 255	0	User programmable number, most significant byte - 2.
081	UPN LSB	0 ~ 255	0	User programmable number, least significant byte.
082	CHKSM ERROR	0 / 1	1	Enforces rigid MPI checksum.
083	HANDSHK TIME	0 ~ 5	5	Relaxes MPI timing to be compatible with PC-based Windows-controlled systems.
084	PERMANENT BLK	0 / 1	0	Removes block hours setting for Parental Control and makes block permanent.
087	REAR RGB EN.	0/1/17	1	Set to 0 to disable RGB1. Set to 1 to enable for RGB PC. Set to 17 for Auto Configure.
088	EN NOISE MUTE	0 / 1	1	If set to 1, audio is muted if no signal is present.
090	KEY LOCK	0 / 1	0	If set to 1, keyboard is locked out, IR is still functional.
091	YPrPb2 EN	0 / 1	1	Set to 1 to enable HDMI 2 input.
094	SAP MENU EN	0 / 1	1	Set to 0 to disable feature on Function Menu. Set to 1 to enable feature on Function Menu.
096	DEF. ASP. RATIO	0 ~ 4	2	Sets default aspect ratio at power up. See detailed descriptions and item 106.
098	PRO:CENTRIC	0 ~ 2	0	Set to 0 to disable Pro:Centric operation. Set to 1 for Flash Mode. Set to 2 for GEM (Java Application) Mode.
099	BACK LIGHTING	1 ~ 100, 101 ~ 200, 255	100	Sets the level of the TV picture back lighting. (See detailed descriptions.)
102	ATSC BAND	0 ~ 4	4	Selects ATSC band.
103	ATSC TUNE MODE	0 / 1	1	Set to 1 (default) for Physical Channel scan. Set to 0 for Virtual Channel scan.
104	START MINOR CH	0 ~ 255	0	Selects Minor Start Channel. Set to 0 for NTSC.
106	ASP RATIO LOCK	0 / 1	0	To retain set aspect ratio on power cycle, set to 1. Set to 0 for default ratio on power cycle.
116	VIDEO MUTE EN	0 / 1	0	Set to 0 for Normal. Set to 1 for Blank.
117	FACT DEFAULT	0 / 1	0	Set to 0 for Normal. Set to 1 to load presets for all Installer Menu settings.
119	DATA CHANNEL	0 ~ 135	0	Set to 0 to disable. Set to the RF channel number of the Data Channel for Pro:Centric or E-Z Installation data. (See detailed descriptions.)

## Detailed Descriptions of Installer Menu Items

### 000 - INSTALLER SEQUENCE

Specifies entry sequence to the Installer Menu.

0 = 9876	1 = 4321
2 = 1478	3 = 3698

### 001 - POWER MANAGE (Power Management)

Determines hours of no activity before automatic shutoff. The Power Management function is for saving energy. If set to 0, Power Manage is Off. Settings range from 0 ~ 7, with 1 ~ 7 representing the hours that the unit will remain ON, unless there has been activity from either the control panel or remote control.

### 002 - AC ON (AC Power Switchable)

If set to 1, this allows the TV to turn ON when AC power is applied. Pressing the ON button is not necessary. This is desirable if the TV is plugged into a cable box or a power outlet controlled by a wall switch. Use the Left/Right arrow keys to choose 0 or 1, where 0 is the default (OFF), and 1 is ON.

**Note:** If set to 1 (ON), the TV does not respond to On/Off commands from either the remote or the display control panel, and the SLEEP TIMER is also nonfunctional.

### 003 - BAND/AFC (Band/Automatic Frequency Control)

There are four possible settings for this option:

0 = Broadcast	1 = CATV (default)
2 = HRC	3 = IRC

If some channels were not found by Auto Tuning (Channel Search), select the appropriate Band setting here, and add the channels using the Channel Edit option in the Channel Menu.

### 004 - STRT CHANNEL (Start Channel)

If active, this function allows you to determine the initial Major Start Channel number when the TV is turned ON. This feature is useful for an in-house information channel, since the TV would always select that channel when it is turned ON. Setting this item to 255 causes the last channel viewed when the TV was turned OFF, to be the tuned to channel when the TV is turned ON again.

**Note:** For a digital Start Channel, always remember to set item 104 to the Minor Start Channel number.

255 = Last channel	1 ~ 125 = Major Ch. #	0 = Aux
126 = Map to Channel 3	127 = Map to Channel 4	

### 005 - CHAN LOCK (Channel Lock)

Channel Lock is ideal if the system must always be on the same channel. Changing channels with the Channel Up/Down or keypad numbers is impossible. Channel Lock is inactive if set to 0 (default).

Generally, this feature is used in connection with STRT CHANNEL (Installer Menu item 004) where the Start Channel may, for example, be set to 3 or 4. If the Start Channel is 3, then the TV will remain locked on channel 3.

**NOTE:** For items 007, 008, and 009

For legacy reasons, the scale used is 0–63. The PTC software will translate this to the 0–100 scale used by the TV.

To translate a TV volume level to the Installer Menu value, use the following formula:

$$\text{Installer Value} = \frac{\text{TV Value} \times 63}{100}$$

Enter only the whole number (disregard fractions).

### 007 - STRT VOLUME (Start Volume)

This function allows the Installer to determine the initial volume level setting when the TV is turned ON. This feature is useful for an in-house information channel, since the TV would always select that volume level when it is turned ON. The range of values are 0 - 63, 255. If 255 is selected, the current volume level will be retained in memory when the TV is turned OFF; at turn ON, the volume level will be automatically set at the previous or last level.

### 008 - MIN VOLUME (Minimum Volume)

This function determines the minimum volume level allowable with the Volume (VOL) Up/Down control. In this way, for example, someone cannot set the volume too low to hear. The value range is from 0 to 63. Use the Left/Right arrow keys to change values. The factory default is 0, which provides the full range of volume control, if item 009 MAX VOLUME is also set to 63. It may be best to set the same value on every TV.

**Note:** The minimum volume level cannot have a value setting higher than the maximum volume level (described below).

### 009 - MAX VOLUME (Maximum Volume)

This function determines the maximum volume level allowable with the Volume (VOL) Up/Down control. In this way, for example, someone cannot set the volume level high enough to disturb others. The value range is 0 to 63, with 63 as the default, which gives the user the full range of volume control, if item 008 MIN VOLUME is also set at 0. Use the Left/Right arrow keys to change values. It may be best to set the same value on every TV.

**Note:** The maximum volume level cannot have a value setting lower than the minimum volume level (described above).

### 010 - MUTE DISABLE

Enables or disables sound mute function. If set to 1, sound cannot be muted. If set to 0, sound can be muted.

### 011 - KEY DEFEAT (Keyboard Defeat)

If set to 1, KEY DEFEAT prevents the end user from accessing the on-screen menus from the display panel—MENU, ENTER, and menu navigation keys do not function. If set to 0, those keys do function.

**Note:** Users can always access the menus by pressing MENU on the remote.

# Installer Menu (Cont.)

---

## 015 - SLEEP TIMER

If set to 1, the Sleep Timer feature may be used. If set to 0, the Sleep Timer is not available.

## 016 - EN TIMER (Enable On/Off Timers) \*

If set to 1, the Timer function is available to the end user and enabled continuously. Set to 0 to disable On/Off timers.

**Note:** Clock must be set in order to use timers.

## 017 - ALARM \*

Gives the installer the option of making the Alarm function available to the end user. If set to 1, the Alarm function is available to the end user. Set to 0 to disable the Alarm function.

**Note:** Clock must be set before the Alarm function will work.

## 020 - FEATURE LEVEL

Determines the IR code scheme to which the TV will respond, allowing for the use of unique IR codes based on "bed number" in a multi-TV single room installation. First determine the IR mode; then select the bed number.

**Note:** Multi-code remotes are not available for the current release. For additional information, contact your LG representative.

## 021 - V-CHIP (Parental Control) \*

Set to 1 to activate V-Chip (Parental Control) and have it available to the end user to filter and control or otherwise restrict programming content that can appear. Set to 0 to turn the V-Chip feature Off (not available to user); no programming restrictions can be set.

## 022 - MAX BLK HRS (Maximum Block Hours) \*

Sets hours from 0 to 99 for the maximum V-Chip (Parental Control) block hours. Default setting is for 12 blocking hours.

## 023 - CAPTION LOCK

If set to 0, captions are OFF when the TV is turned ON. Set to 1 to use the caption setting configured before the TV was turned OFF when the TV is turned ON.

## 028 - CH. OVERRIDE (Channel Override)

If set to 1, the user can select channels with either Channel Up/Down or by direct keypad entry. If set to 0, only those channels that are active in the TV's memory can be selected.

## 029 - OLD OCV (On Command Video™)

Set to 1 for operation with systems from On Command Corporation.

## 030 - ACK MASK

MPI Communication Parameter. Leave at default setting unless changed by PPV provider. When set to 1, changes MPI for some OCV boxes.

\* Only affects Function Menu if enabled by some PPV providers.

## 031 - POLL RATE

MPI Communication Parameter. Selects Poll Rate for MPI. Leave at default setting unless changed by Pay-Per-View provider. Step size of 16 ms.

## 032 - TIMING PULSE

MPI Communication Parameter. Leave at default setting unless changed by Pay-Per-View provider. Sets baud rate. Step size of 4.3 uS.

## 034 - CAMPORT EN. (Camera Port Enable)

Set to 1 to enable Video 2 input on display panel. If set to 0, Video 2 input on display panel is not functional.

## 035 - COMPPORT EN. (Computer Port Enable)

Enable/disable TV display panel HDMI 1 input jack. Set to 0 to disable HDMI1. Set to 1 to enable HDMI1.

## 038 - YPrPb EN. (Rear Component Video Enable)

Set to 1 to enable display panel rear Component Video input jacks. Set to 0 to disable display panel rear Component Video input jacks.

## 039 - REAR AUX EN. (Rear Aux Enable)

Set to 1 to enable display panel rear Aux (Video 1) input. Set to 0 to disable display panel rear Aux (Video 1) input.

## 040 - AUTO CAMPORT

Set to 1 to automatically switch to Camport when equipment is connected to side Video input. Set to 0 to disable side Video automatic source selection. If set to 1, STRT AUX SRCE cannot be set to 2.

## 046 - STRT AUX SRCE (Start Aux Source)

Sets the starting Aux source. When turned ON, the TV will tune to starting Aux source if item 004 STRT CHANNEL is set to 0.

If item 040 AUTO CAMPORT is set to 0:

1 = Video 1	4 = RGB	255 = Last Aux
2 = Video 2	5 = HDMI 2	
3 = HDMI 1	6 = Component	

If item 040 AUTO CAMPORT is set to 1:

1 = Video 1	4 = RGB	6 = Component
3 = HDMI 1	5 = HDMI 2	

## 047 - AUX STATUS

Set to 1 for MPI Aux source to be reported as a channel number instead of channel 0. Set to 0 to disable Aux identification change. Controls MPI status channel response for Aux inputs.

## 053 - DIS. CH-TIME (Disable Channel-Time)

Set to 1 to disable the Channel-Time display; Channel-Time display will not appear. Set to 0 to enable the Channel-Time display.

## **069 - EN. CH-T COL. (Enable Channel-Time Custom Color)**

Set to 1 to enable custom color for the Channel-Time display. Set to 0 to disable custom color for the Channel-Time display.

## **070 - FOR. CH-TIME (Channel-Time Display Foreground Color)**

Set according to Color Chart:

0 = Black	3 = Cyan	6 = Yellow
1 = Blue	4 = Red	7 = White
2 = Green	5 = Violet	

**Note:** Applies only to "Channel Not Available" message if item 073 is set to 1 (enabled). If foreground color and background color are the same, the menu background will be transparent.

## **071 - BCK. CH-TIME (Channel-Time Display Background Color)**

Set according to Color Chart:

0 = Black	3 = Cyan	6 = Yellow
1 = Blue	4 = Red	7 = White
2 = Green	5 = Violet	

**Note:** Applies only to "Channel Not Available" message if item 073 is set to 1 (enabled). If foreground color and background color are the same, the menu background will be transparent.

## **073 - CH NOT AVBLE (Channel Not Available)**

If set to 1 and item 028 CH. OVERRIDE is set to 0, a "NOT AVAILABLE" message is displayed when directly accessing a channel not in the channel scan list available in memory.

## **075 - REVERT CH (Revert to Start Channel)**

If set to 1 and loss of MPI communication occurs, TV automatically tunes to the specified Start Channel.

## **078 - UPN MSB (UPN Most Significant Byte)**

User programmable number, most significant byte readable by MPI command. Not linked to serial number.

## **079 - UPN MSB-1 (UPN Most Significant Byte-1)**

User programmable number, most significant byte-1 readable by MPI command. Not linked to serial number.

## **080 - UPN MSB-2 (UPN Most Significant Byte-2)**

User programmable number, most significant byte-2 readable by MPI command. Note: Not linked to serial number.

## **081 - UPN LSB (UPN Least Significant Byte)**

User programmable number, least significant byte readable by MPI command. Note: Not linked to serial number.

## **082 - CHKSM ERROR (Checksum Error)**

Enforces rigid MPI checksum validation. Set to 1 for validation. Set to 0 to disable (does not check checksum on MPI async port). SPI is always checked.

## **083 - HANDSHK TIME (Handshake Time)**

Adds an additional delay to the handshake time which is 64 msec, thus relaxing MPI timing requirements to be compatible with PC-based Windows controlled systems. Range is 0 - 5. (Timeout = 25.5MS + [25.5 MS\* Handshake time].)

## **084 - PERMANENT BLK (Permanent Block)**

Allows Lock (Parental Control) blocking schemes to be permanent by disabling the blocking hours function. Set to 1 to install Parental Control restrictions permanently. Set to 0 for user-specified hours control of blocking schemes.

## **087 - REAR RGB EN. (Rear RGB Enable)**

Controls access to rear RGB input on TV. Set to 0 to disable RGB input. Set to 1 to enable for PC RGB input. Set to 17 to initiate a one-time automatic configuration after an AC power cycle; otherwise, automatic adjustment will be performed each time the RGB input is accessed.

## **088 - EN NOISE MUTE (Enable Noise Mute)**

If set to 1, audio mutes if no signal is present.

## **090 - KEY LOCK**

If set to 1, front keyboard Channel, Volume, and Captions buttons are disabled, Power button remains enabled. If set to 0, the Channel, Volume, Captions, and Power buttons are all enabled.

## **091 - YPrPb2 EN. (HDMI2 Enable)**

Set to 0 to disable display panel HDMI2 input. Set to 1 to enable DTV mode. Set to 2 to enable PC mode.

## **094 - SAP MENU EN (2nd Audio Program)**

Set to 1 to enable SAP feature on Function Menu, if Function Menu is available. Set to 0 to disable SAP feature on Function Menu, if Function Menu is available.

## **096 - DEF. ASP. RATIO (Default Aspect Ratio)**

Selects default aspect ratio at power up.

- Set to 0 for Set By System.
- Set to 1 for 4:3.
- Set to 2 for 16:9 (Factory Default).
- Set to 3 for Just Scan.
- Set to 4 for Zoom.

**Note:** Only applies if item 106 ASP RATIO LOCK is disabled, set to 0.

## **098 - PRO:CENTRIC**

Selects the Pro:Centric Mode. Set to 0 (default) to disable Pro:Centric operation. Set to 1 for Flash Mode. Set to 2 for GEM (Java Application) Mode.

## Installer Menu (Cont.)

---

### 099 - BACK LIGHTING

Sets the TV screen brightness at power up. Default setting is 100.

- 1 - 100 Static Back Lighting  
(1 = Dimmest picture, 100 = Brightest picture)
- 101 - 200 Dynamic Back Lighting  
(101 = Dimmest picture, 200 = Brightest picture)

If set between 101 and 200, the TV automatically controls back lighting depending upon the picture level of the current program. If set to 255, back lighting is controlled via the Picture settings in the TV's setup menus.

### 102 - ATSC BAND

Sets up TV to receive different types of incoming signals:  
0 = Broadcast, 1 = CATV, 2 = HRC, 3 = IRC, 4 = Same as NTSC.

### 103 - ATSC TUNE MODE

Sets ATSC tuning mode: Default set to 1 for Physical Channel scan. Set to 0 for Virtual Channel scan.

### 104 - START MINOR CHANNEL

Sets Minor Start Channel number at power up. 0 = NTSC. If not 0, number selected is the digital channel's Minor Start Channel number.

### 106 - ASP RATIO LOCK (Aspect Ratio Lock)

Set to 1 to retain previous aspect ratio with power off. Set to 0 to retain default aspect ratio with power off. See item 096 DEF. ASP. RATIO above.

### 116 - VIDEO MUTE EN (Video Mute Enable)

Set to 0 for Normal. Set to 1 for Blank.

### 117 - FACT DEFAULT (Factory Default)

Set to 0 for normal. Set to 1 to load presets of all Installer Menu item settings.



**Warning: If set to 1, this will reload the factory defaults and clear the channel lineup, including any assigned channel icons and custom channel labels.**

### 119 - DATA CHANNEL

Set to 0 (default) to disable. Set to the RF channel number of the Data Channel for Pro:Centric or E-Z Installation (splash screen, configuration, or firmware) data.

**Note:** Pro:Centric updates are downloaded from the Pro:Centric server to the TV when the TV is turned OFF. Also, while Pro:Centric updates are in progress, it is not possible to turn the TV ON. The TV may take several minutes to load EPG data after the initial download of the Pro:Centric application. Subsequent updates generally will take less than one minute.



# TV Setup Menus Overview

---

On-screen setup menus control the features of the TV. Press **MENU** on the Installer Remote to access the TV setup menus, and set the TV features to the desired configuration for the end user.

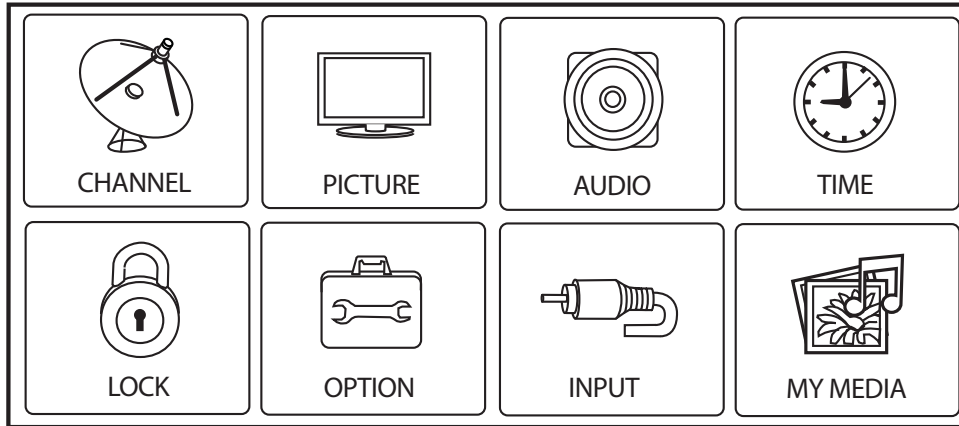

Refer to the Owner's Manual for further information on the TV setup menus.

# Adding Channel Label Icons / Custom Channel Labels (2-5-4 + MENU Mode)

## Editing/Adding Channel Icons and/or Labels

If there is no pre-assigned icon, you can make a custom channel label of up to seven (7) characters to help identify a channel or network. If desired, channel labels can also be added in addition to a pre-assigned icon. You may also add labels for the Aux input sources to clearly identify the devices that are connected to the Aux inputs.

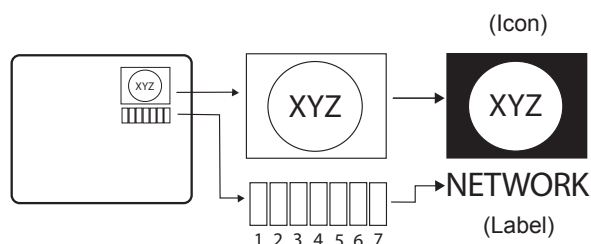

Editing and adding the labels can only be done if there are channels entered into the TV's Channel Map either during Commercial Mode Setup (see pages 12 to 13), by cloning, or by using some PPV providers' master remote controls. **Note:** A blank letter space is available between "Z" and "!".

## To perform channel editing/labeling:

1. Enter the TV Installer Menu: Press **MENU** repeatedly until the on-screen setup menus lock up, and then press **9-8-7-6 + ENTER**.
2. Press **2-5-4 + MENU** on the Installer Remote to enter the Channel Label Editing Mode.
3. Add channel icons and channel labels as described in the procedures below. (You can do this more than once.)
4. To exit the menu when you are done, press **MENU**.

## Changing a Channel's Icon on the Master TV

1. Use Channel Up/Down to select the desired channel.
2. Use the Left/Right arrow keys to select the thin letter "I" on the Channel ID display.
3. Use the Up/Down arrow keys to select the icon with which you want to identify the channel. (If you know the icon number, enter the number, and press **ENTER**.)
4. Proceed to change/add channel labels, or go to the next channel.

## Changing/Adding Channel Labels on the Master TV

1. Use Channel Up/Down to select the desired channel.
2. Press the Left or Right arrow repeatedly until the numbers 1 to 7 appear on the display. The number shows the position of the character that can be changed. Number 1 is the first character, number 2 the second character, etc.
3. Use the Up/Down arrow keys to select the desired character.
4. Proceed to the next number position, or use Channel Up/Down to go to the next channel.

## Changing Source Labels on the Master TV

1. Press **INPUT** to select the desired Aux input source: A/V 1, A/V 2, HDMI Component, RGB, etc.
2. Press the Left or Right arrow repeatedly until the numbers 0 to 9 appear on the display. The number shows the position of the character that can be changed.
3. Use the Up/Down arrow keys to select the desired character.
4. Press **INPUT** for the next Aux source, or use Channel Up/Down to return to channels.

## Installer Remote Control Key Functions for Master TV Channel Editing/Labeling Menu

- **Channel Up/Down:** Tunes to the next channel in scan.
- **Left/Right Arrows:** Select the item to change. If "I" is shown, the icon can be changed. If a number is shown, it indicates the position of the character that can be changed.
- **Up/Down Arrows:** Select the icon or the character to be displayed. Tip: Arrows can be held down for fast scrolling.
- **0 – 9:** Use to enter the index number of the icon, if known.
- **ENTER:** Changes the icon after the number has been entered.
- **INPUT:** Changes the Aux input label.
- **MENU:** Exits the editing process.

## IMPORTANT CLONING INFORMATION

There are three options for cloning a Master TV Setup:

- Using a USB memory device
- Using a TLL-1100A clone programmer
- Using a LT2002 clone programmer

Each option is described in further detail on the pages that follow. As you perform cloning procedures, be sure to complete each task as indicated. If a procedure or step is omitted or not performed completely, cloning may not work. At each step, pay attention to ensure the TV screen shows the proper message when cloning. If the message indicated does not appear, there is a problem with that step, and cloning may not be successful.



**Warning: Copying a blank or incorrect memory into a TV will cause the TV to operate erratically or become inoperable.**



**Warning: Do not connect a clone programmer to a PPV card installed in the Master or Target TVs, as this will damage the clone programmer and the PPV card.**

### Before you begin cloning:

- Complete the Commercial Mode Setup for Master TV procedure on pages 12 to 13.
- Ensure Installer Menu items on Target TVs are set/restored to factory default settings (i.e., set Installer Menu item 117 FACT DEFAULT to 001 on Target TVs) before Teaching is initiated.
- All equipment should be connected to power and turned ON.
- Learning and Teaching is only possible between identical model TVs.
- The Master and Target TVs must be in Pass-through Mode.
- If using a USB memory device, ensure the USB device has been formatted with FAT format.
- For both Master and Target TVs—If using a clone programmer, ensure the TV signal source is either an Aux or TV (RF) source. If a TV (RF) source, the TV must be tuned to an analog (not a digital) channel.
- LT2002 only—Make sure the batteries in the clone programmer are fresh. If batteries are removed, the clone programmer clock time (if set) will be lost (see page 28 for information on the clone programmer clock).
- Do not unplug the TV power cord or remove/disconnect the USB memory device/clone programmer while Learning or Teaching, as doing so may cause the TV to malfunction or harm the USB device/clone programmer, respectively.

## Clonable Menu Features

### Installer Menu

Installer Menu item settings

### Channel

Auto Tuning (Channel Lineup)  
Manual Tuning  
Channel Edit  
Channel Label

### Picture

Aspect Ratio  
Picture Mode  
Advanced Control

### Audio

Auto Volume  
Clear Voice  
Sound Mode  
Balance  
TV Speaker

### Option

Menu Language  
Audio Language  
Caption  
Caption Mode  
Digital Caption Options

### Lock

Movie Rating  
TV Rating – Children  
TV Rating – General  
Input Block

### Time

Auto Clock  
Manual Clock  
Off Time  
On Time  
Auto Off (Sleep Timer)

**Note:** Some menu options vary between analog and digital channels and Aux sources.

# Cloning Procedures

## Learning / Teaching a Master TV Setup using a USB Memory Device

### USB Cloning Notes

- Read the IMPORTANT CLONING INFORMATION on page 23 before beginning any cloning procedures.
- You may edit a filename as part of the Learning procedure; however, a file with edited contents will not be recognized.
- It is not possible to clone a Master TV's clock using a USB memory device. Either set a Target TV's clock manually, or use the Auto Clock setting in the TV setup menus.

### Learn Setup from Master TV

1. Ensure the Master TV is set up completely and in Pass-through Mode.
2. Plug the USB memory device into the USB IN port on the Master TV.
3. Press **MENU** on the Installer Remote to display the TV setup menus, use the arrow navigation keys to select/highlight the **Option** menu icon, and then press the number "7" key a total of seven times to display the USB Download Menu.
4. To gain access to the Learn From TV option in the USB Download Menu, key in the password used to enter the Installer Menu (Example: Press **9-8-7-6**).
5. Use the Up/Down arrow keys to select **Learn From TV (TLL)**, and then press **ENTER**.
6. To identify the profile from others, you can use the Up/Down arrow keys to change the last few digits of the filename. Press **ENTER** when you are ready to initiate Learning.

Learning status will be shown on the progress bar. When the Learning process is complete, the USB Download menu will reappear on screen.

7. Remove the USB memory device.

### Teach Master TV Setup to Target TV

1. Ensure the Target TV is in Pass-through Mode, and then use the Installer Remote to enter the Target TV Installer Menu: Press **MENU** repeatedly until the on-screen setup menus lock up, and then press **9-8-7-6 + ENTER**.
2. Set Installer Menu item **117 FACT DEFAULT** to **001**, and press **ENTER**. When the value changes back to 0, press **ENTER** again to exit the Installer Menu.
3. Plug the USB memory device with the Master TV Setup file into the Target TV USB IN port.
4. Press **MENU** on the Installer Remote to display the TV setup menus, use the arrow navigation keys to select/highlight the **Option** menu icon, and then press the number "7" key a total of seven times to display the USB Download Menu.
5. Use the Up/Down arrow keys to select **Teach To TV (TLL)**, and then press **ENTER**.
6. Use the Up/Down arrow keys to select the Master TV Setup you want to install, and then press **ENTER**. Note: Filenames identify the TV and the TLL version (see example at right).

Teaching status will be shown on the progress bar. When the Teaching process is complete, the USB Download menu will reappear on screen.

7. When Teaching is done, remove the USB memory device, turn OFF the TV, and unplug the TV power cord for 15 seconds.
8. Reconnect the TV power cord, and turn ON the TV. The Master TV Setup should be resident on the Target TV.

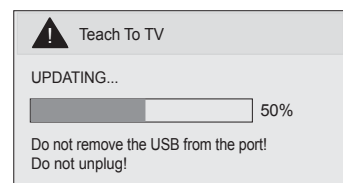
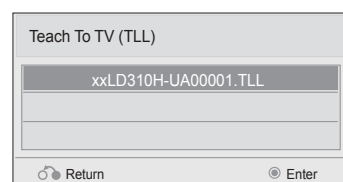
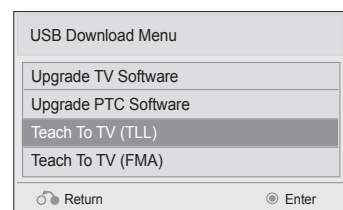
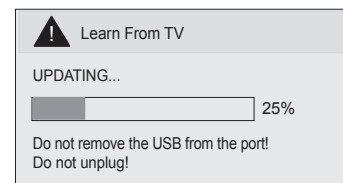
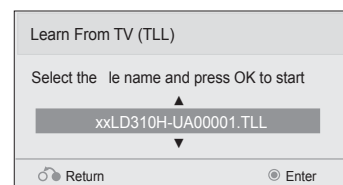
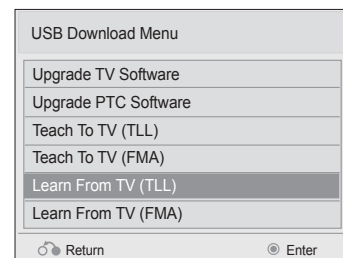

## Learning / Teaching a Master TV Setup using a TLL-1100A Clone Programmer

**Warning:** Do not connect a clone programmer to a PPV card installed in the Master or Target TVs, as this will damage the clone programmer and the PPV card.

Cloning is accomplished using the TV/clone programmer MPI ports for communication (see figure).

### TLL-1100A Cloning Notes

- Read the IMPORTANT CLONING INFORMATION on page 23 before beginning any cloning procedures.
- Ensure the TLL-1100A is either fully charged or connected to AC power.
- Learning and Teaching is only possible between identical model TVs; however, the TLL-1100A clone programmer can store up to eight different Master TV Setups.

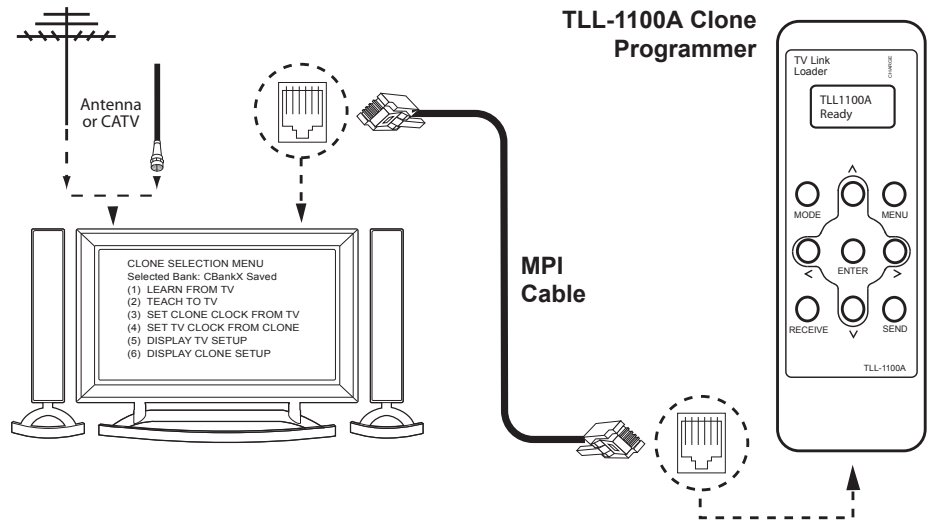

### Learn Setup from Master TV

1. Ensure the Master TV is set up completely and in Pass-through Mode.
2. If an analog channel is not available, direct tune the TV to an Aux source, or select an Aux source, such as AV-1, from the Input Menu. Then, plug one end of the MPI cable into the TV MPI port.
3. Turn ON the TLL-1100A.
4. Use the **MODE** button on the TLL-1100A to select **Clone Mode**.
5. Use the Left/Right arrows on the TLL-1100A to select the Memory CBank (1 to 8) in which to store the Master TV Setup.
6. Plug the other end of the MPI cable into the MPI port on the bottom of the TLL-1100A. The Clone Selection Menu will display on the TV screen.
7. Press **1** on the Installer Remote to select **LEARN FROM TV** from the Clone Selection Menu. Then, press **ENTER** to transfer the Master TV Setup into CBankX on the TLL-1100A.

CLONE SELECTION MENU  
 Selected Bank: CBankX Saved  
 (1) LEARN FROM TV  
 (2) TEACH TO TV  
 (3) SET CLONE CLOCK FROM TV  
 (4) SET TV CLOCK FROM CLONE  
 (5) DISPLAY TV SETUP  
 (6) DISPLAY CLONE SETUP

CLONE CLOCK = XX:XX  
 TV CLOCK = XX:XX  
 THE CLONE IS VERSION VX.X.X

- To change menu items, press channel keys or digits.  
 - To execute item, press Enter.

Learning usually takes about 90 seconds. "LEARNING IN PROGRESS" will be displayed on the screen while the TLL-1100A copies the Master Setup. When the Learning process is complete, a "LEARNING COMPLETE" message will be displayed.

# Cloning Procedures (Cont.)

## Learning / Teaching a Master TV Setup using a TLL-1100A Clone Programmer (Cont.)

### (Optional) Set the Clock

Set the time on a Master TV's clock. (If the time has already been copied from a TV into the TLL-1100A clone programmer, you can set the Master TV's clock by copying the time from the clone programmer.) The TLL-1100A can copy the current time to both a Master TV and to the clone's internal clock—accurate to within one minute.

Since the TLL-1100A's time cannot be set directly, the current time needs to be copied from an LG TV equipped with an enabled MPI port.

After the time is copied to the TLL-1100A clone programmer, the current time will be maintained and can then be transferred to another TV. (This can be a Master TV or another TV which has already had the features set up.)

### Teach Master TV Setup to Target TV

1. When Learning is complete, disconnect the MPI cable from the Master TV.
2. Ensure the Target TV is in Pass-through Mode, and then use the Installer Remote to enter the Target TV Installer Menu: Press **MENU** repeatedly until the on-screen setup menus lock up, and then press **9-8-7-6 + ENTER**.
3. Set Installer Menu item **117 FACT DEFAULT** to **001**, and press **ENTER**. When the value changes back to 0, press **ENTER** again to exit the Installer Menu.
4. Tune/set the TV to an analog channel or Aux source, and then connect the MPI cable to the MPI port on the Target TV. The Clone Selection Menu will display on the TV screen.
5. Ensure the correct Memory CBank(X) is selected on the TLL-1100A.
6. Press **2** on the Installer Remote to select **TEACH TO TV** from the Clone Selection Menu. Then, press **ENTER** to transfer the Master TV Setup to the Target TV.  
Teaching usually takes 3 to 4 minutes. "TEACHING IN PROGRESS" will be displayed on the screen during Teaching. When the Teaching process is complete, a "TEACHING COMPLETE" message will be displayed.
7. When Teaching is done, disconnect the MPI cable from the Target TV, turn OFF the TV, and unplug the TV power cord for 15 seconds.
8. Reconnect the TV power cord, and turn ON the TV. The Master TV Setup should be resident on the Target TV.

CLONE SELECTION MENU  
Selected Bank: CBankX Saved  
(1) LEARN FROM TV  
(2) TEACH TO TV  
(3) SET CLONE CLOCK FROM TV  
(4) SET TV CLOCK FROM CLONE  
(5) DISPLAY TV SETUP  
(6) DISPLAY CLONE SETUP

CLONE CLOCK = XX:XX  
TV CLOCK = XX:XX  
THE CLONE IS VERSION VX.X.X  
- To change menu items, press channel keys or digits.  
- To execute item, press Enter.

CLONE SELECTION MENU  
Selected Bank: CBankX Saved  
(1) LEARN FROM TV  
(2) TEACH TO TV  
(3) SET CLONE CLOCK FROM TV  
(4) SET TV CLOCK FROM CLONE  
(5) DISPLAY TV SETUP  
(6) DISPLAY CLONE SETUP

CLONE CLOCK = XX:XX  
TV CLOCK = XX:XX  
THE CLONE IS VERSION VX.X.X  
- To change menu items, press channel keys or digits.  
- To execute item, press Enter.

## Learning / Teaching a Master TV Setup using an LT2002 Clone Programmer

**Warning:** Do not connect a clone programmer to a PPV card installed in the Master or Target TVs, as this will damage the clone programmer and the PPV card.

Cloning is accomplished using the TV/clone programmer MPI ports for communication (see figure).

### LT2002 Cloning Notes

- Read the IMPORTANT CLONING INFORMATION on page 23 before beginning any cloning procedures.
- A slow flashing green light indicates that there are communication problems between the TV and the LT2002 clone programmer. If this is the case, check for a damaged cable, poor contacts, or other connection troubles.
- If the status indicator is red, the LT2002 batteries are low and should be replaced. Install four (4) high-quality alkaline AA batteries.
- Learning and Teaching is only possible between identical model TVs; however, the LT2002 clone programmer can store up to three different Master TV Setups.

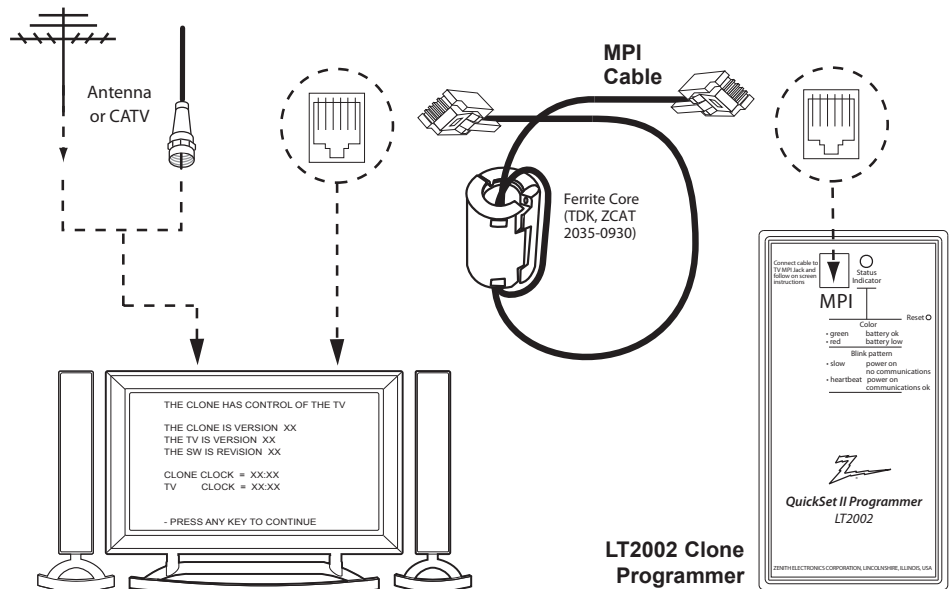

### Learn Setup from Master TV

1. Ensure the Master TV is set up completely and in Pass-through Mode.
2. If an analog channel is not available, direct tune the TV to an Aux source, or select an Aux source, such as AV-1, from the Input Menu. Then, plug one end of the MPI cable into the TV MPI port.
3. If there is a good connection after the LT2002 is connected to the TV MPI port, "THE CLONE HAS CONTROL OF THE TV" message will appear on the TV screen. Press any key on the Installer Remote to access the LT2002 Clone Selection Menu.
4. Press **1** on the Installer Remote to select **LEARN FROM TV** from the Clone Selection Menu; then press **ENTER** to proceed to the Memory Bank Selection Menu (see sample screen on next page).
5. Select the clone Memory Bank in which to store the Master Setup by pressing either Channel key repeatedly to choose Memory Bank 1, 2, or 3. Note: If you choose a Memory Bank that already has a Master device's setup programmed into it, that setup will be overwritten by the new Master TV Setup.

THE CLONE HAS CONTROL OF THE TV

THE CLONE IS VERSION XX  
THE TV IS VERSION XX  
THE SW IS REVISION XX

CLONE CLOCK = XX:XX  
TV CLOCK = XX:XX

- PRESS ANY KEY TO CONTINUE.

- DISCONNECT CLONE WHEN DONE.

CLONE SELECTION MENU

(1) LEARN FROM TV  
(2) TEACH TO TV  
(3) SET CLONE CLOCK FROM TV  
(4) SET TV CLOCK FROM CLONE  
(5) DISPLAY TV SETUP  
(6) DISPLAY CLONE SETUP

- TO CHANGE MENU ITEMS, PRESS CHANNEL KEYS OR DIGITS.

- TO EXECUTE ITEM, PRESS ON/OFF, POWER, OR ENTER.

(Continued on next page)

# Cloning Procedures (Cont.)

## Learning / Teaching a Master TV Setup using an LT2002 Clone Programmer (Cont.)

(Continued from previous page)

6. Once you select the clone Memory Bank, press **ENTER** on the Installer Remote. The Memory Bank you selected will be shown.
7. Press **POWER** to transfer the Master TV Setup into the selected Memory Bank on the LT2002.

Learning usually takes about 90 seconds. "LEARNING IN PROGRESS" will be displayed on the screen while the LT2002 copies the Master Setup. When the Learning process is complete, a "LEARNING COMPLETE" message will be displayed.

SAVE TV SETUP IN SELECTED CLONE MEMORY

- (1) MEMORY 1 VER XX REV XX
- (2) MEMORY 2 VER XX REV XX
- (3) MEMORY 3 VER XX REV XX
- (4) RETURN TO CLONE MENU

- TO CHANGE MENU ITEMS, PRESS CHANNEL KEYS OR DIGITS.

- TO EXECUTE ITEM, PRESS ON/OFF, POWER, OR ENTER.

### (Optional) Set the Clock

Set the time on a Master TV's clock. (If the time has already been copied from a TV into the LT2002 clone programmer, you can set the Master TV's clock by copying the time from the clone programmer.) The LT2002 can copy the current time to both a Master TV and to the clone's internal clock—accurate to within one minute. (Another reason that the LT2002 should be equipped with fresh, high-quality alkaline batteries, is for it to keep the time as accurately as possible.)

Since the LT2002's time cannot be set directly, the current time needs to be copied from an LG TV equipped with an enabled MPI port.

After the time is copied to the LT2002 clone programmer, the current time will be maintained and can then be transferred to another TV. (This can be a Master TV or another TV which has already had the features set up.)

CLONE SELECTION MENU

- (1) LEARN FROM TV
- (2) TEACH TO TV
- (3) SET CLONE CLOCK FROM TV
- (4) SET TV CLOCK FROM CLONE
- (5) DISPLAY TV SETUP
- (6) DISPLAY CLONE SETUP

- TO CHANGE MENU ITEMS, PRESS CHANNEL KEYS OR DIGITS.

- TO EXECUTE ITEM, PRESS ON/OFF, POWER, OR ENTER.

### Teach Master TV Setup to Target TV

1. When Learning is complete, disconnect the MPI cable from the Master TV.
2. Ensure the Target TV is in Pass-through Mode, and then use the Installer Remote to enter the Target TV Installer Menu: Press **MENU** repeatedly until the on-screen setup menus lock up, and then press **9-8-7-6 + ENTER**.
3. Set Installer Menu item **117 FACT DEFAULT** to **001**, and press **ENTER**. When the value changes back to 0, press **ENTER** again to exit the Installer Menu.
4. Tune/set the TV to an analog channel or Aux source, and then connect the MPI cable to the MPI port on the Target TV.
3. With "THE CLONE HAS CONTROL OF TV" message on display, press **2** on the Installer Remote to select **TEACH TO TV** from the LT2002 Clone Selection Menu. Then, press **ENTER**.

CLONE SELECTION MENU

- (1) LEARN FROM TV
- (2) TEACH TO TV
- (3) SET CLONE CLOCK FROM TV
- (4) SET TV CLOCK FROM CLONE
- (5) DISPLAY TV SETUP
- (6) DISPLAY CLONE SETUP

- TO CHANGE MENU ITEMS, PRESS CHANNEL KEYS OR DIGITS.

- TO EXECUTE ITEM, PRESS ON/OFF, POWER, OR ENTER.

4. Select the LT2002 Memory Bank in which the new setup is located. Then, press **POWER** to transfer the Master TV Setup to the Target TV.

Teaching usually takes 3 to 4 minutes. "TEACHING IN PROGRESS" will be displayed on the screen during Teaching. When the Teaching process is complete, a "TEACHING COMPLETE" message will be displayed.

5. When Teaching is done, press any key on the Installer Remote to return to the Clone Selection Menu. Then, press **ENTER**.
6. Disconnect the MPI cable from the Target TV, turn OFF the TV, and unplug the TV power cord for 15 seconds.
7. Reconnect the TV power cord, and turn ON the TV. The Master TV Setup should be resident on the Target TV.

COPY SELECTED CLONE MEMORY TO TV

- (1) MEMORY 1 VER XX REV XX
- (2) MEMORY 2 VER XX REV XX
- (3) MEMORY 3 VER XX REV XX
- (4) RETURN TO CLONE MENU

- TO CHANGE MENU ITEMS, PRESS CHANNEL KEYS OR DIGITS.

- TO EXECUTE ITEM, PRESS ON/OFF, POWER, OR ENTER.



## FTG Mode Overview / Determining the TV Operating Mode

### FTG Mode Overview

FTG Mode enables Pro:Idiom decryption and also allows logical channel mapping of physical channels. “Teaching” an FMA Configuration file to a LD310H TV puts the TV into FTG Mode. Once the LD310H TV is in FTG Mode:

- Users can still access the Installer Menu; however, all Installer Menu items, with the exception of item 117 FACT DEFAULT will be read-only. To return the TV to Pass-through Mode, you must set Installer Menu item 117 FACT DEFAULT to 001 to reload factory default settings on the TV. (See “Installer Menu” section of this document for further information.)
- Any con guration updates must be made in the FTG Con guration Application. FTG Channel Map Con guration and FTG Installer Menu Con guration Utilities enable you to update the FTG Channel Map and FTG Installer Menu, as necessary, and the FMA Con guration Utility enables you to save the updates to a FMA Con guration file. The FMA Con guration file can then be transferred to the TV via a USB memory device.

This section outlines how to create an FMA Configuration file using the FTG Channel Map, FTG Installer Menu, and FMA Configuration Utilities that comprise the FTG Configuration Application. It also describes how to transfer (Teach) an FMA Configuration file to a TV using a USB device. Refer to the **Free-To-Guest (FTG) Configuration Application** manual for further information.

 **Note: The LD310H cannot be put into FTG Mode in this manner if an MPI slot card or external MPI device has been implemented as a means of controlling the TV.**

### Determining the TV Operating Mode

To determine the operating mode of the TV, press **MENU** on the Installer Remote. If the end user Function Menu (showing aspect ratio options) appears, the TV is in FTG Mode. If the TV setup menus appear, the TV is in Pass-through Mode.

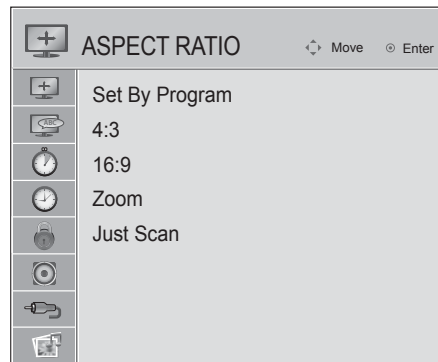

**Function Menu**  
Shows that the TV is in FTG Mode. While this menu is present on-screen, Installer Menu settings can **ONLY** be changed using the FTG Configuration Application to update the FMA Configuration file.

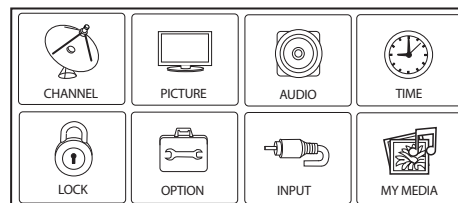

**TV Setup Menus**  
Shows that the TV is in Pass-through Mode.

# FTG Mode of Operation (Cont.)

## Creating an FMA Configuration File using the FTG Configuration Application

---

In order to enable Pro:Idiom decryption, it is recommended that you create an FMA Configuration file using the FTG Configuration Application. However, if you do not know the RF channels at the site, you can Learn an FMA Configuration file from a TV (see next page).

The procedure below provides an overview of the steps required to create an FMA Configuration (.fma) file. Refer to the **Free-To-Guest (FTG) Configuration Application** manual for further information. See also FTG Configuration Application sample screens on pages 33 to 36.

**Note:** FTG Configuration Application software is available online at: [www.LGcommercial.com/FTGsoftware](http://www.LGcommercial.com/FTGsoftware).

1. Install (if necessary) and launch the FTG Configuration Application (v5.0.0 or higher) on the PC that will be used to create the FMA Configuration file.
2. Either:
  - Open an existing FTG Configuration (.rml) file, if applicable, to use its FTG Channel Map. Otherwise, create a new FTG Channel Map using the FTG Channel Map Editor in the FTG Channel Map Configuration Utility. Then, continue with step 3.  
**Note:** Up to 141 logical channels can be defined in the FTG Channel Map.
  - To view and/or base a new FMA Configuration file on an existing LD310H FMA Configuration file, click **Configure** in the FTG Configuration Application menu bar, and select **FMA** to access the FMA Configuration Utility. Then, click the **Open** button above the FMA Configuration List, and double-click the desired (.fma) file. A list of the file's contents will be displayed in the FMA Configuration List window, and you can edit the FMA Configuration List as necessary to create a new file. Proceed to step 4 when you are ready to continue.
3. Click **Configure** in the FTG Configuration Application menu bar, and select **FMA** to access the FMA Configuration Utility.
4. To add an FTG Channel Map, click >> under FTG Channel Map to copy the current FTG Channel Map to the FMA Configuration List.  
**Note:** If you make any change(s) in the FTG Channel Map Configuration Utility to the current data to be included in the FMA Configuration List, you will need to recopy the FTG Channel Map to the FMA Configuration List.
5. Load default Installer Menu settings for the LD310H TV:
  - Click the down arrow at the right of the Chassis field under Installer Menu Templates, and select **32/37LD310H** from the drop-down list of available models.
  - Click the **Load** button.
  - Use the FTG Installer Menu Configuration Utility to modify settings, if necessary. Then, return to the FMA Configuration Utility.
  - Click >> under FTG Installer Menu Settings to copy the LD310H settings to the FMA Configuration List.
6. Click the **Save** button above the FMA Configuration List to save its contents to an FMA Configuration (.fma) file for later use.
7. Save the FMA Configuration file to a USB memory device, and proceed to "Teaching FMA Configuration to a TV" on the following page to transfer the FMA Configuration file to an LD310H TV.

## Teaching FMA Configuration to a TV / Learning an FMA Configuration File from a TV

### Teaching FMA Configuration to a TV

1. Plug the USB memory device that contains the FMA Configuration file into the Target LD310H TV USB IN port.
2. Press **MENU** to display the TV setup menus, use the arrow navigation keys to select/highlight either the **Option** (if TV is in Pass-through Mode) or **Lock** (if TV is already in FTG Mode) menu icon, and then press the number “7” key a total of seven times to display the USB Download Menu.
3. Use the Up/Down arrow keys to select **Teach To TV (FMA)**, and then press **ENTER**.
4. Use the Up/Down arrow keys to select the FMA Configuration file you want to install, and then press **ENTER**.

The TV will show Teaching completion progress in a new window. Do NOT remove the USB device until Teaching is complete. When Teaching is complete, the TV will tune to the first logical channel in the FTG Channel Map.

5. When Teaching is done, remove the USB memory device. The FMA Configuration should be resident on the Target TV. Also, the Target TV is now in FTG Mode (if it was previously in Pass-through Mode).

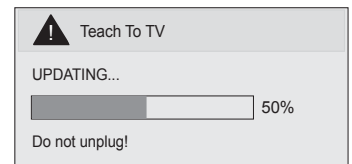
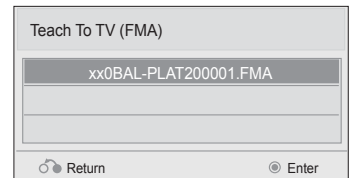
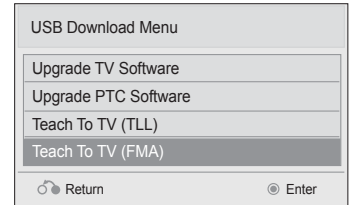

### Learning an FMA Configuration File from a TV

To ensure that Pro:Idiom decryption is enabled, it is recommended that you create an FMA Configuration file using the FTG Configuration Application as described on the previous page. However, if necessary, this option enables you to save (Learn) an FMA Configuration file from an LD310H TV to a USB memory device.

**Note:** If the LD310H TV is NOT already in FTG Mode, you may need to perform some manual configuration on the TV before you start this procedure (see following page).

1. Plug a USB memory device into the USB IN port on the TV.
2. Press **MENU** to display the TV setup menus, use the arrow navigation keys to select/highlight either the **Option** (if TV is in Pass-through Mode) or **Lock** (if TV is already in FTG Mode) menu icon, and then press the number “7” key a total of seven times to display the USB Download Menu.
3. To gain access to the Learn From TV options in the USB Download Menu, key in the password used to enter the Installer Menu (Example: Press **9-8-7-6**).
4. Use the Up/Down arrow keys to select **Learn From TV (FMA)**, and then press **ENTER**.
5. To identify the file from others, you can use the Up/Down arrow keys to change the last few digits of the filename. Press **ENTER** when you are ready to initiate Learning.

The TV will show Learning completion progress in a new window. Do NOT remove the USB device until Learning is complete. When Learning is complete, the USB Download Menu will reappear on screen.

6. When you are finished, remove the USB memory device.



**Note:** It is highly recommended that you open this FMA Configuration file in the FTG Configuration Application—BEFORE transferring (Teaching) the file to any TVs—to verify FTG Channel Map and FTG Installer Menu settings and enable Pro:Idiom decryption by marking Encrypted channels. This will also enable you to confirm and add channel attributes, labels, etc.

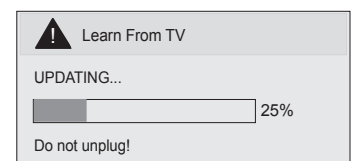
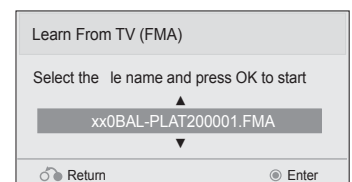
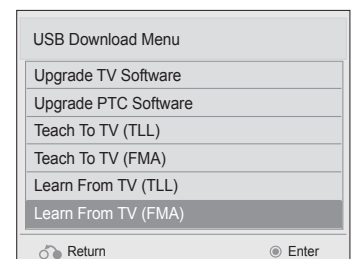

# FTG Mode of Operation (Cont.)

## Optional Manual Configuration / Setup for a TV

The manual configuration procedures below should only be performed if you do not know the RF channels at the site and need to Learn the FMA Configuration file from an LD310H TV.

### Set Installer Menu Items

These steps provide specific instruction only on the Installer Menu items that should be set on an LD310H TV. Refer to pages 14 to 20 for detailed information on all Installer Menu items.

1. Make sure the TV is ON. Then, use the Installer Remote to enter the TV Installer Menu: Press **MENU** repeatedly until the on-screen setup menus lock up, and then press **9-8-7-6 + ENTER**.
2. Set Installer Menu item **117 FACT DEFAULT** to **001** and press **ENTER** on the Installer Remote.

This clears all Installer Menu custom settings, the channel lineup, etc. and reloads the factory default settings. The value will change back to 0 after the internal TV controller (PTC) has been restored to factory default condition. This step ensures that the TV Channel Memory will be the active channel lineup.

3. Set Installer Menu item **003 BAND/ AFC**, as appropriate.
  - Broadcast: Set to 000.
  - HRC: Set to 002.
  - CATV: Set to 001 (default).
  - IRC: Set to 003.
4. Set any other Installer Menu items that affect your TV programming network to the required configuration. For example, enable/disable Aux sources, set a Start Channel, etc.
5. After you have adjusted all required Installer Menu item settings, press **ENTER** once on the Installer Remote to save your changes; then, press **ENTER** again to exit the menu.

### Run Auto Tuning (Channel Search)

**Note:** In the FMA Configuration file, Logical Channel numbers will automatically be assigned in ascending order, starting with 0 (zero), to the Physical Channels from the TV Channel Map.

**Note:** Pro:Idiom decryption for encrypted channels will not be enabled unless you use the FTG Configuration Application to set the channel attributes.

1. Search for all available analog and digital channels: Use the Installer Remote to go to the Channel Menu, select the **Auto Tuning** option, and follow the on-screen instructions.
2. Use the **Channel Edit** option in the Channel Menu to edit the channel lineup, as necessary, to include free to guest channels only. Add/delete channels per your system requirements. Note that physical channel numbers are used to identify virtual channels. Also, channel numbers cannot be higher than 255.

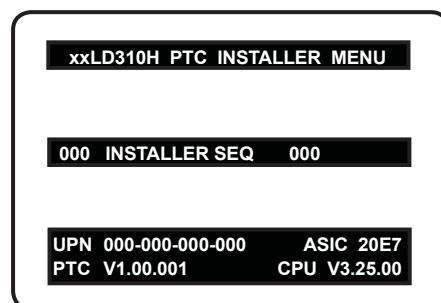

Typical TV Installer Menu

Note: The Installer Menu header will vary depending on the TV you are setting up.



Adjust the settings for these Installer Menu items.

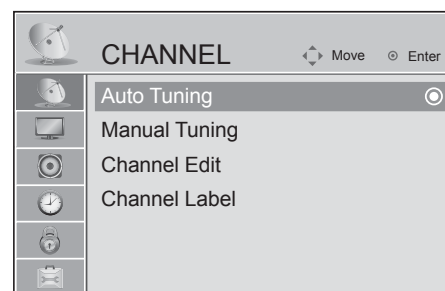

Run Auto Tuning and edit the channel lineup, as necessary.

# FTG Mode of Operation (Cont.)

## FTG Channel Map Configuration Utility Overview

The FTG Channel Map Configuration Utility enables you to build a Channel Map with logical channel numbers.

**Note:** Write, Read, and Learn functions in the FTG Channel Map Configuration Utility are used for local FTG configuration of TVs that support a direct connection to a PC. These functions are not applicable to the process of creating an FMA Configuration file to be used with LD310H TVs.

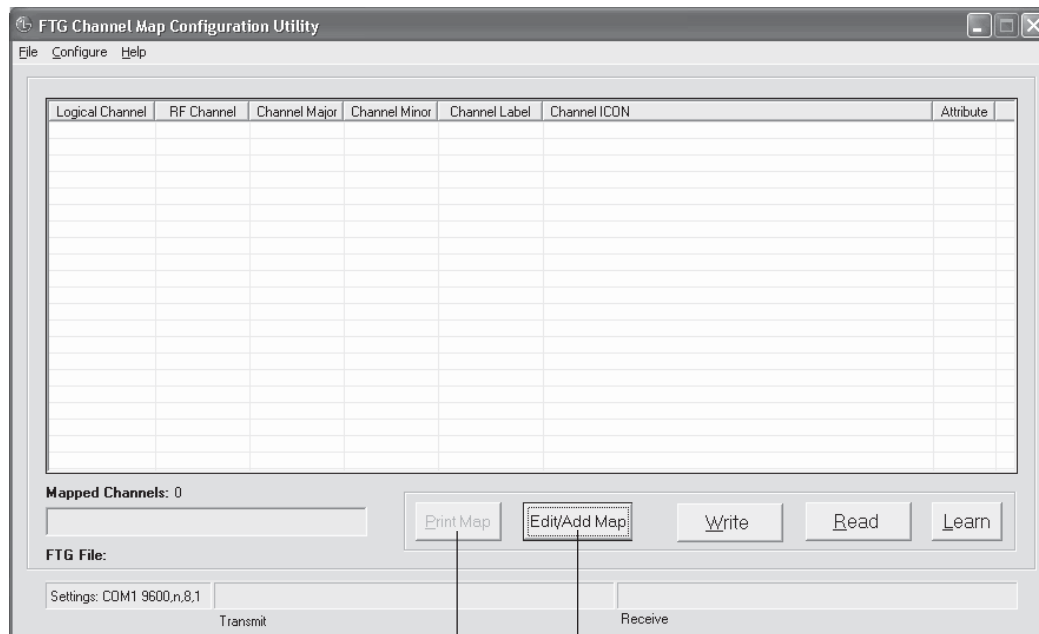

**PRINT MAP**  
Click to display a printable FTG Channel Map Report. The report can also be exported as an HTML or Text file.

**EDIT/ADD MAP**  
Click to open the FTG Channel Map Editor to create or edit an FTG Channel Map (see below).

# FTG Mode of Operation (Cont.)

## FTG Channel Map Editor Overview

The FTG Channel Map Editor shows a single Logical Channel's Data and the FTG Channel Map.

### LOGICAL CHANNEL MAPPING

Select a Logical Channel number, then assign it the RF, Major, and Minor channel numbers to complete the mapping.

### CUSTOM CHANNEL LABELS/ICONS

Enter custom labels and select icons by name on menu or by number.

### SET CHANNEL ATTRIBUTES

Check/select Encrypted, OSD, or Blank Video.

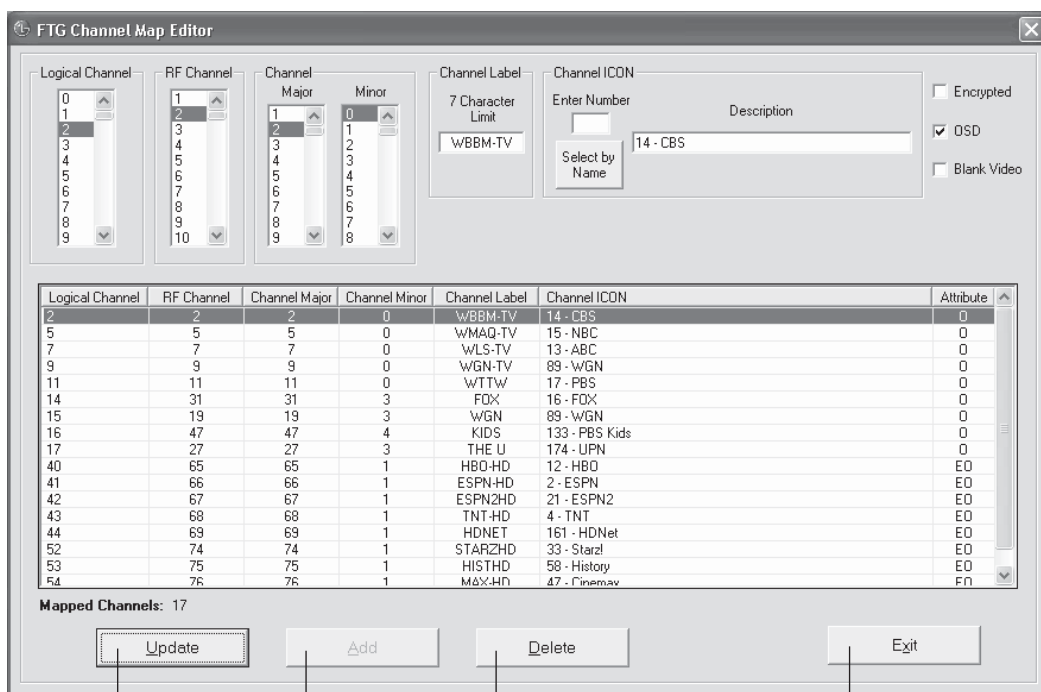

### UPDATE

After editing an existing Logical Channel's data, click to commit the changes in the FTG Channel Map.

### ADD

After defining a new Logical Channel, click to add channel to the FTG Channel Map.

### DELETE

Click to remove highlighted channel from FTG Channel Map.

### EXIT

Click to exit editor and return to FTG Channel Map Configuration Utility.

# FTG Mode of Operation (Cont.)

## FTG Installer Menu Configuration Utility Overview

**Note:** Write, Read, Learn, and IR Remote Access functions in the FTG Installer Menu Configuration Utility are used for local FTG configuration of TVs that support a direct connection to a PC. These functions are not applicable to the process of creating an FMA Configuration file to be used with LD310H TVs.

### CONFIGURATION SETTINGS

Select tabs for categories of Installer Menu items to set up TV.

### HOSPITAL-GRADE TV ONLY

Set Hospital items on Installer Menu for hospital-grade TVs.

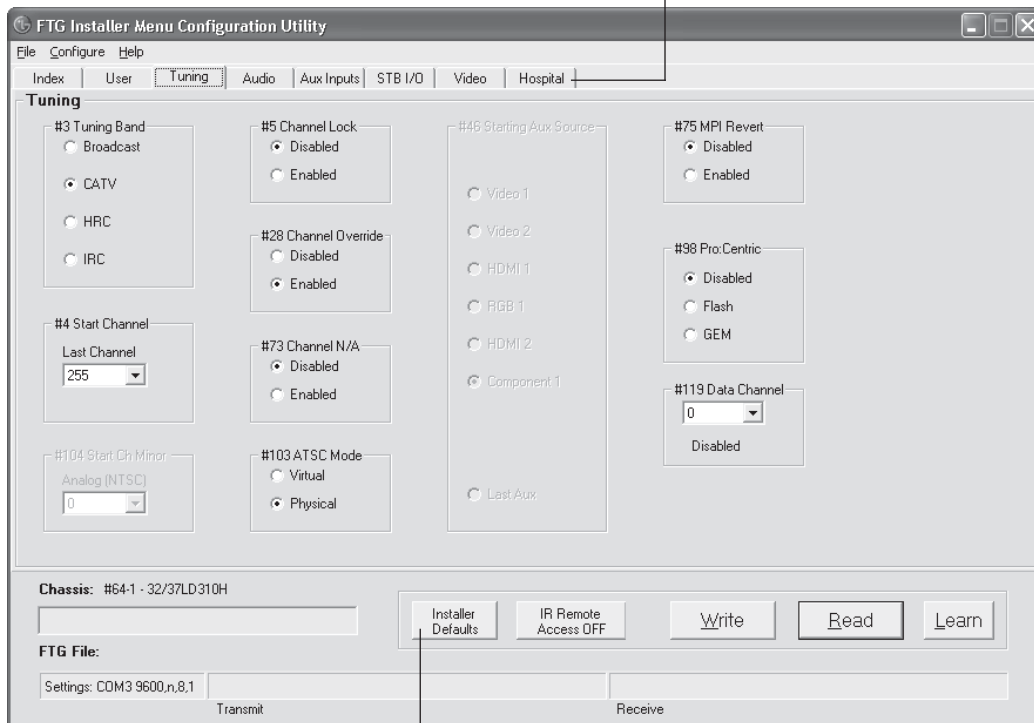

### INSTALLER DEFAULTS

Click to reset FTG Installer Menu items shown in the FTG Configuration Application to defaults.

# FTG Mode of Operation (Cont.)

## FMA Configuration Utility Overview

**Note:** FMA Write, Read, Clock, Broadcast, Firmware, and IP Communication functions in the FMA Configuration Utility are used to configure control equipment (Example: FMA-LG101) at the hotel/institution head end. These functions are not applicable to the process of creating an FMA Configuration file to be used with LD310H TVs.

**FMA CONFIGURATION LIST**  
(data to be saved or already saved in FMA Configuration file)

**NEW/OPEN/SAVE**  
FMA File options

Filename of opened FTG Configuration file (if applicable)

Copy FTG Channel Map to and from FMA Configuration List.

Copy FTG Installer Menu settings to and from FMA Configuration List.

Load default FTG Installer Menu for LD310H.

Item
17 Mapped Channels IM (Items Default) 32/37LD310H



**Note:** The data referenced in the FMA Configuration List is only a snapshot of the current FTG Channel Map and FTG Installer Menu settings when copied to the list. If you make any change(s) to the current data to be included in the FMA Configuration List, you will need to recopy Channel Map and Installer Menu settings to the FMA Configuration List.



# Reference: Upgrading TV/PTC Software using a USB Memory Device

## Checking the Software Versions

**Note:** This function is not accessible while the TV is in FTG or PPV Mode.

You can check the software versions of the TV by accessing the Installer Menu with the Installer Remote: Press **MENU** repeatedly until the on-screen setup menus lock up, and then press **9-8-7-6 + ENTER**. When you are finished, press **ENTER** again to exit the Installer Menu.

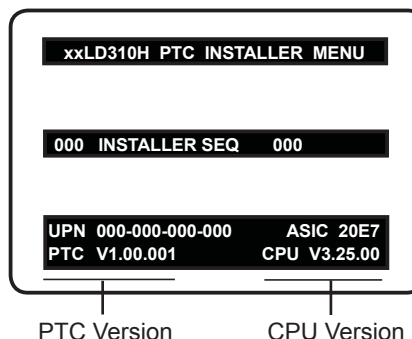

Typical Installer Menu

## Upgrading TV/PTC Software

Before you begin, note that the software upgrade files must be stored in a folder named "LG\_DTV" in the root directory of the USB memory device. Also, ensure the USB device has been formatted with FAT format.

**Note for TV Software Upgrade only:** If the TV detects a later version of software on the USB device, it will automatically display a dialog from which you can start the software upgrade immediately. Otherwise, you can close the dialog, and access the USB Download Menu as described below.

1. Turn the TV ON.
2. Plug the USB memory device into the USB IN port on the TV.
3. Press **MENU** on the Installer Remote to display the TV setup menus.
4. Use the arrow navigation keys to select/highlight either the **Option** (if TV is in Pass-through Mode) or **Lock** (if TV is in FTG or LodgeNet PPV Mode) menu icon; then, press the number "7" key a total of seven times to display the USB Download Menu.
5. Use the Up/Down arrow keys to select **Upgrade TV Software** or **Upgrade PTC Software**, as applicable, and then press **ENTER**.
6. Select the appropriate option(s), depending on the type of upgrade you are performing:
  - TV Software Upgrade: (See screen samples at right.) Select **TV Software Update** from the first TV Software Update window. In the second TV Software Update window, select the update file to install and press **ENTER**.  
**Note:** Do not select Forced Update options unless you have been specifically instructed to do so or have previous experience with Expert Software Updates.
  - PTC Software Upgrade: In the PTC Software Update window, select the update file to install and press **ENTER**.  
**Note:** The PTC Software Update window is similar to the second TV Software Update window, though there are no Forced Update options. Current software version information is shown at the top and update files on the USB device are listed at the bottom of the window.

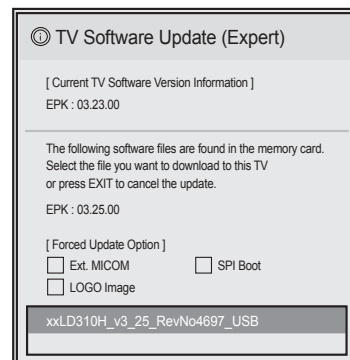
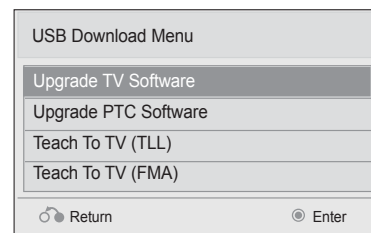

The TV will show update completion progress in a new window. Do NOT remove the USB device until the software upgrade is complete. When a TV software upgrade is complete, the TV will reset itself with an automatic restart. When a PTC upgrade is complete, the TV will turn OFF.

# Reference: Downloading a Splash Screen using a USB Memory Device

## Splash Screen Image File Guidelines

- The splash screen image must be a baseline (not progressive) JPEG.
- The image should be no larger than 1 MB.
- The ideal size for the image is 1366 x 768 pixels or under.
- The image file must be stored in a folder named “LG\_DTV” in the root directory of USB memory device.
- Ensure the USB device has been formatted with FAT format.

## Downloading a Splash Screen Image

1. Turn the TV ON.
2. Plug the USB memory device into the USB IN port on the TV.
3. Press **MENU** on the Installer Remote to display the TV setup menus.
4. Use the arrow navigation keys to select/highlight either the **Option** (if TV is in Pass-through Mode) or **Lock** (if TV is in FTG or LodgeNet PPV Mode) menu icon; then, press the number “7” key a total of seven times to display the USB Download Menu.
5. Use the Up/Down arrow keys to select **Upgrade TV Software**, and then press **ENTER**.
6. Select **LOGO Image Download** from the first TV Software Update window.
7. In the second TV Software Update window, select the image file to download and press **ENTER**.

The TV will show download completion progress in a new window. Do NOT remove the USB device until the image download is complete. When the image download is complete, the TV will reset itself with an automatic restart. Upon the restart, you should see the new splash screen.

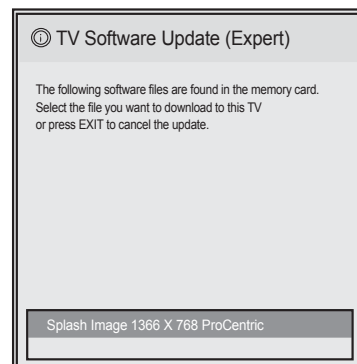
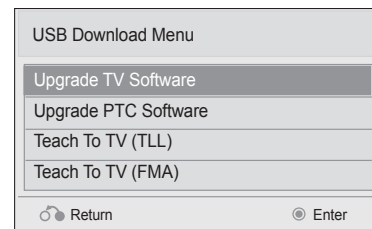

## Reference: Power Consumption Settings

The following tables assume Installer Menu item 099 BACK LIGHTING is set as shown below (default value is 100).

Item 099 Back Lighting (Static)	32LD310H		37LD310H	
	Power Consumption (Watts)	Percent Savings	Power Consumption (Watts)	Percent Savings
100	72.97	0.00%	88.92	0.00%
90	63.82	12.54%	84.19	5.32%
80	58.53	19.78%	77.84	12.46%
70	53.58	26.57%	72.19	18.81%
60	44.24	39.38%	66.28	25.46%
50	41.27	43.45%	60.90	31.51%
40	38.71	46.95%	56.58	36.37%
30	36.20	50.39%	52.35	41.13%
20	33.51	54.07%	47.75	46.30%
10	31.01	57.51%	43.68	50.88%
1	28.55	60.87%	39.62	55.44%

Item 099 Back Lighting (Dynamic)	32LD310H		37LD310H	
	Power Consumption (Watts)	Percent Savings	Power Consumption (Watts)	Percent Savings
200	75.45	0.00%	110.86	0.00%
190	69.23	8.25%	99.05	10.65%
180	65.26	13.51%	92.33	16.72%
170	60.72	19.53%	85.39	22.98%
160	56.29	25.40%	78.61	29.10%
150	51.82	31.33%	71.70	35.32%
140	46.62	38.21%	63.53	42.69%
130	41.67	44.78%	55.65	49.80%
120	36.14	52.10%	47.34	57.30%
110	31.11	58.76%	39.90	64.01%
101	26.41	65.00%	33.00	70.24%

Note: Values are results of controlled experiments under laboratory conditions.

# Reference: TV Camport Auto Sense Operation

The Camport Auto Sense function is enabled when:  
 1. Installer Menu item 034 CAMPORT EN is set to 1 AND  
 2. Installer Menu item 040 AUTO CAMPORT is enabled (1).

**Selectable:** Can be accessed with INPUT key, direct access, etc.

**Auto Sense:** TV switches to this input when connector is inserted. The Camport (Side [AV IN 2] Video) has the highest priority and will override any commands including tuning to the Start Channel.

## CAMPORT (Side Video) Functionality Control

Item 034 CAMPORT EN	Item 040 AUTO CAMPORT	Side (AV IN 2) Video Operation
0	0	Disabled
0	1	Disabled
1	0	Selectable
1	1	Auto Sense

### Campport Operation (Stand-alone)

When Campport Auto Sense is enabled as above, the TV's source will switch to the Side (AV IN 2) Video Aux source whenever a plug is inserted into the AV IN 2 Video input.

When the plug is removed, the TV will switch back to the previous channel or input source that was being displayed before the plug was inserted. However, if any direct access to an RF channel or Aux channel is requested while the Camport is active, then, when the video plug is removed, the TV will switch to the last requested channel. Source changes using any Source keys (INPUT) are ignored. Channel Up/Down and Flashback commands are not direct access tuning commands, and they are also ignored.

Previous State Before Inserting CAMPORT	Operation While CAMPORT is Active	State Upon Removal of CAMPORT
Aux or RF Channel	None	Previous Aux or RF Channel
Aux or RF Channel	Direct Access	Last Requested Aux or RF Channel
Aux or RF Channel	Ch Up/Down, Flashback, and Input Keys	Previous Aux or RF Channel

### Campport Operation (FTG or PPV)

The operation will be similar to that of the Stand-alone Mode. However, when the Channel Map is maintained external to the PTC (i.e., FTG and PPV), Channel Up/Down or Flashback keys are sent as Direct Access tuning commands to the PTC/TV.

Previous State Before Inserting CAMPORT	Operation While CAMPORT is Active	State Upon Removal of CAMPORT
Aux or RF Channel	None	Previous Aux or RF Channel
Aux or RF Channel	Direct Access	Last Requested Aux or RF Channel
Aux or RF Channel	Ch Up/Down, Flashback, and Input Keys	Last Requested Aux or RF Channel

# Reference: TV Aux Input Configuration

DIRECT ACCESS Tuning		TV		ENABLE				MPI DATA			START AUX SOURCE ASSIGNMENT
				Installer Menu		MPI DATA STATUS TYPE 0x41 SOURCES ENABLED (R/W)		DATA STATUS TYPE 0xD2 CURRENT AV SOURCE (R)		DATA STATUS TYPE 0x0D AUX SOURCE (R)	
OLD_OCV = 0	OLD_OCV = 1	Source Input	Source Mode	Number	Labeling	Value	Labeling	Value	Labeling		
130	90	Video2 (Side)	CV	34	CAMPORT_EN	0x01	Video Front (Camport)	0	Video Front (Camport)	0 (VIDEO)	2
131	91	Video1 (Rear)	CV	39	REAR_AUX_EN	0x02	Rear Video (Aux)	1	Rear Video (Aux)	0 (VIDEO)	1
132	92	HDMI2	DTV/PC	91	YPrPb2 EN = 1	0x04	S-Video Rear	2	S-Video Rear	0 (VIDEO)	5
133	93	HDMI1/DVI	DTV/PC	35	COMPPOINT_EN = 1	0x08	Front Computer	3	Front Computer	0 (VIDEO)	3
134	94	RGB	PC	87	REAR RGB EN = 2	0x10	SVGA Rear Computer	4	SVGA Rear Computer	2 (COMPUTER)	4
136	96	Component		38	YPrPb EN	0x40	Y/UV Component	6	Rear Y/PrPb Component Video	0 (VIDEO)	6

# Troubleshooting

## General Troubleshooting

---

### Some Quick and Easy Tips for Resolving Problems

Symptom	Possible Cause(s)	Possible Solution(s)
<b>Software Problems</b>		
Cannot direct enter channel number or “No Signal” appears.	Channel not included in channel lineup in TV controller.	After 2-5-5 + MENU, only channels included in TV controller will appear. If channel is available, it can be added to channel lineup. If it is not available, the “No Signal” message appears on the TV screen.
<b>Power</b>		
No power.	See troubleshooting flow chart on following page.	
<b>Display Panel Picture</b>		
No picture.	Display panel is turned off.	<ul style="list-style-type: none"><li>• Turn TV ON.</li><li>• Power failure?</li></ul>
	Antenna/cable not connected.	Connect antenna/cable signal to TV.
	Connections incorrect.	Check connections on TV.
	MPI not connected.	If applicable, connect MPI cable to MPI device.
	Encrypted program.	Try another channel.
Wrong tuning band.	Adjust Installer Menu settings.	
<b>Erratic Operation</b>		
Installer Menu setup.	Wrong Installer Menu settings.	Adjust Installer Menu settings as required.
<b>Installer Remote</b>		
Remote doesn't work.	Remote not in TV Mode.	Use MODE key to select “TV”; puts remote into TV Mode.
	Not aimed at IR remote sensor.	Point remote at TV's IR receiver on TV.
	Remote too far from IR sensor.	Move remote closer to TV's IR receiver or darken room.
	MPI not connected.	If applicable, connect MPI cable to MPI device.
	IR path to TV's receiver obstructed.	Remove obstructions.
	Weak batteries.	Replace batteries.
	Wrong battery polarity.	Check that “+” and “-” match in battery compartment.
	Too much light in room.	Dim room light.
Wrong Installer Remote.	Requires compatible Installer Remote. Contact your LG dealer.	
<b>Picture Reception</b>		
Normal picture, poor or no sound.	Audio muted.	Press MUTE or use Volume Up key to increase sound level.
	Broadcast problem.	Try a different channel.

**Note:** For other problems not caused by the TV, refer to the other devices' operating guide(s).

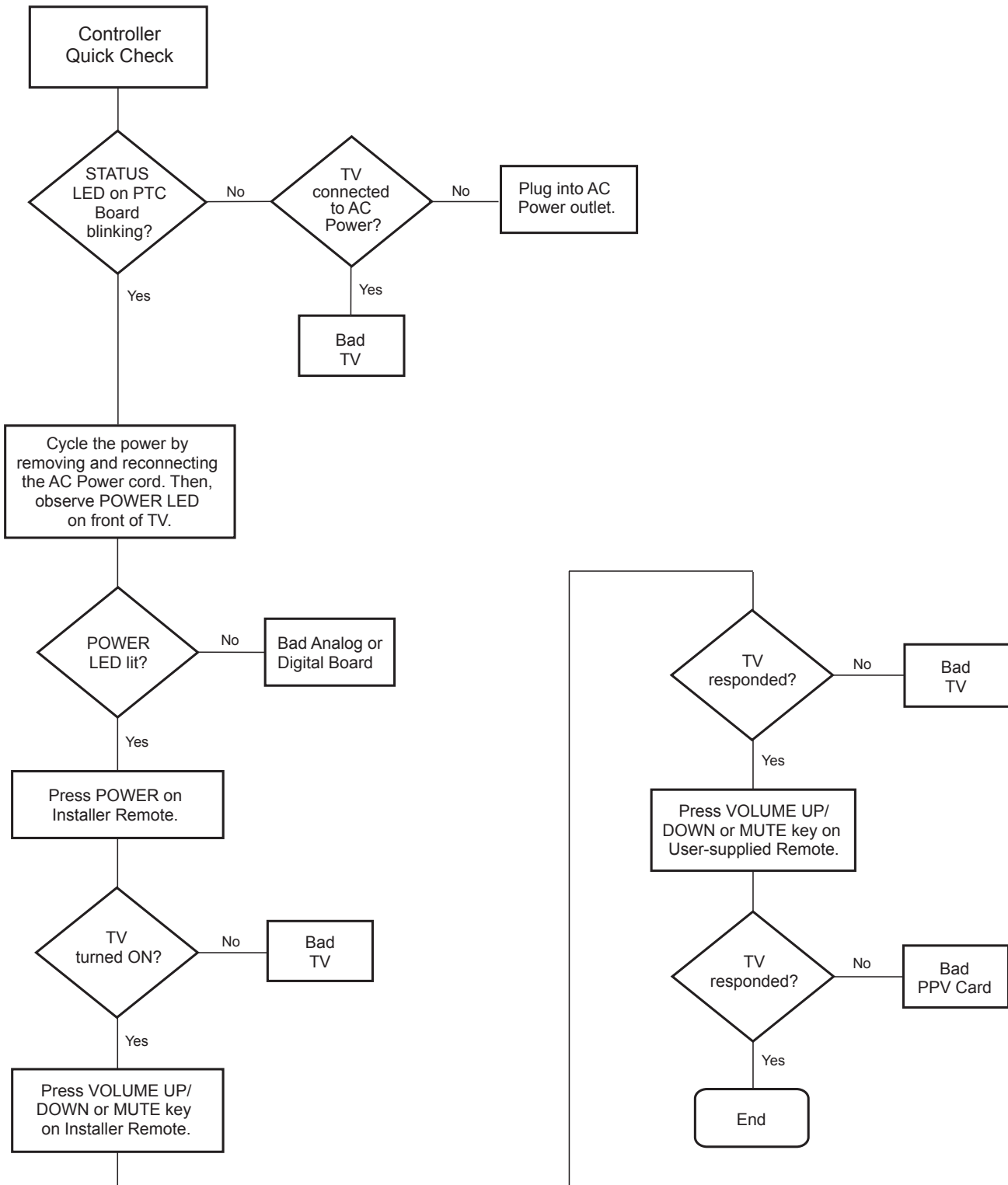

# Troubleshooting (Cont.)

## Commercial Mode Check / FTG Operation Troubleshooting

---

### Commercial Mode Check

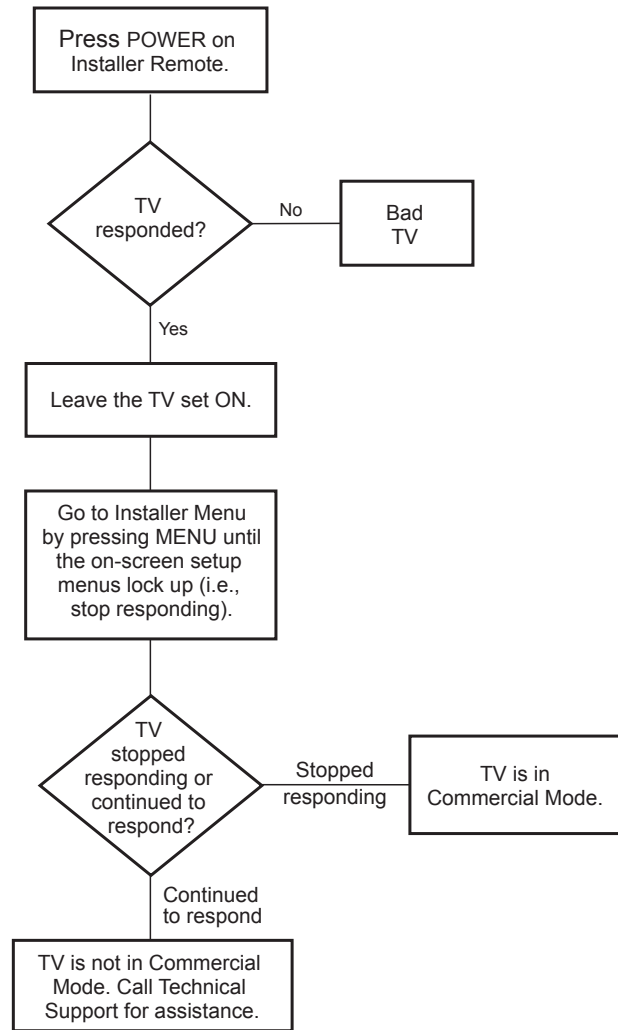

---

### FTG Operation Troubleshooting

The following table provides troubleshooting information for when the TV is configured in the FTG Mode of operation.

---

Symptom	Possible Cause(s)	Solution(s)
Communication Error ("Communications Timeout")	TV not powered. TV not turned ON.	Check/connect the TV power cord. TV needs to be turned ON (default FTG Mode).

---



## Clone Programmer Troubleshooting



**Warning: Do not connect a clone programmer to a PPV card installed in the Master or Target TVs, as this will damage the clone programmer and the PPV card.**

### Reset Clone Programmer After Static Shock

After replacing exhausted batteries (LT2002 only), or if the clone programmer behaves strangely after a static shock:

- TLL-1100A: Turn the TLL-1100A OFF and then ON.
- LT2002: Use a paper clip or similar instrument inserted through the small hole marked RESET to activate the internal reset switch and restore normal operation.

After a reset, check the real-time clock setting. It may be necessary to set the clone programmer clock from a TV containing the correct time.

### Notes

- The TLL-1100A and LT2002 clone programmers are designed to be used with TVs containing the 221-01006 and later processors. Use with earlier TVs may give unpredictable results. Processors used before the 221-01006-04 have a limited screen display capability; they cannot display entire screens as shown in the setup instructions accompanying the clone programmer. Use the printed menu illustrations in the documentation as an aid to making your programming choices.
- The Master and Target TVs must be in Pass-through Mode for cloning purposes. See also IMPORTANT CLONING INFORMATION on page 23.

Symptom	Possible Cause(s)	Possible Solution(s)
<b>Clone Programmer</b>		
Clone copies setup in less than 30 seconds.	Not enough time to copy entire TV setup.	TLL-1100A: Turn the TLL-1100A Off and then ON. LT2002: Press RESET on clone programmer. Then redo Learn/Teach. (Learning usually takes about 90 seconds; Teaching usually takes 3 to 4 minutes.)
Remote does not operate clone programmer.	Wrong Installer Remote.	Only use an LG Installer Remote to operate clone programmer with TV.
Clone menu does not display on TV screen, TLL-1100A shows error message, or LT2002 LED does not blink.	MPI cord not connected. TV not turned ON. (LT2002 only) Weak batteries. (TLL-1100A only) No charge.	Connect MPI cord properly, and ensure good connection. TV must be powered ON for clone programmer to work. Install four (4) fresh AA high-quality alkaline batteries. Ensure the TLL-1100A is fully charged or connected to AC power.
Clone menu hard to read.	Weak signal.	Connect TV to a reliable analog channel signal source.
No time set.	Time not available.	Set time on a TV, and copy time to clone programmer.
Clone not working.	Clone programmer problem.	<ul style="list-style-type: none"> <li>• Try a different clone programmer.</li> <li>• Reset the clone programmer.</li> </ul>
Clone scans channels more than once.	Clone should only scan channels once.	Ensure TV is set up correctly, and try cloning again.

### Master and Target TVs

Cloning did not work.	Procedure interrupted.	Wait until procedure complete message is displayed.
	Different TV models.	Cloning is only possible with identical model TVs.
	Step(s) omitted or not performed.	Refer to the applicable cloning procedure(s), and make sure all tasks were performed.
(LT2002 only) Clone time disappeared.	Batteries were removed.	Batteries must remain installed to retain time settings.
New setup not present.	Target TV not reset.	Disconnect Target TV from AC power for fifteen (15) seconds.

- After cloning operations are complete, unplug the TLL-1100A/LT2002 from the TV.
- If the TV does not display a picture (blank screen) after a few seconds, just change channels.

# Glossary of Terms

---

A list of definitions for some of the words found in this guide.

## **75 OHM RF CABLE**

The wire that comes from an off-air antenna or cable service provider. The end looks like a hex-shaped nut with a wire through the middle. It screws onto the Antenna/Cable threaded jack on the back of the TV.

## **300 TO 75 OHM ADAPTER**

A small device that connects a 2-wire 300 ohm antenna to a 75 ohm RF jack. It is usually about an inch long with two screws on one end and a round opening with a wire extending out the other end.

## **A/V CABLES**

Audio/Video cables. Three cables bunched together—right audio (red), left audio (white), and video (yellow). A/V cables are used for stereo playback of videocassettes and for higher quality picture and sound from other A/V devices.

## **A/V DEVICE**

Any device that produces video or sound (VCR, DVD, cable box, or television).

## **AMPLIFIER**

An electronic device that amplifies sound from a television, CD player, VCR, DVD player, or other Audio/Video device.

## **ANTENNA**

The physical receiver of television signals sent over the air. A large metal piece of equipment does not always have to be visible to be using an antenna.

## **CABLE**

Cable service box. Refers to the descrambler box cable subscribers use to receive cable programming signals.

## **CATV**

Programming provided by a cable service.

## **COMPONENT VIDEO**

Uses three wires for transporting three-color video signals. The end result is usually better video quality.

## **COMPOSITE VIDEO**

Typical video jack, uses one wire for transporting three-color video signals.

## **DELETE**

Lets you remove channels from the list that the end user can scroll through using Channel Up/Down.

## **DIGITAL TELEVISION**

High-resolution, cinema-quality television signals transmitted digitally.

## **DVI**

Digital Video Interface. Accommodates analog and digital interfaces with a single connector.

## **HDMI**

High-definition multi-media interface.

## **HDSTB**

High-definition set top box. Refers to a tuner device that receives high-definition television signals which have higher resolution than ordinary analog TV signals.

## **HDTV**

High-definition television. Refers to television signals that have higher resolution than ordinary analog TV signals.

## **INPUT**

Refers to the input jack that receives a signal from a TV, VCR, DVD Player or other Audio/Video device.

## **JACK**

An input or output connector on the back of a TV, VCR, DVD Player or other Audio/Video device.

## **MONO SOUND**

Mono (monaural) sound is one channel of sound. On more than one speaker, all the speakers play the same audio.

## **OUTPUT**

Refers to the output jack that sends a signal out of a VCR, DVD, or other A/V device.

## **PHYSICAL CHANNEL NUMBER**

The actual channel number. Analog channels use the Physical Channel number and digital channels can use a Virtual Channel number.

## **RGB (RED, GREEN, BLUE)**

Connection input or output port available for producing a video image using three separate colors: Red, Green, and Blue.

## **RS-232**

Serial communication port through which firmware is downloaded.

## **2ND AUDIO PROGRAMMING/SAP**

Second Audio Programming (SAP) is another, separate audio channel available with some programming. Choosing SAP often refers to listening to audio in another language, such as Spanish or French.

## **SIGNAL**

Picture and sound traveling through a cable, or over the air, to the TV.

## **STEREO SOUND**

Stereo (Stereophonic) sound refers to audio that's divided into right and left sides.

## **TUNER**

Device that picks up the broadcast signal and turns it into picture and sound.

## **VIRTUAL CHANNEL NUMBER**

A re-mapped channel number. Analog channels use the Physical Channel number; however digital channels use a Virtual (or false) Channel number.

## **XDS**

Extended Data Service. Additional program information included on the signal provided at the discretion of the broadcaster.

---

Note: Refer to [www.atsc.org](http://www.atsc.org) for further information.

## Document Revision History

Date	Description
January 2011	Revision A: New Document

Product documentation is available online at: [www.LGolutions.com/products](http://www.LGolutions.com/products). From the Products page, select **TVs, Systems & Solutions**, then **LCD TVs**, then the applicable TV. Click the **Literature & Downloads** tab at the bottom of the TV page, and select the required document(s) from the Downloads list.

---

## Notes



---

For Customer Support/Service, please call:

**1-888-865-3026**

[www.LGsolutions.com](http://www.LGsolutions.com)

Pro:Idiom is a registered trademark of Zenith Electronics LLC. Pro:Centric is a trademark of LG Electronics U.S.A., Inc. All other trademarks or registered trademarks are the property of their respective owners.



**26LD340H 32LD340H 37LD340H 42LD340H  
26LD345H 32LD345H 37LD345H 42LD345H**

**Lodging Guest Interactive Pro:Centric™ TVs**

---

## **Commercial Mode Setup Guide**

Note: Selected features shown in this guide may not be available on all models.

### **EXPERIENCED INSTALLER**

Commercial Mode Setup  
pages 12–13

Cloning Information  
pages 23–28

FTG Mode of Operation  
pages 29–39

For Customer Support/Service, please call:  
**1-888-865-3026**

The latest product information and documentation is available online at:  
**www.LG solutions.com/products**

MODEL and SERIAL NUMBER

The model and serial numbers of this TV are located on the back of the cabinet. For future reference, LG suggests that you record those numbers here:

Model No. \_\_\_\_\_ Serial No. \_\_\_\_\_



**WARNING:**

TO REDUCE THE RISK OF ELECTRIC SHOCK DO NOT REMOVE COVER (OR BACK). NO USER-SERVICEABLE PARTS INSIDE. REFER TO QUALIFIED SERVICE PERSONNEL.



The lightning flash with arrowhead symbol, within an equilateral triangle, is intended to alert the user to the presence of uninsulated “dangerous voltage” within the product’s enclosure that may be of sufficient magnitude to constitute a risk of electric shock to persons.



The exclamation point within an equilateral triangle is intended to alert the user to the presence of important operating and maintenance (servicing) instructions in the literature accompanying the appliance.

**WARNING:**

TO PREVENT FIRE OR SHOCK HAZARDS, DO NOT EXPOSE THIS PRODUCT TO RAIN OR MOISTURE.

**POWER CORD POLARIZATION:**

This product is equipped with a 3-wire grounding-type alternating current power plug. This plug will fit into the power outlet only one way. This is a safety feature. If you are unable to insert the plug fully into the outlet, contact your electrician to replace your obsolete outlet. Do not defeat the safety purpose of the 3-wire grounding-type plug.

**NOTE TO CABLE/TV INSTALLER:**

This reminder is provided to call the cable TV system installer’s attention to Article 820-40 of the National Electric Code (U.S.A.). The code provides guidelines for proper grounding and, in particular, specifies that the cable ground shall be connected to the grounding system of the building, as close to the point of the cable entry as practical.

**REGULATORY INFORMATION:**

This equipment has been tested and found to comply with the limits for a Class B digital device, pursuant to Part 15 of the FCC Rules. These limits are designed to provide reasonable protection against harmful interference when the equipment is operated in a residential installation. This equipment generates, uses and can radiate radio frequency energy and, if not installed and used in accordance with the instruction manual, may cause harmful interference to radio communications. However, there is no guarantee that interference will not occur in a particular installation. If this equipment does cause harmful interference to radio or television reception, which can be determined by turning the equipment off and on, the user is encouraged to try to correct the interference by one or more of the following measures:

- Reorient or relocate the receiving antenna.
- Increase the separation between the equipment and receiver.
- Connect the equipment to an outlet on a circuit different from that to which the receiver is connected.
- Consult the dealer or an experienced radio/TV technician for help.

**CAUTION:**

Do not attempt to modify this product in any way without written authorization from LG Electronics U.S.A., Inc. Unauthorized modification could void the user’s authority to operate this product.

**COMPLIANCE:**

The responsible party for this product’s compliance is: LG Electronics U.S.A., Inc.  
1000 Sylvan Avenue, Englewood Cliffs, NJ 07632, USA • Phone: 1-201-816-2000

Marketed and Distributed in the United States by LG Electronics U.S.A., Inc.  
1000 Sylvan Avenue, Englewood Cliffs, NJ 07632

# IMPORTANT SAFETY INSTRUCTIONS

1. Read these instructions.
2. Keep these instructions.
3. Heed all warnings.
4. Follow all instructions.
5. Do not use this apparatus near water.
6. Clean only with dry cloth.
7. Do not block any ventilation openings. Install in accordance with the manufacturer's instructions.
8. Do not install near any heat sources, such as radiators, heat registers, stoves, or other apparatus (including amplifiers) that produce heat.
9. Do not defeat the safety purpose of the polarized or grounding-type plug. A polarized plug has two blades with one wider than the other. A grounding-type plug has two blades and a third grounding prong. The wide blade or the third prong are provided for your safety. If the provided plug does not fit into your outlet, consult an electrician for replacement of the obsolete outlet.
10. Protect the power cord from being walked on or pinched, particularly at plugs, convenience receptacles, and the point where it exits from the apparatus.
11. Only use attachments/accessories specified by the manufacturer.
12. Use only with the cart, stand, tripod, bracket, or table specified by the manufacturer or sold with the apparatus. When a cart is used, use caution when moving the cart/apparatus combination in order to avoid injury from tip-over.



PORTABLE CART WARNING

13. Refer all servicing to qualified service personnel. Servicing is required when the apparatus has been damaged in any way, such as power-supply cord or plug is damaged, liquid has been spilled or objects have fallen into the apparatus, the apparatus has been exposed to rain or moisture, does not operate normally, or has been dropped.
14. Never touch this apparatus or antenna during a thunder or lightning storm.
15. When mounting a TV on the wall, make sure not to install the TV by the hanging power and signal cables on the back of the TV.
16. Do not allow an impact shock or any objects to fall into the product, and do not drop objects onto the screen.

## 17. Power Cord

**Caution: It is recommended that appliances be placed upon a dedicated circuit; that is, a single outlet circuit which powers only that appliance and has no additional outlets or branch circuits. Check the specification page of the Owner's Manual to be certain.**

Periodically examine the cord of your appliance, and if its appearance indicates damage or deterioration, unplug it, discontinue use of the appliance, and have the cord replaced with an exact replacement part by an authorized servicer. Protect the power cord from physical or mechanical abuse, such as twisting, kinking, or pinching or being closed in a door or walked upon. Pay particular attention to plugs, wall outlets, and the point where the cord exits the appliance.

Do not use a damaged or loose power cord. Be sure to grasp the plug when unplugging the power cord. Do not pull on the power cord to unplug the TV.

## 18. Overloading

Do not connect too many appliances to the same AC power outlet as this could result in fire or electric shock. Do not overload wall outlets. Overloaded wall outlets, loose or damaged wall outlets, extension cords, frayed power cords, or damaged or cracked wire insulation are dangerous. Any of these conditions could result in fire or electric shock.

## 19. Outdoor Use/Wet Location

 **Warning: To reduce the risk of fire or electrical shock, do not expose this product to rain, moisture or other liquids.**

Do not touch the TV with wet hands. Do not install this product near flammable objects such as gasoline or candles or expose the TV to direct air conditioning.

Do not expose to dripping or splashing and do not place objects filled with liquids, such as vases, cups, etc., on or over the apparatus (e.g., on shelves above the unit).

## 20. Grounding

Ensure that you connect the earth ground wire to prevent possible electric shock (i.e., a TV with a three-prong grounded AC plug must be connected to a three-prong grounded AC outlet). If grounding methods are not possible, have a qualified electrician install a separate circuit breaker. Do not try to ground the unit by connecting it to telephone wires, lightning rods, or gas pipes.

## 21. Disconnect Device

The mains plug is the disconnecting device. The plug must remain readily operable.

As long as this unit is connected to the AC wall outlet, it is not disconnected from the AC power source even if you turn off this unit by SWITCH.

(Continued on next page)

# IMPORTANT SAFETY INSTRUCTIONS

(Continued from previous page)

## 22. Outdoor Antenna Grounding

If an outside antenna or cable system is connected to the product, follow the precautions below.

An outdoor antenna system should not be located in the vicinity of overhead power lines or other electric light or power circuits or where it can come into contact with such power lines or circuits as death or serious injury can occur.

Be sure the antenna system is grounded so as to provide some protection against voltage surges and built-up static charges.

Article 810 of the National Electrical Code (NEC) in the U.S.A. provides information with respect to proper grounding of the mast and supporting structure, grounding of the lead-in wire to an antenna-discharge unit, size of grounding conductors, location of antenna-discharge unit, connection to grounding electrodes, and requirements for the grounding electrode.

### Antenna Grounding According to NEC, ANSI/NFPA 70

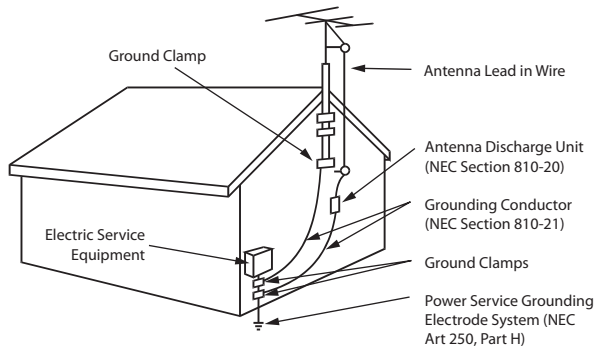

## 23. Cleaning

When cleaning, unplug the power cord and rub gently with a soft cloth to prevent scratching. Do not spray water or other liquids directly on the TV as electric shock may occur. Do not clean with chemicals such as alcohol, thinners or benzene.

## 24. Transporting Product

Make sure the product is turned Off and unplugged and that all cables have been removed. It may take two or more people to carry larger TVs. Do not press against or put stress on the front panel of the TV.

## 25. Ventilation

Install the TV where there is proper ventilation. Do not install in a confined space such as a bookcase. Do not cover the product with cloth or other materials (e.g., plastic) while it is plugged in. Do not install in excessively dusty places.

26. Do not touch the ventilation openings, as they may become hot while the TV is operating.

27. If you smell smoke or other odors coming from the TV or hear strange sounds, unplug the power cord, and contact an authorized service center.

28. Do not press strongly on the panel with a hand or sharp object (e.g., a nail, pencil, or pen) or make a scratch on it.

29. Keep the product away from direct sunlight.

## 30. Dot Defect

The Plasma or LCD panel is a high technology product with resolution of two million to six million pixels. In a very few cases, you could see fine dots on the screen while you're viewing the TV. Those dots are deactivated pixels and do not affect the performance and reliability of the TV.

## 31. Generated Sound

"Cracking": A cracking noise that occurs while the TV is On or when it is turned Off is generated by plastic thermal contraction due to temperature and humidity. This noise is common for products where thermal deformation is required.

Electrical circuit humming/panel buzzing: A low level noise is generated from a high-speed switching circuit, which supplies a large amount of current to operate a product. It varies depending on the product. This generated sound does not affect the performance and reliability of the product.

## 32. For LCD TV

If the TV feels cold to the touch, there may be a small "flicker" when it is turned On. This is normal; there is nothing wrong with TV. Some minute dot defects may be visible on the screen, appearing as tiny red, green, or blue spots. However, they have no adverse effect on the monitor's performance. Avoid touching the LCD screen or holding your finger(s) against it for long periods of time. Doing so may produce some temporary distortion effects on the screen.



# Table of Contents

---

Safety Warnings . . . . .	2	<b>FTG Mode via EBL</b> . . . . .	35
Important Safety Instructions . . . . .	3–4	FTG Configuration Application Utilities Overview . . . . .	36–39
Table of Contents . . . . .	5	FTG Channel Map Configuration Utility . . . . .	36
Setup Checklist / Commercial Mode Setup Overview . . . . .	6	FTG Channel Map Editor . . . . .	37
Pro:Centric TV Interactive Menu Features . . . . .	7	FTG Installer Menu Configuration Utility . . . . .	38
LD340H/LD345H Rear Jack Panel . . . . .	8	FMA Configuration Utility . . . . .	39
Side Connections Panel / RF Antenna Connection . . . . .	9	Remote Jack Pack / TV Connections & Setup . . . . .	40
Installer Overview . . . . .	10	<b>References</b>	
Installer Remote Control Typical Key Functions . . . . .	11	Upgrading TV/PTC Software using a USB Memory Device . . . . .	41
<b>Commercial Mode Setup for Master TV</b> . . . . .	12–13	Downloading a Splash Screen using a USB Memory Device . . . . .	42
<b>Installer Menu</b> . . . . .	14–20	Power Consumption Settings . . . . .	43
TV Setup Menus Overview . . . . .	21	TV Camport Auto Sense Operation . . . . .	44
Adding Channel Icons / Custom Channel Labels (2-5-4 + MENU Mode) . . . . .	22	TV Aux Input Configuration . . . . .	45
<b>Cloning Overview / Clonable Menu Features</b> . . . . .	23	<i>b</i> -LAN Setup & Overview . . . . .	46
<b>Cloning Procedures</b> . . . . .	24–28	RJP Model List and Input Auto-sensing Hierarchy . . . . .	47
Learning / Teaching a Master TV Setup using a USB Memory Device . . . . .	24	Resetting a TV to Pass-through Mode . . . . .	48
Learning / Teaching a Master TV Setup using a TLL-1100A Clone Programmer . . . . .	25	Troubleshooting . . . . .	49–52
Learning / Teaching a Master TV Setup using an LT2002 Clone Programmer . . . . .	27	General Troubleshooting . . . . .	49
<b>FTG Mode of Operation Overview</b> . . . . .	29–30	Troubleshooting Flow Chart . . . . .	50
FTG Mode via CPU or EBL . . . . .	29	Commercial Mode Check / FTG Operating Troubleshooting . . . . .	51
Determining the TV Operating Mode . . . . .	30	Clone Programmer Troubleshooting . . . . .	52
<b>FTG Mode via CPU</b> . . . . .	31–34	Glossary of Terms . . . . .	53
Creating an FMA Configuration File using the FTG Configuration Application . . . . .	31	Document Revision History / Notes . . . . .	54
Teaching FMA Configuration to a TV . . . . .	32	Back Cover . . . . .	55
Learning an FMA Configuration File from a TV . . . . .	33		
Optional Manual Configuration / Setup for a TV . . . . .	34		

---

## Notes

- Installer Menu content is intended for use primarily by qualified TV electronics technicians.
- Refer to the Owner's Manual for additional information on TV features, specifications, maintenance, and safety instructions.
- For additional information, contact your LG representative.

Note: Design and specifications subject to change without prior notice.

# Setup Checklist / Overview

---

## Setup Checklist

### Installation and Setup Checklist

- \_\_\_ Unpack TV and all accessories.
  - \_\_\_ Install batteries in remote control.
  - \_\_\_ Install TV on VESA mount or stand.
- Note:** It may be advisable to make all cable connections before installing on VESA mount or stand, as appropriate.

### Hardware Connections

- \_\_\_ Install any additional hardware as appropriate to your institution, LAN, etc.

### Cable Connections

- \_\_\_ Make all connections to rear jack panel and RF antenna on MPI/PPV card.
- \_\_\_ Make all connections to signal, interactive resources, and Aux sources, as appropriate.

### Commercial Mode Setup

- \_\_\_ Complete Commercial Mode Setup (configure all relevant Installer Menu items as required of your institution and configure display features for the end user).

### Software Installation

- \_\_\_ Install or configure any software, as applicable, for example, PPV, etc.

---

## Commercial Mode Setup Overview

This document describes how to set up LD340H and LD345H Pro:Centric™ TVs for Commercial Mode while the TV/Embedded *b*-LAN™ (EBL) module is in either Pass-through Mode or Free-To-Guest (FTG) Mode.

**Note:** The *b*-LAN module is internal to the TV and allows hotel/institution head end equipment with *b*-LAN technology to communicate with the TV for configuration and control. See Reference section, “*b*-LAN Setup & Overview,” for further information.

### Pass-through Mode

This mode allows you to configure a Master TV Setup for cloning purposes as well as external VOD/PPV control. Use the Installer Remote to configure Installer Menu items as required for TV operation and set up TV features (Channel, Picture, Audio, etc.). See pages 12 to 13 for detailed information.

### FTG Mode

This mode enables Pro:Idiom® decryption and also allows logical channel mapping of physical channels to remove the need for dash tuning. FTG Configuration Application software is used to configure and/or edit FTG Channel Map and FTG Installer Menu settings. With the LD340H/LD345H models, there are two separate and distinct methods for configuring the TVs for the FTG Mode of operation. See pages 29 to 39 for information on FTG Mode options and using the FTG Configuration Application.

# Pro:Centric TV Interactive Menu Features



**Important: Pro:Centric operation requires that Installer Menu items 098 PRO:CENTRIC and 119 DATA CHANNEL be set appropriately and that the TV be in PPV or FTG Mode.**

The interactive Pro:Centric TV enables guests—from the comfort of their hotel rooms—to view and select from a complete listing of hotel services and amenities. The Pro:Centric TV is connected to the hotel's billing computer, and service/amenities charges are billed at the time of order.

Interactive amenities may include:

- Hotel information, news, and events
- Directory services (tourist attractions, restaurants, etc.)
- Reservation services (business meetings, fitness, spa, etc.)
- Weather and traffic information
- Shopping services (delivery to guest room)
- Room service (menu ordering, memo service, morning wake up call, laundry, etc.)
- Ticketing services
- Check-out service (in the guest room)
- Gaming services
- E-mail resources/account access

Use the Installer Remote to operate both interactive menus and regular TV features. Press **PORTAL** on the Installer Remote to access the interactive menus.

**Note:** Interactive menu options may vary, depending on Pro:Centric features enabled for the site. The following are default interactive menus.

## Channel Guide

Shows available TV networks and channels. When available, electronic program guide (EPG) data indicates the channel and the program start and finish times.

## Information

Typically displays hotel information, for example, photos of guest rooms, dining rooms, business centers, facilities, etc., as well as information on local weather and attractions. Information may also include resources, such as local school programs, run in cooperation with the hotel.

## Help

Provides help for navigating the interactive menus.

## Watch TV

Removes the interactive menu from the screen and returns to the previously tuned TV channel.

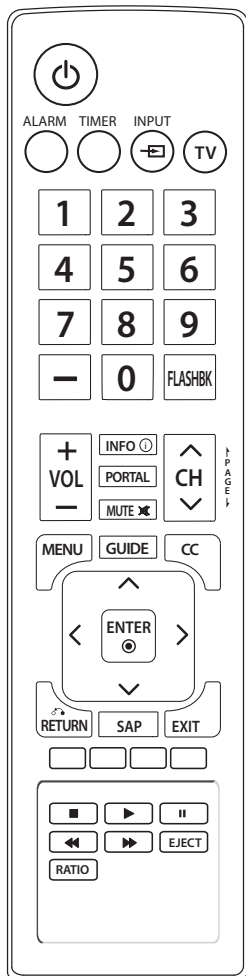

# LD340H/LD345H Rear Jack Panel

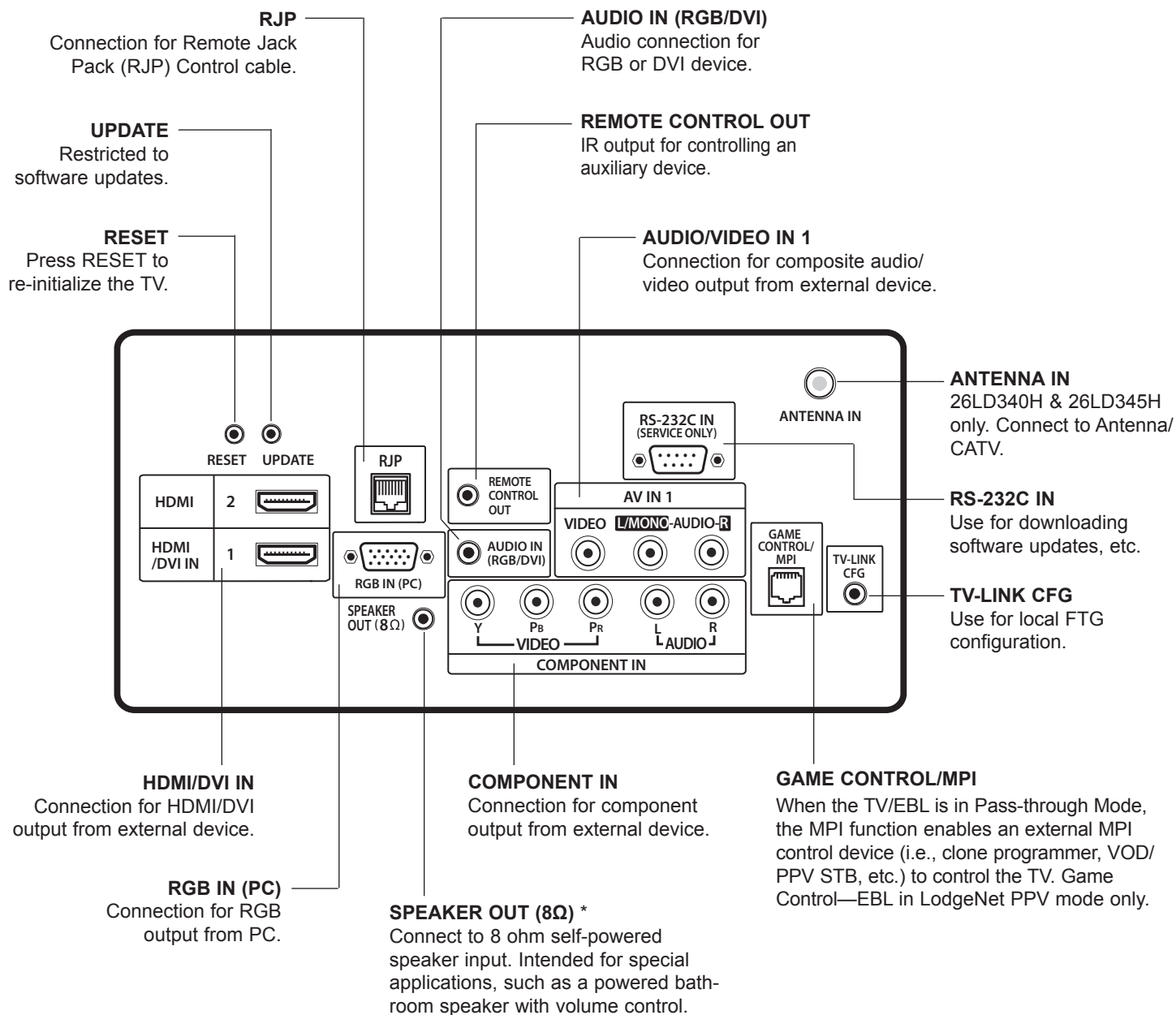

\* This stereo jack provides a mono speaker fixed-level, 1 watt output (audio +, audio -, w/ground shield). Do NOT plug in a mono connector, as this may damage the TV.

# Side Connections Panel / RF Antenna Connection

## Side Connections Panel

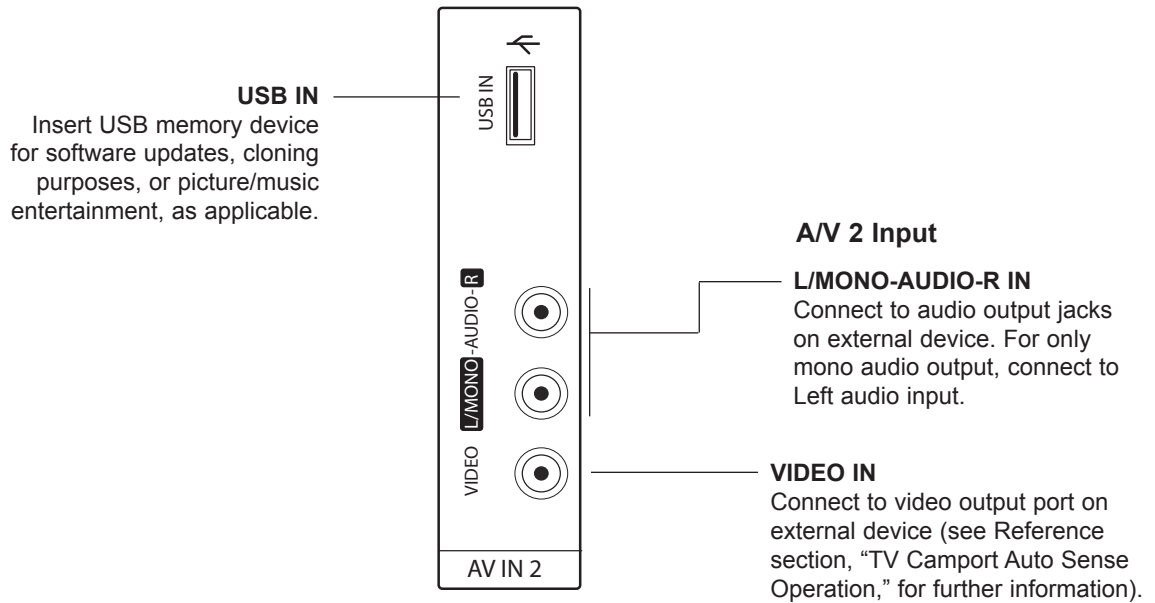

## RF Antenna Connection

(32/37/42LD340H and 32/37/42LD345H TVs)

**Note:** 26LD340H and 26LD345H Antenna connections are on the rear jack panel (see previous page).

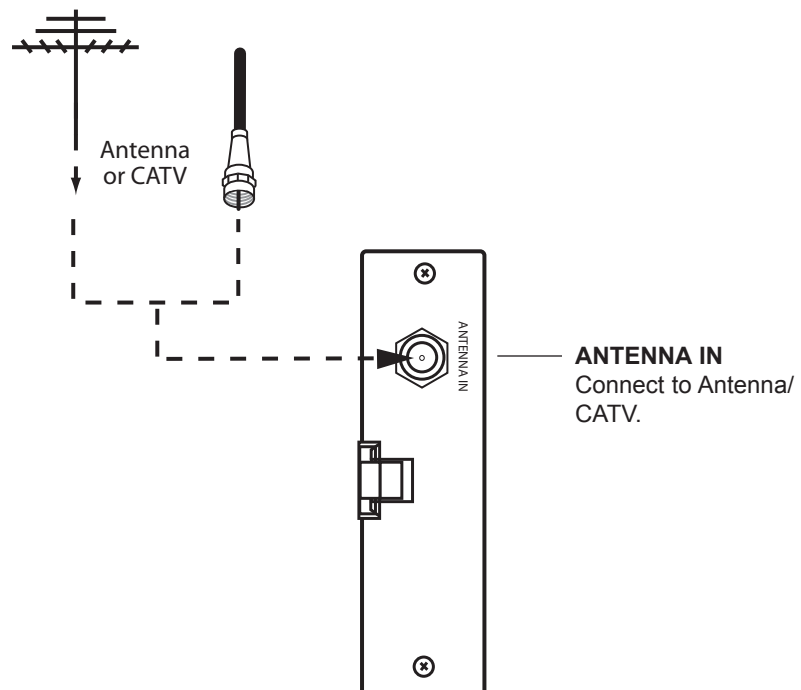

# Installer Overview

This is the Commercial Mode Setup Guide only.

## Installer Menu / Commercial Mode Setup

To set up a Master TV for cloning purposes, you will need to know how to enter the TV Installer Menu and make changes to the default values as required. Similarly, to configure a TV's Installer Menu settings in FTG Mode, you will need to know how to access and use the FTG Configuration Application utilities. If necessary, familiarize yourself with the Installer Menu and how to make and save changes. Refer to page 14 for information on accessing the Installer Menu in Pass-through Mode. Pages 15 to 20 describe Installer Menu items in detail. Refer to pages 29 to 39 for information on entering FTG Mode and using the FTG Configuration Application utilities.

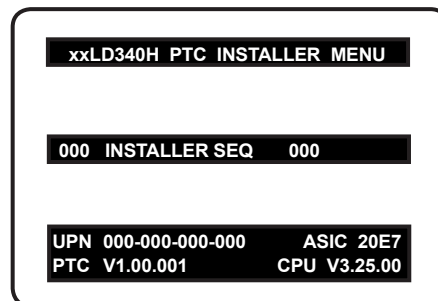

Typical Installer Menu

## Installer Remote

The LG Installer Remote is supplied with and dedicated to operate the TV. See next page for typical key functions in TV operating mode. Some DVD and VCR controls may be available for selected LG DVD/VCR products.

## Cloning

Cloning refers to the process of capturing a Master TV Setup and transferring it to a Target TV. The Master TV's clonable features need to be configured as part of the Commercial Mode Setup. This is a critical step. If the Master TV's clonable features—channel icons or labels, digital font options, etc.—are not set up correctly, the cloned TVs will all have problems. Pages 23 to 28 provide detailed information on cloning requirements and procedures.

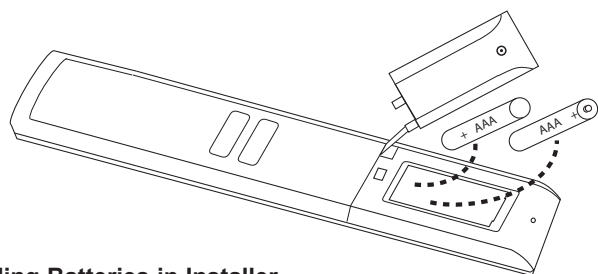

### Installing Batteries in Installer Remote

- Open the battery compartment cover on the back side of the remote.
- Install two high-quality alkaline 1.5V AAA batteries. Never mix old or used batteries with new ones. Install batteries matching correct polarity as shown (+ with + and - with -).
- Replace the battery compartment cover.

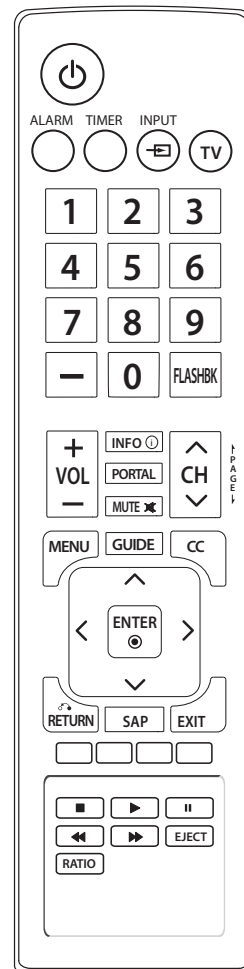

# Installer Remote Control Typical Key Functions

The LG Installer Remote illustrated below and throughout this document shows typical remote control functions and is provided for reference only. This Installer Remote may vary from the Installer Remote supplied with the TV.

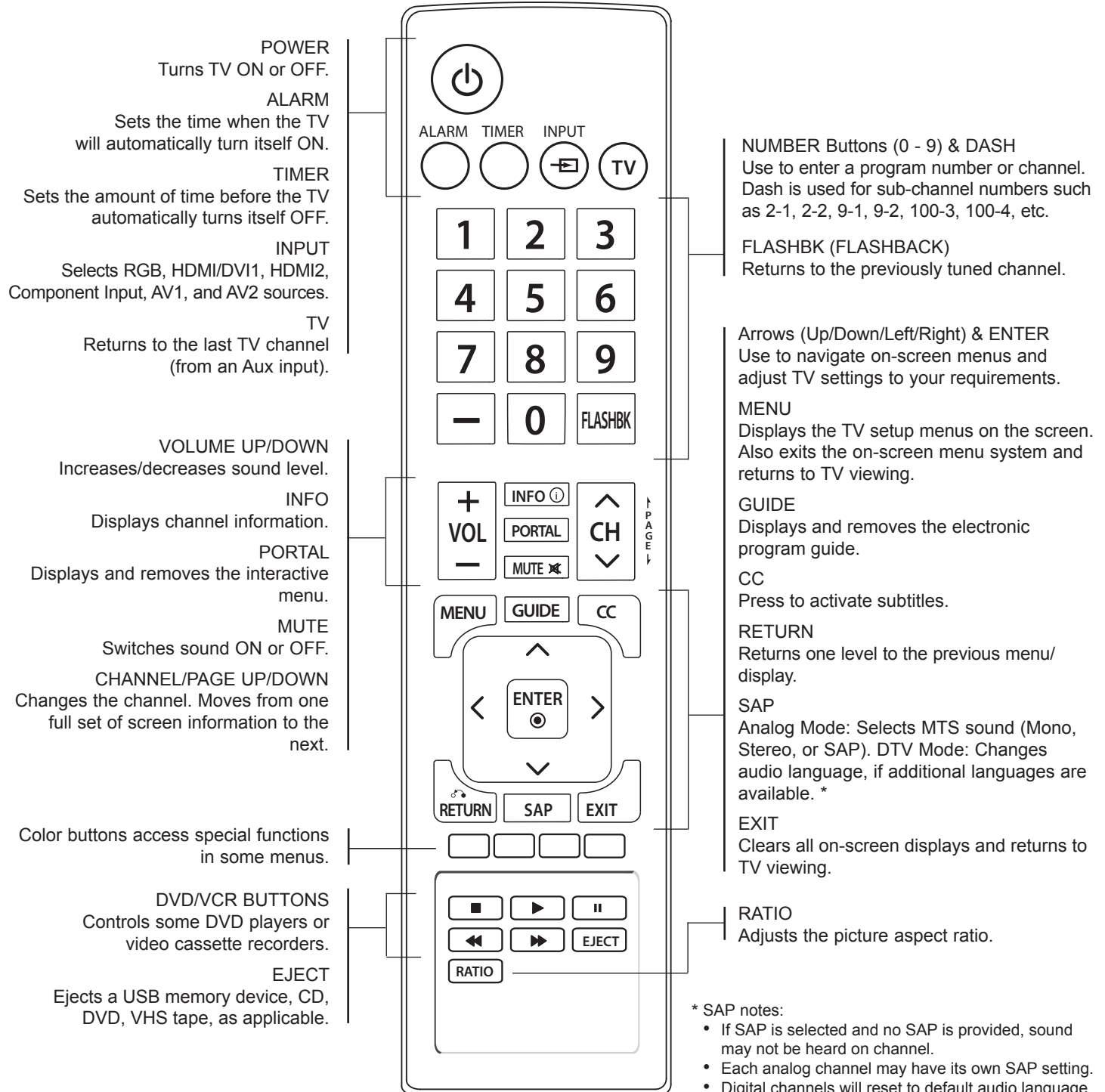

\* SAP notes:

- If SAP is selected and no SAP is provided, sound may not be heard on channel.
- Each analog channel may have its own SAP setting.
- Digital channels will reset to default audio language with a power off/on.

# Commercial Mode Setup for Master TV

This section describes how to set up a Master TV for cloning purposes when the TV is in Pass-through Mode.

**Note:** Disconnect all Aux inputs. Under certain conditions, Auto Tuning (Channel Search) is disabled if there is an Aux input active.

**Note:** Refer to FTG Mode information on pages 29 to 39 for details on entering FTG Mode and configuring/editing FTG Channel Map and FTG Installer Menu settings using the FTG Configuration Application.

## 1. Set Installer Menu items.

This step provides specific instruction only on the Installer Menu items that should be set on a Master TV. Refer to pages 14 to 20 for detailed information on all Installer Menu items.

- a) Make sure the TV is ON. Then, use the Installer Remote to enter the TV Installer Menu: Press **MENU** repeatedly until the on-screen setup menus lock up, and then press **9-8-7-6 + ENTER**.
- b) Set Installer Menu item **117 FACT DEFAULT** to **001** and press **ENTER** on the Installer Remote.

This clears all Installer Menu custom settings, channel lineup, etc. and reloads the factory default settings. The value will change back to 0 after the internal TV controller (Protocol Translator Card [PTC]) has been restored to factory default condition. This step ensures that the TV Channel Memory will be the active channel lineup.

- c) Set Installer Menu item **003 BAND/AFC**, as appropriate.
  - Broadcast: Set to 000.
  - CATV: Set to 001 (default).
  - HRC: Set to 002.
  - IRC: Set to 003.
- d) Set any other Installer Menu items that affect your TV programming network to the required configuration. For example, enable/disable Aux sources, set a Start Channel, etc.
- e) After you have adjusted all required Installer Menu item settings, press **ENTER** once on the Installer Remote to save your changes; then, press **ENTER** again to exit the menu.

## 2. Set up TV features.

On-screen setup menus control the features of the TV (see page 21). Press **MENU** on the Installer Remote to access the setup menus, and then set Channel, Picture, Audio, Lock, Time, etc. options to the desired configurations. See also the Clonable Menu Features list on page 23.

**Note:** If desired, you can run Auto Tuning (see step 3) prior to completing this step.

## 3. Run Auto Tuning (Channel Search).

- a) Search for all available analog and digital channels: Go to the Channel Menu, select the **Auto Tuning** option, and follow the on-screen instructions.

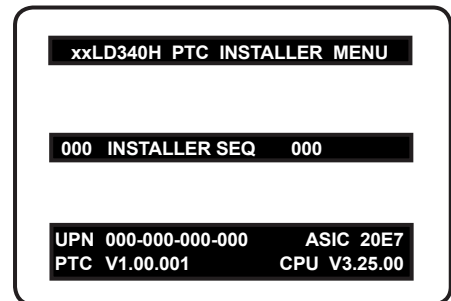

Typical TV Installer Menu

Note: The Installer Menu header will vary depending on the TV you are setting up.

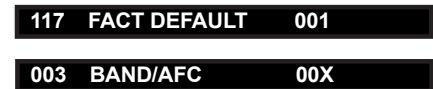

Adjust the settings for these Installer Menu items.

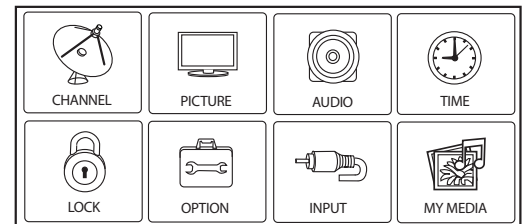

Set the TV features to the desired configuration for the end user.

(Continued on next page)



# Commercial Mode Setup for Master TV (Cont.)

(Continued from previous page)

## 3. Run Auto Tuning (Channel Search). (continued)

- b) Use the **Channel Edit** option in the Channel Menu to edit the channel lineup, as necessary, to include free to guest channels only.
- Add/delete channels per your system requirements. Note that if Installer Menu item 103 ATSC TUNE MODE is set for Physical Channel tuning (default and recommended setting), channels with minor channel numbers higher than 255 will not transfer correctly in step 4. If it is set for Virtual Channel tuning and either the major or minor channel numbers are higher than 255, the channel(s) will not transfer correctly in step 4.
  - Use the **Channel Label** option in the Channel Menu to add familiar channel trademarks/logos such as ABC, CBS, NBC, etc. to the Channel-Time on-screen display. Identifiable labels (logos) should enable the end user to readily know what common networks are available. (You can add the channel labels in this step, or you can add channel labels or logos for channels without icons in step 5.)

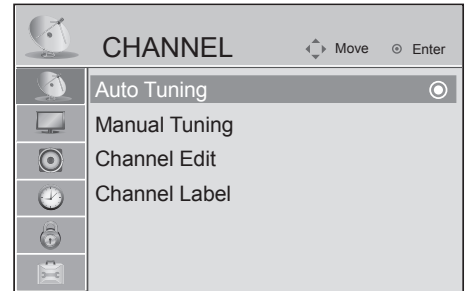

Run Auto Tuning, edit channels, and select familiar channel trademarks/logos using Channel Menu options.

## 4. Transfer the TV Setup to the internal TV Controller (PTC):

### 2-5-5 + MENU Mode

After the TV channel lineup has been edited and channel label icons added, enter the Installer Menu. Once in the Installer Menu, press **2-5-5 + MENU** on the Installer Remote to initiate the transfer of the Master TV Setup to the PTC. The TV exits the Installer Menu and then tunes through the channels in the channel lineup during the transfer. When the transfer is complete, the TV tunes back to the channel that was tuned before the transfer began.

**Note:** The maximum number of active channels that can be transferred is 141. An attempt to transfer more than 141 channels will result in erratic TV tuning operation.

## 5. Add Custom Channel and Aux Source Labels for Analog

### Channels: 2-5-4 + MENU Mode

Enter the Installer Menu, and press **2-5-4 + MENU** on the Installer Remote. Add/edit custom text labels to channel on-screen displays. Note that digital channels often have a broadcaster generated label (see 2-5-4 + MENU procedural information on page 22). When you are finished, press **MENU** to exit 2-5-4 + MENU Mode.

## 6. Verify the TV setup.

At this point, verify that the channel lineup, channel icons, and custom labels are correct. Make sure the TV features are set per your requirements.

## 7. Lock the channel lineup.

Enter the Installer Menu. Set item **028 CH. OVERRIDE** to **000** and press **ENTER** to lock the channel lineup and restrict access to the TV setup menus. Press **ENTER** again to save your changes and exit the Installer Menu.\*

The Master TV Setup is now ready to be copied to a USB memory device or a clone programmer (see cloning information in this document).

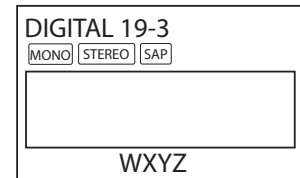

Custom Text Label "WXYZ" created in 2-5-4 + MENU (Add Channel Label) Mode.



After verifying the TV Setup, set Installer Menu item 028 CH. OVERIDE to 000.\*

\* This step prevents end users from accessing channel settings (i.e., the Channel Menu will be inaccessible/grayed out).

# Installer Menu

---

Use the Installer Menu to set up or change operational settings. Refer to the table starting on the next page for brief descriptions of Installer Menu items. More detailed descriptions follow the table listing.

## Accessing the Installer Menu

1. Make sure the TV is ON.
2. Using an Installer Remote, press **MENU** repeatedly until the on-screen setup menus lock up, and then press **9-8-7-6 + ENTER** to access the Installer Menu.

The Installer Menu opens with item 000 INSTALLER SEQ 000.

## Using the Installer Menu

Items 000 ~ 119 are accessible only upon entering the Installer Menu. Refer to the table on pages 15 and 16 for an overview of Installer Menu items, including item numbers, functions, ranges, and default values. Installer Menu items not relevant to this TV series are not present on the Installer Menu; therefore, some numbers are missing. For example, item 006 will not appear.

### Navigation within the Installer Menu

Use the Up/Down arrow keys on the Installer Remote to sequence through the available menu items, or access an item directly by keying in the line number and then pressing **MENU**. For example, to access the SLEEP TIMER option, which is item 015, press 0-1-5 + MENU.

### Changing Installer Menu Settings

To change an Installer Menu item setting, use the Left/Right arrow keys on the Installer Remote, or enter a value directly. Press **ENTER** to save the new setting, or use the Up/Down arrow keys to navigate to a new Installer Menu item if you have additional items to edit.

## Exiting the Installer Menu and Activating Updates

After you have adjusted all required Installer Menu item settings, press **ENTER** once on the Installer Remote to save your changes; then, press **ENTER** again to exit the Installer Menu. Any changes you make will be stored in non-volatile memory.

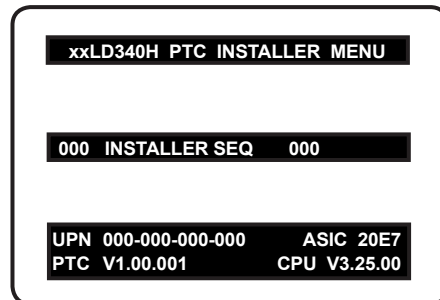

Typical TV Installer Menu

# Installer Menu (Cont.)

## Installer Menu Items 000 through 071

Menu Item	Function	Value Range	Default Value	Brief Description of Function and Comments
000	INSTALLER SEQ	0 ~ 3	0	Leave default set to 0.
001	POWER MANAGE	0 ~ 7	0	Sets number of hours of no activity before automatic shutoff.
002	AC ON	0 / 1	0	Set to 1 to enable Auto Turn ON when AC power is applied.
003	BAND/AFC	0 ~ 3	1	Selects Tuning Band: 0=Broadcast, 1=CATV, 2=HRC, 3=IRC
004	STRT CHANNEL	0 ~ 127, 255	255	Channel tuned when TV is turned ON. (Set to 255 to tune to channel tuned before TV turned OFF.)
005	CHAN LOCK	0 / 1	0	If set to 1, cannot tune from current channel.
007	STRT VOLUME	0 ~ 63, 255	255	Volume level when TV is turned ON. (Set to 255 to use volume level before TV turned OFF.)
008	MIN VOLUME	0 ~ 63	0	Sets minimum allowable volume setting.
009	MAX VOLUME	0 ~ 63	63	Sets maximum allowable volume setting.
010	MUTE DISABLE	0 / 1	0	Set to 1 to disable Mute Function.
011	KEY DEFEAT	0 / 1	0	Set to 1 to disable menu navigation keys on display panel.
015	SLEEP TIMER	0 / 1	1	Set to 1 to enable Sleep Timer.
016	EN TIMER	0 / 1	0	Set to 1 to enable On/Off Timers.
017	ALARM	0 / 1	1	Set to 1 to enable Alarm.
020	FEATURE LEVEL	0 ~ 1, 16 ~ 24	1	Determines the IR code scheme to which the TV will respond.
021	V-CHIP	0 / 1	1	Set to 1 to enable V-Chip (Parental Control) functions.
022	MAX BLK HRS	0 ~ 99	12	Sets number of V-Chip blocking hours.
023	CAPTION LOCK	0 / 1	0	Set to 1 to retain caption setting set before TV turned OFF.
028	CH. OVERRIDE	0 / 1	1	If set to 0, limits direct access to favorite channels.
029	OLD OCV	0 / 1	0	Set to 1 to change MPI operation to OCV.
030	ACK MASK	0 / 1	0	If set to 1, changes MPI for some OCV boxes.
031	POLL RATE	20 ~ 169	94	Selects poll rate for MPI.
032	TIMING PULSE	186 ~ 227	207	Sets baud rate for MPI.
034	CAMPORT EN	0 / 1	1	Set to 1 to enable Video 2 input.
035	COMPPOINT EN.	0 / 1	1	Set to 0 to disable HDMI 1. Set to 1 enable HDMI 1.
038	YPrPb EN.	0 / 1	1	Set to 1 to enable display panel Component Video 1 input jacks.
039	REAR AUX EN	0 / 1	1	Set to 1 to enable display panel Video 1 input jack.
040	AUTO CAMPORT	0 / 1	1	Set to 1 to automatically switch to Camport. If set to 1, STRT AUX SRCE cannot be set to 2.
046	STRT AUX SRCE	1 ~ 6, 255	6	Sets the starting Aux source (if item 004 STRT CHANNEL is set to 0).
047	AUX STATUS	0 / 1	0	Set to 1 for MPI Aux source to be reported as a channel number instead of Channel 0.
053	DIS. CH-TIME	0 / 1	0	Set to 1 to disable Channel-Time display.
069	EN. CH-T COL.	0 / 1	1	Set to 1 to enable custom color for the Channel-Time display.
070	FOR. CH-TIME	0 ~ 7	2	Chooses custom foreground color for the Channel-Time display.
071	BCK. CH-TIME	0 ~ 7	2	Chooses custom background color for the Channel-Time display.

## Installer Menu (Cont.)

### Installer Menu Items 073 through 119

Menu Item	Function	Value Range	Default Value	Brief Description of Function and Comments
073	CH NOT AVBLE	0 / 1	0	If set to 1 and Channel Override is 0, "NOT AVAILABLE" message is displayed when directly accessing a channel not in the favorite Channel List.
075	REVERT CH	0 / 1	0	If set to 1 and loss of MPI communication occurs, TV tunes to Start Channel.
078	UPN MSB	0 ~ 255	0	User programmable number, most significant byte.
079	UPN MSB-1	0 ~ 255	0	User programmable number, most significant byte - 1.
080	UPN MSB-2	0 ~ 255	0	User programmable number, most significant byte - 2.
081	UPN LSB	0 ~ 255	0	User programmable number, least significant byte.
082	CHKSM ERROR	0 / 1	1	Enforces rigid MPI checksum.
083	HANDSHK TIME	0 ~ 5	5	Relaxes MPI timing to be compatible with PC-based Windows-controlled systems.
084	PERMANENT BLK	0 / 1	0	Removes block hours setting for Parental Control and makes block permanent.
087	REAR RGB EN.	0/1/17	1	Dependent on item 093 RJP AVAILABLE setting. Set to 0 to disable RGB input. Set to 1 to enable RGB input. Set to 17 for Auto Configure.
088	EN NOISE MUTE	0 / 1	1	If set to 1, audio is muted if no signal is present.
090	KEY LOCK	0 / 1	0	If set to 1, keyboard is locked out, IR is still functional.
091	YPrPb2 EN	0 / 1	1	Set to 1 to enable HDMI 2 input.
093	RJP AVAILABLE	0, 1, 2, 5, 6	0	Set to 0 to disable. Set to 1, 2, 5, or 6 for HDMI or DVI Mode. (See detailed descriptions.)
094	SAP MENU EN	0 / 1	1	Set to 0 to disable feature on Function Menu. Set to 1 to enable feature on Function Menu.
096	DEF. ASP. RATIO	0 ~ 4	2	Sets default aspect ratio at power up. See detailed descriptions and item 106.
098	PRO:CENTRIC	0 ~ 2	0	Set to 0 to disable Pro:Centric operation. Set to 1 for Flash Mode. Set to 2 for GEM (Java Application) Mode.
099	BACK LIGHTING	1 ~ 100, 101 ~ 200, 255	100	Sets the level of the TV picture back lighting. (See detailed descriptions.)
102	ATSC BAND	0 ~ 4	4	Selects ATSC band.
103	ATSC TUNE MODE	0 / 1	1	Set to 1 (default) for Physical Channel scan. Set to 0 for Virtual Channel scan.
104	START MINOR CH	0 ~ 255	0	Selects Minor Start Channel. Set to 0 for NTSC.
106	ASP RATIO LOCK	0 / 1	0	To retain set aspect ratio on power cycle, set to 1. Set to 0 for default ratio on power cycle.
116	VIDEO MUTE EN	0 / 1	0	Set to 0 for Normal. Set to 1 for Blank.
117	FACT DEFAULT	0 / 1	0	Set to 0 for Normal. Set to 1 to load presets for all Installer Menu settings.
118	POWER SAVINGS	1 / 3	3	Set to 3 (default—b-LAN module only powered when TV is turned ON), or set to 1 (b-LAN module is always powered).
119	DATA CHANNEL	0 ~ 135	0	Set to 0 to disable. Set to the RF channel number of the Data Channel for Pro:Centric or E-Z Installation data. (See detailed descriptions.)

## Detailed Descriptions of Installer Menu Items

### 000 - INSTALLER SEQUENCE

Specifies entry sequence to the Installer Menu.

0 = 9876	1 = 4321
2 = 1478	3 = 3698

### 001 - POWER MANAGE (Power Management)

Determines hours of no activity before automatic shutoff. The Power Management function is for saving energy. If set to 0, Power Manage is Off. Settings range from 0 ~ 7, with 1 ~ 7 representing the hours that the unit will remain ON, unless there has been activity from either the control panel or remote control.

### 002 - AC ON (AC Power Switchable)

If set to 1, this allows the TV to turn ON when AC power is applied. Pressing the ON button is not necessary. This is desirable if the TV is plugged into a cable box or a power outlet controlled by a wall switch. Use the Left/Right arrow keys to choose 0 or 1, where 0 is the default (OFF), and 1 is ON.

**Note:** If set to 1 (ON), the TV does not respond to On/Off commands from either the remote or the display control panel, and the SLEEP TIMER is also nonfunctional.

### 003 - BAND/AFC (Band/Automatic Frequency Control)

There are four possible settings for this option:

0 = Broadcast	1 = CATV (default)
2 = HRC	3 = IRC

If some channels were not found by Auto Tuning (Channel Search), select the appropriate Band setting here, and add the channels using the Channel Edit option in the Channel Menu.

### 004 - STRT CHANNEL (Start Channel)

If active, this function allows you to determine the initial Major Start Channel number when the TV is turned ON. This feature is useful for an in-house information channel, since the TV would always select that channel when it is turned ON. Setting this item to 255 causes the last channel viewed when the TV was turned OFF, to be the tuned to channel when the TV is turned ON again.

**Note:** For a digital Start Channel, always remember to set item 104 to the Minor Start Channel number.

255 = Last channel	1 ~ 125 = Major Ch. #	0 = Aux
126 = Map to Channel 3	127 = Map to Channel 4	

### 005 - CHAN LOCK (Channel Lock)

Channel Lock is ideal if the system must always be on the same channel. Changing channels with the Channel Up/Down or keypad numbers is impossible. Channel Lock is inactive if set to 0 (default).

Generally, this feature is used in connection with STRT CHANNEL (Installer Menu item 004) where the Start Channel may, for example, be set to 3 or 4. If the Start Channel is 3, then the TV will remain locked on channel 3.

**NOTE:** For items 007, 008, and 009

For legacy reasons, the scale used is 0–63. The PTC software will translate this to the 0–100 scale used by the TV.

To translate a TV volume level to the Installer Menu value, use the following formula:

$$\text{Installer Value} = \frac{\text{TV Value} \times 63}{100}$$

Enter only the whole number (disregard fractions).

### 007 - STRT VOLUME (Start Volume)

This function allows the Installer to determine the initial volume level setting when the TV is turned ON. This feature is useful for an in-house information channel, since the TV would always select that volume level when it is turned ON. The range of values are 0 - 63, 255. If 255 is selected, the current volume level will be retained in memory when the TV is turned OFF; at turn ON, the volume level will be automatically set at the previous or last level.

### 008 - MIN VOLUME (Minimum Volume)

This function determines the minimum volume level allowable with the Volume (VOL) Up/Down control. In this way, for example, someone cannot set the volume too low to hear. The value range is from 0 to 63. Use the Left/Right arrow keys to change values. The factory default is 0, which provides the full range of volume control, if item 009 MAX VOLUME is also set to 63. It may be best to set the same value on every TV.

**Note:** The minimum volume level cannot have a value setting higher than the maximum volume level (described below).

### 009 - MAX VOLUME (Maximum Volume)

This function determines the maximum volume level allowable with the Volume (VOL) Up/Down control. In this way, for example, someone cannot set the volume level high enough to disturb others. The value range is 0 to 63, with 63 as the default, which gives the user the full range of volume control, if item 008 MIN VOLUME is also set at 0. Use the Left/Right arrow keys to change values. It may be best to set the same value on every TV.

**Note:** The maximum volume level cannot have a value setting lower than the minimum volume level (described above).

### 010 - MUTE DISABLE

Enables or disables sound mute function. If set to 1, sound cannot be muted. If set to 0, sound can be muted.

### 011 - KEY DEFEAT (Keyboard Defeat)

If set to 1, KEY DEFEAT prevents the end user from accessing the on-screen menus from the display panel—MENU, ENTER, and menu navigation keys do not function. If set to 0, those keys do function.

**Note:** Users can always access the menus by pressing MENU on the remote.

# Installer Menu (Cont.)

## 015 - SLEEP TIMER

If set to 1, the Sleep Timer feature may be used. If set to 0, the Sleep Timer is not available.

## 016 - EN TIMER (Enable On/Off Timers) \*

If set to 1, the Timer function is available to the end user and enabled continuously. Set to 0 to disable On/Off timers.

**Note:** Clock must be set in order to use timers.

## 017 - ALARM \*

Gives the installer the option of making the Alarm function available to the end user. If set to 1, the Alarm function is available to the end user. Set to 0 to disable the Alarm function.

**Note:** Clock must be set before the Alarm function will work.

## 020 - FEATURE LEVEL

Determines an additional IR code scheme to which the TV will respond, allowing for the use of unique IR codes based on "bed number" in a multi-TV single room installation. First determine the IR mode; then select the bed number.

IR Mode	Bed #	Values
Legacy (Hospital)	1-2	0-1
Multi-code Remote	1-9	16-24

**Note:** For further information, see documentation for the accessory package that includes the multi-code remote.

## 021 - V-CHIP (Parental Control) \*

Set to 1 to activate V-Chip (Parental Control) and have it available to the end user to filter and control or otherwise restrict programming content that can appear. Set to 0 to turn the V-Chip feature Off (not available to user); no programming restrictions can be set.

## 022 - MAX BLK HRS (Maximum Block Hours) \*

Sets hours from 0 to 99 for the maximum V-Chip (Parental Control) block hours. Default setting is for 12 blocking hours.

## 023 - CAPTION LOCK

If set to 0, captions are OFF when the TV is turned ON. Set to 1 to use the caption setting configured before the TV was turned OFF when the TV is turned ON.

## 028 - CH. OVERRIDE (Channel Override)

If set to 1, the user can select channels with either Channel Up/Down or by direct keypad entry. If set to 0, only those channels that are active in the TV's memory can be selected.

## 029 - OLD OCV (On Command Video™)

Set to 1 for operation with systems from On Command Corporation.

\* Only affects Function Menu if enabled by some PPV providers.

## 030 - ACK MASK

MPI Communication Parameter. Leave at default setting unless changed by PPV provider. When set to 1, changes MPI for some OCV boxes.

## 031 - POLL RATE

MPI Communication Parameter. Selects Poll Rate for MPI. Leave at default setting unless changed by Pay-Per-View provider. Step size of 16 ms.

## 032 - TIMING PULSE

MPI Communication Parameter. Leave at default setting unless changed by Pay-Per-View provider. Sets baud rate. Step size of 4.3 uS.

## 034 - CAMPORT EN. (Camera Port Enable)

Set to 1 to enable Video 2 input on display panel. If set to 0, Video 2 input on display panel is not functional.

## 035 - COMPPORT EN. (Computer Port Enable)

Enable/disable TV display panel HDMI 1 input jack. Set to 0 to disable HDMI1. Set to 1 to enable HDMI1.

**Note:** This setting is ignored if item 093 RJP AVAILABLE is set to 1.

## 038 - YPrPb EN. (Rear Component Video Enable)

Set to 1 to enable display panel rear Component Video input jacks. Set to 0 to disable display panel rear Component Video input jacks.

## 039 - REAR AUX EN. (Rear Aux Enable)

Set to 1 to enable display panel rear Aux (Video 1) input. Set to 0 to disable display panel rear Aux (Video 1) input.

## 040 - AUTO CAMPORT

Set to 1 to automatically switch to Camport when equipment is connected to side Video input. Set to 0 to disable side Video automatic source selection. If set to 1, STRT AUX SRCE cannot be set to 2.

**Note:** If set to 1, item 093 RJP AVAILABLE is automatically set to 0.

## 046 - STRT AUX SRCE (Start Aux Source)

Sets the starting Aux source. When turned ON, the TV will tune to starting Aux source if item 004 STRT CHANNEL is set to 0.

If item 093 RJP AVAILABLE is set to 0 and item 040 AUTO CAMPORT is set to 0:

1 = Video 1      4 = RGB      255 = Last Aux  
2 = Video 2      5 = HDMI 2  
3 = HDMI 1      6 = Component

If item 093 RJP AVAILABLE is set to 1:

2 = Video 2      5 = HDMI 2      6 = Component

If item 040 AUTO CAMPORT is set to 1:

1 = Video 1      4 = RGB      6 = Component  
3 = HDMI 1      5 = HDMI 2

## 047 - AUX STATUS

Set to 1 for MPI Aux source to be reported as a channel number instead of channel 0. Set to 0 to disable Aux identification change. Controls MPI status channel response for Aux inputs.

## 053 - DIS. CH-TIME (Disable Channel-Time)

Set to 1 to disable the Channel-Time display; Channel-Time display will not appear. Set to 0 to enable the Channel-Time display.

## 069 - EN. CH-T COL. (Enable Channel-Time Custom Color)

Set to 1 to enable custom color for the Channel-Time display. Set to 0 to disable custom color for the Channel-Time display.

## 070 - FOR. CH-TIME (Channel-Time Display Foreground Color)

Set according to Color Chart:

0 = Black	3 = Cyan	6 = Yellow
1 = Blue	4 = Red	7 = White
2 = Green	5 = Violet	

**Note:** Applies only to "Channel Not Available" message if item 073 is set to 1 (enabled). If foreground color and background color are the same, the menu background will be transparent.

## 071 - BCK. CH-TIME (Channel-Time Display Background Color)

Set according to Color Chart:

0 = Black	3 = Cyan	6 = Yellow
1 = Blue	4 = Red	7 = White
2 = Green	5 = Violet	

**Note:** Applies only to "Channel Not Available" message if item 073 is set to 1 (enabled). If foreground color and background color are the same, the menu background will be transparent.

## 073 - CH NOT AVBLE (Channel Not Available)

If set to 1 and item 028 CH. OVERRIDE is set to 0, a "NOT AVAILABLE" message is displayed when directly accessing a channel not in the channel scan list available in memory.

## 075 - REVERT CH (Revert to Start Channel)

If set to 1 and loss of MPI communication occurs, TV automatically tunes to the specified Start Channel.

## 078 - UPN MSB (UPN Most Significant Byte)

User programmable number, most significant byte readable by MPI command. Note: Not linked to serial number.

## 079 - UPN MSB-1 (UPN Most Significant Byte-1)

User programmable number, most significant byte-1 readable by MPI command. Note: Not linked to serial number.

## 080 - UPN MSB-2 (UPN Most Significant Byte-2)

User programmable number, most significant byte-2 readable by MPI command. Note: Not linked to serial number.

## 081 - UPN LSB (UPN Least Significant Byte)

User programmable number, least significant byte readable by MPI command. Note: Not linked to serial number.

## 082 - CHKSM ERROR (Checksum Error)

Enforces rigid MPI checksum validation. Set to 1 for validation. Set to 0 to disable (does not check checksum on MPI async port). SPI is always checked.

## 083 - HANDSHK TIME (Handshake Time)

Adds an additional delay to the handshake time which is 64 msec, thus relaxing MPI timing requirements to be compatible with PC-based Windows controlled systems. Range is 0 - 5. (Timeout = 25.5MS + [25.5 MS\* Handshake time].)

## 084 - PERMANENT BLK (Permanent Block)

Allows Lock (Parental Control) blocking schemes to be permanent by disabling the blocking hours function. Set to 1 to install Parental Control restrictions permanently. Set to 0 for user-specified hours control of blocking schemes.

## 087 - REAR RGB EN. (Rear RGB Enable)

Controls access to rear RGB input on TV. Set to 0 to disable RGB input. Set to 1 to enable RGB input. Set to 17 to initiate a one-time automatic configuration after an AC power cycle; otherwise, automatic adjustment will be performed each time the RGB input is accessed.

## 088 - EN NOISE MUTE (Enable Noise Mute)

If set to 1, audio mutes if no signal is present.

## 090 - KEY LOCK

If set to 1, display panel Channel, Volume, and Captions buttons are disabled, Power button remains enabled. If set to 0, the Channel, Volume, Captions, and Power buttons are all enabled.

## 091 - YPrPb2 EN. (HDMI2 Enable)

Set to 0 to disable display panel HDMI2 input. Set to 1 to enable DTV mode. Set to 2 to enable PC mode.

## 093 - RJP AVAILABLE (Remote Jack Pack Available)

- 0 = Remote jack pack is not available or disabled.
- 1 = Legacy Model RJPs: HDMI Mode  
Enables RJP feature for use with full cable bundle models. In this mode, when an HDMI source is connected to the RJP, both digital video and audio are expected via the HDMI cable. If no digital audio is present, no audio will be heard.
- 2 = Legacy Model RJPs: DVI Mode  
Enables RJP feature for use with full cable bundle models. In this mode, when an HDMI/DVI source is connected to the RJP, only digital video is expected via the HDMI cable. Analog audio is provided via a separate cable, from the source, connected to an RJP AUDIO IN. If no analog audio cable is connected, tuner audio will be heard.
- 5 = Scaler Model RJPs: HDMI Mode  
Enables RJP feature for use with reduced cable bundle models. In this mode, when an HDMI source is connected to the RJP, both digital video and audio are expected via the HDMI cable. If no digital audio is present, no audio will be heard.

# Installer Menu (Cont.)

---

- **6 = Scaler Model RJP: DVI Mode**  
Enables RJP feature for use with reduced cable bundle models. In this mode, when an HDMI/DVI source is connected to the RJP, only digital video is expected via the HDMI cable. Analog audio is provided via separate cable, from the source, connected to an RJP AUDIO IN. If no analog audio cable is connected, tuner audio will be heard.

## Notes:

See Reference section, "RJP Model List and Input Auto-sensing Hierarchy." If RJP AVAILABLE is set to 1, 2, 5, or 6, item 040 AUTO CAMPORT is automatically set to 0. Settings 1, 2, 5, and 6 allow the lodge staff to customize each TV's RJP setup based on customer requirements.

## 094 - SAP MENU EN (2nd Audio Program)

Set to 1 to enable SAP feature on Function Menu, if Function Menu is available. Set to 0 to disable SAP feature on Function Menu, if Function Menu is available.

## 096 - DEF. ASP. RATIO (Default Aspect Ratio)

Selects default aspect ratio at power up.

- Set to 0 for Set By System.
- Set to 1 for 4:3.
- Set to 2 for 16:9 (Factory Default).
- Set to 3 for Just Scan.
- Set to 4 for Zoom.

**Note:** Only applies if item 106 ASP RATIO LOCK is disabled, set to 0.

## 098 - PRO:CENTRIC

Selects the Pro:Centric Mode. Set to 0 (default) to disable Pro:Centric operation. Set to 1 for Flash Mode. Set to 2 for GEM (Java Application) Mode.

## 099 - BACK LIGHTING

Sets the TV screen brightness at power up. Default setting is 100.

- 1 - 100 Static Back Lighting  
(1 = Dimmest picture, 100 = Brightest picture)
- 101 - 200 Dynamic Back Lighting  
(101 = Dimmest picture, 200 = Brightest picture)

If set between 101 and 200, the TV automatically controls back lighting depending upon the picture level of the current program. If set to 255, back lighting is controlled via the Picture settings in the TV's setup menus.

## 102 - ATSC BAND

Sets up TV to receive different types of incoming signals: 0 = Broadcast, 1 = CATV, 2 = HRC, 3 = IRC, 4 = Same as NTSC.

## 103 - ATSC TUNE MODE

Sets ATSC tuning mode: Default set to 1 for Physical Channel scan. Set to 0 for Virtual Channel scan.

## 104 - START MINOR CHANNEL

Sets Minor Start Channel number at power up. 0 = NTSC. If not 0, number selected is the digital channel's Minor Start Channel number.

## 106 - ASP RATIO LOCK (Aspect Ratio Lock)

Set to 1 to retain previous aspect ratio with power off. Set to 0 to retain default aspect ratio with power off. See item 096 DEF. ASP. RATIO above.

## 116 - VIDEO MUTE EN (Video Mute Enable)

Set to 0 for Normal. Set to 1 for Blank.

## 117 - FACT DEFAULT (Factory Default)

Set to 0 for normal. Set to 1 to load presets of all Installer Menu item settings.



**Warning: If set to 1, this will reload the factory defaults and clear the Channel List, including any assigned channel icons and custom channel labels.**

## 118 - POWER SAVINGS

Default set to 3—the embedded *b*-LAN module is only powered when the TV is turned ON. If set to 1, the *b*-LAN module is always powered.

**Note:** MPI cards with *b*-LAN technology—LMT7Z5, LMT7Z7, LMT7Z9—are NOT supported in TVs in which *b*-LAN technology is already integrated.

**Note:** See Reference section, "*b*-LAN Setup & Overview," for further information.

## 119 - DATA CHANNEL

Set to 0 (default) to disable. Set to the RF channel number of the Data Channel for Pro:Centric or E-Z Installation (splash screen, configuration, or firmware) data.

**Note:** Pro:Centric updates are downloaded from the Pro:Centric server to the TV when the TV is turned OFF. Also, while Pro:Centric updates are in progress, it is not possible to turn the TV ON. The TV may take several minutes to load EPG data after the initial download of the Pro:Centric application. Subsequent updates generally will take less than one minute.



# TV Setup Menus Overview

---

On-screen setup menus control the features of the TV. Press **MENU** on the Installer Remote to access the TV setup menus, and set the TV features to the desired configuration for the end user.

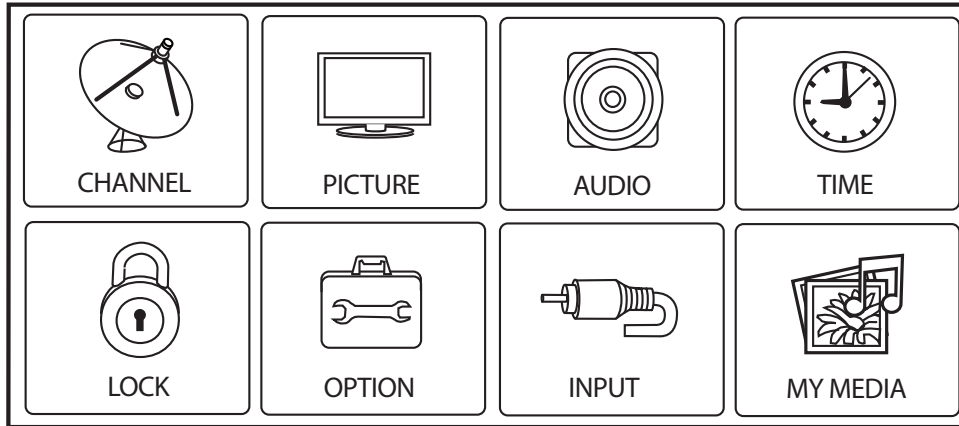

Refer to the Owner's Manual for further information on the TV setup menus.

# Adding Channel Icons / Custom Channel Labels (2-5-4 + MENU Mode)

## Editing/Adding Channel Icons and/or Labels

If there is no pre-assigned icon, you can make a custom channel label of up to seven (7) characters to help identify a channel or network. If desired, channel labels can also be added in addition to a pre-assigned icon. You may also add labels for the Aux input sources to clearly identify the devices that are connected to the Aux inputs.

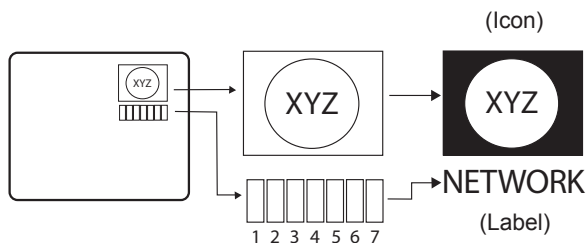

Editing and adding the labels can only be done if there are channels entered into the TV's Channel Map either during Commercial Mode Setup (see pages 12 to 13), by cloning, or by using some PPV providers' master remote controls. **Note:** A blank letter space is available between "Z" and "!".

## To perform channel editing/labeling:

1. Enter the TV Installer Menu: Press **MENU** repeatedly until the on-screen setup menus lock up, and then press **9-8-7-6 + ENTER**.
2. Press **2-5-4 + MENU** on the Installer Remote to enter the Channel Label Editing Mode.
3. Add channel icons and channel labels as described in the procedures below. (You can do this more than once.)
4. To exit the menu when you are done, press **MENU**.

## Changing a Channel's Icon on the Master TV

1. Use Channel Up/Down to select the desired channel.
2. Use the Left/Right arrow keys to select the thin letter "I" on the Channel ID display.
3. Use the Up/Down arrow keys to select the icon with which you want to identify the channel. (If you know the icon number, enter the number, and press **ENTER**.)
4. Proceed to change/add channel labels, or go to the next channel.

## Changing/Adding Channel Labels on the Master TV

1. Use Channel Up/Down to select the desired channel.
2. Press the Left or Right arrow repeatedly until the numbers 1 to 7 appear on the display. The number shows the position of the character that can be changed. Number 1 is the first character, number 2 the second character, etc.
3. Use the Up/Down arrow keys to select the desired character.
4. Proceed to the next number position, or use Channel Up/Down to go to the next channel.

## Changing Source Labels on the Master TV

1. Press **INPUT** to select the desired Aux input source: A/V 1, A/V 2, HDMI Component, RGB, etc.
2. Press the Left or Right arrow repeatedly until the numbers 0 to 9 appear on the display. The number shows the position of the character that can be changed.
3. Use the Up/Down arrow keys to select the desired character.
4. Press **INPUT** for the next Aux source, or use Channel Up/Down to return to channels.

## Installer Remote Control Key Functions for Master TV Channel Editing/Labeling Menu

- **Channel Up/Down:** Tunes to the next channel in scan.
- **Left/Right Arrows:** Select the item to change. If "I" is shown, the icon can be changed. If a number is shown, it indicates the position of the character that can be changed.
- **Up/Down Arrows:** Select the icon or the character to be displayed. Tip: Arrows can be held down for fast scrolling.
- **0 – 9:** Use to enter the index number of the icon, if known.
- **ENTER:** Changes the icon after the number has been entered.
- **INPUT:** Changes the Aux input label.
- **MENU:** Exits the editing process.

## IMPORTANT CLONING INFORMATION

There are three options for cloning a Master TV Setup:

- Using a USB memory device
- Using a TLL-1100A clone programmer
- Using a LT2002 clone programmer

Each option is described in further detail on the pages that follow. As you perform cloning procedures, be sure to complete each task as indicated. If a procedure or step is omitted or not performed completely, cloning may not work. At each step, pay attention to ensure the TV screen shows the proper message when cloning. If the message indicated does not appear, there is a problem with that step, and cloning may not be successful.



**Warning: Copying a blank or incorrect memory into a TV will cause the TV to operate erratically or become inoperable.**



**Warning: Do not connect a clone programmer to a PPV card installed in the Master or Target TVs. Also, if the TV is in LodgeNet PPV Mode (check with the site administrator if you are not certain), do not connect a clone programmer to the GAME CONTROL/MPI port. Either of these actions will damage the clone programmer and, if applicable, the PPV card.**

### Before you begin cloning:

- Complete the Commercial Mode Setup for Master TV procedure on pages 12 to 13.
- All equipment should be connected to power and turned ON.
- Both the Master and Target TVs must be in Pass-through Mode.
- Ensure Installer Menu items on Target TVs are set/restored to factory default settings (i.e., set Installer Menu item 117 FACT DEFAULT to 001 on Target TVs) before Teaching is initiated.
- Learning and Teaching is only possible between identical model TVs.
- If using a USB memory device, ensure the USB device has been formatted with FAT format.
- For both Master and Target TVs—If using a clone programmer, ensure the TV signal source is either an Aux or TV (RF) source. If a TV (RF) source, the TV must be tuned to an analog (not a digital) channel.
- LT2002 only—Make sure the batteries in the clone programmer are fresh. If batteries are removed, the clone programmer clock time (if set) will be lost (see page 28 for information on the clone programmer clock).
- Do not unplug the TV power cord or remove/disconnect the USB memory device/clone programmer while Learning or Teaching, as doing so may cause the TV to malfunction or harm the USB device/clone programmer, respectively.

## Clonable Menu Features

### Installer Menu

Installer Menu item settings

### Channel

Auto Tuning (Channel Lineup)  
Manual Tuning  
Channel Edit  
Channel Label

### Picture

Aspect Ratio  
Picture Mode  
Advanced Control

### Audio

Auto Volume  
Clear Voice  
Sound Mode  
Balance  
TV Speaker

### Option

Menu Language  
Audio Language  
Caption  
Caption Mode  
Digital Caption Options

### Lock

Movie Rating  
TV Rating – Children  
TV Rating – General  
Input Block

### Time

Auto Clock  
Manual Clock  
Off Time  
On Time  
Auto Off (Sleep Timer)

**Note:** Some menu options vary between analog and digital channels and Aux sources.

Your TV's OSD (On Screen Display) may differ slightly from that shown in this manual.

# Cloning Procedures

## Learning / Teaching a Master TV Setup using a USB Memory Device

### USB Cloning Notes

- Read the IMPORTANT CLONING INFORMATION on page 23 before beginning any cloning procedures.
- You may edit a filename as part of the Learning procedure; however, a file with edited contents will not be recognized.
- It is not possible to clone a Master TV's clock using a USB memory device. Either set a Target TV's clock manually, or use the Auto Clock setting in the TV setup menus.

### Learn Setup from Master TV

1. Ensure the Master TV is set up completely and in Pass-through Mode.
2. Plug the USB memory device into the USB IN port on the Master TV.
3. Press **MENU** on the Installer Remote to display the TV setup menus, use the arrow navigation keys to select/highlight the **Option** menu icon, and then press the number "7" key a total of seven times to display the USB Download Menu.
4. To gain access to the "Learn From TV" option in the USB Download Menu, key in the password used to enter the Installer Menu (Example: Press **9-8-7-6**).
5. Use the Up/Down arrow keys to select **Learn From TV (TLL)**, and then press **ENTER**.
6. To identify the profile from others, you can use the Up/Down arrow keys to change the last five digits of the filename. Press **ENTER** when you are ready to initiate Learning.

Learning status will be shown on the progress bar. When the Learning process is complete, the USB Download menu will reappear on screen.

7. Remove the USB memory device from the Master TV.

### Teach Master TV Setup to Target TV

1. Ensure the Target TV is in Pass-through Mode, and then use the Installer Remote to enter the Target TV Installer Menu: Press **MENU** repeatedly until the on-screen setup menus lock up, and then press **9-8-7-6 + ENTER**.
2. Set Installer Menu item **117 FACT DEFAULT** to **001**, and press **ENTER**. When the value changes back to 0, press **ENTER** again to exit the Installer Menu.
3. Plug the USB memory device with the Master TV Setup file into the Target TV USB IN port.
4. Press **MENU** on the Installer Remote to display the TV setup menus, use the arrow navigation keys to select/highlight the **Option** menu icon, and then press the number "7" key a total of seven times to display the USB Download Menu.
5. Use the Up/Down arrow keys to select **Teach To TV (TLL)**, and then press **ENTER**.
6. Use the Up/Down arrow keys to select the Master TV Setup you want to install, and then press **ENTER**. Note: Filenames identify the TV and the TLL version (see example at right).

Teaching status will be shown on the progress bar. When the Teaching process is complete, the USB Download menu will reappear on screen.

7. When Teaching is done, remove the USB memory device from the Target TV, turn OFF the TV, and unplug the TV power cord for 15 seconds.
8. Reconnect the TV power cord, and turn ON the TV. The Master TV Setup should be resident on the Target TV.

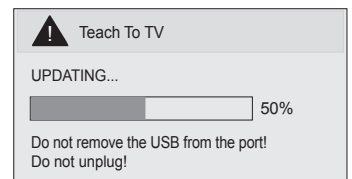
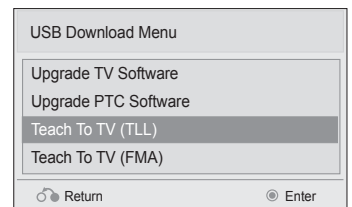
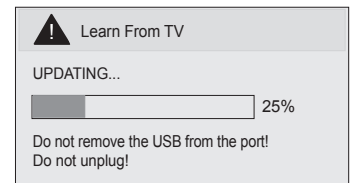
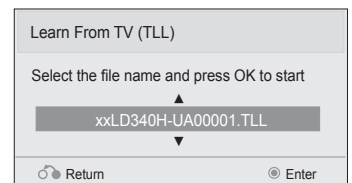
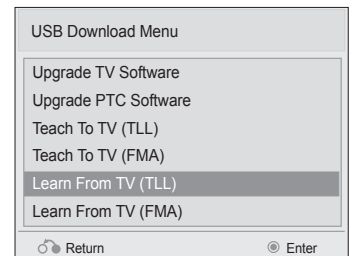

## Learning / Teaching a Master TV Setup using a TLL-1100A Clone Programmer



**Warning: Do not connect a clone programmer to a PPV card installed in the Master or Target TVs. Also, if the TV is in LodgeNet PPV Mode (check with the site administrator if you are not certain), do not connect a clone programmer to the GAME CONTROL/MPI port. Either of these actions will damage the clone programmer and, if applicable, the PPV card.**

Cloning is accomplished using the TV/clone programmer MPI ports for communication (see figure).

### TLL-1100A Cloning Notes

- Read the IMPORTANT CLONING INFORMATION on page 23 before beginning any cloning procedures.
- Ensure the TLL-1100A is either fully charged or connected to AC power.
- Learning and Teaching is only possible between identical model TVs; however, the TLL-1100A clone programmer can store up to eight different Master TV Setups.

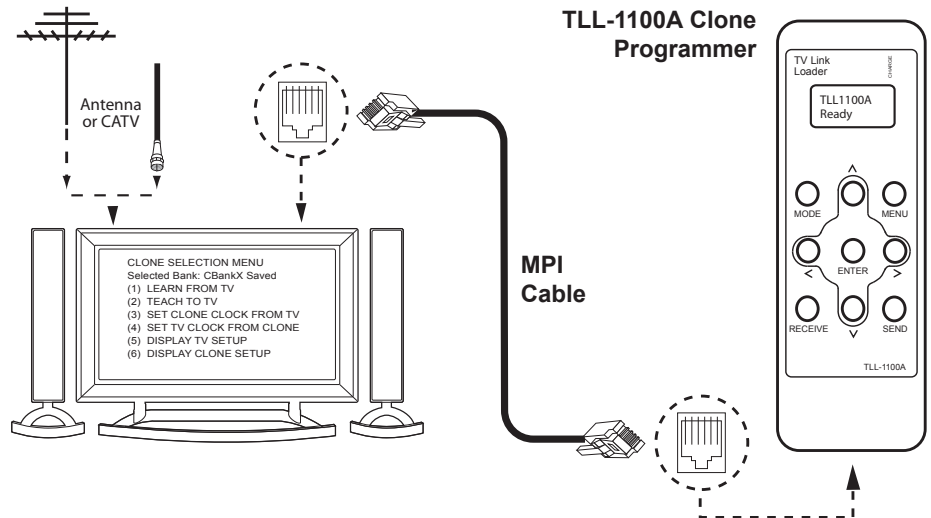

### Learn Setup from Master TV

1. Ensure the Master TV is set up completely and in Pass-through Mode.
2. If an analog channel is not available, direct tune the TV to an Aux source, or select an Aux source, such as AV-1, from the Input Menu. Then, plug one end of the MPI cable into the TV MPI port.
3. Turn ON the TLL-1100A.
4. Use the **MODE** button on the TLL-1100A to select **Clone Mode**.
5. Use the Left/Right arrows on the TLL-1100A to select the Memory CBank (1 to 8) in which to store the Master TV Setup.
6. Plug the other end of the MPI cable into the MPI port on the bottom of the TLL-1100A. The Clone Selection Menu will display on the TV screen.
7. Press **1** on the Installer Remote to select **LEARN FROM TV** from the Clone Selection Menu. Then, press **ENTER** to transfer the Master TV Setup into CBankX on the TLL-1100A.

Learning usually takes about 90 seconds. "LEARNING IN PROGRESS" will be displayed on the screen while the TLL-1100A copies the Master Setup. When the Learning process is complete, a "LEARNING COMPLETE" message will be displayed.

8. When Learning is complete, disconnect the MPI cable from the Master TV.

CLONE SELECTION MENU  
Selected Bank: CBankX Saved  
(1) LEARN FROM TV  
(2) TEACH TO TV  
(3) SET CLONE CLOCK FROM TV  
(4) SET TV CLOCK FROM CLONE  
(5) DISPLAY TV SETUP  
(6) DISPLAY CLONE SETUP

CLONE CLOCK = XX:XX  
TV CLOCK = XX:XX  
THE CLONE IS VERSION VX.X.X  
- To change menu items, press channel keys or digits.  
- To execute item, press Enter.

# Cloning Procedures (Cont.)

## Learning / Teaching a Master TV Setup using a TLL-1100A Clone Programmer (Cont.)

---

### (Optional) Set the Clock

Set the time on a Master TV's clock. (If the time has already been copied from a TV into the TLL-1100A clone programmer, you can set the Master TV's clock by copying the time from the clone programmer.) The TLL-1100A can copy the current time to both a Master TV and to the clone's internal clock—accurate to within one minute.

Since the TLL-1100A's time cannot be set directly, the current time needs to be copied from an LG TV equipped with an enabled MPI port.

After the time is copied to the TLL-1100A clone programmer, the current time will be maintained and can then be transferred to another TV. (This can be a Master TV or another TV which has already had the features set up.)

### Teach Master TV Setup to Target TV

1. Ensure the Target TV is in Pass-through Mode, and then use the Installer Remote to enter the Target TV Installer Menu: Press **MENU** repeatedly until the on-screen setup menus lock up, and then press **9-8-7-6 + ENTER**.
2. Set Installer Menu item **117 FACT DEFAULT** to **001**, and press **ENTER**. When the value changes back to 0, press **ENTER** again to exit the Installer Menu.
3. Tune/set the TV to an analog channel or Aux source, and then connect the MPI cable to the MPI port on the Target TV. The Clone Selection Menu will display on the TV screen.
4. Ensure the correct Memory CBank(X) is selected on the TLL-1100A.
5. Press **2** on the Installer Remote to select **TEACH TO TV** from the Clone Selection Menu. Then, press **ENTER** to transfer the Master TV Setup to the Target TV.  
Teaching usually takes 3 to 4 minutes. "TEACHING IN PROGRESS" will be displayed on the screen during Teaching. When the Teaching process is complete, a "TEACHING COMPLETE" message will be displayed.
6. When Teaching is done, disconnect the MPI cable from the Target TV, turn OFF the TV, and unplug the TV power cord for 15 seconds.
7. Reconnect the TV power cord, and turn ON the TV. The Master TV Setup should be resident on the Target TV.

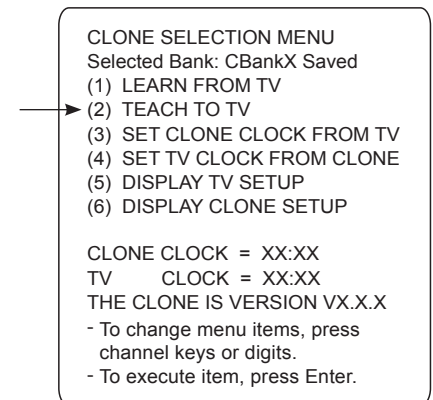
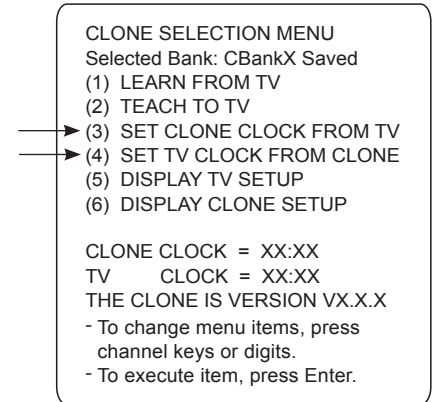

## Learning / Teaching a Master TV Setup using an LT2002 Clone Programmer



**Warning: Do not connect a clone programmer to a PPV card installed in the Master or Target TVs. Also, if the TV is in LodgeNet PPV Mode (check with the site administrator if you are not certain), do not connect a clone programmer to the GAME CONTROL/MPI port. Either of these actions will damage the clone programmer and, if applicable, the PPV card.**

Cloning is accomplished using the TV/clone programmer MPI ports for communication (see figure).

### LT2002 Cloning Notes

- Read the IMPORTANT CLONING INFORMATION on page 23 before beginning any cloning procedures.
- A slow flashing green light indicates that there are communication problems between the TV and the LT2002 clone programmer. If this is the case, check for a damaged cable, poor contacts, or other connection troubles.
- If the status indicator is red, the LT2002 batteries are low and should be replaced. Install four (4) high-quality alkaline AA batteries.
- Learning and Teaching is only possible between identical model TVs; however, the LT2002 clone programmer can store up to three different Master TV Setups.

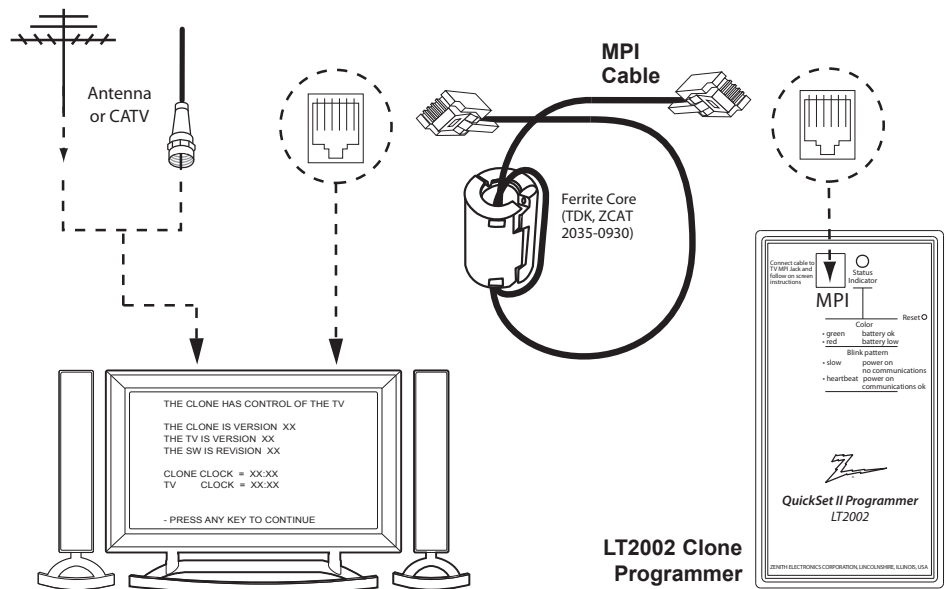

### Learn Setup from Master TV

1. Ensure the Master TV is set up completely and in Pass-through Mode.
2. If an analog channel is not available, direct tune the TV to an Aux source, or select an Aux source, such as AV-1, from the Input Menu. Then, plug one end of the MPI cable into the TV MPI port.
3. If there is a good connection after the LT2002 is connected to the TV MPI port, "THE CLONE HAS CONTROL OF THE TV" message will appear on the TV screen. Press any key on the Installer Remote to access the LT2002 Clone Selection Menu.
4. Press **1** on the Installer Remote to select **LEARN FROM TV** from the Clone Selection Menu; then press **ENTER** to proceed to the Memory Bank Selection Menu (see sample screen on next page).
5. Press 1, 2, or 3 on the Installer Remote to select the clone Memory Bank in which to store the Master Setup. Then, press **ENTER**.

**Note:** If you choose a Memory Bank that already has a Master device's setup programmed into it, that setup will be overwritten by the new Master TV Setup.

(Continued on next page)

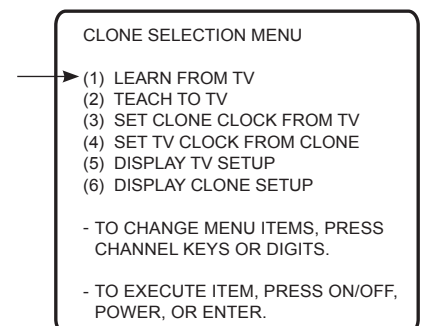
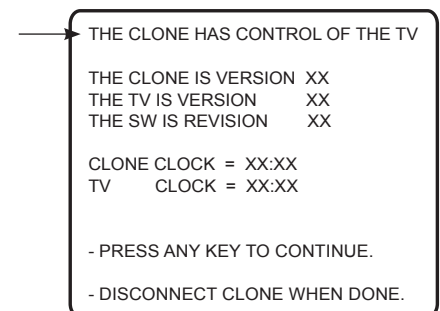

# Cloning Procedures (Cont.)

## Learning / Teaching a Master TV Setup using an LT2002 Clone Programmer (Cont.)

(Continued from previous page)

6. Verify the Learning setup information on the next screen, and then press **POWER** to transfer the Master TV Setup into the selected Memory Bank on the LT2002.

Learning usually takes about 90 seconds. "LEARNING IN PROGRESS" will be displayed on the screen while the LT2002 copies the Master Setup. When the Learning process is complete, a "LEARNING COMPLETE" message will be displayed.

7. When Learning is complete, disconnect the MPI cable from the Master TV.

### (Optional) Set the Clock

Set the time on a Master TV's clock. (If the time has already been copied from a TV into the LT2002 clone programmer, you can set the Master TV's clock by copying the time from the clone programmer.) The LT2002 can copy the current time to both a Master TV and to the clone's internal clock—accurate to within one minute. (Another reason that the LT2002 should be equipped with fresh, high-quality alkaline batteries, is for it to keep the time as accurately as possible.)

Since the LT2002's time cannot be set directly, the current time needs to be copied from an LG TV equipped with an enabled MPI port.

After the time is copied to the LT2002 clone programmer, the current time will be maintained and can then be transferred to another TV. (This can be a Master TV or another TV which has already had the features set up.)

### Teach Master TV Setup to Target TV

1. Ensure the Target TV is in Pass-through Mode, and then use the Installer Remote to enter the Target TV Installer Menu: Press **MENU** repeatedly until the on-screen setup menus lock up, and then press **9-8-7-6 + ENTER**.
2. Set Installer Menu item **117 FACT DEFAULT** to **001**, and press **ENTER**. When the value changes back to 0, press **ENTER** again to exit the Installer Menu.
3. Tune/set the TV to an analog channel or Aux source, and then connect the MPI cable to the MPI port on the Target TV.
4. With "THE CLONE HAS CONTROL OF TV" message on display, press **2** on the Installer Remote to select **TEACH TO TV** from the LT2002 Clone Selection Menu. Then, press **ENTER**.
5. Select the LT2002 Memory Bank in which the new Master TV Setup is located, and press **ENTER**.
6. Verify the Teaching setup information on the next screen, and then press **POWER** to transfer the Master TV Setup to the Target TV.

Teaching usually takes 3 to 4 minutes. "TEACHING IN PROGRESS" will be displayed on-screen during Teaching. When the Teaching process is complete, a "TEACHING COMPLETE" message will be displayed.

7. When Teaching is done, disconnect the MPI cable from the Target TV, turn OFF the TV, and unplug the TV power cord for 15 seconds.
8. Reconnect the TV power cord, and turn ON the TV. The Master TV Setup should be resident on the Target TV.

SAVE TV SETUP IN SELECTED CLONE MEMORY

- (1) MEMORY 1 VER XX REV XX
- (2) MEMORY 2 VER XX REV XX
- (3) MEMORY 3 VER XX REV XX
- (4) RETURN TO CLONE MENU

- TO CHANGE MENU ITEMS, PRESS CHANNEL KEYS OR DIGITS.

- TO EXECUTE ITEM, PRESS ON/OFF, POWER, OR ENTER.

CLONE SELECTION MENU

- (1) LEARN FROM TV
- (2) TEACH TO TV
- (3) SET CLONE CLOCK FROM TV
- (4) SET TV CLOCK FROM CLONE
- (5) DISPLAY TV SETUP
- (6) DISPLAY CLONE SETUP

- TO CHANGE MENU ITEMS, PRESS CHANNEL KEYS OR DIGITS.

- TO EXECUTE ITEM, PRESS ON/OFF, POWER, OR ENTER.

CLONE SELECTION MENU

- (1) LEARN FROM TV
- (2) TEACH TO TV
- (3) SET CLONE CLOCK FROM TV
- (4) SET TV CLOCK FROM CLONE
- (5) DISPLAY TV SETUP
- (6) DISPLAY CLONE SETUP

- TO CHANGE MENU ITEMS, PRESS CHANNEL KEYS OR DIGITS.

- TO EXECUTE ITEM, PRESS ON/OFF, POWER, OR ENTER.

COPY SELECTED CLONE MEMORY TO TV

- (1) MEMORY 1 VER XX REV XX
- (2) MEMORY 2 VER XX REV XX
- (3) MEMORY 3 VER XX REV XX
- (4) RETURN TO CLONE MENU

- TO CHANGE MENU ITEMS, PRESS CHANNEL KEYS OR DIGITS.

- TO EXECUTE ITEM, PRESS ON/OFF, POWER, OR ENTER.



## FTG Mode via CPU or EBL

FTG Mode enables Pro:Idiom decryption and also allows logical channel mapping of physical channels.

There are two separate and distinct methods for configuring LD340H/LD345H TVs for FTG Mode of operation: one (new) method is to configure the TV CPU for FTG Mode operation, while the other is to configure the TV EBL for FTG Mode operation. EACH OF THESE METHODS IS MUTUALLY EXCLUSIVE. IF THE CPU IS IN FTG MODE, THE EBL CANNOT BE SWITCHED TO FTG MODE. LIKEWISE, IF THE EBL IS IN FTG MODE, THE CPU CANNOT BE SWITCHED TO FTG MODE.

 **Caution: Once the initial method for configuring the TVs for FTG Mode of operation has been selected, all subsequent changes to FTG Channel Map and FTG Installer Menu settings must also be performed in accordance with the selected FTG Mode of operation (via CPU or EBL).**

- FTG Mode via CPU: With this method, the TV's CPU is configured with an FTG Channel Map and FTG Installer Menu settings using one of the following processes:
  - Configure an individual LD340H/LD345H TV via its USB port using an FMA Configuration (.fma) file on a USB memory device. The “Teach to TV (FMA)” process, along with associated procedures, is described on pages 31 to 34.
  - Configure all LD340H/LD345H TVs at the site using a Pro:Centric server head end device (Example: PCS150R). Load an FMA Configuration (.fma) file on the Pro:Centric server using the TV E-Z Installation “Configuration” option in the Pro:Centric Server Admin Client. Refer to the **Pro:Centric™ Server Admin Client User Guide** for further information.
- FTG Mode via EBL: With this method, the TV's EBL module is configured with an FTG Channel Map and FTG Installer Menu settings using one of the following processes:
  - Configure an individual LD340H/LD345H TV's EBL via its TV-LINK CFG jack using a direct PC-to-TV connection and the FTG Configuration Application. The “Write” process for an FTG Channel Map and FTG Installer Menu settings is described on page 35.
  - Configure all LD340H/LD345H TV EBLs at the site using a Free-To-Guest Management Appliance (FMA) head end device (Example: FMA-LG101). Refer to the **Free-To-Guest (FTG) Configuration Application** manual and/or the Installation & Setup manual for the FMA device for further information.

While the TV is in FTG Mode:

- Users can still access the Installer Menu using an LG Installer Remote; however, all Installer Menu items will be read-only.
- Any FTG configuration changes must be made using the FTG Configuration Application. FTG Channel Map Configuration and FTG Installer Menu Configuration Utilities enable you to make changes, respectively, to the FTG Channel Map and FTG Installer Menu settings as necessary. Based on the initial method used to configure the TV for FTG Mode operation (via CPU or EBL), all subsequent changes must be transferred to the TV/EBL via a process that is in accordance with that method.
- If it becomes necessary to reset the TV to Pass-through Mode, there are several options that will enable you to do so. Refer to Reference section, “Resetting a TV to Pass-through Mode,” for further information.

Pages 36 to 39 provide overviews of the FTG Channel Map, FTG Installer Menu, and FMA Configuration Utilities that comprise the FTG Configuration Application. Refer to the **Free-To-Guest (FTG) Configuration Application** manual for further information on the FTG Configuration Application.

# FTG Mode of Operation Overview (Cont.)

## Determining the TV Operating Mode

To determine the operating mode of the TV, press **MENU** on the Installer Remote. The menu display alternates based on the operating mode. See examples below.

If the end user Function Menu appears, the TV is in FTG Mode. If the TV setup menus appear, the TV is in Pass-through Mode.

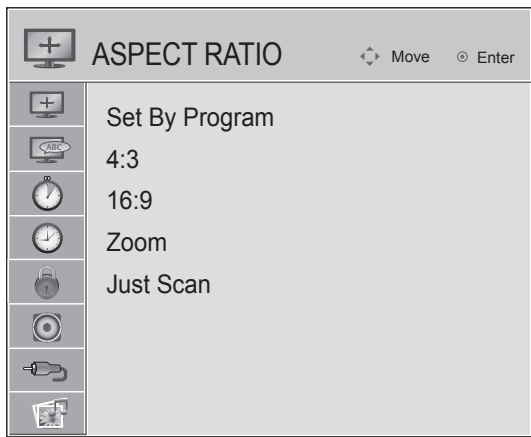

### Function Menu

Indicates the TV (CPU or EBL) is in FTG Mode. While the TV is in FTG Mode, Installer Menu settings can be accessed as read-only using an Installer Remote. To make changes, use the FTG Configuration Application.

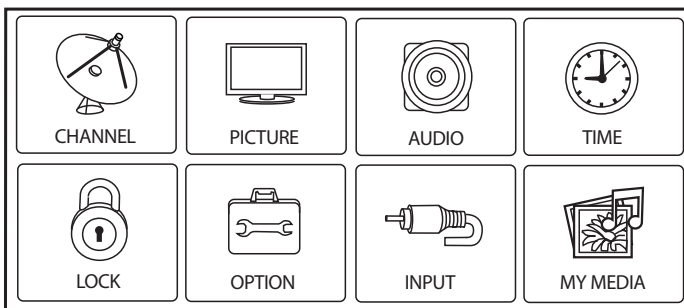

### TV Setup Menu

Shows that the TV is in Pass-through Mode.

## Creating an FMA Configuration File using the FTG Configuration Application

This section describes how to create an FMA Configuration file that can be saved to a USB memory device. In order to enable Pro:Idiom decryption, it is recommended that you create an FMA Configuration file using the FTG Configuration Application. However, if you do not know the RF channels at the site, there is an option to save (Learn) an FMA Configuration file from a TV (see “Learning an FMA Configuration File from a TV” on page 33).

The procedure below provides an overview of the steps required to create an FMA Configuration (.fma) file. Refer to the **Free-To-Guest (FTG) Configuration Application** manual for further information. See also FTG Configuration Application sample screens on pages 36 to 39.

**Note:** FTG Configuration Application software is available online at: [www.LGcommercial.com/FTGsoftware](http://www.LGcommercial.com/FTGsoftware).

1. Install (if necessary) and launch the FTG Configuration Application (v5.0.0 or higher) on the PC that will be used to create the FMA Configuration file.
2. Either:
  - Open an existing FTG Configuration (.rml) file, if applicable, to use its FTG Channel Map. Otherwise, create a new FTG Channel Map using the FTG Channel Map Editor in the FTG Channel Map Configuration Utility. Then, continue with step 3.
  - Note:** Up to 141 logical channels can be defined in the FTG Channel Map.
  - To view and/or base a new FMA Configuration file on an existing LD340H/LD345H FMA Configuration file, click **Configure** in the FTG Configuration Application menu bar, and select **FMA** to access the FMA Configuration Utility. Then, click the **Open** button above the FMA Configuration List, and double-click the desired (.fma) file. A list of the file’s contents will be displayed in the FMA Configuration List window, and you can edit the FMA Configuration List as necessary to create a new file. Proceed to step 4 when you are ready to continue.
3. Click **Configure** in the FTG Configuration Application menu bar, and select **FMA** to access the FMA Configuration Utility.
4. To add an FTG Channel Map, click >> under FTG Channel Map to copy the current FTG Channel Map to the FMA Configuration List.
 

**Note:** If you make any change(s) in the FTG Channel Map Configuration Utility to the current data to be included in the FMA Configuration List, you will need to recopy the FTG Channel Map to the FMA Configuration List.
5. Load default Installer Menu settings for the LD340H/LD345H TV:
  - Click the down arrow at the right of the Chassis field under Installer Menu Templates, and select the appropriate LD340H/LD345H option (depending on the TV size) from the drop-down list of available models.
  - Click the **Load** button.
  - Use the FTG Installer Menu Configuration Utility to modify settings, if necessary. Then, return to the FMA Configuration Utility.
  - Click >> under FTG Installer Menu Settings to copy the LD340H/LD345H settings to the FMA Configuration List.
6. Click the **Save** button above the FMA Configuration List to save its contents to an FMA Configuration (.fma) file for later use.
7. Save the FMA Configuration file to a USB memory device, and proceed to “Teaching FMA Configuration to a TV” on the following page to transfer the FMA Configuration file to an LD340H/LD345H TV.

# FTG Mode via CPU (Cont.)

## Teaching FMA Configuration to a TV

This procedure describes how to “Teach” an FMA Configuration file from a USB memory device to a TV. Ensure you have completed the procedure on the previous page to create the FMA Configuration file before proceeding with the steps below.

 **Caution: If the TV EBL is already in FTG Mode, you cannot use this procedure to make changes to the FTG Channel Map and FTG Installer Menu settings. You must use a direct PC-to-TV connection as described on page 35 or an FMA head end device to reconfigure the EBL.**

1. Plug the USB memory device that contains the FMA Configuration file into the Target LD340H/LD345H TV USB IN port.
2. Press **MENU** to display the TV setup menus, use the arrow navigation keys to select/highlight either the **Option** (if TV is in Pass-through Mode) or **Lock** (if TV is already in FTG Mode) menu icon, and then press the number “7” key a total of seven times to display the USB Download Menu.
3. Use the Up/Down arrow keys to select **Teach To TV (FMA)**, and then press **ENTER**.
4. Use the Up/Down arrow keys to select the FMA Configuration file you want to install, and then press **ENTER**.

The TV will show Teaching completion progress in a new window. Do NOT remove the USB device until Teaching is complete. When Teaching is complete, the TV will tune to the first logical channel in the FTG Channel Map.

5. When Teaching is done, remove the USB memory device. The FMA Configuration should be resident on the Target TV. Also, the Target TV CPU is now in FTG Mode (if it was previously in Pass-through Mode).

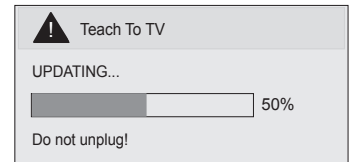
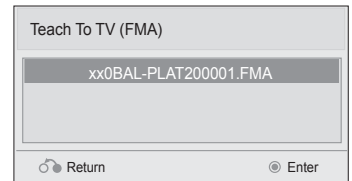
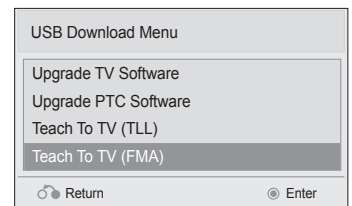

## Learning an FMA Configuration File from a TV

To ensure that Pro:Idiom decryption is enabled, it is recommended that you create an FMA Configuration file using the FTG Configuration Application as described on page 31. However, if necessary, this option enables you to save (Learn) an FMA Configuration file from an LD340H/LD345H TV to a USB memory device.

**Note:** If the LD340H/LD345H TV is NOT already in FTG Mode, you may need to perform some manual configuration on the TV before you start this procedure (see “Optional Manual Configuration / Setup for a TV” on following page).

1. Plug a USB memory device into the USB IN port on the TV.
2. Press **MENU** to display the TV setup menus, use the arrow navigation keys to select/highlight either the **Option** (if TV is in Pass-through Mode) or **Lock** (if TV is already in FTG Mode) menu icon, and then press the number “7” key a total of seven times to display the USB Download Menu.
3. To gain access to the Learn From TV options in the USB Download Menu, key in the password used to enter the Installer Menu (Example: Press **9-8-7-6**).
4. Use the Up/Down arrow keys to select **Learn From TV (FMA)**, and then press **ENTER**.
5. To identify the file from others, you can use the Up/Down arrow keys to change the last five digits of the filename. Press **ENTER** when you are ready to initiate Learning.  
The TV will show Learning completion progress in a new window. Do NOT remove the USB device until Learning is complete. When Learning is complete, the USB Download Menu will reappear on screen.
6. When you are finished, remove the USB memory device.

 **Note: It is highly recommended that you open this FMA Configuration file in the FTG Configuration Application—BEFORE transferring (Teaching) the file to any TVs—to verify FTG Channel Map and FTG Installer Menu settings and enable Pro:Idiom decryption by marking Encrypted channels. This will also enable you to confirm and add channel attributes, labels, etc.**

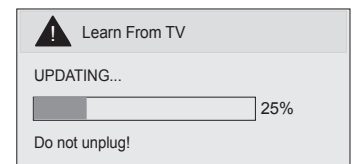
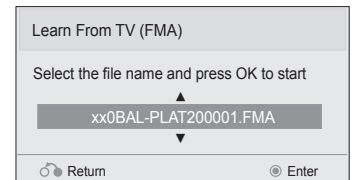
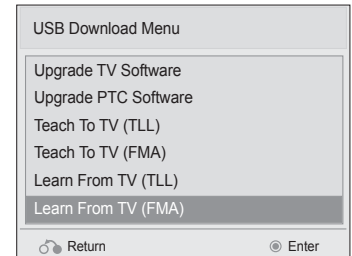

# FTG Mode via CPU (Cont.)

## Optional Manual Configuration / Setup for a TV

The manual configuration procedures below should only be performed if you do not know the RF channels at the site and need to “Learn” an FMA Configuration file from an LD340H/LD345H TV as described on the previous page. Ensure the TV is in Pass-through Mode before you begin.

### Set Installer Menu Items

These steps provide specific instruction only on the Installer Menu items that should be set on an LD340H/LD345H TV. Refer to pages 14 to 20 for detailed information on all Installer Menu items.

1. Make sure the TV is ON. Then, use the Installer Remote to enter the TV Installer Menu: Press **MENU** repeatedly until the on-screen setup menus lock up, and then press **9-8-7-6 + ENTER**.
2. Set Installer Menu item **117 FACT DEFAULT** to **001** and press **ENTER** on the Installer Remote.

This clears all Installer Menu custom settings, the channel lineup, etc. and reloads the factory default settings. The value will change back to 0 after the internal TV controller (PTC) has been restored to factory default condition. This step ensures that the TV Channel Memory will be the active channel lineup.

3. Set Installer Menu item **003 BAND/AFC**, as appropriate.
  - Broadcast: Set to 000.
  - CATV: Set to 001 (default).
  - HRC: Set to 002.
  - IRC: Set to 003.
4. Set any other Installer Menu items that affect your TV programming network to the required configuration. For example, enable/disable Aux sources, set a Start Channel, etc.
5. After you have adjusted all required Installer Menu item settings, press **ENTER** once on the Installer Remote to save your changes; then, press **ENTER** again to exit the menu.

### Run Auto Tuning (Channel Search)

**Note:** In the FMA Configuration file, Logical Channel numbers will automatically be assigned in ascending order, starting with 0 (zero), to the Physical Channels from the TV Channel Map.

**Note:** Pro:Idiom decryption for encrypted channels will not be enabled unless you use the FTG Configuration Application to set the channel attributes.

1. Search for all available analog and digital channels: Use the Installer Remote to go to the Channel Menu, select the **Auto Tuning** option, and follow the on-screen instructions.
2. Use the **Channel Edit** option in the Channel Menu to edit the channel lineup, as necessary, to include free to guest channels only. Add/delete channels per your system requirements. \*

Once you have completed these procedures, return to “Learning an FMA Configuration File from a TV” on the previous page to complete the Learn sequence.

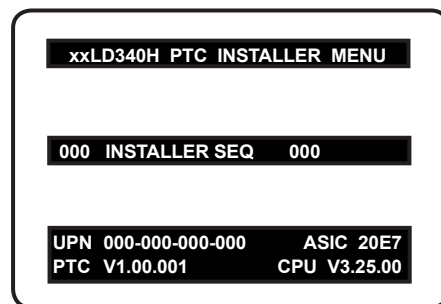

Typical TV Installer Menu

Note: The Installer Menu header will vary depending on the TV you are setting up.



Adjust the settings for these Installer Menu items.

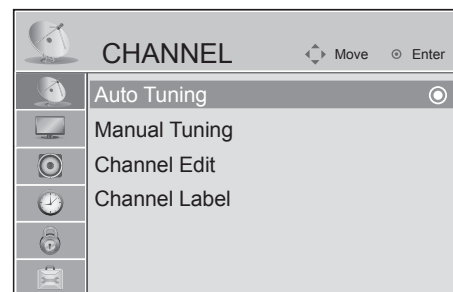

Run Auto Tuning and edit the channel lineup, as necessary.

\* If Installer Menu item 103 ATSC TUNE MODE is set for Physical Channel tuning (default and recommended setting), minor channel numbers cannot be higher than 255. If set for Virtual Channel tuning, neither major nor minor channel numbers can be higher than 255.

The following steps outline local FTG configuration of individual TV EBLs using a direct PC-to-TV connection. Refer to the **Free-To-Guest (FTG) Configuration Application** manual for further information. See also FTG Configuration Application sample screens on pages 36 to 38.

**Note:** FTG Configuration Application software is available online at: [www.LGcommercial.com/FTGsoftware](http://www.LGcommercial.com/FTGsoftware).

**Caution:** If the TV CPU is already in FTG Mode, you cannot use this procedure to make changes to the FTG Channel Map and FTG Installer Menu settings. Instead, refer to and use the processes described on pages 31 and 32 to reconfigure the TV CPU.

1. Install (if necessary) and launch the FTG Configuration Application (v5.0.0 or higher) on the PC that will be used to configure the EBL.
2. Build a Channel Map using the FTG Channel Map Editor in the FTG Channel Map Configuration Utility (or, if applicable, open an existing FTG Configuration [.rml] file).  
**Note:** Up to 141 logical channels can be defined in the FTG Channel Map.
3. Connect the PC to the TV-LINK CFG jack on the TV's rear connections panel using a USB-to-TTL serial cable (TTL-232R-5V-AJ). If necessary, install the device driver on the PC.
4. Turn ON the TV. Note: The TV will briefly display a green text banner that shows the EBL firmware version and release date.
5. "Write" the FTG Channel Map to the EBL (switches the EBL from Pass-through Mode to FTG Mode).
6. "Read" the current FTG Installer Menu settings from the EBL using the FTG Installer Menu Configuration Utility. If necessary to make changes to Installer Menu items, "Write" them back to the EBL in FTG Mode.
7. Save the FTG Channel Map and FTG Installer Menu settings to an FTG Configuration (.rml) file for future use.
8. Tune the TV to a Logical Channel in the FTG Channel Map.

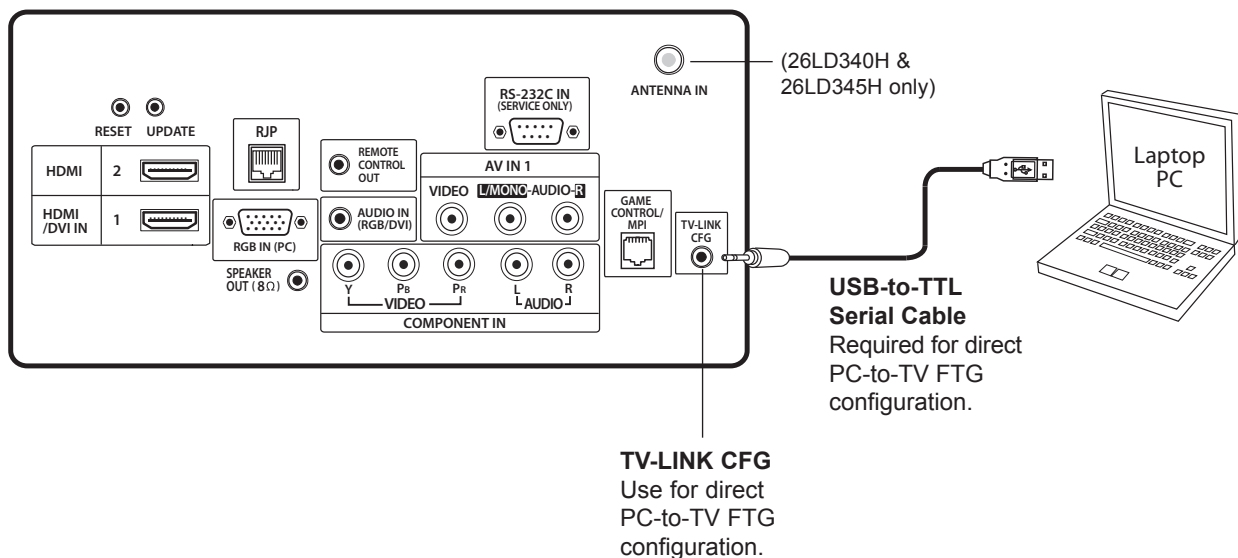

# FTG Configuration Application Utilities Overview

## FTG Channel Map Configuration Utility

The FTG Channel Map Configuration Utility enables you to build a Channel Map with logical channel numbers.

**Note:** Write, Read, and Learn functions in the FTG Channel Map Configuration Utility are used for direct PC-to-TV FTG configuration of LD340H/LD345H TVs (FTG Mode via EBL). These functions are not applicable to the process of creating an FMA Configuration file to be saved to a USB memory device (FTG Mode via CPU).

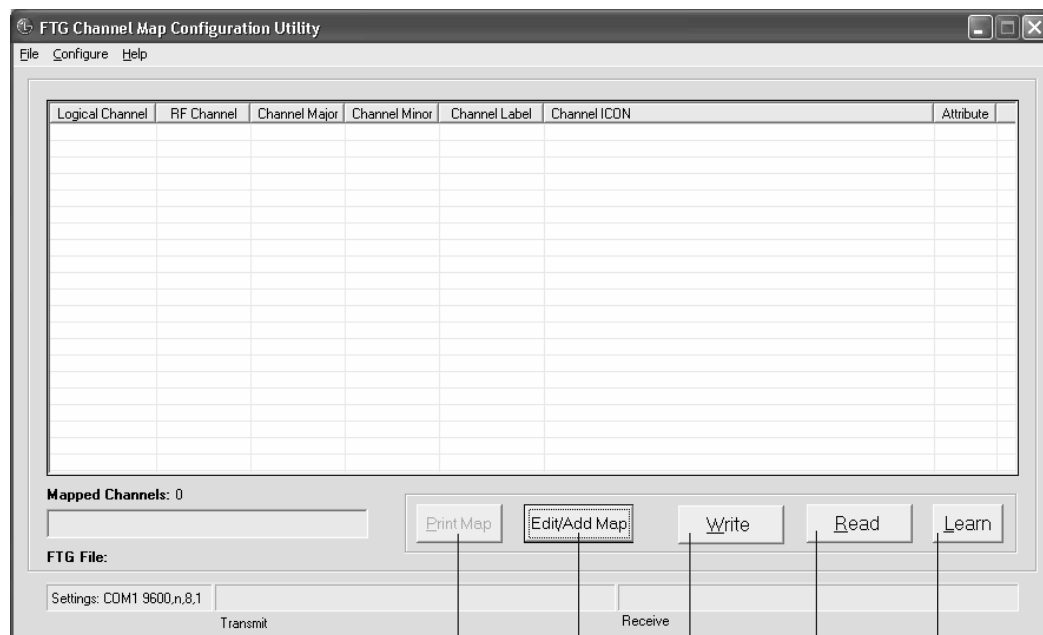

### PRINT MAP

Click to display a printable FTG Channel Map Report. The report can also be exported as an HTML or Text file.

### EDIT/ADD MAP

Click to open the FTG Channel Map Editor to create or edit an FTG Channel Map (see next page).

### LEARN

Click to transfer the TV Channel Map from the PTC to the EBL and the FTG Configuration Application. (Requires that 2-5-5 + MENU was performed to transfer TV Channel Map to PTC.) \*

### READ

Click to transfer the FTG Channel Map from the EBL to the FTG Configuration Application.

### WRITE

Click to transfer the FTG Channel Map to the EBL. This will switch the EBL from Pass-through Mode to FTG Mode.

\* Logical Channel numbers will automatically be assigned in ascending order, starting with 0 (zero), to the Physical Channels from the TV Channel Map.



# FTG Configuration Application Utilities Overview (Cont.)

## FTG Channel Map Editor

The FTG Channel Map Editor shows a single Logical Channel's Data and the FTG Channel Map.

### LOGICAL CHANNEL MAPPING

Select a Logical Channel number, then assign it the RF, Major, and Minor channel numbers to complete the mapping.

### CUSTOM CHANNEL LABELS/ICONS

Enter custom labels and select icons by name on menu or by number.

### SET CHANNEL ATTRIBUTES

Check/select Encrypted, OSD, or Blank Video.

Logical Channel	RF Channel	Channel Major	Channel Minor	Channel Label	Channel ICON	Attribute
2	2	2	0	WBBM-TV	14 - CBS	0
5	5	5	0	WMAQ-TV	15 - NBC	0
7	7	7	0	WLS-TV	13 - ABC	0
9	9	9	0	WGN-TV	89 - WGN	0
11	11	11	0	WTTW	17 - PBS	0
14	31	31	3	FOX	16 - FOX	0
15	19	19	3	WGN	89 - WGN	0
16	47	47	4	KIDS	133 - PBS Kids	0
17	27	27	3	THE U	174 - UPN	0
40	65	65	1	HBO-HD	12 - HBO	EO
41	66	66	1	ESPN-HD	2 - ESPN	EO
42	67	67	1	ESPN2HD	21 - ESPN2	EO
43	68	68	1	TNT-HD	4 - TNT	EO
44	69	69	1	HDNET	161 - HDNet	EO
52	74	74	1	STARZHD	33 - Starz	EO
53	75	75	1	HISTHD	58 - History	EO
54	76	76	1	MAX-HD	47 - Cinemax	EO

### UPDATE

After editing an existing Logical Channel's data, click to commit the changes in the FTG Channel Map.

### ADD

After defining a new Logical Channel, click to add channel to the FTG Channel Map.

### DELETE

Click to remove highlighted channel from FTG Channel Map.

### EXIT

Click to exit editor and return to FTG Channel Map Configuration Utility.

# FTG Configuration Application Utilities Overview (Cont.)

## FTG Installer Menu Configuration Utility

**Note:** Write, Read, Learn, and IR Remote Access functions in the FTG Installer Menu Configuration Utility are used for direct PC-to-TV FTG configuration of LD340H/LD345H TVs (FTG Mode via EBL). These functions are not applicable to the process of creating an FMA Configuration file to be saved to a USB memory device (FTG Mode via CPU).

### CONFIGURATION SETTINGS

Select tabs for categories of Installer Menu items to set up TV.

### HOSPITAL-GRADE TV ONLY

Set Hospital items on Installer Menu for hospital-grade TVs.

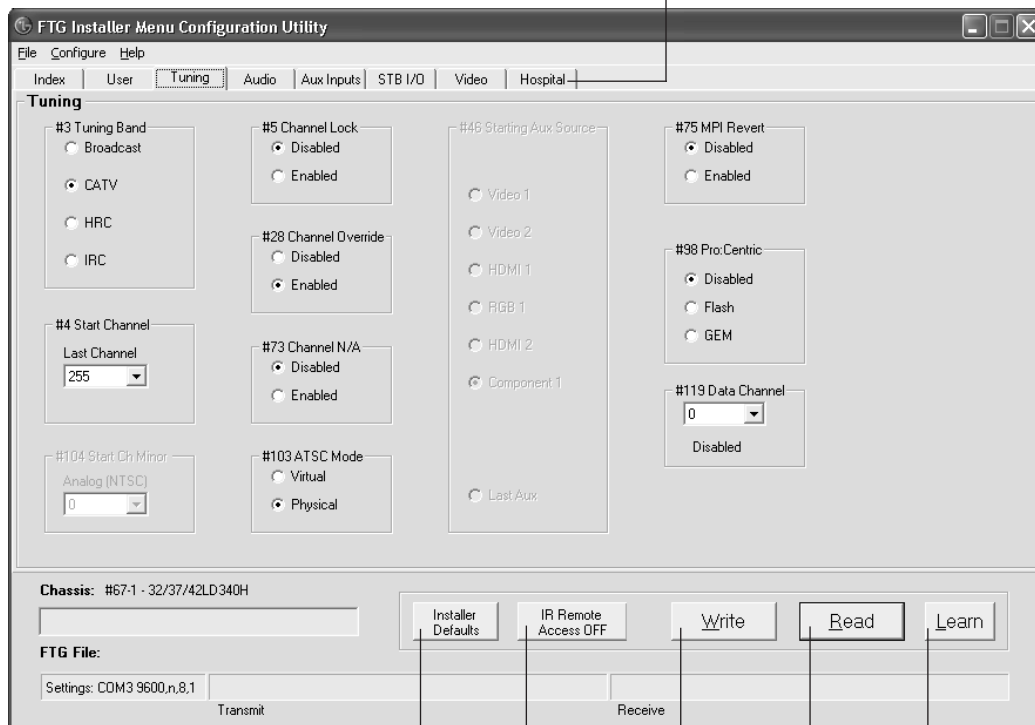

### INSTALLER DEFAULTS

Click to reset FTG Installer Menu items shown in the FTG Configuration Application to defaults.

### IR REMOTE ACCESS

Toggle IR Remote Access to ON to obtain access to TV setup menus and Installer Menu.

### WRITE

Click to transfer the FTG Installer Menu settings to the EBL.

### LEARN

Click to transfer Installer Menu settings from the PTC to the EBL and FTG Configuration Application. \*

### READ

Click to transfer the Installer Menu settings in the EBL to the FTG Configuration Application.

\* Logical Channel numbers will automatically be assigned in ascending order, starting with 0 (zero), to the Physical Channels from the TV Channel Map.

# FTG Configuration Application Utilities Overview (Cont.)

## FMA Configuration Utility

**Note:** FMA Write, Read, Clock, Broadcast, Firmware, and IP Communication functions in the FMA Configuration Utility are used to configure *b*-LAN enabled equipment (Example: FMA-LG101) at the hotel/institution head end. These functions are not applicable to the process of creating an FMA Configuration file to be used with LD340H/LD345H TVs (FTG Mode via CPU).

### FMA CONFIGURATION LIST (data to be saved or already saved in FMA Configuration file)

Filename of opened FTG Configuration file (if applicable)

Copy FTG Channel Map to and from FMA Configuration List.

Copy FTG Installer Menu settings to and from FMA Configuration List.

Load default FTG Installer Menu for LD340H/LD345H.

The screenshot shows the 'FTG Management Appliance (FMA) Configuration Utility' window. It features a menu bar with 'File', 'Configure', and 'Help'. The main interface is divided into several sections:

- FTG File:** Includes a text field for the filename and buttons for 'New', 'Open', and 'Save'.
- FTG Channel Map:** A list box containing '17 Mapped Channels' with 'Left' and 'Right' arrow buttons for copying data to and from the FMA Configuration List.
- FTG Installer Menu Settings:** A text field showing '#67-1 - 32/37/42LD340H (Items Default)' with 'Left' and 'Right' arrow buttons for copying data to and from the FMA Configuration List.
- Installer Menu Templates:** A dropdown menu for 'Chassis' (set to 'Select Model') and a 'Load' button. A note below states: 'Note: A template contains the default settings pertaining to its chassis model'.
- FMA Configuration:** A central section containing:
  - 'FMA File' buttons: 'New', 'Open', 'Save'.
  - 'FMA Configuration List': A table with one row containing '17 Mapped Channels' and 'IM (Items Default) 32/37/42LD340H', and a 'Remove Item' button.
  - 'FMA Configuration Transfer': 'Write' and 'Read' buttons.
- FMA Clock:** 'Date & Time' section with 'Auto' checked, 'DST' checked, and a 'Set Clock' button.
- FMA Broadcast:** 'Adjust Rate (0-999 sec)' section with a dropdown set to '60' and a 'Set Rate' button.
- FMA Firmware Version:** A text field and a 'Get FW' button.
- FMA IP Communication:** 'Configuration Utility's IP Address' section with a text field set to '10.20.1.120'. An 'Important' note below states: 'To communicate with the FMA, confirm the Utility's IP Address is set to the FMA's IP Address.'



**Note:** The data referenced in the FMA Configuration List is only a snapshot of the current FTG Channel Map and FTG Installer Menu settings when copied to the list. If you make any change(s) to the current data to be included in the FMA Configuration List, you will need to recopy Channel Map and Installer Menu settings to the FMA Configuration List.

# Remote Jack Pack / TV Connections & Setup

## Remote Jack Pack Setup

RJP Available? If you will use a Remote Jack Pack (RJP) in your system, set Installer Menu item **093 RJP AVAILABLE** appropriately (for example, on a legacy model RJP: HDMI Mode, set RJP AVAILABLE to 001). See Installer Menu detailed descriptions for further information.

**093 RJP AVAILABLE 001**

## TV Connections

**!** Make these connections **ONLY** after Commercial Mode Setup and TV Cloning procedures are complete.

Refer to the figure below, and connect the RJ-45 Control cable from the RJP cable bundle to the RJP INTERFACE port on the TV's jack panel. Then, connect HDMI, RGB, and Composite Video/Audio connectors, as applicable, for the cable bundle.

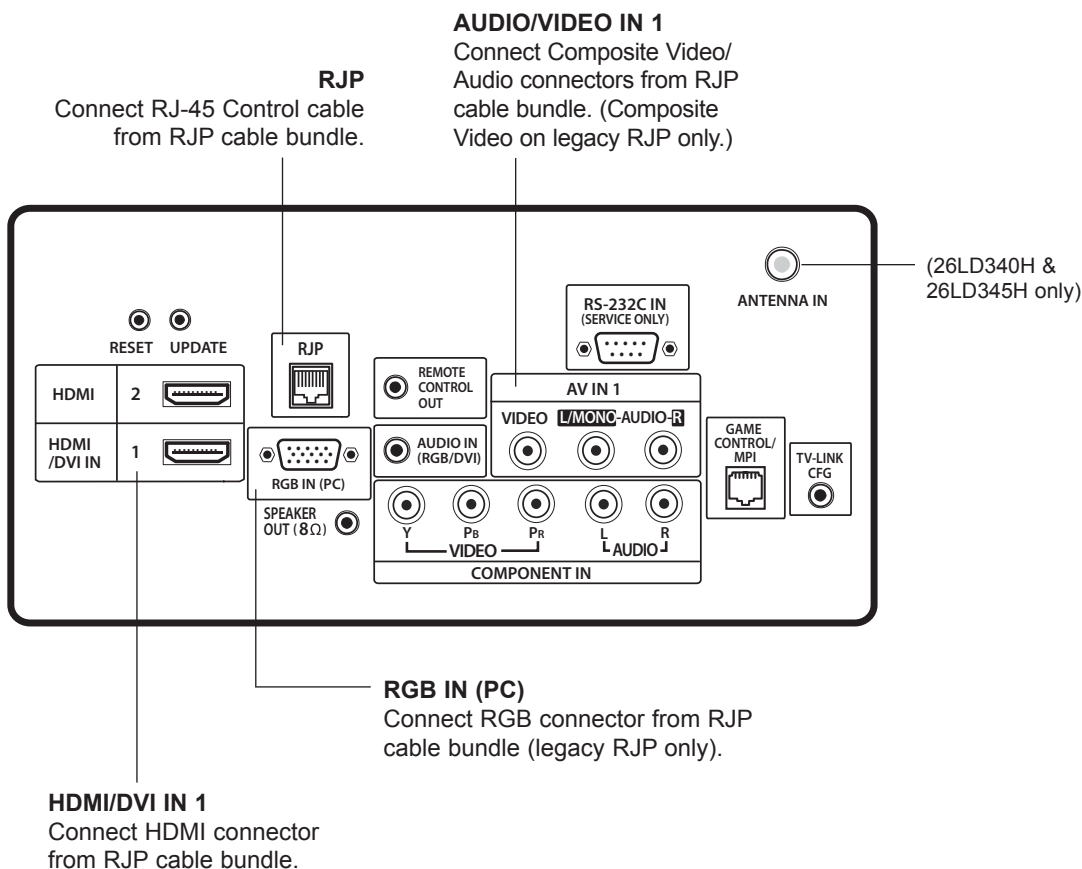

# Reference: Upgrading TV/PTC Software using a USB Memory Device

## Checking the Software Versions

You can check the software versions of the TV by accessing the Installer Menu with the Installer Remote: Press **MENU** repeatedly until the on-screen setup menus lock up, and then press **9-8-7-6 + ENTER**. When you are finished, press **ENTER** again to exit the Installer Menu.

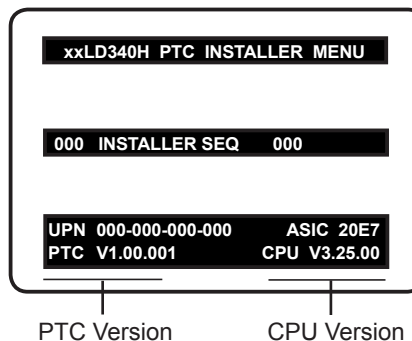

Typical Installer Menu

## Upgrading TV/PTC Software

Before you begin, note that the software upgrade files must be stored in a folder named "LG\_DTV" in the root directory of the USB memory device. Also, ensure the USB device has been formatted with FAT format.

**Note for TV Software Upgrade only:** If the TV detects a later version of software on the USB device, it will automatically display a dialog from which you can start the software upgrade immediately. Otherwise, you can close the dialog, and access the USB Download Menu as described below.

1. Turn the TV ON.
2. Plug the USB memory device into the USB IN port on the TV.
3. Press **MENU** on the Installer Remote to display the TV setup menus.
4. Use the arrow navigation keys to select/highlight either the **Option** (if TV is in Pass-through Mode) or **Lock** (if TV is in FTG or LodgeNet PPV Mode) menu icon; then, press the number "7" key a total of seven times to display the USB Download Menu.
5. Use the Up/Down arrow keys to select **Upgrade TV Software** or **Upgrade PTC Software**, as applicable, and press **ENTER**.
6. Select the appropriate option(s), depending on the type of upgrade you are performing:
  - TV Software Upgrade: (See screen samples at right.) Select **TV Software Update** from the first TV Software Update window. In the second TV Software Update window, select/highlight the update file to install and press **ENTER**.  
**Note:** Do not select Forced Update options unless you have been specifically instructed to do so or have previous experience with Expert Software Updates.
  - PTC Software Upgrade: In the PTC Software Update window, select/highlight the update file to install and press **ENTER**.  
**Note:** The PTC Software Update window is similar to the second TV Software Update window, though there are no Forced Update options. Current software version information is shown at the top and update files on the USB device are listed at the bottom of the window.

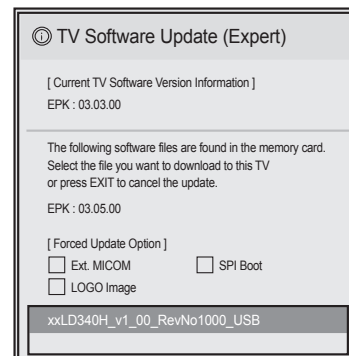
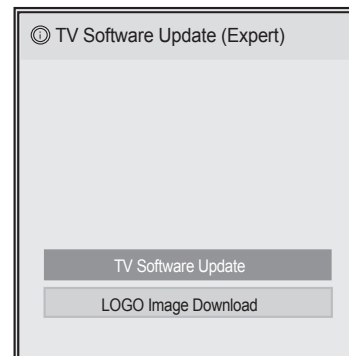
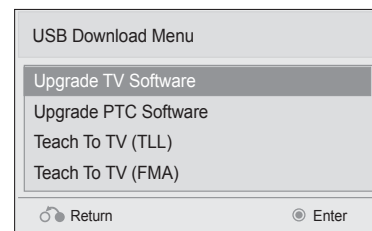

The TV will show update completion progress in a new window. Do NOT remove the USB device until the software upgrade is complete. When a TV software upgrade is complete, the TV will reset itself with an automatic restart. When a PTC upgrade is complete, the TV will turn OFF.

# Reference: Downloading a Splash Screen using a USB Memory Device

## Splash Screen Image File Guidelines

- The splash screen image must be a baseline (not progressive) JPEG.
- The image should be no larger than 1 MB.
- The ideal size for the image is 1366 x 768 pixels or under.
- The image file must be stored in a folder named “LG\_DTV” in the root directory of USB memory device.
- Ensure the USB device has been formatted with FAT format.

## Downloading a Splash Screen Image

1. Turn the TV ON.
2. Plug the USB memory device into the USB IN port on the TV.
3. Press **MENU** on the Installer Remote to display the TV setup menus.
4. Use the arrow navigation keys to select/highlight either the **Option** (if TV is in Pass-through Mode) or **Lock** (if TV is in FTG or LodgeNet PPV Mode) menu icon; then, press the number “7” key a total of seven times to display the USB Download Menu.
5. Use the Up/Down arrow keys to select **Upgrade TV Software**, and then press **ENTER**.
6. Select **LOGO Image Download** from the first TV Software Update window.
7. In the second TV Software Update window, use the Up/Down arrow keys to select the image file to download, and then press **ENTER**.

The TV will show download completion progress in a new window. Do NOT remove the USB device until the image download is complete. When the image download is complete, the TV will reset itself with an automatic restart. Upon the restart, you should see the new splash screen.

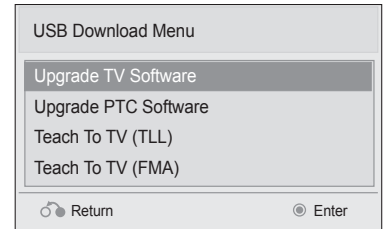

## Reference: Power Consumption Settings

The following tables assume that Installer Menu item 118 POWER SAVINGS is set to 003 (default) and Installer Menu item 099 BACK LIGHTING is set as shown below (default value is 100).

Item 099 Back Lighting (Static)	26LD340H / 26LD345H		32LD340H / 32LD345H		37LD340H / 37LD345H		42LD340H / 42LD345H	
	Power Consumption (Watts)	Percent Savings	Power Consumption (Watts)	Percent Savings	Power Consumption (Watts)	Percent Savings	Power Consumption (Watts)	Percent Savings
100	56.82	0.00%	72.97	0.00%	88.92	0.00%	107.53	0.00%
90	51.98	8.52%	63.82	12.54%	84.19	5.32%	86.68	19.39%
80	47.09	17.13%	58.53	19.78%	77.84	12.46%	78.79	26.73%
70	42.06	25.97%	53.58	26.57%	72.19	18.81%	72.81	32.29%
60	39.71	30.12%	44.24	39.38%	66.28	25.46%	66.78	37.89%
50	37.36	34.25%	41.27	43.45%	60.90	31.51%	60.61	43.63%
40	36.31	36.10%	38.71	46.95%	56.58	36.37%	56.35	47.60%
30	35.12	38.19%	36.20	50.39%	52.35	41.13%	52.90	50.81%
20	32.59	42.64%	33.51	54.07%	47.75	46.30%	47.71	55.63%
10	30.23	46.80%	31.01	57.51%	43.68	50.88%	43.04	59.98%
1	27.95	50.82%	28.55	60.87%	39.62	55.44%	38.86	63.86%

Item 099 Back Lighting (Dynamic)	26LD340H / 26LD345H		32LD340H / 32LD345H		37LD340H / 37LD345H		42LD340H / 42LD345H	
	Power Consumption (Watts)	Percent Savings	Power Consumption (Watts)	Percent Savings	Power Consumption (Watts)	Percent Savings	Power Consumption (Watts)	Percent Savings
200	72.19	0.00%	75.45	0.00%	110.86	0.00%	125.41	0.00%
190	68.21	5.51%	69.23	8.25%	99.05	10.65%	111.41	11.16%
180	63.72	11.74%	65.26	13.51%	92.33	16.72%	103.30	17.63%
170	59.21	17.99%	60.72	19.53%	85.39	22.98%	95.29	24.02%
160	55.04	23.76%	56.29	25.40%	78.61	29.10%	87.64	30.11%
150	50.81	29.62%	51.82	31.33%	71.70	35.32%	79.71	36.44%
140	46.03	36.24%	46.62	38.21%	63.53	42.69%	70.73	43.60%
130	41.49	42.53%	41.67	44.78%	55.65	49.80%	61.80	50.72%
120	36.32	49.69%	36.14	52.10%	47.34	57.30%	51.86	58.65%
110	31.52	56.34%	31.11	58.76%	39.90	64.01%	42.90	65.79%
101	26.95	62.67%	26.41	65.00%	33.00	70.24%	34.52	72.47%

Note: Values are results of controlled experiments under laboratory conditions.

# Reference: TV Camport Auto Sense Operation

The Camport Auto Sense function is enabled when:  
 1. Installer Menu item 034 CAMPORT EN is set to 1 AND  
 2. Installer Menu item 040 AUTO CAMPORT is enabled (1).

**Selectable:** Can be accessed with INPUT key, direct access, etc.

**Auto Sense:** TV switches to this input when connector is inserted. The Camport (Side [AV IN 2] Video) has the highest priority and will override any commands including tuning to the Start Channel.

## CAMPORT (Side Video) Functionality Control

Item 034 CAMPORT EN	Item 040 AUTO CAMPORT	Side (AV IN 2) Video Operation
0	0	Disabled
0	1	Disabled
1	0	Selectable
1	1	Auto Sense

### Campport Operation (Stand-alone)

When Campport Auto Sense is enabled as above, the TV's source will switch to the Side (AV IN 2) Video Aux source whenever a plug is inserted into the AV IN 2 Video input.

When the plug is removed, the TV will switch back to the previous channel or input source that was being displayed before the plug was inserted. However, if any direct access to an RF channel or Aux channel is requested while the Camport is active, then, when the video plug is removed, the TV will switch to the last requested channel. Source changes using any Source keys (INPUT) are ignored. Channel Up/Down and Flashback commands are not direct access tuning commands, and they are also ignored.

Previous State Before Inserting CAMPORT	Operation While CAMPORT is Active	State Upon Removal of CAMPORT
Aux or RF Channel	None	Previous Aux or RF Channel
Aux or RF Channel	Direct Access	Last Requested Aux or RF Channel
Aux or RF Channel	Ch Up/Down, Flashback, and Input Keys	Previous Aux or RF Channel

### Campport Operation (FTG or PPV)

The operation will be similar to that of the Stand-alone Mode. However, when the Channel Map is maintained external to the PTC (i.e., FTG and PPV), Channel Up/Down or Flashback keys are sent as Direct Access tuning commands to the PTC/TV.

Previous State Before Inserting CAMPORT	Operation While CAMPORT is Active	State Upon Removal of CAMPORT
Aux or RF Channel	None	Previous Aux or RF Channel
Aux or RF Channel	Direct Access	Last Requested Aux or RF Channel
Aux or RF Channel	Ch Up/Down, Flashback, and Input Keys	Last Requested Aux or RF Channel



# Reference: TV Aux Input Configuration

DIRECT ACCESS Tuning		TV		ENABLE				MPI DATA			START AUX SOURCE ASSIGNMENT
				Installer Menu		MPI DATA STATUS TYPE 0x41 SOURCES ENABLED (R/W)		DATA STATUS TYPE 0xD2 CURRENT AV SOURCE (R)		DATA STATUS TYPE 0x0D AUX SOURCE (R)	
OLD_OCV = 0	OLD_OCV = 1	Source Input	Source Mode	Number	Labeling	Value	Labeling	Value	Labeling		
130	90	Video2 (Side)	CV	34	CAMPORT_EN	0x01	Video Front (Camport)	0	Video Front (Camport)	0 (VIDEO)	2
131	91	Video1 (Rear)	CV	39	REAR_AUX_EN	0x02	Rear Video (Aux)	1	Rear Video (Aux)	0 (VIDEO)	1
132	92	HDMI2	DTV/PC	91	YPrPb2 EN = 1	0x04	S-Video Rear	2	S-Video Rear	0 (VIDEO)	5
133	93	HDMI1/DVI	DTV/PC	35	COMPPORT_EN = 1	0x08	Front Computer	3	Front Computer	0 (VIDEO)	3
134	94	RGB	PC	87	REAR RGB EN = 2	0x10	SVGA Rear Computer	4	SVGA Rear Computer	2 (COMPUTER)	4
136	96	Component		38	YPrPb EN	0x40	Y/UV Component	6	Rear Y/PrPb Component Video	0 (VIDEO)	6

## Reference: *b*-LAN Setup & Overview

---

The *b*-LAN module is internal to the TV. It allows hotel/institution head end equipment with *b*-LAN technology to communicate, via the institution's RF distribution system, with the TV for configuration and control.

**Note:** MPI cards with *b*-LAN technology—LMT7Z5, LMT7Z7, LMT7Z9—are NOT supported in TVs in which *b*-LAN technology is already integrated.

Power to the *b*-LAN module is controlled by Installer Menu item 118 POWER SAVINGS. The default value is 003—the *b*-LAN module is only powered when the TV is turned ON. See chart below.

POWER SAVINGS	TV Standby State	TV Power On State
	<i>b</i> -LAN Power	<i>b</i> -LAN Power
001	On	On
003 (default)	Off	On

A *b*-LAN enabled head end device, such as an LG FMA-LG101, broadcasts over the RF distribution system to communicate to multiple TVs. When the TV is first installed, it must be turned ON in order for its embedded *b*-LAN module to receive communication from the head end device. At this point, if it is desired for the *b*-LAN module to always be powered, including while the TV is in Standby, set Installer Menu item 118 POWER SAVINGS to 001.

# Reference: RJP Model List and Input Auto-sensing Hierarchy

---

## RJP Model List

<b>Legacy Models</b>	<b>Scaler Models</b>
RJP-101M	N/A
RJP-101ML	N/A
RJP-110F	RJP-210F
RJP-110FW	RJP-210FW
RJP-110W	RJP-210W
RJP-110WBR	RJP-210WBR
RJP-110S	RJP-210S
RJP-120G	RJP-220G
RJP-120T	RJP-220T
RJP-201B	RJP-301B
RJP-202B	RJP-302B

## RJP Input Auto-sensing Hierarchy

<b>Priority</b>	<b>Video</b>	<b>Audio</b>
1st (Highest)	Digital Video In	Audio In (3.5mm)
2nd	PC Video In	Audio In (L/R)
3rd	Video In	Digital Video In

# Resetting a TV to Pass-through Mode

---

This section describes how you can reset a TV that is currently in FTG Mode to Pass-through Mode. Note that the reset to Pass-through Mode will also restore all factory default settings on the TV.

## FTG Mode via CPU

There are three options for resetting Pass-through Mode on TVs that are in FTG Mode via the CPU. The first and second options enable you to reset a single TV to Pass-through Mode, while the third option enables you to reset multiple TVs to Pass-through Mode at one time.

- A predefined value for Installer Menu item 117 FACT DEFAULT enables access to initiate a factory “IN-STOP” process that will reset the TV to Pass-through Mode. Contact technical support for the required value for Installer Menu item 117 and for additional information on performing the IN-STOP from the Installer Menu.
- Using a USB memory device, “Teach” an FMA Configuration file that only contains a “0 Mapped Channels” FTG Channel Map to the TV. Refer to “Creating an FMA Configuration File using the FTG Configuration Application” and “Teaching FMA Configuration to a TV” on pages 31 and 32, respectively, for further information.
- If your system uses a Pro:Centric server for configuration, use the Pro:Centric Admin Client to load an FMA Configuration file that only contains a “0 Mapped Channels” FTG Channel Map on the Pro:Centric server. Refer to the *Pro:Centric™ Server Admin Client User Guide* for further information.

## FTG Mode via EBL

There are three options for resetting Pass-through Mode on TVs that are in FTG Mode via the EBL. The first and second options enable you to reset a single TV to Pass-through Mode, while the third option enables you to reset multiple TVs to Pass-through Mode at one time.

- A predefined value for Installer Menu item 117 FACT DEFAULT enables access to initiate a factory “IN-STOP” process that will reset the TV to Pass-through Mode. Contact technical support for the required value for Installer Menu item 117 and for additional information on performing the IN-STOP from the Installer Menu.
- Using a direct PC-to-TV connection, “Write” an unpopulated Channel Map—that is, a Channel Map with zero channels—to the TV. Refer to the “FTG Mode via EBL” procedure on page 35 and/or the *Free-To-Guest (FTG) Configuration Application* manual for further information.
- If your system uses an FMA for broadcast configuration, configure the FMA device with an FMA Configuration file that only contains a “0 Mapped Channels” FTG Channel Map to broadcast to the TV EBL(s). Refer to the *Free-To-Guest (FTG) Configuration Application* manual and/or the Installation & Setup manual for the FMA device for further information.

### Some Quick and Easy Tips for Resolving Problems

Symptom	Possible Cause(s)	Possible Solution(s)
<b>Software Problems</b>		
When direct enter channel number, "No Signal" appears.	Channel not included in channel lineup in internal TV controller (PTC).	After 2-5-5 + MENU, only channels included in the TV PTC will appear. If a channel is available, it can be added to channel lineup. If it is not available, the "No Signal" message appears on the TV screen.
<b>Power</b>		
No power.	See troubleshooting flow chart on following page.	
<b>Display Panel Picture</b>		
No picture.	Display panel is turned off.	<ul style="list-style-type: none"> <li>• Turn TV ON.</li> <li>• Power failure?</li> </ul>
	Antenna/cable not connected.	Connect antenna/cable signal to TV
	Connections incorrect.	Check connections on TV
	MPI not connected.	If applicable, connect MPI cable to MPI device.
	Encrypted program.	Try another channel.
	Wrong tuning band.	Adjust Installer Menu settings.
<b>Erratic Operation</b>		
Installer Menu setup.	Wrong Installer Menu settings.	Adjust Installer Menu settings as required.
<b>Installer Remote</b>		
Remote doesn't work.	Remote not in TV Mode.	Use MODE key to select "TV"; puts remote into TV Mode.
	Not aimed at IR remote sensor.	Point remote at IR receiver on TV.
	Remote too far from IR sensor.	Move remote closer to IR receiver on TV or darken room.
	MPI not connected.	If applicable, connect MPI cable to MPI device.
	IR path to TV's receiver obstructed.	Remove obstructions.
	Weak batteries.	Replace batteries.
	Wrong battery polarity.	Check that "+" and "-" match in battery compartment.
	Too much light in room.	Dim room light.
Wrong Installer Remote.	Requires compatible Installer Remote. Contact your LG dealer.	
<b>Picture Reception</b>		
Normal picture, poor or no sound.	Audio muted.	Press MUTE or use Volume Up key to increase sound level.
	Broadcast problem.	Try a different channel.

**Note:** For other problems not caused by the TV, refer to the other devices' operating guide(s).

# Troubleshooting (Cont.)

## Troubleshooting Flow Chart

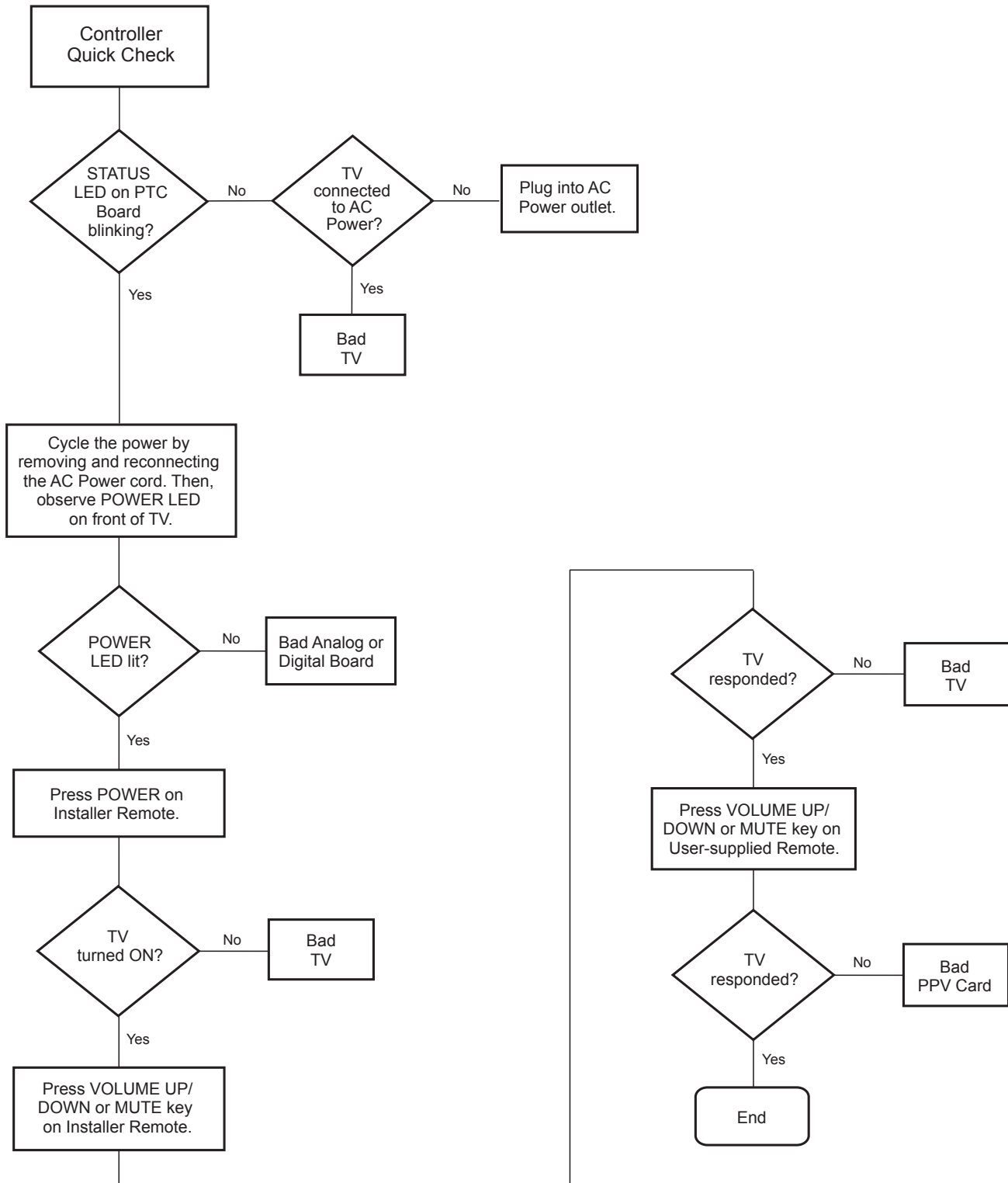

## Commercial Mode Check / FTG Operation Troubleshooting

### Commercial Mode Check

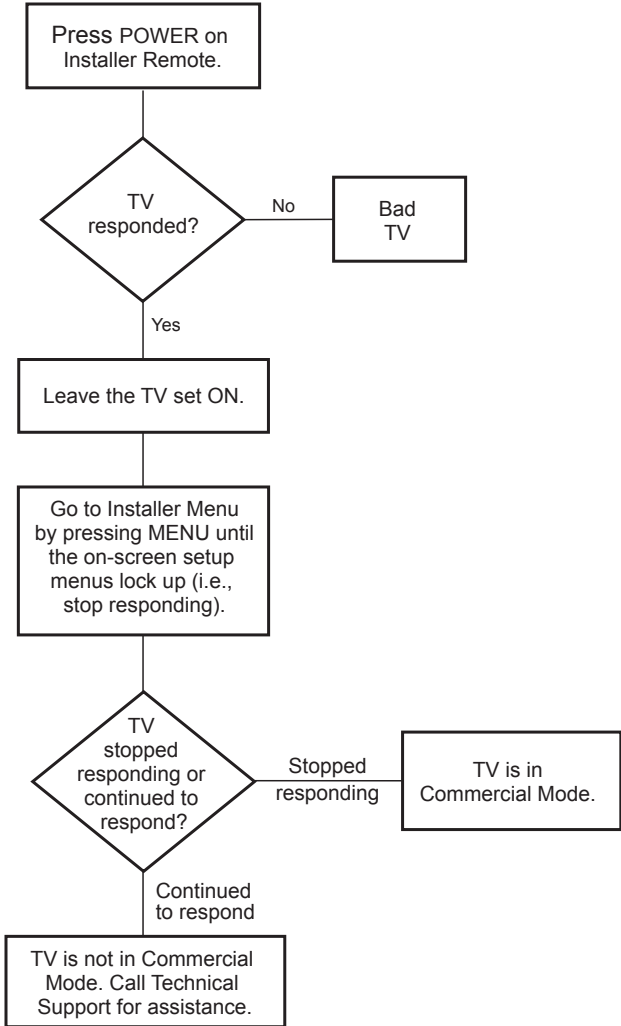

### FTG Operation Troubleshooting

The following table provides troubleshooting information for when the EBL is configured in the FTG Mode of operation.

Symptom	Possible Cause(s)	Solution(s)
Communication Error ("Communications Timeout")	Cable(s) not connected.	Check and connect communication cables.
	TV not powered.	Check/connect the TV power cord.
	TV not turned ON.	TV needs to be turned ON (default FTG Mode).
	Wrong COM (communication) port.	In the FTG Configuration Application, select the correct COM port for the cable being used.

# Troubleshooting (Cont.)

## Clone Programmer Troubleshooting



**Warning: Do not connect a clone programmer to a PPV card installed in the Master or Target TVs. Also, if the TV is in LodgeNet PPV Mode (check with the site administrator if you are not certain), do not connect a clone programmer to the GAME CONTROL/MPI port. Either of these actions will damage the clone programmer and, if applicable, the PPV card.**

### Reset Clone Programmer After Static Shock

After replacing exhausted batteries (LT2002 only), or if the clone programmer behaves strangely after a static shock:

- TLL-1100A: Turn the TLL-1100A OFF and then ON.
- LT2002: Use a paper clip or similar instrument inserted through the small hole marked RESET to activate the internal reset switch and restore normal operation.

After a reset, check the real-time clock setting. It may be necessary to set the clone programmer clock from a TV containing the correct time.

**Note:** Both the Master and Target TVs must be in Pass-through Mode for cloning purposes. See also IMPORTANT CLONING INFORMATION on page 23.

Symptom	Possible Cause(s)	Possible Solution(s)
<b>Clone Programmer</b>		
Clone copies setup in less than 30 seconds.	Not enough time to copy entire TV setup.	TLL-1100A: Turn the TLL-1100A OFF and then ON. LT2002: Press RESET on clone programmer. Then redo Learn/Teach. (Learning usually takes about 90 seconds; Teaching usually takes 3 to 4 minutes.)
Remote does not operate clone programmer.	Wrong Installer Remote.	Only use an LG Installer Remote to operate clone programmer with TV.
Clone menu does not appear on display panel screen, TLL-1100A shows error message, or LT2002 LED does not blink.	MPI cord not connected.	Connect MPI cord properly, and ensure good connection.
	TV not turned ON.	TV must be powered ON for clone programmer to work.
	(LT2002 only) Weak batteries.	Install four (4) fresh AA high-quality alkaline batteries.
	(TLL-1100A only) No charge.	Ensure the TLL-1100A is fully charged or connected to AC power.
Clone menu hard to read.	Weak signal.	Connect TV to a reliable analog channel signal source.
No time set.	Time not available.	Set time on a TV, and copy time to clone programmer.
Clone not working.	Clone programmer problem.	<ul style="list-style-type: none"> <li>• Try a different clone programmer.</li> <li>• Reset the clone programmer.</li> </ul>
Clone scans channels more than once.	Clone should only scan channels once.	Ensure TV is set up correctly, and try cloning again.

### Master and Target TVs

Cloning did not work.	Procedure interrupted.	Wait until procedure complete message is displayed.
	Different TV models.	Cloning is only possible with identical model TVs.
	Step(s) omitted or not performed.	Refer to the applicable cloning procedure(s), and make sure all tasks were performed.
(LT2002 only) Clone time disappeared.	Batteries were removed.	Batteries must remain installed to retain time settings.
New setup not present.	Target TV not reset.	Disconnect Target TV from AC power for 15 seconds.

- After cloning operations are complete, unplug the TLL-1100A/LT2002 from the TV.
- If the TV does not display a picture (blank screen) after a few seconds, just change channels.



A list of definitions for some of the words found in this guide.

## **75 OHM RF CABLE**

The wire that comes from an off-air antenna or cable service provider. The end looks like a hex-shaped nut with a wire through the middle. It screws onto the Antenna/Cable threaded jack on the back of the TV.

## **300 TO 75 OHM ADAPTER**

A small device that connects a 2-wire 300 ohm antenna to a 75 ohm RF jack. It is usually about an inch long with two screws on one end and a round opening with a wire extending out the other end.

## **A/V CABLES**

Audio/Video cables. Three cables bunched together—right audio (red), left audio (white), and video (yellow). A/V cables are used for stereo playback of videocassettes and for higher quality picture and sound from other A/V devices.

## **A/V DEVICE**

Any device that produces video or sound (VCR, DVD, cable box, or television).

## **AMPLIFIER**

An electronic device that amplifies sound from a television, CD player, VCR, DVD player, or other Audio/Video device.

## **ANTENNA**

The physical receiver of television signals sent over the air. A large metal piece of equipment does not always have to be visible to be using an antenna.

## **b-LAN**

LodgeNet Interactive Corporation proprietary RF communication system used to configure/control TV via RF distribution system.

## **CABLE**

Cable service box. Refers to the descrambler box cable subscribers use to receive cable programming signals.

## **CATV**

Programming provided by a cable service.

## **COMPONENT VIDEO**

Uses three wires for transporting three-color video signals. The end result is usually better video quality.

## **COMPOSITE VIDEO**

Typical video jack, uses one wire for transporting three-color video signals.

## **DELETE**

Lets you remove channels from the list that the end user can scroll through using Channel Up/Down.

## **DIGITAL TELEVISION**

High-resolution, cinema-quality television signals transmitted digitally.

## **DVI**

Digital Video Interface. Accommodates analog and digital interfaces with a single connector.

## **HDMI**

High-definition multi-media interface.

## **HDSTB**

High-definition set top box. Refers to a tuner device that receives high-definition television signals which have higher resolution than ordinary analog TV signals.

## **HDTV**

High-definition television. Refers to television signals that have higher resolution than ordinary analog TV signals.

## **INPUT**

Refers to the input jack that receives a signal from a TV, VCR, DVD Player, or other Audio/Video device.

## **JACK**

An input or output connector on the back of a TV, VCR, DVD Player, or other Audio/Video device.

## **MONO SOUND**

Mono (monaural) sound is one channel of sound. On more than one speaker, all the speakers play the same audio.

## **OUTPUT**

Refers to the output jack that sends a signal out of a VCR, DVD, or other A/V device.

## **PHYSICAL CHANNEL NUMBER**

The actual channel number. Analog channels use the Physical Channel number and digital channels can use a Virtual Channel number.

## **RGB (RED, GREEN, BLUE)**

Connection input or output port available for producing a video image using three separate colors: Red, Green, and Blue.

## **RS-232**

Serial communication port through which firmware is downloaded.

## **2ND AUDIO PROGRAMMING/SAP**

Second Audio Programming (SAP) is another, separate audio channel available with some programming. Choosing SAP often refers to listening to audio in another language, such as Spanish or French.

## **SIGNAL**

Picture and sound traveling through a cable, or over the air, to the TV.

## **STEREO SOUND**

Stereo (Stereophonic) sound refers to audio that's divided into right and left sides.

## **TUNER**

Device that picks up the broadcast signal and turns it into picture and sound.

## **VIRTUAL CHANNEL NUMBER**

A re-mapped channel number. Analog channels use the Physical Channel number; however digital channels use a Virtual (or false) Channel number.

## **XDS**

Extended Data Service. Additional program information included on the signal provided at the discretion of the broadcaster.

---

Note: Refer to [www.atsc.org](http://www.atsc.org) for further information.

# Document Revision History / Notes

---

## Document Revision History

Date	Description
May 2011	Revision A: New document

Product documentation is available online at: [www.LGolutions.com/products](http://www.LGolutions.com/products). From the Products page, select **TVs, Systems & Solutions**, then **LCD TVs**, then the applicable TV. Click the **Literature & Downloads** tab at the bottom of the TV page, and select the required document(s) from the Downloads list.

---

## Notes



---

For Customer Support/Service, please call:

**1-888-865-3026**

[www.LGolutions.com](http://www.LGolutions.com)

Pro:Idiom is a registered trademark of Zenith Electronics LLC. Pro:Centric is a trademark of LG Electronics U.S.A., Inc. b-LAN is a trademark of LodgeNet Interactive Corporation. All other trademarks or registered trademarks are the property of their respective owners.



**32LD330H**  
**37LD330H**

## **Lodging Guest Interactive Pro:Centric™ TVs**

---

# **Commercial Mode Setup Guide**

Note: Selected features shown in this guide may not be available on all models.

### **EXPERIENCED INSTALLER**

Commercial Mode Setup  
pages 12–13

Cloning Information  
pages 23–28

FTG Mode of Operation  
pages 29–37

For Customer Support/Service, please call:  
**1-888-865-3026**

The latest product information and documentation is available online at:  
**www.LG solutions.com/products**

MODEL and SERIAL NUMBER

The model and serial numbers of this TV are located on the back of the cabinet. For future reference, LG suggests that you record those numbers here:

Model No. \_\_\_\_\_ Serial No. \_\_\_\_\_



**WARNING:**

TO REDUCE THE RISK OF ELECTRIC SHOCK DO NOT REMOVE COVER (OR BACK). NO USER-SERVICEABLE PARTS INSIDE. REFER TO QUALIFIED SERVICE PERSONNEL.



The lightning flash with arrowhead symbol, within an equilateral triangle, is intended to alert the user to the presence of uninsulated “dangerous voltage” within the product’s enclosure that may be of sufficient magnitude to constitute a risk of electric shock to persons.



The exclamation point within an equilateral triangle is intended to alert the user to the presence of important operating and maintenance (servicing) instructions in the literature accompanying the appliance.

**WARNING:**

TO PREVENT FIRE OR SHOCK HAZARDS, DO NOT EXPOSE THIS PRODUCT TO RAIN OR MOISTURE.

**POWER CORD POLARIZATION:**

This product is equipped with a 3-wire grounding-type alternating current power plug. This plug will fit into the power outlet only one way. This is a safety feature. If you are unable to insert the plug fully into the outlet, contact your electrician to replace your obsolete outlet. Do not defeat the safety purpose of the 3-wire grounding-type plug.

**NOTE TO CABLE/TV INSTALLER:**

This reminder is provided to call the cable TV system installer’s attention to Article 820-40 of the National Electric Code (U.S.A.). The code provides guidelines for proper grounding and, in particular, specifies that the cable ground shall be connected to the grounding system of the building, as close to the point of the cable entry as practical.

**REGULATORY INFORMATION:**

This equipment has been tested and found to comply with the limits for a Class B digital device, pursuant to Part 15 of the FCC Rules. These limits are designed to provide reasonable protection against harmful interference when the equipment is operated in a residential installation. This equipment generates, uses and can radiate radio frequency energy and, if not installed and used in accordance with the instruction manual, may cause harmful interference to radio communications. However, there is no guarantee that interference will not occur in a particular installation. If this equipment does cause harmful interference to radio or television reception, which can be determined by turning the equipment off and on, the user is encouraged to try to correct the interference by one or more of the following measures:

- Reorient or relocate the receiving antenna.
- Increase the separation between the equipment and receiver.
- Connect the equipment to an outlet on a circuit different from that to which the receiver is connected.
- Consult the dealer or an experienced radio/TV technician for help.

**CAUTION:**

Do not attempt to modify this product in any way without written authorization from LG Electronics U.S.A., Inc. Unauthorized modification could void the user’s authority to operate this product.

**COMPLIANCE:**

The responsible party for this product’s compliance is: LG Electronics U.S.A., Inc.  
1000 Sylvan Avenue, Englewood Cliffs, NJ 07632, USA • Phone: 1-201-816-2000

Marketed and Distributed in the United States by LG Electronics U.S.A., Inc.  
1000 Sylvan Avenue, Englewood Cliffs, NJ 07632

# IMPORTANT SAFETY INSTRUCTIONS

1. Read these instructions.
2. Keep these instructions.
3. Heed all warnings.
4. Follow all instructions.
5. Do not use this apparatus near water.
6. Clean only with dry cloth.
7. Do not block any ventilation openings. Install in accordance with the manufacturer's instructions.
8. Do not install near any heat sources, such as radiators, heat registers, stoves, or other apparatus (including amplifiers) that produce heat.
9. Do not defeat the safety purpose of the polarized or grounding-type plug. A polarized plug has two blades with one wider than the other. A grounding-type plug has two blades and a third grounding prong. The wide blade or the third prong are provided for your safety. If the provided plug does not fit into your outlet, consult an electrician for replacement of the obsolete outlet.
10. Protect the power cord from being walked on or pinched, particularly at plugs, convenience receptacles, and the point where it exits from the apparatus.
11. Only use attachments/accessories specified by the manufacturer.
12. Use only with the cart, stand, tripod, bracket, or table specified by the manufacturer or sold with the apparatus. When a cart is used, use caution when moving the cart/apparatus combination in order to avoid injury from tip-over.



13. Refer all servicing to qualified service personnel. Servicing is required when the apparatus has been damaged in any way, such as power-supply cord or plug is damaged, liquid has been spilled or objects have fallen into the apparatus, the apparatus has been exposed to rain or moisture, does not operate normally, or has been dropped.
14. Never touch this apparatus or antenna during a thunder or lightning storm.
15. When mounting a TV on the wall, make sure not to install the TV by the hanging power and signal cables on the back of the TV.
16. Do not allow an impact shock or any objects to fall into the product, and do not drop objects onto the screen.

## 17. Power Cord

**Caution: It is recommended that appliances be placed upon a dedicated circuit; that is, a single outlet circuit which powers only that appliance and has no additional outlets or branch circuits. Check the specification page of the Owner's Manual to be certain.**

Periodically examine the cord of your appliance, and if its appearance indicates damage or deterioration, unplug it, discontinue use of the appliance, and have the cord replaced with an exact replacement part by an authorized servicer. Protect the power cord from physical or mechanical abuse, such as twisting, kinking, or pinching or being closed in a door or walked upon. Pay particular attention to plugs, wall outlets, and the point where the cord exits the appliance.

Do not use a damaged or loose power cord. Be sure to grasp the plug when unplugging the power cord. Do not pull on the power cord to unplug the TV.

## 18. Overloading

Do not connect too many appliances to the same AC power outlet as this could result in fire or electric shock. Do not overload wall outlets. Overloaded wall outlets, loose or damaged wall outlets, extension cords, frayed power cords, or damaged or cracked wire insulation are dangerous. Any of these conditions could result in fire or electric shock.

## 19. Outdoor Use/Wet Location



**Warning: To reduce the risk of fire or electrical shock, do not expose this product to rain, moisture or other liquids.**

Do not touch the TV with wet hands. Do not install this product near flammable objects, such as gasoline or candles, or expose the TV to direct air conditioning.

Do not expose to dripping or splashing and do not place objects filled with liquids, such as vases, cups, etc., on or over the apparatus (e.g., on shelves above the unit).

## 20. Grounding

Ensure that you connect the earth ground wire to prevent possible electric shock (i.e., a TV with a three-prong grounded AC plug must be connected to a three-prong grounded AC outlet). If grounding methods are not possible, have a qualified electrician install a separate circuit breaker. Do not try to ground the unit by connecting it to telephone wires, lightning rods, or gas pipes.

## 21. Disconnect Device

The mains plug is the disconnecting device. The plug must remain readily operable.

As long as this unit is connected to the AC wall outlet, it is not disconnected from the AC power source even if the unit is turned Off.

(Continued on next page)

# IMPORTANT SAFETY INSTRUCTIONS

(Continued from previous page)

## 22. Outdoor Antenna Grounding

If an outside antenna or cable system is connected to the product, follow the precautions below.

An outdoor antenna system should not be located in the vicinity of overhead power lines or other electric light or power circuits or where it can come into contact with such power lines or circuits as death or serious injury can occur.

Be sure the antenna system is grounded so as to provide some protection against voltage surges and built-up static charges.

Article 810 of the National Electrical Code (NEC) in the U.S.A. provides information with respect to proper grounding of the mast and supporting structure, grounding of the lead-in wire to an antenna-discharge unit, size of grounding conductors, location of antenna-discharge unit, connection to grounding electrodes, and requirements for the grounding electrode.

### Antenna Grounding According to NEC, ANSI/NFPA 70

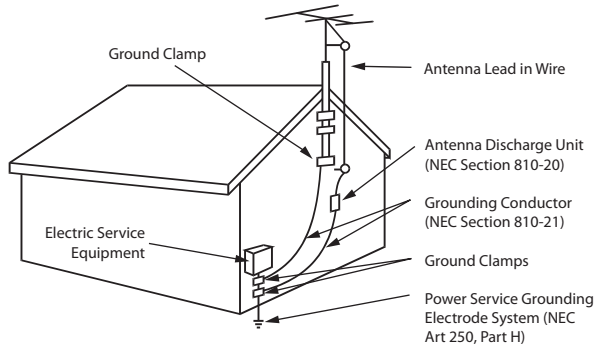

## 23. Cleaning

When cleaning, unplug the power cord and wipe gently with a soft cloth to prevent scratching. Do not spray water or other liquids directly on the TV as electric shock may occur. Do not clean with chemicals such as alcohol, thinners or benzene.

## 24. Transporting Product

Make sure the product is turned Off and unplugged and that all cables have been removed. It may take two or more people to carry larger TVs. Do not press against or put stress on the front panel of the TV.

## 25. Ventilation

Install the TV where there is proper ventilation. Do not install in a confined space such as a bookcase. Do not cover the product with cloth or other materials (e.g., plastic) while it is plugged in. Do not install in excessively dusty places.

26. Do not touch the ventilation openings, as they may become hot while the TV is operating.

27. If you smell smoke or other odors coming from the TV or hear strange sounds, unplug the power cord, and contact an authorized service center.

28. Do not press strongly on the panel with your hand or a sharp object (e.g., a nail, pencil, or pen) or make a scratch on it.

29. Keep the product away from direct sunlight.

## 30. Dot Defect

The Plasma or LCD panel is a high technology product with resolution of two million to six million pixels. In a very few cases, you could see fine dots on the screen while you're viewing the TV. Those dots are deactivated pixels and do not affect the performance and reliability of the TV.

## 31. Generated Sound

"Cracking": A cracking noise that occurs while the TV is On or when it is turned Off is generated by plastic thermal contraction due to temperature and humidity. This noise is common for products where thermal deformation is required.

Electrical circuit humming/panel buzzing: A low level noise is generated from a high-speed switching circuit, which supplies a large amount of current to operate a product. It varies depending on the product. This generated sound does not affect the performance and reliability of the product.

## 32. For LCD TV

If the TV feels cold to the touch, there may be a small "flicker" when it is turned On. This is normal; there is nothing wrong with TV. Some minute dot defects may be visible on the screen, appearing as tiny red, green, or blue spots. However, they have no adverse effect on the TV's performance. Avoid touching the LCD screen or holding your finger(s) against it for long periods of time. Doing so may produce some temporary distortion effects on the screen.

# Table of Contents

---

Safety Warnings . . . . .	2	FTG Configuration Application Utilities Overview . . .	34–37
Important Safety Instructions . . . . .	3–4	FTG Channel Map Configuration Utility . . . . .	34
Table of Contents . . . . .	5	FTG Channel Map Editor . . . . .	35
Setup Checklist / Commercial Mode Setup Overview . . .	6	FTG Installer Menu Configuration Utility . . . . .	36
Pro:Centric TV Interactive Menu Features . . . . .	7	FMA Configuration Utility . . . . .	37
LD330H Rear Jack Panel . . . . .	8		
Side Connections Panel / RF Antenna Connection . . . . .	9	<b>References</b>	
Installer Overview . . . . .	10	Upgrading TV/PTC Software using a USB Memory	
Installer Remote Control Typical Key Functions . . . . .	11	Device . . . . .	38
<b>Commercial Mode Setup for Master TV</b> . . . . .	12–13	Downloading a Splash Screen using a USB Memory	
<b>Installer Menu</b> . . . . .	14–20	Device . . . . .	39
TV Setup Menus Overview . . . . .	21	Power Consumption Settings . . . . .	40
Adding Channel Icons / Custom Channel Labels		TV Camport Auto Sense Operation . . . . .	41
(2-5-4 + MENU Mode) . . . . .	22	TV Aux Input Configuration . . . . .	42
<b>Cloning Overview / Clonable Menu Features</b> . . . . .	23	Resetting a TV to Pass-through Mode . . . . .	43
<b>Cloning Procedures</b> . . . . .	24–28	Troubleshooting . . . . .	44–47
Learning / Teaching a Master TV Setup using		General Troubleshooting . . . . .	44
a USB Memory Device . . . . .	24	Troubleshooting Flow Chart . . . . .	45
Learning / Teaching a Master TV Setup using		Commercial Mode Check / FTG Operation	
a TLL-1100A Clone Programmer . . . . .	25–26	Troubleshooting . . . . .	46
Learning / Teaching a Master TV Setup using		Clone Programmer Troubleshooting . . . . .	47
an LT2002 Clone Programmer . . . . .	27–28	Glossary of Terms . . . . .	48
<b>FTG Mode of Operation</b> . . . . .	29–33	Document Revision History / Notes . . . . .	49
FTG Mode Overview / Determining the TV		Back Cover . . . . .	50
Operating Mode . . . . .	29		
Creating an FMA Configuration File using the FTG			
Configuration Application . . . . .	30		
Teaching FMA Configuration to a TV . . . . .	31		
Learning an FMA Configuration File from a TV . . . . .	32		
Optional Manual Configuration / Setup for a TV . . . . .	33		

---

## Notes

- Installer Menu content is intended for use primarily by qualified TV electronics technicians.
- Refer to the Owner's Manual for additional information on TV features, specifications, maintenance, and safety instructions.
- For additional information, contact your LG representative.

Note: Design and specifications subject to change without prior notice.



# Setup Checklist / Commercial Mode Setup Overview

---

## Setup Checklist

### Installation and Setup Checklist

- \_\_\_ Unpack TV and all accessories.
  - \_\_\_ Install batteries in remote control.
  - \_\_\_ Install TV on VESA mount or stand.
- Note:** It may be advisable to make all cable connections before installing on VESA mount or stand, as appropriate.

### Hardware Connections

- \_\_\_ Install any additional hardware as appropriate to your institution, LAN, etc.

### Cable Connections

- \_\_\_ Make all connections to rear jack panel and RF antenna on MPI/PPV card.
- \_\_\_ Make all connections to signal, interactive resources, and Aux sources, as appropriate.

### Commercial Mode Setup

- \_\_\_ Complete Commercial Mode Setup (configure all relevant Installer Menu items as required of your institution and configure display features for the end user).

### Software Installation

- \_\_\_ Install or configure any software, as applicable, for example, PPV, etc.

---

## Commercial Mode Setup Overview

This document describes how to set up LD330H Pro:Centric™ TVs for Commercial Mode either while in Pass-through Mode or Free-To-Guest (FTG) Mode.

### Pass-through Mode

This mode allows you to configure a Master TV Setup for cloning purposes as well as external VOD/PPV control. Use the Installer Remote to configure Installer Menu items as required for TV operation and set up TV features (Channel, Picture, Audio, etc.). See pages 12 to 13 for detailed information.

### FTG Mode

This mode enables Pro:Idiom® decryption and also allows logical channel mapping of physical channels to remove the need for dash tuning. FTG Configuration Application software is used to configure and/or edit FTG Channel Map and FTG Installer Menu settings. See pages 29 to 37 for information on FTG Mode options and using the FTG Configuration Application.

# Pro:Centric TV Interactive Menu Features



**Important: Pro:Centric operation requires that Installer Menu items 098 PRO:CENTRIC and 119 DATA CHANNEL be set appropriately and that the TV be in PPV or FTG Mode.**

The interactive Pro:Centric TV enables guests—from the comfort of their hotel rooms—to view and select from a complete listing of hotel services and amenities. The Pro:Centric TV is connected to the hotel's billing computer, and service/amenities charges are billed at the time of order.

Interactive amenities may include:

- Hotel information, news, and events
- Directory services (tourist attractions, restaurants, etc.)
- Reservation services (business meetings, fitness, spa, etc.)
- Weather and traffic information
- Shopping services (delivery to guest room)
- Room service (menu ordering, memo service, morning wake up call, laundry, etc.)
- Ticketing services
- Check-out service (in the guest room)
- Gaming services
- E-mail resources/account access

Use the Installer Remote to operate both interactive menus and regular TV features. Press **PORTAL** on the Installer Remote to access the interactive menus.

**Note:** Interactive menu options may vary, depending on Pro:Centric features enabled for the site. The following are default interactive menus.

## Channel Guide

Shows available TV networks and channels. When available, electronic program guide (EPG) data indicates the channel and the program start and finish times.

## Information

Typically displays hotel information, for example, photos of guest rooms, dining rooms, business centers, facilities, etc., as well as information on local weather and attractions. Information may also include resources, such as local school programs, run in cooperation with the hotel.

## Help

Provides help for navigating the interactive menus.

## Watch TV

Removes the interactive menu from the screen and returns to the previously tuned TV channel.

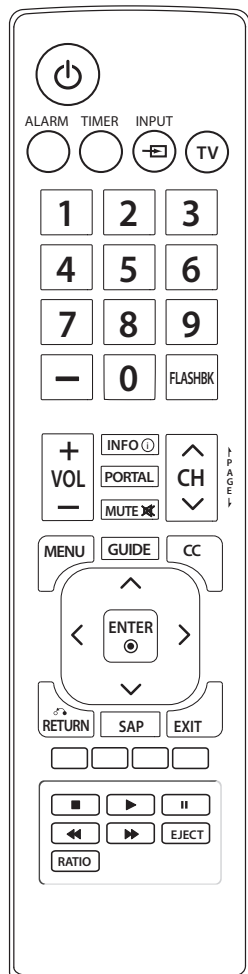

# LD330H Rear Jack Panel

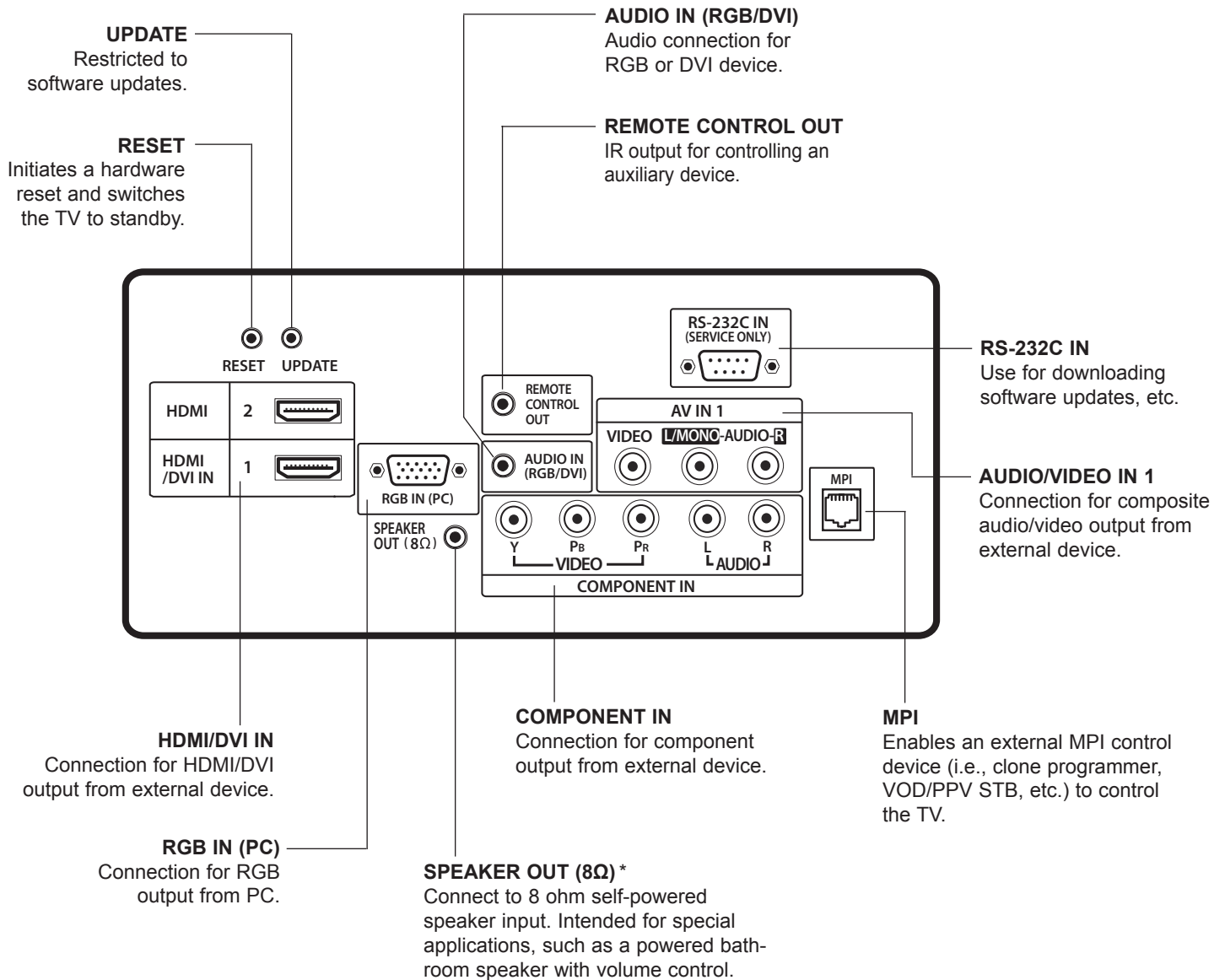

\* This stereo jack provides a mono speaker fixed-level, 1 watt output (audio +, audio -, w/ground shield). Do NOT plug in a mono connector, as this may damage the TV.

# Side Connections Panel / RF Antenna Connection

## Side Connections Panel

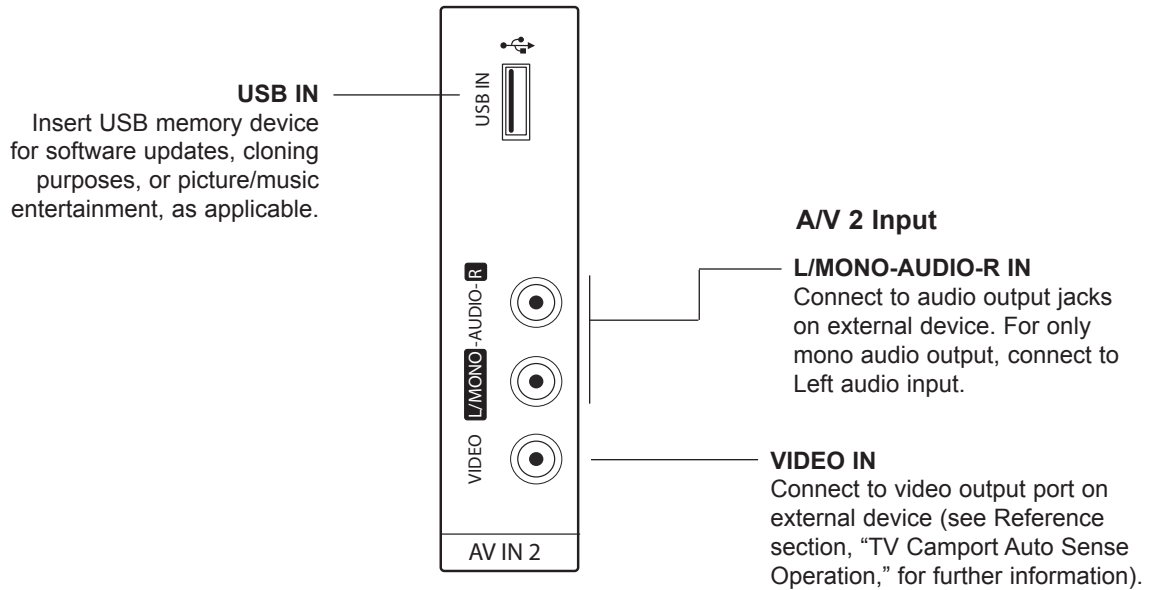

## RF Antenna Connection

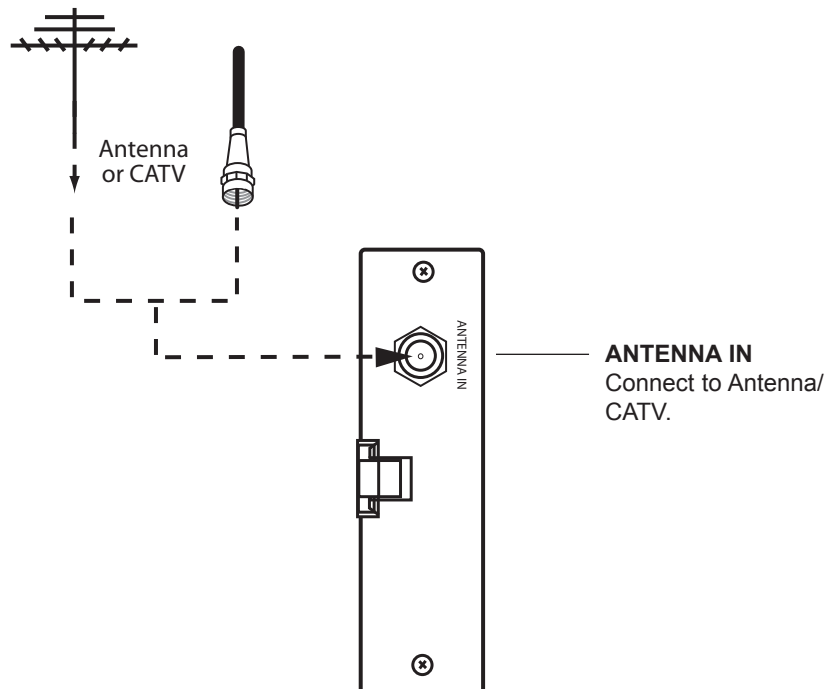

# Installer Overview

This is the Commercial Mode Setup Guide only.

## Installer Menu / Commercial Mode Setup

To set up a Master TV for cloning purposes, you will need to know how to enter the TV Installer Menu and make changes to the default values as required. Similarly, to configure a TV's Installer Menu settings in FTG Mode, you will need to know how to access and use the FTG Configuration Application utilities. If necessary, familiarize yourself with the Installer Menu and how to make and save changes. Refer to page 14 for information on accessing the Installer Menu in Pass-through Mode. Pages 15 to 20 describe Installer Menu items in detail. Refer to pages 29 to 37 for information on entering FTG Mode and using the FTG Configuration Application utilities.

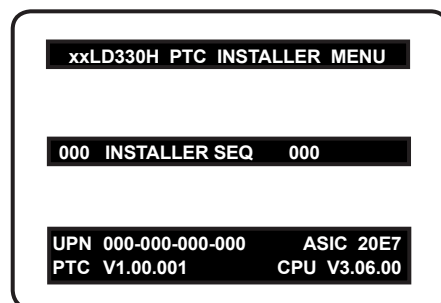

Typical Installer Menu

## Installer Remote

The LG Installer Remote is supplied with and dedicated to operate the TV. See next page for typical key functions. Some DVD and VCR controls may be available for selected LG DVD/VCR products.

## Cloning

Cloning refers to the process of capturing a Master TV Setup and transferring it to a Target TV. The Master TV's clonable features need to be configured as part of the Commercial Mode Setup. This is a critical step. If the Master TV's clonable features—channel icons or labels, digital font options, etc.—are not set up correctly, the cloned TVs will all have problems. Pages 23 to 28 provide detailed information on cloning requirements and procedures.

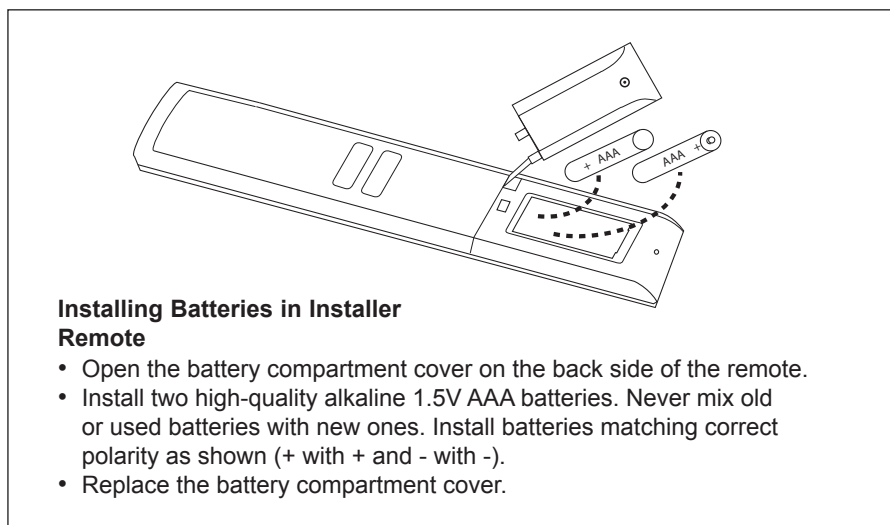
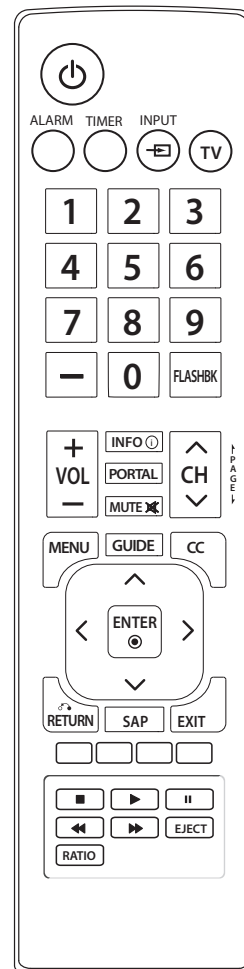

# Installer Remote Control Typical Key Functions

The LG Installer Remote illustrated below and throughout this document shows typical remote control functions and is provided for reference only. This Installer Remote may vary from the Installer Remote supplied with the TV.

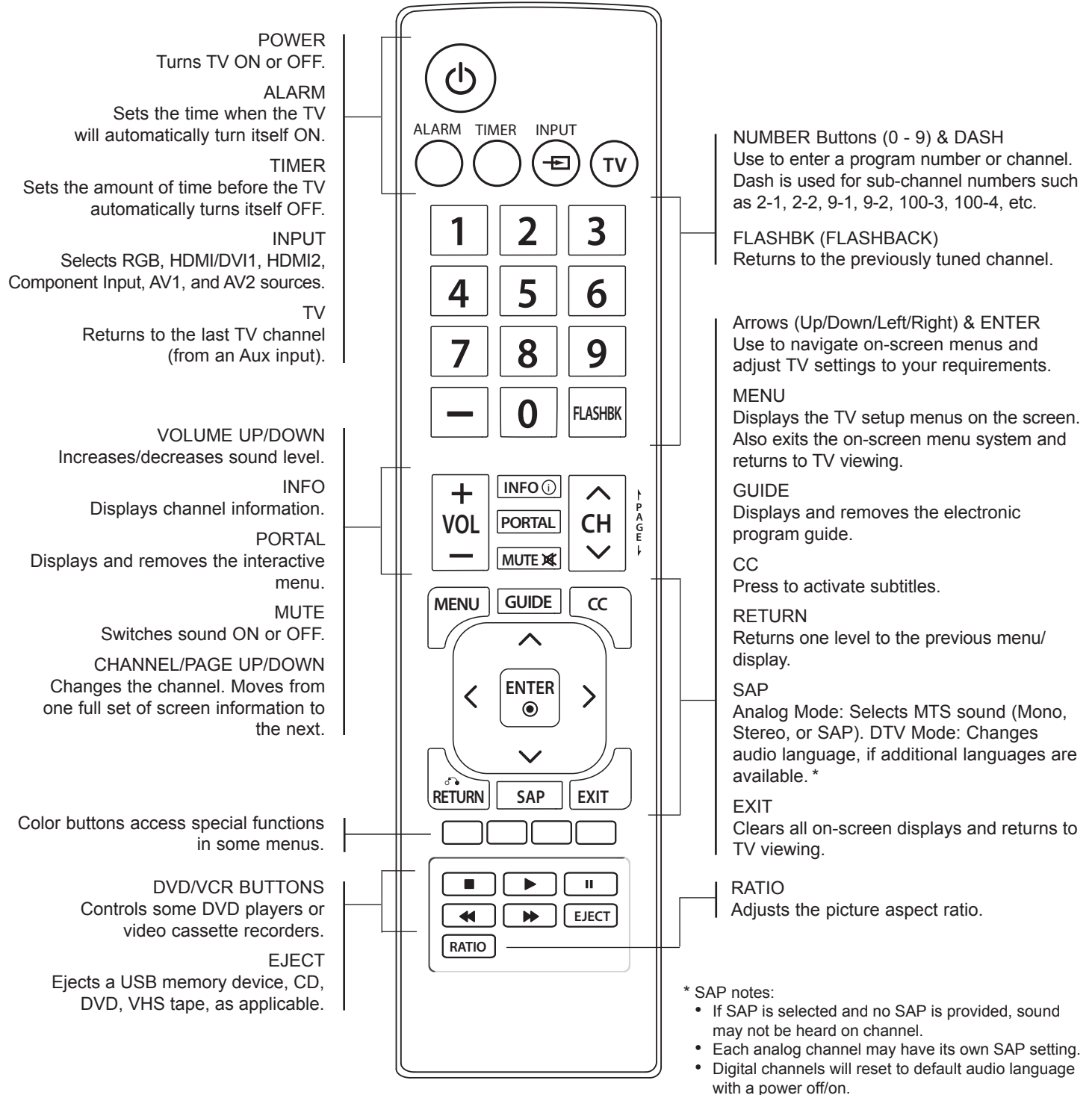

# Commercial Mode Setup for Master TV

This section describes how to set up a Master TV for cloning purposes when the TV is in Pass-through Mode.

**Note:** Disconnect all Aux inputs. Under certain conditions, Auto Tuning (Channel Search) is disabled if there is an Aux input active.

**Note:** Refer to FTG Mode information on pages 29 to 37 for information on entering FTG Mode and configuring/editing FTG Channel Map and FTG Installer Menu settings using the FTG Configuration Application.

## 1. Set Installer Menu items.

This step provides specific instruction only on the Installer Menu items that should be set on a Master TV. Refer to pages 14 to 20 for detailed information on all Installer Menu items.

- a) Make sure the TV is ON. Then, use the Installer Remote to enter the TV Installer Menu: Press **MENU** repeatedly until the on-screen setup menus lock up, and then press **9-8-7-6 + ENTER**.
- b) Set Installer Menu item **117 FACT DEFAULT** to **001** and press **ENTER** on the Installer Remote.

This clears all Installer Menu custom settings, the channel lineup, etc. and reloads the factory default settings. The value will change back to 0 after the internal TV controller (Protocol Translator Card [PTC]) has been restored to factory default condition. This step ensures that the TV Channel Memory will be the active channel lineup.

- c) Set Installer Menu item **003 BAND/AFC**, as appropriate.
  - Broadcast: Set to 000.
  - CATV: Set to 001 (default).
  - HRC: Set to 002.
  - IRC: Set to 003.
- d) Set any other Installer Menu items that affect your TV programming network to the required configuration. For example, enable/disable Aux sources, set a Start Channel, etc.
- e) After you have adjusted all required Installer Menu item settings, press **ENTER** once on the Installer Remote to save your changes; then, press **ENTER** again to exit the menu.

## 2. Set up TV features.

On-screen setup menus control the features of the TV (see page 21). Press **MENU** on the Installer Remote to access the setup menus, and then set Channel, Picture, Audio, Lock, Time, etc. options to the desired configurations. See also the Clonable Menu Features list on page 23.

**Note:** If desired, you can run Auto Tuning (see step 3) prior to completing this step.

## 3. Run Auto Tuning (Channel Search).

- a) Search for all available analog and digital channels: Go to the Channel Menu, select the **Auto Tuning** option, and follow the on-screen instructions.

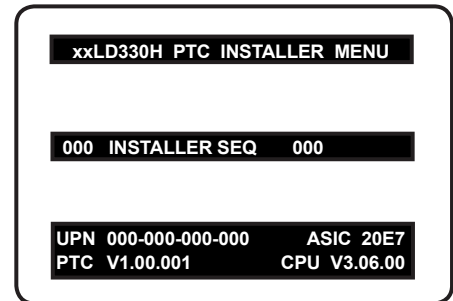

Typical TV Installer Menu

Note: The Installer Menu header will vary depending on the TV you are setting up.

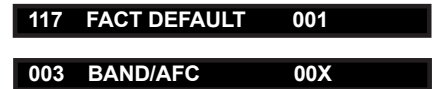

Adjust the settings for these Installer Menu items.

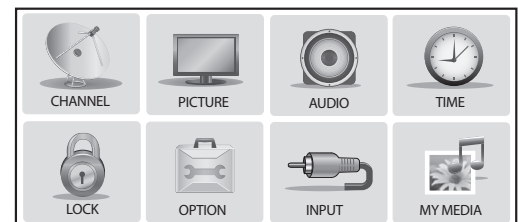

Set the TV features to the desired configuration for the end user.

(Continued on next page)

# Commercial Mode Setup for Master TV (Cont.)

(Continued from previous page)

## 3. Run Auto Tuning (Channel Search). (continued)

b) Use the **Channel Edit** option in the Channel Menu to edit the channel lineup, as necessary, to include free to guest channels only.

- Add/delete channels per your system requirements. Note that if Installer Menu item 103 ATSC TUNE MODE is set for Physical Channel tuning (default and recommended setting), channels with minor channel numbers higher than 255 will not transfer correctly in step 4. If it is set for Virtual Channel tuning and either the major or minor channel numbers are higher than 255, the channel(s) will not transfer correctly in step 4.
- Use the **Channel Label** option in the Channel Menu to add familiar channel trademarks/logos such as ABC, CBS, NBC, etc. to the Channel-Time on-screen display. Identifiable labels (logos) should enable the end user to readily know what common networks are available. (You can add the channel labels in this step, or you can add channel labels or logos for channels without icons in step 5.)

## 4. Transfer the TV Setup to the internal TV Controller (PTC): 2-5-5 + MENU Mode

After the TV channel lineup has been edited and channel label icons added, enter the Installer Menu. Once in the Installer Menu, press **2-5-5 + MENU** on the Installer Remote to initiate the transfer of the Master TV Setup to the PTC. The TV exits the Installer Menu and then tunes through the channels in the channel lineup during the transfer. When the transfer is complete, the TV tunes back to the channel that was tuned before the transfer began.

**Note:** The maximum number of active channels that can be transferred is 141. An attempt to transfer more than 141 channels will result in erratic TV tuning operation.

## 5. Add Custom Channel and Aux Source Labels for Analog Channels: 2-5-4 + MENU Mode

Enter the Installer Menu, and press **2-5-4 + MENU** on the Installer Remote. Add/edit custom text labels to channel on-screen displays. Note that digital channels often have a broadcaster generated label (see 2-5-4 + MENU procedural information on page 22). When you are finished, press **MENU** to exit 2-5-4 + MENU Mode.

## 6. Verify the TV setup.

At this point, verify that the channel lineup, channel icons, and custom labels are correct. Make sure the TV features are set per your requirements.

## 7. Lock the channel lineup.

Enter the Installer Menu. Set item **028 CH. OVERRIDE** to **000** and press **ENTER** to lock the channel lineup and restrict access to the TV setup menus. Press **ENTER** again to save your changes and exit the Installer Menu.\*

The Master TV Setup is now ready to be copied to a USB memory device or a clone programmer (see cloning information in this document).

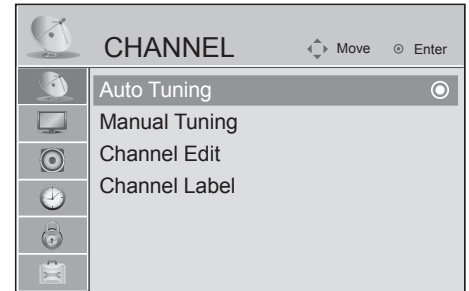

Run Auto Tuning, edit channels, and select familiar channel trademarks/logos using Channel Menu options.

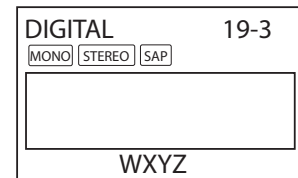

Custom Text Label "WXYZ" created in 2-5-4 + MENU (Add Channel Label) Mode.

**028 CH. OVERRIDE 000**

After verifying the TV Setup, set Installer Menu item 028 CH. OVERRIDE to 000.\*

\* This step prevents end users from accessing channel settings (i.e., the Channel Menu will be inaccessible/grayed out).



# Installer Menu

---

Use the Installer Menu to set up or change operational settings. Refer to the table starting on the next page for brief descriptions of Installer Menu items. More detailed descriptions follow the table listing.

## Accessing the Installer Menu

1. Make sure the TV is ON.
2. Using an Installer Remote, press **MENU** repeatedly until the on-screen setup menus lock up, and then press **9-8-7-6 + ENTER** to access the Installer Menu.

The Installer Menu opens with item 000 INSTALLER SEQ 000.

## Using the Installer Menu

Items 000 ~ 119 are accessible only upon entering the Installer Menu. Refer to the table on pages 15 and 16 for an overview of Installer Menu items, including item numbers, functions, ranges, and default values. Installer Menu items not relevant to this TV series are not present on the Installer Menu; therefore, some numbers are missing. For example, item 006 will not appear.

## Navigation within the Installer Menu

Use the Up/Down arrow keys on the Installer Remote to sequence through the available menu items, or access an item directly by keying in the line number and then pressing **MENU**. For example, to access the SLEEP TIMER option, which is item 015, press 0-1-5 + MENU.

## Changing Installer Menu Settings

To change an Installer Menu item setting, use the Left/Right arrow keys on the Installer Remote, or enter a value directly. Press **ENTER** to save the new setting, or use the Up/Down arrow keys to navigate to a new Installer Menu item if you have additional items to edit.

## Exiting the Installer Menu and Activating Updates

After you have adjusted all required Installer Menu item settings, press **ENTER** once on the Installer Remote to save your changes; then, press **ENTER** again to exit the Installer Menu. Any changes you make will be stored in non-volatile memory.

**Note:** Each time you exit the Installer Menu, all V-Chip (Parental Control) settings in the TV are reset to their default values; that is, the Lock System, if previously enabled from the Lock setup menu (see the Owner's Manual for additional information), will now be disabled, and the individual Parental Control settings will be restored to default values.

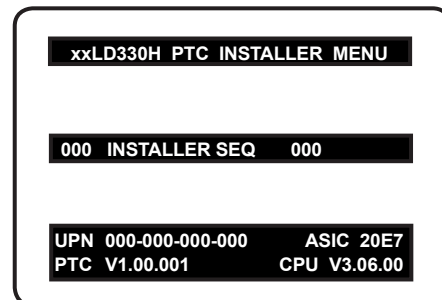

Typical TV Installer Menu

# Installer Menu (Cont.)

## Installer Menu Items 000 through 071

Menu Item	Function	Value Range	Default Value	Brief Description of Function and Comments
000	INSTALLER SEQ	0 ~ 3	0	Leave default set to 0.
001	POWER MANAGE	0 ~ 7	0	Sets number of hours of no activity before automatic shutoff.
002	AC ON	0 / 1	0	Set to 1 to enable Auto Turn ON when AC power is applied.
003	BAND/AFC	0 ~ 3	1	Selects Tuning Band: 0=Broadcast, 1=CATV, 2=HRC, 3=IRC
004	STRT CHANNEL	0 ~ 127, 255	255	Channel tuned when TV is turned ON. (Set to 255 to tune to channel tuned before TV turned OFF.)
005	CHAN LOCK	0 / 1	0	If set to 1, cannot tune from current channel.
007	STRT VOLUME	0 ~ 63, 255	255	Volume level when TV is turned ON. (Set to 255 to use volume level before TV turned OFF.)
008	MIN VOLUME	0 ~ 63	0	Sets minimum allowable volume setting.
009	MAX VOLUME	0 ~ 63	63	Sets maximum allowable volume setting.
010	MUTE DISABLE	0 / 1	0	Set to 1 to disable Mute Function.
011	KEY DEFEAT	0 / 1	0	Set to 1 to disable menu navigation keys on display panel.
015	SLEEP TIMER	0 / 1	1	Set to 1 to enable Sleep Timer.
016	EN TIMER	0 / 1	0	Set to 1 to enable On/Off Timers.
017	ALARM	0 / 1	1	Set to 1 to enable Alarm.
020	FEATURE LEVEL	0 ~ 1, 16 ~ 24	1	Determines an additional IR code scheme to which the TV will respond.
021	V-CHIP	0 / 1	1	Set to 1 to enable V-Chip (Parental Control) functions.
022	MAX BLK HRS	0 ~ 99	12	Sets number of V-Chip blocking hours.
023	CAPTION LOCK	0 / 1	0	Set to 1 to retain caption setting set before TV turned OFF.
028	CH. OVERRIDE	0 / 1	1	If set to 0, limits direct access to favorite channels.
029	OLD OCV	0 / 1	0	Set to 1 to change MPI operation to OCV.
030	ACK MASK	0 / 1	0	If set to 1, changes MPI for some OCV boxes.
031	POLL RATE	20 ~ 169	94	Selects poll rate for MPI.
032	TIMING PULSE	186 ~ 227	207	Sets baud rate for MPI.
034	CAMPORT EN	0 / 1	1	Set to 1 to enable Video 2 input.
035	COMPPOINT EN.	0 / 1	1	Set to 0 to disable HDMI 1. Set to 1 enable HDMI 1.
038	YPrPb EN.	0 / 1	1	Set to 1 to enable display panel Component Video 1 input jacks.
039	REAR AUX EN	0 / 1	1	Set to 1 to enable display panel Video 1 input jack.
040	AUTO CAMPORT	0 / 1	1	Set to 1 to automatically switch to Camport. If set to 1, STRT AUX SRCE cannot be set to 2.
046	STRT AUX SRCE	1 ~ 6, 255	6	Sets the starting Aux source (if item 004 STRT CHANNEL is set to 0).
047	AUX STATUS	0 / 1	0	Set to 1 for MPI Aux source to be reported as a channel number instead of Channel 0.
053	DIS. CH-TIME	0 / 1	0	Set to 1 to disable Channel-Time display.
069	EN. CH-T COL.	0 / 1	1	Set to 1 to enable custom color for the Channel-Time display.
070	FOR. CH-TIME	0 ~ 7	2	Chooses custom foreground color for the Channel-Time display.
071	BCK. CH-TIME	0 ~ 7	2	Chooses custom background color for the Channel-Time display.

## Installer Menu (Cont.)

### Installer Menu Items 073 through 119

Menu Item	Function	Value Range	Default Value	Brief Description of Function and Comments
073	CH NOT AVBLE	0 / 1	0	If set to 1 and Channel Override is 0, "NOT AVAILABLE" message is displayed when directly accessing a channel not in the favorite Channel List.
075	REVERT CH	0 / 1	0	If set to 1 and loss of MPI communication occurs, TV tunes to Start Channel.
078	UPN MSB	0 ~ 255	0	User programmable number, most significant byte.
079	UPN MSB-1	0 ~ 255	0	User programmable number, most significant byte - 1.
080	UPN MSB-2	0 ~ 255	0	User programmable number, most significant byte - 2.
081	UPN LSB	0 ~ 255	0	User programmable number, least significant byte.
082	CHKSM ERROR	0 / 1	1	Enforces rigid MPI checksum.
083	HANDSHK TIME	0 ~ 5	5	Relaxes MPI timing to be compatible with PC-based Windows-controlled systems.
084	PERMANENT BLK	0 / 1	0	Removes block hours setting for Parental Control and makes block permanent.
087	REAR RGB EN.	0/1/17	1	Set to 0 to disable RGB input. Set to 1 to enable RGB input. Set to 17 for Auto Configure.
088	EN NOISE MUTE	0 / 1	1	If set to 1, audio is muted if no signal is present.
090	KEY LOCK	0 / 1	0	If set to 1, keyboard is locked out, IR is still functional.
091	YPrPb2 EN	0 / 1	1	Set to 1 to enable HDMI 2 input.
094	SAP MENU EN	0 / 1	1	Set to 0 to disable feature on Function Menu. Set to 1 to enable feature on Function Menu.
096	DEF. ASP. RATIO	0 ~ 4	2	Sets default aspect ratio at power up. See detailed descriptions and item 106.
098	PRO:CENTRIC	0 ~ 2	0	Set to 0 to disable Pro:Centric operation. Set to 1 for Flash Mode. Set to 2 for GEM (Java Application) Mode.
099	BACK LIGHTING	1 ~ 100, 101 ~ 200, 255	100	Sets the level of the TV picture back lighting. (See detailed descriptions.)
102	ATSC BAND	0 ~ 4	4	Selects ATSC band.
103	ATSC TUNE MODE	0 / 1	1	Set to 1 (default) for Physical Channel scan. Set to 0 for Virtual Channel scan.
104	START MINOR CH	0 ~ 255	0	Selects Minor Start Channel. Set to 0 for NTSC.
106	ASP RATIO LOCK	0 / 1	0	To retain set aspect ratio on power cycle, set to 1. Set to 0 for default ratio on power cycle.
116	VIDEO MUTE EN	0 / 1	0	Set to 0 for Normal. Set to 1 for Blank.
117	FACT DEFAULT	0 / 1	0	Set to 0 for Normal. Set to 1 to load presets for all Installer Menu settings.
119	DATA CHANNEL	0 ~ 135	0	Set to 0 to disable. Set to the RF channel number of the Data Channel for Pro:Centric or E-Z Installation data. (See detailed descriptions.)

## Detailed Descriptions of Installer Menu Items

### 000 - INSTALLER SEQUENCE

Specifies entry sequence to the Installer Menu.

0 = 9876	1 = 4321
2 = 1478	3 = 3698

### 001 - POWER MANAGE (Power Management)

Determines hours of no activity before automatic shutoff. The Power Management function is for saving energy. If set to 0, Power Manage is Off. Settings range from 0 ~ 7, with 1 ~ 7 representing the hours that the unit will remain ON, unless there has been activity from either the control panel or remote control.

### 002 - AC ON (AC Power Switchable)

If set to 1, this allows the TV to turn ON when AC power is applied. Pressing the ON button is not necessary. This is desirable if the TV is plugged into a cable box or a power outlet controlled by a wall switch. Use the Left/Right arrow keys to choose 0 or 1, where 0 is the default (OFF), and 1 is ON.

**Note:** If set to 1 (ON), the TV does not respond to On/Off commands from either the remote or the display control panel, and the SLEEP TIMER is also nonfunctional.

### 003 - BAND/AFC (Band/Automatic Frequency Control)

There are four possible settings for this option:

0 = Broadcast	1 = CATV (default)
2 = HRC	3 = IRC

If some channels were not found by Auto Tuning (Channel Search), select the appropriate Band setting here, and add the channels using the Channel Edit option in the Channel Menu.

### 004 - STRT CHANNEL (Start Channel)

If active, this function allows you to determine the initial Major Start Channel number when the TV is turned ON. This feature is useful for an in-house information channel, since the TV would always select that channel when it is turned ON. Setting this item to 255 causes the last channel viewed when the TV was turned OFF, to be the tuned to channel when the TV is turned ON again.

**Note:** For a digital Start Channel, always remember to set item 104 to the Minor Start Channel number.

255 = Last channel	1 ~ 125 = Major Ch. #	0 = Aux
126 = Map to Channel 3	127 = Map to Channel 4	

### 005 - CHAN LOCK (Channel Lock)

Channel Lock is ideal if the system must always be on the same channel. Changing channels with the Channel Up/Down or keypad numbers is impossible. Channel Lock is inactive if set to 0 (default).

Generally, this feature is used in connection with STRT CHANNEL (Installer Menu item 004) where the Start Channel may, for example, be set to 3 or 4. If the Start Channel is 3, then the TV will remain locked on channel 3.

**NOTE:** For items 007, 008, and 009

For legacy reasons, the scale used is 0–63. The PTC software will translate this to the 0–100 scale used by the TV.

To translate a TV volume level to the Installer Menu value, use the following formula:

$$\text{Installer Value} = \frac{\text{TV Value} \times 63}{100}$$

Enter only the whole number (disregard fractions).

### 007 - STRT VOLUME (Start Volume)

This function allows the Installer to determine the initial volume level setting when the TV is turned ON. This feature is useful for an in-house information channel, since the TV would always select that volume level when it is turned ON. The range of values are 0 - 63, 255. If 255 is selected, the current volume level will be retained in memory when the TV is turned OFF; at turn ON, the volume level will be automatically set at the previous or last level.

### 008 - MIN VOLUME (Minimum Volume)

This function determines the minimum volume level allowable with the Volume (VOL) Up/Down control. In this way, for example, someone cannot set the volume too low to hear. The value range is from 0 to 63. Use the Left/Right arrow keys to change values. The factory default is 0, which provides the full range of volume control, if item 009 MAX VOLUME is also set to 63. It may be best to set the same value on every TV.

**Note:** The minimum volume level cannot have a value setting higher than the maximum volume level (described below).

### 009 - MAX VOLUME (Maximum Volume)

This function determines the maximum volume level allowable with the Volume (VOL) Up/Down control. In this way, for example, someone cannot set the volume level high enough to disturb others. The value range is 0 to 63, with 63 as the default, which gives the user the full range of volume control, if item 008 MIN VOLUME is also set at 0. Use the Left/Right arrow keys to change values. It may be best to set the same value on every TV.

**Note:** The maximum volume level cannot have a value setting lower than the minimum volume level (described above).

### 010 - MUTE DISABLE

Enables or disables sound mute function. If set to 1, sound cannot be muted. If set to 0, sound can be muted.

### 011 - KEY DEFEAT (Keyboard Defeat)

If set to 1, KEY DEFEAT prevents the end user from accessing the on-screen menus from the display panel—MENU, ENTER, and menu navigation keys do not function. If set to 0, those keys do function.

**Note:** Users can always access the menus by pressing MENU on the remote.

# Installer Menu (Cont.)

## 015 - SLEEP TIMER

If set to 1, the Sleep Timer feature may be used. If set to 0, the Sleep Timer is not available.

## 016 - EN TIMER (Enable On/Off Timers) \*

If set to 1, the Timer function is available to the end user and enabled continuously. Set to 0 to disable On/Off timers.

**Note:** Clock must be set in order to use timers.

## 017 - ALARM \*

Gives the installer the option of making the Alarm function available to the end user. If set to 1, the Alarm function is available to the end user. Set to 0 to disable the Alarm function.

**Note:** Clock must be set before the Alarm function will work.

## 020 - FEATURE LEVEL

Determines an additional IR code scheme to which the TV will respond, allowing for the use of unique IR codes based on "bed number" in a multi-TV single room installation. First determine the IR mode; then select the bed number.

IR Mode	Bed #	Values
Legacy (Hospital)	1-2	0-1
Multi-code Remote	1-9	16-24

**Note:** Multi-code remotes are not available for the current release. For additional information, contact your LG representative.

## 021 - V-CHIP (Parental Control) \*

Set to 1 to activate V-Chip (Parental Control) and have it available to the end user to filter and control or otherwise restrict programming content that can appear. Set to 0 to turn the V-Chip feature Off (not available to user); no programming restrictions can be set.

## 022 - MAX BLK HRS (Maximum Block Hours) \*

Sets hours from 0 to 99 for the maximum V-Chip (Parental Control) block hours. Default setting is for 12 blocking hours.

## 023 - CAPTION LOCK

If set to 0, captions are OFF when the TV is turned ON. Set to 1 to use the caption setting configured before the TV was turned OFF when the TV is turned ON.

## 028 - CH. OVERRIDE (Channel Override)

If set to 1, the user can select channels with either Channel Up/Down or by direct keypad entry. If set to 0, only those channels that are active in the TV's memory can be selected.

## 029 - OLD OCV (On Command Video™)

Set to 1 for operation with systems from On Command Corporation.

## 030 - ACK MASK

MPI Communication Parameter. Leave at default setting unless changed by PPV provider. When set to 1, changes MPI for some OCV boxes.

## 031 - POLL RATE

MPI Communication Parameter. Selects Poll Rate for MPI. Leave at default setting unless changed by Pay-Per-View provider. Step size of 16 ms.

## 032 - TIMING PULSE

MPI Communication Parameter. Leave at default setting unless changed by Pay-Per-View provider. Sets baud rate. Step size of 4.3 uS.

## 034 - CAMPORT EN. (Camera Port Enable)

Set to 1 to enable Video 2 input on display panel. If set to 0, Video 2 input on display panel is not functional.

## 035 - COMPPORT EN. (Computer Port Enable)

Enable/disable TV display panel HDMI 1 input jack. Set to 0 to disable HDMI1. Set to 1 to enable HDMI1.

## 038 - YPrPb EN. (Rear Component Video Enable)

Set to 1 to enable display panel rear Component Video input jacks. Set to 0 to disable display panel rear Component Video input jacks.

## 039 - REAR AUX EN. (Rear Aux Enable)

Set to 1 to enable display panel rear Aux (Video 1) input. Set to 0 to disable display panel rear Aux (Video 1) input.

## 040 - AUTO CAMPORT

Set to 1 to automatically switch to Camport when equipment is connected to side Video input. Set to 0 to disable side Video automatic source selection. If set to 1, STRT AUX SRCE cannot be set to 2.

## 046 - STRT AUX SRCE (Start Aux Source)

Sets the starting Aux source. When turned ON, the TV will tune to starting Aux source if item 004 STRT CHANNEL is set to 0.

If item 040 AUTO CAMPORT is set to 0:

1 = Video 1      4 = RGB      255 = Last Aux

2 = Video 2      5 = HDMI 2

3 = HDMI 1      6 = Component

If item 040 AUTO CAMPORT is set to 1:

1 = Video 1      4 = RGB      6 = Component

3 = HDMI 1      5 = HDMI 2

## 047 - AUX STATUS

Set to 1 for MPI Aux source to be reported as a channel number instead of channel 0. Set to 0 to disable Aux identification change. Controls MPI status channel response for Aux inputs.

\* Only affects Function Menu if enabled by some PPV providers.

## 053 - DIS. CH-TIME (Disable Channel-Time)

Set to 1 to disable the Channel-Time display; Channel-Time display will not appear. Set to 0 to enable the Channel-Time display.

## 069 - EN. CH-T COL. (Enable Channel-Time Custom Color)

Set to 1 to enable custom color for the Channel-Time display. Set to 0 to disable custom color for the Channel-Time display.

## 070 - FOR. CH-TIME (Channel-Time Display Foreground Color)

Set according to Color Chart:

0 = Black	3 = Cyan	6 = Yellow
1 = Blue	4 = Red	7 = White
2 = Green	5 = Violet	

**Note:** Applies only to "Channel Not Available" message if item 073 is set to 1 (enabled). If foreground color and background color are the same, the menu background will be transparent.

## 071 - BCK. CH-TIME (Channel-Time Display Background Color)

Set according to Color Chart:

0 = Black	3 = Cyan	6 = Yellow
1 = Blue	4 = Red	7 = White
2 = Green	5 = Violet	

**Note:** Applies only to "Channel Not Available" message if item 073 is set to 1 (enabled). If foreground color and background color are the same, the menu background will be transparent.

## 073 - CH NOT AVBLE (Channel Not Available)

If set to 1 and item 028 CH. OVERRIDE is set to 0, a "NOT AVAILABLE" message is displayed when directly accessing a channel not in the channel scan list available in memory.

## 075 - REVERT CH (Revert to Start Channel)

If set to 1 and loss of MPI communication occurs, TV automatically tunes to the specified Start Channel.

## 078 - UPN MSB (UPN Most Significant Byte)

User programmable number, most significant byte readable by MPI command. Note: Not linked to serial number.

## 079 - UPN MSB-1 (UPN Most Significant Byte-1)

User programmable number, most significant byte-1 readable by MPI command. Note: Not linked to serial number.

## 080 - UPN MSB-2 (UPN Most Significant Byte-2)

User programmable number, most significant byte-2 readable by MPI command. Note: Not linked to serial number.

## 081 - UPN LSB (UPN Least Significant Byte)

User programmable number, least significant byte readable by MPI command. Note: Not linked to serial number.

## 082 - CHKSM ERROR (Checksum Error)

Enforces rigid MPI checksum validation. Set to 1 for validation. Set to 0 to disable (does not check checksum on MPI async port). SPI is always checked.

## 083 - HANDSHK TIME (Handshake Time)

Adds an additional delay to the handshake time which is 64 msec, thus relaxing MPI timing requirements to be compatible with PC-based Windows controlled systems. Range is 0 - 5. (Timeout = 25.5MS + [25.5 MS\* Handshake time].)

## 084 - PERMANENT BLK (Permanent Block)

Allows Lock (Parental Control) blocking schemes to be permanent by disabling the blocking hours function. Set to 1 to install Parental Control restrictions permanently. Set to 0 for user-specified hours control of blocking schemes.

## 087 - REAR RGB EN. (Rear RGB Enable)

Controls access to rear RGB input on TV. Set to 0 to disable RGB input. Set to 1 to enable RGB input. Set to 17 to initiate a one-time automatic configuration after an AC power cycle; otherwise, automatic adjustment will be performed each time the RGB input is accessed.

## 088 - EN NOISE MUTE (Enable Noise Mute)

If set to 1, audio mutes if no signal is present.

## 090 - KEY LOCK

If set to 1, display panel Channel, Volume, and Captions buttons are disabled, Power button remains enabled. If set to 0, the Channel, Volume, Captions, and Power buttons are all enabled.

## 091 - YPrPb2 EN. (HDMI2 Enable)

Set to 0 to disable display panel HDMI2 input. Set to 1 to enable DTV mode. Set to 2 to enable PC mode.

## 094 - SAP MENU EN (2nd Audio Program)

Set to 1 to enable SAP feature on Function Menu, if Function Menu is available. Set to 0 to disable SAP feature on Function Menu, if Function Menu is available.

## 096 - DEF. ASP. RATIO (Default Aspect Ratio)

Selects default aspect ratio at power up.

- Set to 0 for Set By System.
- Set to 1 for 4:3.
- Set to 2 for 16:9 (Factory Default).
- Set to 3 for Just Scan.
- Set to 4 for Zoom.

**Note:** Only applies if item 106 ASP RATIO LOCK is disabled, set to 0.

## Installer Menu (Cont.)

---

### 098 - PRO:CENTRIC

Selects the Pro:Centric Mode. Set to 0 (default) to disable Pro:Centric operation. Set to 1 for Flash Mode. Set to 2 for GEM (Java Application) Mode.

### 099 - BACK LIGHTING

Sets the TV screen brightness at power up. Default setting is 100.

- 1 - 100 Static Back Lighting  
(1 = Dimmest picture, 100 = Brightest picture)
- 101 - 200 Dynamic Back Lighting  
(101 = Dimmest picture, 200 = Brightest picture)

If set between 101 and 200, the TV automatically controls back lighting depending upon the picture level of the current program. If set to 255, back lighting is controlled via the Picture settings in the TV's setup menus.

### 102 - ATSC BAND

Sets up TV to receive different types of incoming signals:  
0 = Broadcast, 1 = CATV, 2 = HRC, 3 = IRC, 4 = Same as NTSC.

### 103 - ATSC TUNE MODE

Sets ATSC tuning mode. Default set to 1 for Physical Channel scan. Set to 0 for Virtual Channel scan.

### 104 - START MINOR CHANNEL

Sets Minor Start Channel number at power up. 0 = NTSC. If not 0, number selected is the digital channel's Minor Start Channel number.

### 106 - ASP RATIO LOCK (Aspect Ratio Lock)

Set to 1 to retain previous aspect ratio with power off. Set to 0 to retain default aspect ratio with power off. See item 096 DEF. ASP. RATIO above.

### 116 - VIDEO MUTE EN (Video Mute Enable)

Set to 0 for Normal. Set to 1 for Blank.

### 117 - FACT DEFAULT (Factory Default)

Set to 0 for normal. Set to 1 to load presets of all Installer Menu item settings.



**Warning: If set to 1, this will reload the factory defaults and clear the channel lineup, including any assigned channel icons and custom channel labels.**

### 119 - DATA CHANNEL

Set to 0 (default) to disable. Set to the RF channel number of the Data Channel for Pro:Centric or E-Z Installation (splash screen, configuration, or firmware) data.

**Note:** Pro:Centric updates are downloaded from the Pro:Centric server to the TV when the TV is turned OFF. Also, while Pro:Centric updates are in progress, it is not possible to turn the TV ON. The TV may take several minutes to load EPG data after the initial download of the Pro:Centric application. Subsequent updates generally will take less than one minute.

# TV Setup Menu Overview

---

On-screen setup menus control the features of the TV. Press **MENU** on the Installer Remote to access the TV setup menus, and set the TV features to the desired configuration for the end user.

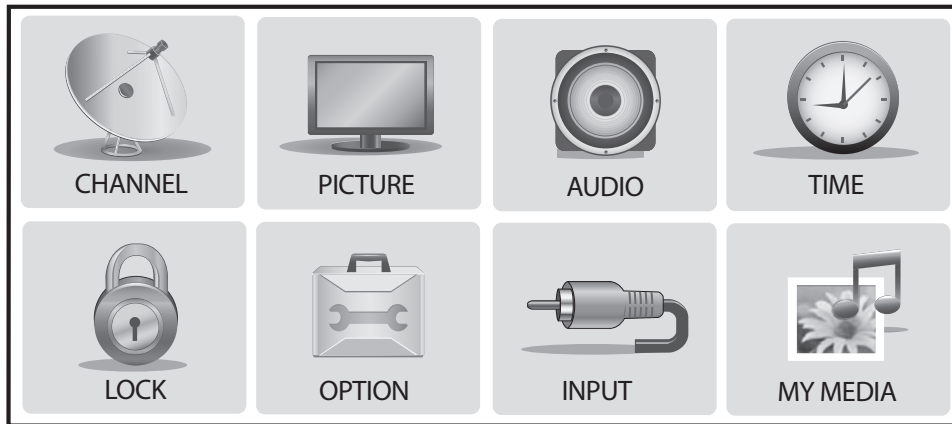

Refer to the Owner's Manual for further information on the TV setup menus.



# Adding Channel Icons / Custom Channel Labels (2-5-4 + MENU Mode)

## Editing/Adding Channel Icons and/or Labels

If there is no pre-assigned icon, you can make a custom channel label of up to seven (7) characters to help identify a channel or network. If desired, channel labels can also be added in addition to a pre-assigned icon. You may also add labels for the Aux input sources to clearly identify the devices that are connected to the Aux inputs.

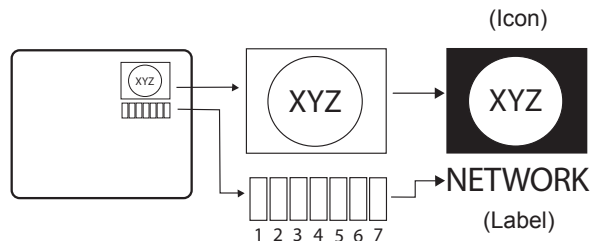

Editing and adding the labels can only be done if there are channels entered into the TV's Channel Map either during Commercial Mode Setup (see pages 12 to 13), by cloning, or by using some PPV providers' master remote controls.  
**Note:** A blank letter space is available between "Z" and "!".

## To perform channel editing/labeling:

1. Enter the TV Installer Menu: Press **MENU** repeatedly until the on-screen setup menus lock up, and then press **9-8-7-6 + ENTER**.
2. Press **2-5-4 + MENU** on the Installer Remote to enter the Channel Label Editing Mode.
3. Add channel icons and channel labels as described in the procedures below. (You can do this more than once.)
4. To exit the menu when you are done, press **MENU**.

## Changing a Channel's Icon on the Master TV

1. Use Channel Up/Down to select the desired channel.
2. Use the Left/Right arrow keys to select the thin letter "I" on the Channel ID display.
3. Use the Up/Down arrow keys to select the icon with which you want to identify the channel. (If you know the icon number, enter the number, and press **ENTER**.)
4. Proceed to change/add channel labels, or go to the next channel.

## Changing/Adding Channel Labels on the Master TV

1. Use Channel Up/Down to select the desired channel.
2. Press the Left or Right arrow repeatedly until the numbers 1 to 7 appear on the display. The number shows the position of the character that can be changed. Number 1 is the first character, number 2 the second character, etc.
3. Use the Up/Down arrow keys to select the desired character.
4. Proceed to the next number position, or use Channel Up/Down to go to the next channel.

## Changing Source Labels on the Master TV

1. Press **INPUT** to select the desired Aux input source: A/V 1, A/V 2, HDMI Component, RGB, etc.
2. Press the Left or Right arrow repeatedly until the numbers 0 to 9 appear on the display. The number shows the position of the character that can be changed.
3. Use the Up/Down arrow keys to select the desired character.
4. Press **INPUT** for the next Aux source, or use Channel Up/Down to return to channels.

## Installer Remote Control Key Functions for Master TV Channel Editing/Labeling Menu

- **Channel Up/Down:** Tunes to the next channel in scan.
- **Left/Right Arrows:** Select the item to change. If "I" is shown, the icon can be changed. If a number is shown, it indicates the position of the character that can be changed.
- **Up/Down Arrows:** Select the icon or the character to be displayed. Tip: Arrows can be held down for fast scrolling.
- **0 – 9:** Use to enter the index number of the icon, if known.
- **ENTER:** Changes the icon after the number has been entered.
- **INPUT:** Changes the Aux input label.
- **MENU:** Exits the editing process.

## IMPORTANT CLONING INFORMATION

There are three options for cloning a Master TV Setup:

- Using a USB memory device
- Using a TLL-1100A clone programmer
- Using a LT2002 clone programmer

Each option is described in further detail on the pages that follow. As you perform cloning procedures, be sure to complete each task as indicated. If a procedure or step is omitted or not performed completely, cloning may not work. At each step, pay attention to ensure the TV screen shows the proper message when cloning. If the message indicated does not appear, there is a problem with that step, and cloning may not be successful.



**Warning: Copying a blank or incorrect memory into a TV will cause the TV to operate erratically or become inoperable.**



**Warning: Do not connect a clone programmer to a PPV card installed in the Master or Target TVs, as this will damage the clone programmer and the PPV card.**

### Before you begin cloning:

- Complete the Commercial Mode Setup for Master TV procedure on pages 12 to 13.
- All equipment should be connected to power and turned ON.
- Both the Master and Target TVs must be in Pass-through Mode.
- Ensure Installer Menu items on Target TVs are set/restored to factory default settings (i.e., set Installer Menu item 117 FACT DEFAULT to 001 on Target TVs) before Teaching is initiated.
- Learning and Teaching is only possible between identical model TVs.
- If using a USB memory device, ensure the USB device has been formatted with FAT format.
- For both Master and Target TVs—If using a clone programmer, ensure the TV signal source is either an Aux or TV (RF) source. If a TV (RF) source, the TV must be tuned to an analog (not a digital) channel.
- LT2002 only—Make sure the batteries in the clone programmer are fresh. If batteries are removed, the clone programmer clock time (if set) will be lost (see page 28 for information on the clone programmer clock).
- Do not unplug the TV power cord or remove/disconnect the USB memory device/clone programmer while Learning or Teaching, as doing so may cause the TV to malfunction or harm the USB device/clone programmer, respectively.

## Clonable Menu Features

### Installer Menu

Installer Menu item settings

### Channel

Auto Tuning (Channel Lineup)  
Manual Tuning  
Channel Edit  
Channel Label

### Picture

Aspect Ratio  
Picture Mode  
Advanced Control

### Audio

Auto Volume  
Clear Voice  
Sound Mode  
Balance  
TV Speaker

### Option

Menu Language  
Audio Language  
Caption  
Caption Mode  
Digital Caption Options

### Lock

Movie Rating  
TV Rating – Children  
TV Rating – General  
Input Block

### Time

Auto Clock  
Manual Clock  
Off Time  
On Time  
Auto Off (Sleep Timer)

**Note:** Some menu options vary between analog and digital channels and Aux sources.

Your TV's OSD (On Screen Display) may differ slightly from that shown in this manual.

# Cloning Procedures

## Learning / Teaching a Master TV Setup using a USB Memory Device

### USB Cloning Notes

- Read the IMPORTANT CLONING INFORMATION on page 23 before beginning any cloning procedures.
- You may edit a filename as part of the Learning procedure; however, a file with edited contents will not be recognized.
- It is not possible to clone a Master TV's clock using a USB memory device. Either set a Target TV's clock manually, or use the Auto Clock setting in the TV setup menus.

### Learn Setup from Master TV

1. Ensure the Master TV is set up completely and in Pass-through Mode.
2. Plug the USB memory device into the USB IN port on the Master TV.
3. Press **MENU** on the Installer Remote to display the TV setup menus, use the arrow navigation keys to select/highlight the **Option** menu icon, and then press the number "7" key a total of seven times to display the USB Download Menu.
4. To gain access to the "Learn From TV" option in the USB Download Menu, key in the password used to enter the Installer Menu (Example: Press **9-8-7-6**).
5. Use the Up/Down arrow keys to select **Learn From TV (TLL)**, and then press **ENTER**.
6. To identify the profile from others, you can use the Up/Down arrow keys to change the last five digits of the filename. Press **ENTER** when you are ready to initiate Learning.

Learning status will be shown on the progress bar. When the Learning process is complete, the USB Download menu will reappear on screen.

7. Remove the USB memory device from the Master TV.

### Teach Master TV Setup to Target TV

1. Ensure the Target TV is in Pass-through Mode, and then use the Installer Remote to enter the Target TV Installer Menu: Press **MENU** repeatedly until the on-screen setup menus lock up, and then press **9-8-7-6 + ENTER**.
2. Set Installer Menu item **117 FACT DEFAULT** to **001**, and press **ENTER**. When the value changes back to 0, press **ENTER** again to exit the Installer Menu.
3. Plug the USB memory device with the Master TV Setup file into the Target TV USB IN port.
4. Press **MENU** on the Installer Remote to display the TV setup menus, use the arrow navigation keys to select/highlight the **Option** menu icon, and then press the number "7" key a total of seven times to display the USB Download Menu.
5. Use the Up/Down arrow keys to select **Teach To TV (TLL)**, and then press **ENTER**.
6. Use the Up/Down arrow keys to select the Master TV Setup you want to install, and then press **ENTER**. Note: Filenames identify the TV and the TLL version (see example at right).

Teaching status will be shown on the progress bar. When the Teaching process is complete, the USB Download menu will reappear on screen.

7. When Teaching is done, remove the USB memory device from the Target TV, turn OFF the TV, and unplug the TV power cord for 15 seconds.
8. Reconnect the TV power cord, and turn ON the TV. The Master TV Setup should be resident on the Target TV.

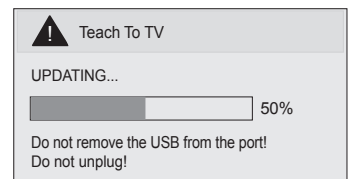
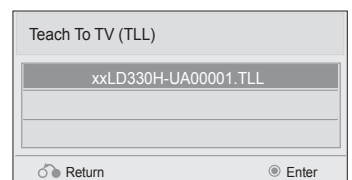
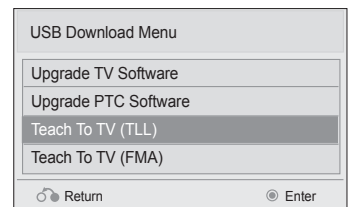
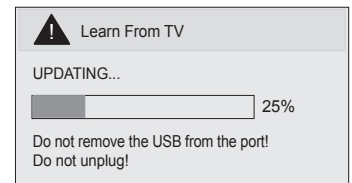
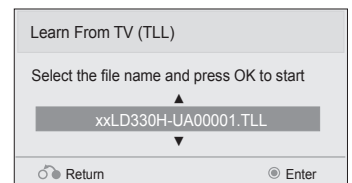
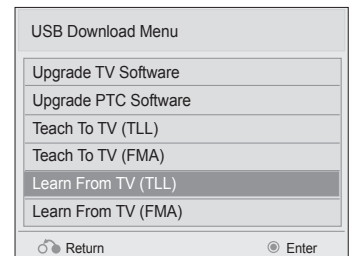

## Learning / Teaching a Master TV Setup using a TLL-1100A Clone Programmer

**Warning:** Do not connect a clone programmer to a PPV card installed in the Master or Target TVs, as this will damage the clone programmer and the PPV card.

Cloning is accomplished using the TV/clone programmer MPI ports for communication (see figure).

### TLL-1100A Cloning Notes

- Read the IMPORTANT CLONING INFORMATION on page 23 before beginning any cloning procedures.
- Ensure the TLL-1100A is either fully charged or connected to AC power.
- Learning and Teaching is only possible between identical model TVs; however, the TLL-1100A clone programmer can store up to eight different Master TV Setups.

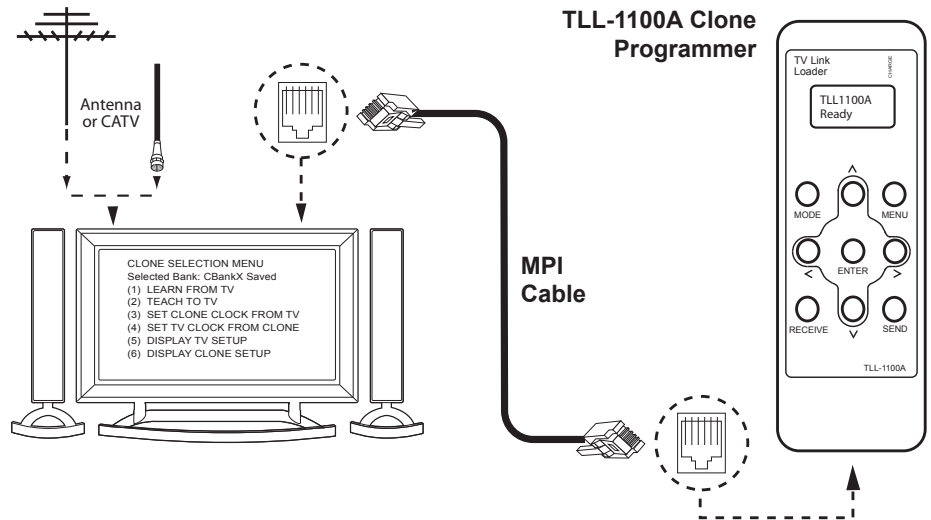

### Learn Setup from Master TV

1. Ensure the Master TV is set up completely and in Pass-through Mode.
2. If an analog channel is not available, direct tune the TV to an Aux source, or select an Aux source, such as AV-1, from the Input Menu. Then, plug one end of the MPI cable into the TV MPI port.
3. Turn ON the TLL-1100A.
4. Use the **MODE** button on the TLL-1100A to select **Clone Mode**.
5. Use the Left/Right arrows on the TLL-1100A to select the Memory CBank (1 to 8) in which to store the Master TV Setup.
6. Plug the other end of the MPI cable into the MPI port on the bottom of the TLL-1100A. The Clone Selection Menu will display on the TV screen.
7. Press **1** on the Installer Remote to select **LEARN FROM TV** from the Clone Selection Menu. Then, press **ENTER** to transfer the Master TV Setup into CBankX on the TLL-1100A.

Learning usually takes about 90 seconds. "LEARNING IN PROGRESS" will be displayed on the screen while the TLL-1100A copies the Master Setup. When the Learning process is complete, a "LEARNING COMPLETE" message will be displayed.

8. When Learning is complete, disconnect the MPI cable from the Master TV.

CLONE SELECTION MENU  
Selected Bank: CBankX Saved  
(1) LEARN FROM TV  
(2) TEACH TO TV  
(3) SET CLONE CLOCK FROM TV  
(4) SET TV CLOCK FROM CLONE  
(5) DISPLAY TV SETUP  
(6) DISPLAY CLONE SETUP

CLONE CLOCK = XX:XX  
TV CLOCK = XX:XX  
THE CLONE IS VERSION VX.X.X  
- To change menu items, press channel keys or digits.  
- To execute item, press Enter.

# Cloning Procedures (Cont.)

## Learning / Teaching a Master TV Setup using a TLL-1100A Clone Programmer (Cont.)

---

### (Optional) Set the Clock

Set the time on a Master TV's clock. (If the time has already been copied from a TV into the TLL-1100A clone programmer, you can set the Master TV's clock by copying the time from the clone programmer.) The TLL-1100A can copy the current time to both a Master TV and to the clone's internal clock—accurate to within one minute.

Since the TLL-1100A's time cannot be set directly, the current time needs to be copied from an LG TV equipped with an enabled MPI port.

After the time is copied to the TLL-1100A clone programmer, the current time will be maintained and can then be transferred to another TV. (This can be a Master TV or another TV which has already had the features set up.)

### Teach Master TV Setup to Target TV

1. Ensure the Target TV is in Pass-through Mode, and then use the Installer Remote to enter the Target TV Installer Menu: Press **MENU** repeatedly until the on-screen setup menus lock up, and then press **9-8-7-6 + ENTER**.
2. Set Installer Menu item **117 FACT DEFAULT** to **001**, and press **ENTER**. When the value changes back to 0, press **ENTER** again to exit the Installer Menu.
3. Tune/set the TV to an analog channel or Aux source, and then connect the MPI cable to the MPI port on the Target TV. The Clone Selection Menu will display on the TV screen.
4. Ensure the correct Memory CBank(X) is selected on the TLL-1100A.
5. Press **2** on the Installer Remote to select **TEACH TO TV** from the Clone Selection Menu. Then, press **ENTER** to transfer the Master TV Setup to the Target TV.  
Teaching usually takes 3 to 4 minutes. "TEACHING IN PROGRESS" will be displayed on the screen during Teaching. When the Teaching process is complete, a "TEACHING COMPLETE" message will be displayed.
6. When Teaching is done, disconnect the MPI cable from the Target TV, turn OFF the TV, and unplug the TV power cord for 15 seconds.
7. Reconnect the TV power cord, and turn ON the TV. The Master TV Setup should be resident on the Target TV.

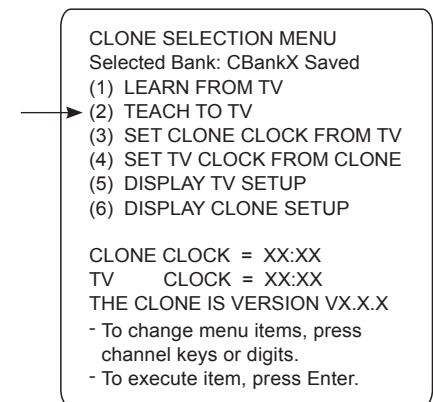
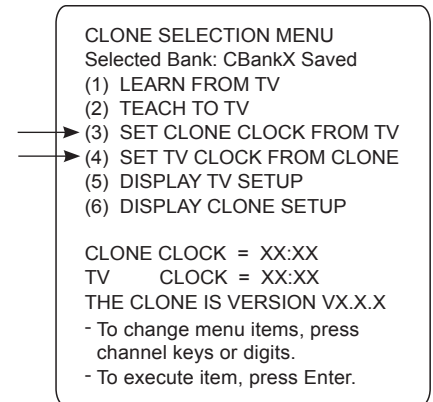

## Learning / Teaching a Master TV Setup using an LT2002 Clone Programmer

**Warning:** Do not connect a clone programmer to a PPV card installed in the Master or Target TVs, as this will damage the clone programmer and the PPV card.

Cloning is accomplished using the TV/clone programmer MPI ports for communication (see figure).

### LT2002 Cloning Notes

- Read the IMPORTANT CLONING INFORMATION on page 23 before beginning any cloning procedures.
- A slow flashing green light indicates that there are communication problems between the TV and the LT2002 clone programmer. If this is the case, check for a damaged cable, poor contacts, or other connection troubles.
- If the status indicator is red, the LT2002 batteries are low and should be replaced. Install four (4) high-quality alkaline AA batteries.
- Learning and Teaching is only possible between identical model TVs; however, the LT2002 clone programmer can store up to three different Master TV Setups.

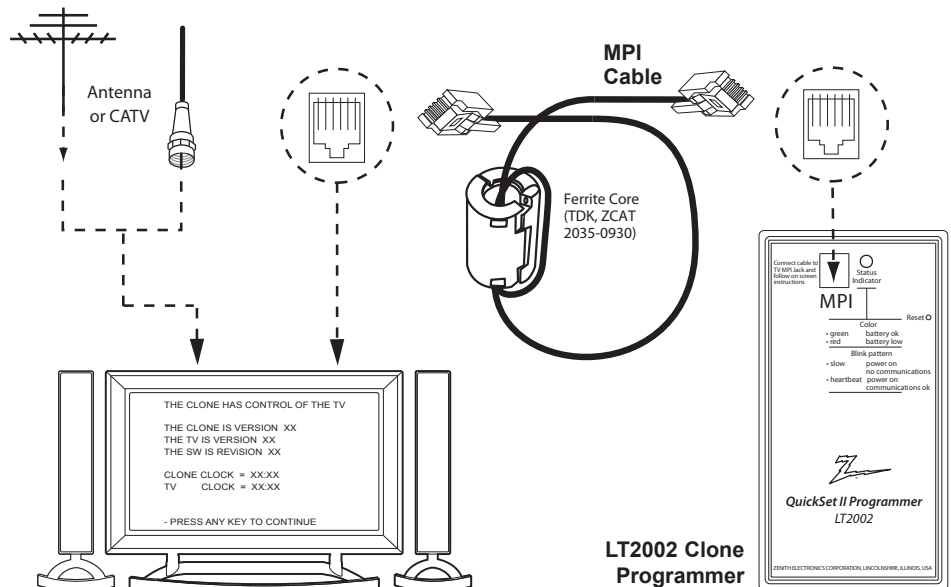

### Learn Setup from Master TV

1. Ensure the Master TV is set up completely and in Pass-through Mode.
2. If an analog channel is not available, direct tune the TV to an Aux source, or select an Aux source, such as AV-1, from the Input Menu. Then, plug one end of the MPI cable into the TV MPI port.
3. If there is a good connection after the LT2002 is connected to the TV MPI port, "THE CLONE HAS CONTROL OF THE TV" message will appear on the TV screen. Press any key on the Installer Remote to access the LT2002 Clone Selection Menu.
4. Press **1** on the Installer Remote to select **LEARN FROM TV** from the Clone Selection Menu; then press **ENTER** to proceed to the Memory Bank Selection Menu (see sample screen on next page).
5. Press 1, 2, or 3 on the Installer Remote to select the clone Memory Bank in which to store the Master Setup. Then, press **ENTER**.

**Note:** If you choose a Memory Bank that already has a Master device's setup programmed into it, that setup will be overwritten by the new Master TV Setup.

(Continued on next page)

THE CLONE HAS CONTROL OF THE TV

```

THE CLONE IS VERSION XX
THE TV IS VERSION XX
THE SW IS REVISION XX

CLONE CLOCK = XX:XX
TV   CLOCK = XX:XX

-PRESS ANY KEY TO CONTINUE.

-DISCONNECT CLONE WHEN DONE.
    
```

CLONE SELECTION MENU

- (1) LEARN FROM TV
- (2) TEACH TO TV
- (3) SET CLONE CLOCK FROM TV
- (4) SET TV CLOCK FROM CLONE
- (5) DISPLAY TV SETUP
- (6) DISPLAY CLONE SETUP

- TO CHANGE MENU ITEMS, PRESS CHANNEL KEYS OR DIGITS.

- TO EXECUTE ITEM, PRESS ON/OFF, POWER, OR ENTER.

# Cloning Procedures (Cont.)

## Learning / Teaching a Master TV Setup using an LT2002 Clone Programmer (Cont.)

(Continued from previous page)

6. Verify the Learning setup information on the next screen, and then press **POWER** to transfer the Master TV Setup into the selected Memory Bank on the LT2002.

Learning usually takes about 90 seconds. "LEARNING IN PROGRESS" will be displayed on the screen while the LT2002 copies the Master Setup. When the Learning process is complete, a "LEARNING COMPLETE" message will be displayed.

7. When Learning is complete, disconnect the MPI cable from the Master TV.

### (Optional) Set the Clock

Set the time on a Master TV's clock. (If the time has already been copied from a TV into the LT2002 clone programmer, you can set the Master TV's clock by copying the time from the clone programmer.) The LT2002 can copy the current time to both a Master TV and to the clone's internal clock—accurate to within one minute. (Another reason that the LT2002 should be equipped with fresh, high-quality alkaline batteries, is for it to keep the time as accurately as possible.)

Since the LT2002's time cannot be set directly, the current time needs to be copied from an LG TV equipped with an enabled MPI port.

After the time is copied to the LT2002 clone programmer, the current time will be maintained and can then be transferred to another TV. (This can be a Master TV or another TV which has already had the features set up.)

### Teach Master TV Setup to Target TV

1. Ensure the Target TV is in Pass-through Mode, and then use the Installer Remote to enter the Target TV Installer Menu: Press **MENU** repeatedly until the on-screen setup menus lock up, and then press **9-8-7-6 + ENTER**.
2. Set Installer Menu item **117 FACT DEFAULT** to **001**, and press **ENTER**. When the value changes back to 0, press **ENTER** again to exit the Installer Menu.
3. Tune/set the TV to an analog channel or Aux source, and then connect the MPI cable to the MPI port on the Target TV.
4. With "THE CLONE HAS CONTROL OF TV" message on display, press **2** on the Installer Remote to select **TEACH TO TV** from the LT2002 Clone Selection Menu. Then, press **ENTER**.
5. Select the LT2002 Memory Bank in which the new Master TV Setup is located, and press **ENTER**.

6. Verify the Teaching setup information on the next screen, and then press **POWER** to transfer the Master TV Setup to the Target TV.

Teaching usually takes 3 to 4 minutes. "TEACHING IN PROGRESS" will be displayed on the screen during Teaching. When the Teaching process is complete, a "TEACHING COMPLETE" message will be displayed.

7. When Teaching is done, disconnect the MPI cable from the Target TV, turn OFF the TV, and unplug the TV power cord for 15 seconds.
8. Reconnect the TV power cord, and turn ON the TV. The Master TV Setup should be resident on the Target TV.

SAVE TV SETUP IN SELECTED CLONE MEMORY

- (1) MEMORY 1 VER XX REV XX
- (2) MEMORY 2 VER XX REV XX
- (3) MEMORY 3 VER XX REV XX
- (4) RETURN TO CLONE MENU

- TO CHANGE MENU ITEMS, PRESS CHANNEL KEYS OR DIGITS.

- TO EXECUTE ITEM, PRESS ON/OFF, POWER, OR ENTER.

CLONE SELECTION MENU

- (1) LEARN FROM TV
- (2) TEACH TO TV
- (3) SET CLONE CLOCK FROM TV
- (4) SET TV CLOCK FROM CLONE
- (5) DISPLAY TV SETUP
- (6) DISPLAY CLONE SETUP

- TO CHANGE MENU ITEMS, PRESS CHANNEL KEYS OR DIGITS.

- TO EXECUTE ITEM, PRESS ON/OFF, POWER, OR ENTER.

CLONE SELECTION MENU

- (1) LEARN FROM TV
- (2) TEACH TO TV
- (3) SET CLONE CLOCK FROM TV
- (4) SET TV CLOCK FROM CLONE
- (5) DISPLAY TV SETUP
- (6) DISPLAY CLONE SETUP

- TO CHANGE MENU ITEMS, PRESS CHANNEL KEYS OR DIGITS.

- TO EXECUTE ITEM, PRESS ON/OFF, POWER, OR ENTER.

COPY SELECTED CLONE MEMORY TO TV

- (1) MEMORY 1 VER XX REV XX
- (2) MEMORY 2 VER XX REV XX
- (3) MEMORY 3 VER XX REV XX
- (4) RETURN TO CLONE MENU

- TO CHANGE MENU ITEMS, PRESS CHANNEL KEYS OR DIGITS.

- TO EXECUTE ITEM, PRESS ON/OFF, POWER, OR ENTER.

## FTG Mode Overview

FTG Mode enables Pro:Idiom decryption and also allows logical channel mapping of physical channels. This section describes how to configure the TV's CPU for FTG Mode operation.

Use one of the following processes to configure the CPU with FTG Channel Map and FTG Installer Menu settings:

- Configure an individual LD330H TV via its USB port using an FMA Configuration (.fma) file on a USB memory device. The "Teach to TV (FMA)" process, along with associated procedures, is described on pages 30 to 33.
- Configure all LD330H TVs at the site using a Pro:Centric server head end device (Example: PCS150R). Load an FMA Configuration (.fma) file on the Pro:Centric server using the TV E-Z Installation "Configuration" option in the Pro:Centric Server Admin Client. Refer to the **Pro:Centric™ Server Admin Client User Guide** for further information.

While the TV is in FTG Mode:

- Users can still access the Installer Menu using an LG Installer Remote; however, all Installer Menu items will be read-only.
- Any FTG configuration changes must be made in the FTG Configuration Application. FTG Channel Map Configuration and FTG Installer Menu Configuration Utilities enable you to make changes, respectively, to the FTG Channel Map and FTG Installer Menu settings as necessary.
- If it becomes necessary to reset the TV to Pass-through Mode, there are several options that will enable you to do so. Refer to Reference section, "Resetting a TV to Pass-through Mode," for further information.

Pages 34 to 37 provide overviews of the FTG Channel Map, FTG Installer Menu, and FMA Configuration Utilities that comprise the FTG Configuration Application. Refer to the **Free-To-Guest (FTG Configuration Application)** manual for further information on the FTG Configuration Application.



**Note: The LD330H cannot be configured for FTG Mode if an external MPI device has been implemented as a means of controlling the TV.**

## Determining the TV Operating Mode

To determine the operating mode of the TV, press **MENU** on the Installer Remote. The menu display alternates based on the operating mode. See examples at right.

If the end user Function Menu appears, the TV is in FTG Mode. If the TV setup menus appear, the TV is in Pass-through Mode.

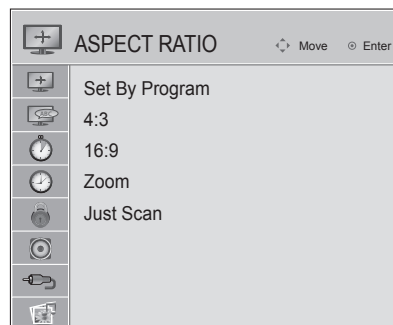

### Function Menu

Indicates the TV CPU is in FTG Mode. While the TV is in FTG Mode, Installer Menu settings can be accessed as read-only using an Installer Remote. To make changes, use the FTG Configuration Application.

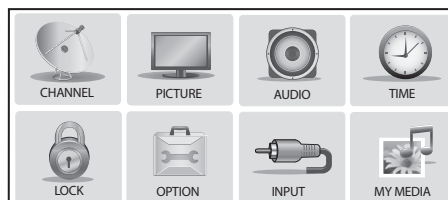

### TV Setup Menus

Shows that the TV is in Pass-through Mode.



# FTG Mode of Operation (Cont.)

---

## Creating an FMA Configuration File using the FTG Configuration Application

This section describes how to create an FMA Configuration file that can be saved to a USB memory device. In order to enable Pro:Idiom decryption, it is recommended that you create an FMA Configuration file using the FTG Configuration Application. However, if you do not know the RF channels at the site, there is an option to save (Learn) an FMA Configuration file from a TV (see “Learning an FMA Configuration File from a TV” on page 32).

The procedure below provides an overview of the steps required to create an FMA Configuration (.fma) file. Refer to the **Free-To-Guest (FTG) Configuration Application** manual for further information. See also FTG Configuration Application sample screens on pages 34 to 37.

**Note:** FTG Configuration Application software is available online at: [www.LGcommercial.com/FTGsoftware](http://www.LGcommercial.com/FTGsoftware).

1. Install (if necessary) and launch the FTG Configuration Application (v5.0.0 or higher) on the PC that will be used to create the FMA Configuration file.
2. Either:
  - Open an existing FTG Configuration (.rml) file, if applicable, to use its FTG Channel Map. Otherwise, create a new FTG Channel Map using the FTG Channel Map Editor in the FTG Channel Map Configuration Utility. Then, continue with step 3.  
**Note:** Up to 141 logical channels can be defined in the FTG Channel Map.
  - To view and/or base a new FMA Configuration file on an existing LD330H FMA Configuration file, click **Configure** in the FTG Configuration Application menu bar, and select **FMA** to access the FMA Configuration Utility. Then, click the **Open** button above the FMA Configuration List, and double-click the desired (.fma) file. A list of the file’s contents will be displayed in the FMA Configuration List window, and you can edit the FMA Configuration List as necessary to create a new file. Proceed to step 4 when you are ready to continue.
3. Click **Configure** in the FTG Configuration Application menu bar, and select **FMA** to access the FMA Configuration Utility.
4. To add an FTG Channel Map, click >> under FTG Channel Map to copy the current FTG Channel Map to the FMA Configuration List.  
**Note:** If you make any change(s) in the FTG Channel Map Configuration Utility to the current data to be included in the FMA Configuration List, you will need to recopy the FTG Channel Map to the FMA Configuration List.
5. Load default Installer Menu settings for the LD330H TV:
  - Click the down arrow at the right of the Chassis field under Installer Menu Templates, and select **32/37LD330H** from the drop-down list of available models.
  - Click the **Load** button.
  - Use the FTG Installer Menu Configuration Utility to modify settings, if necessary. Then, return to the FMA Configuration Utility.
  - Click >> under FTG Installer Menu Settings to copy the LD330H settings to the FMA Configuration List.
6. Click the **Save** button above the FMA Configuration List to save its contents to an FMA Configuration (.fma) file for later use.
7. Save the FMA Configuration file to a USB memory device, and proceed to “Teaching FMA Configuration to a TV” on the following page to transfer the FMA Configuration file to an LD330H TV.

## Teaching FMA Configuration to a TV

This procedure describes how to “Teach” an FMA Configuration file from a USB memory device to a TV. Ensure you have completed the procedure on the previous page to create the FMA Configuration file before proceeding with the steps below.

1. Plug the USB memory device that contains the FMA Configuration file into the Target LD330H TV USB IN port.
2. Press **MENU** to display the TV setup menus, use the arrow navigation keys to select/highlight either the **Option** (if TV is in Pass-through Mode) or **Lock** (if TV is already in FTG Mode) menu icon, and then press the number “7” key a total of seven times to display the USB Download Menu.
3. Use the Up/Down arrow keys to select **Teach To TV (FMA)**, and then press **ENTER**.
4. Use the Up/Down arrow keys to select the FMA Configuration file you want to install, and then press **ENTER**.

The TV will show Teaching completion progress in a new window. Do NOT remove the USB device until Teaching is complete. When Teaching is complete, the TV will tune to the first logical channel in the FTG Channel Map.

5. When Teaching is done, remove the USB memory device. The FMA Configuration should be resident on the Target TV. Also, the Target TV CPU is now in FTG Mode (if it was previously in Pass-through Mode).

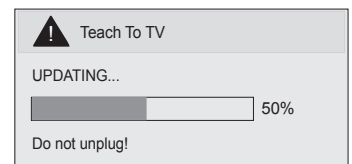
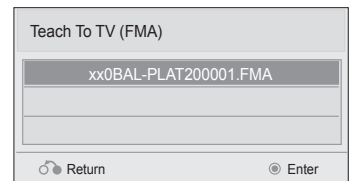
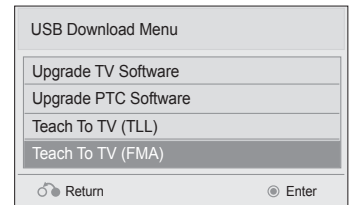

## FTG Mode of Operation (Cont.)

### Learning an FMA Configuration File from a TV

To ensure that Pro:Idiom decryption is enabled, it is recommended that you create an FMA Configuration file using the FTG Configuration Application as described on page 30. However, if necessary, this option enables you to save (Learn) an FMA Configuration file from an LD330H TV to a USB memory device.

**Note:** If the LD330H TV is NOT already in FTG Mode, you may need to perform some manual configuration on the TV before you start this procedure (see “Optional Manual Configuration / Setup for a TV” on following page).

1. Plug a USB memory device into the USB IN port on the TV.
2. Press **MENU** to display the TV setup menus, use the arrow navigation keys to select/highlight either the **Option** (if TV is in Pass-through Mode) or **Lock** (if TV is already in FTG Mode) menu icon, and then press the number “7” key a total of seven times to display the USB Download Menu.
3. To gain access to the Learn From TV options in the USB Download Menu, key in the password used to enter the Installer Menu (Example: Press **9-8-7-6**).
4. Use the Up/Down arrow keys to select **Learn From TV (FMA)**, and then press **ENTER**.
5. To identify the file from others, you can use the Up/Down arrow keys to change the last five digits of the filename. Press **ENTER** when you are ready to initiate Learning.  
The TV will show Learning completion progress in a new window. Do NOT remove the USB device until Learning is complete. When Learning is complete, the USB Download Menu will reappear on screen.
6. When you are finished, remove the USB memory device.

 **Note:** It is highly recommended that you open this FMA Configuration file in the FTG Configuration Application—BEFORE transferring (Teaching) the file to any TVs—to verify FTG Channel Map and FTG Installer Menu settings and enable Pro:Idiom decryption by marking Encrypted channels. This will also enable you to confirm and add channel attributes, labels, etc.

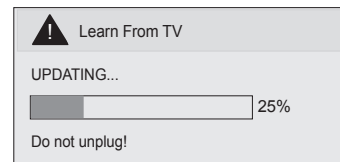
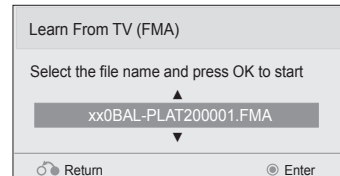
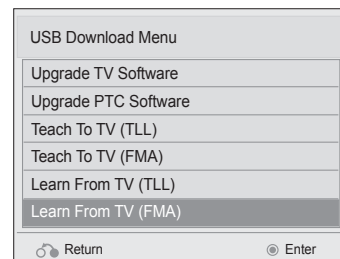

## Optional Manual Configuration / Setup for a TV

The manual configuration procedures below should only be performed if you do not know the RF channels at the site and need to “Learn” the FMA Configuration file from an LD330H TV as described on the previous page. Ensure the TV is in Pass-through Mode before you begin.

### Set Installer Menu Items

These steps provide specific instruction only on the Installer Menu items that should be set on an LD330H TV. Refer to pages 14 to 20 for detailed information on all Installer Menu items.

1. Make sure the TV is ON. Then, use the Installer Remote to enter the TV Installer Menu: Press **MENU** repeatedly until the on-screen setup menus lock up, and then press **9-8-7-6 + ENTER**.
2. Set Installer Menu item **117 FACT DEFAULT** to **001** and press **ENTER** on the Installer Remote.

This clears all Installer Menu custom settings, the channel lineup, etc. and reloads the factory default settings. The value will change back to 0 after the internal TV controller (PTC) has been restored to factory default condition. This step ensures that the TV Channel Memory will be the active channel lineup.

3. Set Installer Menu item **003 BAND/AFC**, as appropriate.
  - Broadcast: Set to 000.
  - CATV: Set to 001 (default).
  - HRC: Set to 002.
  - IRC: Set to 003.
4. Set any other Installer Menu items that affect your TV programming network to the required configuration. For example, enable/disable Aux sources, set a Start Channel, etc.
5. After you have adjusted all required Installer Menu item settings, press **ENTER** once on the Installer Remote to save your changes; then, press **ENTER** again to exit the menu.

### Run Auto Tuning (Channel Search)

**Note:** In the FMA Configuration file, Logical Channel numbers will automatically be assigned in ascending order, starting with 0 (zero), to the Physical Channels from the TV Channel Map.

**Note:** Pro:Idiom decryption for encrypted channels will not be enabled unless you use the FTG Configuration Application to set the channel attributes.

1. Search for all available analog and digital channels: Use the Installer Remote to go to the Channel Menu, select the **Auto Tuning** option, and follow the on-screen instructions.
2. Use the **Channel Edit** option in the Channel Menu to edit the channel lineup, as necessary, to include free to guest channels only. Add/delete channels per your system requirements. \*

Once you have completed these procedures, return to “Learning an FMA Configuration File from a TV” on the previous page to complete the Learn sequence.

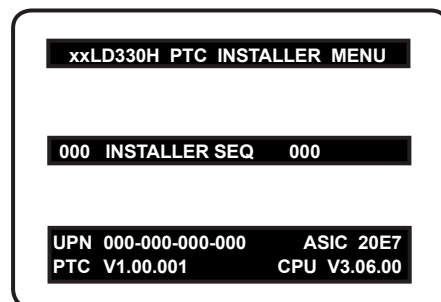

Typical TV Installer Menu

Note: The Installer Menu header will vary depending on the TV you are setting up.



Adjust the settings for these Installer Menu items.

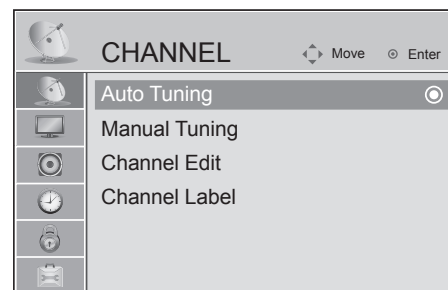

Run Auto Tuning and edit the channel lineup, as necessary.

\* If Installer Menu item 103 ATSC TUNE MODE is set for Physical Channel tuning (default and recommended setting), minor channel numbers cannot be higher than 255. If set for Virtual Channel tuning, neither major nor minor channel numbers can be higher than 255. Note also that the FTG Configuration Application does not support major or minor channel numbers higher than 255.



# FTG Configuration Application Utilities Overview (Cont.)

## FTG Channel Map Editor

The FTG Channel Map Editor shows a single Logical Channel's Data and the FTG Channel Map.

### LOGICAL CHANNEL MAPPING

Select a Logical Channel number, then assign it the RF, Major, and Minor channel numbers to complete the mapping. \*

### CUSTOM CHANNEL LABELS/ICONS

Enter custom labels and select icons by name on menu or by number.

### SET CHANNEL ATTRIBUTES

Check/select Encrypted, OSD, or Blank Video.

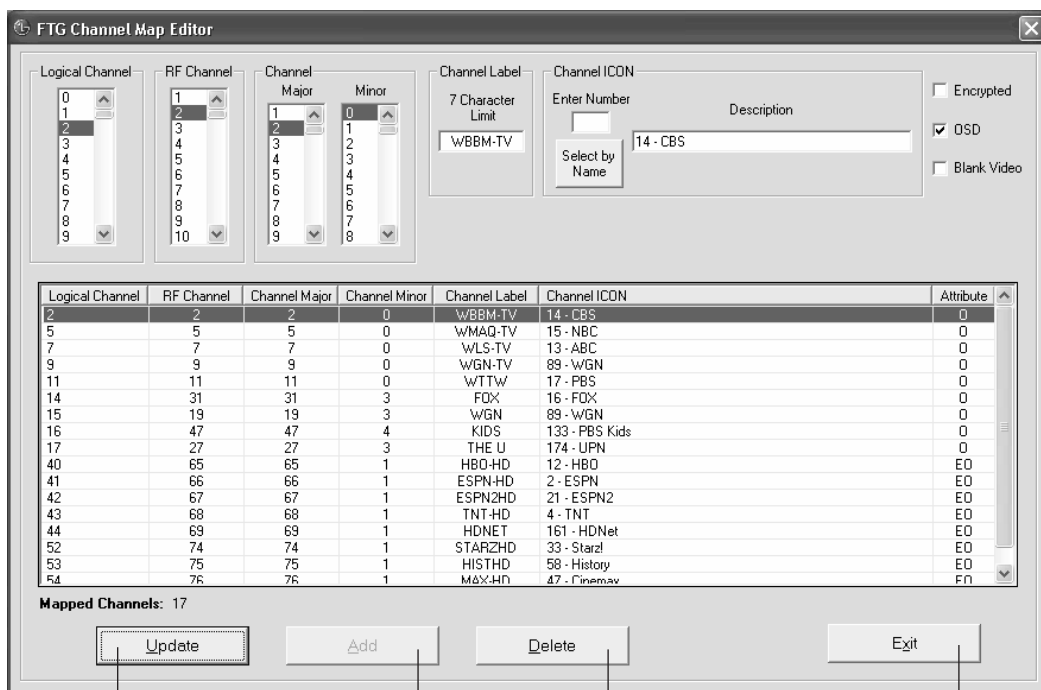

### UPDATE

After editing an existing Logical Channel's data, click to commit the changes in the FTG Channel Map.

### ADD

After defining a new Logical Channel, click to add channel to the FTG Channel Map.

### DELETE

Click to remove highlighted channel from FTG Channel Map.

### EXIT

Click to exit editor and return to FTG Channel Map Configuration Utility.

\* The FTG Configuration Application does not support major or minor channel numbers higher than 255.

# FTG Configuration Application Utilities Overview (Cont.)

## FTG Installer Menu Configuration Utility

**Note:** Write, Read, Learn, and IR Remote Access functions in the FTG Installer Menu Configuration Utility are used for local FTG configuration of TVs that support a direct connection to a PC. These functions are not applicable to the process of creating an FMA Configuration file to be used with LD330H TVs.

### CONFIGURATION SETTINGS

Select tabs for categories of Installer Menu items to set up TV.

### HOSPITAL-GRADE TV ONLY

Set Hospital items on Installer Menu for hospital-grade TVs.

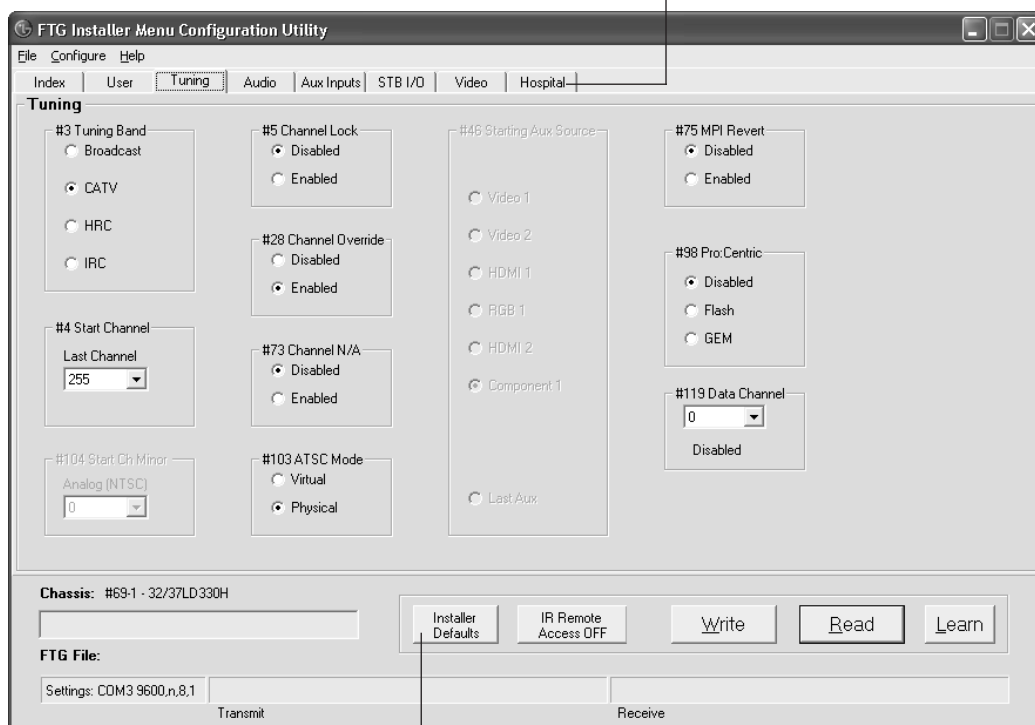

### INSTALLER DEFAULTS

Click to reset FTG Installer Menu items shown in the FTG Configuration Application to defaults.

# FTG Configuration Application Utilities Overview (Cont.)

## FMA Configuration Utility

**Note:** FMA Write, Read, Clock, Broadcast, Firmware, and IP Communication functions in the FMA Configuration Utility are used to configure control equipment (Example: FMA-LG101) at the hotel/institution head end. These functions are not applicable to the process of creating an FMA Configuration file to be used with LD330H TVs.

**FMA CONFIGURATION LIST**  
(data to be saved or already saved in FMA Configuration file)

**NEW/OPEN/SAVE**  
FMA File options

Filename of opened FTG Configuration file (if applicable)

Copy FTG Channel Map to and from FMA Configuration List.

Copy FTG Installer Menu settings to and from FMA Configuration List.

Load default FTG Installer Menu for LD330H.

FMA Configuration List	
17 Mapped Channels	
IM (Items Default)	32/37LD330H



**Note:** The data referenced in the FMA Configuration List is only a snapshot of the current FTG Channel Map and FTG Installer Menu settings when copied to the list. If you make any change(s) to the current data to be included in the FMA Configuration List, you will need to recopy Channel Map and Installer Menu settings to the FMA Configuration List.



# Reference: Upgrading TV/PTC Software using a USB Memory Device

## Checking the Software Versions

You can check the software versions of the TV by accessing the Installer Menu with the Installer Remote: Press **MENU** repeatedly until the on-screen setup menus lock up, and then press **9-8-7-6 + ENTER**. When you are finished, press **ENTER** again to exit the Installer Menu.

Typical TV  
Installer Menu

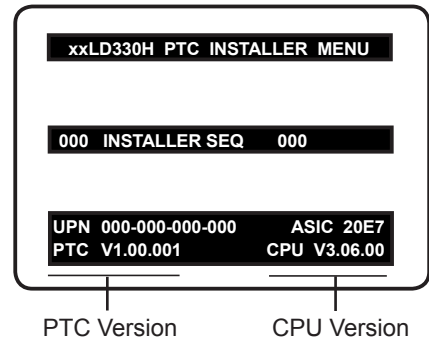

## Upgrading TV/PTC Software

Before you begin, note that the software upgrade files must be stored in a folder named "LG\_DTV" in the root directory of the USB memory device. Also, ensure the USB device has been formatted with FAT format.

**Note for TV Software Upgrade only:** If the TV detects a later version of software on the USB device, it will automatically display a dialog from which you can start the software upgrade immediately. Otherwise, you can close the dialog, and access the USB Download Menu as described below.

1. Turn the TV ON.
2. Plug the USB memory device into the USB IN port on the TV.
3. Press **MENU** on the Installer Remote to display the TV setup menus.
4. Use the arrow navigation keys to select/highlight either the **Option** (if TV is in Pass-through Mode) or **Lock** (if TV is in FTG or LodgeNet PPV Mode) menu icon; then, press the number "7" key a total of seven times to display the USB Download Menu.
5. Use the Up/Down arrow keys to select **Upgrade TV Software** or **Upgrade PTC Software**, as applicable, and then press **ENTER**.
6. Select the appropriate option(s), depending on the type of upgrade you are performing:
  - **TV Software Upgrade:** (See screen samples at right.) Select **TV Software Update** from the first TV Software Update window. In the second TV Software Update window, select the update file to install and press **ENTER**.  
**Note:** Do not select Forced Update options unless you have been specifically instructed to do so or have previous experience with Expert Software Updates.
  - **PTC Software Upgrade:** In the PTC Software Update window, select the update file to install and press **ENTER**.  
**Note:** The PTC Software Update window is similar to the second TV Software Update window, though there are no Forced Update options. Current software version information is shown at the top and update files on the USB device are listed at the bottom of the window.

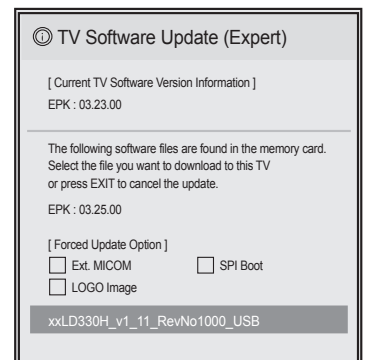
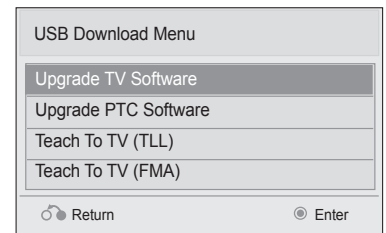

The TV will show update completion progress in a new window. Do NOT remove the USB device until the software upgrade is complete. When a TV software upgrade is complete, the TV will reset itself with an automatic restart. When a PTC upgrade is complete, the TV will turn OFF.

# Reference: Downloading a Splash Screen using a USB Memory Device

## Splash Screen Image File Guidelines

- The splash screen image must be a baseline (not progressive) JPEG.
- The image should be no larger than 1 MB.
- The ideal size for the image is 1366 x 768 pixels or under.
- The image file must be stored in a folder named “LG\_DTV” in the root directory of USB memory device.
- Ensure the USB device has been formatted with FAT format.

## Downloading a Splash Screen Image

1. Turn the TV ON.
2. Plug the USB memory device into the USB IN port on the TV.
3. Press **MENU** on the Installer Remote to display the TV setup menus.
4. Use the arrow navigation keys to select/highlight either the **Option** (if TV is in Pass-through Mode) or **Lock** (if TV is in FTG or LodgeNet PPV Mode) menu icon; then, press the number “7” key a total of seven times to display the USB Download Menu.
5. Use the Up/Down arrow keys to select **Upgrade TV Software**, and then press **ENTER**.
6. Select **LOGO Image Download** from the first TV Software Update window.
7. In the second TV Software Update window, select the image file to download and press **ENTER**.

The TV will show download completion progress in a new window. Do NOT remove the USB device until the image download is complete. When the image download is complete, the TV will reset itself with an automatic restart. Upon the restart, you should see the new splash screen.

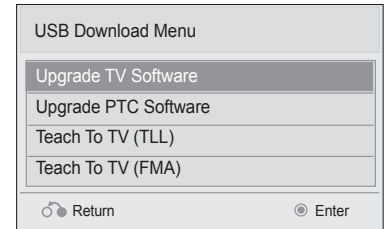

## Reference: Power Consumption Settings

The following tables assume Installer Menu item 099 BACK LIGHTING is set as shown below (default value is 100).

Item 099 Back Lighting (Static)	32LD330H		37LD330H	
	Power Consumption (Watts)	Percent Savings	Power Consumption (Watts)	Percent Savings
100	72.97	0.00%	88.92	0.00%
90	63.82	12.54%	84.19	5.32%
80	58.53	19.78%	77.84	12.46%
70	53.58	26.57%	72.19	18.81%
60	44.24	39.38%	66.28	25.46%
50	41.27	43.45%	60.90	31.51%
40	38.71	46.95%	56.58	36.37%
30	36.20	50.39%	52.35	41.13%
20	33.51	54.07%	47.75	46.30%
10	31.01	57.51%	43.68	50.88%
1	28.55	60.87%	39.62	55.44%

Item 099 Back Lighting (Dynamic)	32LD330H		37LD330H	
	Power Consumption (Watts)	Percent Savings	Power Consumption (Watts)	Percent Savings
200	75.45	0.00%	110.86	0.00%
190	69.23	8.25%	99.05	10.65%
180	65.26	13.51%	92.33	16.72%
170	60.72	19.53%	85.39	22.98%
160	56.29	25.40%	78.61	29.10%
150	51.82	31.33%	71.70	35.32%
140	46.62	38.21%	63.53	42.69%
130	41.67	44.78%	55.65	49.80%
120	36.14	52.10%	47.34	57.30%
110	31.11	58.76%	39.90	64.01%
101	26.41	65.00%	33.00	70.24%

Note: Values are results of controlled experiments under laboratory conditions.

# Reference: TV Camport Auto Sense Operation

The Camport Auto Sense function is enabled when:  
 1. Installer Menu item 034 CAMPORT EN is set to 1 AND  
 2. Installer Menu item 040 AUTO CAMPORT is enabled (1).

**Selectable:** Can be accessed with INPUT key, direct access, etc.

**Auto Sense:** TV switches to this input when connector is inserted. The Camport (Side [AV IN 2] Video) has the highest priority and will override any commands including tuning to the Start Channel.

## CAMPORT (Side Video) Functionality Control

Item 034 CAMPORT EN	Item 040 AUTO CAMPORT	Side (AV IN 2) Video Operation
0	0	Disabled
0	1	Disabled
1	0	Selectable
1	1	Auto Sense

## Camport Operation (Stand-alone)

When Camport Auto Sense is enabled as above, the TV's source will switch to the Side (AV IN 2) Video Aux source whenever a plug is inserted into the AV IN 2 Video input.

When the plug is removed, the TV will switch back to the previous channel or input source that was being displayed before the plug was inserted. However, if any direct access to an RF channel or Aux channel is requested while the Camport is active, then, when the video plug is removed, the TV will switch to the last requested channel. Source changes using any Source keys (INPUT) are ignored. Channel Up/Down and Flashback commands are not direct access tuning commands, and they are also ignored.

Previous State Before Inserting CAMPORT	Operation While CAMPORT is Active	State Upon Removal of CAMPORT
Aux or RF Channel	None	Previous Aux or RF Channel
Aux or RF Channel	Direct Access	Last Requested Aux or RF Channel
Aux or RF Channel	Ch Up/Down, Flashback, and Input Keys	Previous Aux or RF Channel

## Camport Operation (FTG or PPV)

The operation will be similar to that of the Stand-alone Mode. However, when the Channel Map is maintained external to the PTC (i.e., FTG and PPV), Channel Up/Down or Flashback keys are sent as Direct Access tuning commands to the PTC/TV.

Previous State Before Inserting CAMPORT	Operation While CAMPORT is Active	State Upon Removal of CAMPORT
Aux or RF Channel	None	Previous Aux or RF Channel
Aux or RF Channel	Direct Access	Last Requested Aux or RF Channel
Aux or RF Channel	Ch Up/Down, Flashback, and Input Keys	Last Requested Aux or RF Channel

## Reference: TV Aux Input Configuration

DIRECT ACCESS Tuning		TV		ENABLE				MPI DATA			START AUX SOURCE ASSIGN- MENT
				Installer Menu		MPI DATA STATUS TYPE 0x41 SOURCES ENABLED (R/W)		DATA STATUS TYPE 0xD2 CURRENT AV SOURCE (R)		DATA STATUS TYPE 0x0D AUX SOURCE (R)	
OLD_ OCV = 0	OLD_ OCV = 1	Source Input	Source Mode	Number	Labeling	Value	Labeling	Value	Labeling		
130	90	Video2 (Side)	CV	34	CAMPORT_EN	0x01	Video Front (Camport)	0	Video Front (Camport)	0 (VIDEO)	2
131	91	Video1 (Rear)	CV	39	REAR_AUX_EN	0x02	Rear Video (Aux)	1	Rear Video (Aux)	0 (VIDEO)	1
132	92	HDMI2	DTV/PC	91	YPrPb2 EN = 1	0x04	S-Video Rear	2	S-Video Rear	0 (VIDEO)	5
133	93	HDMI1/DVI	DTV/PC	35	COMPPORT_EN = 1	0x08	Front Computer	3	Front Computer	0 (VIDEO)	3
134	94	RGB	PC	87	REAR RGB EN = 2	0x10	SVGA Rear Computer	4	SVGA Rear Computer	2 (COMPUTER)	4
136	96	Component		38	YPrPb EN	0x40	Y/UV Component	6	Rear Y/PrPb Component Video	0 (VIDEO)	6

## Reference: Resetting a TV to Pass-through Mode

---

This section describes how you can reset a TV that is currently in FTG Mode to Pass-through Mode. Note that the reset to Pass-through Mode will also restore all factory default settings on the TV.

There are three options for resetting Pass-through Mode on TVs that are in FTG Mode. The first and second options enable you to reset a single TV to Pass-through Mode, while the third option enables you to reset multiple TVs to Pass-through Mode at one time.

- A predefined value for Installer Menu item 117 FACT DEFAULT enables access to initiate a factory “IN-STOP” process that will reset the TV to Pass-through Mode. Contact technical support for the required value for Installer Menu item 117 and for additional information on performing the IN-STOP from the Installer Menu.
- Using a USB memory device, “Teach” an FMA Configuration file that only contains a “0 Mapped Channels” FTG Channel Map to the TV. Refer to “Creating an FMA Configuration File using the FTG Configuration Application” and “Teaching FMA Configuration to a TV” on pages 30 and 31, respectively, for further information.
- If your system uses a Pro:Centric server for configuration, use the Pro:Centric Admin Client to load an FMA Configuration file that only contains a “0 Mapped Channels” FTG Channel Map on the Pro:Centric server. Refer to the **Pro:Centric™ Server Admin Client User Guide** for further information.

# Troubleshooting

## General Troubleshooting

### Some Quick and Easy Tips for Resolving Problems

Symptom	Possible Cause(s)	Possible Solution(s)
<b>Installation</b>		
Cannot direct enter channel number.	(TV in Stand-alone Mode) Installer Menu item 028 CH. OVERRIDE is set to 0, i.e., disabled (recommended setting).	If Installer Menu item 028 CH. OVERRIDE is set to 0, only channels that are active in the TV's channel lineup can be selected. Set CH. OVERRIDE to 1 to allow access for direct keypad entry to all channels.
	(TV in FTG Mode) The channel entered is not part of the FTG Channel Map.	Channel access is restricted to channels included in the FTG Channel Map. If necessary, make changes to the FTG Channel Map using the FTG Configuration Application.

### Power

No power.	See troubleshooting flow chart on following page.
-----------	---

### Display Panel Picture

No picture.	Display panel is turned off.	<ul style="list-style-type: none"> <li>• Turn TV ON.</li> <li>• Power failure?</li> </ul>
	Antenna/cable not connected.	Connect antenna/cable signal to TV
	Connections incorrect.	Check connections on TV
	MPI not connected.	If applicable, connect MPI cable to MPI device.
	Encrypted program.	Try another channel.
	Wrong tuning band.	Adjust Installer Menu settings.

### Erratic Operation

Installer Menu setup.	Wrong Installer Menu settings.	Adjust Installer Menu settings as required.
-----------------------	--------------------------------	---

### Installer Remote

Remote doesn't work.	Remote not in TV Mode.	Use MODE key to select "TV"; puts remote into TV Mode.
	Not aimed at IR remote sensor.	Point remote at IR receiver on TV.
	Remote too far from IR sensor.	Move remote closer to IR receiver on TV or darken room.
	MPI not connected.	If applicable, connect MPI cable to MPI device.
	IR path to TV's receiver obstructed.	Remove obstructions.
	Weak batteries.	Replace batteries.
	Wrong battery polarity.	Check that "+" and "-" match in battery compartment.
	Too much light in room.	Dim room light.
Wrong Installer Remote.	Requires compatible Installer Remote. Contact your LG dealer.	

### Picture Reception

Normal picture, poor or no sound.	Audio muted.	Press MUTE or use Volume Up key to increase sound level.
	Broadcast problem.	Try a different channel.

**Note:** For other problems not caused by the TV, refer to the other devices' operating guide(s).

# Troubleshooting (Cont.)

## Troubleshooting Flow Chart

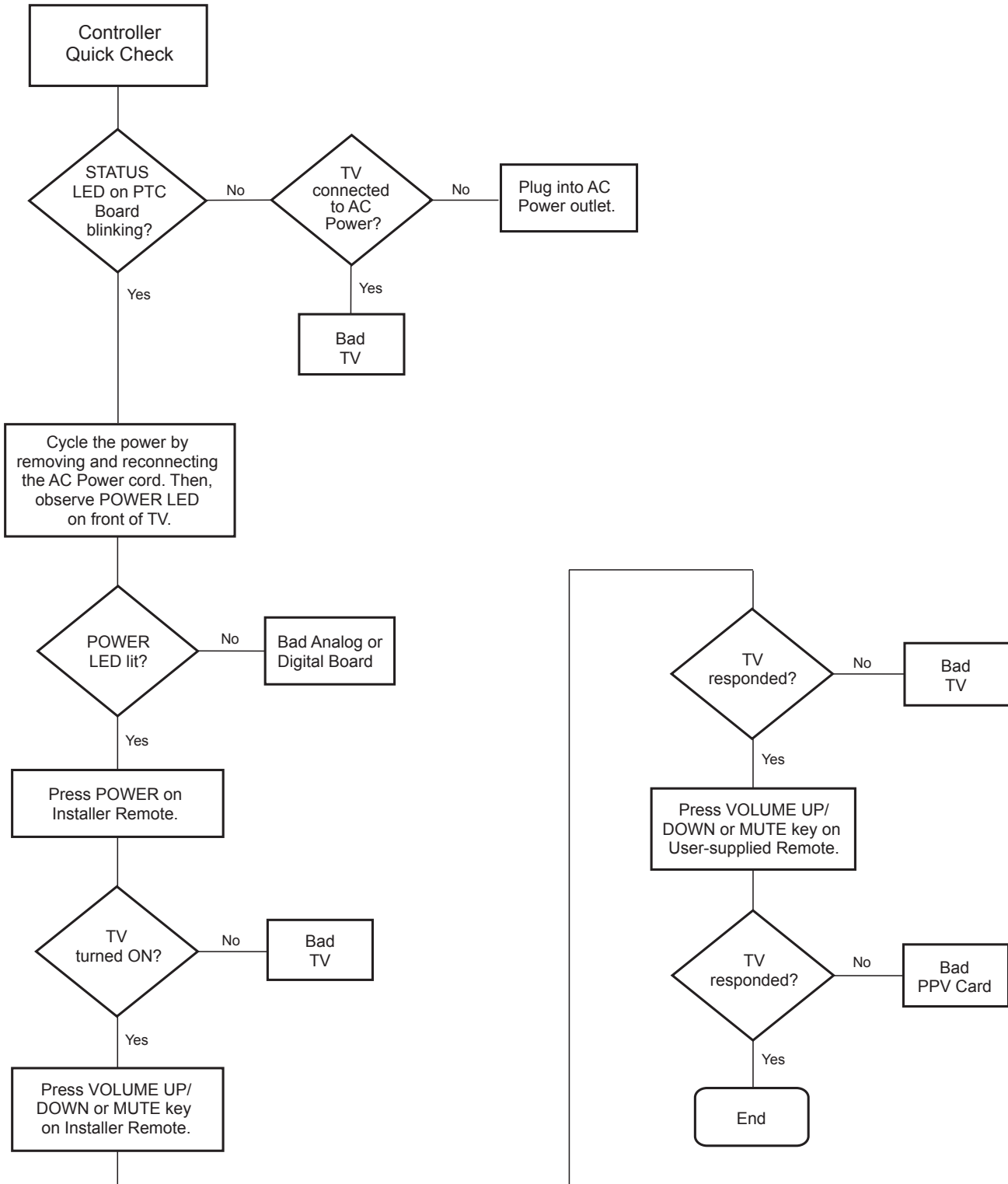



# Troubleshooting (Cont.)

## Commercial Mode Check / FTG Operation Troubleshooting

---

### Commercial Mode Check

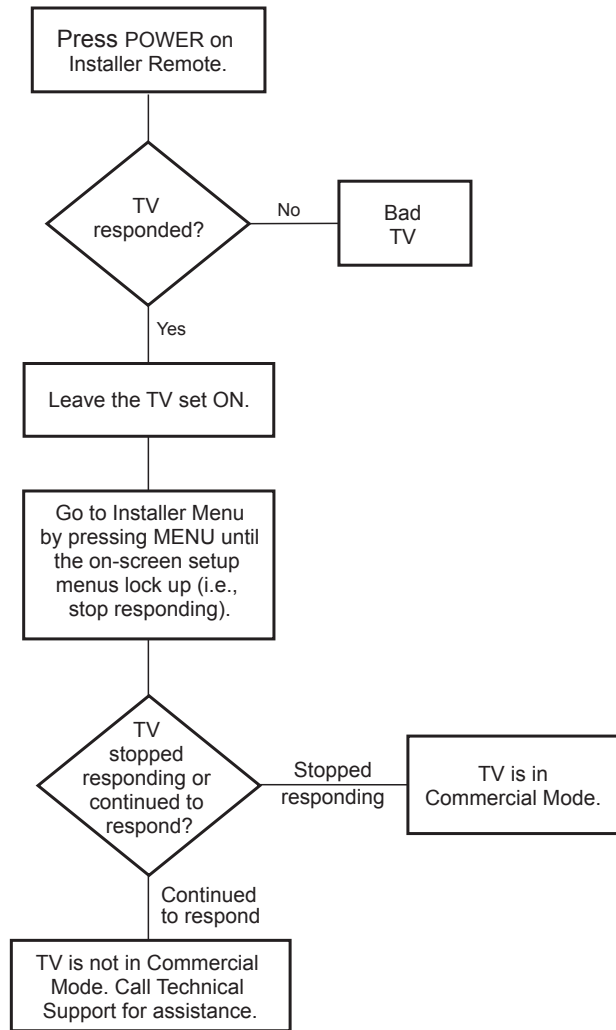

### FTG Operation Troubleshooting

The following table provides troubleshooting information for when the TV is configured in the FTG Mode of operation.

Symptom	Possible Cause(s)	Solution(s)
Communication Error ("Communications Timeout")	TV not powered.	Check/connect the TV power cord.
	TV not turned ON.	TV needs to be turned ON (default FTG Mode).

## Clone Programmer Troubleshooting



**Warning:** Do not connect a clone programmer to a PPV card installed in the Master or Target TVs, as this will damage the clone programmer and the PPV card.

### Reset Clone Programmer After Static Shock

After replacing exhausted batteries (LT2002 only), or if the clone programmer behaves strangely after a static shock:

- TLL-1100A: Turn the TLL-1100A OFF and then ON.
- LT2002: Use a paper clip or similar instrument inserted through the small hole marked RESET to activate the internal reset switch and restore normal operation.

After a reset, check the real-time clock setting. It may be necessary to set the clone programmer clock from a TV containing the correct time.

**Note:** Both the Master and Target TVs must be in Pass-through Mode for cloning purposes. See also IMPORTANT CLONING INFORMATION on page 23.

### Clone Programmer

Symptom	Possible Cause(s)	Possible Solution(s)
Clone copies setup in less than 30 seconds.	Not enough time to copy entire TV setup.	TLL-1100A: Turn the TLL-1100A OFF and then ON. LT2002: Press RESET on clone programmer. Then redo Learn/Teach. (Learning usually takes about 90 seconds; Teaching usually takes 3 to 4 minutes.)
Remote does not operate clone programmer.	Wrong Installer Remote.	Only use an LG Installer Remote to operate clone programmer with TV.
Clone menu does not display on TV screen, TLL-1100A shows error message, or LT2002 LED does not blink.	MPI cord not connected.	Connect MPI cord properly, and ensure good connection.
	TV not turned ON.	TV must be powered ON for clone programmer to work.
	(LT2002 only) Weak batteries.	Install four (4) fresh AA high-quality alkaline batteries.
	(TLL-1100A only) No charge.	Ensure the TLL-1100A is fully charged or connected to AC power.
Clone menu hard to read.	Weak signal.	Connect TV to a reliable analog channel signal source.
No time set.	Time not available.	Set time on a TV, and copy time to clone programmer.
Clone not working.	Clone programmer problem.	<ul style="list-style-type: none"> <li>• Try a different clone programmer.</li> <li>• Reset the clone programmer.</li> </ul>
Clone scans channels more than once.	Clone should only scan channels once.	Ensure TV is set up correctly, and try cloning again.

### Master and Target TVs

Symptom	Possible Cause(s)	Possible Solution(s)
Cloning did not work.	Procedure interrupted.	Wait until procedure complete message is displayed.
	Different TV models.	Cloning is only possible with identical model TVs.
	Step(s) omitted or not performed.	Refer to the applicable cloning procedure(s), and make sure all tasks were performed.
(LT2002 only) Clone time disappeared.	Batteries were removed.	Batteries must remain installed to retain time settings.
New setup not present.	Target TV not reset.	Disconnect Target TV from AC power for 15 seconds.

- After cloning operations are complete, unplug the TLL-1100A/LT2002 from the TV.
- If the TV does not display a picture (blank screen) after a few seconds, just change channels.

# Glossary of Terms

---

A list of definitions for some of the words found in this guide.

## **75 OHM RF CABLE**

The wire that comes from an off-air antenna or cable service provider. The end looks like a hex-shaped nut with a wire through the middle. It screws onto the Antenna/Cable threaded jack on the back of the TV.

## **300 TO 75 OHM ADAPTER**

A small device that connects a 2-wire 300 ohm antenna to a 75 ohm RF jack. It is usually about an inch long with two screws on one end and a round opening with a wire extending out the other end.

## **A/V CABLES**

Audio/Video cables. Three cables bunched together—right audio (red), left audio (white), and video (yellow). A/V cables are used for stereo playback of videocassettes and for higher quality picture and sound from other A/V devices.

## **A/V DEVICE**

Any device that produces video or sound (VCR, DVD, cable box, or television).

## **AMPLIFIER**

An electronic device that amplifies sound from a television, CD player, VCR, DVD player, or other Audio/Video device.

## **ANTENNA**

The physical receiver of television signals sent over the air. A large metal piece of equipment does not always have to be visible to be using an antenna.

## **CABLE**

Cable service box. Refers to the descrambler box cable subscribers use to receive cable programming signals.

## **CATV**

Programming provided by a cable service.

## **COMPONENT VIDEO**

Uses three wires for transporting three-color video signals. The end result is usually better video quality.

## **COMPOSITE VIDEO**

Typical video jack, uses one wire for transporting three-color video signals.

## **DELETE**

Lets you remove channels from the list that the end user can scroll through using Channel Up/Down.

## **DIGITAL TELEVISION**

High-resolution, cinema-quality television signals transmitted digitally.

## **DVI**

Digital Video Interface. Accommodates analog and digital interfaces with a single connector.

## **HDMI**

High-definition multi-media interface.

## **HDSTB**

High-definition set top box. Refers to a tuner device that receives high-definition television signals which have higher resolution than ordinary analog TV signals.

## **HDTV**

High-definition television. Refers to television signals that have higher resolution than ordinary analog TV signals.

## **INPUT**

Refers to the input jack that receives a signal from a TV, VCR, DVD Player, or other Audio/Video device.

## **JACK**

An input or output connector on the back of a TV, VCR, DVD Player, or other Audio/Video device.

## **MONO SOUND**

Mono (monaural) sound is one channel of sound. On more than one speaker, all the speakers play the same audio.

## **OUTPUT**

Refers to the output jack that sends a signal out of a VCR, DVD, or other A/V device.

## **PHYSICAL CHANNEL NUMBER**

The actual channel number. Analog channels use the Physical Channel number and digital channels can use a Virtual Channel number.

## **RGB (RED, GREEN, BLUE)**

Connection input or output port available for producing a video image using three separate colors: Red, Green, and Blue.

## **RS-232**

Serial communication port through which firmware is downloaded.

## **2ND AUDIO PROGRAMMING/SAP**

Second Audio Programming (SAP) is another, separate audio channel available with some programming. Choosing SAP often refers to listening to audio in another language, such as Spanish or French.

## **SIGNAL**

Picture and sound traveling through a cable, or over the air, to the TV.

## **STEREO SOUND**

Stereo (Stereophonic) sound refers to audio that's divided into right and left sides.

## **TUNER**

Device that picks up the broadcast signal and turns it into picture and sound.

## **VIRTUAL CHANNEL NUMBER**

A re-mapped channel number. Analog channels use the Physical Channel number; however digital channels use a Virtual (or false) Channel number.

## **XDS**

Extended Data Service. Additional program information included on the signal provided at the discretion of the broadcaster.

---

Note: Refer to [www.atsc.org](http://www.atsc.org) for further information.

## Document Revision History

Date	Description
May 2011	Revision A: New document

Product documentation is available online at: [www.LGolutions.com/products](http://www.LGolutions.com/products). From the Products page, select **TVs, Systems & Solutions**, then **LCD TVs**, then the applicable TV. Click the **Literature & Downloads** tab at the bottom of the TV page, and select the required document(s) from the Downloads list.

---

## Notes



---

For Customer Support/Service, please call:

**1-888-865-3026**

[www.LGsolutions.com](http://www.LGsolutions.com)

Pro:Idiom is a registered trademark of Zenith Electronics LLC. Pro:Centric is a trademark of LG Electronics U.S.A., Inc. All other trademarks or registered trademarks are the property of their respective owners.