



ENGLISH

Việt

中文

OWNER'S MANUAL DVD Home Theater System

Please read this manual carefully before operating your set and retain it for future reference.

HT356SD (HT356SD, SH36SD-S/W)

P/NO : MFL66983873

Safety Information

1

Getting Started



CAUTION: TO REDUCE THE RISK OF ELECTRIC SHOCK DO NOT REMOVE COVER (OR BACK) NO USER-SERVICEABLE PARTS INSIDE REFER SERVICING TO QUALIFIED SERVICE PERSONNEL.

This lightning flash with arrowhead symbol within an equilateral triangle is intended to alert the user to the presence of uninsulated dangerous voltage within the product's enclosure that may be of sufficient magnitude to constitute a risk of electric shock to persons.



The exclamation point within an equilateral triangle is intended to alert the user to the presence of important operating and maintenance (servicing) instructions in the literature accompanying the product.



WARNING: TO PREVENT FIRE OR ELECTRIC SHOCK HAZARD, DO NOT EXPOSE THIS PRODUCT TO RAIN OR MOISTURE.

WARNING: Do not install this equipment in a confined space such as a book case or similar unit.

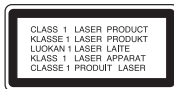

CAUTION: This product employs a Laser System. To ensure proper use of this product, please read this owner's manual carefully and retain it for future reference. Shall the unit require maintenance, contact an authorized service center.

Use of controls, adjustments or the performance of procedures other than those specified herein may result in hazardous radiation exposure.

To prevent direct exposure to laser beam, do not try to open the enclosure. Visible laser radiation when open. DO NOT STARE INTO BEAM.

CAUTION concerning the Power Cord

Most appliances recommend they be placed upon a dedicated circuit;

That is, a single outlet circuit which powers only that appliance and has no additional outlets or branch circuits. Check the specification page of this owner's manual to be certain. Do not overload wall outlets. Overloaded wall outlets, loose or damaged wall outlets, extension cords, frayed power cords, or damaged or cracked wire insulation are dangerous. Any of these conditions could result in electric shock or fire. Periodically examine the cord of your appliance, and if its appearance indicates damage or deterioration, unplug it, discontinue use of the appliance, and have the cord replaced with an exact replacement part by an authorized service center. Protect the power cord from physical or mechanical abuse, such as being twisted, kinked, pinched, closed in a door, or walked upon. Pay particular attention to plugs, wall outlets, and the point where the cord exits the appliance. To disconnect power from the mains, pull out the mains cord plug. When installing the product, ensure that the plug is easily accessible.

This device is equipped with a portable battery or accumulator.

Safe way to remove the battery or the battery

from the equipment: Remove the old battery pack, follow the steps in reverse order than the assembly. To prevent contamination of the environment and bring on possible threat to human and animal health, the old battery or the battery put in the appropriate container at designated collection points. Do not dispose of batteries or battery together with other waste. It is recommended that you use local, free reimbursement system batteries and accumulators.

The battery shall not be exposed to excessive heat such as sunshine, fire or the like.

CAUTION: The apparatus shall not be exposed to water (dripping or splashing) and no objects filled with liquids, such as vases, shall be placed on the apparatus.

Copyrights

It is forbidden by law to copy, broadcast, show, broadcast via cable, play in public, or rent copyrighted material without permission. This product features the copy protection function developed by Macrovision. Copy protection signals are recorded on some discs. When recording and playing the pictures of these discs picture noise will appear. This product incorporates copyright protection technology that is protected by U.S. patents and other intellectual property rights. Use of this copyright protection technology must be authorized by Macrovision, and is intended for home and other limited viewing uses only unless otherwise authorized by Macrovision. Reverse engineering or disassembly is prohibited.

CONSUMERS SHOULD NOTE THAT NOT ALL HIGH DEFINITION TELEVISION SETS ARE FULLY COMPATIBLE WITH THIS PRODUCT AND MAY CAUSE ARTIFACTS TO BE DISPLAYED IN THE PICTURE. IN CASE OF 525 OR 625 PROGRESSIVE SCAN PICTURE PROBLEMS, IT IS RECOMMENDED THAT THE USER SWITCH THE CONNECTION TO THE 'STANDARD DEFINITION' OUTPUT. IF THERE ARE QUESTIONS REGARDING OUR TV SET COMPATIBILITY WITH THIS MODEL 525p AND 625p UNIT, PLEASE CONTACT OUR CUSTOMER SERVICE CENTRE.

You have to set the disc format option to [Mastered] in order to make the discs compatible with the LG players when formatting rewritable discs. When setting the option to Live File System, you cannot use it on LG players.

(Mastered/ Live File System : Disc format system for Windows Vista)

Table of Contents

1 Getting Started

- 2 Safety Information
- 6 Unique Features
 - 6 - Portable In
 - 6 - USB Direct Recording
- 6 Accessories
- 7 Introduction
 - 7 - Playable Discs
 - 7 - About the  Symbol Display
 - 7 - Symbol Used in this Manual
 - 7 - Regional Codes
 - 8 - Playable file Requirement
- 10 Front panel
- 10 Rear panel
- 11 Remote control

2 Connecting

- 12 Connecting the speakers
 - 12 - Attaching the speakers to the unit
 - 12 - Positioning the System
- 13 Connections to Your TV
 - 13 - Component Video Connection
 - 14 - Video Connection
- 14 Optional Equipment Connection
 - 14 - AUX IN Connection
 - 14 - AUDIO IN (P. IN) Connection
 - 15 - USB Connection
 - 15 - Antenna Connection

3 System Setting

- 16 Adjust the Setup settings
 - 16 - OSD Initial language settings - Optional
 - 16 - To display and exit the Setup Menu
 - 16 - LANGUAGE
 - 17 - DISPLAY
 - 17 - AUDIO
 - 18 - LOCK (Parental Control)
 - 19 - OTHERS

4 Operating

- 20 Basic Operations
- 21 Other Operations
 - 21 - Displaying Disc Information on-screen
 - 21 - To display the DVD Menu
 - 21 - To display the DVD Title
 - 21 - Selecting a subtitle language
 - 21 - 1.5 times speed playback
 - 22 - Starting play from selected time
 - 22 - Last Scene Memory
 - 22 - Changing the character set to display DivX® subtitle correctly
 - 22 - Programmed Playback
- 23 Viewing a PHOTO file
 - 23 - Viewing photo files as a slide show
 - 23 - Listening to music during slide show
 - 23 - Sleep Timer Setting
 - 23 - Dimmer
 - 23 - Turn off the sound temporarily
- 24 Screen Saver
 - 24 - System Select - Optional
 - 24 - Displaying file information (ID3 TAG)
- 24 Radio Operations
 - 24 - Listening to the Radio
 - 24 - Presetting the Radio Stations
 - 24 - Deleting all the saved stations
 - 24 - Improving poor FM reception
- 25 Sound adjustment
 - 25 - Setting the surround mode
- 26 Advanced Operations
 - 26 - Listening to music from your portable player or external device
 - 26 - Recording to USB

5 Troubleshooting

27 Troubleshooting

6 Appendix

- 28 Maintenance
- 28 - Handling the Unit
- 28 - Notes on Discs
- 29 Area Code List
- 30 Language Code List
- 31 Trademarks and Licenses
- 32 Specifications

1

2

3

4

5

6

Unique Features

1

Getting Started

Portable In

Listens to music from your portable device.
(MP3, Notebook, etc)

USB Direct Recording

Records music from CD to your USB device.

Accessories

Please check and identify the supplied accessories.

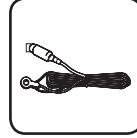

FM Antenna (1)



Remote Control (1)/
Battery (1)



Video Cable (1)

Introduction

Playable Discs

This unit plays DVD±R/RW and CD-R/RW that contains audio titles, DivX, MP3, WMA and/or JPEG files. Some DVD±RW/DVD±R or CD-RW/CD-R cannot be played on this unit due to the recording quality or physical condition of the disc, or the characteristics of the recording device and authoring software.



DVD-VIDEO (8 cm / 12 cm disc)

Discs such as movies that can be purchased or rented.



DVD±R (8 cm / 12 cm disc)

Video mode and finalized only.



DVD-RW (8 cm / 12 cm disc)

Video mode and finalized only.

DVD VR format that have been finalized can not be played in this unit.



DVD+R: Video mode only.

Supports the double layer disc also.



DVD+RW (8 cm / 12 cm disc)

Video mode and finalized only.



Audio CD: Music CDs or CD-R/CD-RW in music CD format that can be purchased.

About the Symbol Display

" " may appear on your TV display during operation and indicates that the function explained in this owner's manual is not available on that disc.

Symbol Used in this Manual



DVD-Video, DVD±R/RW in Video mode or VR mode and finalized



Audio CDs



Video files contained in the USB/Disc



Audio files contained in the USB/Disc



Photo files



Note

Indicates special notes and operating features.



Caution

Indicates cautions for preventing possible damages from abuse.

Regional Codes

This unit has a regional code printed on the rear of the unit. This unit can play only DVD discs labeled same as the rear of the unit or "ALL".

- Most DVD discs have a globe with one or more numbers in it clearly visible on the cover. This number must match your unit's regional code; or the disc cannot play.
- If you try to play a DVD with a different regional code from your unit, the message "Check Regional Code" appears on the TV screen.

Playable file Requirement

MP3/ WMA music file requirement

MP3/ WMA file compatibility with this unit is limited as follows :

- Sampling frequency : within 32 kHz to 48 kHz (MP3), within 32 kHz to 48 kHz (WMA)
- Bit rate : within 32 kbps to 320 kbps (MP3), 40 kbps to 192 kbps (WMA)
- Support Version : v2, v7, v8, v9
- Maximum files : Under 650
- File extensions : “.mp3”/ “.wma”
- CD-ROM file format : ISO9660/ JOLIET
- We recommend that you use Easy-CD Creator, which creates an ISO9660 file system.

Photo file requirement

JPEG disc compatibility with this unit is limited as follows :

- Max pixel in width : 2 760 x 2 048 pixel
- Maximum files : Under 650
- Some discs may not operate due to a different recording format or the condition of disc.
- File extensions: “.jpg”
- CD-ROM file format : ISO9660/ JOLIET

Compatible USB Devices

- MP3 Player : Flash type MP3 player.
- USB Flash Drive : Devices that support USB2.0 or USB1.1.
- The USB function of this unit does not support some USB devices.

USB device requirement

- Devices which require additional program installation connected to a computer, are not supported.
- Do not extract the USB device while in operation.
- For a large capacity USB, it may take longer than a few minute to be searched.
- To prevent data loss, back up all data.
- If you use a USB extension cable or USB hub, the USB device is not recognized.
- Using NTFS file system is not supported. (Only FAT(16/32) file system is supported.)
- This unit is not supported when the total number of files is 1 000 or more.
- External HDD, Card readers, Locked devices, or hard type USB devices are not supported.
- USB port of the unit cannot be connected to PC. The unit can not be used as a storage device.

DivX file requirement

DivX file compatibility with this unit is limited as follows :

- Available resolution:
within 720 x 576 (W x H) pixels.
- The file name of the DivX subtitle should be entered within 45 characters.
- If there is impossible code to express in the DivX file, it may be displayed as " _ " mark on the display.
- Frame rate : less than 30 fps.
- If the video and audio structure of recorded files is not interleaved, either video or audio is outputted.
- Playable DivX file : ".avi", ".mpg", ".mpeg", ".divx"
- Playable Subtitle format : SubRip (*.srt/ *.txt), SAMI (*.smi), SubStation Alpha (*.ssa/ *.txt), MicroDVD (*.sub/ *.txt), SubViewer 2.0 (*.sub/ *.txt), Vobsub (*.sub)
- Playable Codec format : "DIVX3.xx", "DIVX4.xx", "DIVX5.xx", "MP4V3", "3IVX".
- Playable Audio format : "AC3", "PCM", "MP3", "WMA".
- Sampling frequency : within 32 to 48 kHz (MP3), within 32 to 48 kHz (WMA)
- Bit rate : within 32 kbps to 320 kbps (MP3), 40 kbps to 192 kbps (WMA)
- For Discs formatted in Live file system, you can not it on this unit.
- If the name of movie file is different from that of the subtitle file, during playback of a DivX file, subtitle may not be display.
- If you play a DivX file different from the DivXspec, it may not operate normally.

Front panel

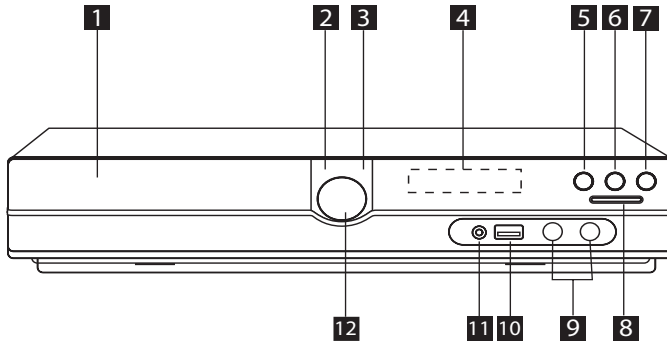

- 1** DVD/CD Disc Drawer
- 2** Power (⏻/⏻)
- 3** Open/Close (▲)
- 4** Display window
- 5** Play/Pause (▶/⏸), MONO/ST.
- 6** Stop (■)
- 7** Function (F)
Selects the function or input source.
- 8** TUNING (-/+ (◀◀/▶▶)), Skip/Search
You can search chapter/ track/ file by pressing and holding ◀◀/▶▶.
- 9** MIC 1/2
- 10** USB port
You can play video, image and sound files by connecting the USB device.
- 11** P.(Portable) IN port
You can enjoy music from portable device on your unit.
- 12** Volume (VOL.)

Rear panel

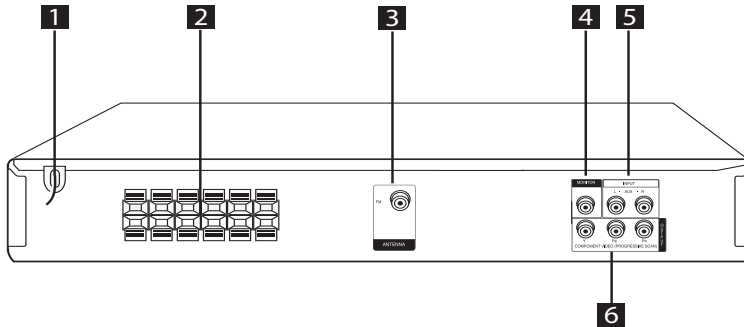

- 1** Power cord
- 2** Speaker terminal
- 3** ANTENNA connector (FM)
- 4** MONITOR (VIDEO OUT) connector
Connect to a TV with video inputs.
- 5** AUX (L/ R) INPUT connector
- 6** COMPONENT VIDEO (PROGRESSIVE SCAN) OUTPUT (Y Pb Pr)
Connect to a TV with Y Pb Pr inputs.

Remote control

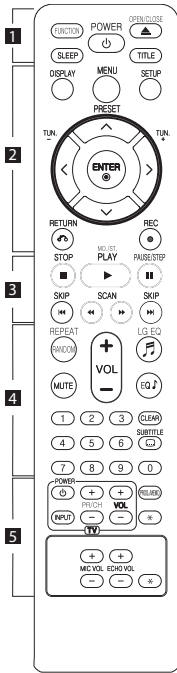

Battery Installation



Remove the battery cover on the rear of the Remote Control, and insert one (size AAA) battery with **+** and **-** matched correctly.

..... **1**

FUNCTION : Selects the function and input source.

SLEEP : Sets the system to turn off automatically at a specified time. (Dimmer : The display window will be darkened by half.)

POWER : Switches the unit ON or OFF.

OPEN/CLOSE : Opens and closes the disc Drawer.

TITLE : If the current DVD title has a menu, the title menu appears on the screen. Otherwise, the disc menu may not appear.

..... **2**

DISPLAY : Accesses On-Screen Display.

MENU : Accesses the menu on a DVD disc.

SETUP : Accesses or removes setup menu.

PRESET ($\wedge \vee$) : Selects programme of Radio.

TUN. (-/+) : Tunes in the desired radio station.

$\wedge / \vee / < / >$ (up/ down/ left/ right): Used to navigate on-screen displays.

ENTER (\odot) : Acknowledges menu selection.

RETURN (\curvearrowright) : Moves backwards in the menu or exits the setup menu.

REC (\bullet) : USB Direct Recording.

..... **3**

STOP (\blacksquare) : Stops playback or recording.

PLAY (\blacktriangleright), **MO./ST.** : Starts playback. Selects Mono/ Stereo.

PAUSE/STEP (\parallel) : Pauses playback.

SKIP (\lll / \ggg) : Goes to next or previous chapter/ track/ file.

SCAN (\lll / \ggg) : Searches backward or forward.

..... **4**

REPEAT/RANDOM : Selects a play mode.(Random, repeat)

MUTE : Mutes the sound.

VOL (Volume) (+/-) : Adjusts speaker volume.

LG EQ (musical note) : Selects a Natural or Local Specialization equalizer effect by using LG EQ.

EQ 2 (EQUALIZER effect) : Chooses sound impressions.

CLEAR : Removes a track number on the Program List.

SUBTITLE : During playback, press **SUBTITLE** repeatedly to select a desired subtitle language.

0 to 9 numerical buttons : Selects numbered options in a menu.

..... **5**

TV Control buttons : Controls the TV. (LG TV only)

- You can control the sound level, input source, and power switching of LG TVs as well. Hold **POWER** (TV) and press **PR/CH (+/-)** button repeatedly until the TV turns on or off.

PROG./MEMO. : Accesses or removes Program menu.

MIC VOL(+/-) : Adjusts microphone volume.

ECHO VOL(+/-) : Adjusts echo volume.

★: This button is not available.

Connecting the speakers

Attaching the speakers to the unit

To connect the cable to the unit, press each plastic finger pad to open the connection terminals on the unit. Insert the wire and release the finger pad.

Connect the black stripe of each wire to the terminals marked - (minus) and the other end to the terminals marked + (plus).

Speaker connection

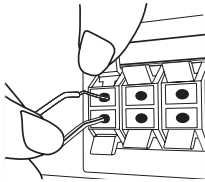

Caution

- Be careful to make sure children not to put their hands or any objects into the *speaker duct.
*Speaker duct: A hole for plentiful bass sound on speaker cabinet (enclosure).
- The speakers contain magnet parts, so color irregularity may occur on the TV screen or PC monitor screen. Please use the speakers far away from either TV screen or PC monitor.

Positioning the System

The following illustration shows an example of positioning the system.

Note that the illustrations in these instructions differ from the actual unit for explanation purposes.

For the best possible surround sound, all the speakers other than the subwoofer should be placed at the same distance from the listening position (A).

Speaker Positioning

- (A) Front left speaker (L)/ (B) Front right speaker (R): Place the front speakers to the sides of the monitor or screen and as flush with the screen surface as possible.
- (C) Center speaker: Place the center speaker above or below the monitor or screen.
- (D) Surround left speaker (L)/ (E) Surround right speaker (R): Place these speakers behind your listening position, facing slightly inwards.
- (F) Subwoofer: The position of the subwoofer is not so critical, because low bass sounds are not highly directional. But it is better to place the subwoofer near the front speakers. Turn it slightly toward the center of the room to reduce the wall reflections.

(G) Unit

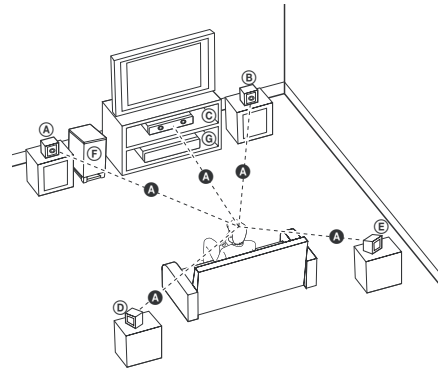

Connections to Your TV

Make one of the following connections, depending on the capabilities of your existing equipment.

! Note

- Depending on your TV and other equipment you wish to connect, there are various ways you could connect the player. Use only one of the connections described in this manual.
- Please refer to the manuals of your TV, Stereo System or other devices as necessary to make the best connections.

! Caution

- Make sure the unit is connected directly to the TV. Tune the TV to the correct video input channel
- Do not connect your player via your VCR. The image could be distorted by the copy protection system.

Component Video Connection

Connect the COMPONENT VIDEO (PROGRESSIVE SCAN) OUTPUT jacks on the unit to the corresponding input jacks on the TV using Y Pb Pr cables.

You can hear the sound through the system's speakers.

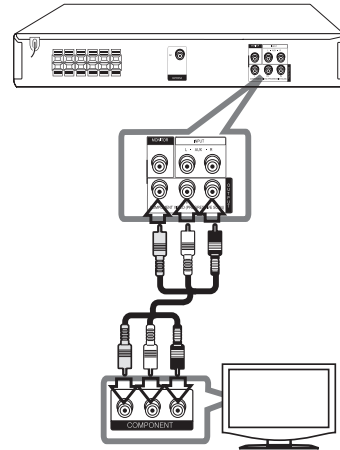

! Note

If your TV accepts progressive format signals, you must use this connection and set [Progressive Scan] in [Display] setup to [On] (See page 17).

Video Connection

Connect the MONITOR jack on the unit to the video in jack on the TV using a video cable.

You can hear the sound through the system's speakers.

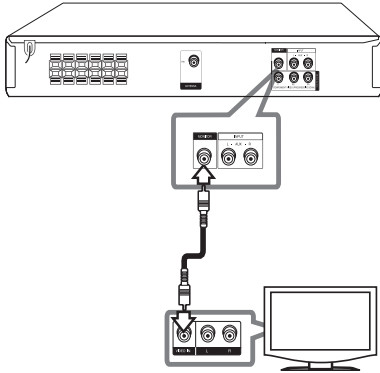

Optional Equipment Connection

AUX IN Connection

Connect an Output of auxiliary device to the AUX (L/R) INPUT Connector.

If your TV has only one output for audio (mono), connect it to the left (white) audio jack on the unit.

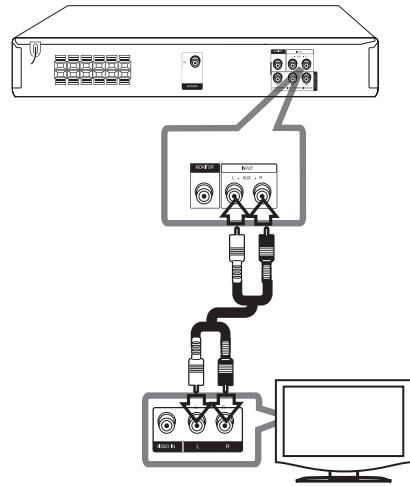

AUDIO IN (P. IN) Connection

Connect an OUTPUT of portable device (MP3 or PMP etc) to the P. IN connector.

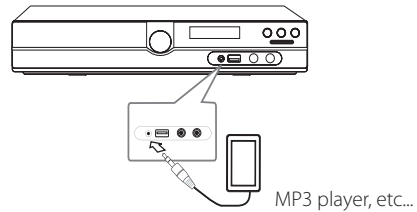

2
Connecting

USB Connection

Connect the USB port of USB Memory (or MP3 player, etc.) to the USB port on the front of the unit.

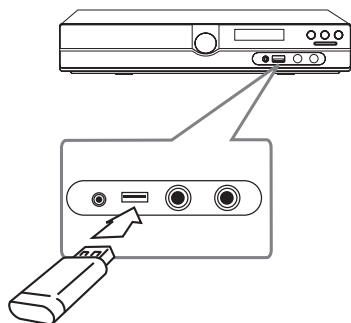

Removing the USB Device from the unit

1. Choose a different function mode or press **STOP** (■) twice in a row.
2. Remove the USB device from the unit.

Antenna Connection

Connect the supplied FM antenna for listening to the radio.

Connect the FM Wire antenna to the FM antenna connector.

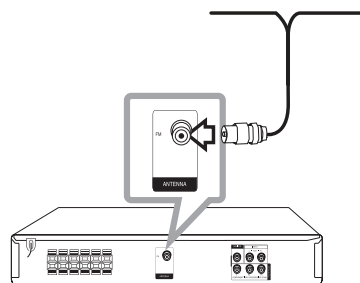

! Note

Be sure to fully extend the FM wire antenna. After connecting the FM wire antenna, keep it as horizontal as possible.

Adjust the Setup settings

By using the Setup menu, you can make various adjustments to items such as picture and sound.

You can also set a language for the subtitles and the Setup menu, among other things. For details on each Setup menu item, see pages 16 to 19.

OSD Initial language settings - Optional

During the first use of this unit, the initial language setup menu appears on your TV screen. You must complete initial language selection before using the unit. English will be selected as the initial language.

1. Press **POWER** to turn the unit on. The language setup menu will appear on the screen.

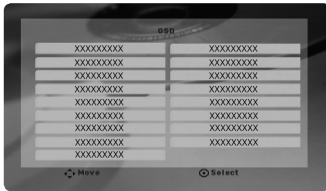

2. Use **^ V <>** to select a language then press **ENTER**.
The confirm menu will appear.



3. Use **<>** to select the [Enter] then press **ENTER** to finish the language setup.

To display and exit the Setup Menu

1. Select the DVD/CD or USB function by pressing **FUNCTION**.
2. Press **SETUP**.
Displays the [Setup] Menu.
3. Press **SETUP** or **RETURN** to exit in the [Setup] Menu.

About help menu for Setup

| Menu | Buttons | Operation |
|-------------------|---------------|---|
| ▲ / ▼ Move | ^ V | Moving to another menu. |
| ◀ Prev. | < | Moving to previous level. |
| ▶ Select | > | Moving to next level or selecting menu. |
| ↶ | RETURN | To exit the [Setup] menu or [5.1 Speaker Setup]. |
| ⊙ | ENTER | To confirm menu. |

LANGUAGE

Menu Language

Select a language for the Setup menu and then on screen display.

Disc Audio / Disc Subtitle / Disc Menu

Select the language you prefer for the audio track (disc audio), subtitles, and the disc menu.

[Original]

Refers to the original language in which the disc was recorded.

[Other]

To select another language, press numeric buttons and then **ENTER** to enter the corresponding 4-digit number according to the language code list on the page 30. If you enter the wrong language code, press **CLEAR**.

[Off (for Disc Subtitle)]

Turn off Subtitle.

DISPLAY

TV Aspect

Select which screen aspect to use based on the shape of your TV screen.

[4:3]

Select when a standard 4:3 TV is connected.

[16:9]

Select when a 16:9 wide TV is connected.

Display Mode

The Display Mode setting works only when the TV Aspect mode is set to 4:3.

[Letterbox]

Displays a wide picture with bands on the upper and lower portions of the screen.

[Panscan]

Automatically displays the wide picture on the entire screen and cuts off the portions that do not fit. (If the disc/file is not compatible with Pan Scan, the picture is displayed at Letterbox ratio.)

Progressive Scan (For Component Video connections)

Selects whether the COMPONENT VIDEO(PROGRESSIVE SCAN) OUTPUT jacks output progressive signal. If your TV accepts progressive format signals, you will enjoy accurate color reproduction and high quality image by selecting [On]. If your TV does not accept progressive format signals, select [Off].

If you set Progressive Scan to [On] in error, you must reset the unit. First, remove the disc in the unit. Next, press and hold **STOP** (■) for five seconds. The video output will be restored to the standard setting, and a picture will be visible on your TV.

AUDIO

DRC (Dynamic Range Control)

Make the sound clear when the volume is turned down (Dolby Digital only). Set to [On] for this effect.

Vocal

Select [On] to mix karaoke channels into normal stereo.

This function is effective for multi-channel karaoke DVDs only.

Semi Karaoke

When a chapter/ title/ track is fully finished, this function shows the score in the screen with a fanfare sound.

[On]

When you finished singing a score will appear on the screen.

[Off]

Fanfare and score do not appears on the screen.

! Note

- DVD, DVD Karaoke discs with more than 2 tracks are available discs for the this function.
- When you watch movies, "off" the Semi Karaoke at the SETUP menu or enjoy it without connecting the MIC if the fanfare or score appears during changing a chapter.

5.1 Speaker Setup

Make the following settings for the built-in 5.1 channel surrounds decoder.

1. Press **SETUP**.
2. Use **▲▼** to select AUDIO menu and then press **>**.
3. Use **▲▼** to select [5.1 Speaker setup] menu and then press **>**.
4. Press **ENTER**
The [5.1 Speaker setup] appears.



5. Use **<>** to select the desired speaker.
6. Adjust options using **▲▼<>** buttons.
7. Press **RETURN** to confirm your selection. Return to the previous menu.

[Speaker]

Select a speaker that you want to adjust.

! Note

Certain speaker settings are prohibited by the Dolby Digital licensing agreement.

[Size]

Since the speaker settings are fixed, you cannot change the settings.

[Volume]

Press **<>** to adjust the output level of the selected speaker.

[Distance]

After you connected speakers to your unit, set the Distance between the speakers and your listening point if the distance of Center or Rear speakers is bigger than the distance of Front speakers. This allows the sound from each speaker to reach the listener at the same time. Press **<>** to adjust the Distance of the selected speaker. This distance is equivalent to a difference of the distance between Center or Rear speaker and Front speakers.

[Test]

Press **<>** to test the signals of each speaker. Adjust the volume to match the volume of test signals memorized in the system.

LOCK (Parental Control)

Initial Setting of the Area Code:

When you use this unit for the first time, you have to set the Area Code.

1. Select the [Lock] menu and then press **>**.
2. Press **>**.
To access the [Lock] options, you must input the password you have created. Input a password and press **ENTER**. Enter it again and press **ENTER** to verify. If you make a mistake before pressing **ENTER**, press **CLEAR**.
3. Select the first character using **▲▼** buttons.
4. Press **ENTER** and select the second character using **▲▼** buttons.
5. Press **ENTER** to confirm your Area code selection.

Rating

Blocks playback of rated DVDs based on their contents. Not all discs are rated.

1. Select [Rating] on the [Lock] menu then press **>**.
2. Input a password and press **ENTER**.
3. Select a rating from 1 to 8 using the **Λ V** buttons.

[Rating 1-8]

Rating one (1) has the most restrictions and rating eight (8) is the least restrictive.

[Unlock]

If you select unlock, parental control is not active and the disc plays in full.

4. Press **ENTER** to confirm your rating selection.

Password

You can enter or change password.

1. Select [Password] on the [Lock] menu and then press **>**.
2. Input a password and press **ENTER**.
To change the password, press **ENTER** when the [Change] option is highlighted. Input a password and press **ENTER**. Enter it again and press **ENTER** to verify.
3. Press **SETUP** to exit the menu.

! Note

If you forget your password, you can clear it using the following steps:

1. Press **SETUP** to display the Setup menu.
2. Input the 6-digit number "210499" and press **ENTER**. The password is cleared.

Area Code

Enter the code of the area whose standards were used to rate the DVD video disc, based on the list on page 29.

1. Select [Area Code] on the [Lock] menu then press **>**.
2. Input a password and press **ENTER**.
3. Select the first character using **Λ V** buttons.
4. Press **ENTER** and select the second character using **Λ V** buttons.
5. Press **ENTER** to confirm your Area code selection.

OTHERS

DivX(R) VOD

ABOUT DIVX VIDEO: DivX® is a digital video format created by DivX, Inc. This is an official DivX Certified® device that plays DivX video. Visit www.divx.com for more information and software tools to convert your files into DivX video.

ABOUT DIVX VIDEO-ON-DEMAND: This DivX Certified® device must be registered in order to play purchased DivX Video-on-Demand (VOD) movies. To obtain your registration code, locate the DivX VOD section in your device setup menu. Go to vod.divx.com for more information on how to complete your registration.

[Register]

Displays the registration code of your unit.

[Deregister]

Deactivate your unit and display the deactivation code.

! Note

All the downloaded videos from DivX VOD can only be played back on this unit.

Basic Operations

1. Insert the disc by pressing **OPEN/CLOSE** or connect the USB device to the USB port.
2. Select the DVD/ CD or USB function by pressing **FUNCTION**.
3. Select a file (or track/ title) you want to play by pressing **^ V < >**.

Note

When playing a disc or USB Flash Drive containing with DivX, MP3/ WMA and JPEG files together, you can select menu of files which you would like to play by pressing **MENU**. If "This file has non-supported type on the unit" pops up, select an appropriate file by pressing **MENU**.



Operating

| To | Do this |
|--|--|
| Stop | Press ■ |
| Playback | Press ▶ |
| Pause | Press |
| Frame-by-Frame playback | Press repeatedly to play title Frame-by-Frame. |
| Skipping to the next/previous chapter/track/file | During playback, press ◀◀ or ▶▶ to go to the next chapter/track or to return to the beginning of the current chapter/track. Press ◀◀ twice briefly to step back to the previous chapter/track. |
| Locating a point quickly by playing a file in fast forward or fast reverse | During playback, press ◀◀ or ▶▶ repeatedly to select the required scan speed. To return to normal speed, press PLAY . |
| Playing repeatedly or randomly | Press REPEAT/RANDOM repeatedly, and the current title, chapter or track will be played back repeatedly or randomly. - Random play mode : only music files. |
| Slowing down the playing speed | In the pause mode, press SCAN (◀◀ or ▶▶) to select the required speed. (The reverse playback is not supported on Divx files.) |

Other Operations

Displaying Disc Information on-screen

You can display various information about the disc loaded on-screen.

1. Press **DISPLAY** to show various playback information.
The displayed items differ depending on the disc type or playing status.
2. You can select an item by pressing **^ V** and change or select the setting by pressing **<>**.
Title – Current title number/ total number of titles.
Chapter – Current chapter number/total number of chapters.
Time – Elapsed playing time.
Audio – Selected audio language or channel.
Subtitle – Selected subtitle.
Angle – Selected angle/total number of angles.
Sound – Selected sound mode.

Note

If any button is not pressed for a few seconds, the onscreen display disappears.

To display the DVD Menu

DVD

When you play a DVD which contains several menus, you can select the menu you want using the menu.

1. Press **MENU**.
The disc's menu appears.
2. Select the menu by using **^ V <>**.
3. Press **PLAY** to confirm.

To display the DVD Title

DVD

When you play a DVD which contains several titles, you can select the title you want using the menu.

1. Press **TITLE**.
The disc's title appears.
2. Select the menu by pressing **^ V <>**.
3. Press **PLAY** to confirm.

Selecting a subtitle language



DVD MOVIE

During playback, press **SUBTITLE**() repeatedly to select a desired subtitle language.

1.5 times speed playback

DVD

The 1.5 speed allows you to watch the pictures and listen to the sound quicker than playing at a normal speed.

1. During playback, press **PLAY**() to play at 1.5 times speed. "▶X1.5" appears on the screen.
2. Press **PLAY**() again to exit.

Starting play from selected time

DVD MOVIE

To start playing at any chosen time on the file or title.

1. Press **DISPLAY** during playback.
2. Press **Λ V** to select the time clock icon and “--:--:--” appears.
3. Input the required start time in hours, minutes, and seconds from left to right. If you enter the wrong numbers, press **CLEAR** to remove the numbers you entered. Then input the correct numbers.
For example, to find a scene at 1 hour, 10 minutes, and 20 seconds, enter “11020” by using numerical buttons.
4. Press **ENTER** to confirm. Playback starts from the selected time.

4

Operating

Last Scene Memory

DVD

This unit memorizes the last scene from the last disc that is viewed. The last scene remains in memory even if you remove the disc from the player or switch off (Stand-by mode) the unit. If you load a disc that has the scene memorized, the scene is automatically recalled.

Changing the character set to display DivX® subtitle correctly

MOVIE

If the subtitle does not display properly during playback press and hold **SUBTITLE** for about 3 seconds then press **<>** or **SUBTITLE** to select another language code until the subtitle is displayed properly and then press **ENTER**.

Programmed Playback

ACD MUSIC

The program function enables you to store your favourite files from any disc or USB device.

A program can contain 30 tracks/ files.

1. Select the DVD/CD or USB function by pressing **FUNCTION**.
2. To add a music(s) on the program list, press **PROG./MEMO.** to enter the program edit mode (**E** mark appears on the menu).
3. Select a desired music on the [List] by using the **Λ V** then press **ENTER** to add the music to the program list.
4. Select music from the program list then press **ENTER** to start programmed playback.
5. Press **PROG./MEMO.** to exit the program edit mode (**E** mark disappears on the menu).

Erasing a file from Program List

1. Press **PROG./MEMO.** to enter the program edit mode (**E** mark appears on the menu).
2. Use **Λ V** to select the track that you wish to erase from the Program list.
3. Press **CLEAR**.

Erasing the Complete Program List

Use **Λ V <>** to select [Clear All] then press **ENTER**.

Note

The programs are also cleared when the disc or USB device is removed, the unit is switched to power off or the function is switched to others.

Viewing a PHOTO file



PHOTO

This unit can play discs with photo files.





1. Select the DVD/CD or USB function by pressing **FUNCTION**.
2. Press **^ V** to select a folder, and then press **ENTER**.
A list of files in the folder appears.
If you are in a file list and want to return to the previous folder list, use the **^ V** buttons on the remote to highlight , and press **ENTER**.
3. If you want to view a particular file, press **^ V** to highlight a file and press **ENTER** or **PLAY**.
While viewing a file, you can press **STOP** to move to the previous menu (JPEG menu).

Viewing photo files as a slide show

PHOTO

1. Use **^ V <>** to highlight  icon then press **ENTER** to start slide Show.
2. You can change slide show speed using **<>** when  icon is highlighted.

About help menu for slide show

| Menu | Buttons | Operation |
|--|--------------------|------------------------|
|  ↶90° / ↷90° | ^ / V | Rotating the picture |
|  Prev./ Next | < / > | Moving to another file |
|  Hide | RETURN | Closing the slide show |
|  | ENTER | Hiding the help menu |

Listening to music during slide show

PHOTO

You can listen to music during slide show, if the disc contain music and photo files together. Use **^ V <>** to highlight  icon then press **ENTER** to start slide show.

! Note

This function is available only in disc.

Sleep Timer Setting

Press **SLEEP** one or more times to select delay time between 10 and 180 minutes, after the unit will turn off.

To check the remaining time, press **SLEEP**.

To cancel the sleep function, press **SLEEP** repeatedly until "SLEEP 10" appears, and then press **SLEEP** once again while "SLEEP 10" is displayed.

! Note

You can check the remaining time before the unit turns off.

Dimmer

Press **SLEEP** once. The display window will be darken by half. To cancel it, press **SLEEP** repeatedly until dimmer gets off.

Turn off the sound temporarily

Press **MUTE** to mute your unit.

You can mute your unit, for example, to answer the telephone, the "MUTE" displayed in the display window.

Screen Saver

The screen saver appears when you leave the unit in stop mode for about five minutes.

System Select - Optional

You must select the appropriate system mode for your TV system. If "NO DISC" appears in the display window, press and hold **PAUSE/STEP (II)** for more than five seconds to select a system.

Displaying file information (ID3 TAG)

While playing an MP3 file containing file information, you can display the information by pressing **DISPLAY**.

4

Operating

Radio Operations

Be sure that both FM aerials are connected. (Refer to the page 15)

Listening to the Radio

1. Press **FUNCTION** until FM appears in the display window.
The last received station is tuned in.
2. Press and hold **TUN.(-/+)** for about two seconds until the frequency indication starts to change, then release. Scanning stops when the unit tunes in a station.

or
Press **TUN.(-/+)** repeatedly.
3. Adjust the volume by rotating **VOL.** on the front panel or by pressing **VOL +** or **-** on the remote control repeatedly.

Presetting the Radio Stations

You can preset 50 stations for FM.

Before tuning, make sure that you have turned down the volume.

1. Press **FUNCTION** until FM appears in the display window.
2. Select the desired frequency by using **TUN.(-/+)**.
3. Press **PROG./MEMO.** a preset number will flash in the display window.
4. Press **PRESET (Λ V)** to select the preset number you want.
5. Press **PROG./MEMO.**
The station is stored.
6. Repeat the steps 2 to 5 to store other stations.

Deleting all the saved stations

1. Press and hold **PROG./MEMO.** for two seconds. "ERASE ALL" will flash up on the unit display.
2. Press **PROG./MEMO.** to erase all of the saved radio stations.

Improving poor FM reception

Press **PLAY (▶)** (MO./ST.) on the remote control. This will change the tuner from stereo to mono and usually improve the reception.

Sound adjustment

Setting the surround mode

This system has a number of pre-set surround sound fields. You can select a desired sound mode by using **EQ/LG EQ**. You can change the **EQ/LG EQ** using **<>** arrow key while the **EQ/LG EQ** information is displayed on.

The displayed items for the Equalizer may be different depending on sound sources and effects.

| On Display | Description |
|--------------------------------|--|
| NAT PLUS | You can enjoy the natural sound effect same as a 5.1-channel. |
| NATURAL | You can enjoy comfortable and natural sound. |
| Local Specialization equalizer | Regionally optimized sound effect. (DANGDUT/ ARABIC/ PERSIAN/ INDIA/ REGUETON/ MERENGUE/ SALSA/ SAMBA/ CUMBIA/ AFRO) |
| AUTO EQ | Realizes the sound equalizer that is the most similar to the genre of which is included in the MP3 ID3 tag of song files. |
| POP CLASSIC JAZZ ROCK | This program lends an enthusiastic atmosphere to the sound, giving you the feeling you are at an actual rock pop, jazz or classic concert. |
| MP3 OPT | This function is optimized for compressible MP3 file. It improves the treble sound. |
| BASS | During playback, Reinforces the treble, bass and surround sound effect. |
| VIRTUAL | You can enjoy more virtual surround sound. |
| BYPASS | You can enjoy the sound without equalizer effect. |

! Note

- In some of surround modes, on some speakers, there's no sound or low sound. it, depends on the mode of surround and the source of audio, it is not defective.
- You may need to reset the surround mode, after switching the input, sometimes even after the sound track changed.

Advanced Operations

Listening to music from your portable player or external device

The unit can be used to play the music from many types of portable player or external devices.

1. Connect the portable player to the P. IN(PORTABLE IN) connector of the unit.

Or

Connect the external device to the AUX connector of the unit.

2. Turn the power on by pressing **POWER**.
3. Select the PORTABLE or AUX function by pressing **FUNCTION**.
4. Turn the portable player or external device and start it playing.

4

Operating

Recording to USB

1. Connect the USB device to the unit.
2. Select a DVD/ CD function by pressing **FUNCTION**.

One track recording - You can record to USB after playing the file you want.

All tracks recording - You can record to USB after stop.

Program list recording - After showing the programmed list, you can record it to USB.

3. Start the recording by pressing ● **REC**.
4. To stop recording, press ■ **STOP**.

! Note

- You can check the recording percentage rate for the USB record on the screen during the recording.
- When you stop recording during playback, the file that has been recorded at that time will be stored.
- Do not remove the USB device or turn off the unit during USB recording. If not, an incomplete file may be made and not deleted on PC.
- If USB recording does not work, the message like "NO USB", "ERROR", "USB FULL" or "NO REC" is displayed on the display window.
- On CD-G disc, USB recording is not supported.
- You may not store more than 999 files.
- It'll be stored as TRK_001 on CD FOLDER.
- Recording is supported only in Audio CDs.

The making of unauthorized copies of copy-protected material, including computer programs, files, broadcasts and sound recordings, may be an infringement of copyrights and constitute a criminal offense. This equipment should not be used for such purposes.

Be responsible

Respect copyrights

Troubleshooting

| PROBLEM | CORRECTION |
|--|--|
| No power | Plug the power cord into the wall outlet securely. |
| No picture | Select the appropriate video input mode on the TV so the picture from the unit appears on the TV screen. |
| | Connect the video cables securely to both the TV and unit. |
| There is little or no sound | Select the correct input mode of the unit so you can hear the sound from the unit. |
| | Connect the audio cables into the connection terminals correctly. |
| | Replace with a new audio cable. |
| The DVD picture quality is poor | Clean the disc using a soft cloth with outward strokes. |
| A DVD/CD will not play | Insert a disc. |
| | Insert a playable disc (check the disc type, colour system and regional code). |
| | Place the disc with the label or printed side facing upwards. |
| | Enter your password or change the rating level. |
| Humming noise heard while a DVD or CD is playing | Clean the disc using a soft cloth with outward strokes. |
| | Move unit and audio components further away from your TV. |
| Radio stations can't be tuned in properly. | Check the antenna connection and adjust its position. |
| | Attach an external aerial if necessary. |
| | Tune to the station manually. |
| | Preset some radio stations, see page 24 for details. |
| The remote control doesn't work well / at all | The remote is not pointed directly at the unit. Point the remote directly at the unit. |
| | The remote is too far from the unit. Use the remote within 23 feet (7m) of the unit. |
| | There is an obstacle in the path between the remote control and the unit. Remove the obstacle. |
| | The battery in the remote control are flat. Replace the battery with new ones. |

Maintenance

Handling the Unit

When shipping the unit

Please save the original shipping carton and packing materials. If you need to ship the unit, for maximum protection, re-pack the unit as it was originally packed at the factory.

Keeping the exterior surfaces clean

- Do not use volatile liquids such as insecticide spray near the unit.
- Wiping with strong pressure may damage the surface.
- Do not leave rubber or plastic products in contact with the unit for a long period of time.

Cleaning the unit

To clean the player, use a soft, dry cloth. If the surfaces are extremely dirty, use a soft cloth lightly moistened with a mild detergent solution. Do not use strong solvents such as alcohol, benzene, or thinner, as these might damage the surface of the unit.

Maintaining the Unit

The unit is a high-tech, precision device. If the optical pick-up lens and disc drive parts are dirty or worn, the picture quality could be diminished. For details, please contact your nearest authorized service center.

Notes on Discs

Handling Discs

Do not touch the playback side of the disc. Hold the disc by the edges so that fingerprints do not get on the surface. Never stick paper or tape on the disc.

Storing Discs

After playing, store the disc in its case. Do not expose the disc to direct sunlight or sources of heat and never leave it in a parked car exposed to direct sunlight.

Cleaning Discs

Fingerprints and dust on the disc can cause poor picture quality and sound distortion. Before playing, clean the disc with a clean cloth. Wipe the disc from the center to out.

Do not use strong solvents such as alcohol, benzene, thinner, commercially available cleaners, or anti-static spray intended for older vinyl records.

Area Code List

Choose an area code from this list.

| Area | Code | Area | Code | Area | Code | Area | Code |
|----------------|------|---------------|------|--------------------|------|-----------------|------|
| Afghanistan | AF | Fiji | FJ | Monaco | MC | Singapore | SG |
| Argentina | AR | Finland | FI | Mongolia | MN | Slovak Republic | SK |
| Australia | AU | France | FR | Morocco | MA | Slovenia | SI |
| Austria | AT | Germany | DE | Nepal | NP | South Africa | ZA |
| Belgium | BE | Great Britain | GB | Netherlands | NL | South Korea | KR |
| Bhutan | BT | Greece | GR | Antilles | AN | Spain | ES |
| Bolivia | BO | Greenland | GL | New Zealand | NZ | Sri Lanka | LK |
| Brazil | BR | Hong Kong | HK | Nigeria | NG | Sweden | SE |
| Cambodia | KH | Hungary | HU | Norway | NO | Switzerland | CH |
| Canada | CA | India | IN | Oman | OM | Taiwan | TW |
| Chile | CL | Indonesia | ID | Pakistan | PK | Thailand | TH |
| China | CN | Israel | IL | Panama | PA | Turkey | TR |
| Colombia | CO | Italy | IT | Paraguay | PY | Uganda | UG |
| Congo | CG | Jamaica | JM | Philippines | PH | Ukraine | UA |
| Costa Rica | CR | Japan | JP | Poland | PL | United States | US |
| Croatia | HR | Kenya | KE | Portugal | PT | Uruguay | UY |
| Czech Republic | CZ | Kuwait | KW | Romania | RO | Uzbekistan | UZ |
| Denmark | DK | Libya | LY | Russian Federation | RU | Vietnam | VN |
| Ecuador | EC | Luxembourg | LU | Saudi Arabia | SA | Zimbabwe | ZW |
| Egypt | EG | Malaysia | MY | Senegal | SN | | |
| El Salvador | SV | Maldives | MV | | | | |
| Ethiopia | ET | Mexico | MX | | | | |

Language Code List

Use this list to input your desired language for the following initial settings: [Disc Audio], [Disc Subtitle] and [Disc Menu].

| Language | Code | Language | Code | Language | Code | Language | Code |
|-----------------|------|------------------|------|----------------|------|------------|------|
| Afar | 6565 | French | 7082 | Lithuanian | 7684 | Sindhi | 8368 |
| Afrikaans | 6570 | Frisian | 7089 | Macedonian | 7775 | Singhalese | 8373 |
| Albanian | 8381 | Galician | 7176 | Malagasy | 7771 | Slovak | 8375 |
| Ameharic | 6577 | Georgian | 7565 | Malay | 7783 | Slovenian | 8376 |
| Arabic | 6582 | German | 6869 | Malayalam | 7776 | Spanish | 6983 |
| Armenian | 7289 | Greek | 6976 | Maori | 7773 | Sudanese | 8385 |
| Assamese | 6583 | Greenlandic | 7576 | Marathi | 7782 | Swahili | 8387 |
| Aymara | 6588 | Guarani | 7178 | Moldavian | 7779 | Swedish | 8386 |
| Azerbaijani | 6590 | Gujarati | 7185 | Mongolian | 7778 | Tagalog | 8476 |
| Bashkir | 6665 | Hausa | 7265 | Nauru | 7865 | Tajik | 8471 |
| Basque | 6985 | Hebrew | 7387 | Nepali | 7869 | Tamil | 8465 |
| Bengali; Bangla | 6678 | Hindi | 7273 | Norwegian | 7879 | Telugu | 8469 |
| Bhutani | 6890 | Hungarian | 7285 | Oriya | 7982 | Thai | 8472 |
| Bihari | 6672 | Icelandic | 7383 | Panjabi | 8065 | Tonga | 8479 |
| Breton | 6682 | Indonesian | 7378 | Pashto, Pushto | 8083 | Turkish | 8482 |
| Bulgarian | 6671 | Interlingua | 7365 | Persian | 7065 | Turkmen | 8475 |
| Burmese | 7789 | Irish | 7165 | Polish | 8076 | Twi | 8487 |
| Byelorussian | 6669 | Italian | 7384 | Portuguese | 8084 | Ukrainian | 8575 |
| Chinese | 9072 | Japanese | 7465 | Quechua | 8185 | Urdu | 8582 |
| Croatian | 7282 | Kannada | 7578 | Rhaeto-Romance | 8277 | Uzbek | 8590 |
| Czech | 6783 | Kashmiri | 7583 | Rumanian | 8279 | Vietnamese | 8673 |
| Danish | 6865 | Kazakh | 7575 | Russian | 8285 | Volapük | 8679 |
| Dutch | 7876 | Kirghiz | 7589 | Samoan | 8377 | Welsh | 6789 |
| English | 6978 | Korean | 7579 | Sanskrit | 8365 | Wolof | 8779 |
| Esperanto | 6979 | Kurdish | 7585 | Scots Gaelic | 7168 | Xhosa | 8872 |
| Estonian | 6984 | Laothian | 7679 | Serbian | 8382 | Yiddish | 7473 |
| Faroese | 7079 | Latin | 7665 | Serbo-Croatian | 8372 | Yoruba | 8979 |
| Fiji | 7074 | Latvian, Lettish | 7686 | Shona | 8378 | Zulu | 9085 |
| Finnish | 7073 | Lingala | 7678 | | | | |

Trademarks and Licenses



"DVD Logo" is a trademark of DVD Format/Logo Licensing Corporation.



DivX®, DivX Certified® and associated logos are trademarks of DivX, Inc., and are used under license.



Manufactured under license from Dolby Laboratories. Dolby and the double-D symbol are trademarks of Dolby Laboratories.



Specifications

| General | |
|------------------------|--|
| Power requirements | 110 - 240 V, 50/ 60 Hz |
| Power consumption | 45 W |
| Dimensions (W x H x D) | Approx. 360 x 65 x 320 mm without foot |
| Net Weight (Approx.) | 2.5 kg |
| Operating temperature | 5 °C to 35 °C (41 °F to 95 °F) |
| Operating humidity | 5 % to 90 % |

| Outputs | |
|---------------------|---|
| VIDEO OUT | 1.0 V (p-p), 75 Ω, sync negative, RCA jack x 1 |
| COMPONENT VIDEO OUT | (Y) 1.0 V (p-p), 75 Ω, sync negative, RCA jack x 1 (Pb)/(Pr) 0.7 V (p-p), 75 Ω, RCA jack x 2 |
| ANALOG AUDIO IN | 2.0 Vrms (1 kHz, 0 dB), 600 Ω, RCA jack (L, R) x 1 |
| PORT. IN | 0.5Vrms (3.5 mm stereo jack) |

| System | |
|------------------------|---|
| Laser | Semiconductor laser, wavelength: 650 nm |
| Signal system | Standard NTSC/ PAL color TV system |
| Frequency response | 20 Hz to 20 kHz (48 kHz, 96 kHz, 192 kHz sampling) |
| Signal-to-noise ratio | More than 80 dB |
| Harmonic distortion | 0.05 % at 1 W |
| Dynamic range | More than 85 dB |
| Bus Power Supply (USB) | DC 5 V  500 mA |

| Amplificador | | |
|---------------|----------------------------|----------------------------|
| Stereo mode | 45 W + 45 W (4 Ω at 1 kHz) | |
| Surround mode | Front | 45 W + 45 W (THD 1 %) |
| | Center | 45 W |
| | Surround | 45 W + 45 W (4 Ω at 1 kHz) |
| | Subwoofer | 75 W (8 Ω at 60 Hz) |

| Tuner | |
|-----------------|--|
| FM Tuning Range | 87.5 to 108.0 MHz or 87.50 to 108.00 MHz |

| Front Speaker | |
|----------------------------|-------------------|
| Type | 1 Way 1 Speaker |
| Impedance Rated | 4 Ω |
| Input Power | 45 W |
| Max. Input Power | 90 W |
| Net Dimensions (W x H x D) | 113 x 113 x 84 mm |
| Net Weight | 0.34 kg |

| Rear Speaker | |
|----------------------------|-------------------|
| Type | 1 Way 1 Speaker |
| Impedance Rated | 4 Ω |
| Input Power | 45 W |
| Max. Input Power | 90 W |
| Net Dimensions (W x H x D) | 113 x 113 x 84 mm |
| Net Weight | 0.38 kg |

| Centre Speaker | |
|----------------------------|-------------------|
| Type | 1 Way 1 Speaker |
| Impedance Rated | 4 Ω |
| Input Power | 45 W |
| Max. Input Power | 90 W |
| Net Dimensions (W x H x D) | 113 x 113 x 84 mm |
| Net Weight | 0.34 kg |

| Subwoofer | |
|----------------------------|--------------------|
| Type | 1 Way 1 Speaker |
| Impedance Rated | 8 Ω |
| Input Power | 75 W |
| Max. Input Power | 150 W |
| Net Dimensions (W x H x D) | 155 x 325 x 265 mm |
| Net Weight | 3 kg |

Design and specifications are subject to change without notice.

