



OWNER'S MANUAL

VKC902H****

New Type Cyclone Vacuum Cleaner

This information contains important instructions for the safe use and maintenance of the vacuum cleaner. Especially, please read all of the information on page 4,5 for your safety. Please keep this manual in an easily accessible place and refer to it anytime.





②

Table of contents

Important safety instructions	4-5
How to use	6
Assembling vacuum cleaner.....	6
Operating vacuum cleaner.....	8
Using carpet and floor nozzle	9
Using TurboCombi Nozzle and mini turbine nozzle.....	10
Using accessory nozzles	11
Emptying dust tank	12
Cleaning dust tank.....	13
Cleaning air filter and motor safety filter	14
Cleaning exhaust filter	15
What to do if your vacuum cleaner does not work	16
What to do when suction performance decreases	16





IMPORTANT SAFETY INSTRUCTIONS

Read and follow all instructions before using your vacuum cleaner to prevent the risk of fire, electric shock, personal injury, or damage when using the vacuum cleaner. This guide does not cover all possible conditions that may occur. Always contact your service agent or manufacturer about problems that you do not understand. This appliance complies with the following EC Directives: -73/23/EEC, 93/68/EEC-Low Voltage Directive-89/336/EEC –EMC Directive.



This is the safety alert symbol.

This symbol alerts you to potential hazards that can kill or hurt you and others.

All safety messages will follow the safety alert symbol and either the word "WARNING" or "CAUTION."

These words mean:

WARNING

This symbol will alert you to hazards or unsafe practices which could cause serious bodily harm or death.

CAUTION

This symbol will alert you to hazards or unsafe practices which could cause bodily injury or property damage.

WARNING

- **Do not plug in if control knob is not in OFF position.**
Personal injury or product damage could result.
- **Keep children away and beware of obstructions when rewinding the cord to prevent personal injury**
The cord moves rapidly when rewinding.
- **Disconnect electrical supply before servicing or cleaning the unit or when cleaner is not in use.**
Failure to do so could result in electrical shock or personal injury.
- **Do not use vacuum cleaner to pick up anything that is burning or smoking such as cigarettes, or hot ashes.**
Doing so could result in death, fire or electrical shock.
- **Do not vacuum flammable or explosive substances such as gasoline, benzene, thinners, propane (liquids or gases).**
The fumes from these substances can create a fire hazard or explosion. Doing so could result in death or personal injury.
- **Do not handle plug or vacuum cleaner with wet hands.**
Doing so could result in death or electrical shock.
- **Do not unplug by pulling on cord.**
Doing so could result in product damage or electrical shock. To unplug, grasp the plug, not the cord.
- **Keep hair, loose clothing, fingers, and all parts of the body away from openings and moving parts.**
Failure to do so could result in electrical shock or personal injury.
- **Do not pull or carry by cord, use cord as a handle, close a door on cord, or pull cord around sharp edges or corners. Do not run vacuum cleaner over cord. Keep cord away from heated surfaces.**
Failure to do so could result in electrical shock or personal injury or fire or product damage.
- **The hose contains electrical wires. Do not use it if it is damaged, cut or punctured.**
Failure to do so could result in death, or electrical shock.
- **Do not allow to be used as toy. Close attention is necessary when used by or near children.**
Personal injury or product damage could result.
- **Do not use the vacuum cleaner if the power cord or plug is damaged or faulty.**
Personal injury or product damage could result. In these cases, contact LG Electronics Service Agent to avoid hazard.
- **Do not use vacuum cleaner if it has been under water.**
Personal injury or product damage could result. In these cases, contact LG Electronics Service Agent to avoid hazard.
- **Do not continue to vacuum if any parts appear missing or damaged.**
Personal injury or product damage could result. In these cases, contact LG Electronics Service Agent to avoid hazard.
- **Do not use an extension cord with this vacuum cleaner**
Fire hazard or product damage could result.
- **Using proper voltage.**
Using improper voltage may result in damage to the motor and possible injury to the user. Proper voltage is listed on the bottom of vacuum cleaner.
- **Turn off all controls before unplugging.**
Failure to do so could result in electrical shock or personal injury.
- **Do not change the plug in any way.**
Failure to do so could result in electrical shock or personal injury or product damage. Doing so result in death. If plug does not fit, contact a qualified electrician to install the proper outlet.
- **Repairs to electrical appliances may only be performed by qualified service engineers.**
Improper repairs may lead to serious hazards for the user.
- **Do not put fingers near the gear.**
Failure to do so could result in personal injury.

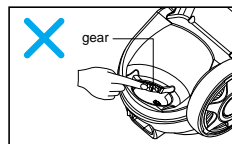

IMPORTANT SAFETY INSTRUCTIONS

CAUTION

- **Do not put any objects into openings.**
Failure to do so could result in product damage.
- **Do not use with any opening blocked: keep free of dust, lint, hair, and anything that may reduce air flow.**
Failure to do so could result in product damage.
- **Do not use vacuum cleaner without dust tank and/or filters in place.**
Failure to do so could result in product damage.
- **Always clean the dust bin after vacuuming carpet cleaners or fresheners, powders and fine dust.**
These products clog the filters, reduce airflow and can cause damage to the cleaner. Failure to clean the dust bin could cause permanent damage to the cleaner.
- **Do not use vacuum cleaner to pick up sharp hard objects, small toys, pins, paper clips, etc.**
They may damage the cleaner or dust bin.
- **Store the vacuum cleaner indoors.**
Put the vacuum cleaner away after use to prevent tripping over it.
- **The vacuum cleaner is not intended to use by young children or infirm people without supervision.**
Failure to do so could result in personal injury or product damage.
- **Only use parts produced or recommended by LG Electronics Service Agents.**
Failure to do so could result in product damage.
- **Use only as described in this manual. Use only with LG recommended or approved attachments and accessories.**
Failure to do so could result in personal injury or product damage.
- **To avoid personal injury and to prevent the machine from falling when cleaning stairs, always place it at the bottom of stairs.**
Failure to do so could result in personal injury or product damage.
- **Use accessory nozzles in sofa mode.**
Failure to do so could result in product damage.
- **Don't grasp the tank handle when you are moving the vacuum cleaner.**
The vacuum cleaner's body may fall when separating tank and body. Personal injury or product damage could result. **You should grasp the carrier handle** when you are moving the vacuum cleaner.
- **If after emptying the dust tank the indicator light is on (red), clean the dust tank.**
Failure to do so could result in product damage.
- **Make sure the filters (exhaust filter and motor safety filter) are completely dry before replacing in the machine.**
Failure to do so could result in product damage.
- **Do not dry the filter in an oven or microwave.**
Failure to do so could result in fire hazard.
- **Do not dry the filter in a clothes dryer.**
Failure to do so could result in fire hazard.
- **Do not dry near an open flame.**
Failure to do so could result in fire hazard.
- **Do not push or pull the lever on the vacuum cleaner**
If the lever is damaged, the vacuum cleaner may not work properly and indicator light may flash red and alarm may sound although dust tank is not full. In this case, contact LG Electronics Service Agent

<Do not push or pull the lever>

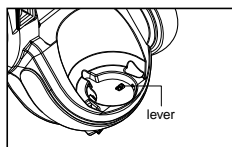

Thermal protector :

This vacuum cleaner has a special thermostat that protects the vacuum cleaner in case of motor overheating. If the vacuum cleaner suddenly shuts off, turn off the switch and unplug the vacuum cleaner. Check the vacuum cleaner for possible source of overheating such as a full dust tank, a blocked hose or clogged filter. If these conditions are found, fix them and wait at least 30 minutes before attempting to use the vacuum cleaner. After the 30 minute period, plug the vacuum cleaner back in and turn on the switch. If the vacuum cleaner still does not run, contact a qualified electrician.

How to use Assembling vacuum cleaner

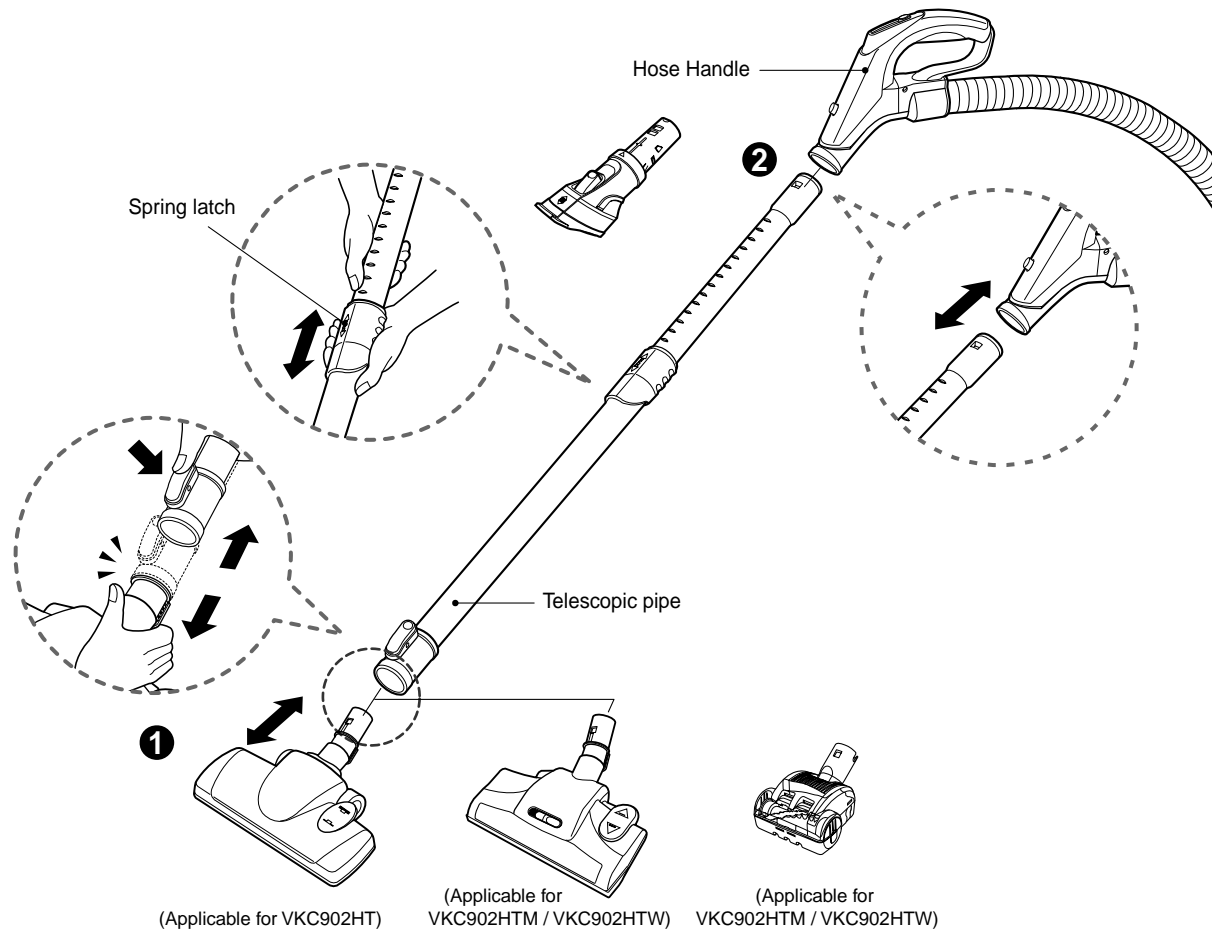

① Carpet and floor nozzle (depend on model)

Push the nozzle into the telescopic pipe.

② Telescopic pipe

- Push telescopic pipe firmly into hose handle.
- Grasp the spring latch to expand.
- Pull out the pipe to desired length.

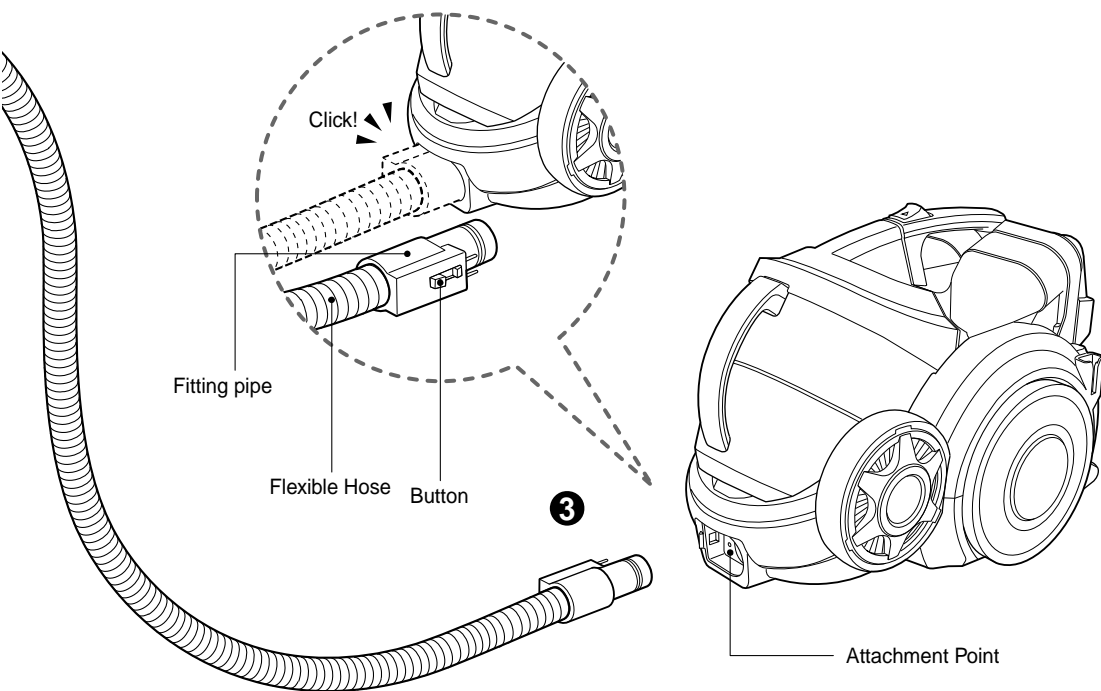

3 Connecting the hose to the vacuum cleaner

Push the fitting pipe on the flexible hose into the attachment point on the vacuum cleaner. To remove the flexible hose from the vacuum cleaner, press the button situated on the fitting pipe, then pull the fitting pipe out of the vacuum cleaner.

How to use Operating vacuum cleaner

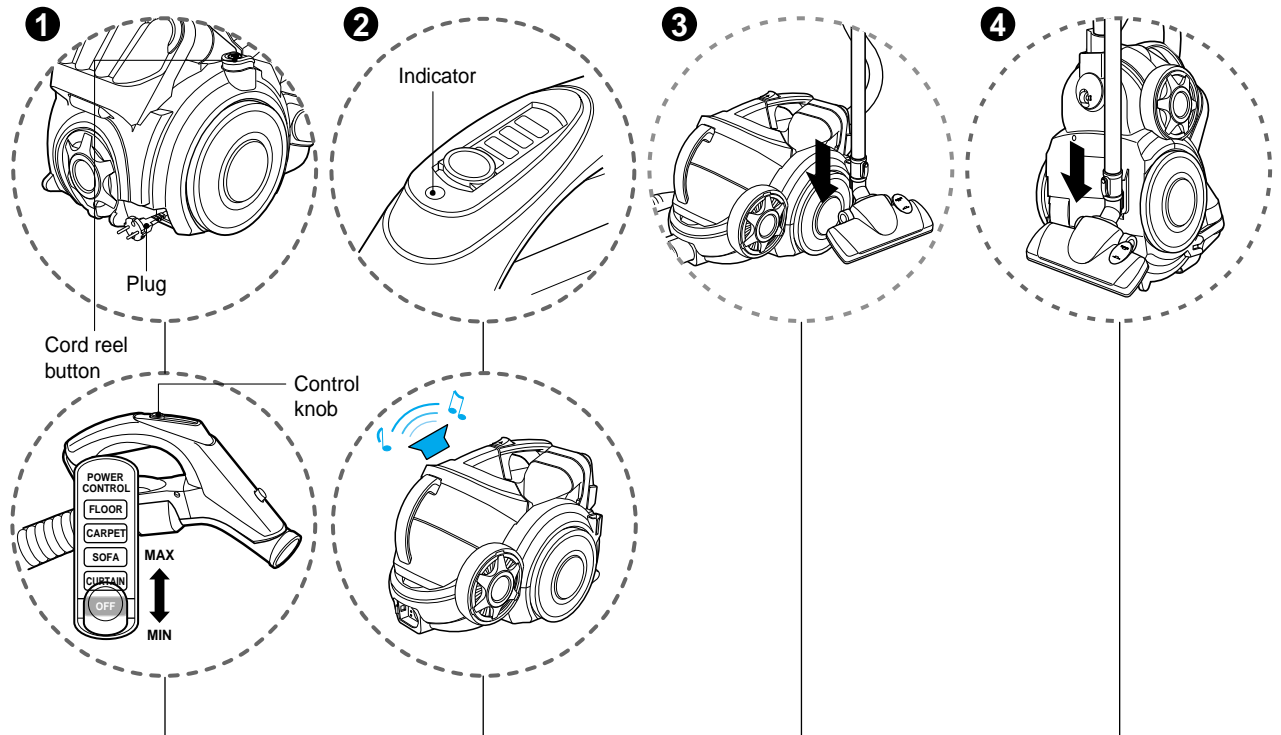

1 How to operate

- Pull out the power cord to the desired length and plug into the socket.
- Place the control knob of the hose handle to the required position.
- To turn off, slide control knob to OFF position.
- Press the cord reel button to rewind the power cord after use.

2 Indicator and alarm sound

- The indicator light of the hose handle is on and alarm will sound when dust tank is full. After about 2 minutes, vacuum cleaner will turn itself off and alarm will sound. Empty the dust tank and reuse the vacuum cleaner

3 Park mode

- To store during vacuuming, for example to move a small piece of furniture or a rug, use park mode to support the flexible hose and nozzle.
 - Slide the hook on the nozzle into the slot on the side of vacuum cleaner.

4 Storage

- When you have switched off and unplugged the vacuum cleaner, press the cord reel button to automatically rewind the cord.
- You can store your vacuum cleaner in a vertical position by sliding the hook on the nozzle into the slot on the underside of the vacuum cleaner.

NOTICE

When indicator light flashes and alarm sounds :

1. Dust tank is full
 - ➔ slide handle knob to OFF position and empty dust tank
2. Power is on without dust tank
 - ➔ slide handle knob to OFF position and reattach dust tank
3. Rotating plate in the dust tank is restricted because of obstruction
 - ➔ slide handle knob to OFF position and remove obstruction

How to use Using carpet and floor nozzle (Applicable for VKC902HT)

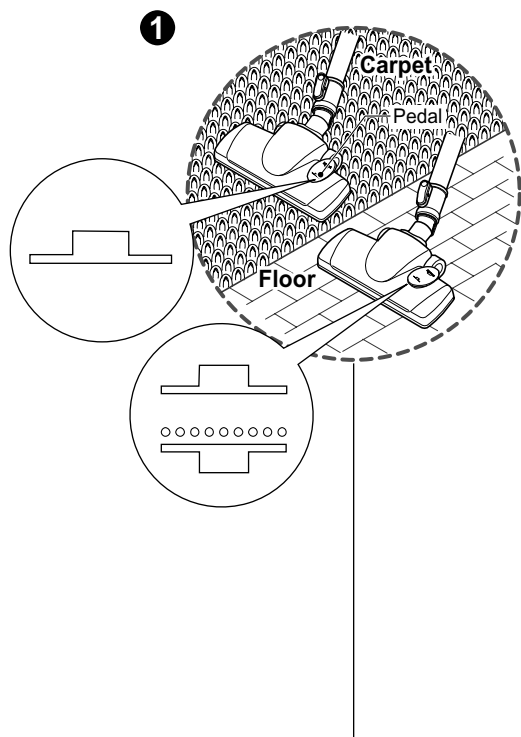

• Cleaning carpet and floor nozzle

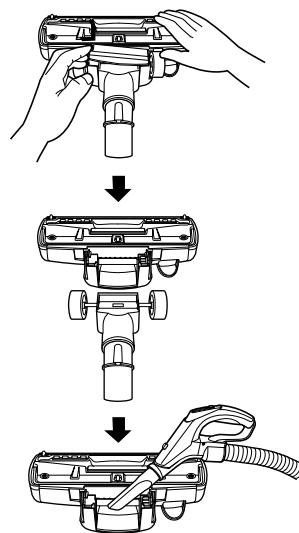

1 Carpet and floor nozzle (depend on model)

- **The 2 position nozzle**

This is equipped with a pedal which allows you to alter its position according to the type of floor to be cleaned.

- **Carpet or rug position**

press the pedal (↙) to lower brush.

- **Hard floor position** (tiles, parquets floor)

Both pedal position are suitable.

- Open the cover by pulling the hook.



- Separate the nozzle into two parts



- Clean the hole of the nozzle.



How to use Using TurboCombi Nozzle and mini turbine nozzle (Applicable for VKC902HTM / VKC902HTW)

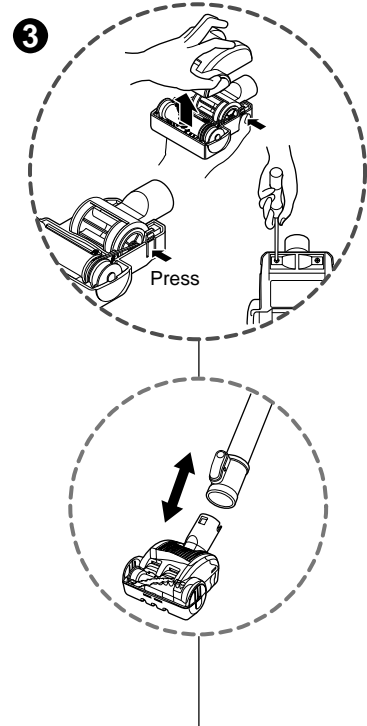
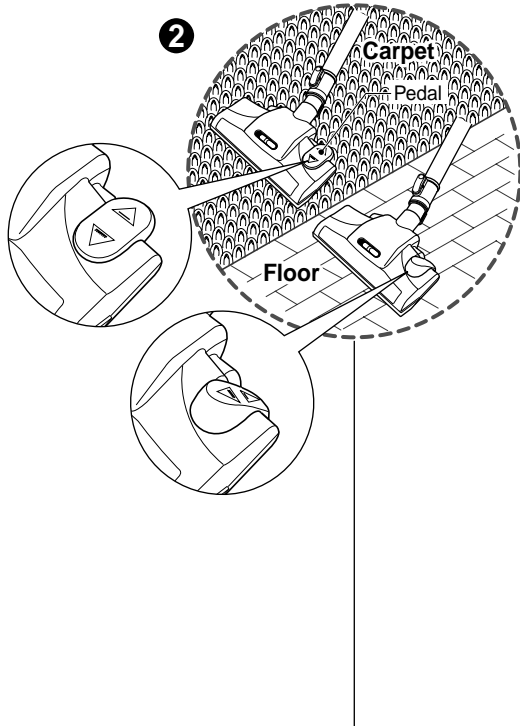

2 TurboCombi Nozzle (depend on model)

- **The 2 position nozzle**
This is equipped with a pedal which allows you to alter its position according to the type of floor to be cleaned.
- **Carpet or rug position**
Press the pedal (▲), then brush will rotate
- **Hard floor position**
Press the pedal (△), then brush will stop rotating

• Cleaning TurboCombi nozzle

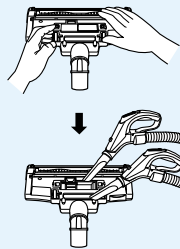

- Open the cover by pulling the hook.

- Clean the hole and brush of the nozzle.

3 Mini turbine nozzle (optional)

- Mini turbine is used for stairs and other hard to reach places.
- To clean the mini turbine nozzle, remove the nozzle cover :
Remove 2 screws on the bottom and take mini turbine nozzle cover off as shown.
- Frequently clean and remove hair, string, and lint build-up in the brush area. Failure to do so could damage to mini turbine nozzle.

How to use Using accessory nozzles

Upholstery nozzle

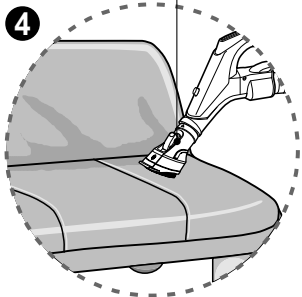

4

Dusting brush

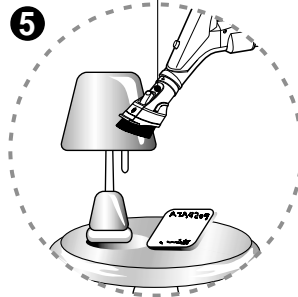

5

Crevice tool

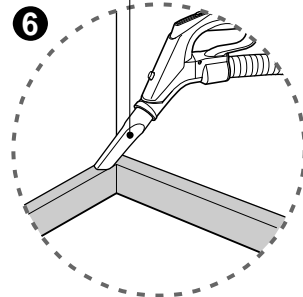

6



4 Upholstery nozzle

Upholstery nozzle is for vacuuming upholstery, mattresses etc.

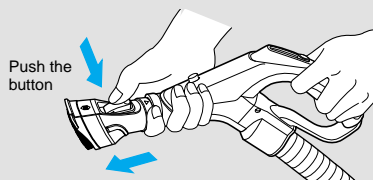

< Upholstery nozzle mode >

5 Dusting brush

Dusting brush is for vacuuming picture frames, furniture frames, books and other irregular surfaces.

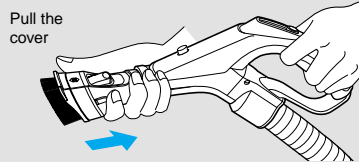

< Dusting brush mode >

6 Crevice tool

Crevice tool is for vacuuming in those normally hard-to-reach places such as reaching cobwebs or between the cushions of a sofa.

NOTICE

Use accessory in the sofa mode

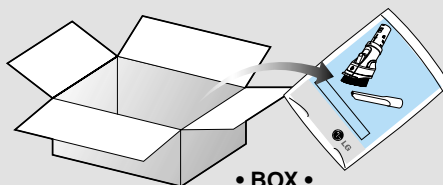

• BOX •

• Accessory nozzles included in the "PE BAG" with owner's manual.



How to use Emptying dust tank

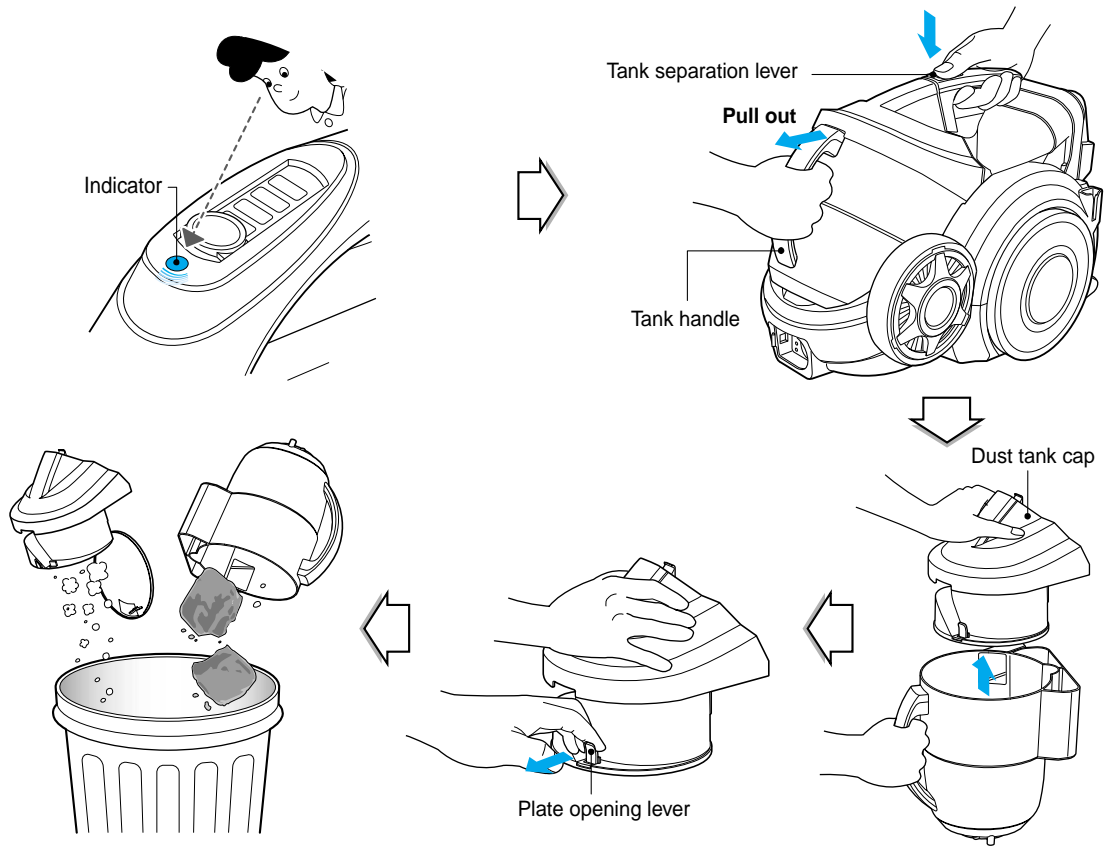

The dust tank needs emptying when indicator light is on.

- Turn off the vacuum cleaner and unplug it.
- Grasp the handle of the tank and then press the tank separation lever.
- Pull out the dust tank.
- Empty the tank and then assemble the dust tank as below

Assembling dust tank

First, place the bottom of dust tank on the vacuum cleaner and tilt.

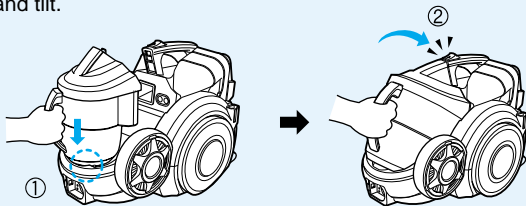

NOTICE

- If suction power decreases after emptying dust tank, clean dust tank → next page
- **Since dust tank is full, indicator continues to flash for 2-3 minutes and suction power will decrease for a while, then vacuum cleaner will turn itself off.**

Moving the vacuum cleaner

- Don't grasp the tank handle when you are moving the vacuum cleaner. The vacuum cleaner's body may fall when separating tank and body. You should grasp the carrier handle when you are moving the vacuum cleaner.

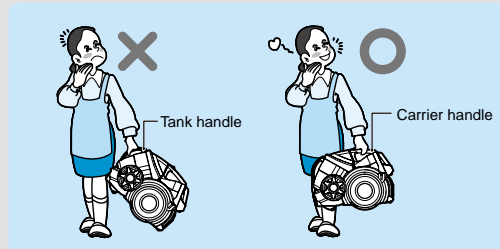

How to use Cleaning dust tank

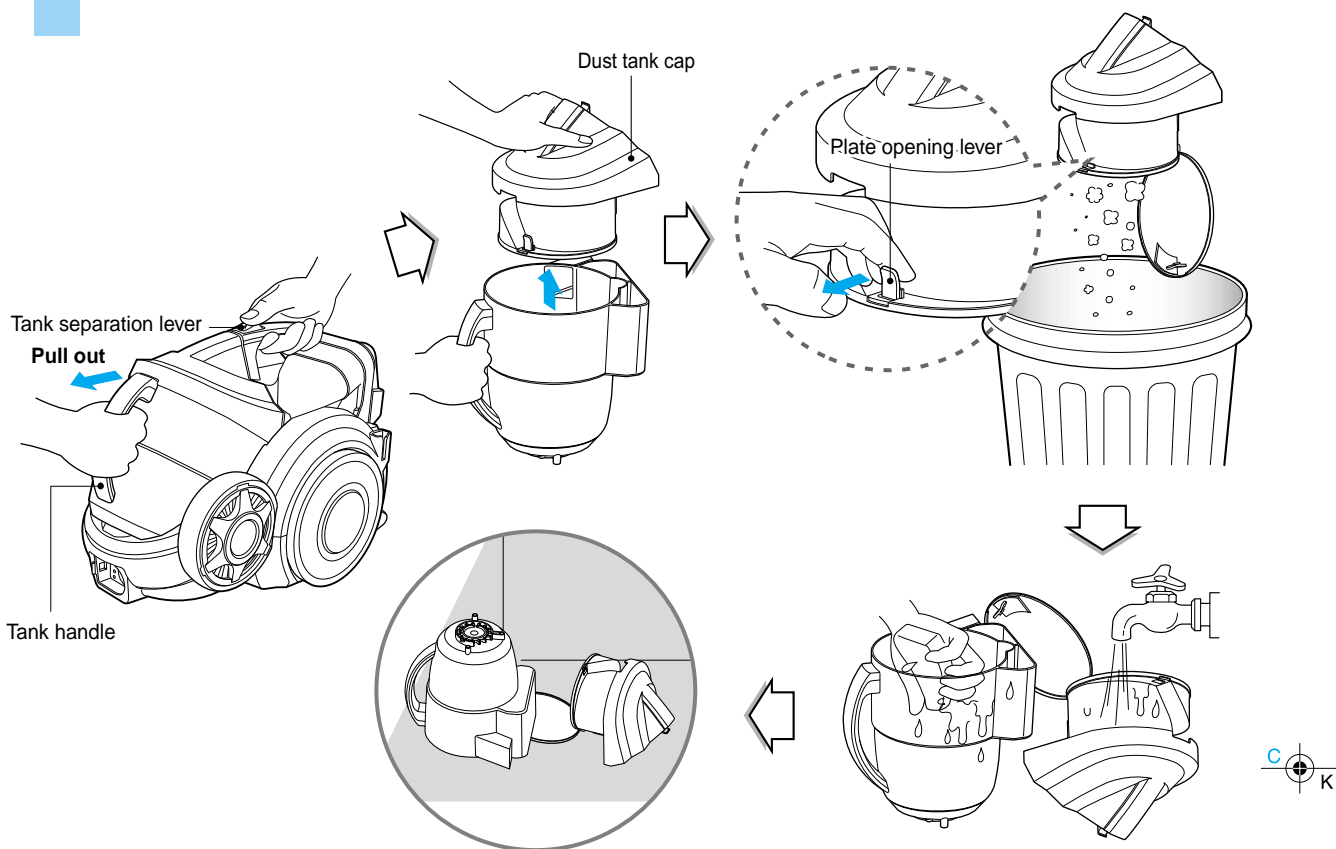

- Press tank separation lever and pull out dust tank.
- Raise dust tank cap
- Dry fully in shade so that moisture is entirely removed.

NOTICE

If suction power decreases after cleaning dust tank, clean air filter and motor safety filter. ➔ Next page

How to use Cleaning air filter and motor safety filter

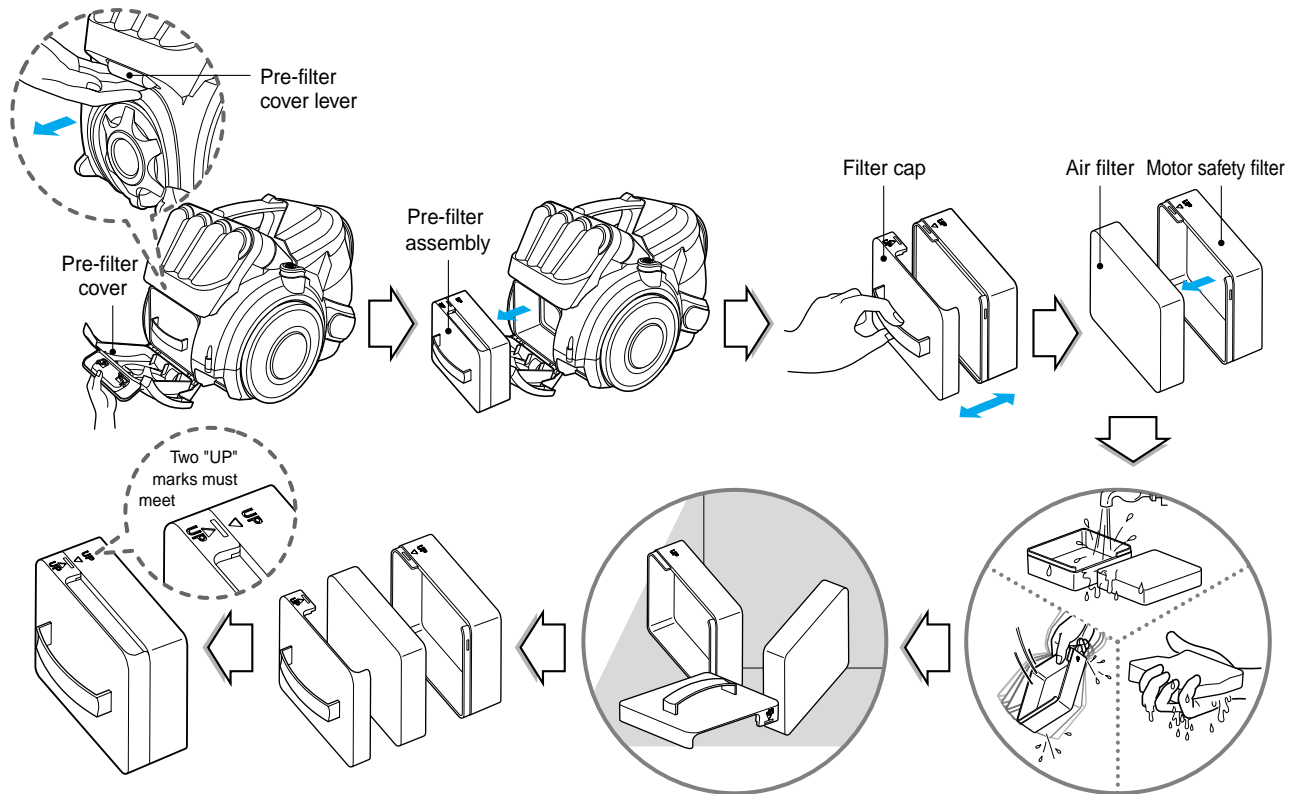

If suction power is decreased after cleaning dust tank, clean air filter and motor safety filter. Air filter and motor safety filter are located at the back of vacuum cleaner in the above figure.

- Open the pre filter cover by pulling the pre filter cover lever and take out pre filter assembly
- Separate the parts
- Wash air filter and motor safety filter with water
- Do not wash filters with hot water.
- Dry fully in shade so that moisture is entirely removed.
- Air filter and motor safety filter should be cleaned in the above case.

NOTICE

If filters are damaged, do not use them.
In this cases, contact LG Electronics Service Agent.

How to use Cleaning exhaust filter

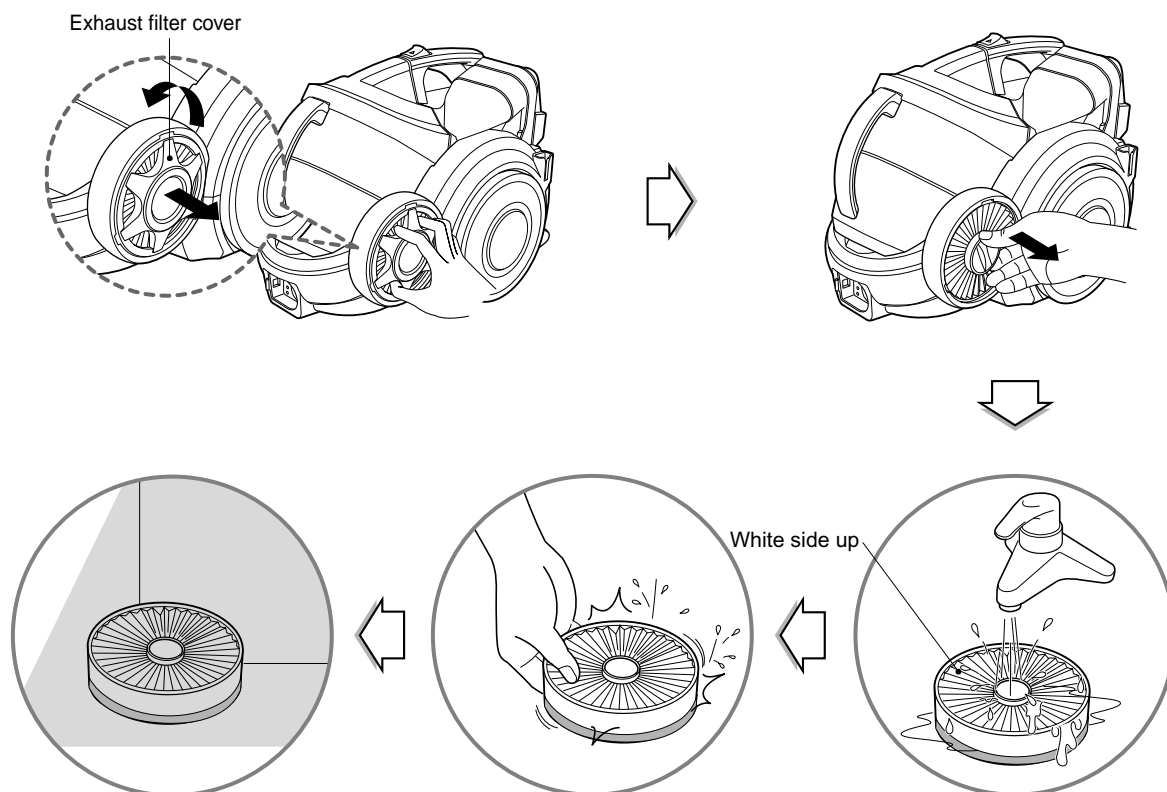

- The exhaust filter is a washable and reusable HEPA filter.
- To clean the exhaust filter, remove the exhaust filter cover on the body by rotating it counterclockwise.
- Separate the exhaust filter.
- Wash the filter cleanly in flowing water.
- Remove moisture.
- **When filter is washed, make sure not to wash green side of filter**
- Dry fully in shade so that moisture is entirely removed.
- The exhaust filter should be cleaned at least once a year.

Exhaust filter cover assembling

- Fit exhaust filter cover lugs to the grooves of vacuum cleaner body
- Join it to the body by rotating it clockwise.



What to do if your vacuum cleaner does not work

Check that the vacuum cleaner is plugged in correctly and that the electrical socket is working.

What to do when suction performance decreases

- Turn off the vacuum cleaner and unplug it.
- Check the telescopic pipe, flexible hose and cleaning tool for blockages or obstructions.
- Check that the dust tank is not full. Empty if necessary.
- Check that the exhaust filter is not clogged. Clean the exhaust filter if necessary.
- Check that the air filter is not clogged. Clean the air filter if necessary.



Disposal of your old appliance

1. When this crossed-out wheeled bin symbol is attached to a product it means the product is covered by the European Directive 2002/96/EC.
2. All electrical and electronic products should be disposed of separately from the municipal waste stream via designated collection facilities appointed by the government or the local authorities.
3. The correct disposal of your old appliance will help prevent potential negative consequences for the environment and human health.
4. For more detailed information about disposal of your old appliance, please contact your city office, waste disposal service or the shop where you purchased the product.

Note



Note



Note





P/No.: MFL37414301
Made in KOREA