



OWNER'S MANUAL

3D Blu-ray™ / DVD

Home Cinema System

Please read this manual carefully before operating your set and retain it for future reference.

HX352 (HX352, S62S1-S, S62T1-C, S62S1-W)

P/NO : SAC35474805

Safety Information



CAUTION
RISK OF ELECTRIC SHOCK
DO NOT OPEN



CAUTION: TO REDUCE THE RISK OF ELECTRIC SHOCK DO NOT REMOVE COVER (OR BACK) NO USER-SERVICEABLE PARTS INSIDE REFER SERVICING TO QUALIFIED SERVICE PERSONNEL.



This lightning flash with arrowhead symbol within an equilateral triangle is intended to alert the user to the presence of uninsulated dangerous voltage within the product's enclosure that may be of sufficient magnitude to constitute a risk of electric shock to persons.



The exclamation point within an equilateral triangle is intended to alert the user to the presence of important operating and maintenance (servicing) instructions in the literature accompanying the product.

WARNING: TO PREVENT FIRE OR ELECTRIC SHOCK HAZARD, DO NOT EXPOSE THIS PRODUCT TO RAIN OR MOISTURE.

WARNING: Do not install this equipment in a confined space such as a book case or similar unit.

CAUTION: Do not block any ventilation openings. Install in accordance with the manufacturer's instructions.

Slots and openings in the cabinet are provided for ventilation and to ensure reliable operation of the product and to protect it from over heating. The openings shall be never be blocked by placing the product on a bed, sofa, rug or other similar surface. This product shall not be placed in a built-in installation such as a bookcase or rack unless proper ventilation is provided or the manufacturer's instruction has been adhered to.



CAUTION : CLASS 1M VISIBLE AND INVISIBLE LASER RADIATION WHEN OPEN. DO NOT VIEW DIRECTLY WITH OPTICAL INSTRUMENTS

Use of controls, adjustments or the performance of procedures other than those specified herein may result in hazardous radiation exposure.

CAUTION concerning the Power Cord

Most appliances recommend they be placed upon a dedicated circuit;

That is, a single outlet circuit which powers only that appliance and has no additional outlets or branch circuits. Check the specification page of this owner's manual to be certain. Do not overload wall outlets. Overloaded wall outlets, loose or damaged wall outlets, extension cords, frayed power cords, or damaged or cracked wire insulation are dangerous. Any of these conditions could result in electric shock or fire. Periodically examine the cord of your appliance, and if its appearance indicates damage or deterioration, unplug it, discontinue use of the appliance, and have the cord replaced with an exact replacement part by an authorized service center. Protect the power cord from physical or mechanical abuse, such as being twisted, kinked, pinched, closed in a door, or walked upon. Pay particular attention to plugs, wall outlets, and the point where the cord exits the appliance. To disconnect power from the mains, pull out the mains cord plug. When installing the product, ensure that the plug is easily accessible.

This device is equipped with a portable battery or accumulator.

Safety way to remove the battery or the battery from the equipment: Remove the old battery or battery pack, follow the steps in reverse order than the assembly. To prevent contamination of the environment and bring on possible threat to human and animal health, the old battery or the battery put it in the appropriate container at designated collection points. Do not dispose of batteries or battery together with other waste. It is recommended that you use local, free reimbursement systems batteries and accumulators. The battery shall not be exposed to excessive heat such as sunshine, fire or the like.

CAUTION: The apparatus shall not be exposed to water (dripping or splashing) and no objects filled with liquids, such as vases, shall be placed on the apparatus.

Disposal of your old appliance



1. When this crossed-out wheeled bin symbol is attached to a product it means the product is covered by the European Directive 2002/96/EC.
2. All electrical and electronic products should be disposed of separately from the municipal waste stream via designated collection facilities appointed by the government or the local authorities.
3. The correct disposal of your old appliance will help prevent potential negative consequences for the environment and human health.
4. For more detailed information about disposal of your old appliance, please contact your city office, waste disposal service or the shop where you purchased the product.

Disposal of waste batteries/accumulators



1. When this crossed-out wheeled bin symbol is attached to batteries/accumulators of Your product it means they are covered by European Directive 2006/66/EC.
2. This symbol may be combined with chemical symbols for mercury(Hg), cadmium(Cd) or lead(Pb) if the battery Contains more than 0.0005% of mercury, 0.002% of cadmium or 0.004% of lead.
3. All batteries/accumulators should be disposed separately from the municipal waste stream via designated collection facilities appointed by the government or the local authorities.
4. The correct disposal of Your old batteries/accumulators will help to prevent potential negative consequences for the environment, animal and human health.
5. For more detailed information about disposal of Your old batteries/accumulators, please contact Your city office, waste disposal service or the shop where You purchased the product.

CE LG Electronics hereby declares that this/ these product(s) is/are in compliance with the essential requirements and other relevant provisions of Directive 2004/108/EC, 2006/95/EC, and 2009/125/EC.

European Standards Centre:

Krijgsman 1, 1186 DM Amstelveen
The Netherlands

- Please note that this is NOT a Customer Service contact point. For Customer Service Information, see Warranty Card or contact the dealer that you purchased this product.

Notes on Copyrights

- Because AACS (Advanced Access Content System) is approved as content protection system for Blu-ray Disc format, similar to use of CSS (Content Scramble System) for DVD format, certain restrictions are imposed on playback, analog signal output, etc., of AACS protected contents. The operation of this product and restrictions on this product may vary depending on your time of purchase as those restrictions may be adopted and/or changed by AACS after the production of this product.
- Furthermore, BD-ROM Mark and BD+ are additionally used as content protection systems for Blu-ray Disc format, which imposes certain restrictions including playback restrictions for BD-ROM Mark and/or BD+ protected contents. To obtain additional information on AACS, BD-ROM Mark, BD+, or this product, please contact an authorized Customer Service Centre.
- Many BD-ROM/DVD discs are encoded with copy protection. Because of this, you should only connect your player directly to your TV, not to a VCR. Connecting to a VCR results in a distorted picture from copy-protected discs.
- This product incorporates copyright protection technology that is protected by U.S. patents and other intellectual property rights. Use of this copyright protection technology must be authorized by Rovi, and is intended for home and other limited viewing uses only unless otherwise authorized by Rovi. Reverse engineering or disassembly is prohibited.
- Under the U.S. Copyright laws and Copyright laws of other countries, unauthorized recording, use, display, distribution, or revision of television programs, videotapes, BD-ROM discs, DVDs, CDs and other materials may subject you to civil and/or criminal liability.

Important Notice for TV colour system

The colour system of this player differs according to currently playing discs.

For example, when the player plays the disc recorded in the NTSC colour system, the image is output as an NTSC signal.

Only the multi system colour TV can receive all signals output from the player.

- If you have a PAL colour system TV, you will see just distorted images when using discs or video contents recorded in NTSC.
- The multi system colour TV changes the colour system automatically according to input signals. In case that the colour system is not changed automatically, turn it off and then on to see normal images on screen.
- Even if the disc recorded in NTSC colour system are well displayed on your TV, these may not be recorded correctly on your recorder.



Caution

- Watching a 3D content for a long period time may cause dizziness or tiredness.
- It is not recommended to watch a movie in 3D mode for infirm, child and pregnant woman.
- If you are experiencing headache, tiredness or dizziness while viewing contents in 3D, it is strongly recommended to stop the playback and rest until you feel normal.

Table of Contents

1 Getting Started

- 2 Safety Information
- 8 Introduction
 - 8 – Playable Discs and symbols used in this manual
 - 9 – About the "⓪" Symbol Display
 - 9 – Compatibility Notes
 - 10 – File compatibility
 - 11 – AVCHD (Advanced Video Codec High Definition)
 - 12 – About DLNA
 - 12 – Certain System Requirements
 - 12 – Regional Code
 - 12 – System Select
- 13 Remote control
- 14 Front panel
- 15 Rear panel

2 Connecting

- 16 Positioning the system
- 17 Speaker Connection
 - 17 – Attaching the speakers to the player
- 18 Connecting to Your TV
 - 18 – HDMI Connection
 - 19 – What is SIMPLINK?
 - 20 – Video Connection
 - 20 – Resolution Setting
- 21 Antenna connection
- 22 Connections with external device
 - 22 – AUX Connection
 - 22 – PORT. IN connection
 - 23 – OPTICAL IN connection
- 24 Connecting to your Home Network
 - 24 – Wired network connection
 - 25 – Wired Network Setup
- 27 USB device connection
 - 27 – Playback content in the USB device

3 System Setting

- 28 Settings

- 28 – Initial Setup
- 29 – Adjust the Setup Settings
- 30 – [DISPLAY] Menu
- 31 – [LANGUAGE] Menu
- 32 – [AUDIO] Menu
- 34 – [LOCK] Menu
- 35 – [NETWORK] Menu
- 35 – [OTHERS] Menu
- 37 Sound Effect

4 Operating

- 38 General Playback
 - 38 – Using [HOME] menu
 - 38 – Playing a Disc
 - 38 – Playing a file on a disc/USB device
 - 39 – Playing Blu-ray 3D disc
 - 39 – Enjoying BD-Live™
 - 40 – Playing a file on a network server
 - 40 – Basic operations for video and audio content
 - 41 – Basic operations for photo content
 - 41 – Using the disc menu
 - 41 – Resume playback
 - 41 – Last Scene Memory
- 42 Advanced Playback
 - 42 – Repeat Playback
 - 42 – Repeating a specific portion
 - 42 – Viewing content information
 - 43 – Changing content list view
 - 43 – Selecting a subtitle file
 - 44 – Options while viewing a photo
 - 44 – Listening to music while slide show
- 45 On-Screen display
 - 45 – Displaying content information on-screen
 - 46 – Playing from selected time
 - 46 – Selecting a subtitle language
 - 46 – Hearing a different audio
 - 46 – Watching from a different angle
 - 47 – Changing the TV Aspect Ratio
 - 47 – Changing subtitle code page
 - 47 – Changing the Picture Mode
- 48 Radio Operations
 - 48 – Listening to the radio
 - 48 – Presetting the Radio Stations
 - 48 – Deleting a saved station

- 48 – Deleting all the saved stations
- 48 – Improving poor FM reception
- 48 – See information about a radio station
- 49 Using the Premium
- 49 Using the LG Apps
- 50 – Signing in
- 50 – Managing my Apps

5 Troubleshooting

- 51 Troubleshooting
- 51 – General
- 52 – Network
- 53 – Picture
- 53 – Sound
- 53 – Customer Support
- 53 – Open source software notice











6 Appendix

- 54 Controlling a TV with the Supplied Remote Control
- 54 – Setting up the remote to control your TV
- 55 Network Software Update
- 55 – Network update notification
- 55 – Software Update
- 57 About Nero MediaHome 4 Essentials
- 57 – System Requirements
- 58 – Installing Nero MediaHome 4 Essentials
- 58 – Sharing files and folders
- 59 Area Code List
- 60 Language code List
- 61 Trademarks and Licenses
- 63 Audio Output Specifications
- 64 Specifications
- 66 Maintenance
- 66 – Handling the Unit
- 66 – Notes on Discs
- 67 Important Information Relating to Network Services

Introduction

1

Playable Discs and symbols used in this manual

Media/Term	Logo	Symbol	Description
Blu-Ray		BD	<ul style="list-style-type: none"> Discs such as movies that can be purchased or rented. "Blu-ray 3D" discs and "Blu-ray 3D ONLY" discs. BD-R/RE discs that are recorded in BDAV format.
		MOVIE MUSIC PHOTO	<ul style="list-style-type: none"> BD-R/RE discs that contain Movie, Music or Photo files. ISO 9660+JOLIET, UDF and UDF Bridge format
DVD-ROM DVD-R DVD-RW DVD+R DVD+RW (8 cm, 12 cm)		DVD	<ul style="list-style-type: none"> Discs such as movies that can be purchased or rented. Movie mode and finalized only Supports the dual layer disc also
		AVCHD	Finalized AVCHD format
		MOVIE MUSIC PHOTO	<ul style="list-style-type: none"> DVD±R/RW discs that contain Movie, Music or Photo files. ISO 9660+JOLIET, UDF and UDF Bridge format
DVD-RW (VR) (8 cm, 12 cm)		DVD	VR mode and finalized only
Audio CD (8 cm, 12 cm)		ACD	Audio CD
CD-R/RW (8 cm, 12 cm)		MOVIE MUSIC PHOTO	<ul style="list-style-type: none"> CD-R/RW discs that contain Movie, Music or Photo files. ISO 9660+JOLIET, UDF and UDF Bridge format
Note	-		Indicates special notes and operating features.
Caution	-		Indicates cautions for preventing possible damages from abuse.

Note

- Depending on the conditions of the recording equipment or the CD-R/RW (or DVD±R/RW) disc itself, some CD-R/RW (or DVD±R/RW) discs cannot be played on the unit.
- Depending on the recording software & the finalization, some recorded discs (CD-R/RW, DVD±R/RW, BD-R/RE) may not be playable.
- BD-R/RE, DVD±R/RW and CD-R/RW discs recorded using a personal computer or a DVD or CD Recorder may not play if the disc is damaged or dirty, or if there is dirt or condensation on the player's lens.
- If you record a disc using a personal computer, even if it is recorded in a compatible format, there are cases in which it may not play because of the settings of the application software used to create the disc. (Check with the software publisher for more detailed information.)
- This player requires discs and recordings to meet certain technical standards in order to achieve optimal playback quality.
- Pre-recorded DVDs are automatically set to these standards. There are many different types of recordable disc formats (including CD-R containing MP3 or WMA files) and these require certain pre-existing conditions to ensure compatible playback.
- Customers should note that permission is required in order to download MP3 / WMA files and music from the Internet. Our company has no right to grant such permission. Permission should always be sought from the copyright owner.
- You have to set the disc format option to [Mastered] in order to make the discs compatible with the LG players when formatting rewritable discs. When setting the option to Live System, you cannot use it on LG player. (Mastered/Live File System : Disc format system for windows Vista)

About the “⊘” Symbol Display

“⊘” may appear on your TV display during operation and indicates that the function explained in this owner's manual is not available on that specific media.

Compatibility Notes

- Because BD-ROM is a new format, certain disc, digital connection and other compatibility issues are possible. If you experience compatibility problems, please contact an authorized Customer Service Center.
- This unit allows you to enjoy functions such as picture-in-picture, secondary audio and Virtual packages, etc., with BD-ROM supporting BONUSVIEW (BD-ROM version 2 Profile 1 version 1.1). Secondary video and audio can be played from a disc compatible with the picture-in-picture function. For the playback method, refer to the instructions in the disc.
- Viewing high-definition content and up-converting standard DVD content may require a HDMI-capable input or HDCP-capable DVI input on your display device.
- Some BD-ROM and DVD discs may restrict the use of some operation commands or features.
- Dolby TrueHD, Dolby Digital Plus and DTS-HD are supported with maximum 5.1 channels if you use HDMI connection for the audio output of the unit.
- You can use a USB device to store some disc related information, including downloaded on-line content. The disc you are using will control how long this information is retained.

File compatibility

Movie files

File Location	File Extension	Codec Format	Audio Format	Subtitle
Disc, USB	“.avi”, “.divx”, “.mpg”, “.mpeg”, “.mkv”, “.mp4”, “.asf”, “.wmv”, “.m4v” (DRM free), “.vob”, “.3gp”	DIVX3.xx, DIVX4.xx, DIVX5.xx, DIVX6.xx (Standard playback only), XVID, MPEG1 SS, H.264/MPEG-4 AVC, MPEG2 PS, MPEG2 TS, VC-1 SM (WMV3)	Dolby Digital, DTS, MP3, WMA, AAC, AC3	SubRip (.srt / .txt), SAMI (.smi), SubStation Alpha (.ssa/.txt), MicroDVD (.sub/.txt), VobSub (.sub), SubViewer 1.0 (.sub), SubViewer 2.0 (.sub/.txt), TMLayer (.txt), DVD Subtitle System (.txt)
DLNA	“.avi”, “.divx”, “.mpg”, “.mpeg”, “.mkv”, “.mp4”, “.asf”, “.wmv”, “.m4v” (DRM free)	DIVX3.xx, DIVX4.xx, DIVX5.xx, DIVX6.xx, XVID, MPEG1 SS, H.264/MPEG-4 AVC, MPEG2 PS, MPEG2 TS, VC-1 SM (WMV3)	Dolby Digital, DTS, MP3, WMA, AAC, AC3	SubRip (.srt / .txt), SAMI (.smi), SubStation Alpha (.ssa/.txt), MicroDVD (.sub/.txt), SubViewer 1.0 (.sub), SubViewer 2.0 (.sub/.txt), TMLayer (.txt), DVD Subtitle System (.txt)

Music files

File Location	File Extension	Sampling Frequency	Bitrate	Note
Disc, USB	“.mp3”, “.wma”, “.wav”, “.m4a” (DRM free), “.flac”	within 32 - 48 kHz (WMA), within 16 - 48 kHz (MP3)	within 32 - 192 kbps (WMA), within 32 - 320 kbps (MP3)	Some wav files are not supported on this player.
DLNA	“.mp3”, “.wma”, “.wav”, “.m4a” (DRM free)	within 32 - 48 kHz (WMA), within 16 - 48 kHz (MP3)	within 32 - 192 kbps (WMA), within 32 - 320 kbps (MP3)	Some wav files are not supported on this player.

Photo files

File Location	File Extension	Recommended Size	Note
Disc, USB, DLNA	“.jpg”, “.jpeg”, “.png”, “.gif”	Less than 4,000 x 3,000 x 24 bit/pixel Less than 3,000 x 3,000 x 32 bit/pixel	Progressive and lossless compression photo image files are not supported.

Supplied bundle DLNA server for Macintosh edition has limitations in file compatibility, such as ASF, WMA and WMV.

! Note

- The file name is limited to 180 characters.
- Maximum files/folder: Less than 2 000 (total number of files and folders)
- Depending on the size and number of the files, it may take several minutes to read the contents on the media.
- File compatibility may differ depending on the server.
- Because the compatibility on DLNA server are tested on the bundle DLNA server (Nero MediaHome 4 Essentials Windows edition) environment, file requirements and playback functions may differ depending on media servers.
- Supplied bundle DLNA server for Macintosh edition has limitations in file compatibility, such as ASF, WMA and WMV.
- The file requirements on page 10 are not always compatible. There may have some restrictions by file features and media server's ability.
- Playing a movie subtitle files are only available on share folder of a PC or DLNA media server created by supplied Nero MediaHome 4 Essentials software on this player package.
- The files from removable media such as USB drive, DVD-drive etc. on your media server may not be shared properly.
- This unit cannot support the ID3 Tag embedded MP3 file.
- The total playback time of audio file indicated on the screen may not correct for VBR files.
- HD movie files contained on the CD/DVD or USB 1.0/1.1 may not played properly. Blu-ray Disc or USB 2.0 are recommended to play back HD movie files.
- This player supports H.264/MPEG-4 AVC profile Main, High at Level 4.1. For a file with higher level, the warning message will appear on the screen.
- This player does not support files that are recorded with GMC*¹ or Qpel*².

*1 GMC – Global Motion Compensation

*2 Qpel – Quarter pixel

! Note

- A “avi” file which is encoded “WMV 9 codec” is not supported.
- This player supports UTF-8 files even it contains Unicode subtitle contents. This player can not support the pure Unicode subtitle files.
- Depending on the types of file or ways of recording, it may not play back.
- A disc which was recorded by multi-session on normal PC is not supported on this player.
- To be playback a movie file, movie file name and Subtitle file name must be the same.
- If video codec is MPEG2 TS or MPEG2 PS, subtitle does not play back.
- The total playback time of music file indicated on the screen may not correct for VBR files.

AVCHD (Advanced Video Codec High Definition)

- This player can playback AVCHD format discs. These discs are normally recorded and used in camcorders.
- The AVCHD format is a high definition digital video camera format.
- The MPEG-4 AVC/H.264 format is capable of compressing images at higher efficiency than that of the conventional image compressing format.
- This player can playback AVCHD discs using “x.v.Color” format.
- Some AVCHD format discs may not play depending on the recording condition.
- AVCHD format discs need to be finalized.
- “x.v.Color” offers a wider color range than normal DVD camcorder discs.

About DLNA

This Player is a DLNA Certified digital media player that can display and play movie, photo and music content from your DLNA-compatible digital media server (PC and Consumer Electronics).

The Digital Living Network Alliance (DLNA) is a cross-industry organization of consumer electronics, computing industry and mobile device companies. Digital Living provides consumers with easy sharing of digital media through your home network.

The DLNA certification logo makes it easy to find products that comply with the DLNA Interoperability Guidelines. This unit complies with DLNA Interoperability Guidelines v1.5.

When a PC running DLNA server software or other DLNA compatible device is connected to this player, some setting changes of software or other devices may be required. Please refer to the operating instructions for the software or device for more information.

Certain System Requirements

For high definition video playback:

- BD-ROM disc with high definition content.
- HDMI or HDCP capable DVI input on your display device is required for some content (as specified by disc authors).

Regional Code

This unit has a regional code printed on the rear of the unit. This unit can play only BD-ROM or DVD discs labeled same as the rear of the unit or "ALL".

System Select

You must select the appropriate system mode for your TV system. Open the disc tray using the ▲ (OPEN/CLOSE) button and then, press and hold ■ (PAUSE) for more than five seconds to be able to select a system (PAL, NTSC, AUTO)

Remote control

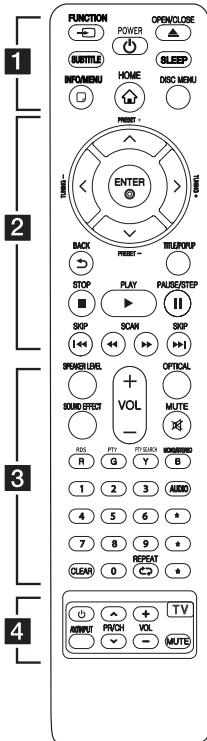

Battery Installation

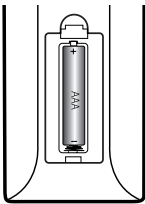

Remove the battery cover on the rear of the Remote Control, and insert R03 (size AAA) battery with \oplus and \ominus matched correctly.

..... **1**

FUNCTION: Changes input mode.
SUBTITLE: Selects a subtitle language.

⏻ (POWER): Switches the player ON or OFF.

⬆️ (OPEN/CLOSE): Ejects a disc.

SLEEP: Sets a certain period of time after which the unit will switch to off.

INFO/MENU (◻): Displays or exits On-Screen Display.

HOME (🏠): Displays or exits the [Home Menu].

DISC MENU: Accesses menu on a disc.

..... **2**

Direction buttons: Selects an option in the menu.

PRESET +/-: Selects programme of Radio.

TUNING +/-: Tunes in the desired radio station.

ENTER (⊙): Acknowledges menu selection.

BACK (⏪): Exits the menu or returns to the previous screen.

TITLE/POPUP: Displays the DVD title menu or BD-ROM's pop-up menu, if available.

■ (STOP): Stops playback.

▶️ (PLAY): Starts playback.

⏸️ (PAUSE/STEP): Pauses playback.

⏮️/⏭️ (SKIP): Goes to the next or previous chapter / track / file.

⏪/⏩ (SCAN): Searches backward or forward.

..... **3**

SPEAKER LEVEL: Sets the sound level of desired speaker.

SOUND EFFECT: Selects a sound effect mode.

VOL +/-: Adjusts speaker volume.

OPTICAL: Changes input mode to optical directly.

MUTE: Mute the unit.

Colored (R, G, Y, B) buttons:

- Use to navigate BD-ROM menus. They are also used for [MOVIE], [PHOTO], [MUSIC], [Premium] and [LG Apps] menu.

- B button: Selects mono/ stereo in FM mode.

RDS: Radio Data System.

PTY: Views the programme type of the RDS.

PTY SEARCH:

Searches programme type.

0-9 numerical buttons: Selects numbered options in a menu.

CLEAR: Removes a mark on the search menu or a number when setting the password.

REPEAT (↺): Repeats a desired section or sequence.

AUDIO: Selects an audio language or audio channel.

★ : Marked button is not available.

..... **4**

TV Control Buttons: See page 54.

Front panel

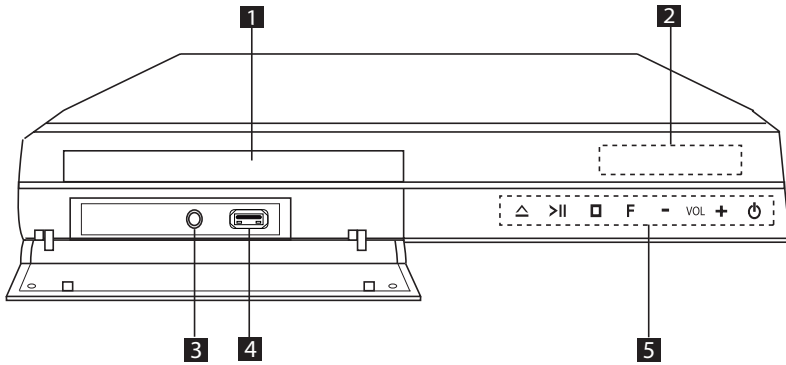

- 1** Disc tray
- 2** Display Window
- 3** PORT. IN
- 4** USB Port

- 5** Operation buttons
 - △ (Open / Close)
 - >|| (Play / Pause)
 - (Stop)
 - F (Function)
 - Changes the input source or function.
 - VOL -/+
 - ⏻ (Power)

Rear panel

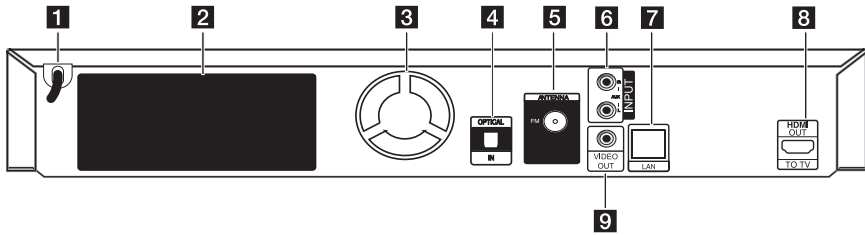

- | | |
|------------------------------|-------------------------|
| 1 AC power cord | 7 LAN port |
| 2 Speakers connectors | 8 HDMI OUT TO TV |
| 3 Cooling Fan | 9 VIDEO OUT |
| 4 OPTICAL IN | |
| 5 Antenna Connector | |
| 6 AUX (L/R) INPUT | |

Positioning the system

The following illustration shows an example of positioning the system. Note that the illustrations in these instructions differ from the actual unit for explanation purposes.

For the best possible surround sound, all the speakers other than the subwoofer should be placed at the same distance from the listening position (A).

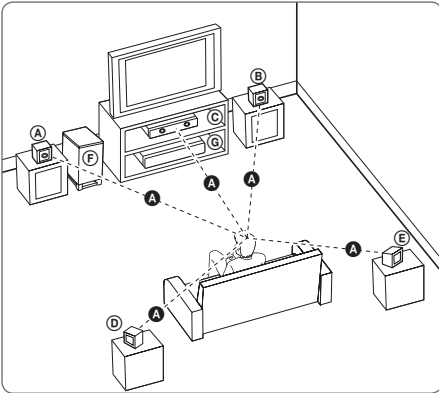

(A) Front left speaker (L)/

(B) Front right speaker (R):

Place the front speakers to the sides of the monitor or screen and as flush with the screen surface as possible.

(C) Center speaker:

Place the center speaker above or below the monitor or screen.

(D) Surround left speaker (L)/

(E) Surround right speaker (R):

Place these speakers behind your listening position, facing slightly inwards.

(F) Subwoofer:

The position of the subwoofer is not so critical, because low bass sounds are not highly directional. But it is better to place the subwoofer near the front speakers. Turn it slightly toward the center of the room to reduce the wall reflections.

(G) Unit

! Caution

- Be careful to make sure children not to put their hands or any objects into the *speaker duct.
*Speaker duct: A hole for plentiful bass sound on speaker cabinet (enclosure).
- Place the center speaker at a safe distance from the child's reach.
Otherwise it may result in the speaker falling down and causing personal injury and/or property damage.
- The speakers contain magnetic parts, so colour irregularity may occur on the CRT TV screen or PC monitor screen. Please use the speakers away from the TV screen or PC monitor screen.
- Before using the subwoofer, remove the protective vinyl.

Speaker Connection

Attaching the speakers to the player

1. Connect speaker wires to the player.
Each speaker wire is color-coded. Use matching color wires for corresponding speakers.

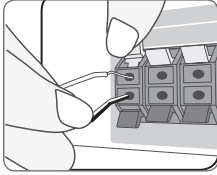

Color	Speaker	Position
Grey	Rear	Rear right
Blue	Rear	Rear left
Green	Center	Center
Orange	Sub woofer	Any front position
Red	Front	Front right
White	Front	Front left

2. Connect the speaker wire to the terminal on the speaker.
Connect the black stripe of each wire to the terminals marked - (minus) and the other end to the terminals marked + (plus).

Connecting to Your TV

Make one of the following connections, depending on the capabilities of your existing equipment.

- HDMI connection (page 18)
- Video connection (page 20)

! Note

- Depending on your TV and other equipment you wish to connect, there are various ways you could connect the player. Use only one of the connections described in this manual.
- Please refer to the manuals of your TV, stereo system or other devices as necessary to make the best connections.
- Make sure the player is connected directly to the TV. Tune the TV to the correct video input channel.
- Do not connect your player via your VCR. The image could be distorted by the copy protection system.

HDMI Connection

If you have a HDMI TV or monitor, you can connect it to this player using a HDMI cable (Type A, High speed HDMI™ cable with Ethernet). Connect the HDMI jack on the player to the HDMI jack on a HDMI compatible TV or monitor.

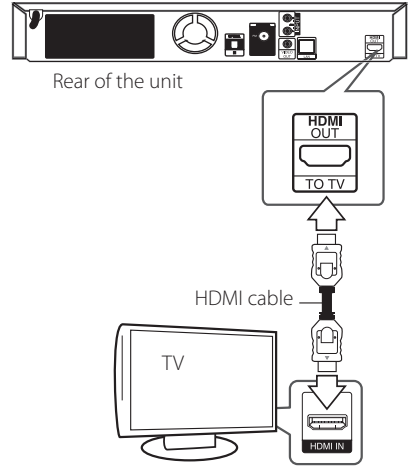

Set the TV's source to HDMI (refer to TV's Owner's manual).

Additional Information for HDMI

- When you connect a HDMI or DVI compatible device make sure of the following:
 - Try switching off the HDMI/DVI device and this player. Next, switch on the HDMI/DVI device and leave it for around 30 seconds, then switch on this player.
 - The connected device's video input is set correctly for this unit.
 - The connected device is compatible with 720x576p, 1280x720p, 1920x1080i or 1920x1080p video input.
- Not all HDCP-compatible HDMI or DVI devices will work with this player.
 - The picture will not be displayed properly with non-HDCP device.

! Note

- If a connected HDMI device does not accept the audio output of the player, the HDMI device's audio sound may be distorted or may not output.
- When you use HDMI connection, you can change the resolution for the HDMI output. (Refer to "Resolution Setting" on page 20.)
- Select the type of video output from the HDMI OUT jack using [HDMI Color Setting] option on the [Setup] menu (see page 31).
- Changing the resolution when the connection has already been established may result in malfunctions. To solve the problem, turn off the player and then turn it on again.
- When the HDMI connection with HDCP is not verified, TV screen is changed to black screen. In this case, check the HDMI connection, or disconnect the HDMI cable.
- If there are noises or lines on the screen, please check the HDMI cable (length is generally limited to 4.5 m(15 ft)).

What is SIMPLINK?

Some functions of this unit are controlled by the TV's remote control when this unit and LG TV's with SIMPLINK are connected through HDMI connection.

Controllable functions by LG TV's remote control; Play, Pause, Scan, Skip, Stop, Power Off, etc.

Refer to the TV owner's manual for the details of SIMPLINK function.

LG TV's with SIMPLINK function has the logo as shown above.

! Note

Depending on the disc type or playing status, some SIMPLINK operation may differ from your purpose or not work.

Video Connection

Connect the VIDEO OUT jack on the player to the video in jack on the TV using a video cable. You can hear the sound through the system's speakers.

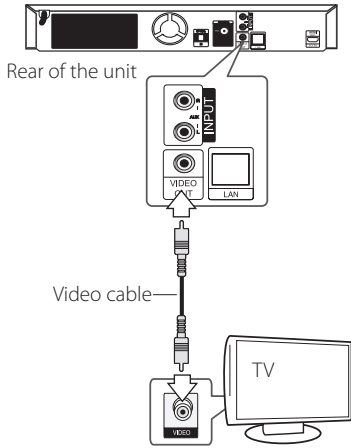

Resolution Setting

The player provides several output resolutions for HDMI OUT jack. You can change the resolution using [Setup] menu.

1. Press HOME (🏠).
2. Use </> to select the [Setup] and press ENTER (⏻). The [Setup] menu appears.
3. Use ^/v to select [DISPLAY] option then press > to move to the second level.
4. Use ^/v to select the [Resolution] option then press ENTER (⏻) to move to the third level.

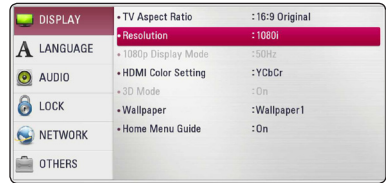

5. Use ^/v to select the desired resolution then press ENTER (⏻) to confirm your selection.



! Note

- If your TV does not accept the resolution you have set on the player, you can set resolution to 576p as follows:
 1. Press ▲ to open the disc tray.
 2. Press ■ (STOP) for more than 5 seconds.
- When you set the resolution to 576i with HDMI connection, actual resolution is outputted to 576p.
- If you select a resolution manually and then connect the HDMI jack to TV and your TV does not accept it, the resolution setting is set to [Auto].
- If you select a resolution that your TV does not accept, the warning message will appear. After resolution change, if you cannot see the screen, please wait 20 seconds and the resolution will automatically revert back to the previous resolution.
- The 1080p video output frame rate may be automatically set to either 24 Hz or 50 Hz depending both on the capability and preference of the connected TV and based on the native video frame rate of the content on the BD-ROM disc.
- The resolution of the VIDEO OUT jack is always outputted at 576i resolution.

Antenna connection

Connect the supplied antenna for listening to the radio.

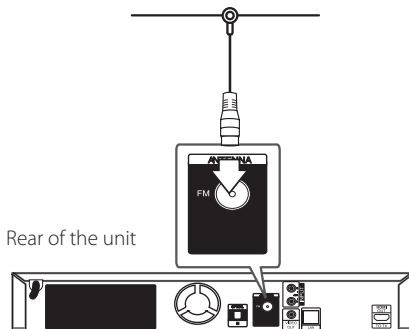

! Note

After connecting the FM wire antenna, keep it as horizontal as possible. Be sure to fully extend the FM wire antenna.

Connections with external device

AUX Connection

You can enjoy the sound from an external component through the speakers of this system.

Connect the analog audio output jacks of your component into the AUX L/R (INPUT) on this unit. And then select the [AUX] option by pressing FUNCTION and ENTER (⊙).

You can also use the F (Function) button on the front panel to select the input mode.



Rear of the unit

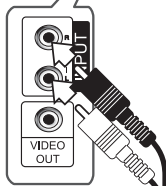

Red

White

To the audio output jacks of your component (TV, VCR, etc.)

PORT. IN connection

You can enjoy the sound from your portable audio player through the speakers of this system.

Connect the headphones (or line out) jack of the portable audio player into the PORT. IN socket of this unit. And then select the [PORTABLE] option by pressing FUNCTION and ENTER (⊙).

You can also use the F (Function) button on the front panel to select the input mode.

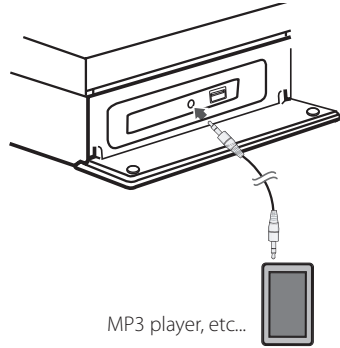

MP3 player, etc...

OPTICAL IN connection

You can enjoy the sound from your component with a digital optical connection through the speakers of this system.

Connect the optical output jack of your component into the OPTICAL IN jack on the unit. And then select the [OPTICAL] option by pressing FUNCTION and ENTER (●). Or press OPTICAL to select directly.

You can also use the F (Function) button on the front panel to select the input mode.

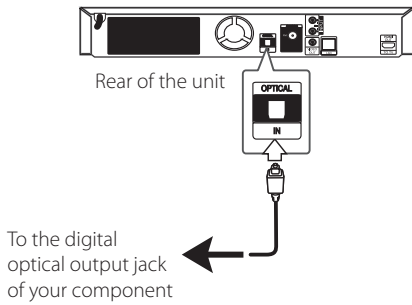

Connecting to your Home Network

This player can be connected to a local area network (LAN) via the LAN port on the rear panel. By connecting the unit to a broadband home network, you have access to services such as software updates, BD-LIVE interactivity and on-line content services.

Wired network connection

Using a wired network provides the best performance, because the attached devices connect directly to the network and are not subject to radio frequency interference.

Please refer to the documentation for your network device for further instructions.

Connect the player's LAN port to the corresponding port on your Modem or Router using a commercially available LAN or Ethernet cable.

Note

- When plugging or unplugging the LAN cable, hold the plug portion of the cable. When unplugging, do not pull on the LAN cable but unplug while pressing down on the lock.
- Do not connect a modular phone cable to the LAN port.
- Since there are various connection configurations, please follow the specifications of your telecommunication carrier or internet service provider.
- If you want to access content from DLNA servers, this player must be connected to the same local area network with them via a router.
- To set your PC as a DLNA server, install the supplied Nero MediaHome 4 on your PC. (see page 57)

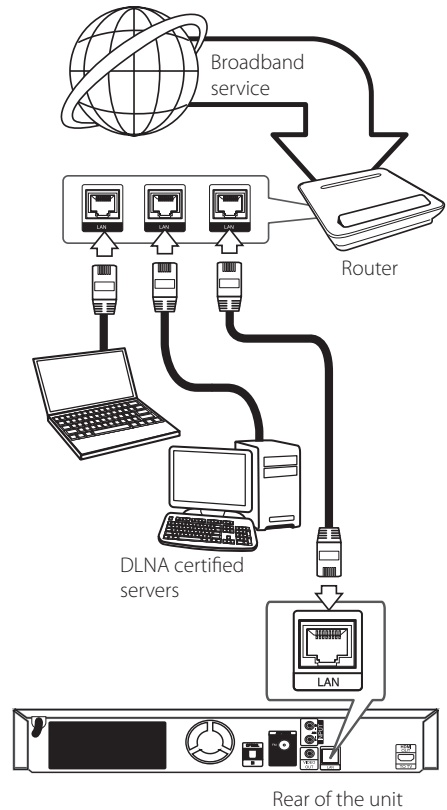

Wired Network Setup

If there is a DHCP server on the local area network (LAN) via wired connection, this player will automatically be allocated an IP address. After making the physical connection, a small number of home networks may require the player's network setting to be adjusted. Adjust the [NETWORK] setting as follow.

Preparation

Before setting the wired network, you need to connect the broadband internet to your home network.

1. Select [Connection Setting] option in the [Setup] menu then press ENTER (⊙).

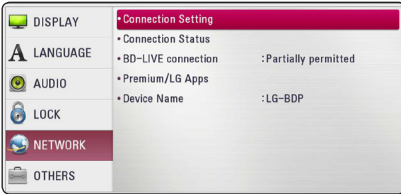

2. Read the preparations for the network settings and then press ENTER (⊙) while [Start] is highlighted.



Network will automatically be connected to the unit.



Advanced Setting

If you want to set the network settings manually, use \wedge/\vee to select [Advanced Setting] on the [Network Setting] menu and press ENTER (⊙).

1. Use $\wedge/\vee/</>$ to select the IP mode between [Dynamic] and [Static].

Normally, select [Dynamic] to allocate an IP address automatically.



Note

If there is no DHCP server on the network and you want to set the IP address manually, select [Static] then set [IP Address], [Subnet Mask], [Gateway] and [DNS Server] using $\wedge/\vee/</>$ and numerical buttons. If you make a mistake while entering a number, press CLEAR to clear the highlighted part.

2. Select [Next] and press ENTER (⊙) to apply network settings.



Network connection status is displayed on the screen.

3. Press ENTER (⊙) while [Close] is highlighted to finish the wired network settings.

Notes on Network Connection:

- Many network connection problems during set up can often be fixed by re-setting the router or modem. After connecting the player to the home network, quickly power off and/or disconnect the power cable of the home network router or cable modem. Then power on and/or connect the power cable again.
- Depending on the internet service provider (ISP), the number of devices that can receive internet service may be limited by the applicable terms of service. For details, contact your ISP.
- Our company is not responsible for any malfunction of the player and/or the internet connection feature due to communication errors/malfunctions associated with your broadband internet connection, or other connected equipment.
- The features of BD-ROM discs made available through the Internet Connection feature are not created or provided by our company, and our company is not responsible for their functionality or continued availability. Some disc related material available by the Internet Connection may not be compatible with this player. If you have questions about such content, please contact the producer of the disc.
- Some internet contents may require a higher bandwidth connection.
- Even if the player is properly connected and configured, some internet contents may not operate properly because of internet congestion, the quality or bandwidth of your internet service, or problems at the provider of the content.
- Some internet connection operations may not be possible due to certain restrictions set by the Internet service provider (ISP) supplying your broadband Internet connection.
- Any fees charged by an ISP including, without limitation, connection charges are your responsibility.
- A 10 Base-T or 100 Base-TX LAN port is required for wired connection to this player. If your internet service does not allow for such a connection, you will not be able to connect the player.
- You must use a Router to use xDSL service.
- A DSL modem is required to use DSL service and a cable modem is required to use cable modem service. Depending on the access method of and subscriber agreement with your ISP, you may not be able to use the internet connection feature contained in this player or you may be limited to the number of devices you can connect at the same time. (If your ISP limits subscription to one device, this player may not be allowed to connect when a PC is already connected.)
- The use of a "Router" may not be allowed or its usage may be limited depending on the policies and restrictions of your ISP. For details, contact your ISP directly.

USB device connection

This player can play movie, music and photo files contained in the USB device.

Playback content in the USB device

1. Insert a USB device to the USB port until it fits into place.

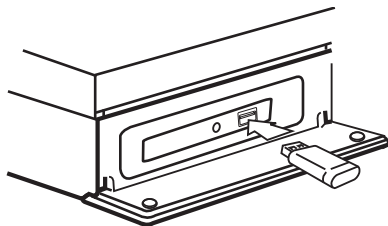

When you connect the USB device on the HOME menu, the player plays only music file contained in the USB storage device automatically. If the USB storage device is containing various types of files, a menu for the file type selection will appear.

File loading may takes few minutes depending on the number of content stored in the USB storage device. Press ENTER (⊙) while [Cancel] is selected to stop loading.

2. Press HOME (🏠).
3. Select [Movie], [Photo] or [Music] using </>, and press ENTER (⊙).
4. Select the [USB] option using ^/v, and press ENTER (⊙).

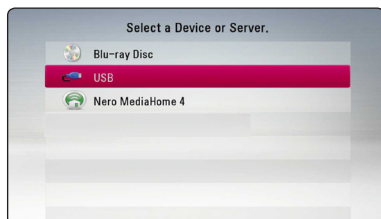

5. Select a file using ^/v/</>, and press PLAY or ENTER (⊙) to play the file.
6. Withdraw the USB device carefully.

! Note

- This player supports USB flash drive/ external HDD formatted in FAT16, FAT32 and NTFS when accessing files (music, photo, movie). However, for BD-Live and Audio CD recording, only FAT16 and FAT32 formats are supported. Use the USB flash drive/external HDD formatted in either FAT16 or FAT32 when using BD-Live.
- The USB device can be used for the local storage for enjoying BD-LIVE discs with Internet.
- This unit can support up to 4 partitions of the USB device.
- Do not extract the USB device during operation (play, etc.).
- A USB device which requires additional program installation when you have connected it to a computer, is not supported.
- USB device: USB device that supports USB1.1 and USB2.0.
- Movie, music and photo files can be played. For details of operations on each file, refer to relevant pages.
- Regular back up is recommended to prevent data loss.
- If you use a USB extension cable, USB HUB or USB Multi-reader, the USB device may not be recognized.
- Some USB device may not work with this unit.
- Digital camera and mobile phone are not supported.
- USB Port of the unit cannot be connected to PC. The unit cannot be used as a storage device.

Settings

Initial Setup

When you turn on the unit for the first time, the initial setup wizard appears on the screen. Set the display language, network settings and speaker setup on the initial setup wizard.

1. Press **⏻** (POWER).

The initial setup wizard appears on the screen.

2. Use **^**/**v**/**<**/**>** to select a display language and press **ENTER** (**⊙**).



3. Read and prepare the preparations for the network settings and then press **ENTER** (**⊙**) while [Start] is highlighted.



If wired network is connected, the network connection setting will automatically be finished.



4. Select [Next] and press **ENTER** (**⊙**).
5. Press **ENTER** (**⊙**) to verify the test tone signals of the speakers.



After verifying the test tone signals, press **ENTER** (**⊙**) while [Stop] is highlighted. Select [Next] and press **ENTER** (**⊙**).

6. Check all the settings that you have set in the previous steps.

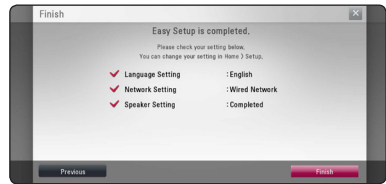

Press **ENTER** (**⊙**) while [Finish] is highlighted to finish the initial setup settings. If there is any settings to be changed, use **<**/**>** to select [Previous] and press **ENTER** (**⊙**).

Adjust the Setup Settings

You can change the settings of the player in the [Setup] menu.

1. Press HOME (🏠).



2. Use </> to select the [Setup] and press ENTER (⊙). The [Setup] menu appears.



3. Use ^/v to select the first setup option, and press > to move to the second level.



4. Use ^/v to select a second setup option, and press ENTER (⊙) to move to the third level.



5. Use ^/v to select a desired setting, and press ENTER (⊙) to confirm your selection.

[DISPLAY] Menu

TV Aspect Ratio

Select a TV aspect ratio option according to your TV type.

[4:3 Letter Box]

Select when a standard 4:3 TV is connected. Displays theatrical images with masking bars above and below the picture.

[4:3 Pan Scan]

Select when a standard 4:3 TV is connected. Displays pictures cropped to fill your TV screen. Both sides of the picture are cut off.

[16:9 Original]

Select when a 16:9 wide TV is connected. The 4:3 picture is displayed with an original 4:3 aspect ratio, with black bars appearing at the left and right sides.

[16:9 Full]

Select when a 16:9 wide TV is connected. The 4:3 picture is adjusted horizontally (in a linear proportion) to fill the entire screen.

! Note

You cannot select [4:3 Letter Box] and [4:3 Pan Scan] option when the resolution is set to higher than 720p.

Resolution

Sets the output resolution of the HDMI video signal. Refer to page 20 for details about the resolution setting.

[Auto]

If the HDMI OUT jack is connected to TVs providing display information (EDID), automatically selects the resolution best suited to the connected TV.

[1080p]

Outputs 1080 lines of progressive video.

[1080i]

Outputs 1080 lines of interlaced video.

[720p]

Outputs 720 lines of progressive video.

[576p]

Outputs 576 lines of progressive video.

[576i]

Outputs 576 lines of interlaced video.

1080p Display Mode

When the resolution is set to 1080p, select [24 Hz] for smooth presentation of film material (1080p/24 Hz) with a HDMI-equipped display compatible with 1080p/24 Hz input.

! Note

- When you select [24 Hz], you may experience some picture disturbance when the video switches video and film material. In this case, select [50 Hz].
- Even when [1080p Display Mode] is set to [24 Hz], if your TV is not compatible with 1080p/24 Hz, the actual frame frequency of the video output will be 50 Hz to match the video source format.

HDMI Color Setting

Select the type of output from the HDMI OUT jack. For this setting, please refer to the manuals of your display device.

[YCbCr]

Select when connecting to a HDMI display device.

[RGB]

Select when connecting to a DVI display device.

3D Mode

Select the type of output mode for Blu-ray 3D disc playback.

[Off]

Blu-ray 3D disc playback will output as 2D mode like a normal BD-ROM disc playback.

[On]

Blu-ray 3D disc playback will output as 3D mode.

Wallpaper

Changes the background of the initial screen.

Home Menu Guide

This function allows you to display or delete the guide bubble on the Home Menu. Set this option to [On] for displaying guide.

[LANGUAGE] Menu

Display Menu

Select a language for the [Setup] menu and on-screen display.

Disc Menu/Disc Audio/ Disc Subtitle

Select the language you prefer for the audio track (disc audio), subtitles, and the disc menu.

[Original]

Refers to the original language in which the disc was recorded.

[Other]

Press ENTER (⏻) to select another language. Use number buttons then press ENTER (⏻) to enter the corresponding 4-digit number according to the language code list on page 60.

[Off] (Disc Subtitle only)

Turn off Subtitle.

Note

Depending on the disc, your language setting may not work.

[AUDIO] Menu

Each disc has a variety of audio output options. Set the player's Audio options according to the type of audio system you use.

! Note

Since many factors affect the type of audio output, see "Audio Output Specifications" on page 63 for details.

Digital Output

[PCM Stereo] (HDMI only)

Select if you connect this unit's HDMI OUT jack to a device with two-channel digital stereo decoder.

[PCM Multi-Ch] (HDMI only)

Select if you connect this unit's HDMI OUT jack to a device with multi-channel digital decoder.

[DTS Re-Encode] (HDMI only)

Select if you connect this unit's HDMI OUT jack to a device with DTS decoder.

[BitStream] (HDMI only)

Select if you connect this unit's HDMI OUT jack to a device with LPCM, Dolby Digital, Dolby Digital Plus, Dolby TrueHD, DTS and DTS-HD decoder.

! Note

- When [Digital Output] option is set to [PCM Multi-Ch], the audio may output as PCM Stereo if the PCM Multi-Ch information is not detected from HDMI device with EDID.
- If the [Digital Output] option is set to [DTS Re-Encode], the DTS Re-Encode audio is outputted for BD-ROM discs with secondary audio and the original audio is outputted for the other discs (like [BitStream]).
- This setting is not available on the input signal from an external device.

Speaker Setup

To obtain the best possible sound, use the speaker setup display to specify the volume of the speakers you have connected and their distance from your listening position. Use the test to adjust the volume of the speakers to the same level.

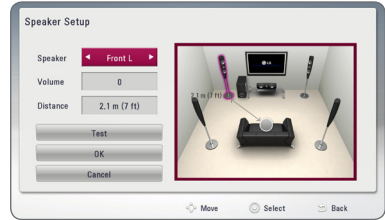

[Speaker]

Select a speaker that you want to adjust.

[Volume]

Adjust the output level of each speaker.

[Distance]

Adjust the distance between each speaker and the listening position.

[Test/ Stop test tone]

The speakers will emit a test tone.

[OK]

Confirms the setting.

[Cancel]

Cancels the setting.

HD AV Sync

Sometimes Digital TV encounters a delay between picture and sound. If this happens you can compensate by setting a delay on the sound so that it effectively 'waits' for the picture to arrive: this is called HD AV Sync. Use **▲ ▼** to scroll up and down through the delay amount, which you can set at anything between 0 and 300 ms.

DRC (Dynamic Range Control)

This function allows you to listen to a movie at a lower volume without losing clarity of sound.

[Off]

Turns off this function.

[On]

Compress the dynamic range of the Dolby Digital, Dolby Digital Plus or Dolby TrueHD audio output.

[Auto]

The dynamic range of the Dolby TrueHD audio output is specified by itself.
And the dynamic range of the Dolby Digital and Dolby Digital Plus are operated as same as the [On] mode.



Note

The DRC setting can be changed only when a disc is not inserted or the unit is in complete stop mode.

[LOCK] Menu

The [LOCK] settings affect only BD-ROM and DVD playback.

To access the any features in [LOCK] settings, you must enter the 4-digit security code you have created.

If you have not entered a password yet, you are prompted to do so. Enter a 4-digit password twice, and press ENTER (Ⓞ) to create a new password.

Password

You can create or change the password.

[None]

Enter a 4-digit password twice, and press ENTER (Ⓞ) to create a new password.

[Change]

Enter the current password and press ENTER (Ⓞ). Enter a 4-digit password twice, and press ENTER (Ⓞ) to create a new password.

If you forget your password

If you forget your password, you can clear it using the following steps:

1. Remove any disc that might be in the player.
2. Select [Password] option in the [Setup] menu.
3. Use Number buttons to enter "210499". The password is cleared.

! Note

If you make a mistake before pressing ENTER (Ⓞ), press CLEAR. Then input the correct password.

DVD Rating

Blocks playback of rated DVD based on their content. (Not all discs are rated.)

[Rating 1-8]

Rating one (1) has the most restrictions and rating eight (8) is the least restrictive.

[Unlock]

If you select [Unlock], parental control is not active and the disc plays in full.

Blu-ray Disc Rating

Set an age limit of BD-ROM play. Use number buttons to input an age limit for BD-ROM viewing.

[255]

All BD-ROM can be played.

[0-254]

Prohibits play of BD-ROM with corresponding ratings recorded on them.

Area Code

Enter the code of the area whose standards were used to rate the DVD video disc, based on the list on page 59.

[NETWORK] Menu

The [NETWORK] settings are needed to use the software update, BD Live and on-line content services.

Connection Setting

If your home network environment is ready to connect the player, the player needs to be set the wired for network communication. (See "Connecting to your Home Network" on page 24.)

Connection Status

If you want to check the network status on this player, select the [Connection Status] options and press ENTER (⊙) to check whether a connection to the network and the internet have been established.

BD-LIVE connection

You can restrict Internet access when BD-LIVE functions are used.

[Permitted]

Internet access is permitted for all BD-LIVE contents.

[Partially permitted]

Internet access is permitted only for BD-LIVE contents which have content owner certificates. Internet access and AACIS Online functions are prohibited for all BD-LIVE contents without a certificate.

[Prohibited]

Internet access is prohibited for all BD-LIVE contents.

Premium/LG Apps

[Country Setting]

Select your area for displaying proper services and contents on the [Premium] and [LG Apps] feature.

Device Name

You can make a network name using virtual keyboard. This player will be recognised by the name you are entering on your home network.

[OTHERS] Menu

DivX VOD

ABOUT DIVX VIDEO: DivX® is a digital video format created by DivX, LLC, a subsidiary of Rovi Corporation. This is an official DivX Certified® device that plays DivX video. Visit divx.com for more information and software tools to convert your files into DivX videos.

ABOUT DIVX VIDEO-ON-DEMAND: This DivX Certified® device must be registered in order to play purchased DivX Video-on-Demand (VOD) movies. To obtain your registration code, locate the DivX VOD section in your device setup menu. Go to vod.divx.com for more information on how to complete your registration.

[Register]

Displays the registration code of your player.

[Deregister]

Deactivate your player and display the deactivation code.

! Note

All the downloaded videos from DivX(R) VOD with this player's registration code can only be played on this unit.

Network Play

This function allows you to control the playback of media streamed from DLNA media server by a DLNA certified smartphone. Most DLNA certified smartphone has a function to control the playback media on your home network. Set this option to [On] for allowing your smartphone to control this unit. Refer to instructions of your DLNA certified smartphone or the application for more detailed information.

! Note

- This unit and the DLNA Certified Smartphone must be connected to the same network.
- To use the [Network Play] function using a DLNA certified smartphone, press HOME (🏠) to display the home menu before connecting to this unit.
- While controlling the unit using the [Network Play] function, the remote control may not work.
- Available file formats described on page 10 are not always supported on [Network Play] function.

Auto Power Off

The screen saver appears when you leave the player in Stop mode for about five minutes. If you set this option to [On], the unit automatically turns off within 20 minutes since the Screen Saver is displayed. Set this option to [Off] to leave the screen saver until the unit is operated by the user.

! Note

Depending on the function, this function may not be available.

Initialize

[Factory Set]

You can reset the player to its original factory settings.

[Blu-ray Storage Clear]

Initializes the BD-Live contents from the connected USB storage.

! Note

If you reset the player to its original factory settings using [Factory Set] option, you have to set all the activation for the on-line services and network settings again.

Software

[Information]

Displays the current software version.

[Update]

You can update the software by connecting the unit directly to the software update server (see page 55).

Disclaimer Notice

Press ENTER (⊙) to view the notice of Network Service Disclaimer.

Sound Effect

You can select a suitable sound mode. Press SOUND EFFECT repeatedly until the desired mode appears on the front panel display or the TV screen. The displayed items for the equalizer maybe different depending on sound sources and effects.

[Natural Plus]: You can enjoy the natural sound effect same as 5.1 channel.

[Natural]: You can enjoy comfortable and natural sound.

[Bypass]: Software with multichannel surround audio signals is played according to the way it was recorded.

[Bass Blast]: Reinforce the bass sound effect from front left and right speaker and subwoofer.

[Loudness]: Improves bass and treble sound.

[User EQ]: You can adjust the sound by raising or lowering the level of specific frequency.

Setting the [User EQ]



1. Use \wedge / \vee to select the desired frequency.
2. Use $< / >$ to select the desired level.

Select [Cancel] option then press ENTER (⊙) to cancel the setting.

Select [Reset] option then press ENTER (⊙) to reset the all adjustments.

General Playback

Using [HOME] menu

The home menu appears when you press HOME (⏠). Use $\wedge/\vee/⟷/⟩$ to select a category and press ENTER (⏏).

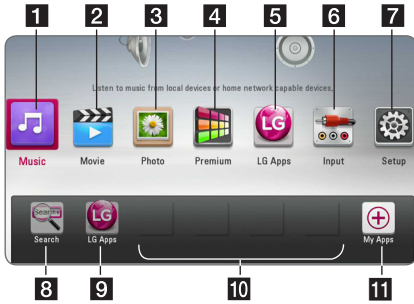

! Note

Depending on the region, [LG Apps] service and [Search] function may not be available at the moment. The service may become available in these regions through at software update later.

1	[Music] - Plays audio contents.
2	[Movie] - Plays video contents.
3	[Photo] - Plays photo contents.
4	[Premium] - Displays the Premium Home screen.
5	[LG Apps] - Displays the [LG Apps] screen.
6	[Input] - Changes input mode.
7	[Setup] - Adjusts the system settings.
8	[Search] - Searching an on-line content by inputting a keyword on the search menu.
9	[LG Apps] - Displays the [LG Apps] screen.
10	[Favorite Apps] - Shortcut for user's favorite Apps.
11	[My Apps] - Displays the My Apps screen.

Playing a Disc

BD DVD AVCHD ACD

1. Press \blacktriangle (OPEN/CLOSE), and place a disc on the disc tray.
2. Press \blacktriangle (OPEN/CLOSE) to close the disc tray.
For the most Audio CD, BD-ROM and DVD-ROM discs, playback starts automatically.
3. Press HOME (⏠).
4. Select [Movie] or [Music] using $\langle/⟩$, and press ENTER (⏏).
5. Select [Blu-ray Disc], [DVD], [VR] or [Audio] option using \wedge/\vee , and press ENTER (⏏).

! Note

- Playback functions described in this manual are not always available in every files and media. Some functions can be restricted depending on many factors.
- Depending on the BD-ROM titles, a USB device connection may be needed for the proper playback.
- Unfinalized DVD VR format discs may not be played in this player.
- Some DVD-VR discs are made with CPRM data by DVD RECORDER. This unit cannot support these kinds of discs.

Playing a file on a disc/USB device

MOVIE MUSIC PHOTO

This player can play movie, music and photo files contained in the disc or USB device.

1. Insert a data disc on the tray or connect a USB device.
The unit plays only music file contained in the USB storage device or disc automatically.
2. Press HOME (⏠).
3. Select [Movie], [Photo] or [Music] using $\langle/⟩$, and press ENTER (⏏).
4. Select [Data] or [USB] option using \wedge/\vee , and press ENTER (⏏).
5. Select a file using $\wedge/\vee/⟷/⟩$, and press \blacktriangleright (PLAY) or ENTER (⏏) to play the file.

Playing Blu-ray 3D disc

BD

This player can play the Blu-ray 3D discs which contains separate views for the left and right eyes.

Preparation

In order to playback Blu-ray 3D title in stereoscopic 3D mode, you need to:

- Check your TV is 3D capable and has HDMI input(s).
- Wear 3D glasses to enjoy the 3D experience if it is necessary.
- Check whether the BD-ROM title is the Blu-ray 3D disc or not.
- Connect an HDMI cable (High Speed HDMI™ Cable with Ethernet) between the player's HDMI output and TV's HDMI input.

1. Press HOME (⏠), and set the [3D Mode] option on the [Setup] menu to [On] (page 31).
2. Press ▲ (OPEN/CLOSE), and place a disc on the disc tray.
3. Press ▲ (OPEN/CLOSE) to close the disc tray. The playback starts automatically.
4. Refer to the owner's manual of your 3D-ready TV for the further instruction.

You may need to adjust the display settings and focus on your TV's setting for the improved 3D effect.

! Caution

- Watching a 3D content for a long period time may cause dizziness or tiredness.
- It is not recommended to watch a movie in 3D mode for infirm, child and pregnant woman.
- If you are experiencing headache, tiredness or dizziness while viewing contents in 3D, it is strongly recommended to stop the playback and rest until you feel normal.

Enjoying BD-Live™

BD

BD-ROM supporting BD-Live that has a network extension function allows you to enjoy more functions such as downloading new movie trailers by connecting this unit to the internet.

1. Check the network connection and settings (page 24).
2. Insert a USB storage device to the USB port on the front panel.
A USB storage device is needed to download bonus content.
3. Press HOME (⏠), and set the [BD-LIVE connection] option on the [Setup] menu (page 35).

Depending on a disc, the BD-Live function may not be operated if [BD-LIVE connection] option is set to [Partially Permitted].

4. Insert a BD-ROM with BD-Live.

The operations are differ depending on the disc. Refer to the manual supplied with the disc.

! Caution

Do not extract the connected USB device while content is being downloaded or a Blu-ray disc is still in the disc tray. Doing so may damage the connected USB device and BD-Live features may not operate properly with the damaged USB device anymore. If the connected USB device seems damaged from such an action, you can format the connected USB device from the PC and reuse it with this player.

! Note

- Some BD-Live contents may be restrictively accessed in some territories by contents provider's own decision.
- It may take up to several minutes to load and start enjoying BD-Live contents.

Playing a file on a network server

MOVIE MUSIC PHOTO

This player can play video, audio and photo files located in a DLNA server through your home network.

1. Check the network connection and settings (page 24).
2. Press HOME (🏠).
3. Select [Movie], [Photo] or [Music] using </>, and press ENTER (⊙).
4. Select a DLNA media server on the list using ^/v/</>, and press ENTER (⊙).

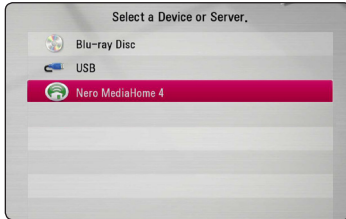

If you want to rescan available media server, press the green (G) colored button.

5. Select a file using ^/v/</>, and press ENTER (⊙) to play the file.

! Note

- The file requirements are described on page 10.
- The thumbnail of the unplayable files can be displayed, but those cannot be played on this player.
- The subtitle file name and movie file name have to be the same and located at the same folder.
- The playback and operating quality may be affected by your home network condition.
- You may experience connection problems depending on your server's environment.
- To set your PC as a DLNA server, install the supplied Nero MediaHome 4 on your PC. (see page 57)

Basic operations for video and audio content

To stop playback

Press ■ (STOP) while playback.

To pause playback

Press || (PAUSE) while playback.

Press ▶ (PLAY) to resume playback.

To play frame-by-frame (Video)

Press || (PAUSE) while movie playback.

Press || (PAUSE) repeatedly to play Frame-by-Frame playback.

To scan forward or backward

Press ◀◀ or ▶▶ to play fast forward or fast reverse during playback.

You can change the various playback speeds by pressing ◀◀ or ▶▶ repeatedly.

To slow down the playing speed

While the playback is paused, press ▶▶ repeatedly to play various speeds of slow motion.

To skip to the next/previous chapter/track/file

During playback, press ◀◀ or ▶▶ to go to the next chapter/track/file or to return to the beginning of the current chapter/track/file.

Press ◀◀ twice briefly to step back to the previous chapter/track/file.

In the file list menu of a server, there may have many types of contents in a folder together. In this case, press ◀◀ or ▶▶ to go to the previous or next content with same type.

Basic operations for photo content

To play a slide show

Press ► (PLAY) to start slide show.

To stop a slide show

Press ■ (STOP) while slide show.

To pause a slide show

Press || (PAUSE) while slide show.

Press ► (PLAY) to re-start the slide show.

To skip to the next/previous photo

While viewing a photo in full screen, press < or > to go to the previous or next photo.

Using the disc menu

BD DVD AVCHD

To display the disc menu

The menu screen may be displayed first after loading a disc which contains a menu. If you want to display the disc menu while playback, press DISC MENU.

Use ^/∨/ </> buttons to navigate through menu items.

To display the Pop-up menu

Some BD-ROM discs contain Pop-up menu that appears while playback.

Press TITLE/POPUP while playback, and use ^/∨/ </> buttons to navigate through menu items.

Resume playback

**BD DVD AVCHD MOVIE ACD
MUSIC**

The unit records the point where you pressed the ■ (STOP) depending on the disc.

If "||■ (Resume Stop)" appears on the screen briefly, press ► (PLAY) to resume playback (from the scene point).

If you press ■ (STOP) twice or unload the disc, "■ (Complete Stop)" appears on the screen. The unit will clear the stopped point.

! Note

- The resume point may be cleared when a button is pressed (for example; ⏻ (POWER), ⏪ (OPEN/CLOSE), etc).
- On BD-ROM discs with BD-J, the resume playback function does not work.
- If you press ■ (STOP) once during BD-ROM interactive title playback, the unit will be in Complete Stop mode .

Last Scene Memory

BD DVD

This unit memorizes the last scene from the last disc that is viewed. The last scene remains in memory even if you remove the disc from the unit or switch off the unit. If you load a disc that has the scene memorized, the scene is automatically recalled.

! Note

- Last Scene Memory function for a previous disc is erased once a different disc is played.
- This function may not work depending on the disc.
- On BD-ROM discs with BD-J, the last scene memory function does not work.
- This unit does not memorize settings of a disc if you switch off the unit before commencing to play it.

Advanced Playback

Repeat Playback

**BD DVD AVCHD ACD MUSIC
MOVIE**

During playback, press REPEAT (⏮) repeatedly to select a desired repeat mode.

Blu-ray Disc / DVD / Movie files

- 🔁 **A-** – Selected portion will be repeated continually.
- 🔁 **Chapter** – The current chapter will be played back repeatedly.
- 🔁 **Title** – The current title will be played back repeatedly.
- 🔁 **All** – All the tracks or files will be played back repeatedly.

To return to normal playback, press REPEAT (⏮) repeatedly to select [Off].

Audio CDs/Music files

- 🔁 **Track** – The current track or file will be played back repeatedly.
- 🔁 **All** – All the tracks or files will be played back repeatedly.
- 🔁 **X** – The tracks or files will be played back in random order.
- 🔁 **X All** – All the tracks or files will be played back repeatedly in random order.
- 🔁 **A-B** – Selected portion will be repeated continually. (Audio CD only)

To return to normal playback, press CLEAR.

! Note

- If you press ⏮ once during Repeat Chapter/Track playback, the repeat playback cancels.
- This function may not work on some disc or title.

Repeating a specific portion

BD DVD AVCHD ACD MOVIE

This player can repeat a portion you have selected.

1. While playback, press REPEAT (⏮) to select [A-] at the beginning of the portion you wish to repeat.
2. Press ENTER (⏹) at the end of the portion. Your selected portion will be repeated continually.
3. To return to normal playback, press REPEAT (⏮) repeatedly to select [Off].

! Note

- You cannot select a portion less than 3 seconds.
- This function may not work on some disc or title.

Viewing content information

MOVIE

The player can display the content information.

1. Select a file using $\wedge / \vee / < / >$.
2. Press INFO/MENU (ⓘ) to display the option menu.
3. Select the [Information] option using \wedge / \vee , and press ENTER (⏹).

The file information appears on the screen.

While movie playback, you can display the file information by pressing TITLE/POPUP.

! Note

The information displayed on the screen may not correct comparing actual content information.

Changing content list view

MOVIE MUSIC PHOTO

On the [Movie], [Music] or [Photo] menu, you can change the content list view.

Method 1

Press red (R) colored button repeatedly.

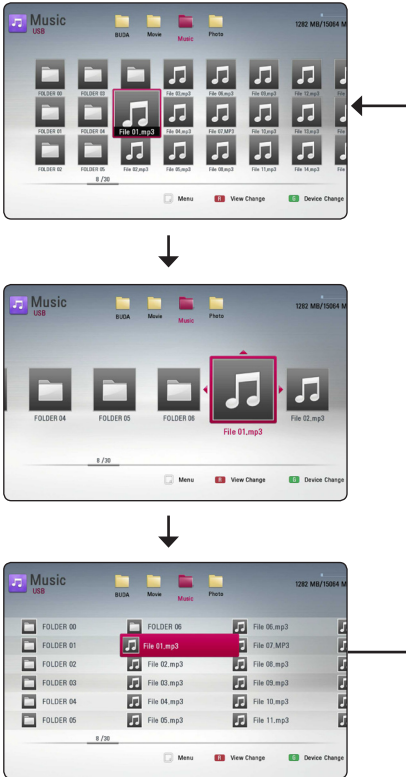

Method 2

1. On the content list, press INFO/MENU (⏏) to display the option menu.
2. Use \wedge / \vee to select the [View Change] option.
3. Press ENTER (⊙) to change the content list view.

Selecting a subtitle file

MOVIE

If the subtitle file name is different from the movie file name, you need to select the subtitle file on the [Movie] menu before playing the movie.

1. Use \wedge / \vee / \lt / \gt to select the subtitle file you wish to play in the [Movie] menu.
2. Press ENTER (⊙).

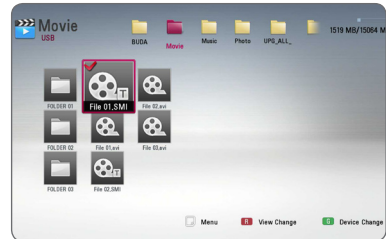

Press ENTER (⊙) again to deselect the subtitle file. Selected subtitle file will be displayed when you play the movie file.

Note

- If you press ■ (STOP) while playback, the subtitle selection is cancelled.
- This function is not available for playing file on a server via home network.

Options while viewing a photo

PHOTO

You can use various options during viewing a photo in full screen.

1. While viewing a photo in full screen, press INFO/MENU (ⓘ) to display the option menu.
2. Select an option using \wedge / \vee .



- 1 Current photo/Total number of photos** – Use \leftarrow / \rightarrow to view previous/next photo.
- 2 Slide Show** – Press ENTER (⊙) to start or pause slide show.
- 3 Music Select** – Select the background music for the slide show (page 44).
- 4 Music** – Press ENTER (⊙) to start or pause background music.
- 5 Rotate** – Press ENTER (⊙) to rotate the photo clockwise.
- 6 Zoom** – Press ENTER (⊙) to display the [Zoom] menu.
- 7 Effect** – Use \leftarrow / \rightarrow to select a transition effect between photos in a slide show.
- 8 Speed** – Use \leftarrow / \rightarrow to select a delaying speed between photos in a slide show.

3. Press BACK (⏪) to exit the option menu.

Listening to music while slide show

PHOTO

You can display photo files while listening to music files.

1. While viewing a photo in full screen, press INFO/MENU (ⓘ) to display the option menu.
2. Use \wedge / \vee to select [Music Select] option, and press ENTER (⊙) to display the [Music Select] menu.
3. Use \wedge / \vee to select a device, and press ENTER (⊙).

Device that you can select are differ depending on the location of the photo file you are displaying in full screen.

Photo location	Available Device
Disc, USB	Disc, USB
DLNA server	DLNA server

4. Use \wedge / \vee to select a file or a folder you wish to play.

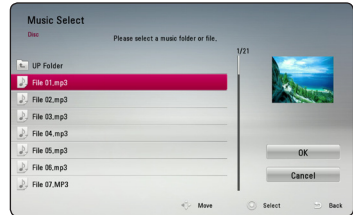

Select \leftarrow and press ENTER (⊙) to display the upper directory.

! Note

When selecting music file from a server, folder selection is not available. Only file selection is available.

5. Use \rightarrow to select [OK], and press ENTER (⊙) to complete music selection.

On-Screen display

You can display and adjust various information and settings about the content.

Displaying content information on-screen

BD DVD AVCHD MOVIE

1. While playback, press INFO/MENU (⏏) to show various playback information.



- 1 **Title** – current title number/total number of titles
- 2 **Chapter** – current chapter number/total number of chapters
- 3 **Time** – elapsed playing time/total playback time
- 4 **Audio** – selected audio language or channel
- 5 **Subtitle** – selected subtitle.
- 6 **Angle** – selected angle/total number of angles
- 7 **TV Aspect Ratio** – selected TV aspect Ratio
- 8 **Picture Mode** – selected picture mode

2. Select an option using \wedge/\vee .
3. Use $</>$ to adjust the selected option value.
4. Press BACK (⏏) to exit the On-Screen display.

! Note

- If no button is pressed for a few seconds, the on-screen display disappears.
- A title number cannot be selected on some discs.
- Available items may differ depending on discs or titles.
- If an interactive Blu-ray Disc is playing back, some setting information is displayed on the screen but prohibited to be changed.

Playing from selected time

BD DVD AVCHD MOVIE

1. Press INFO/MENU (□) during playback. The time search box shows the elapsed playing time.
2. Select the [Time] option and then input the required start time in hours, minutes, and seconds from left to right.

For example, to find a scene at 2 hours, 10 minutes, and 20 seconds, enter "21020".

Press </> to skip the playback 60 seconds forward or backward.

3. Press ENTER (⊙) to start playback from selected time.

! Note

- This function may not work on some disc or titles.
- This function may not work depending on the file type and ability of the DLNA server.

Selecting a subtitle language

BD DVD AVCHD MOVIE

1. During playback, press INFO/MENU (□) to display the On-Screen display.
2. Use \wedge / \vee to select the [Subtitle] option.
3. Use </> to select desired subtitle language.
4. Press BACK (↶) to exit the On-Screen display.

! Note

- Some discs allow you to change subtitle selections only via the disc menu. If this is the case, press TITLE/POPUP or DISC MENU button and choose the appropriate subtitle from the selections on the disc menu.
- You can select the [Subtitle] option on the On-Screen display directly by pressing SUBTITLE button.

Hearing a different audio

BD DVD AVCHD MOVIE

1. During playback, press INFO/MENU (□) to display the On-Screen display.
2. Use \wedge / \vee to select the [Audio] option.
3. Use </> to select desired audio language, audio track or audio channel.

! Note

- Some discs allow you to change audio selections only via the disc menu. In this case, press TITLE/POPUP or DISC MENU button and choose the appropriate audio from the selections on the disc menu.
- Immediately after you have switched sound, there may be a temporary discrepancy between the display and actual sound.
- On BD-ROM disc, the multi audio format (5.1CH or 7.1CH) is displayed with [MultiCH] in the on-screen display.
- You can select the [Audio] option on the On-Screen display directly by pressing AUDIO button.

Watching from a different angle

BD DVD

If the disc contains scenes recorded at different camera angles, you can change to a different camera angle during playback.

1. During playback, press INFO/MENU (□) to display the On-Screen display.
2. Use \wedge / \vee to select the [Angle] option.
3. Use </> to select desired angle.
4. Press BACK (↶) to exit the On-Screen display.

Changing the TV Aspect Ratio

BD AVCHD MOVIE

You can change the TV aspect ratio setting while playback.

1. During playback, press INFO/MENU (□) to display the On-Screen display.
2. Use \wedge/\vee to select the [TV Aspect Ratio] option.
3. Use $\lt;/\gt$ to select desired option.
4. Press BACK (↶) to exit the On-Screen display.

! Note

Even if you change the value of the [TV Aspect Ratio] option in On-Screen display, the [TV Aspect Ratio] option in the [Setup] menu is not changed.

Changing subtitle code page

MOVIE

If the subtitle is displayed in broken letter, you can change the subtitle code page to view the subtitle file properly.

1. During playback, press INFO/MENU (□) to display the playback menu.
2. Use \wedge/\vee to select the [Code Page] option.
3. Use $\lt;/\gt$ to select desired code option.

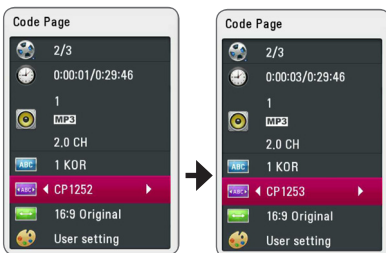

4. Press BACK (↶) to exit the On-Screen display.

Changing the Picture Mode

BD DVD AVCHD MOVIE

You can change the [Picture mode] option while playback.

1. During playback, press INFO/MENU (□) to display the On-Screen display.
2. Use \wedge/\vee to select the [Picture Mode] option.
3. Use $\lt;/\gt$ to select desired option.
4. Press BACK (↶) to exit the On-Screen display.

Setting the [User] option

1. During playback, press INFO/MENU (□) to display the On-Screen display.
2. Use \wedge/\vee to select the [Picture Mode] option.
3. Use $\lt;/\gt$ to select the [User setting] option, and press ENTER (⊙).

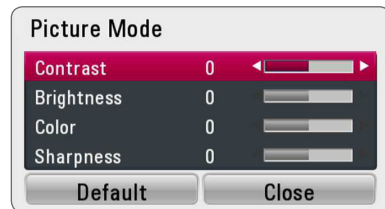

4. Use $\wedge/\vee/\lt;/\gt$ to adjust the [Picture Mode] options.

Select [Default] option then press ENTER (⊙) to reset the all video adjustments.

5. Use $\wedge/\vee/\lt;/\gt$ to select the [Close] option, and press ENTER (⊙) to finish setting.

Radio Operations

Be sure that the antennas are connected.
(Refer to the page 21)

Listening to the radio

1. Press FUNCTION until TUNER (FM) appears in the display window. The last received station is tuned in.
2. Press and hold TUNING (-/+) for about two seconds until the frequency indication starts to change. Scanning stops when the unit tunes in a station. Or Press TUNING (-/+) repeatedly.
3. Adjust the volume by pressing VOL (+/-).

Presetting the Radio Stations

You can preset 50 stations for FM.

Before tuning, make sure that you have turned down the volume.

1. Press FUNCTION until the TUNER (FM) appears in the display window.
2. Select the desired frequency by using TUNING (-/+).
3. Press ENTER (⊙) a preset number will flash in the display window.
4. Press PRESET (-/+) to select the preset number you want.
5. Press ENTER (⊙). The station is stored.
6. Repeat the steps 2 to 5 to store other stations.

Deleting a saved station

1. Press PRESET (- / +) to select a preset number you want to delete.
2. Press CLEAR, the preset number will blink in the display window.
3. Press CLEAR again, to delete the selected preset number.

Deleting all the saved stations

Press and hold CLEAR for two seconds.

"ERASE ALL" will flash up. Press CLEAR again. Then all the saved stations are deleted.

Improving poor FM reception

Press B (blue) (MONO/STEREO) colored button on the remote control. This will change the tuner from stereo to mono and usually improve the reception.

See information about a radio station

The FM tuner is supplied with the RDS (Radio Data System) facility. This shows information about the radio station being listened to. Press RDS repeatedly to cycle through the various data types:

PS	(Programme Service Name) The name of the channel will appear in the display
PTY	(Programme Type Recognition) The programme type (e.g. Jazz or News) will appear in the display.
RT	(Radio Text) A text message contains special information from the broadcast station. This text may scroll across the display.
CT	(Time controlled by the channel) This shows the time and date as broadcast by the station.

Using the Premium

You can use various content services via Internet with the Premium feature.

1. Check the network connection and settings (page 24).
2. Press HOME (🏠).
3. Select the [Premium] using </>, and press ENTER (⊙).

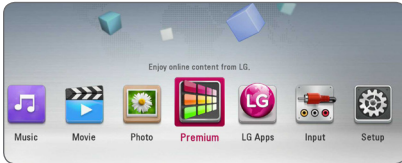

4. Select an on-line service using ^ / v / </>, and press ENTER (⊙).

! Note

- Detailed information of each service, contact to the content provider or visit support link of the service.
- The content of Premium services and service related information, including user interface, is subject to changes. Please refer to the web site of each service for most up-to-date information.
- When you are first time to access [Premium] or [LG Apps] feature, current country setting appears. If you want to change the country setting, select [EDIT] and press ENTER (⊙).

Using the LG Apps

You can use the LG application services on this player via Internet. You can easily find and download various applications from LG App store.

Depending on the region, the LG Apps service may not be available at the moment. The service will become available in these regions through a software update.

1. Check the network connection and settings (page 24).
2. Press HOME (🏠).
3. Select the [LG Apps] using </>, and press ENTER (⊙).

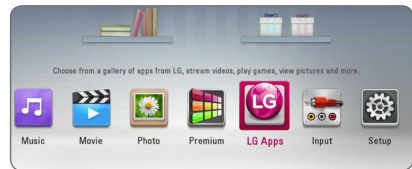

4. Select a category using </>, and press ENTER (⊙).
5. Use ^ / v / </> to select an application, and press ENTER (⊙) to display the information.

6. Press ENTER (⊙) while [Install] icon is highlighted. The application will be installed to the player.

To install an application to the player, user needs to sign in. Refer to page 50 for more information of signing in.

7. Press yellow (Y) colored button to display the [My Apps] screen.
8. Select the installed application and press ENTER (⊙) to execute it.

! Note

To install a paid application, you need to be a paid member. Visit www.lgappstv.com for more information.

Signing in

To use the [LG Apps] feature, you need to sign in with your account.

1. On the [LG Apps] or [My Apps] screen, press red (R) colored button.
2. Fill the [ID] and [Password] field using the virtual keyboard.
If you do not have an account, press red (R) colored button to register.
3. Use $\wedge / \vee / < / >$ to select [OK], and press ENTER (⊙) to sign in with your account.

If you select the [Auto Sign In] check box, your ID and password are remembered and automatically signed in without entering them.

! Note

- If you want to sign in with other account, press red (R) colored button on [LG Apps] or [My Apps] screen, and select [Change User] option.
- To view the information of your account and applications, press red (R) colored button on [LG Apps] or [My Apps] screen, and select [Account Setting] option.

Managing my Apps

You can move or delete an installed application in the [My Apps] menu.

Move an application

1. Select an application, and press green (G) colored button to display the options.
2. Use \wedge / \vee to select [Move], and press ENTER (⊙).
3. Use $\wedge / \vee / < / >$ to select a position you want to move to, and press ENTER (⊙).

Delete an application

1. Select an application, and press green (G) colored button to display the options.
2. Use \wedge / \vee to select [Delete], and press ENTER (⊙).
3. Use $< / >$ to select [Yes], and press ENTER (⊙) to confirm.

Troubleshooting

General

Symptom	Cause & Solution
The Power does not turned on.	<ul style="list-style-type: none"> • Plug the power cord into the wall outlet securely.
The unit does not start playback.	<ul style="list-style-type: none"> • Insert a playable disc. (Check the disc type, color system, and regional code.) • Insert the disc with the playback side down. • Clean the disc. • Cancel the Rating function or change the rating level.
The angle cannot be changed.	<ul style="list-style-type: none"> • Multi-angles are not recorded on the DVD Video being played.
Cannot play movie, photo or music files.	<ul style="list-style-type: none"> • The files are not recorded in a format that the unit can play. • The unit does not support the codec of the movie file.
The remote control does not work properly.	<ul style="list-style-type: none"> • The remote control is not pointed at the remote sensor of the unit. • The remote control is too far from the unit. • There is an obstacle in the path of the remote control and the unit. • The batteries in the remote control are exhausted.
The unit is plugged in, but the power will not turn on or off.	<p>You can reset the unit as follows.</p> <ul style="list-style-type: none"> • Unplug the power cord, wait at least five seconds, and then plug it in again.
The unit is not operating normally.	

Network

Symptom	Cause & Solution
BD-Live feature does not work.	<ul style="list-style-type: none"> The connected USB storage may not have enough space. Connect the USB storage with at least 1GB free space. Ensure that the unit is correctly connected to the local area network and can access the internet (see page 24). Your broadband speed may not fast enough to use the BD-LIVE features. Contact your Internet Service Provider (ISP) and increase the broadband speed is recommended. The [BD-LIVE connection] option in the [Setup] menu is set to [Prohibited]. Set the option to [Permitted].
Streaming video services (such as YouTube™, etc.) are often stopped or “buffer” during playback.	Your broadband service speed may not be fast enough to stream video services. Contact your Internet Service Provider (ISP) and increase the broadband speed is recommended.
Media servers are not displayed on the device list.	<ul style="list-style-type: none"> The firewall or anti-virus software on your media server is running. Turn off the firewall or anti-virus software running on your media server. The player is not connected to the local area network that your media server is connected.
Access point is not displayed on the “Access point name” list.	Your network device such as access point may not set with available frequency range and channel that this player can support. Try setting the frequency range and channel on the network device setting.

Picture

Symptom	Cause & Solution
There is no picture.	<ul style="list-style-type: none"> • Select the appropriate video input mode on the TV so the picture from the unit appears on the TV screen. • Connect the video connection securely. • Check the [HDMI Color Setting] in the [Setup] menu is set to the appropriate item that conforms to your video connection. • Your TV may not support the resolution you have set on the player. Change the resolution that your TV accepts. • The player's HDMI OUT jack is connected to a DVI device that does not support copyright protection.
Picture noise appears	<ul style="list-style-type: none"> • You are playing a disc recorded in a colour system that is different from your TV. • Set the resolution which your TV accepts.
Blu-ray 3D disc playback does not output 3D views.	<ul style="list-style-type: none"> • Connect the player to your TV with HDMI cable (Type A, High Speed HDMI™ Cable with Ethernet). • Your TV may not support "HDMI 3D mandatory format". • The [3D Mode] option in the [Setup] menu is set to [Off]. Set the option to [On].

Sound

Symptom	Cause & Solution
There is no sound or the sound is distorted.	<ul style="list-style-type: none"> • The unit is in scan, slow motion, or pause mode. • The sound volume is low. • Check the speaker cable connection. (page 17)

Customer Support

You can update the Player using the latest software to enhance the products operation and/or add new features. To obtain the latest software for this player (if updates have been made), please visit <http://www.lg.com/global/support> or contact LG Electronics customer care centre.

Open source software notice

To obtain the corresponding source code under GPL, LGPL, MPL and other open source licenses, please visit <http://opensource.lge.com>. All referred license terms, warranty disclaimers and copyright notices are available to download with the source code.

Controlling a TV with the Supplied Remote Control

You can control your TV using the buttons below.

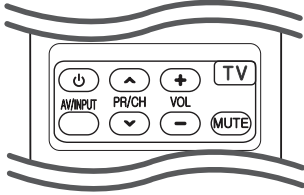

By pressing	You can
⏻ (TV POWER)	Turn the TV on or off.
AV/INPUT	Switch the TV's input source between the TV and other input sources.
PR/CH ▲/▼	Scan up or down through memorized channels.
VOL +/-	Adjust the volume of the TV.
MUTE	Turn the TV's volume on or off.

! Note

Depending on the unit being connected, you may not be able to control your TV using some of the buttons.

Setting up the remote to control your TV

You can operate your TV with the supplied remote control.

If your TV is listed in the table below, set the appropriate manufacturer code.

1. While holding down ⏻ (TV POWER) button, and press the manufacturer code for your TV with the numerical buttons (see the table below).

Manufacturer	Code Number
LG	1(Default), 2
Zenith	1, 3, 4
GoldStar	1, 2
Samsung	6, 7
Sony	8, 9
Hitachi	4

2. Release the ⏻ (TV POWER) button to complete setting.

Depending on your TV, some or all buttons may not function on the TV, even after entering the correct manufacturer code. When you replace the batteries of the remote, the code number you have set may be reset to the default setting. Set the appropriate code number again.

Network Software Update

Network update notification

From time to time, performance improvements and/or additional features or services may be made available to units that are connected to a broadband home network. If there is new software available and the unit is connected to a broadband home network, the player will inform you about the update as follows.

Option 1:

1. The update menu will appear on the screen when you turn off the player.
2. Use $\langle \rangle$ to select a desired option and then press ENTER (⊙).

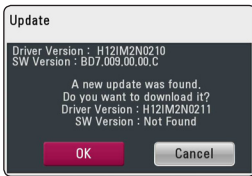

[OK]	Starts the software update.
[Cancel]	Exits the update menu and turns the power off.

Option 2:

If the software update is available from the update server, the "Software Update" icon appears in the Home menu. Press blue (B) colored button to start the update procedure.

Software Update

You can update the player using the latest software to enhance the products operation and/or add new features. You can update the software by connecting the unit directly to the software update server.

! Note

- Before updating the software in your player, remove any disc and USB Device from the player.
- Before updating the software in your player, turn the player off and then turn it back on.
- **During the software update procedure, do not turn off the player or disconnect AC power, or do not press any button.**
- If you cancel the update, turn off the power and turn it on for stable performance.
- This unit cannot be updated to previous software version.

1. Check the network connection and settings (page 24)
2. Select [Software] option in the [Setup] menu then press ENTER (⊙).
3. Select [Update] option, and press ENTER (⊙).

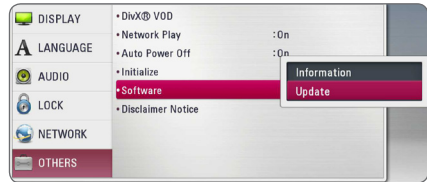

The player will check for the newest update.

! Note

- Pressing ENTER (⊙) while checking for the update will end the process.
- If there is no update available, the Message, "No update is found," appears. Press ENTER (⊙) to return to the [Home Menu].

4. If newer version exists, the message "Do you want to download it?" appears.
5. Select [OK] to start update. (Selecting [Cancel] will end the update.)
6. The player starts downloading the newest update from the server. (Downloading will take several minutes depending on your home network condition)
7. When downloading is completed, the message, "Download is complete. Do you want to update?" appears.
8. Select [OK] to start updating. (Selecting [Cancel] will end the update and downloaded file will not be re-usable. To update software the next time, the software update procedure has to be started from the beginning again.)



Caution

Do not turn off the power during the software update.



Note

If the software includes the driver update, disc tray may open during the process.

9. When update is completed, the power will be turned automatically in a few seconds.
10. Turn the power back on. The system now operates with the new version.



Note

The Software Update function may not work properly depending on your internet environment. In this case, you can obtain the latest software from the authorized LG Electronics Service Centre then update your player. Refer to "Customer Support" on page 53.

About Nero MediaHome 4 Essentials

Nero MediaHome 4 Essentials is a software for sharing movie, music and photo files stored on your computer to this player as a DLNA-compatible digital media server.

Note

- The Nero MediaHome 4 Essentials CD-ROM is designed for PCs and should not be inserted in this player or in any product other than a PC.
- The supplied Nero MediaHome 4 Essentials CD-ROM is a customized software edition only for sharing files and folders to this player.
- The supplied Nero MediaHome 4 Essentials software does not support following functions: Transcoding, Remote UI, TV control, Internet services and Apple iTunes
- The supplied Nero MediaHome 4 Essentials software can be downloaded at <http://www.lg.com/global/support>. Find the download link on the web page of this product.
- This manual explains operations with the English version of Nero MediaHome 4 Essentials as examples. Follow the explanation referring to the actual operations of your language version.

System Requirements

Windows PC

- Windows® XP (Service Pack 2 or higher), Windows Vista® (no Service Pack required), Windows® 7 (no Service Pack required), Windows® XP Media Center Edition 2005 (Service Pack 2 or higher), Windows Server® 2003
- Windows Vista® 64-bit edition (application runs in 32-bit mode)
- Windows® 7 64-bit edition (application runs in 32-bit mode)
- Hard drive space: 200 MB hard drive space for a typical installation of Nero MediaHome stand-alone
- 1.2 GHz Intel® Pentium® III or AMD Sempron™ 2200+ processors
- Memory: 256 MB RAM
- Graphics card with at least 32 MB video memory, minimum resolution of 800 x 600 pixels, and 16-bit color settings
- Windows® Internet Explorer® 6.0 or higher
- DirectX® 9.0c revision 30 (August 2006) or higher
- Network environment: 100 Mb Ethernet, WLAN

Macintosh

- Mac OS X 10.5 (Leopard) or 10.6 (Snow Leopard)
- Macintosh computer with an Intel x86 processor
- Hard drive space: 200 MB hard drive space for a typical installation of Nero MediaHome stand-alone
- Memory: 256 MB RAM

Installing Nero MediaHome 4 Essentials

Windows

Start up your computer, and insert the supplied CD-ROM disc into your computer's CD-ROM drive. An installation wizard will walk you through the quick and uncomplicated installation process. To install Nero MediaHome 4 Essentials, proceed as follows:

1. Close all Microsoft Windows programs and exit any anti-virus software that may be running.
2. Insert the supplied CD-ROM disc into your computer's CD-ROM drive.
3. Click [Nero MediaHome 4 Essentials].
4. Click [Run] to start installation.
5. Click [Nero MediaHome 4 Essentials]. The installation is prepared and the installation wizard appears.
6. Click the [Next] button to display the serial number input screen. Click [Next] to go to the next step.
7. If you accept all conditions, click [I accept the License Conditions] check box and click [Next]. Installation is not possible without this agreement.
8. Click [Typical] and click [Next]. The installation process is started.
9. If you want to take part in the anonymous collection of data, select the check box and click the [Next] button.
10. Click the [Exit] button to complete the installation.

Mac OS X

1. Start up your computer, and insert the supplied CD-ROM disc into your computer's CD-ROM drive.
2. Browse the CD-ROM drive and open the "MediaHome_4_Essentials_MAC" folder.
3. Double-click the "Nero MediaHome.dmg" image file. The Nero MediaHome window is opened.
4. In the Nero MediaHome window, drag the Nero MediaHome icon either to the Applications folder within the window or to any other desired location.
5. You can now start the application by double-clicking the Nero MediaHome icon in the location you dragged it to.

Sharing files and folders

On your computer, you must share the folder contained movie, music and/or photo content to play them on this player.

This part explains the procedure for selecting the shared folders on your computer.

1. Double-click the "Nero MediaHome 4 Essentials" icon.
2. Click [Network] icon on the left and define your network name in the [Network name] field. The Network name you enter will be recognized by your player.
3. Click [Shares] icon on the left.
4. Click [Local Folders] tab on the [Shares] screen.
5. Click [Add] icon to open the [Browse Folder] window.
6. Select the folder containing the files you want to share. The selected folder is added to the list of shared folders.
7. Click [Start Server] icon to start the server.

Note

- If the shared folders or files are not displayed on the player, click the folder on the [Local Folders] tab and click [Rescan Folder] at the [More] button.
- Visit www.nero.com for more information and software tools

Area Code List

Choose an area code from this list.

Area	Code	Area	Code	Area	Code	Area	Code
Afghanistan	AF	Fiji	FJ	Monaco	MC	Singapore	SG
Argentina	AR	Finland	FI	Mongolia	MN	Slovak Republic	SK
Australia	AU	France	FR	Morocco	MA	Slovenia	SI
Austria	AT	Germany	DE	Nepal	NP	South Africa	ZA
Belgium	BE	Great Britain	GB	Netherlands	NL	South Korea	KR
Bhutan	BT	Greece	GR	Antilles	AN	Spain	ES
Bolivia	BO	Greenland	GL	New Zealand	NZ	Sri Lanka	LK
Brazil	BR	Hong Kong	HK	Nigeria	NG	Sweden	SE
Cambodia	KH	Hungary	HU	Norway	NO	Switzerland	CH
Canada	CA	India	IN	Oman	OM	Taiwan	TW
Chile	CL	Indonesia	ID	Pakistan	PK	Thailand	TH
China	CN	Israel	IL	Panama	PA	Turkey	TR
Colombia	CO	Italy	IT	Paraguay	PY	Uganda	UG
Congo	CG	Jamaica	JM	Philippines	PH	Ukraine	UA
Costa Rica	CR	Japan	JP	Poland	PL	United States	US
Croatia	HR	Kenya	KE	Portugal	PT	Uruguay	UY
Czech Republic	CZ	Kuwait	KW	Romania	RO	Uzbekistan	UZ
Denmark	DK	Libya	LY	Russian Federation	RU	Vietnam	VN
Ecuador	EC	Luxembourg	LU	Saudi Arabia	SA	Zimbabwe	ZW
Egypt	EG	Malaysia	MY	Senegal	SN		
El Salvador	SV	Maldives	MV				
Ethiopia	ET	Mexico	MX				

Language code List

Use this list to input your desired language for the following initial settings: [Disc Audio], [Disc Subtitle] and [Disc Menu].

Language	Code	Language	Code	Language	Code	Language	Code
Afar	6565	French	7082	Lithuanian	7684	Sindhi	8368
Afrikaans	6570	Frisian	7089	Macedonian	7775	Singhalese	8373
Albanian	8381	Galician	7176	Malagasy	7771	Slovak	8375
Amharic	6577	Georgian	7565	Malay	7783	Slovenian	8376
Arabic	6582	German	6869	Malayalam	7776	Spanish	6983
Armenian	7289	Greek	6976	Maori	7773	Sudanese	8385
Assamese	6583	Greenlandic	7576	Marathi	7782	Swahili	8387
Aymara	6588	Guarani	7178	Moldavian	7779	Swedish	8386
Azerbaijani	6590	Gujarati	7185	Mongolian	7778	Tagalog	8476
Bashkir	6665	Hausa	7265	Nauru	7865	Tajik	8471
Basque	6985	Hebrew	7387	Nepali	7869	Tamil	8465
Bengali; Bangla	6678	Hindi	7273	Norwegian	7879	Telugu	8469
Bhutani	6890	Hungarian	7285	Oriya	7982	Thai	8472
Bihari	6672	Icelandic	7383	Panjabi	8065	Tonga	8479
Breton	6682	Indonesian	7378	Pashto, Pushto	8083	Turkish	8482
Bulgarian	6671	Interlingua	7365	Persian	7065	Turkmen	8475
Burmese	7789	Irish	7165	Polish	8076	Twi	8487
Byelorussian	6669	Italian	7384	Portuguese	8084	Ukrainian	8575
Chinese	9072	Japanese	7465	Quechua	8185	Urdu	8582
Croatian	7282	Kannada	7578	Rhaeto-Romance	8277	Uzbek	8590
Czech	6783	Kashmiri	7583	Rumanian	8279	Vietnamese	8673
Danish	6865	Kazakh	7575	Russian	8285	Volapük	8679
Dutch	7876	Kirghiz	7589	Samoan	8377	Welsh	6789
English	6978	Korean	7579	Sanskrit	8365	Wolof	8779
Esperanto	6979	Kurdish	7585	Scots Gaelic	7168	Xhosa	8872
Estonian	6984	Laotian	7679	Serbian	8382	Yiddish	7473
Faroese	7079	Latin	7665	Serbo-Croatian	8372	Yoruba	8979
Fiji	7074	Latvian, Lettish	7686	Shona	8378	Zulu	9085
Finnish	7073	Lingala	7678				

Trademarks and Licenses



Blu-ray Disc™, Blu-ray™, Blu-ray 3D™, BD-Live™, BONUSVIEW™ and the logos are trademarks of the Blu-ray Disc Association.



“DVD Logo” is a trademark of DVD Format/Logo Licensing Corporation.



Java is a trademark of Oracle and/or its affiliates.



HDMI, the HDMI logo and High-Definition Multimedia Interface are trademarks or registered trademarks of HDMI Licensing LLC in the United States and other countries.



Manufactured under license from Dolby Laboratories. Dolby and the double-D symbol are trademarks of Dolby Laboratories.



DLNA®, the DLNA Logo and DLNA CERTIFIED® are trademarks, service marks, or certification marks of the Digital Living Network Alliance.



Manufactured under license under U.S. Patent Nos: 5,956,674; 5,974,380; 6,226,616; 6,487,535; 7,392,195; 7,272,567; 7,333,929; 7,212,872 & other U.S. and worldwide patents issued & pending. DTS-HD, the Symbol, & DTS-HD and the Symbol together are registered trademarks & DTS-HD Master Audio | Essential is a trademark of DTS, Inc. Product includes software. © DTS, Inc. All Rights Reserved.



“AVCHD” and the “AVCHD” logo are trademarks of Panasonic Corporation and Sony Corporation.



DivX®, DivX Certified® and associated logos are trademarks of Rovi Corporation or its subsidiaries and are used under license.

Cinavia Notice

This product uses Cinavia technology to limit the use of unauthorized copies of some commercially-produced film and videos and their soundtracks. When a prohibited use of an unauthorized copy is detected, a message will be displayed and playback or copying will be interrupted.

More information about Cinavia technology is provided at the Cinavia Online Consumer Information Center at <http://www.cinavia.com>. To request additional information about Cinavia by mail, send a postcard with your mailing address to: Cinavia Consumer Information Center, P.O. Box 86851, San Diego, CA, 92138, USA.

This product incorporates proprietary technology under license from Verance Corporation and is protected by U.S. Patent 7,369,677 and other U.S. and worldwide patents issued and pending as well as copyright and trade secret protection for certain aspects of such technology. Cinavia is a trademark of Verance Corporation. Copyright 2004-2010 Verance Corporation. All rights reserved by Verance. Reverse engineering or disassembly is prohibited.

Audio Output Specifications

Jack/Setting Source	HDMI OUT			
	PCM Stereo	PCM Multi-Ch	DTS Re-encode *3	BitStream *1 *2
Dolby Digital	PCM 2ch	PCM 5.1ch	DTS	Dolby Digital
Dolby Digital Plus	PCM 2ch	PCM 5.1ch	DTS	Dolby Digital Plus
Dolby TrueHD	PCM 2ch	PCM 5.1ch	DTS	Dolby TrueHD
DTS	PCM 2ch	PCM 5.1ch	DTS	DTS
DTS-HD	PCM 2ch	PCM 5.1ch	DTS	DTS-HD
Linear PCM 2ch	PCM 2ch	PCM 2ch	DTS	Linear PCM 2ch
Linear PCM 5.1ch	PCM 2ch	PCM 5.1ch	DTS	Linear PCM 5.1ch
Linear PCM 7.1ch	PCM 2ch	PCM 5.1ch	DTS	Linear PCM 7.1ch

*1 The secondary and interactive audio may not be included in the output bitstream if [Digital Output] option is set to [BitStream]. (Except LPCM Codec : the output always include interactive and secondary audio.)

*2 This player automatically selects the HDMI audio according to the decoding capability of the connected HDMI device even though [Digital Output] option is set to [BitStream].

*3 If the [Digital Output] option is set to [DTS re-encode], the audio output is limited to 48 kHz and 5.1Ch. If the [Digital Output] option is set to [DTS re-encode], the DTS Re-encode audio is outputted for BD-ROM discs, and the original audio is outputted for the other discs (like [BitStream]).

- The audio is outputted as PCM 48 kHz/16 bit for MP3/WMA file and PCM 44.1kHz/16 bit for Audio CD while playback.
- With digital audio connection (HDMI OUT), Disc Menu button sounds of BD-ROM may not be heard if the [Digital Output] option is set to [BitStream].
- If the audio format of the digital output does not match the capabilities of your receiver, the receiver will produce a strong, distorted sound or no sound at all.
- Multi-channel Digital Surround Sound via digital connection can only be obtained if your receiver is equipped with a Digital Multi-channel decoder.
- This setting is not available on the input signal from an external device.

Specifications

General	
Power requirements	Refer to main label.
Power consumption	Refer to main label.
Dimensions (W x H x D)	Approx. 360 X 60.5 X 297 mm
Net Weight (Approx.)	2.7 kg
Operating temperature	5 °C to 35 °C (41 °F to 95 °F)
Operating humidity	5 % to 90 %

Inputs/Outputs	
VIDEO OUT	1.0 V (p-p), 75 Ω, sync negative, RCA jack x 1
HDMI OUT (video/audio)	19 pin (Type A, HDMI™ Connector) x 1
ANALOG AUDIO IN	2.0 Vrms (1 kHz, 0 dB), 600 Ω, RCA jack (L, R) x 1
DIGITAL IN (OPTICAL)	3 V (p-p), Optical jack x 1
PORT. IN	0.5 Vrms (3.5 mm stereo jack) x 1

Tuner	
FM Tuning Range	87.5 to 108.0 MHz or 87.50 to 108.00 MHz

Amplifier	
Power output, (RMS), THD 10 %	
Total	850 W
Front	141 W x 2
Center	141 W
Rear	141 W x 2
Sub-Woofer	145 W (Passive)

System	
Laser	Semiconductor laser
Wavelength	405 nm / 650 nm
Signal system	Standard PAL/NTSC color TV system
Frequency response	20 Hz to 18 kHz (48 kHz, 96 kHz, 192 kHz sampling)
Harmonic distortion	Less than 0.05 %
Dynamic range	More than 80 dB
LAN port	Ethernet jack x 1, 10BASE-T / 100BASE-TX
Bus Power Supply (USB)	DC 5 V  500 mA

Speakers			
Front speaker (Left/ Right)			
Type	1 Way 1 Speaker	Max. Input power	282 W
Impedance Rated	3 Ω	Net Dimensions (W x H x D)	88 x 197 x 79 mm
Input Power	141 W	Net Weight	0.6 kg
Rear speaker (Left/ Right)			
Type	1 Way 1 speaker	Max. Input power	282 W
Impedance Rated	3 Ω	Net Dimensions (W x H x D)	88 x 197 x 79 mm
Input Power	141 W	Net Weight	0.6 kg
Center speaker			
Type	1 Way 1 Speaker	Max. Input power	282 W
Impedance Rated	3 Ω	Net Dimensions (W x H x D)	300 x 88 x 64 mm
Input Power	141 W	Net Weight	0.5 kg
Subwoofer			
Type	1 Way 1 speaker	Max. Input power	290 W
Impedance Rated	3 Ω	Net Dimensions (W x H x D)	133 x 352 x 325 mm
Input Power	145 W	Net Weight	4.8 kg

- Design and specifications are subject to change without notice.

Maintenance

Handling the Unit

When shipping the unit

Please save the original shipping carton and packing materials. If you need to ship the unit, for maximum protection, re-pack the unit as it was originally packed at the factory.

Keeping the exterior surfaces clean

Cleaning the unit

To clean the player, use a soft, dry cloth. If the surfaces are extremely dirty, use a soft cloth lightly moistened with a mild detergent solution. Do not use strong solvents such as alcohol, benzine, or thinner, as these might damage the surface of the unit.

- Do not use volatile liquids such as insecticide spray near the unit.
- Wiping with strong pressure may damage the surface.
- Do not leave rubber or plastic products in contact with the unit for a long period of time.

Maintaining the Unit

The unit is a high-tech, precision device. If the optical pick-up lens and disc drive parts are dirty or worn, the picture quality could be diminished. For details, please contact your nearest authorized service center.

Notes on Discs

Handling Discs

Do not touch the playback side of the disc. Hold the disc by the edges so that fingerprints do not get on the surface. Never stick paper or tape on the disc.

Storing Discs

After playing, store the disc in its case. Do not expose the disc to direct sunlight or sources of heat and never leave it in a parked car exposed to direct sunlight.

Cleaning Discs

Fingerprints and dust on the disc can cause poor picture quality and sound distortion. Before playing, clean the disc with a clean cloth. Wipe the disc from the center to out.

Do not use strong solvents such as alcohol, benzine, thinner, commercially available cleaners, or anti-static spray intended for older vinyl records.

Important Information Relating to Network Services

All information, data, documents, communications, downloads, files, text, images, photographs, graphics, videos, webcasts, publications, tools, resources, software, code, programs, applets, widgets, applications, products and other content (“Content”) and all services and offerings (“Services”) provided or made available by or through any third party (each a “Service Provider”) is the sole responsibility of the Service Provider from whom it originated.

The availability of and access to Content and Services furnished by the Service Provider through the LGE Device are subject to change at any time, without prior notice, including, but not limited to the suspension, removal or cessation of all or any part of the Content or Services.

Should you have any inquiry or problem related to the Content or Services, you may refer to the Service Provider’s website for the most up-to-date information. LGE is neither responsible nor liable for customer service related to the Content and Services. Any question or request for service relating to the Content or Services should be made directly to the respective Content and Service Providers.

Please note that LGE is not responsible for any Content or Services provided by the Service Provider or any changes to, removal of, or cessation of such Content or Services and does not warrant or guaranty the availability of or access to such Content or Services.

