



OWNER'S MANUAL

Dome Camera

Please read this manual carefully before operating your set and retain it for future reference.

MODEL

L9322 Series

1 Safety Information

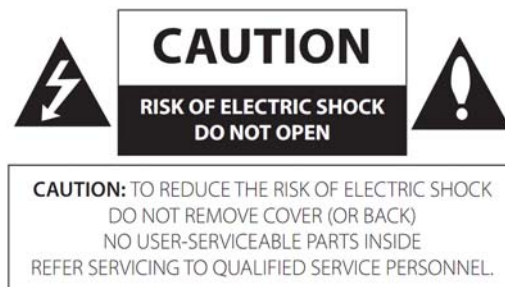

This lightning flash with arrowhead symbol within an equilateral triangle is intended to alert the user to the presence of un-insulated dangerous voltage within the product's enclosure that may be of sufficient magnitude to constitute a risk of electric shock to persons.



The exclamation point within an equilateral triangle is intended to alert the user to the presence of important operating and maintenance (servicing) instructions in the literature accompanying the product.

FCC WARNING: This equipment may generate or use radio frequency energy. Changes or modifications to this equipment may cause harmful interference unless the modifications are expressly approved in the instruction manual. The user could lose the authority to operate this equipment if an unauthorized change or modification is made.

REGULATORY INFORMATION: FCC Part 15

This equipment has been tested and found to comply with the limits for a Class A digital device, pursuant to Part 15 of the FCC Rules. These limits are designed to provide reasonable protection against harmful interference when the equipment is operated in a commercial environment. This equipment generates, uses, and can radiate radio frequency energy and, if not installed and used in accordance with the instruction manual, may cause harmful interference to radio communications. Operation of this equipment in a residential area is likely to cause harmful interference in which case the user will be required to correct the interference at his expense.

- A suitable conduit entries, knock-outs or glands shall be provided in the cable entries of this product in the end user.
- Caution: Danger of explosion if battery is incorrectly replaced. Replaced only with the same or equivalent type recommended by the manufacturer. Dispose of used batteries according to the manufacturer's instructions.
- Holes in metal, through which insulated wires pass, shall have smooth well rounded surfaces or shall be provided with brushings.

This Class A digital apparatus complies with Canadian ICES-003.
Cet appareil numérique de la classe A est conforme à la norme NMB-003 du Canada.

Warning: Do not install this equipment in a confined space such as a bookcase or similar unit.

Warning: Wiring methods shall be in accordance with the National Electric Code, ANSI/NFPA 70.

Warning: This is a class A product. In a domestic environment this product may cause radio interference in which case the user may be required to take adequate measures.

Warning: To reduce a risk of fire or electric shock, do not expose this product to rain or moisture.

Caution: This installation should be made by a qualified service person and should conform to all local codes.

Caution: To avoid electrical shock, do not open the cabinet. Refer servicing to qualified personnel only.

Caution: The apparatus should not be exposed to water (dripping or splashing) and no objects filled with liquids, such as vases, should be placed on the apparatus.

Caution: This product employs a Laser System. To ensure proper use of this product, please read this owner's manual carefully and retain it for future reference. Should the unit require maintenance, contact an authorized service center. Performing controls, adjustments, or carrying out procedures other than those specified herein may result hazardous radiation exposure. To prevent direct exposure to laser beam, do not try to open the enclosure. Visible laser radiation when opened. DO NOT STARE INTO BEAM.

To disconnect power from mains, pull out the mains cord plug. When installing the product, ensure that the plug is easily accessible.



LG Electronics hereby declares that this/these product(s) is/are in compliance with the essential requirements and other relevant provisions of Directive 2004/108/EC, 2006/95/EC, and 2009/125/EC.

European representative :

LG Electronics Service Europe B.V.
Veluwezoom 15, 1327
AE Almere. The Netherlands
(Tel : +31-(0)36-547-8888)

Disposal of your old appliance



1. When this crossed-out wheeled bin symbol is attached to a product it means the product is covered by the European Directive 2002/96/EC.
2. All electrical and electronic products should be disposed of separately from the municipal waste stream via designated collection facilities appointed by the government or the local authorities.
3. The correct disposal of your old appliance will help prevent potential negative consequences for the environment and human health.
4. For more detailed information about disposal of your old appliance, please contact your city office, waste disposal service or the shop where you purchased the product.

EEE Compliance with Directive. (for Turkey only)

IMPORTANT SAFETY INSTRUCTIONS

1. Read these instructions.
2. Keep these instructions.
3. Heed all warnings.
4. Follow all instructions.
5. Do not use this apparatus near water.
6. Clean only with dry cloth.
7. Do not block any ventilation openings. Install in accordance with the manufacturer's instructions.
8. Do not install near any heat sources such as radiators, heat registers, stoves, or other apparatus (including amplifiers) that produce heat.
9. Do not defeat the safety purpose of the polarized or grounding-type plug. A polarized plug has two blades with one wider than the other. A grounding type plug has two blades and a third grounding prong. The wide blade or the third prong is provided for your safety. If the provided plug does not fit into your outlet, consult an electrician for replacement of the obsolete outlet.
10. Protect the power cord from being walked on or pinched particularly at plugs, convenience receptacles, and the point where they exit from the apparatus.
11. Only use attachments/accessories specified by the manufacturer.
12. Use only with the cart, stand, tripod, bracket, or table specified by the manufacturer, or sold with the apparatus. When a cart is used, use caution when moving the cart/apparatus combination to avoid injury from tip-over.



13. Unplug this apparatus during lightning storms or when unused for long periods of time.
14. Refer all servicing to qualified service personnel. Servicing is required when the apparatus has been damaged in any way, such as power-supply cord or plug is damaged, liquid has been spilled or objects have fallen into the apparatus, the apparatus has been exposed to rain or moisture, does not operate normally, or has been dropped.

Safety Precautions

- Do not attempt to disassemble the camera
To prevent electric shock, do not remove screws or covers. There are no user serviceable parts inside. Ask a qualified service personnel for servicing.
- Avoid the camera with direct sunlight
Do not aim the camera at bright objects. Whether the camera is in use or not, never face it with direct sunlight or other extremely bright objects. Otherwise blooming or smear may be caused.
- Handle the camera with care
Do not abuse the camera. Avoid striking, shaking, etc. The camera could be damaged by improper handling or storage.
- Do not use strong solvents or detergents
Use a dry cloth to the camera when it is dirty. If it is hard to remove the dirt on the camera, use a mild detergent and wipe it gently.
- Do not install this camera upside down
This camera is designed for mounting on the ceiling or wall. If you install this camera upside down, for example, mounted on the floor, it may cause malfunction.
- Do not use the camera in such places as shown below. The lens may become cloudy due to condensation if the camera is used under the following conditions.
 - > Rapid temperature fluctuation by switching an air conditioner on and off.
 - > Rapid temperature fluctuation due to frequent door opening and closing.
 - > Use in an environment where eyeglasses become foggy.
 - > Use in a room filled with cigarette smoke or dust.If the lens becomes cloudy due to condensation, remove the dome cover and wipe all moist surfaces with a soft cloth.
- Before operating, please check proper temperature, humidity and power source ratings.
Use the camera under conditions where temperature is from -10 °C to 50 °C and humidity is below 80 %. The input power source is DC 12 V or AC 24 V.
- This camera must always be operated by AC 24 V or DC 12 V Certified/Listed, class 2 power supply only.
- Consumables
Parts having contacts such as the lens-drive motors, cooling fan built inside the camera are subject to wear with time. About replacement and maintenance of such parts, please ask the nearest service center.

Camera Installation Location

Discuss the installation location for the camera with your retailer, and select a place that is strong enough for the installation.

- Install the camera on a ceiling (concrete, etc.) at a location that is sufficiently strong to support it.
- Install the camera body on the foundation section of the building or sections having sufficient bearing strength.

Never install or use the camera in the following locations

- Do not install it in areas exposed to direct sunlight or rain.
- Do not install the camera near the air outlet of an air conditioner.
- Near a swimming pool or other areas where chemicals are used.
- Food preparation areas and other locations where there are large amounts of steam vapor and oil, in flammable atmospheres, other special environments.
- Areas where radiation, X-rays, strong electric waves, or magnetism is generated.
- At sea, in coastal areas, or in areas where corrosive gas is being generated.

- Areas outside of the allowable ambient operating temperature range.

About Static Electricity Removal

Before installing the camera, touch a metal case or other metallic parts with your hand to remove static electricity from your body.

Do not install in areas subjected to high amounts of humidity or dust.

Doing so may cause internal components to damage more easily or malfunction.

Do not wire cables near power lines.

Tightening the Screws

Screws should be tightened sufficiently in accordance with the materials and structure of the installation location. After tightening the screws, visually inspect them to make sure there is no unevenness and that each screw is tight

Contents

1

Safety Information

IMPORTANT SAFETY INSTRUCTIONS.....	4
Safety Precautions.....	5

2

Preparation

Features.....	9
Package Component.....	11
Main Part Description.....	12

3

Installation

Connections	13
Precautions	13
Connection Overview.....	13
DIP Switch Setup.....	14
Mounting the camera.....	17
Surface mount.....	17
In-ceiling mount.....	18

4

Operation

Menu navigation.....	19
Setup Menu Overview.....	20
Menu settings	24
Camera menu settings.....	24
Focus setting.....	24
Exposure settings.....	25
White Balance Setting.....	26
DAY/NIGHT Setting	28
3D-DNR Setting.....	29
Color Setting.....	29
Sharpness Setting	30
D-Effect Setting.....	31
Stabilizer Setting.....	31
Pan/Tilt Setting.....	32
Preset Setting.....	32
Group Tour Setting	34
Pattern Setting.....	35
Auto Pan Setting	36
Swing Setting.....	37
Privacy Mask Setting.....	39

Special Setting.....	40
OSD Settings.....	43
User Title Setting.....	43
ZOOM MAG Setting.....	44
FUNCTION Setting.....	44
DOME ID Setting.....	45
LANGUAGE Setting.....	45
ALARM Setting.....	46
Alarm In Setting.....	47
Alarm Out Setting.....	47
RESET Setting.....	48
Information.....	48
Initialization.....	48
Factory Reset.....	48
Specifications.....	49

2 Preparation

Features

- **High Sensitivity Support**
The camera provides the high quality picture with 4.5 mm CCD and XDI-II ISP.
- **Preset Position**
Preset position is the function to register camera monitoring positions (preset positions). By using LKD1000 controller, you can register presets with position number. Maximum 128 Preset Positions are available. By entering the position numbers, you can move cameras to the preset positions. The moving speed and holding time are adjustable.
- **Preset Tour**
Preset Tour is the function to go through all the registered camera monitoring positions (preset positions).
- **Group Tour**
Maximum 9 group tours are able to compose the group of preset, pattern, auto pan that the operator can program to be linked together in a sequence.
- **Pattern recording function**
A routine of manual operations can be stored and reproduced repeatedly. The Pan, Tilt and Zoom controls are available for pattern recording.

Note

The available total time of pattern differs depending on camera's operation. When the pattern recording is full, the pattern recording will automatically stop.

- **Privacy Mask**
Privacy zone feature enables users to veil unwanted zones. This setting is used for masking unwanted zones, hiding them from display on the monitor screen. Up to 8 zones can be registered.
- **Auto Pan**
The camera has an Auto Pan function that enables to keep surveillance on every detail occurring around the specific area, which is preset to watch in advance. The camera can pan among the maximum 8 points you will set. The moving speed and holding time are adjustable.
- **Swing**
Swing is the function that a camera scans between 2 preset positions. Swing speed between 2 preset positions can be adjusted. There are 8 Swings.
- **Auto Flip**
When the camera is operated to tilt through the 90°, it can be watched the opposite side of the locations by Auto Flip of a 180° horizontally.
- **Optical Zoom**
The optical zoom range is 1x to 12x.
- **Digital Zoom**
Digital zoom enhances the systems zoom range to 12 times beyond the optical zoom limit. Total system zoom range is 12x (1x digital zoom) to 144x (12x digital zoom).

- **Alarm In Function (3 channels)**
Alarm input signals are supplied from external devices through the ALARM IN connector to activate 'go to preset' function.
- **Alarm Out Function (1 channels)**
When alarm inputs are supplied via the alarm input connector on the camera, the camera sends output signals via the alarm output connector on the camera.
- **Motion Detection Function**
When there is no Pan/Tilt/Zoom motion, a camera can detect motions in video images and work with sensor functions
- **Controls by General Controller**
This camera can be controlled by RS-485. Especially the camera has an excellent cost-saving effect because it can be controlled by the general RX point of contact signal.
- **Connects with maximum 256 cameras**
This camera can be utilized after being connected with maximum 256 cameras. Therefore, it is capable of performing an excellent job in the large buildings or department stores.
- **Day & Night Function**
This camera can be selected Color or Black & White. You can set Color in the daytime and Black & White at night due to the low illumination. (Filter Conversion type)
- **DSS (Digital Slow Shutter) Function**
It is possible to highly sensitive surveillance because of DSS(Digital Slow Shutter) function.
- **WDR (Wide Dynamic Range) Function**
The camera can be best condition to watch easily inside or outside in the strong back light.
- **Power Supply**
Both of DC 12V and AC 24V can be used.

Package Component

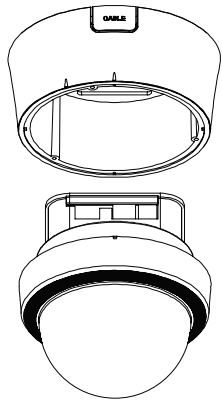

● Main Body & Surface Mount Bracket

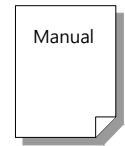
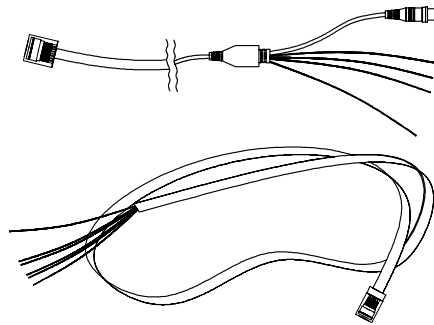

● Default Accessories
[Main Cable, I/O Cable, Owner's Manual,
Screws : Tapping M4×16]

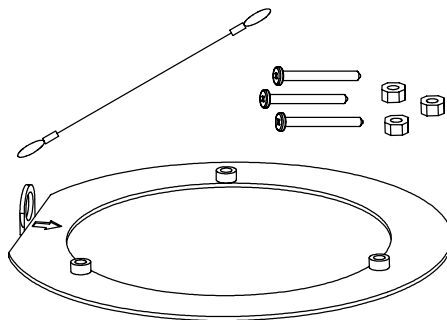

● Accessories for In-ceiling mount
[In-ceiling Plate, In-Ceiling Wire, Machine M4×50, Nut M4]

Main Part Description

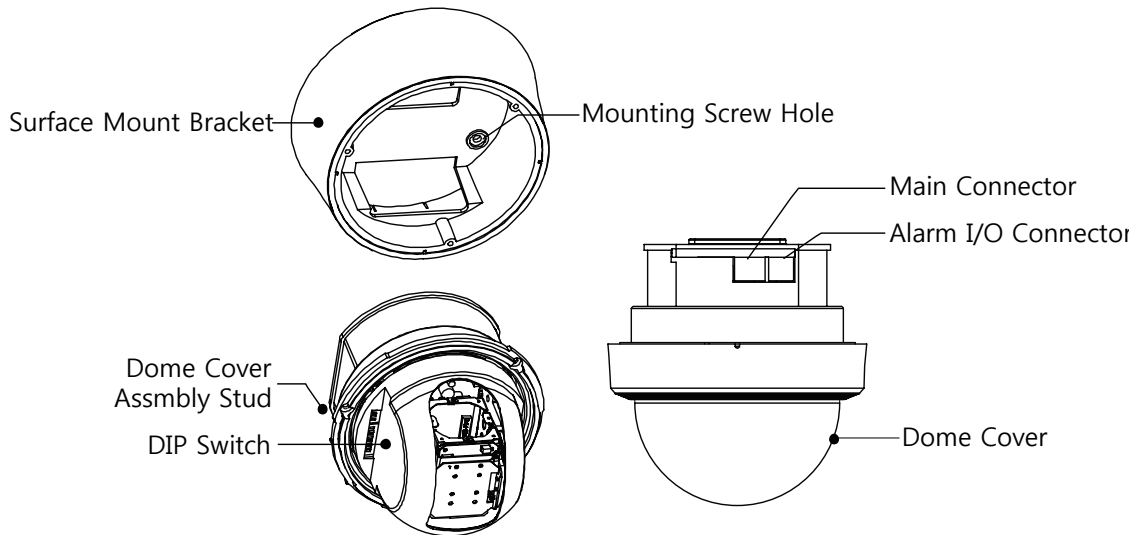

- Dome Cover Do not detach the protection vinyl from the dome cover before finishing all the installation process to protect the dome cover from scratches or dust.
- Dome Cover Assembly Stud Used to line up the stud on the main body and the stud on the dome cover when assembling the dome cover with the main body.
- DIP Switch Used to set up camera IDs and protocols.
- Surface Mount Bracket & Mounting Screw Hole Used for surface mount type, wall mount type and ceiling mount type. They are not used for in-ceiling mount type.
- Main Connector Used for the power wire, the video cable and the RS-485 communication cable connection.
- Alarm I/O Connector Used for the alarm in/out connection.

3 Installation

Connections

Precautions

- The following steps of installation and connection work should be done by qualified service personnel or system installers and should conform to all local codes.
- Before you install and connect the camera, check and prepare the required peripheral devices and cables.
- Before you connect the camera, turn off all devices to be connected, such as this camera and DVR.
- Do not touch the dome cover's window.

Connection Overview

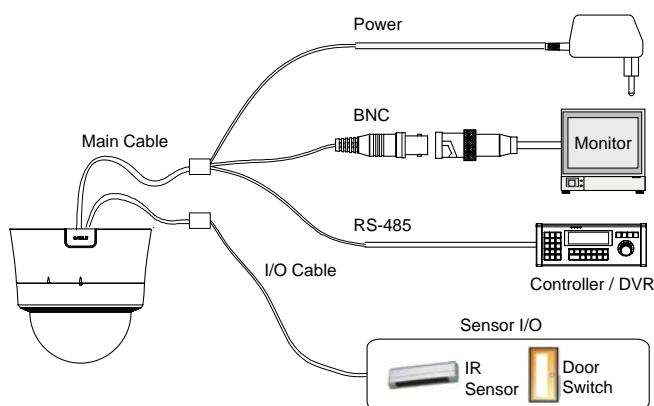

□ Port Description

• Main Cable

Port Pin Number	Connector / Wire Color	Signal
1	BNC Connector	Video +
2,4		Video -
5	Red	RS-485 +
3	Yellow	RS-485 -
7	Orange	Power +
6,8	White	Power -

• Alarm I/O Cable

Port Pin Number	Wire Color	Signal
1	Blue	IN COM +
2	Yellow	IN 1 -
3	Green	IN 2 -
4	Red	IN 3 -
5	Black	OUT A
6	White	OUT B

DIP Switch Setup

Before installing the camera, set up the DIP switch to configure the camera ID and the communication protocol.

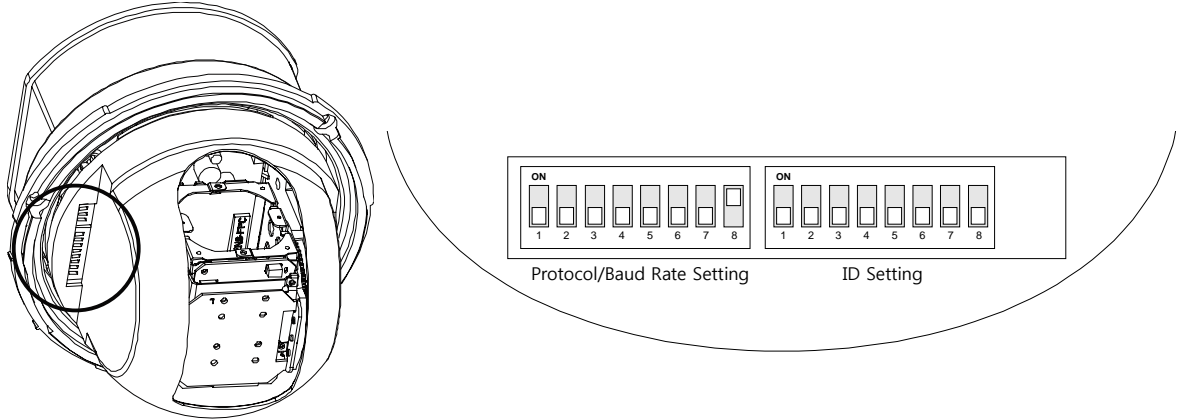

□ Camera ID Setup

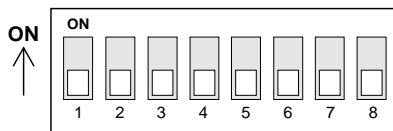

- ID numbers of cameras are set up with binary numbers. See the examples shown below.

Pin	1	2	3	4	5	6	7	8
Binary Value	1	2	4	8	16	32	64	128
ex) ID=5	on	off	on	off	off	off	off	off
ex) ID=10	off	on	off	on	off	off	off	off

- The factory default of the camera ID is "0".
- Match the camera ID with the Cam ID setting of your DVR or Controller to control the camera.
- ID 0 can not be used in Pelco-P protocol.

□ Communication Protocol Setup

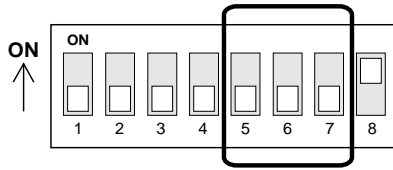

- Select an appropriate Protocol with the DIP switch combination.

Switch Mode			Protocol
Pin 5	Pin 6	Pin 7	
OFF	OFF	OFF	LG Multix
ON	OFF	OFF	PELCO-D
OFF	ON	OFF	PELCO-P
ON	ON	OFF	PELCO-C
ON	ON	ON	OSD Set
Others			Reserved

- Match the camera protocol with the camera protocol in the setting of your DVR or controller to control the camera.
- Adjust the DIP switch after turning off the camera.
- The factory default protocol is "LG Multix".

□ Baud Rate Setup

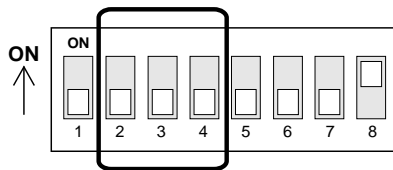

- Select the baud rate with the DIP switch combination.

Switch Mode			Baud Rate
Pin 2	Pin 3	Pin 4	
OFF	OFF	OFF	9600 bps
ON	OFF	OFF	2400 bps
OFF	ON	OFF	4800 bps
ON	ON	OFF	19200 bps
OFF	OFF	ON	38400 bps
ON	ON	ON	OSD Set
Others			Reserved

- Match the baud rate with the camera's one in the setting of your DVR or controller to control the camera.
- Adjust the DIP switch after turning off the camera
- The factory default value is 9600 bps.

□ Terminal Resistor Setup

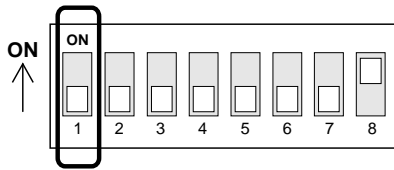

The terminal resistor is used for the following cases.

- **In case that the control cable length between a camera and a controller is relatively very long (1:1 Connection)**

If the communication cable length is very long, the electrical signal will bound in the terminal point. This reflected signal causes distortion of original signal. Accordingly, the camera can be out of control. In this case, the terminal resistor of both sides i.e. the camera and the controller must be set to 'ON' state.

- **In case that multiple cameras are connected to a controller**

Due to similar reasons with the case 1, the terminal resistor of the controller and the last camera must be set to 'ON' state. The last camera means the camera farthest in cable length from the controller. Do not turn on the terminal resistor of all the cameras on the same communication cable.

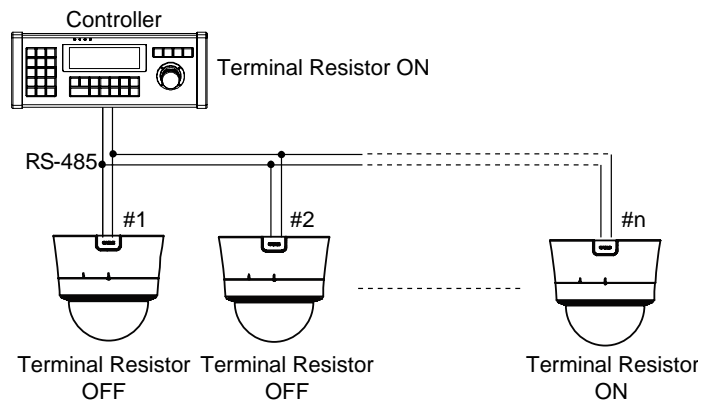

□ Configuration for the Manufacturer Only

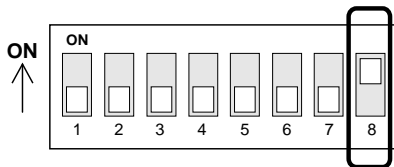

- **DO NOT CONFIGURE! This configuration is to upgrade its firmware by the manufacturer only.**
- **It must be always set to ON.**

Mounting the camera

Surface mount

- ① Remove the ceiling tile from the ceiling and cut a hole whose diameter is 30~40mm on the ceiling tile to pass the wires and cables through to the upside of the ceiling.
- ② Prepare the surface mount bracket. Pull the wires and cables for the system as below. Attach the surface mount bracket to the mounting surface. (Tapping M4×16)

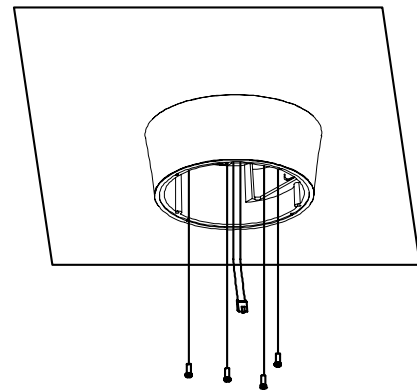
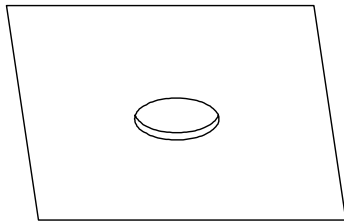

- ③ Connect the wires and cables to the ports and install the main body. (Machine M3×8)
- ④ Align the dome cover stud with the dome cover assembly stud and slightly push the dome cover to the ceiling. Turn the dome cover clockwise and remove the protection vinyl from the dome cover.

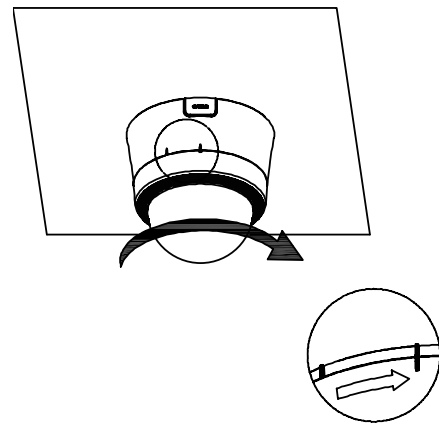
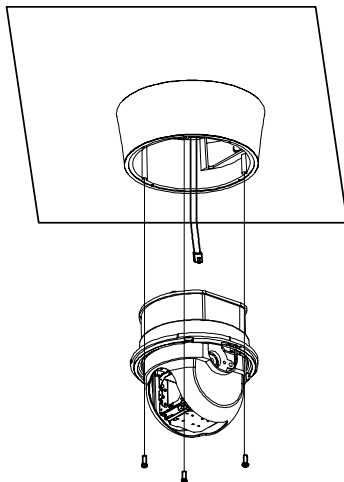

In-ceiling mount

- ① Remove the ceiling tile from the ceiling and cut a hole whose diameter is 113 mm.

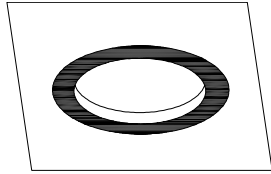

- ② Cut three holes for M4 screws, and install the main body with the In-Ceiling Plate, the three screws (M4x50) and the three nuts (M4). Then install the ceiling tile to the ceiling and connect the main cable to the main port. Attach the supplied lanyard to the in-ceiling ring eye and then to the building structure.

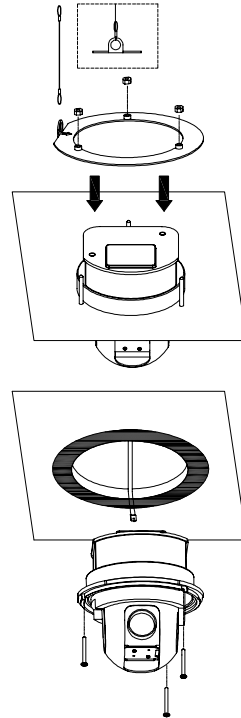

- ③ Align the dome cover stud with the dome cover assembly stud and slightly push the dome cover to the ceiling tile. Then remove the protection vinyl from the dome cover.

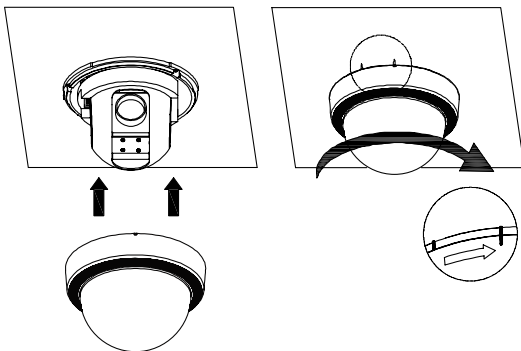

4

Operation

Menu navigation

We use the LKD1000 controller in this manual to explain the features of the LG Dome camera because of the LKD1000's ability to control all of the LG Dome camera's advanced features. (For detailed controller instructions, refer to the LKD1000 Controller Manual)

LKD1000 button	Camera OSD operation
Cam OSD button	Displays or removes the setup menu.
ZOOM IN button	Use to move upper direction on the menu screen.
ZOOM OUT button	Use to move lower direction on the menu screen.
FOCUS NEAR button	Use for the increase value of the option.
FOCUS FAR button	Use for decrease the value of the option.
Open/Close(Enter) button	Executes selections and displays a submenu for an item with the mark.

Setup Menu Overview

The following table shows the list of menu items and options. You can adapt the camera to your requirements by setting up the respective items in these menus.

1st level	2nd level	3rd level	Contents	
CAMERA SET	FOCUS	FOCUS MODE	AUTO/MANUAL/ONE PUSH/ZOOM TRIG	
		FOCUS DIST	50cm/1m/3m/5m	
		RETURN		
	EXPOSURE	IRIS	AUTO/MANUAL	
		AGC	0~10	
		WDR/BLC	OFF/WDR/BLC/HSBLC	
		BRIGHTNESS	0~100	
		SHUTTER	AUTO,OFF,A.FLK,1/160...1/120000, X512...X2	
		SENS-UP	OFF/AUTO X2/AUTO X3.../AUTO X128	
		RETURN		
		WHITE BALANCE	AUTO	
	MANUAL		COLOR TEMP	INDOOR/OUTDOOR
			RED	-100~100
			BLUE	-100~100
			RETURN	
	ONE PUSH			
	ATW			
	DAY/NIGHT	AUTO	D/N LEVEL	LOW/MIDDLE/HIGH
			DWELL TIME	5/10/15/30/60 SEC
			RETURN	
		DAY		
	NIGHT			
	3D-DNR	OFF/LOW/MIDDLE/HIGH		
	COLOR	ON	LEVEL	-20~20
			RETURN	
		OFF		
	SHARPNESS	0~68		
D-EFFECT	OFF/V-FLIP/MIRROR/ROTATE			
STABILIZER	OFF/ON			
RETURN				

1st level	2nd level	3rd level	Contents		
PAN/TILT SET	PRESET	SET PRESET	NAME	ON/OFF	
			SPEED	1/SEC,10/SEC...360/SEC...500/SEC	
			DWELL TIME	1 SEC~255 SEC	
			IRIS	AUTO/20/40/60/80/100%	
			WDR/BLC/ HSBLC	OFF/LOW WDR/ MID. WDR /HIGH WDR/LOW BLC/MID. BLC/ HIGH BLC/HSBLC0.../HSBLC5	
			SHUTTER	AUTO,OFF,A.FLK,1/160...1/120000, X512...X2	
			SET POSITION		
			SAVE		
			RETURN		
		GOTO PRESET	0~127		
		PRESET TOUR			
		CLEAR PRESET	0~127		
		CLEAR ALL			
		FREEZE	OFF/ON		
		RETURN			
		GROUP TOUR	SET GROUP	1~9	
			RUN	1~9	
			CLEAR	1~9	
	RETURN				
	PATTERN	RECORD	1~4		
		RUN	1~4		
		RETURN			
	AUTO PAN	SET AUTO PAN	1~8		
		RUN			
		CLEAR			
		RETURN			
	SWING	SET SWING(1~8)	POSITION 1	PRESET 0~127	
			POSITION 2	PRESET 0~127	
			SPEED	1/SEC,10/SEC...180/SEC	
			DWELL TIME	1~60SEC	
			SAVE		
			RETURN		
		RUN	1~8		
		CLEAR	1~8		
		RETURN			

1st level	2nd level	3rd level	Contents			
PAN/TILT SET	PRIVACY MASK	MASK NUMBER	1~8			
		SET MASK				
		MASK STATE	OFF/ON			
		MASK COLOR	GRAY/WHITE/BLACK			
		WIDTH	2~320			
		HEIGHT	3~240			
		RETURN				
	SPECIAL	PROPORTIONAL PT	OFF/ON			
		COMPASS	SET/ON/OFF			
		HOME POSITION	ON	SET POSITION		
				GO		
				DWELL TIME	0~100 MIN	
				RETURN		
			OFF			
		AUTO RETURN	ON	RETURN TIME	1~100 MIN	
				RETURN		
				OFF		
		TILT LIMIT	OFF/ON			
		AUTO FLIP	OFF/ON			
		MOTION DET	ON	SENSITIVITY	0~100	
				WIDTH	2~8	
				HEIGHT	2~6	
				MOVE X	1~7	
				MOVE Y	1~5	
				RETURN		
				OFF		
	COMMUNICATION	PROTOCOL	LG-Multix/Pelco-D/Pelco-P/Pelco-C			
BAUD RATE			2400/4800/9600/19200/38400 bps			
SAVE & EXIT						
RETURN						
RETURN						
RETURN						
OSD SET	USER TITLE	OFF/ON				
	ZOOM MAG	OFF/ON				
	FUNCTION	OFF/ON				
	ID	OFF/ON				
	RETURN					
LANGUAGE	ENG/한국어/ 中文/日本語					

1st level	2nd level	3rd level	Contents	
ALARM SET	ALARM IN (1~3)	ON	NORMAL	OPEN/CLOSE
			ALARM IN (1~3)	PRESET 0~127
			DWELL TIME	3~255 SEC
			RETURN	
		OFF		
	ALARM OUT	ON	ALARM OUT	ALARM IN 1~3/MOTION DET
			DWELL TIME	3~255 SEC
			RETURN	
			OFF	
	RESET	INFORMATION	PTZ S/W VER	
CAM S/W VER				
ID				
PROTOCOL				
BAUD RATE				
INITIALIZATION				
FACTORY RESET				
RETURN				
RETURN				

Menu settings

Camera menu settings

Focus setting

The camera adjusts the focus automatically by sensing the center of the picture.

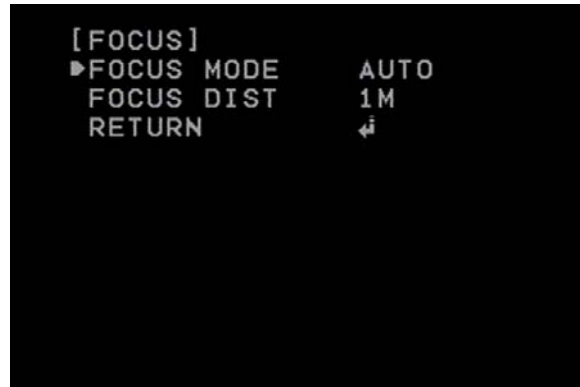
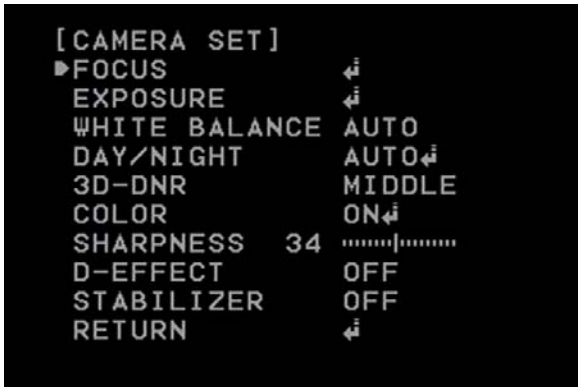

Focus mode

Select [FOCUS MODE] option on the [FOCUS] menu and then select the following mode.

- AUTO: Auto-focus is activated automatically.
- MANUAL: Focus is activated automatically after the zoom movement is finished. If you want to control the focus manually, press the FOCUS (NEAR or FAR) buttons on the controller.
- ONE PUSH: The focus is activated manually. If the camera is received auto-focus command, the camera is activated auto-focus mode and the focus is set automatically and then the focus mode is automatically changed to manual mode.
- ZOOM TRIG: The focus is activated manually. If you change the zoom, the focus is activated automatically and then the focus mode is automatically changed to manual mode

Focus Distance setting

Selects the minimum shooting distance for the focus. Select [FOCUS DIST] option on the [FOCUS] menu and then select a focus distance value

Exposure settings

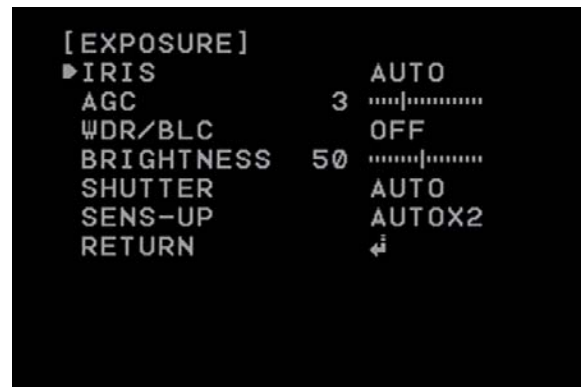
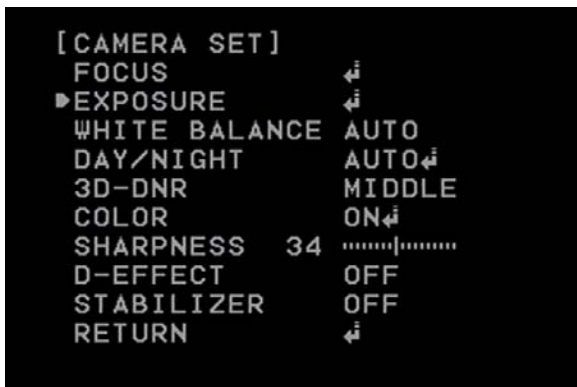

IRIS setting

Select the desired lens iris value for camera exposure. Select [IRIS] option on the [EXPOSURE] menu, then select a value.

- AUTO: The lens iris is set automatically.
- MANUAL: Use [Near] or [Far] button to select the DC Iris level. DC Iris level are set by one parameter unit.

AGC (Automatic Gain Control) Setting

If the images are too dark, change the maximum [AGC] value to make the images bright.

1. Select [AGC] option on the [EXPOSURE] menu.
2. Use [Near] or [Far] button to select a mode.

WDR/BLC setting

Use WDR/BLC option to set the options for BLC or WDR camera.

1. Select [WDR/BLC] option on the [EXPOSURE] menu.
 2. Use [Near] or [Far] button to select a mode then press [Open] or [Close].
- WDR LEVEL: WDR (Wide dynamic range) feature can be very helpful to cope with very challenging lighting conditions. It is capable of capturing both of the dark part and bright part and combining the differences into a scene to generate a highly realistic image as original scene. Set the WDR level (LOW, MIDDLE, HIGH)
 - BLC LEVEL: Camera's backlight compensation feature helps alleviate issues of visibility in high contrast areas. Set the BLC level (LOW, MIDDLE, HIGH)
 - HSBLC: Use for masking brightness of the specific area to view the subject more clearly.
 - HSBLC LEVEL: Select the HSBLC level. (0~5)
 - COLOR: Use [Near] or [Far] button to select a color.
 - OFF: Not used.

Brightness Setting

You can increase the brightness of the darkened video. If you set the brightness to lower value, the image is darkened. If you set the brightness to higher value, the image gets bright.

1. Select [BRIGHTNESS] option on the [EXPOSURE] menu.
2. Use [Near] or [Far] button to set the bright level.

Shutter (Shutter Speed) Setting

Select the desired shutter speed for camera exposure. You can change the shutter speed to higher speed to capture fast-moving subjects, though the image becomes darker.

1. Select [SHUTTER] option on the [EXPOSURE] menu.
2. Use [Near] or [Far] button to set shutter speed.

SENS-UP Setting

If pictures are not clear due to darkness, use this function to increase the sensitivity of picture.

1. Select [SENS-UP] option on the [EXPOSURE] menu.
2. Use [Near] or [Far] button to set the SENS-UP limit. To set the SENS-UP function, select the [AUTO] on the [SHUTTER]

NOTE

If you set to one of the SHUTTER options except AUTO on the [SHUTTER] menu, the [SENS-UP] setting is not available and [---] mark is displayed.

White Balance Setting

Select the method by which the camera shifts its output colors to compensate for the color of a light source



1. Select [WHITE BALANCE] option on the [CAMERA SET] menu.
 2. Use [Near] or [Far] button to select a mode then press [Open] or [Close].
- ATW (Auto-Tracing White Balance): In this mode, the color temperature range for the proper white balance is approximately from **1700K** to 11000K. Proper white balance may not be obtained under the following conditions:
 - When the color temperature is out of the 1800K to 11000K range
 - When the scene mostly contains high color temperature objects, such as a blue sky or sunset
 - When the scene is dim.
 - AUTO: In this mode, the color temperature range for the proper white balance is approximately **3500 K to 6500 K**. Proper white balance may not be obtained under the following conditions:
 - When the color temperature is out of the **3500K to 6500K** range.
 - When the scene mostly contains high color temperature objects, such as a blue sky or sunset.
 - When the scene is dim.

- MANUAL: You can set the white balance options manually.



- COLOR TEMP: Use [Near] or [Far] button to select a function.
 - INDOOR: The color temperature range for the proper white balance is approximately 3600K.
 - OUTDOOR: The color temperature range for the proper white balance is approximately 6500K.
 - RED: Set the desired red value. (-100 to 100)
 - BLUE: Set the desired blue value. (-100 to 100)
- ONE PUSH: If you select the ONE PUSH mode, you will be able to set up the White Balance automatically using [Open] or [Close] button.

DAY/NIGHT Setting

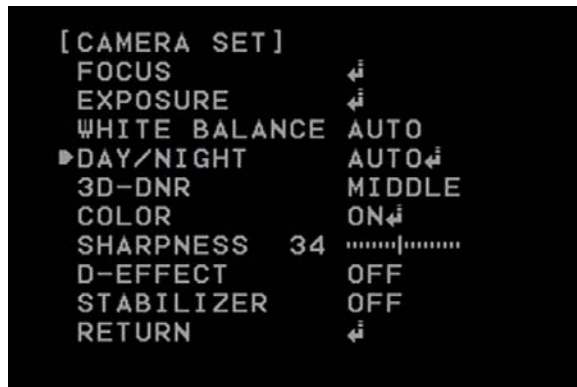

1. Select [DAY/NIGHT] option on the [CAMERA SET] menu.
2. Use [Near] or [Far] button to select the mode.
 - AUTO: You will be able to change the Day/Night mode automatically.

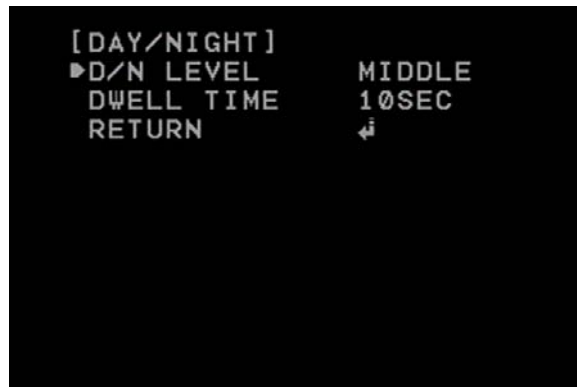

- D/N LEVEL: Use [Near] or [Far] button to select a level.
- DWELL TIME: Use [Near] or [Far] button to select a dwell time.
- DAY: Color mode enabled.
- NIGHT: Black-and-white mode enabled.

NOTE

If you set the AGC to [OFF] on the [EXPOSURE] menu, the AUTO mode of the DAY/NIGHT function is not available and [---] mark is displayed.

3D-DNR Setting

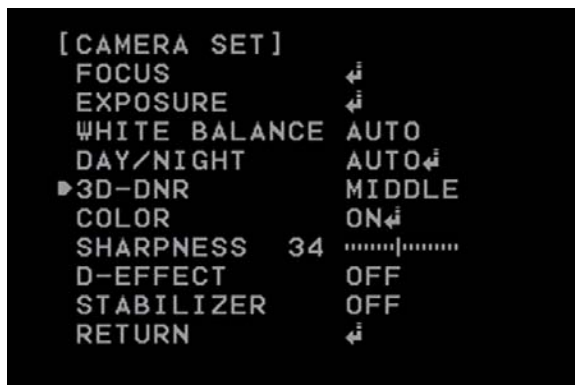

1. Select [3D-DNR] option. If pictures are not clear due to brightness, use this function to reduce the noise of picture.
2. Use [Near] or [Far] button to select an option.

NOTE

- If you set the AGC to [OFF] on the [EXPOSURE] menu, the [3D-DNR] function is not available.
- When you use this function, the afterimage may occur.

Color Setting

You can switch the displayed picture to grayscale or color.

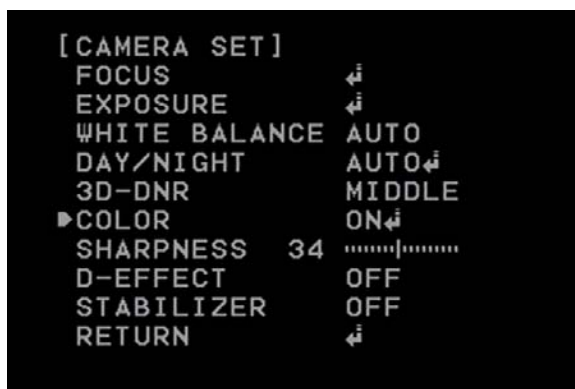

1. Select [COLOR] option on the [CAMERA SET] menu.
2. Use [Near] or [Far] button to change a color effect.
 - ON: To display the picture with color. Select ON and press [Open] or [Close] to display the submenu. You can adjust the color level using the [Near] or [Far] button.
 - OFF: To display the picture with grayscale

Sharpness Setting

Sharpens the image outline.

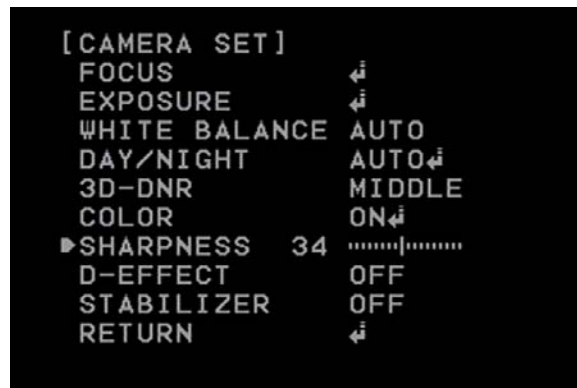

1. Select [SHARPNESS] option on the [CAMERA SET] menu.
2. Use [Near] or [Far] button to adjust the option. If you set the sharpness value to higher, the image outline becomes sharp. If you set to lower value, the image outline becomes dim.

D-Effect Setting

Configures a digital effect to be used in video images. Select one of V-Flip / Mirror / Rotate

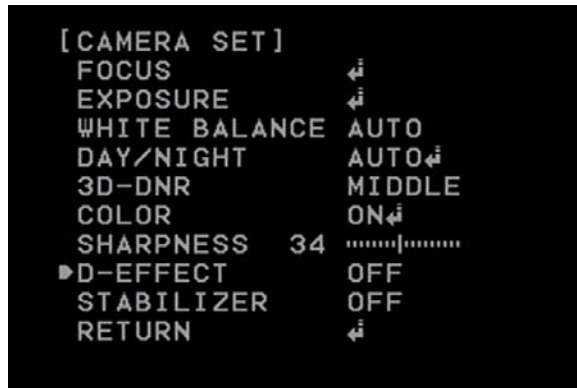

1. Select [D-EFFECT] option on the [CAMERA SET] menu.
2. Use [Near] or [Far] button to adjust the function.

Stabilizer Setting

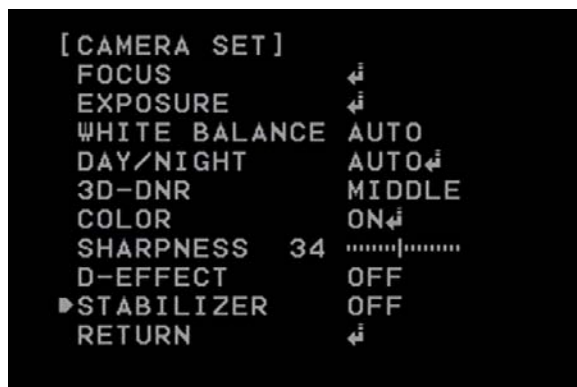

1. Select [STABILIZER] option on the [CAMERA SET] menu.
2. Use [Near] or [Far] button to set up the [ON] or [OFF].

Pan/Tilt Setting

Preset Setting

Preset position is the function to register camera monitoring positions (preset positions) associated with position numbers. By entering the position numbers, you can move cameras to the preset positions.

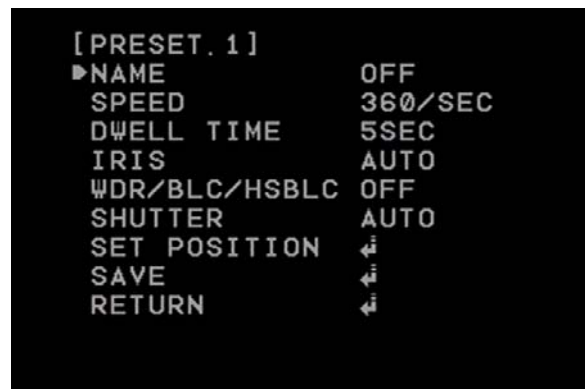
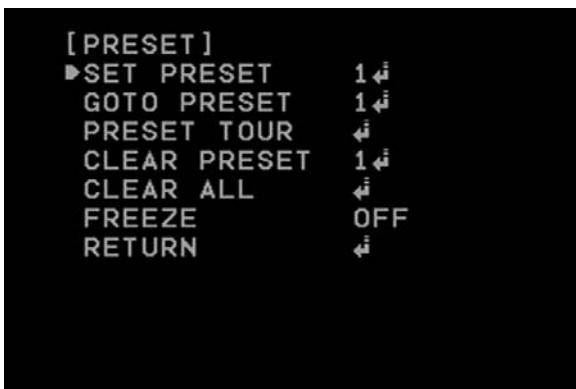
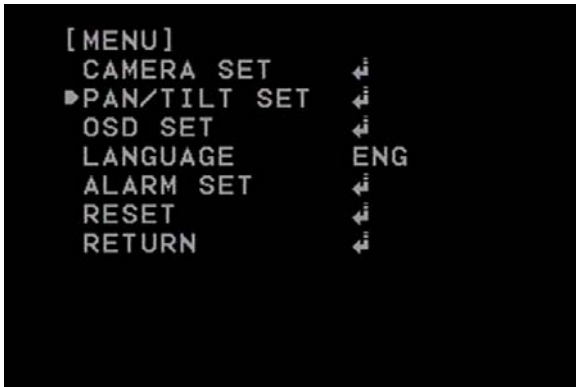

To register preset positions

1. Select the [SET PRESET] option on the [PRESET] menu
2. Use the [Near] or [Far] button to select the preset number you wish to register and press the [Open] or [Close] button.
3. Set the preset name.

How to set the preset name

- ① Set the NAME option to [ON] and press [Open] or [Close] button.
 - ② Use [In], [Out], [Near] or [Far] button to select a character, number, symbol mark or option item.
 - </>: Moves cursor to left or right
 - (Blank): Insert a space at the cursor position.
 - CLR: If you enter the wrong code, select [CLR] then press [Open] or [Close] to delete. All letters will be erased at once.
 - SAVE: Select this option to confirm the settings.
 - EXIT: Select this option to exit the settings.
 - ③ Press [Open] or [Close] button to confirm your selection.
4. Select the speed to move to the preset position.
 5. Select the preset tour dwell time.
 6. Set the IRIS option. IRIS LEVEL are set by 20 % unit (20 %, 40 %, 60 %, 80 %, 100 %)

7. Set the WDR/BLC/HSBLC option.
8. Set the SHUTTER option.
9. Select the [SET POSITION] option and press [Open] or [Close] button.
10. Move the camera to a point you wish by using the joystick and then press [Open] or [Close] button to save it.
11. Select [SAVE] option and press [Open] or [Close] button to confirm the settings. The position and its number are memorized.
12. Repeat steps 1 to 11 to add additional positions.
13. Select [RETURN] option and press [Open] or [Close] button to exit the setting menu.

Moving to preset position

The preset function makes the combination camera move to the programmed preset position. It is necessary to program preset positions for the combination camera beforehand.

1. Select [GOTO PRESET] option on the [PRESET] menu.
2. Select the memorized preset position's index number then press [Open] or [Close] button. The camera moves to the preset position and the picture of the camera in that position appears on the monitor.

To tour the preset positions

You can tour all preset positions.

1. Select [PRESET TOUR] option on the [PRESET] menu. All registered preset positions in the camera will be selected and the camera position image will be switched on the active monitor.
2. You can stop the tour by moving the joystick or pressing any button.

To clear the preset position

You can clear a memorized preset position.

1. Select [CLEAR PRESET] option on the [PRESET] menu.
2. Selects the memorized preset index number then press [Open] or [Close] button to clear the preset positions.

To clear all the preset position

You can clear all of the memorized preset positions at once.

1. Select [CLEAR ALL] option on the [PRESET] menu.
2. Press [Open] or [Close] button to clear the all preset positions.

Freeze function

1. Select [FREEZE] option on the [PRESET] menu.
2. Use [Near] or [Far] button to set up the [ON] or [OFF].

Group Tour Setting

You can create a group using preset positions that are registered already. A maximum of 9 groups is available.



To set the group

1. Select [SET GROUP] option on the [GROUP TOUR] menu.
2. Select the group number and press [Open] or [Close] button.

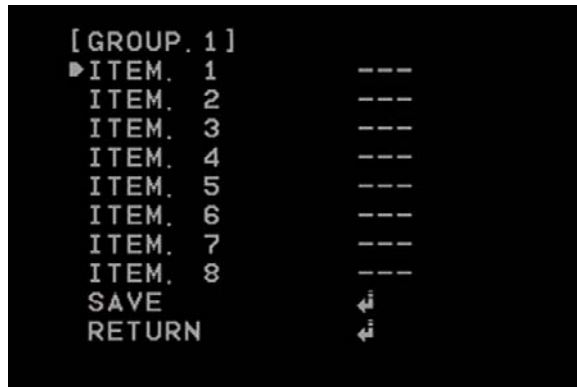

3. Set the group item. You can set the group item up to 8.
4. Select [SAVE] option and press [Open] or [Close] button to confirm the settings.
5. Select [RETURN] option and press [Open] or [Close] button to exit the setting menu.

To tour the group

You can tour the group that is registered already.

1. Select [RUN] option on the [GROUP TOUR] menu.
2. Select the group number and press [Open] or [Close] button. The camera moves to the preset position in the group and the picture of the camera in that position appears on the monitor.

To delete a group

You can delete a memorized group.

1. Select [CLEAR] option on the [GROUP TOUR] menu.
2. Select the group number and press [Open] or [Close] button. The group will be deleted.

Pattern Setting

You can activate the camera in a repeating pattern. The pattern is programmed by recording your manual pan, tilt, and zoom operations. The camera stores the movements you performed in memory.

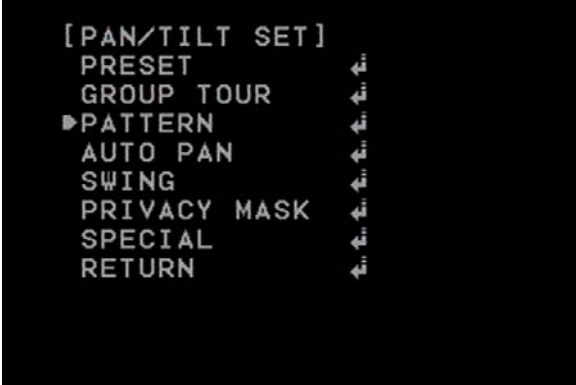

To record the pattern

1. Select [RECORD] option on the [PATTERN] menu.
2. Select the recording number and press [Open] or [Close] button. The pattern recording is started.
3. Move the camera through the desired movement.
4. Press [Open] or [Close] button to stop the pattern recording

NOTE

- The available total time of pattern differs depending on operation.
- When recording time is completed regardless of remained storage, indication for remained storage should be shown as "TIME OUT"

To play the pattern

1. Select [RUN] option on the [PATTERN] menu.
2. Select the recording number and then press [Open] or [Close] button to play the programmed pattern. The tour will play indefinitely until you stop it by moving the joystick or pressing any button.

Auto Pan Setting

By selecting the Auto Pan number, the camera pans automatically. In Auto Pan setting, the "Auto Flip" function is not available.

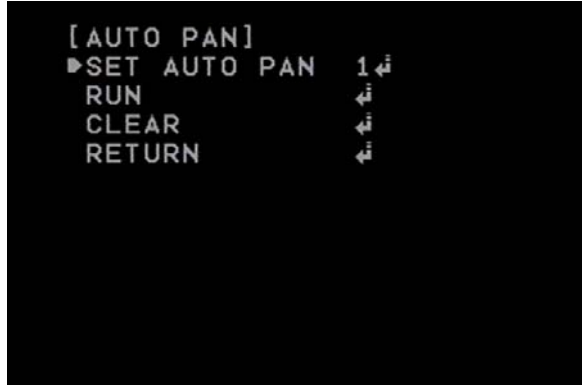
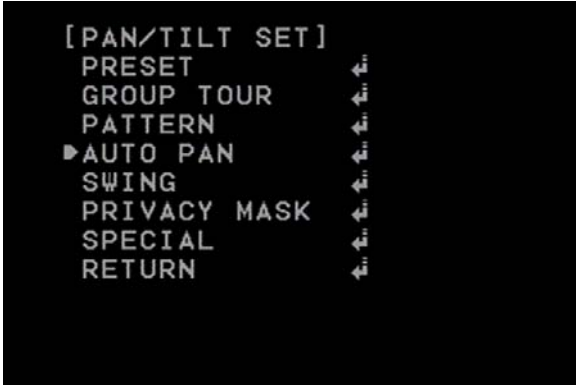

To set the Auto Pan positions

1. Select [SET AUTO PAN] option on the [AUTO PAN] menu.

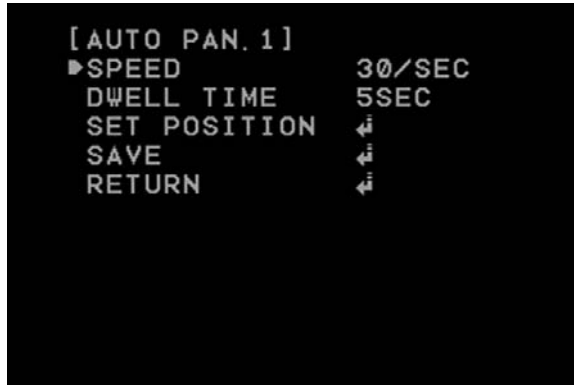

2. Select the moving speed.
3. Select the Auto pan dwell time.
4. Select the [SET POSITION] option and press [Open] or [Close] button.
5. Move the camera to the desired position by using the joystick and then press [Open] or [Close] button.
6. Select the [SAVE] option and press [Open] or [Close] button.
7. Select the [RETURN] option and press [Open] or [Close] button. The number of Auto Pan will be increased automatically.
8. Repeat steps 1 to 7 to add additional positions.
9. Select [RETURN] option and press [Open] or [Close] button to exit the setting menu.

To play the Auto Pan

1. You can play the camera with auto pan function.
2. Select [RUN] option on the [AUTO PAN] menu.
3. You can stop the Auto pan function by moving the joystick or pressing any button.

To delete the Auto Pan position

You can delete the memorized auto pan position.

1. Select [AUTO PAN] option on the [PAN/TILT] menu.
2. Select [CLEAR] option then press [Open] or [Close] button to delete the Auto pan position

Swing Setting

Swing is the function that a camera scans between 2 preset positions. In case that only one preset is configured or one preset is configured in both of position 1 and position 2, a camera scans by 360 degrees on pan direction. Also one preset or both of 2 presets in Swing are not pre-defined, Swing does not work.

In Swing function, video parameters pre-defined in each preset such as Iris, BLC and Shutter do not work. Also Freeze configurations pre-defined in each preset are ignored although Freeze configurations are configured in each preset.

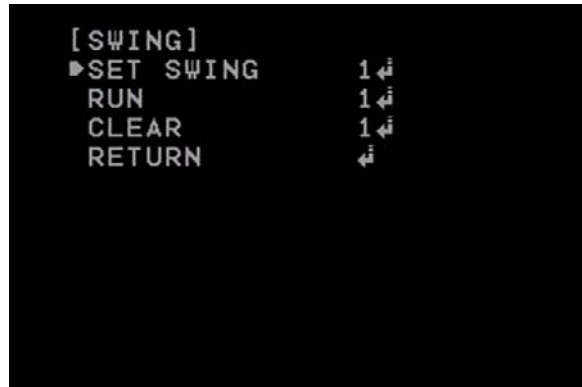

To set the Swing

1. Select a Swing to be configured in [Swing] menu with [Near] and [Far] button. Then press [Open] button or [Close] button to configure the Swing

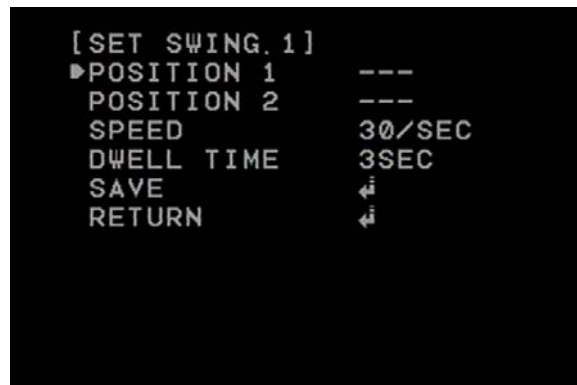

2. Select a preset in [POSITION 1].
3. Select another preset in [POSITION 2].
4. Configure a speed between the 2 selected presets in [SPEED].
5. Configure a time which a camera dwells at the 2 selected presets in [DWELL TIME].
6. Select [SAVE] to save all configurations. Then a camera will save all configurations and automatically move back to the previous menu.
7. Select [RETURN] to cancel saving all the configurations.
8. To set up another Swing, select another Swing and repeat 2 ~ 6.

To play the Swing

1. Select [RUN] in [Swing] menu to run a Swing
2. Select a Swing to run with [Near] and [Far] button and press [Open] button or [Close] button. A camera scans the 2 pre-defined presets.

To delete the Swing

You can delete a memorized swing.

1. Select [CLEAR] option on the [SWING] menu.
2. Select the swing number and press [Open] or [Close] button. The swing will be deleted.

Privacy Mask Setting

This function is aiming at the protection of personal privacy, the mask zone is not displayed on the screen. Up to 8 zones can be registered.

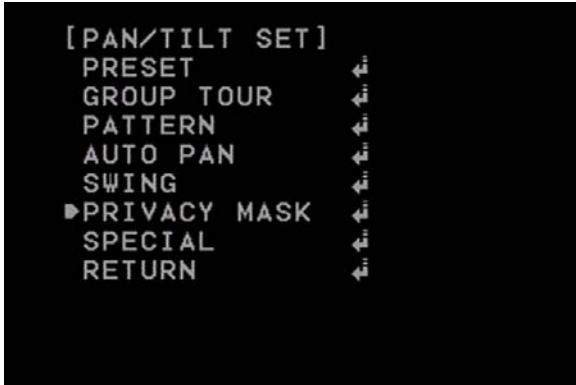

1. Select [PRIVACY MASK] option on the [PAN/TILT MENU].
2. Press [Open] or [Close] button to display the PRIVACY MASK MENU.
3. Use [Near] or [Far] button to select a zone number on the [MASK NUMBER] option.
4. Select the [SET MASK] option and press [Open] or [Close] button.
5. Select the mask zone using the joystick and then press [Open] or [Close] button to save it.
6. Use [Near] or [Far] button to set up the [ON] or [OFF] on the [MASK STATE] option. If you already registered the mask zone and set to ON, the mask zone box appears on the monitor.
7. Use [Near] or [Far] button to select the color of the mask zone box on the [MASK COLOR] option.
8. Select the [WIDTH] option and use [Near] or [Far] button to adjust the horizontal size of the mask zone box.
9. Select the [HEIGHT] option and use [Near] or [Far] button to adjust the vertical size of the mask zone box.
10. Repeat steps 3 to 9 to add additional positions.

NOTE

If you change the color of a mask, the color of all masks will be changed.

Special Setting

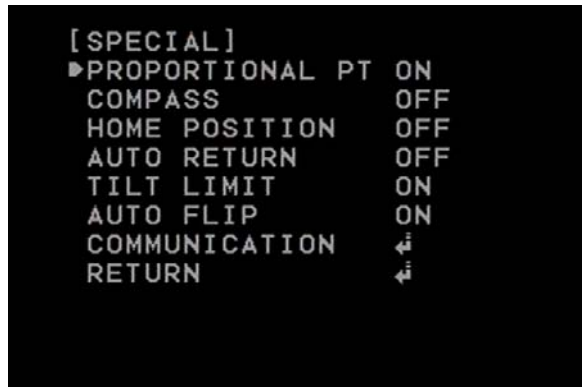
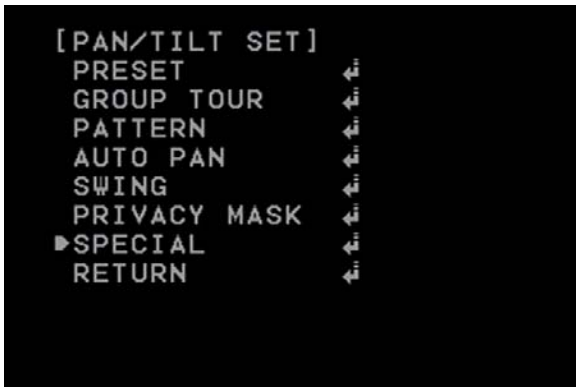

Propotional PT

This function optimizes the image by automatically adjusting the PAN/TILT (horizontal/vertical rotation) speed according to the zoom ratio.

1. Select [PROPORTIONAL PT] option on the [SPECIAL] menu.
2. Use [Near] or [Far] button to toggle it on and off.
 - ON : Pan/tilt speed is in inverse proportion to the zoom ratio.
 - OFF : The speed is constant at the fastest level regardless of the zoom ratio.

Compass

You can display the north, south, east and west information on the screen.

1. Select [COMPASS] option on the [SPECIAL] menu.
2. Set the [COMPASS] option to [SET] and then press [Open] or [Close] button.
3. Select north point using the joystick and then press [Open] or [Close] button.
4. Set the [COMPASS] option to [ON].

Home position

The home position is the camera's basic position. The camera returns to this position whenever you want. Use the following procedure to make the home position.

1. Select [HOME POSITION] option on the [SPECIAL] menu.
2. Use [Near] or [Far] button to set it ON.
3. Press [Open] or [Close] button.
4. Select [SET] option and then press [Open] or [Close] button.
5. Select the home position where you want and then press [Open] or [Close] button.
6. Select [DWELL TIME] option and then select the dwell time.
7. Select [RETURN] option and press [Open] or [Close] button to exit the setting menu.

Go to Home Position

1. Select [HOME POSITION] option on the [SPECIAL] menu.
2. Use [Near] or [Far] button to set it ON.
3. Press [Open] or [Close] button.
4. Select [GO] option and then press [Open] or [Close] button. The camera will move to the home position.

NOTE

- If you do not want to use the home function, set the [HOME POSITION] to [OFF].
- If you set the [HOME POSITION] to [ON], the [AUTO RETURN] option is set to [OFF] automatically and you can not use it.

Auto Return

This function can be used to specify automatic return to a particular mode if a certain amount of time elapses without any operation being performed.

1. Select [AUTO RETURN] option on the [SPECIAL] menu.
2. Use [Near] or [Far] button to set it [ON] and then press [Open] or [Close] button.
3. Select [RETURN TIME] option and then select the auto return time.
4. Select [RETURN] option and press [Open] or [Close] button to exit the setting menu

NOTE

If you set the [AUTO RETURN] to [ON], the [HOME POSITION] option is set to [OFF] automatically and you can not use it.

Tilt Limit

To remove block area on videos, tilt angle limit can be configured.

1. Select [TILT LIMIT] in [SPECIAL].
2. To turn on this function, select [ON] with [Near] button or [Far] button. To turn off this function, select [OFF] with [Near] button or [Far] button.

Auto Flip

In the event that tilt angle arrives at the top of the tilt orbit (90°), the camera turns on its axis by 180° at the top of the tilt orbit and moves to the opposite tilt direction (180°) to keep tracing targets.

1. Select [AUTO FLIP] in [SPECIAL].
2. To turn on this function, select [ON] with [Near] button or [Far] button. To turn off this function, select [OFF] with [Near] button or [Far] button.

Motion Det

Configures the parameters for Motion Detection function.

1. Select [SPECIAL] menu and set [MOTION DET] option to [ON]. And then press [Open] button or [Close] button to enter into its sub-menus.

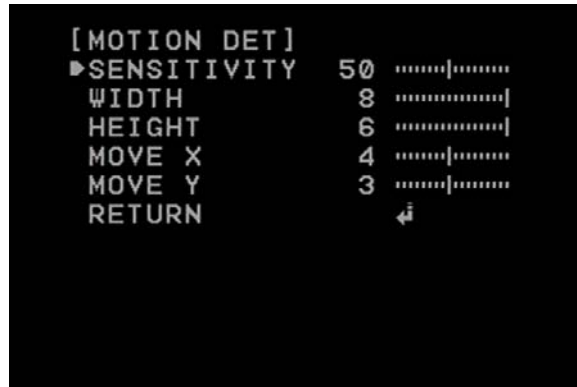

2. Adjust detection sensitivity with [Near] button or [Far] button in [SENSITIVITY] option.
3. Adjust detection area with [Near] button or [Far] button in [WIDTH] and [HEIGHT] option.
4. Adjust center of detection area with [Near] button or [Far] button in [MOVE X] and [MOVE Y] option.
5. Select [RETURN] and exit [MOTION DET] menu with [Open] button or [Close] button.

NOTE

- Even though Motion Detection function is set to [ON], Motion Detection function does not work in the following cases.
 - When OSD Menu is being configured
 - When Pan/Tilt/Zoom function is working
 - When Pattern or Swing or Auto Pan is working
- When motion is detected during Preset Tour or Group Tour, waiting time is automatically extended. When motion is not detected any more, waiting time starts running.
- When there are alarm inputs, waiting time is not extended even though motion is detected.

Communication

This setting is required to establish a connection between the system controller and the camera.

1. Select [COMMUNICATION] option on the [SPECIAL] menu.
2. Press [Open] or [Close] button.
3. Set the below options.
 - Protocol: This item lets you set a protocol for RS-485 communication. Select the desired protocol.
 - Baud Rate: Select the desired speed of communication between the system controller and the camera. Confirm selected parameter to the baud rate of the system controller.
 - SAVE & EXIT: Select this option and then press [Open] or [Close] button to save the communication settings and exit the setting menu.

OSD Settings

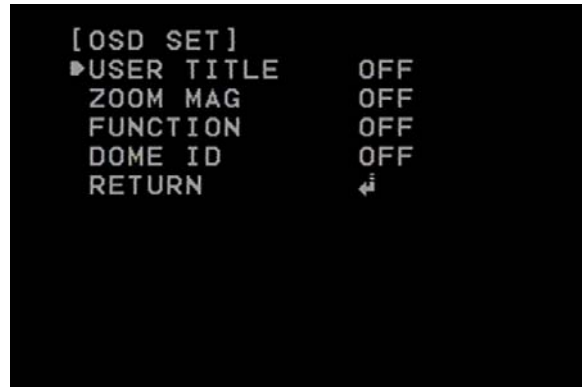
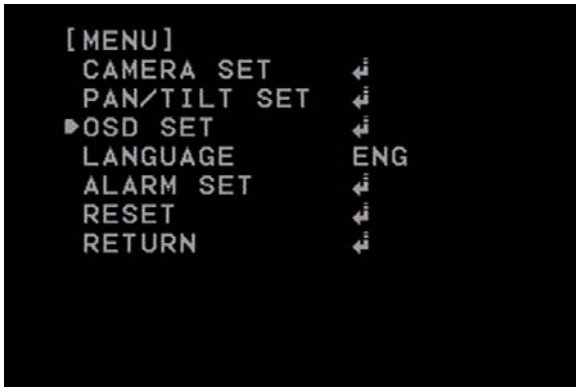

User Title Setting

You can use the camera identification to assign a number and character to the camera.

1. Select [USER TITLE] option on the [OSD] menu.
2. Use [Near] or [Far] button to set it [ON].
3. Press [Open] or [Close] button. The USER TITLE menu appears.
4. Use [In], [Out], [Near] or [Far] button to select a character, number, symbol mark or option item.

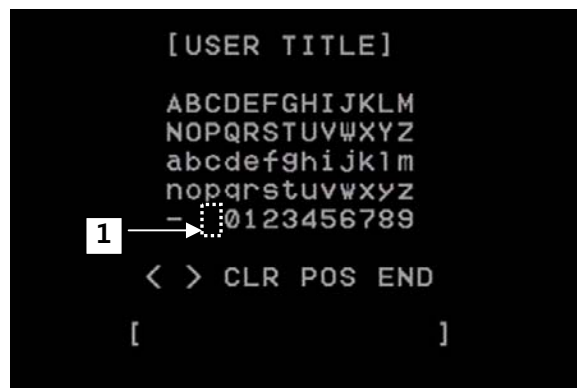

- </>: Moves cursor to left or right.
- **1** (Blank): Insert a space at the cursor position.
- CLR: If you enter the wrong code, select [CLR] then press [Open] or [Close]. All letters will be erased at once.
- POS: Move the USER TITLE position on the screen using the [Near] or [Far] buttons.
- END: Select this option to exit the settings

ZOOM MAG Setting

Displays or removes the zoom OSD on the screen.

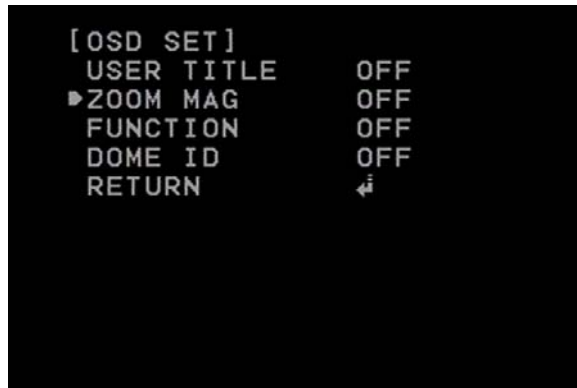

1. Select [ZOOM MAG] option on the [OSD] menu.
2. Use [Near] or [Far] button to set it [ON] or [OFF].
3. Select [RETURN] option and press [Open] or [Close] button to exit the setting menu

FUNCTION Setting

Displays or removes the Function OSD on the screen.

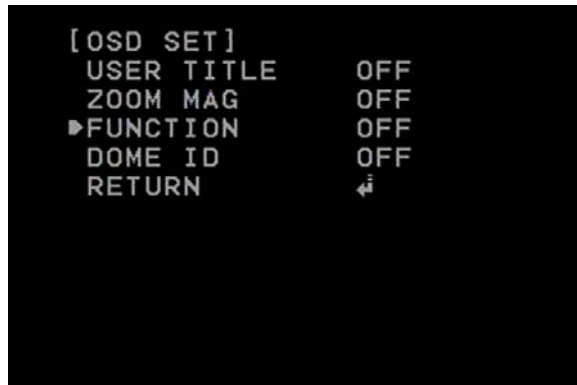

1. Select [FUNCTION] option on the [OSD] menu.
2. Use [Near] or [Far] button to set it [ON] or [OFF].
3. Select [RETURN] option and press [Open] or [Close] button to exit the setting menu

DOME ID Setting

Displays or removes the Camera ID OSD on the screen.

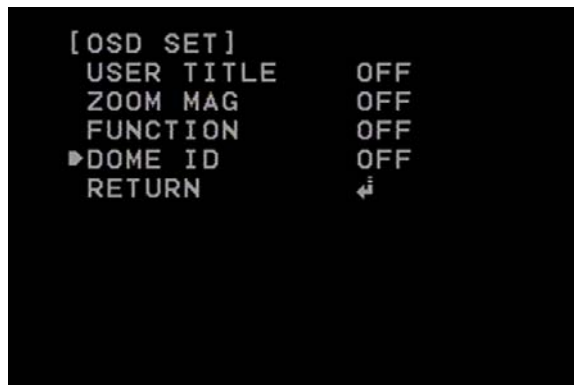

1. Select [DOME ID] option on the [OSD] menu.
2. Use [Near] or [Far] button to set it [ON] or [OFF].
3. Select [RETURN] option and press [Open] or [Close] button to exit the setting menu

LANGUAGE Setting

Select a language for the setup menu and OSD display.

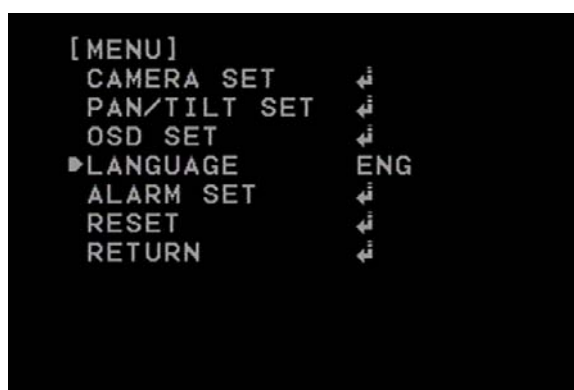

ALARM Setting

This camera has a terminal that can sense the alarm signals. The camera can be programmed to go to a preset with a signal from any connected alarm device.

Function status	Mode
While observe a specific position	Change the observe position to the alarmed position then return to the position that previously observed.
While operating Preset Tour function	Stop preset touring and change the observe position to the alarmed position then restart the preset touring again.
While operating Auto Pan function	Stop auto panning and change the observe position to the alarmed position then restart the auto panning again.
While operating Pattern function	Stop operating pattern function and change the observe position to the alarmed position during the dwell time then restart the pattern function again.
While operating Swing function	Stop operating swing function and change the observe position to the alarmed position during the dwell time then restart the swing function again.
in case of HOME POSITION is ON	After Alarm has been cleared and finished the dwell time, it moves to the HOME POSITION and spend the dwell time at that position.

NOTE

During the dwell time for alarm, you can not control the controller.

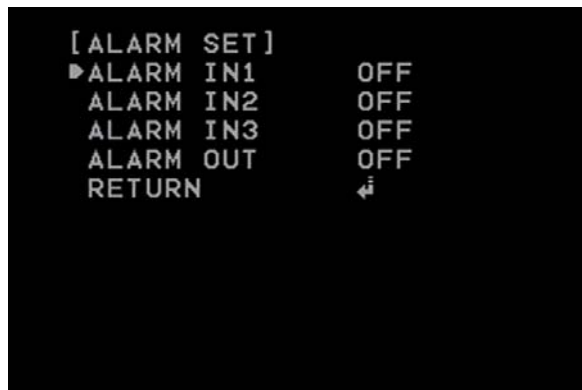
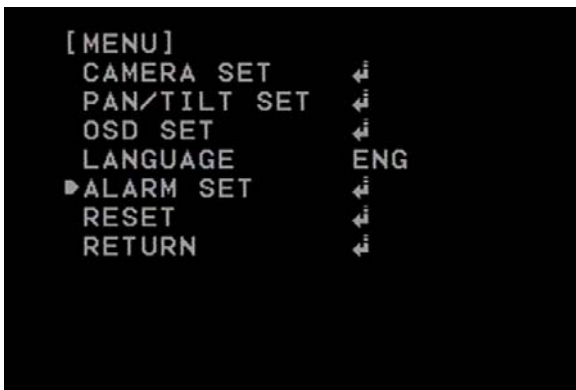

Alarm In Setting

1. Select one of the alarms in option on the [ALARM SET] menu.
2. Use [Near] or [Far] button to set it [ON].
3. Press [Open] or [Close] button.



4. Select [NORMAL] option and select [Open] or [Close] option.
 - OPEN: Activate the alarm in the close position.
 - CLOSE: Activate the alarm in the open position.
5. Select [ALARM IN(1 to 3)] option and select preset number. When the alarm is triggered, the camera moves to the selected preset position. The presets run continuously until alarm source is off.
6. Select [DWELL TIME] option and then set the alarm dwell time. The alarm is stopped after selected dwell time

Alarm Out Setting

1. Select one of the alarm out options on the [ALARM SET] menu.
2. Use [Near] or [Far] button to set it [ON].
3. Press [Open] or [Close] button.

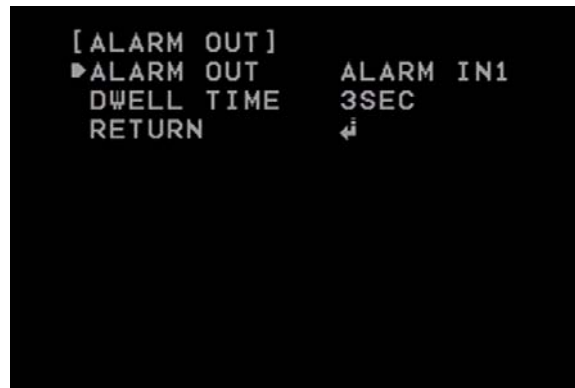

4. Select alarm input number or motion detection on the [ALARM OUT] option. When the selected function is activated, the alarm signal is outputted.
5. Select [DWELL TIME] option and then set the alarm dwell time. The alarm output is stopped after selected dwell time.

RESET Setting

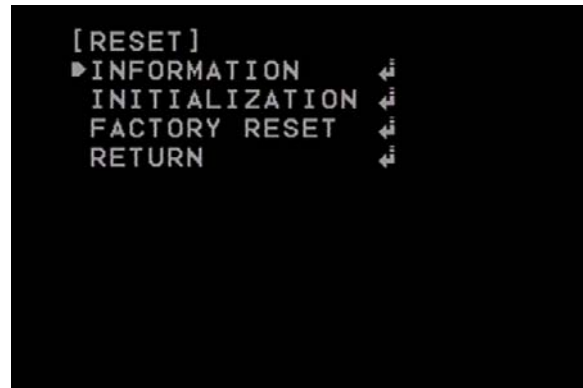
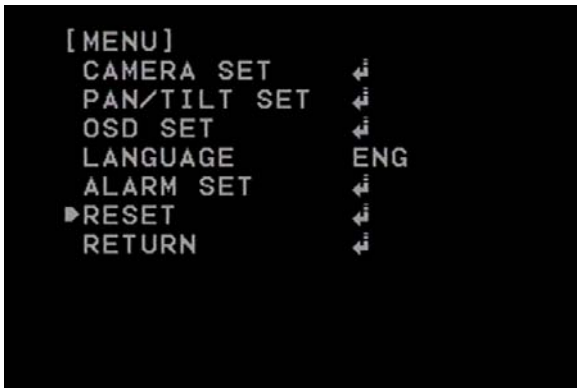

Information

You can view the current camera information such as PTZ software version, camera software version, camera ID, Protocol and Baud Rate.

1. Select [INFORMATION] option on the [RESET] menu.
2. Press [Open] or [Close] button to display the current camera information.

Initialization

You can reboot the camera.

1. Select [INITIALIZATION] option on the [RESET] menu.
2. Press [Open] or [Close] button then confirmation window is displayed.
3. Select [YES] and press [Open] or [Close] button.

Factory Reset

Clear certain settings and information and return to factory default settings.

1. Select [FACTORY RESET] option on the [RESET] menu.
2. Press [Open] or [Close] button then confirmation window is displayed.
3. Select [YES] and press [Open] or [Close] button. The camera will return to the factory default settings.

Specifications

Camera Part		
Model	L9322-BN	L9322-BP
Signal System	NTSC	PAL
Pick-Up Device	4.5mm (1/4 inch Type) CCD	
Total Pixel No	520K Pixels	610K Pixels
Effective Pixel No	480K Pixels	570K Pixels
Horizontal Resolution	600 TV Lines	
Lens	12X, F1.6(Wide),F2.7(Tele) f=3.80~45.6 mm	
S/N Ratio	50 dB (AGC Off)	
Day & Night	Day / Night / Auto(ICR)	
Minimum Illumination (30IRE)	B/W : 0.05 lux (Sens up off), 0.003 lux (Sens up on)	
Digital Zoom	×12	
Sync System	Internal	
White Balance	Auto / One Push / Manual / ATW (1,700°K ~ 11,000°K)	
Electric Shutter	1/60 ~ 1/120,000 second	1/50 ~ 1/120,000 second
Iris Control	Auto / Manual	
Backlight Control	WDR / BLC/ HSBL/ Off	
Noise Reduction	3D-DNR (Off/ Low / Middle / High)	
AGC	0~10 Levels	
Snes-Up	Off / Auto (x2, x3, x4,, ...x128)	
D-Effect	Off / V-Flip / Mirror / Rotate	
Stabilizer	Off / On	
Privacy Mask	8 Masks	

Mechanism		
Pan/Tilt Range	Pan : 360°(Endless), Tilt : 90°	
Speed	Preset	500°/sec
	Jog	0.05 ~ 120°/sec (Zoom proportional)
Preset	128 presets	
Auto Pan	2 to 8 points	
Pattern	4 pattern (920 commands/pattern)	
Swing	8 Swings	
Group Tour	9 Group (8 actions/group)	
Communication	RS-485	
Protocol	LG-Multix, Pelco-D, Pelco-P, Pelco-C	
Motion Detection	Sensitivity, Area Adjustable	
Alarm Input	3 channels	
Alarm Output	1 channel	
Video Output	Composite Output 1Vp-p (75Ω Terminated)	
Operating Temperature	-10°C ~ 50°C (Humidity 0%~80%RH)	
Safekeeping Temperature	-20°C ~ 60°C (Humidity 0%~90%RH)	
Rated Voltage	AC 24V or DC 12V (Dual Power)	
Power Consumption	12 W	
Dimension (∅ × H)	150 mm × 143 mm	
Weight	860 g	