



LG

Life's Good

ENGLISH

عربي

OWNER'S MANUAL

SXS

REFRIGERATOR

Please read this guide thoroughly before operating and keep it handy for reference at all times.

Table of contents

Introduction	Entry	4
	Important safety instruction	4
	Important safety instruction	5
	Identification of parts	12
Installation	Where to install	13
	Door removal	14
	Door replacement	15
	When the freezer door is lower than the refrigerator door	15
	When the refrigerator door is lower than the freezer door	15
Operation	Starting	16
	Adjusting the temperatures and functions	16
	Refreshment center (Applicable to some models only)	19
	Wine holder (Applicable to some models only)	20
	Ice making	20
	Shelf(Applicable to some models only)	21
	Deodorizer(Applicable to some models only)	21
	Egg box	22
	Humidity control in the vegetable compartment	22
Convert into a vegetable or meat compartment	22	
Suggestion on food storage	Location of foods	23
	Storing foods	24
Care and maintenance	How to dismantle parts	25
	General information	26
	Cleaning	26
	Trouble shooting	27
	It is normal...	31

Entry

The model and serial numbers are found on the inner case or back of refrigerator compartment of this unit. These numbers are unique to this unit and not available to others. You should record requested information here and retain this guide as a permanent record of your purchase. Staple your receipt here.

Date of purchase : _____
 Dealer purchased from : _____
 Dealer address : _____
 Dealer phone no. : _____
 Model no. : _____
 Serial no. : _____

Important safety instruction

Before it is used, this refrigerator must be properly installed and located in accordance with the installation instructions in this document.

When moving your appliance away from the wall, be careful not to roll over the power cord or to damage it in any way.

After your refrigerator is in operation, do not touch the cold surfaces in the freezer compartment, particularly when your hands are damp or wet. Skin could adhere to these extremely cold surfaces.

Unplug the power cord from the power outlet for cleaning or other requirements. Never touch it with wet hands because you can get an electric shock or be hurt.

Never place glass products in the freezer because they may be broken due to expansion when their contents are frozen.

Never allow your hands within the ice storage bin of the automatic ice maker. You could be hurt by the operation of the automatic ice maker.

The appliance is not intended for use by young children or infirm persons without supervision.

If possible, connect the refrigerator to its own individual electrical outlet to prevent it and other appliances or household lights from causing an overload that could cause a power outage.

The refrigerator-freezer should be so positioned that the supply plug is accessible for quick disconnection when accident happens.

If the supply cord is damaged, it must be replaced by the manufacturer or its service agent or a similarly qualified person in order to avoid a hazard.



Don't use an extension cord

**Accessibility of Supply Plug
Supply Cord Replacement**

⚠ Important safety instruction

BASIC SAFETY PRECAUTIONS

This guide contains many important safety messages. Always read and obey all safety messages.

⚠ This is the safety alert symbol. It alerts you to safety messages that inform you of hazards that can kill or hurt you or others or cause damage to the product. All safety messages will be preceded by the safety alert symbol and the hazard signal word DANGER, WARNING, or CAUTION. These words mean:

⚠ **DANGER** You will be killed or seriously injured if you don't follow instructions.

⚠ **WARNING** You can be killed or seriously injured if you don't follow instructions.

⚠ **CAUTION** Indicates an imminently hazardous situation which, if not avoided, may result in minor or moderate injury, or product damage only.

All safety messages will identify the hazard, tell you how to reduce the chance of injury, and tell you what can happen if the instructions are not followed.

⚠ WARNING

To reduce the risk of fire, electric shock, or injury to persons when using your product, basic safety precautions should be followed, including the following. Read all instructions before using this appliance.

1. When connecting the power

The dedicated outlet should be used.

- Using several devices at one outlet may cause fire.
- The electric leakage breaker may damage food and the dispenser may be leaked.

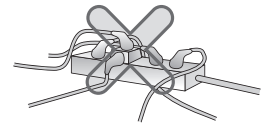

Do not allow the power plug to face upward or to be squeezed at the back of the refrigerator.

Water may be flown into or the plug may be damaged, which causes fire or electric shock.

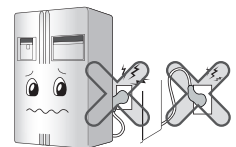

Do not allow the power cord bent or pressed by the heavy object to be damaged.

It may damage the power cord to cause fire or electric shock.



Do not extend or modify the length of the power plug. It causes electric shock or fire by the electric damage of the power cord or others.

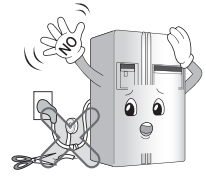

Unplug the power plug when cleaning, handling or replacing the interior lamp of the refrigerator.

- It may cause electric shock or injury.
- When replacing the interior lamp of the refrigerator, make sure that the rubber ring for preventing the electric spark within the socket is not taken off.

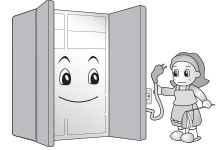

Do not pull out the cord or touch the power plug with wet hands.

- It may cause electric shock or injury.

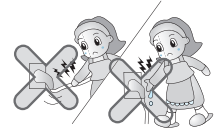

Remove water or dust from the power plug and insert it with the ends of the pins securely connected.

Dust, water or unstable connection may fire or electric shock.

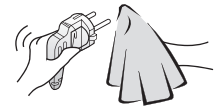

Make sure of grounding.

The incorrect grounding may cause breakdown and electric shock.

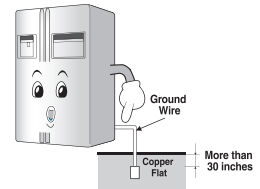

When the power cord or the power plug is damaged or the holes of the outlet are loosed, do not use them.

It may cause electric shock or short circuit to make fire.

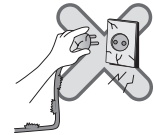

2. When using the refrigerator

Do not place the heavy object or the dangerous object (container with liquid) on the refrigerator.

It may be dropped to cause injury, fire or electric shock when opening or closing the door.



Do not install the refrigerator in the wet place or the place which water or rain splashes.

Deterioration of insulation of electric parts may cause electric leakage.



2. When using the refrigerator

Do not cling to the door or the shelves of the door or the home bar of the freezer or the cool chamber.

It may make the refrigerator fallen down or damage the hands. Especially, do not allow the children to do the above.

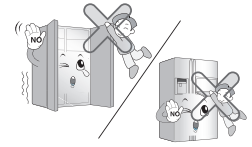

Do not use or store inflammable materials ether, benzene, alcohol, medicine, LP gas, spray or cosmetics near or in the refrigerator.

It may cause explosion or fire.

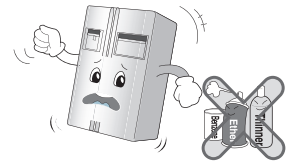

Do not place the lit candle within the refrigerator to deodorize.

It may cause explosion or fire.

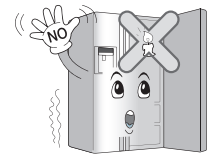

Do not insert the hands into the ice bucket or the ice dispenser.

(only for the model with the dispenser).

Operating the ice maker may cause injury.



Do not store the medicine or the academic materials at the refrigerator.

When the material with the strict temperature control is stored, it may be deteriorated or it may make an unexpected reaction to cause any risk.

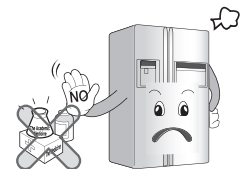

Do not use the combustible spray near the refrigerator.

It may cause fire.

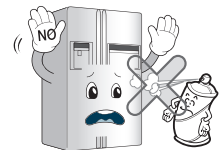

Avoid the heating devices.

It may cause fire.

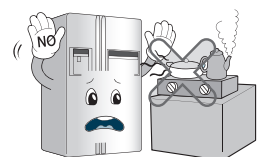

Do not place flower vase, cup, cosmetics, medicine or any container with water on the refrigerator .
It may cause fire, electric shock or injury by dropping down.

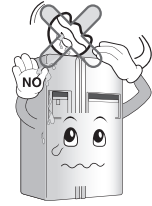

Use the submerged refrigerator after checking it.
It may cause electric shock or fire.

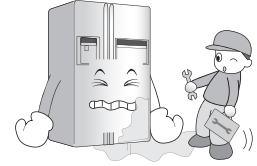

When gas is leaked, do not touch the refrigerator or the outlet and ventilate the room immediately.

- The explosion by spark may cause fire or burn.
- Because this refrigerator uses natural gas (R600a) as the environment-friendly refrigerant, even a small amount (80~90g) is combustible. When the gas is leaked by the severe damage during delivering, installing or using the refrigerator, any spark may cause fire or burn. (Only for the model with the R600a.)

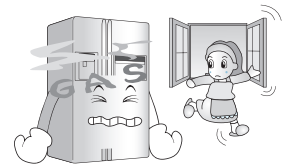

Do not spray water at the outside or the inside of the refrigerator or do not clean it with benzene or thinner.
Deterioration of insulation of electric parts may cause electric shock or fire.

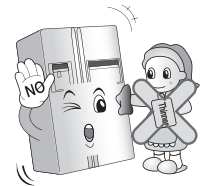

When any strange smell or smoke is detected from the refrigerator, disconnect the power plug immediately and contact to the service center.
It may cause fire.



Do not allow any person except the qualified engineer to disassemble, repair or alter the refrigerator.
It may cause injury, electric shock or fire.

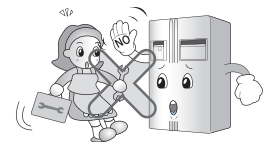

Do not use the refrigerator for non-domestic purpose (storing medicine or testing material, using at the ship, etc.).
It may cause an unexpected risk such as fire, electric shock, deterioration of stored material or chemical reaction.



2. When using the refrigerator

When disposing the refrigerator, remove the packing materials from the door.

It may cause to lock out the child.



Install the refrigerator on the solid and level floor.

Installing it on the unstable place may cause death by falling down the refrigerator when opening or closing the door.

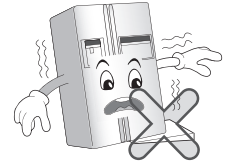

Do not insert the hands or the metal stick into the exit of cool air, the cover, the bottom of the refrigerator, the heatproof grill (exhaust hole) at the backside.

It may cause electric shock or injury.

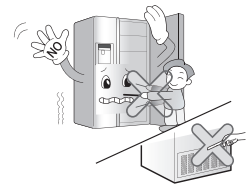

When you want to dispose the refrigerator, contact to the down-block office.

When you want to dispose the large living waste such as electric home appliance and furniture, you'd better contact the local down-block office.

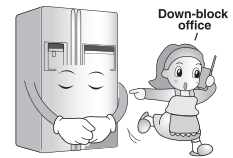

CAUTION

Violating this direction may cause injury or damage house or furniture. Always be careful, please.

Do not touch food or containers at the freezer with wet hands.

It may cause frostbite.

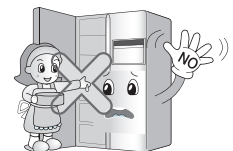

Do not put ice in thin crystal cup or ceramic ware.

It may break cup or ceramic ware to cause injury.

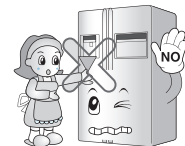

When the electricity is off, remove ice from the ice bucket (only for the model with the dispenser).

The long-time power failure may thaw ice to damage the floor. When the long-time power failure is expected, remove ice from the ice bucket.



Supply the automatic ice maker with drinkable water only (only for the model with the dispenser).

Otherwise, it may cause any risk.

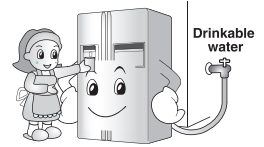

Wait for 5 minutes or longer when reconnecting the plug. It may cause the operation of the freezer to fail.

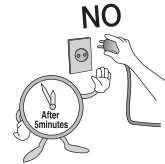

Do not put bottle in the freezer. It may freeze the contents to break the bottle to cause injury.



Pull out the power plug not by grasping the cord but the plug of its end.

It may cause electric shock or short circuit to fire.



Do not install the refrigerator in the wet place or the place which water or rain splashes.

Deterioration of insulation of electric parts may cause electric leakage.

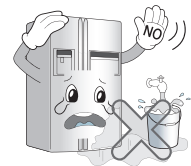

Do not insert the hands into the bottom of the refrigerator.

The iron plate of the bottom may cause injury.



Carry the refrigerator with the handle bar at the bottom of the front and the top of the rear.

Otherwise, your hands may be slipped to cause injury.

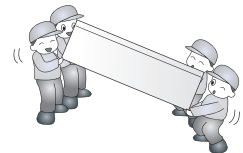

Because opening or closing the door of the refrigerator may cause injury to the person around it, be careful, please.

Opening or closing the door may cause feet or hands to be caught in the chink in door or the child to be get hurt by the corner.

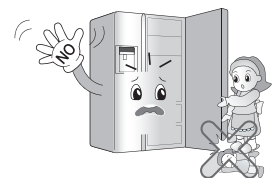

Do not put any living animal in the refrigerator.

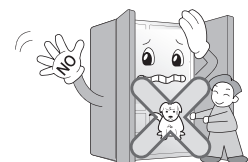

WARNING

1. When connecting the power

Prevent the power cord from being crushed or imprinted when the refrigerator is pushed in after the power plug is connected during the installation.

When moving your appliance away from the wall, be careful not to roll over or damage the power cord.

It can be the cause of fire or electric shock.

Only connect the refrigerator to an approved outlet with the correct specified supply voltage.

It can be the cause of fire.

If the supply cord is damaged, it must be replaced by the manufacturer or its service agent or a similarly qualified person in order to avoid any hazard.

2. When using the refrigerator,

prevent children from entering the product.

It may endanger the life of a child if the child enters the refrigerator. Never leave a child near the refrigerator unsupervised.

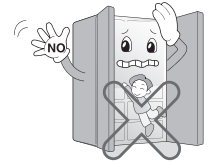

Opening and closing the door of the refrigerator aggressively may cause the stored food in the refrigerator basket to fall and cause injury, so take precautions.

Do not put heavy things on the Home Bar door. (Only for the models with the Home Bar) Heavy items will cause damage to the door and possible injury.

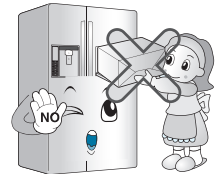

It is recommended that the refrigerator be disconnected during severe electrical storms or if not in use for long periods.

Power surges from electrical storms can seriously damage the refrigerator's electrical components. If the refrigerator is not used for long periods, storage measures should be taken to avoid odours and vermin contamination.

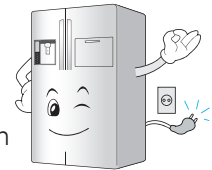

CAUTION

Do not insert hands into the ice bucket or the ice dispenser.

Operating the ice maker may cause injury.

Do not remove the external cover of the water and ice dispenser.

(Only for the models with automatic ice maker)

The mechanical and electrical parts of the icemaker may cause injury or an electrical shock hazard.



Arrange food and items appropriately inside the refrigerator.

The food may fall during opening and closing of the doors causing both damage to the unit or injury to persons.

Select a good location**Where to install**

1. Place your appliance where it is easy to use.
2. Avoid placing the unit near heat sources, direct sunlight or moisture.
3. To ensure proper air circulation around the fridge -freezer, please maintain sufficient space on both the sides as well as top and maintain at least 2 inches (5 cm) from the rear wall.
4. To avoid vibrations, the appliance must be leveled.
5. Don't install the appliance below 5°C . It may cause affect the performance.

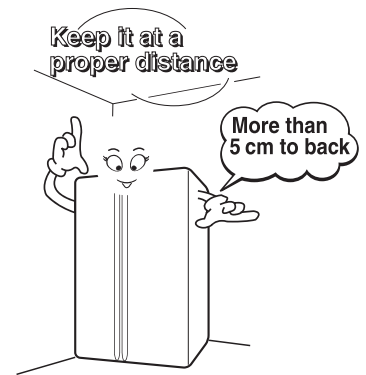
**Disposal of the old appliance**

This appliance contains fluid (refrigerant, lubricant) and is made of parts and materials which are reusable and/or recyclable. All the important materials should be sent to the collection center of waste material and can be reused after rework (recycling). For take back, please contact with the local agency.

! WARNING

Door removal

Electric Shock Hazard

Disconnect electrical supply to refrigerator before installing. Failure to do so could result in death or serious injury.

If your access door is too narrow for the refrigerator remove the refrigerator door and pass the refrigerator laterally.

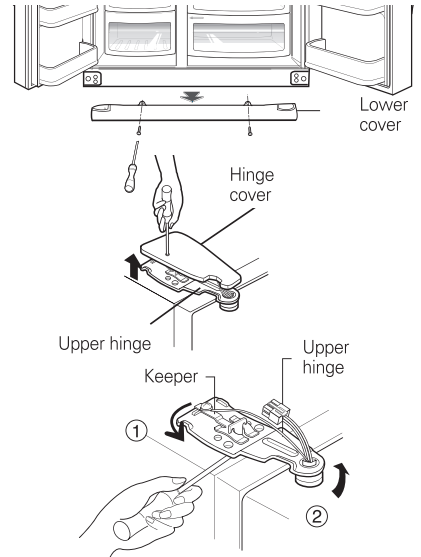

Remove lower cover

Remove the lower cover by lifting upward.

Remove the freezer compartment door

- 1) Loosen the hinge cover screws and remove the cover.
- 2) Remove the keeper by rotating it to counter clockwise (①) and then lifting the upper hinge up (②).

! CAUTION

• When removing the upper hinge, be careful that the door does not fall forwards.

- 3) Remove the freezer compartment door by lifting it upward.

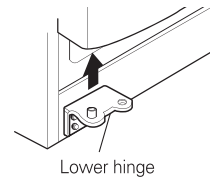

Remove the refrigerator door

- 1) Loosen the hinge cover screws and remove the cover. Remove connection wire, if any, except for the earth line.
- 2) Remove keeper by rotating it clockwise (①) and then remove the upper hinge by lifting it up (②).
- 3) Remove the refrigerator compartment door by lifting it up.

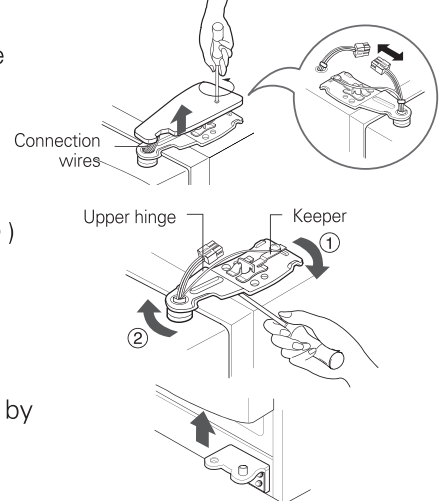

Pass the refrigerator

Pass the refrigerator laterally through access door as shown in the right figure.

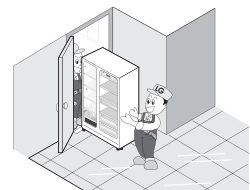

Door replacement

Mount them in the reverse sequence of removal after they pass through the access door.

When the freezer door is lower than the refrigerator door

Insert the transparent sheet supplied with the product when the freezer door is lower than the refrigerator door.

- Separate the door with the lower height, use the (+) type screwdriver to unscrew the screw at the bottom hinge as shown at Figure ①, insert the transparent sheet between the bottom hinge and the bottom bracket, and then fix it with the screw as shown at Figure ②.
- Insert more transparent sheets enough to align the height. (4 sheets are supplied in total.)

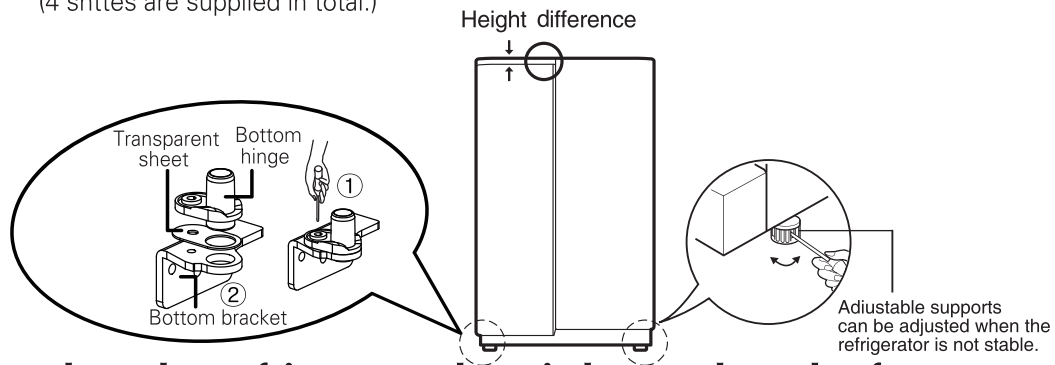

When the refrigerator door is lower than the freezer door

Make adjustments when the refrigerator door is lower than the freezer door while using the refrigerator.

1. Use the wide side of the adjustment tool ③ to rotate the tightening nut ① in clockwise direction to loosen it.
2. Use the narrow side of the adjustment tool ③ to rotate the adjustment hinge pin ② in either clockwise or counterclockwise direction to level the height of the refrigerator to that of the freezer.
3. After leveling the height of the door, rotate the tightening nut in counterclockwise direction to tighten it all the way.

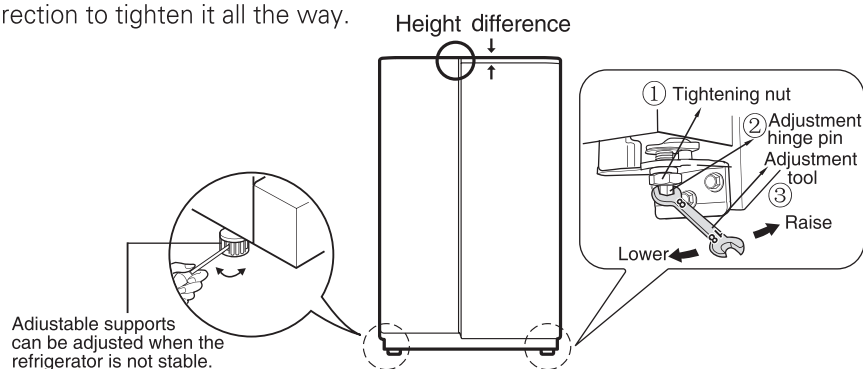

CAUTION

After leveling the door height

Next

Do not adjust the height excessively. You can lose the hinge pin.
(Height adjustable range: Maximum of 5mm)

The refrigerator doors will close smoothly by heightening the front side by adjusting the height adjusting screw. If the doors do not close correctly, performance may be affected.

1. Wipe off all dust accumulated during shipping and clean your appliance thoroughly.
2. Install accessories such as the ice cube box, cover evaporating tray, etc., in their proper places. They are packed together to prevent possible damage during shipping.
3. Connect the power supply cord (or plug) to the outlet. Don't double up with other appliances on the same outlet.

Starting

When your refrigerator is first installed, allow it to stabilize at normal operating temperatures for 2-3 hours prior to filling it with fresh or frozen foods. If operation is interrupted, wait 5 minutes before restarting.

Adjusting the temperatures and functions

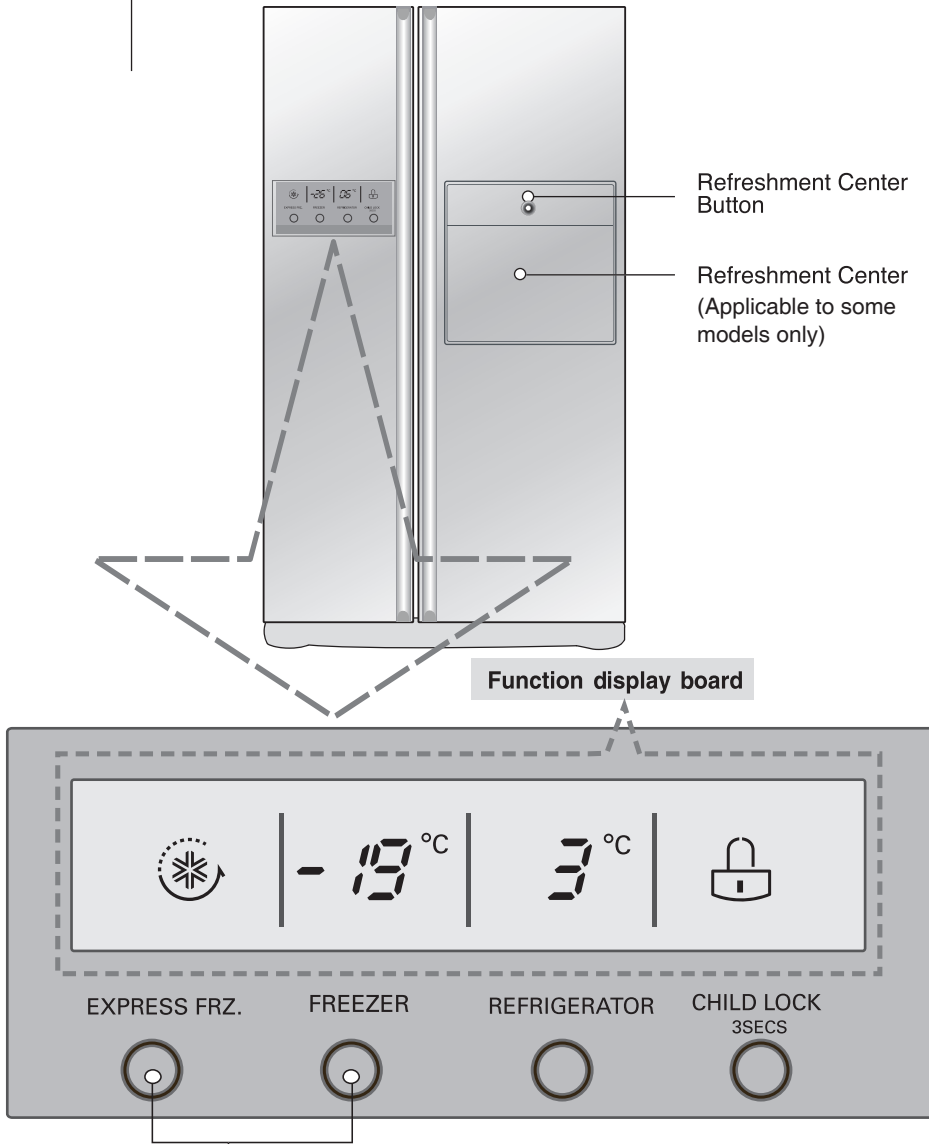

Display Power Saving Mode

NOTE

- Your model may not include every option.

Display Power Saving Mode

This function places the display into power saving mode until the next time the door is opened.

Press the FREEZER and EXPRESS FRZ. buttons simultaneously and hold them for 5 seconds until the Ding sounds. All LED light will then turn ON, then OFF. When the power saving mode is activated, the display will remain off until the next time the door is opened. Then, it will come on whenever a door is opened or a button is pressed and remain on for 20 seconds after the last door opening or button selection. To deactivate the power saving mode, press the FREEZER and EXPRESS FRZ. buttons simultaneously and hold them for 5 seconds until the Ding sounds.

When doors are closed or stopping button selection for 20 seconds, the brightness of LED display will turn down, The power saving mode is activated. When a door is open or a button is pressed, the brightness of LED display will turn up.

You can adjust temperature of the freezer room and refrigerator room.

How to adjust the temperature in the freezer compartment

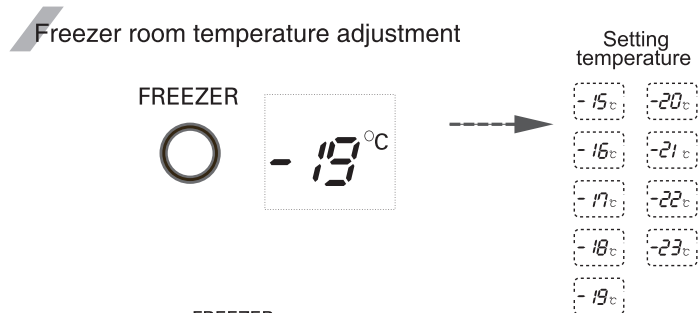

※ Whenever pressing **FREEZER** button, setting is repeated in the order of (-19°C → -20°C → ... → -23°C → -15°C → ... → -19°C).

How to adjust the temperature in the refrigerator compartment

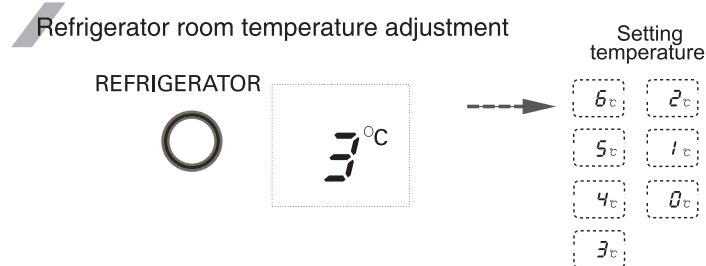



※ Whenever pressing **REFRIGERATOR** button, setting is repeated in the order of (3°C → 2°C → ... → 0°C → 6°C → ... → 3°C).

- The actual inner temperature varies depending on the food status, as the indicated seeing temperature is a target temperature, not actual temperature within refrigerator.
- Refrigeration function is weak in the initial time, Please adjust temperature as above after using refrigerator for minimum 2-3 days.

Super freezer

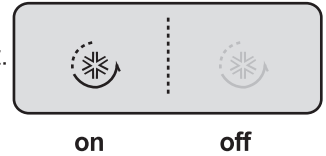

Please select this function for prompt freezer.

- "on" and "off" is repeated whenever pressing  button. EXPRESS FRZ.
- The arrow mark graphic remains at the "on" status when selecting Special Refrigeration "on". 
- Super freezer function automatically turns off if a fixed time passes.



Lock

This button stops operation of different button.

- Locking or Release is repeated whenever the button is pressed more than 3 seconds. CHILD LOCK 3SECS
- When you use the  button, you can not use any other button, until you unlock the unit. When you press the other button when the unit is locked, the  will flash 3 times to notify the current Lock condition.

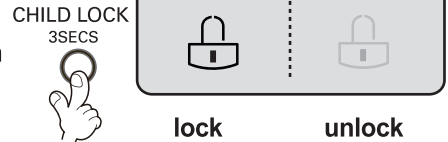

Door open alarm

An alarm will sound 3 times when the refrigerator door is left open for more than 1 minute. This alarm will be rung at intervals of 30 sec. and stop at the close of the door. If the alarm sound does not stop even after the freezer and refrigerator compartment doors are closed, contact the service center.

Self-diagnosis (fault detection) function

Self-diagnosis function operates when a problem occurs in the unit. When an error occurs in the unit, immediately contact the service center without turning the power OFF. If the power is OFF, it will take the engineer longer to find out where the fault occurs. The pressing of any function buttons will not alter the temperature setting when a fault occurs.

Refreshment center (Applicable to some models only)

How to use the Home Bar

1. Press the top central part of the Home Bar until you hear the "Click" sound.
 - You can save electricity because you do not have to open the refrigerator door.
 - Because the indoor lamps of the fridge and freezer are turned on even when you open only the Home Bar door, you can easily take out the food you want.
 - When closing the Home Bar, press until you hear the "Click" sound.
2. Open the door and use the door as the support board.
 - Put the beverage or food on the support board for convenience of use.

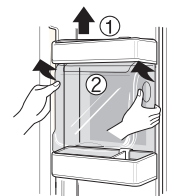
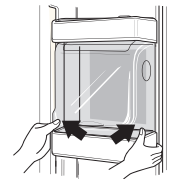
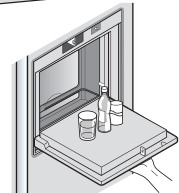
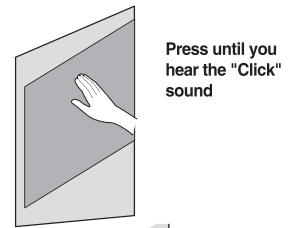

How to disassemble the fridge Home Bar cover

First separate the upper door basket of the Home Bar (①) and then pull up the Home Bar cover (②).

Precaution

1. Do not use the refrigerator with the internal Home Bar cover taken out.
 - If the cover is taken out, the Home Bar function cannot work.
2. Be careful not to press or damage the Home Bar support board.
 - If you lean or press the support board with your arm, it can be damaged.
 - Do not use the support board as a cutting board or use sharp tools on the support board to prevent any scratches.
 - When the support board is wet with alien fluid such as juice, it may not operate properly.
 - When the packing part is wet with alien fluid such as juice, periodically wipe the part.
 - Never place heavy items on the refreshment center door or allow children to hang it on. Not only can the refreshment center door be damaged, but also children may be hurt.

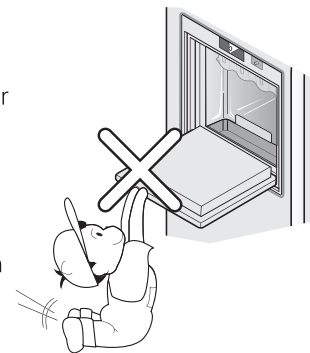

Wine holder (Applicable to some models only)

Wine holder adjustment

Bottles can be stored laterally with this wine rack.



(Type 1)

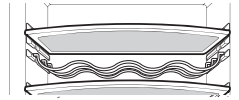

(Type 2)

When making Ice

Ice Making

- Fill water in ice making box of the ice making corner.
If water is fully filled the ice will not be separated well and water can be dropped to make ice lumped.
- Ice will be dropped into the ice storage bin by rotating ice separation handle of ice making compartment.

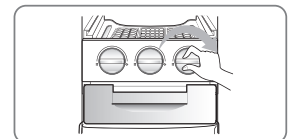
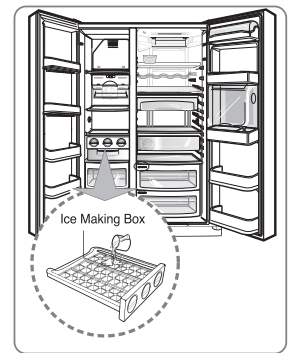

NOTE

- Rotating the ice separation handle before ice is fully frozen may cause the remaining water drop into the ice storage bin to lump the ice together.

Shelf (Applicable to some models only)

How to use

You can store side dish or refrigerated food on the shelf with sufficient space in between the containers.



How to disassemble

1. Hold the front part of the shelf and pull it out until it gets blocked by the hooking part.
2. When you cannot pull out the shelf any more, lift it up slightly.
3. While holding the shelf slightly, tilt the shelf to pull it out.

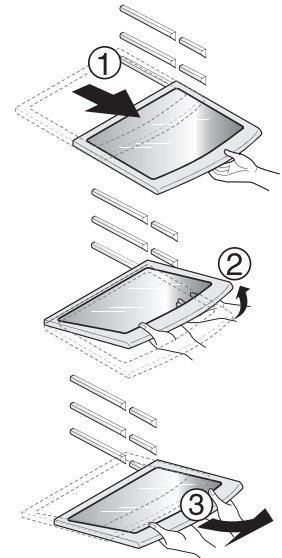

Deodorizer (Applicable to some models only)

This system efficiently absorbs strong odors by using the optical catalyst. This system does **not** have any affect on stored food.

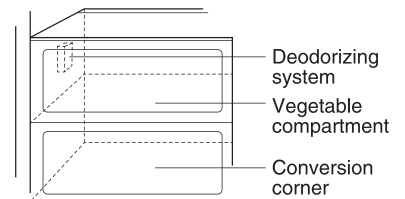

How to use the deodorizing system

- Since it is already installed onto the cool air intake duct from the refrigerator compartment, you need no separate installation.
- Please use closed containers to store food with pungent odors. Otherwise, this odor can be absorbed by other food in the compartment.

Egg box

You can move the egg box to wherever you want.

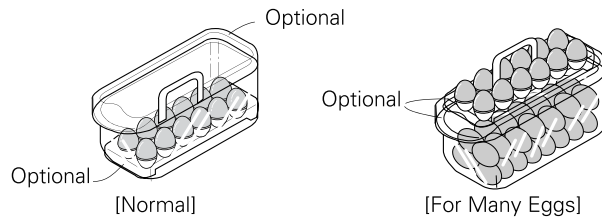

! CAUTION

- Never use the egg box as an ice storage bin. It can be broken.
- Never store the egg box in the freezer compartment or fresh compartment.

Humidity control in the vegetable compartment

The humidity can be controlled by adjusting the humidity control switch to the left/right when storing vegetables or fruits.

High humidity

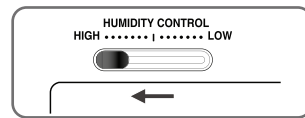

Low humidity

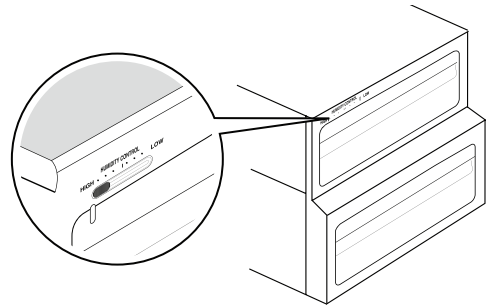
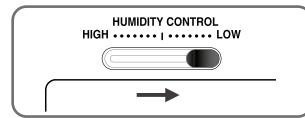

Convert into a vegetable or meat compartment

- The bottom drawer in the refrigerator can be converted into a vegetable or meat compartment

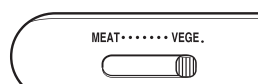

Vegetable compartment

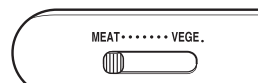

Meat compartment

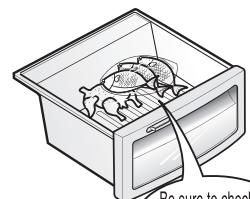
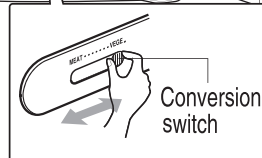
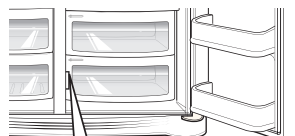

Be sure to check the conversion switch before storing foods

The meat compartment maintains the temperature at a lower point than the refrigerator compartment so that meat or fish can be stored fresh longer.

! CAUTION

- Vegetables or fruits are frozen if the conversion switch is set to meats compartment. So, be sure to check it before storing foods.

Location of foods

(Refer to identification of parts)

Wine holder	Store wine.	
Snack drawer	Store small foods such as bread, snacks, etc..	
Freezer compartment shelf	Store various frozen foods such as meat, fish, ice cream, frozen snacks, etc..	
Freezer compartment door rack	<ul style="list-style-type: none"> ▪ Store small packed frozen food. ▪ Temperature is likely to increase as door opens. So, do not store long-term food such ice cream, etc.. 	
Freezer compartment drawer	<ul style="list-style-type: none"> ▪ Store meat, fish, chicken, etc.. after wrapping them with thin foil. ▪ Store dry. 	
Milk product corner	Store milk products such as butter, cheese, etc..	
Egg box	Place this egg box in the proper location.	
Refreshment center	Store foods of frequent use such as beverage, etc..	
Refrigerator compartment shelf	Store side dishes or other foods at a proper distance.	
Refrigerator compartment door rack	Store small packed food or beverages such as milk, juice, beer, etc..	
Vegetable drawer	Store vegetables or fruits.	
Vegetable drawer /meat drawer conversion corner	<p>Store vegetable, fruits, meat to thaw, raw fish, etc.. setting the conversion switch as necessary.</p> <p>Be sure to check the conversion switch setting before storing foods.</p>	

Storing foods

- Store fresh food in the refrigerator compartment. How food is frozen and thawed is an important factor in maintaining its freshness and flavor.
- Do not store food which goes bad easily at low temperatures, such as bananas, and melons.
- Allow hot food to cool prior to storing, placing hot food in the refrigerator could spoil other food, and lead to higher energy consumption.
- When storing the food, cover it with vinyl wrap or store in a container with a lid. This prevents moisture from evaporating, and helps food to keep its taste and nutrients.
- Do not block air vents with food. Smooth circulation of chilled air keeps refrigerator temperatures even.
- Do not open the door frequently. Opening the door lets warm air enter the refrigerator, and cause temperatures to rise.
- Never keep too much food in door rack because they may push against by inner racks so that the door cannot be fully closed.

Freezer compartment

- Do not store bottles in the freezer compartment - they may break when frozen.
- Do not refreeze food that has been thawed. This causes loss of taste and nutrient.
- When storing frozen food like ice cream for a long period, place it on the freezer shelf, not in the door rack.
- Do not touch the cold foods or containers- especially made of metallic -, with wet hands and place glass products in the freezer compartment.



CAUTION

- That's why you may have chilblains and they may be broken when their inner matters are frozen, causing personal injury.

Refrigerator compartment

- Avoid placing moist food in top refrigerator shelves, it could freeze from direct contact with chilled air.
- Always clean food prior to refrigeration. Vegetables and fruits should be washed and wiped, and packed food should be wiped, to prevent adjacent food from spoiling.
- When storing eggs in their storage rack or box, ensure that they are fresh, and always store them in an upright position, which keeps them fresh longer.

NOTE

- If you keep the refrigerator in a hot and humid place, frequent opening of the door or storing a lot of vegetables in it may cause dew to form which has no effect on its performance. Remove the dew with dust cloth free from care.

How to dismantle parts

NOTE

- Dismantling is done in the reverse sequence of assembly.
Be sure to unplug the power plug before dismantling and assembly.
Never apply severe force to dismantle parts. Parts may be damaged.

Freezer compartment lamp

Separate the lamp by pulling it out ② while slightly pressing ① and rotating ③ the lamp cover.

Turn the bulb counterclockwise.
(Please cut the power off before operation)
Use a DC 12V 0.75W LED bulb.

Please contact with the local service center, when the LED lamp bulb doesn't operate well.

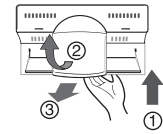

Freezer compartment shelf

To remove a shelf, push the shelf to the left ②, lift the left part of the shelf a bit ①, lift the right part up ③, and take it out.

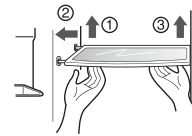

Door rack and support

Lift the door rack to ① direction holding both sides and pull it out to ② direction.

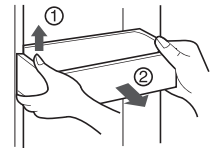

Lamp in refrigerator compartment

Separate the lamp by pulling it out while ② slightly pressing ① and rotating ③ the lamp cover.

(Please cut the power off before operation)
Disassemble the screws of the lamp board and take it down. Use a DC 12V 2W LED lamp board.

Please contact with the local service center, when the LED lamp board doesn't operate well.

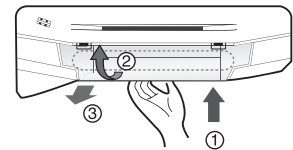

Separate the lamp by pulling it out ①.

Turn the bulb counterclockwise.

(Please cut the power off before operation)
Use a DC 12V 0.75W LED bulb. Please contact with the local service center, when the LED lamp bulb doesn't operate well.

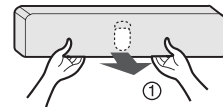

Refreshment center (In select model only)

- Separate the door rack ① to upward.
- Separate cover of the refreshment center ② to upward.
- The door rack ③ can be removed by pulling it upwards.

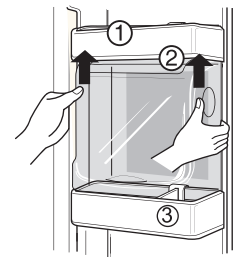

NOTE

- Be sure to remove parts from the refrigerator door when removing the vegetable compartment and snack corner.

Vegetable compartment cover

- To remove the vegetable compartment cover, pull out the vegetable compartment a bit to the front ①, lift the front part of the vegetable compartment cover as shown by ②, and take it out.

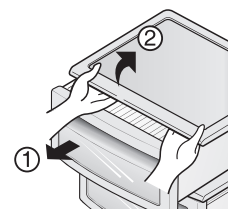

General information

Vacation time

During average length vacations, you will probably find it best to leave the refrigerator in operation. Place freezable items in freezer for longer life.

When you plan not to operate, remove all food, disconnect the power cord, clean the interior thoroughly, and leave each door OPEN to prevent odor formation.

Power failure

Most power failures that are corrected in an hour or two will not affect your refrigerator temperatures.

However, you should minimize the number of door openings while the power is off.

If you move

Remove or securely fasten down all loose items inside the refrigerator.

To avoid damaging the height adjusting screws, turn them all the way into the base.

Anti condensation pipe

The outside wall of the refrigerator cabinet may sometimes get warm, especially just after installation.

Don't be alarmed. This is due to the anti-condensation pipe, which pumps hot refrigerator to prevent "sweating" on the outer cabinet wall.

Cleaning

It is important that your refrigerator be kept clean to prevent undesirable odors. Spilled food should be wiped up immediately, since it may acidify and stain plastic surfaces if allowed to settle.

Exterior

Use a lukewarm solution of mild soap or detergent to clean the durable finish of your refrigerator.

Wipe with a clean damp cloth and then dry.

Interior

Regular cleaning is recommended. Wash all compartments a baking soda solution or a mild detergent and warm water. Rinse and dry.

After cleaning

Please verify that the power cord is not damaged, power plug is not overheated, or power plug is well inserted into the power consent.

WARNING

Always remove power cord from the wall outlet prior to cleaning in the vicinity of electrical parts (lamps, switches, controls, etc.).

Wipe up excess moisture with a sponge or cloth to prevent water or liquid from getting into any electrical part and causing an electric shock.

Never use metallic scouring pads, brushes, coarse abrasive cleaners, strong alkaline solutions, flammable or toxic cleaning liquids on any surface.

Do not touch frozen surfaces with wet or damp hands, because damp object will stick or adhere to extremely cold surfaces.

Trouble shooting

Before calling for service, review this list. It may save you both time and expense. This list includes common occurrences that are not the result of defective workmanship or materials in this appliance.

Occurrence	Possible cause	Solution
Runing of refrigerator		
Refrigerator compressor does not run.	Refrigerator control is off.	Set refrigerator control. See setting the controls.
	Refrigerator is in defrost cycle.	This is normal for a fully automatic defrosting refrigerator. The defrost cycle occurs periodically.
	Plug at wall outlet is disconnected.	Make sure plug is tightly pushed into outlet.
	Power outage. Check house lights.	Call local electric company.
Refrigerator runs too much or too long	Refrigerator is larger than the previous one you owned.	This is normal. Larger, more efficient units run longer in these conditions.
	Room or outside weather is hot.	It is normal for the refrigerator to work longer under these conditions.
	Refrigerator has recently been disconnected for a period of time.	It takes some hours for the refrigerator to cool down completely.
	Large amounts of warm or hot food may have been stored recently.	Warm food will cause the refrigerator to run longer until the desired temperature is reached.
	Doors are opened too frequently or too long.	Warm air entering the refrigerator causes it to run longer. Open the door less often.
	Refrigerator or freezer door may be slightly open.	Make sure the refrigerator is level. Keep food and containers from blocking door. See problem section. OPENING/CLOSING of doors.
	Refrigerator control is set too cold.	Set the refrigerator control to a warmer setting until the refrigerator temperature is satisfactory.
	Refrigerator or freezer gasket is dirty, worn, cracked, or poorly fitted.	Clean or change gasket. Leaks in the door seal will cause refrigerator to run longer in order to maintain desired temperatures.
	Thermostat is keeping the refrigerator at a constant temperature.	This is normal. Refrigerator goes on and off to keep the temperature constant.

Occurrence	Possible cause	Solution
Temperatures are too cold		
Temperature in the freezer is too cold and the refrigerator temperature is satisfactory.	Freezer control is set too cold	Set the freezer control to a warmer setting until the freezer temperature is satisfactory.
Temperature in the refrigerator is too cold and the freezer temperature is satisfactory.	Refrigerator control is set too cold.	Set the refrigerator control to a warmer setting
Food stored in drawers freezes.	Refrigerator control is set too cold.	See above solution.
Meat stored in fresh meat drawer freezes.	Meat should be stored at temperature just below the freezing point of water (32 ° F, 0 ° C) for maximum fresh storage time.	It is normal for ice crystals to form due to the moisture content of meat.
Temperatures are too warm		
Temperatures in the freezer is too warm.	Freezer control is set too warm.	Set the freezer control to a colder setting until the freezer temperature is satisfactory.
	Refrigerator control is set too warm. Refrigerator control has some effect on freezer temperature.	Set the freezer control to a colder setting until the freezer temperature is satisfactory.
Temperatures in the refrigerator or freezer is too warm.	Doors are opened too frequently or too long.	Warm air enters the refrigerator/ freezer whenever the door is opened. Open the door less often.
	Door is open slightly.	Close the door completely.
	Large amounts of warm or hot food may have been stored recently.	Wait until the refrigerator or freezer has had a chance to reach its selected temperature.
	Refrigerator has recently been disconnected for a period of time.	A refrigerator requires some hours to cool down completely.
Temperature in the refrigerator is too warm and the freezer temperature is satisfactory.	Refrigerator control is set too warm.	Set the refrigerator control to a colder setting.

Occurrence	Possible cause	Solution
Sound and noise		
Louder sound levels when refrigerator is on.	Today's refrigerators have increased storage capacity and maintain more even temperatures.	It is normal for sound levels to be higher.
Louder sound levels when compressor comes on.	Refrigerator operates at higher pressures during the start of the ON cycle.	This is normal. Sound will level off as refrigerator continues to run.
Vibrating or rattling noise.	Floor is uneven or weak. Refrigerator rocks on the floor when it is moved slightly.	Be sure floor is level and solid and can adequately support refrigerator.
	Items placed on the top of refrigerator are vibrating.	Remove items.
	Dishes are vibrating on the shelves in the refrigerator.	It is normal for dishes to vibrate slightly. Move dishes slightly. Make sure refrigerator is level and solidly set on floor.
	Refrigerator is touching wall or cabinets.	Relieve or move refrigerator
Water/Moisture /Ice inside refrigerator		
Moisture collects on inside of refrigerator walls.	Weather is hot and humid which increases rate of frost buildup and internal sweating.	This is normal.
	Door is slightly open.	See problem section opening/closing of doors.
	Door is opened too often or too long.	Open the door less often.
Water/Moisture /Ice outside refrigerator		
Moisture forms on outside of refrigerator or between doors.	Weather is humid.	This is normal in humid weather. When humidity is lower, the moisture should disappear.
	Door is slightly open, causing cold air from the inside the refrigerator to meet warm air from the outside.	This time, close the door completely.

Occurrence	Possible cause	Solution
Odors in refrigerator	Interior needs to be cleaned.	Clean interior with sponge, warm water and baking soda.
	Food with strong odor is in refrigerator.	Cover food completely.
	Some containers and wrapping paper produce odors.	Use a different container or brand of wrapping paper.
Opening/Closing of doors/Drawers		
Door(s) will not close.	Food package is keeping door open.	Move packages that keep door from closing.
Door(s) will not close. (Continued)	Door was closed too hard, causing other door to open slightly.	Close both doors gently.
	Refrigerator is not level. It rocks on the floor when it is moved slightly.	Adjust the height adjusting screw.
	Floor is uneven or weak. Refrigerator rocks on the floor when it is moved slightly.	Be sure floor is level and can adequately support refrigerator. Contact carpenter to correct sagging or sloping floor.
	Refrigerator is touching wall or cabinets.	Relieve or move refrigerator..
Drawers are difficult to move.	Food is touching shelf on top of drawer	Keep less food in drawer.
	Track that drawer slides on is dirty.	Clean drawer and track.
Other	Please thoroughly read this manual.	

It is Normal...

The following occurrences are normal.

	Occurrence	Solution
Noise	When you hear "Tak" or "Took" sound	This is the sound of various parts expanding/contracting or various control devices operating depending on the temperature change within the refrigerator.
	When you hear "Deureureuk~", "Dulkuk" or "Woong" sound	This is the count of compressor or fan operating when the operation of the refrigerator is starting or ending. This is the same phenomenon of the sound generated when starting or turning off the engine of a car.
	When you hear "Kureureuk" sound of water flowing	This is the sound of refrigerant changing the condition in the freezer/fridge. When the liquid changes to gas, you will hear the sound of water flowing and when gas changes to liquid, you will hear the "Kureureuk" sound.
	When you hear the sound of wind such as "Shoo~" or "Shik" right after you close the door	This is the sound generated when the internal pressure is temporarily lowered when the warm air entered through the fridge or freezer is cooled fast.
	When you hear the vibrating sound	If the refrigerator is installed on wooden floor or wooden wall, or if the refrigerator is not leveled properly, the sound can be loud from the vibration.
	When you hear a loud sound after installing the product for the first time	When you operate the refrigerator for the first time, the refrigerator will operate at high speed to cool fast and the sound can seem louder. When the internal temperature falls below a certain level, the noise will subside.
Door open	When the door is slightly opened after closing the door	Depending on the force or speed of closing the fridge or freezer door, the door can open slightly but then will close. Be careful not to close the door too hard.
Icing/ Dew drops	When there is icing or condensation formed on the inner or outer side of the refrigerator	When external air flows into the cool inner surface of the refrigerator, condensation can be formed. Especially, this will happen more easily when you open and close the refrigerator door more frequently. Also if the humidity of the installed location is high or during the rainy season or on a rainy day, condensation can form on the outer side of the refrigerator. This is a natural phenomenon that occurs during humid weather. Wipe the condensation with a dry cloth.
Temperature	When the front side of the refrigerator is warm	Heat pipes are installed around the front part of the refrigerator and on the divider of the freezer and fridge to prevent condensation from forming. The refrigerator may feel warmer after the installation or during summer periods. This is quite normal.