



OWNER'S MANUAL

Micro Hi-Fi System

Please read this manual carefully before operating your set and retain it for future reference.

XA146 (XA146, XAS146F)



MFL67460020

Safety Information



CAUTION: TO REDUCE THE RISK OF ELECTRIC SHOCK DO NOT REMOVE COVER (OR BACK) NO USER-SERVICEABLE PARTS INSIDE REFER SERVICING TO QUALIFIED SERVICE PERSONNEL.



This lightning flash with arrowhead symbol within an equilateral triangle is intended to alert the user to the presence of uninsulated dangerous voltage within the product's enclosure that may be of sufficient magnitude to constitute a risk of electric shock to persons.



The exclamation point within an equilateral triangle is intended to alert the user to the presence of important operating and maintenance (servicing) instructions in the literature accompanying the product.

WARNING: TO PREVENT FIRE OR ELECTRIC SHOCK HAZARD, DO NOT EXPOSE THIS PRODUCT TO RAIN OR MOISTURE.

WARNING: Do not install this equipment in a confined space such as a book case or similar unit.

CAUTION: Do not block any ventilation openings. Install in accordance with the manufacturer's instructions.

Slots and openings in the cabinet are provided for ventilation and to ensure reliable operation of the product and to protect it from over heating. The openings shall be never be blocked by placing the product on a bed, sofa, rug or other similar surface. This product shall not be placed in a built-in installation such as a bookcase or rack unless proper ventilation is provided or the manufacturer's instruction has been adhered to.

CAUTION: This product employs a Laser System. To ensure proper use of this product, please read this owner's manual carefully and retain it for future reference. Shall the unit require maintenance, contact an authorized service center. Use of controls, adjustments or the performance of procedures other than those specified herein may result in hazardous radiation exposure. To prevent direct exposure to laser beam, do not try to open the enclosure. Visible laser radiation when open. DO NOT STARE INTO BEAM.

CAUTION concerning the Power Cord

Most appliances recommend they be placed upon a dedicated circuit;

That is, a single outlet circuit which powers only that appliance and has no additional outlets or branch circuits. Check the specification page of this owner's manual to be certain. Do not overload wall outlets. Overloaded wall outlets, loose or damaged wall outlets, extension cords, frayed power cords, or damaged or cracked wire insulation are dangerous. Any of these conditions could result in electric shock or fire. Periodically examine the cord of your appliance, and if its appearance indicates damage or deterioration, unplug it, discontinue use of the appliance, and have the cord replaced with an exact replacement part by an authorized service center. Protect the power cord from physical or mechanical abuse, such as being twisted, kinked, pinched, closed in a door, or walked upon. Pay particular attention to plugs, wall outlets, and the point where the cord exits the appliance. To disconnect power from the mains, pull out the mains cord plug. When installing the product, ensure that the plug is easily accessible.

This device is equipped with a portable battery or accumulator.

Safety way to remove the battery or the battery from the equipment:

Remove the old battery or battery pack, follow the steps in reverse order than the assembly. To prevent contamination of the environment and bring on possible threat to human and animal health, the old battery or the battery put it in the appropriate container at designated collection points. Do not dispose of batteries or battery together with other waste. It is recommended that you use local, free reimbursement systems batteries and accumulators. The battery shall not be exposed to excessive heat such as sunshine, fire or the like.

CAUTION: The apparatus shall not be exposed to water (dripping or splashing) and no objects filled with liquids, such as vases, shall be placed on the apparatus.

Disposal of your old appliance



1. When this crossed-out wheeled bin symbol is attached to a product it means the product is covered by the European Directive 2002/96/EC.
2. All electrical and electronic products should be disposed of separately from the municipal waste stream via designated collection facilities appointed by the government or the local authorities.
3. The correct disposal of your old appliance will help prevent potential negative consequences for the environment and human health.
4. For more detailed information about disposal of your old appliance, please contact your city office, waste disposal service or the shop where you purchased the product.

Disposal of waste batteries/accumulators



1. When this crossed-out wheeled bin symbol is attached to batteries/accumulators of Your product it means they are covered by European Directive 2006/66/EC.
2. This symbol may be combined with chemical symbols for mercury(Hg), cadmium(Cd) or lead(Pb) if the battery Contains more than 0.0005% of mercury, 0.002% of cadmium or 0.004% of lead.
3. All batteries/accumulators should be disposed separately from the municipal waste stream via designated collection facilities appointed by the government or the local authorities.
4. The correct disposal of Your old batteries/accumulators will help to prevent potential negative consequences for the environment, animal and human health.
5. For more detailed information about disposal of Your old batteries/accumulators, please contact Your city office, waste disposal service or the shop where You purchased the product.

You have to set the disc format option to [Mastered] in order to make the discs compatible with the LG players when formatting rewritable discs. When setting the option to Live File System, you cannot use it on LG players.

(Mastered/ Live File System : Disc format system for Windows Vista)

Table of Contents

1 Getting Started

- 2 Safety Information
- 5 Unique Features
- 5 Accessories
- 5 Playable file Requirement
 - 5 - MP3/ WMA music file requirement
 - 5 - Compatible USB Devices
 - 5 - USB device requirement
- 6 Remote control
- 7 Front panel
- 8 Rear panel

2 Connecting

- 9 Connecting to speakers
 - 9 - Attaching the speakers to the unit
- 9 Optional Equipment Connection
 - 9 - PORT. IN Connection
 - 10 - USB Connection

3 Operating

- 11 Basic Operations
 - 11 - CD/ USB Operations
 - 11 Other Operations
 - 11 - Programmed Playback
 - 11 - Displaying file information (ID3 TAG)
 - 11 - Turn off the sound temporarily
- 12 Radio Operations
 - 12 - Listening to the radio
 - 12 - Presetting the Radio Stations
 - 12 - Deleting all the saved stations
 - 12 - Improving poor FM reception
- 13 Sound adjustment
 - 13 - Setting the surround mode
- 13 Setting the Clock
 - 14 - Using your player as an alarm clock
 - 14 - Sleep Timer Setting
 - 14 - Dimmer
- 15 Advanced Operations
 - 15 - Playing the iPod

- 15 - Compatible iPod
- 16 - Listening to music from your external device
- 16 - Recording to USB
- 16 - To select recording bit rate and speed

4 Troubleshooting

- 18 Troubleshooting

5 Appendix

- 19 Specifications
- 20 Maintenance
 - 20 - Handling the Unit
 - 20 - Notes on Discs
- 20 Trademarks and Licenses

Unique Features

USB Direct Recording

Records music to your USB device.

Portable In

Listens to music from your portable device. (MP3, Notebook, etc)

Made for iPod

Enjoy music from iPod® with simple connection.

Accessories

Please check and identify the supplied accessories.

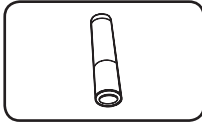

Battery (1)

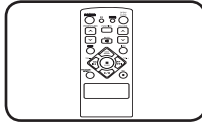

Remote Control (1)

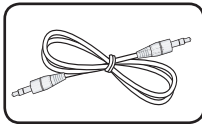

Portable in cable
(Optional) (1)

Playable file Requirement

MP3/ WMA music file requirement

MP3/WMA file compatibility with this unit is limited as follows :

- Sampling frequency : within 32 to 48 kHz (MP3), within 32 to 48 kHz (WMA)
- Bit rate : within 32 to 320 kbps (MP3), 40 to 192 kbps (WMA)
- Maximum files : Under 999
- File extensions : ".mp3"/".wma"
- CD-ROM file format : ISO9660/ JOLIET
- We recommend that you use Easy-CD Creator, which creates an ISO 9660 file system.

Compatible USB Devices

- MP3 Player : Flash type MP3 player.
- USB Flash Drive :
Devices that support USB2.0 or USB1.1.
- The USB function of this unit does not support all USB devices.

USB device requirement

- Devices which require additional program installation when you have connected it to a computer, are not supported.
- Do not extract the USB device while in operation.
- For a large capacity USB, it may take longer than a few minute to be searched.
- To prevent data loss, back up all data.
- If you use a USB extension cable or USB hub, the USB device is not recognized.
- Using NTFS file system is not supported. (Only FAT(16/ 32) file system is supported.)
- This unit is not supported when the total number of files is 1 000 or more.
- External HDD, Card readers, Locked devices, or hard type USB devices are not supported.
- USB port of the unit cannot be connected to PC. The unit cannot be used as a storage device.

Remote control



Getting Started

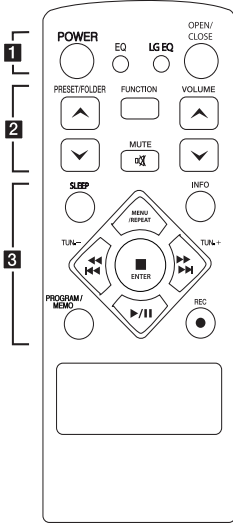

Battery Installation

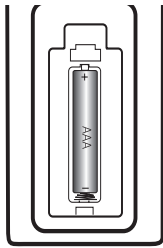

Remove the battery cover on the rear of the Remote Control, and insert one (size AAA) battery with **+** and **-** matched correctly

..... **1**

POWER : Switches the unit ON or OFF.

EQ : Chooses sound impressions.

LG EQ : Selects a natural equalizer effect by using LG EQ.

OPEN/CLOSE : Opens and closes the disc tray.

..... **2**

PRESET/FOLDER \wedge /V : Searches for a folder of MP3/ WMA files. When a CD/ USB containing MP3/ WMA files in several folders is being played, press **PRESET/FOLDER \wedge /V** to select the folder you want to play. Choose a 'preset number' for a radio station.

FUNCTION : Selects the function and input source.

VOLUME \wedge /V : Adjusts speaker volume.

MUTE : Mutes the sound.

..... **3**

SLEEP : Sets the system to turn off automatically at a specified time.

(Dimmer : The display window will be darkening by half.)

MENU/REPEAT :

- Listens to your tracks repeatedly or randomly. (only in CD/USB)

- Move to the previous menu(iPod).

INFO : Checks information about your music. MP3 files often come with tags. The tag gives the Title, Artist, Album or Time information.

TUN. -/+ : Selects the radio station.

⏮⏮⏮/⏭⏭⏭ (Skip/Search):

- Skips Fast backward or Forward.

- Searches for a section within a track.

■ **ENTER** :

- Stops playback or recording.
- choose an item(iPod).

▶/⏸ (Play/Pause) :

- Starts or pauses playback.
- Selects Mono/ Stereo.

PROGRAM/MEMO:

- For storing radio stations if you have saved radio stations using **PROGRAM/MEMO**, you can scroll through them and select one.

- Listens to your tracks in any order.

● **REC** : USB direct recording.

Front panel

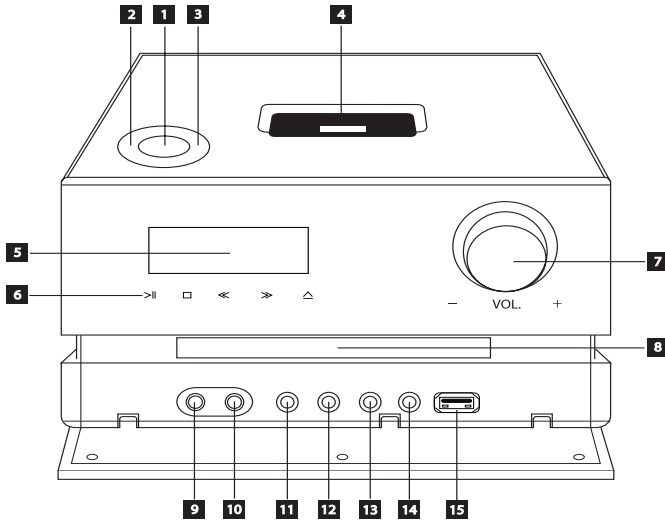

1 **⏻ / I (POWER)**

Switches the unit ON or OFF.

2 **FUNC. (FUNCTION)**

Changes the input source or function.

3 **EQ**

You can choose fixed sound impression.

4 **iPod dock**

5 **Display window**

Shows the current status of the unit.

6 **▶|| (PLAY / PAUSE)**

- Starts playback.
- Pauses playback temporarily, press again to exit pause mode.
- Selects Mono/ Stereo.

□ (STOP)

Stops playback.

◀ / ▶ (Skip/Search):

- Goes to next or previous file/track.
- Searches backward or forward (Press and hold)
- Tunes in the desired radio station.

△ (OPEN/CLOSE)

Opens and closes the disc tray.

7 **VOL.**

Adjusts speaker volume.

8 **Disc Slot**

9 **PORT. IN**

Connects to a portable player with audio outputs.

10 **PHONES**

Headphone jack

11 **CLOCK**

You can set and check the time.

12 **TIMER**

You can turn CD, USB play and TUNER reception on or off at a desired time.

13 **SET**

- Confirms the setting
- Views the information about the radio station being listened to.

14 **REC.**

Recording to USB.

15 **USB Port**

Connects an USB device.

Rear panel

1

Getting Started

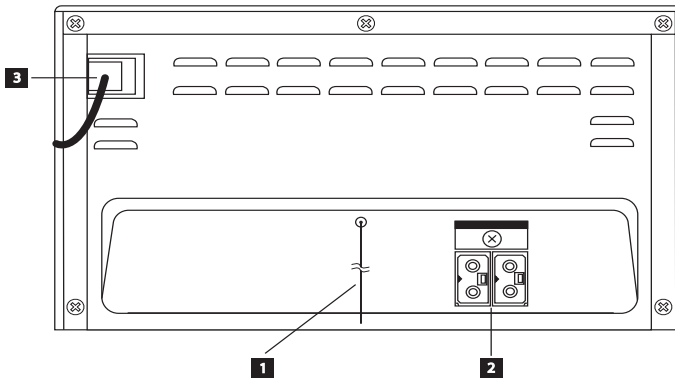

1 ANTENNA (FM)

3 Power cord

2 Speaker terminal

Connecting to speakers

Attaching the speakers to the unit

Connect connector on the speaker cable to speaker terminal.

Each speaker connector is colored.

Use matching color connector to each speaker terminal. When connecting connector to the speaker terminal, push the connector until it is perfectly linked.

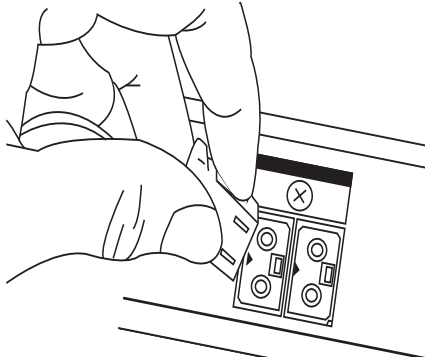

⚠ Caution

- The speakers contain magnet parts, so color irregularity may occur on the TV screen or PC monitor screen. Please use the speakers far away from either TV screen or PC monitor.
- Make sure to install the speaker with other people in order to prevent it from falling and causing injuries to the installer.

Optional Equipment Connection

PORT. IN Connection

Connect an output (earphone or line out) of portable device (MP3 or PMP etc) to the

PORT. IN connector.

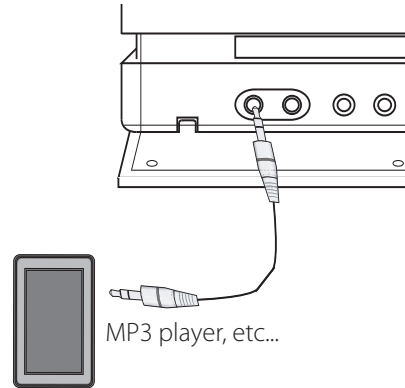

USB Connection

Connect the USB port of USB Memory (or MP3 player, etc.) to the USB port on the front of the unit.

2

Connecting

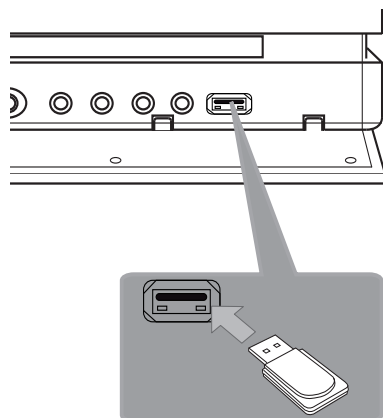

! Note

- Removing the USB Device from the unit
 1. Choose a different function/ mode or press **ENTER** on the remote control or **ENTER** on the unit twice in a row.
 2. Remove the USB device from the unit
- You can not use iPod by connecting USB port.
- when you connect iPod to USB port , it is not recharged.

Basic Operations

CD/ USB Operations

1. Insert the disc by pressing **OPEN/CLOSE** on the remote control or **△ (OPEN/CLOSE)** on the unit or connect the USB device to the USB port.
2. Select the CD or USB function by pressing **FUNCTION** on the remote control or **FUNC.** on the unit.
3. Select a file (or track) you want to play by pressing **◀◀/▶▶** on the remote control or **<< / >>** on the unit.

| To | Do this |
|---|---|
| Stop | Press ■ ENTER on the remote control or □ on the unit. |
| Playback | Press ▶/ on the remote control or > on the unit. |
| Pause | Press ▶/ on the remote control or > on the unit. |
| Skipping to the next/previous track/ file | During playback, press ◀◀/▶▶ on the remote control or << / >> on the unit to go to the next track/ file or to return to the beginning of the current track/ file. Press ◀◀ on the remote control or << on the unit twice briefly to step back to the previous track/ file. |
| Searching for a section within a track | Press and hold ◀◀/▶▶ on the remote control or << / >> on the unit during playback and release it at the point you want to listen. |
| Searching for a section within a folder | Press PRESET/FOLDER ▲/▼ and then ▶/ on the remote control or > on the unit. |
| Playing repeatedly or randomly | Press MENU/REPEAT on the remote control repeatedly, the display change in the following order, RPT1 -> RPT ALL -> RANDOM -> OFF |

Other Operations

Programmed Playback

The program function enables you to store your favorite files/tracks from any disc or USB device.

A program can contain 64 files/tracks.

1. Insert a CD or USB and wait for it to be order.
2. Press **PROGRAM/MEMO** on the remote control in stop status.
3. Press **◀◀/▶▶** on the remote control or **<< / >>** on the unit in stop status.
4. Press **PROGRAM/MEMO** again to save and select a next file/track.
5. Press **▶/||** on the remote control or **>||** on the unit to play the programmed music files.
6. To clear your selection, press **■ ENTER** on the remote control or **□** on the unit twice.

! Note

The programs are also cleared when the disc or USB device is removed, the unit is powered off or the function is switched to others.

Displaying file information (ID3 TAG)

While playing an MP3 file containing file information, you can display the information by pressing **INFO**.

! Note

Sometimes **INFO** can not be executed to according to ID3 TAG version.

Turn off the sound temporarily

Press **⊗ MUTE** to mute your unit.

You can mute your unit, for example, to answer the telephone, the "MUTE ON" or "MUTE OFF" is displayed in the display window.

Radio Operations

Listening to the radio

1. Press **FUNCTION** on the remote control or **FUNC.** on the unit until FM appears in the display window.
The last received station is tuned in.
2. Press and hold **TUN +/-** for about two seconds until the frequency indication starts to change, then release. Scanning stops when the unit tunes in a station.

Or

Press **TUN +/-** repeatedly.

3. Adjust the volume by rotating **VOL.** on the unit or by pressing **VOLUME \wedge / \vee** on the remote control repeatedly.

Presetting the Radio Stations

You can preset 50 stations for FM .

Before tuning, make sure to turn down the volume.

1. Press **FUNCTION** on the remote control or **FUNC.** on the unit until FM appears in the display window.
2. Select the desired frequency by pressing **TUN +/-**.
3. Press **PROGRAM/MEMO** a preset number will flash in the display window.
4. Press **PRESET/FOLDER \wedge / \vee** to select the preset number you want.
5. Press **PROGRAM/MEMO** The station is stored.
6. Repeat steps 2 to 5 to store other stations.
7. To listen a preset station, press **PRESET/FOLDER \wedge / \vee** .

Deleting all the saved stations

1. Press and hold **PROGRAM/MEMO** for two seconds. "ERASE ALL" will flash up on the unit display.
2. Press **PROGRAM/MEMO** to erase all saved radio stations.

Improving poor FM reception

Press **▶/II** on the remote control or **>II** on the unit. This will change the tuner from stereo to mono and usually improve the reception.

Sound adjustment

Setting the surround mode

This system has a number of pre-set surround sound fields. You can select a desired sound mode by using **EQ** or **LG EQ**.

The displayed items for the Equalizer may be different depending on sound sources and effect.

| On Display | Description |
|--------------------------------|--|
| NATURAL | You can enjoy comfortable and natural sound. |
| Local Specialization equalizer | Regionally optimized sound effect. (FORRO/ FUNK/ SERTANEJO/ DANGDUT/ ARABIC/ PERSIAN/ INDIA/ REGUETON/ MERENGUE/ SALSA/ SAMBA/ CUMBIA/ AFRO) |
| AUTO EQ | Realizes the sound equalizer that is the most similar to the genre of which is included in the MP3 ID3 tag of song files. |
| POP CLASSIC JAZZ ROCK | This program lends an enthusiastic atmosphere to the sound, giving you the feeling you are at an actual rock pop, jazz or classic concert. |
| MP3 -- OPT | This function is optimized for compressible MP3, WMA file. It improves the treble sound. |
| BASS BLAST | Reinforces the treble, bass and surround sound effect. |
| VIRTUAL | You can enjoy more virtual surround sound. |
| BYPASS | You can enjoy the sound without equalizer effect. |

Note

Maybe you need reset the surround mode, after switching the input, sometimes even after the sound track changed.

Setting the Clock

1. Turn the unit on.
2. Press **CLOCK** for at least 2 seconds.
3. Choose time mode by pressing **◀◀/▶▶** on the remote control or **◀ / ▶** on the unit.
- AM 12:00 (for an AM and PM display) or 0:00 (for a 24 hour display)
4. Press **SET** to confirm your selection.
5. Select the hours by pressing **◀◀/▶▶** on the remote control or **◀ / ▶** on the unit.
6. Press **SET** to save.
7. Select the minutes by pressing **◀◀/▶▶** on the remote control or **◀ / ▶** on the unit.
8. Press **SET** to save.

Using your player as an alarm clock

1. Turn the unit on.
2. Press **TIMER**. Each function flashes.
3. Press **SET** when the clock you want to be woken up is showed.
4. "ON TIME" will be displayed. This is your desired time to unit turns on. Press **⏮/⏭** on the remote control or **⏪/⏩** on the unit to change the hours and minutes and press **SET** to save.
5. The "OFF TIME" will be displayed. This is your desired time to unit turns off.
6. Press **⏮/⏭** on the remote control or **⏪/⏩** on the unit to change the hours and minutes and press **SET** to save.
7. Press **⏮/⏭** on the remote control or **⏪/⏩** on the unit to change the volume and press **SET** to save.
8. Press **TIMER** button 2 times. You can check the setting status.

! Note

- If you set the clock time, you can check the time by pressing **CLOCK** even when the player is turned off.
- If you press "**CLOCK**" on state of the unit turned off, you can see state in order of "**CLOCK**" and "**TIMER**".

Sleep Timer Setting

Press **SLEEP** repeatedly to select delay time between 10 and 180 minutes. After the delay time, unit will turn off.

To cancel the sleep function, press **SLEEP** repeatedly until "SLEEP 10" appears, and then press **SLEEP** once again while "SLEEP 10" is displayed.

! Note

- You can check the remaining time before the unit turns off.
- Press **SLEEP**. The remaining time appears in the display window.
- Sleep function will work after dimmer.

Dimmer

Press **SLEEP** once. The display window will be darkening by half. To cancel it, press **SLEEP** repeatedly until dim off.

Advanced Operations

Playing the iPod

You can enjoy the sound with your iPod. For details about iPod, refer to the iPod User Guide.

1. Connect the iPod firmly.

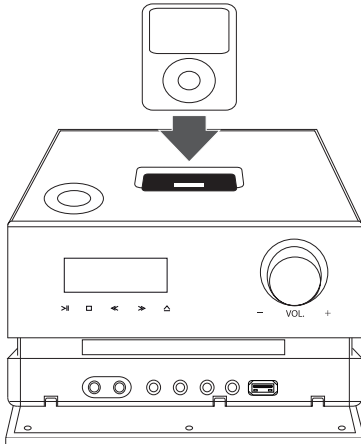

If you turn this unit on, with your iPod connected or docked it will automatically turn on and recharging will start.

2. Press **FUNC.** on the unit or **FUNCTION** on the remote control to select iPod function. You can operate your iPod through an iPod's display by using the supplied remote control and also control on your iPod.

| To | Do this | |
|---------------------------|----------------------|----------------------|
| | ON UNIT | ON REMOTE |
| Pauses or restart | > | ▶/ |
| Skip | <</>> | ◀◀/▶▶ |
| Search | Press and hold <</>> | Press and hold ◀◀/▶▶ |
| Move to the previous menu | - | MENU/ REPEAT |
| Move to the desired item | - | PRESET/ FOLDER ^/V |
| Chooses a item | □ | ■ ENTER |

Compatible iPod

- We recommend installing the latest software version.
- Made for iPod nano (6th, 5th, 4th, 3rd, 2nd and 1st generation), iPod classic, iPod touch (4th, 3rd, 2nd and 1st generation), iPod 5G, iPhone (4, 3GS, 3 G), iPod mini.
For some models, the unit may not operate depending on the firmware version.
- Depending on your iPod's software version, you may not control your iPod from the player.

Note

- If this unit displays an error message, follow the message. An error message "ERROR".
 - Your iPod is not connected firmly.
 - This unit recognizes your iPod as an unknown device.
 - Your iPod is exceptionally low in power.
 - ➔ The battery needs to be charged.
 - ➔ If you charge the battery while iPod is extremely low in power, it may take longer to be charged.
- iPod does not support recording function when connected.
- Depending on your iPod's software version, it may not be possible to control your iPod from this unit. We recommend installing the latest software version.
- If you use an application, make a call, or send and receive SMS text message, etc. on iPod touch or iPhone, disconnect it from iPod dock of this unit and then use it.
- When iPod source is selected, you can not enjoy audio through the headphone jack.
- If you have a problem with your iPod, please visit www.apple.com/support/ipod.

Listening to music from your external device

The unit can be used to play the music from many types of external device.
(Refer to the page 9)

1. Connect the external device to the **PORT. IN** connector of the unit.
2. Turn the power on by pressing **⏻/| (Power)**.
3. Select the PORTABLE function by pressing **FUNCTION** on the remote control or **FUNC.** on the unit.
4. Turn the external device and start it playing.

Recording to USB

1. Connect the USB device to the unit.
2. Select a function by pressing **FUNCTION** on the remote control or **FUNC.** on the unit.

One track recording - You can record to USB after playing a file you want.

All tracks recording - You can record to USB after stop.

Program list recording - After showing the programmed list, you can record it to USB.

3. Start the recording by pressing **REC.** on the unit or **● REC** on the remote control.
4. To stop recording, press **□** on the unit or **■ ENTER** on the remote control.

To select recording bit rate and speed

1. Press **REC.** on the unit or **● REC** on the remote control for longer than 3 seconds on the state of stop.
2. Use **⏪/⏩** on the remote control or **⏪ / ⏩** on the unit to select the bit rate.
3. Press **REC.** on the unit or **● REC** on the remote control again to select the recording speed.
4. Press **⏪/⏩** on the remote control or **⏪ / ⏩** on the unit to select a desired recording speed; (Only AUDIO CD)

X1 SPEED

- You can listen to music while recording it.

X2 SPEED

- You can just record the music file.

5. Press **REC.** on the unit or **● REC** on the remote control to finish the setting.

Note

- When you stop recording during playback, the file that has been recorded at that time will be stored.
- Do not remove the USB device or turn off the unit during USB recording. If not, an incomplete file may be made and not deleted on PC.
- If USB recording does not work, the message like "NO USB", "ERROR", "FULL" or "NO REC" is displayed on the display window.
- Multi card reader device or External HDD can not be used for USB recording.
- A file is recorded by about 512 Mbyte when you record for a long term.
- You may not store more than 999 files.
- It'll be stored as follows.

| AUDIO CD | The other source* |
|---|--|
| <pre> CD_REC ├── TRK_001 ├── TRK_002 ├── ⋮ </pre> | <pre> EXT_REC ├── AUDIO_001 ├── AUDIO_002 ├── ⋮ </pre> |

* : TUNER, Portable and the like.

The making of unauthorized copies of copy-protected material, including computer programs, files, broadcasts and sound recordings, may be an infringement of copyrights and constitute a criminal offense. This equipment should not be used for such purposes.

Be responsible
Respect copyrights

Troubleshooting

| Problem | Cause & Correction |
|---|--|
| No Power. | <ul style="list-style-type: none"> • The power cord is not plugged in. Plug in the power cord. • Check whether electricity failed. Check the condition by operating other electronic devices. |
| No sound. | <ul style="list-style-type: none"> • Check whether you select right function. Press FUNCTION and check the selected function. • If not, connect speaker cables correctly. Speaker cables connected correctly. |
| The unit does not start playback. | <ul style="list-style-type: none"> • An unplayable disc is inserted. Insert a playable disc. • No disc is inserted. Insert a disc. • The disc is dirty. Clean the disc. (Refer to the 20 page) • The disc is inserted upside down. Place the disc with the label or printed side facing upwards. |
| Radio stations cannot be tuned in properly. | <ul style="list-style-type: none"> • The antenna is positioned or connected poorly. Connect the antenna securely. • The signal strength of the radio station is too weak. Tune to the station manually. • No stations have been preset or preset stations have been cleared (when tuning by scanning preset channels). Preset some radio stations, see page 12 for details. |
| The remote control does not work properly. | <ul style="list-style-type: none"> • The remote control is too far from the unit. Operate the remote control within about 23 ft (7 m). • There is an obstacle in the path of the remote control and the unit. Remove the obstacle. • The batteries in the remote control are exhausted. Replace the batteries with new ones. |
| iPod does not work. | <ul style="list-style-type: none"> • Check whether the player is connected to the unit correctly. Connect it to the unit correctly. |

Specifications

| General | |
|------------------------|--|
| Power requirements | Refer to the main label |
| Power consumption | Refer to the main label |
| Dimensions (W x H x D) | 230 X 134 X 228 mm |
| Net Weight (Approx.) | 1.9 kg |
| Operating temperature | 0 °C to 40 °C |
| Operating humidity | 5 % to 90 % |
| Bus Power Supply | USB DC 5 V \equiv 500 mA iPod DC 5 V \equiv 1 A |

| Inputs/ Outputs | |
|-----------------|----------|
| PORT. IN | 0.6 Vrms |

| Tuner | |
|-----------------|---------------------|
| FM Tuning Range | 87.5 MHz to 108 MHz |

| Amplifier | |
|-------------|-------------|
| Stereo mode | 70 W + 70 W |

| CD | |
|-----------------------|-----------------|
| Frequency Response | 20 Hz to 20 KHz |
| Signal-to-noise ratio | 75 dB |
| Dynamic range | 80 dB |

| Front Speaker | |
|----------------------------|--------------------|
| Type | 2 way 2 speaker |
| Impedance Rated | 8 Ω |
| Input Power | 70 W |
| Max. Input Power | 140 W |
| Net Dimensions (W x H x D) | 144 X 268 X 191 mm |
| Net Weight | 1.86 kg |

- Design and specifications are subject to change without notice.

Maintenance

Handling the Unit

When shipping the unit

Please save the original shipping carton and packing materials. If you need to ship the unit, for maximum protection, re-pack the unit as it was originally packed at the factory.

Keeping the exterior surfaces clean

Do not use volatile liquids such as insecticide spray near the unit.

Wiping with strong pressure may damage the surface.

Do not leave rubber or plastic products in contact with the unit for a long period of time.

Cleaning the unit

To clean the player, use a soft, dry cloth. If the surfaces are extremely dirty, use a soft cloth lightly moistened with a mild detergent solution. Do not use strong solvents such as alcohol, benzene, or thinner, as these might damage the surface of the unit.

Maintaining the Unit

The unit is a high-tech, precision device. If the optical pick-up lens and disc drive parts are dirty or worn, the picture quality could be diminished. For details, please contact your nearest authorized service center.

Notes on Discs

Handling Discs

Never stick paper or tape on the disc.

Storing Discs

After playing, store the disc in its case. Do not expose the disc to direct sunlight or sources of heat and never leave it in a parked car exposed to direct sunlight.

Cleaning Discs

Do not use strong solvents such as alcohol, benzene, thinner, commercially available cleaners, or anti-static spray intended for older vinyl records.

Trademarks and Licenses



iPod and iPhone are trademarks of Apple Inc., registered in the U.S. and other countries. "Made for iPod" and "Made for iPhone" mean that an electronic accessory has been designed to connect specifically to iPod or iPhone respectively, and has been certified by the developer to meet Apple performance standards. Apple is not responsible for the operation of this device or its compliance with safety and regulatory standards. Please note that the use of this accessory with iPod, iPhone may affect wireless performance.







| | Телефон | Режим работы | Интернет |
|------------|-----------------------------------|---|---|
| Россия | 8-800-200-7676 | Круглосуточно | http://www.lg.com |
| Беларусь | 8-820-0071-1111 | | |
| Латвия | 8-0003-271 | | |
| Литва | 8-800-30-800 | | |
| Эстония | 800-9990 | | |
| Украина | 0-800-303-000 | 8:00 - 21:00 (Пн.-Пят.) 9:00 - 18:00 (Суб., Вс.) | |
| Казахстан | 8-8000-805-805 | 9:00 - 18:00 (Пн.-Пят.) 9:00 - 18:00 (Суб.) | |
| | 2255 (для мобильных телефонов) | | |
| Кыргызстан | 8-0000-710-005 | Круглосуточно | |
| Узбекистан | | | |



Импортер LG Electronics RUS

Адрес импортера 143160 Российская Федерация, Московская область,
Рузский район, сельское поселение Дороховское, 86 км. Минского шоссе, д.9

Адрес производителя : Донг Гуан Матестар диджитал девайс ЛТД
Район ЧенВубей, город ЧанГпинг, Донг Гуан, Китай

MADE IN CHINA