



ENGLISH

OWNER'S MANUAL

DVD Micro Hi-Fi System

Please read this manual carefully before operating your set and retain it for future reference.

DM2820



MFL67581003

Safety Information



CAUTION: TO REDUCE THE RISK OF ELECTRIC SHOCK DO NOT REMOVE COVER (OR BACK) NO USER-SERVICEABLE PARTS INSIDE REFER SERVICING TO QUALIFIED SERVICE PERSONNEL.

This lightning flash with arrowhead symbol within an equilateral triangle is intended to alert the user to the presence of uninsulated dangerous voltage within the product's enclosure that may be of sufficient magnitude to constitute a risk of electric shock to persons.



The exclamation point within an equilateral triangle is intended to alert the user to the presence of important operating and maintenance (servicing) instructions in the literature accompanying the product.



WARNING: TO PREVENT FIRE OR ELECTRIC SHOCK HAZARD, DO NOT EXPOSE THIS PRODUCT TO RAIN OR MOISTURE.

WARNING: Do not install this equipment in a confined space such as a book case or similar unit.

CAUTION: Do not block any ventilation openings. Install in accordance with the manufacturer's instructions.

Slots and openings in the cabinet are provided for ventilation and to ensure reliable operation of the product and to protect it from over heating. The openings shall be never be blocked by placing the product on a bed, sofa, rug or other similar surface. This product shall not be placed in a built-in installation such as a bookcase or rack unless proper ventilation is provided or the manufacturer's instruction has been adhered to.



CAUTION: This product employs a Laser System. To ensure proper use of this product, please read this owner's manual carefully and retain it for future reference. Shall the unit require maintenance, contact an authorized service center. Use of controls, adjustments or the performance of procedures other than those specified herein may result in hazardous radiation exposure. To prevent direct exposure to laser beam, do not try to open the enclosure.

CAUTION concerning the Power Cord

Most appliances recommend they be placed upon a dedicated circuit;

That is, a single outlet circuit which powers only that appliance and has no additional outlets or branch circuits. Check the specification page of this owner's manual to be certain. Do not overload wall outlets. Overloaded wall outlets, loose or damaged wall outlets, extension cords, frayed power cords, or damaged or cracked wire insulation are dangerous. Any of these conditions could result in electric shock or fire. Periodically examine the cord of your appliance, and if its appearance indicates damage or deterioration, unplug it, discontinue use of the appliance, and have the cord replaced with an exact replacement part by an authorized service center. Protect the power cord from physical or mechanical abuse, such as being twisted, kinked, pinched, closed in a door, or walked upon. Pay particular attention to plugs, wall outlets, and the point where the cord exits the appliance. To disconnect power from the mains, pull out the mains cord plug. When installing the product, ensure that the plug is easily accessible.

This device is equipped with a portable battery or accumulator.

Safety way to remove the battery or the battery from the equipment: Remove the old battery or battery pack, follow the steps in reverse order than the assembly. To prevent contamination of the environment and bring on possible threat to human and animal health, the old battery or the battery put it in the appropriate container at designated collection points. Do not dispose of batteries or battery together with other waste. It is recommended that you use local, free reimbursement systems batteries and accumulators. The battery shall not be exposed to excessive heat such as sunshine, fire or the like.

CAUTION: The apparatus shall not be exposed to water (dripping or splashing) and no objects filled with liquids, such as vases, shall be placed on the apparatus.

Disposal of your old appliance



1. When this crossed-out wheeled bin symbol is attached to a product it means the product is covered by the European Directive 2002/96/EC.
2. All electrical and electronic products should be disposed of separately from the municipal waste stream via designated collection facilities appointed by the government or the local authorities.
3. The correct disposal of your old appliance will help prevent potential negative consequences for the environment and human health.
4. For more detailed information about disposal of your old appliance, please contact your city office, waste disposal service or the shop where you purchased the product.

Disposal of waste batteries/accumulators



1. When this crossed-out wheeled bin symbol is attached to batteries/accumulators of Your product it means they are covered by European Directive 2006/66/EC.
2. This symbol may be combined with chemical symbols for mercury(Hg), cadmium(Cd) or lead(Pb) if the battery Contains more that 0.0005% of mercury,0.002% of cadmium or 0.004% of lead.
3. All batteries/accumulators should be disposed separately from the municipal waste stream via designated collection facilities appointed by the government or the local authorities.
4. The correct disposal of Your old batteries/accumulators will help to prevent potential negative consequences for the environment, animal and human health.
5. For more detailed information about disposal of Your old batteries/accumulators, please contact Your city office, waste disposal service or the shop where You purchased the product.

You have to set the disc format option to [Mastered] in order to make the discs compatible with the LG players when formatting rewritable discs. When setting the option to Live File System, you cannot use it on LG players.

(Mastered/ Live File System : Disc format system for Windows Vista)

Table of Contents

1 Getting Started

- 2 Safety Information
- 6 Unique Features
 - 6 – Portable In
 - 6 – Full HD up-scaling
- 6 Accessories
- 7 Introduction
 - 7 – Playable Discs
 - 7 – About the "⓪" Symbol Display
 - 7 – Symbols Used in this Manual
 - 7 – Regional Codes
- 8 Playable file Requirement
 - 8 – MP3/ WMA music file requirement
 - 8 – Photo file requirement
 - 8 – Compatible USB Devices
 - 8 – USB device requirement
 - 9 – DivX file requirement
- 10 Remote control
- 11 Front panel
- 11 Top panel
- 12 Right panel
- 12 Left panel
- 13 Connecting the AC adapter
- 13 Mounting the main unit on the wall

2 Connecting

- 15 Connections to Your TV
 - 15 – HDMI Out Connection
 - 16 – Video Connection
- 18 Optional Equipment Connection
 - 18 – Listening to music from your portable player or external device
 - 18 – USB Operation
 - 18 – CD Operation
- 19 Antenna Connection
- 20 iPod/iPhone/iPad Connection
 - 20 – Compatible iPod/iPhone/iPad

3 System Setting

- 22 Adjust the setup settings
 - 22 – OSD Initial language settings - Optional
 - 22 – To display and exit the Setup menu
- 23 – Language
- 23 – Display
- 24 – Audio
- 24 – Lock (Parental Control)
- 25 – Others

4 Operating

- 26 Using the Home Menu
- 26 Basic Operations
- 27 Other Operation
 - 27 - Displaying Disc Information on-screen
 - 28 - To display the DVD Menu
 - 28 - To display the DVD title
 - 28 - Changing subtitle code page
 - 28 - 1.5 times speed playback
 - 28 - Resume playback
 - 28 - Last Scene Memory
 - 28 - Screen Saver
 - 29 - Marked Playback
 - 29 - Starting play from selected time
 - 30 - Viewing a PHOTO file
 - 31 - System Select - Optional
 - 31 - Displaying file information (ID3 TAG)
 - 31 - Turn off the sound temporarily
 - 31 - Adjust the speaker level settings
- 32 Setting the Clock
 - 32 - Using your player as an alarm clock
 - 33 - Sleep Timer Setting
 - 33 - Dimmer
- 33 Radio Operations
 - 33 - Listening to the radio
 - 33 - Presetting the Radio Stations
 - 33 - Deleting all the saved stations
 - 33 - Improving poor FM reception
- 34 Sound adjustment
 - 34 - Setting the sound mode

5 Troubleshooting

- 35 Troubleshooting

6 Appendix

- 36 Area Code List
- 37 Language code List
- 38 Trademarks and Licenses
- 39 Specifications
- 41 Maintenance
 - 41 - Handling the Unit
 - 41 - Notes on Discs

1

2

3

4

5

6

Unique Features

1

Getting Started

Portable In

Listens to music from your portable device. (MP3, Notebook, etc)

Full HD up-scaling

Views Full HD picture quality with simple setup.

Accessories

Please check and identify the supplied accessories.

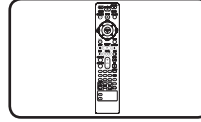

Remote control (1)

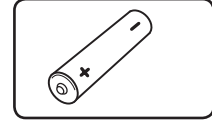

Battery (1)

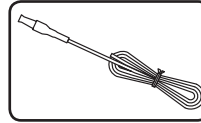

FM antenna (1)

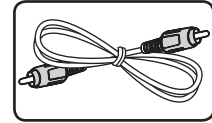

Video cable (1)

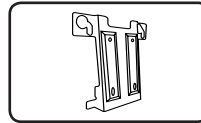

Wall Bracket (1)

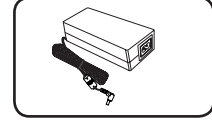

AC Adaptor (1)

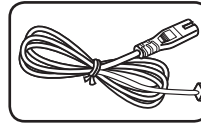

Power cord (1)

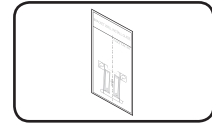

WALL BRACKET
INSTALL GUIDE (1)

Introduction

Playable Discs

This unit plays DVD±R/RW and CD-R/RW that contains audio titles, DivX, MP3, WMA and/or JPEG files. Some DVD±RW/DVD±R or CD-RW/CD-R cannot be played on this unit due to the recording quality or physical condition of the disc, or the characteristics of the recording device and authoring software.



DVD-VIDEO (12 cm disc)
Discs such as movies that can be purchased or rented.



DVD±R (12 cm disc)
Video mode and finalized only.



DVD-RW (12 cm disc)
Video mode and finalized only.



DVD+R: Video mode only
Supports the double layer disc also.



DVD+RW (12 cm disc)
Video mode and finalized only.



Audio CD: Music CDs or CD-R/CD-RW in music CD format that can be purchased.

About the “⊗” Symbol Display

“⊗” may appear on your TV display during operation and indicates that the function explained in this owner’s manual is not available on that specific media.

Symbols Used in this Manual



DVD-Video, DVD±R/RW in Video mode or VR mode and finalized



Audio CDs



Video files contained in the USB/Disc



Audio files contained in the USB/Disc



Photo files

! Note

Indicates special notes and operating features.

! Tip

Indicates tip and hints for making the task easier.

! Caution

Indicates cautions for preventing possible damages from abuse.

Regional Codes

This unit has a regional code printed on the rear of the unit. This unit can play only DVD discs labeled same as the rear of the unit or “ALL”.

- Most DVD discs have a globe with one or more numbers in it clearly visible on the cover. This number must match your unit’s regional code or the disc cannot play.
- If you try to play a DVD with a different regional code from your unit, the message “Check Regional Code” appears on the TV screen.

Playable file Requirement

MP3/ WMA music file requirement

MP3/ WMA file compatibility with this unit is limited as follows :

- Sampling frequency : within 32 to 48 kHz (MP3), within 32 to 48 kHz (WMA)
- Bit rate : within 32 to 320 kbps (MP3), 40 to 192 kbps (WMA)
- Support Version : v2, v7, v8, v9
- Maximum files : Under 999
- File extensions : ".mp3"/ ".wma"
- CD-ROM file format : ISO 9660/ JOLIET
- We recommend that you use Easy-CD Creator, which creates an ISO 9660 file system.

Photo file requirement

Photo file compatibility with this unit is limited as follows :

- Max pixel in width : 2 760 x 2 048 pixel
- Maximum files : Under 999
- Some discs may not operate due to a different recording format or the condition of disc.
- File extensions: ".jpg"
- CD-ROM file format : ISO 9660/ JOLIET

Compatible USB Devices

- MP3 Player : Flash type MP3 player.
- USB Flash Drive : Devices that support USB2.0 or USB1.1.
- The USB function of this unit does not support some USB devices.

USB device requirement

- Devices which require additional program installation connected to a computer, are not supported.
- Do not extract the USB device while in operation.
- For a large capacity USB, it may take longer than a few minute to be searched.
- To prevent data loss, back up all data.
- If you use a USB extension cable or USB hub, the USB device is not recognized.
- Using NTFS file system is not supported. (Only FAT(16/32) file system is supported.)
- This unit is not supported when the total number of files is 1 000 or more.
- External HDD, Card readers, Locked devices, or hard type usb devices are not supported.
- Some USB device may not work with this unit.
- USB port of the unit cannot be connected to PC. The unit can not be used as a storage device.

DivX file requirement

DivX file compatibility with this unit is limited as follows:

- Available resolution: within 800 x 600 (W x H) pixels.
- The file name of the DivX subtitle should be entered within 45 characters.
- If there is impossible code to express in the DivX file, it may be displayed as “_” mark on the display.
- Frame rate : less than 30 fps.
- If the video and audio structure of recorded files is not interleaved, either video or audio is outputted.
- Playable DivX file : “.avi”, “.mpg”, “.mpeg”, “.divx”
- Playable Subtitle format : SubRip (*.srt/ *.txt), SAMI (*.smi), SubStation Alpha (*.ssa/ *.txt), MicroDVD (*.sub/ *.txt), SubViewer 2.0 (*.sub/ *.txt), Vobsub (*.sub)
- Playable Codec format : “DIVX3.xx”, “DIVX4.xx”, “DIVX5.xx”, “DIVX6.xx”, “MP4V3”, “3IVX”.
- Playable Audio format : “AC3”, “PCM”, “MP3”, “WMA”.
- Sampling frequency : within 32 to 48 kHz (MP3), within 32 to 48 kHz (WMA)
- Bit rate : within 32 to 320 kbps (MP3), 40 to 192 kbps (WMA)
- For Discs formatted in Live file system, you can not play it on this unit.
- If the name of movie file is different from that of the subtitle file, during playback of a DivX file, subtitle may not be displayed.
- If you play a DivX file which differs from DivX spec, it may not operate normally.

1 Getting Started

Remote control

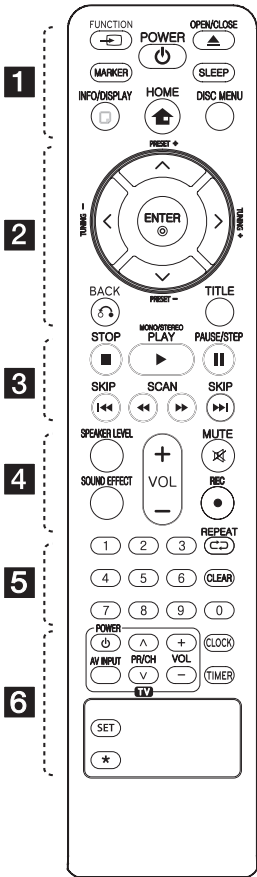

..... **1**

FUNCTION : Selects the function and input source.

MARKER : Marks play list.

POWER : Switches the unit ON or OFF.

OPEN/CLOSE : Ejects the disc from slot loader.

SLEEP : Sets the System to turn off automatically at a specified time. (Dimmer : The display window will be darkened by half.)

INFO/DISPLAY : Accesses On-Screen Display.

HOME : Displays the [Home Menu].

DISC MENU : Accesses the menu on a DVD.

..... **2**

Λ / V / < / > (up/ down/ left/ right) : Uses to navigate on-screen displays.

PRESET (+/-) : Selects the radio station.

TUNING (-/+) : Tunes in the desired radio station.

ENTER : Acknowledges menu selection. Presetting the radio stations.

BACK : Moves backwards in the menu or exits the setup menu.

TITLE : If the current DVD title has a menu, the title menu appears on the screen. Otherwise, the disc menu may not appear.

◀ / ▶ SCAN : Searches backward or forward.

..... **4**

SPEAKER LEVEL : Sets the sound level of desired speaker.

SOUND EFFECT : Selects a sound effect mode.

VOL (+/-) : Adjusts speaker volume.

MUTE : Mutes the sound.

***** : This button is not available.

..... **5**

0-9 numerical buttons : Selects numbered options in a menu.

REPEAT : Selects a play mode. (Repeat/ Random)

CLEAR : Removes a number when setting the password.

..... **6**

TV Control buttons : Controls the TV. (LG TV only)

- You can control the sound level, input source, and power switching of LG TVs as well. Hold **POWER** and press **PR/CH (Λ/V)** button repeatedly until the TV turns on or off.

CLOCK : Sets a clock and checks a time.

TIMER : Uses your player as an alarm clock.

SET : Confirms clock and alarm setting.

***** : This button is not available.

Battery Installation

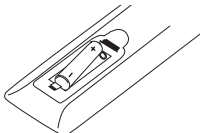

Remove the battery cover on the rear of the Remote Control, and insert one (size AAA) battery with **+** and **-** matched correctly.

..... **3**

STOP : Stops playback.

▶ PLAY, MONO/STEREO :
- Starts playback.
- Selects Mono/ Stereo.

|| PAUSE/STEP :
- Pauses playback.
- Plays title Frame-by-Frame. (DVD, DivX, only)

◀◀ / ▶▶ SKIP : Goes to the next or previous chapter / track / file.

Front panel

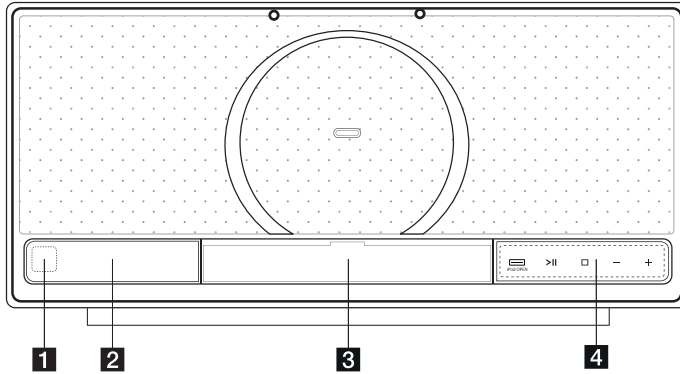

- 1** Remote Sensor
- 2** Display window
- 3** iPod/iPhone/iPad Dock
- 4**  **iPod OPEN**
Opens and closes the iPod/iPhone/iPad Dock.
>|| (PLAY/PAUSE)
Starts playback and pause.
□ (STOP)
Stops playback or recording.
-/+ (VOLUME)
Adjusts volume level.

Top panel

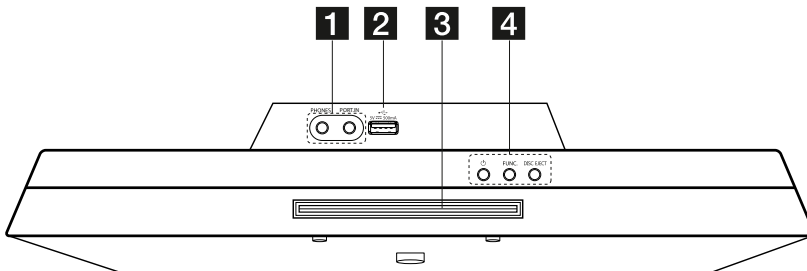

- 1** **PHONES**
Headphone jack
PORT.IN
Listens to music from your portable device.
- 2** **USB Port**
Plays music file by connecting the USB device.
- 3** **Disc slot**
- 4**  **(POWER)**
Switches the unit ON or OFF.
FUNC.
Selects the function and input source.
DISC EJECT
Ejects a DISC from the unit.

Right panel

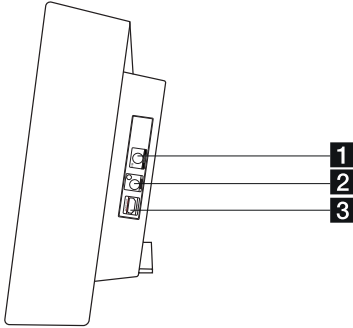

- 1 FM ANTENNA**
Connects the FM wired antenna.
- 2 VIDEO OUT**
Connects to a TV with video inputs.
- 3 HDMI OUT TO TV**
Connects to TV with HDMI inputs.
(Interface for digital audio and video)

Caution

Precautions in using the touch buttons.

- Use the touch buttons with clean and dry hands.
 - In a humid environment, wipe out any moisture on the touch buttons before using.
- Do not press the touch buttons hard to make it work.
 - If you apply too much strength, it can damage the sensor of the touch buttons.
- Touch the button that you want to work in order to operate the function correctly.
- Be careful not to have any conductive material such as metallic object on the touch buttons. It can cause malfunctions.

Left panel

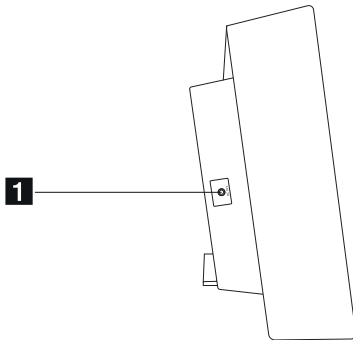

- 1 DC 18V (AC adapter input)**

Connecting the AC adapter

1. Connect the supplied AC power cord to the AC adapter.
2. Connect the AC adapter cable to AC adapter input.
3. Plug the AC power cord into an AC outlet.

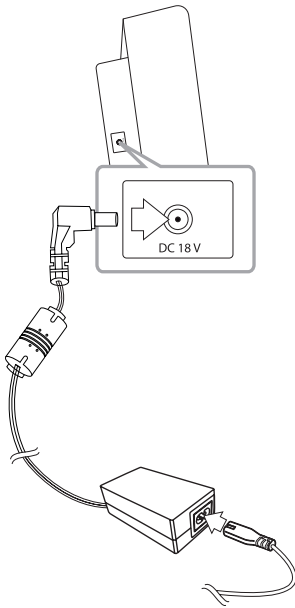

! Caution

Only use the AC adapter supplied with this device. Do not use a power supply from another device or manufacturer. Using any other power cable or power supply may cause damage to the device and void your warranty.

Mounting the main unit on the wall

You can mount the main unit on a wall. Prepare screws and brackets supplied.

Preparation

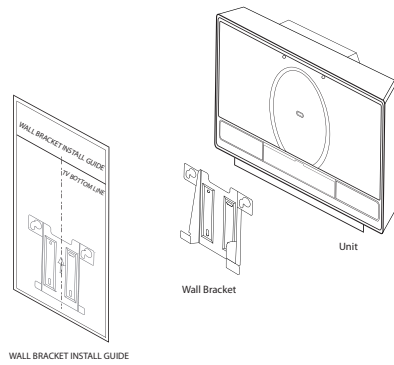

1. Match the TV BOTTOM LINE of WALL BRACKET INSTALL GUIDE with the bottom of TV and attach it to the position.

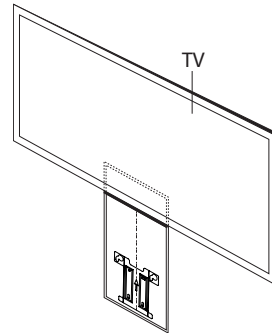

14 Getting Started

1 Getting Started

2. When you mount the wall bracket on a wall (concrete), use the wall bracket to check the point to drill. Then you should drill some holes.

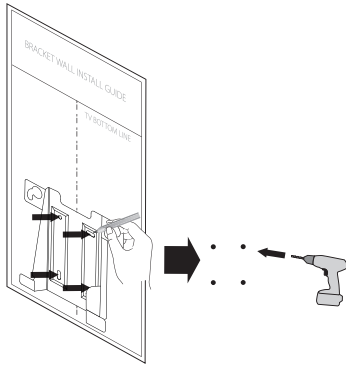

3. Remove the WALL BRACKET INSTALL GUIDE.
4. Fix it with screws (not supplied) as shown in the illustration below.

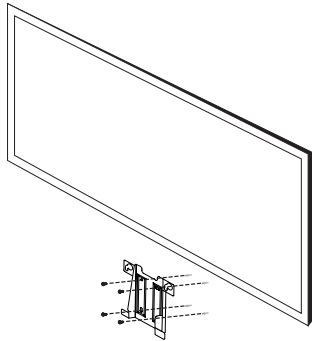

! Note

Screws and anchors are not supplied for mounting the unit. We recommend the FAB31058701 screw and MEG62598701 anchor for the mounting. Please purchase them.

5. Hang the main unit onto the brackets, as shown below.

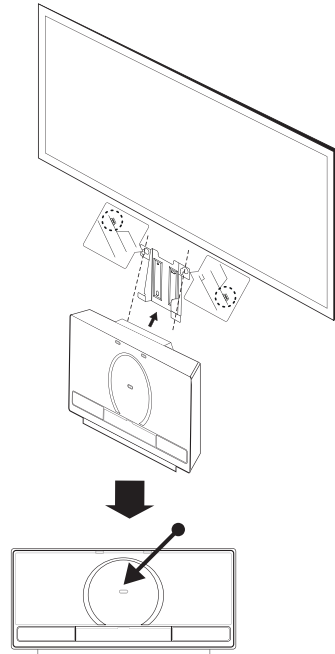

! Caution

- Do not hang onto the installed unit and avoid any impact to the unit.
- Secure the unit firmly to the wall so that it does not fall off. If the unit falls off, it may result in an injury or damage to the product.
- When the unit is installed on a wall, please make sure that a child does not pull any of connecting cables, as it may cause it to fall.

! Note

Detach the unit from the bracket as shown below.

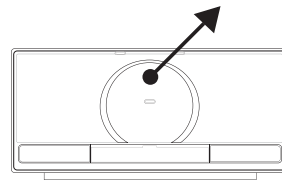

Connections to Your TV

Make one of the following connections, depending on the capabilities of your existing equipment.

! Note

- Depending on your TV and other equipment you wish to connect, there are various ways you could connect the player. Use only one of the connections described in this manual.
- Please refer to the manuals of your TV, Stereo System or other devices as necessary to make the best connections.

! Caution

- Make sure the unit is connected directly to the TV. Tune the TV to the correct video input channel.
- Do not connect your player via your VCR. The image could be distorted by the copy protection system.

HDMI Out Connection

If you have a HDMI TV or monitor, you can connect it to this unit by using a HDMI cable (Type A, High Speed HDMI™ cable).

Connect the HDMI OUT jack on the unit to the HDMI IN jack on a HDMI compatible TV or monitor. Set the TV's source to HDMI (refer to TV's Owner's manual).

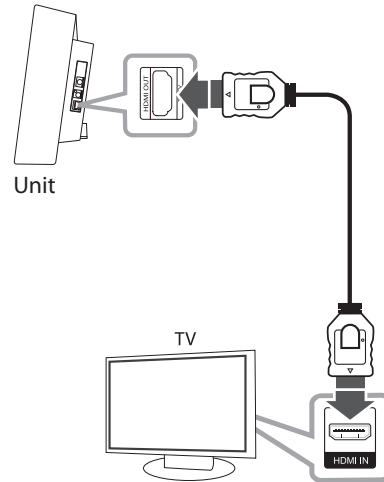

! Tip

- You can fully enjoy digital audio and video signals together with this HDMI connection.
- When you use HDMI connection, you can change the resolution for the HDMI output. (Refer to "Resolution Setting" on page 17.)

Note

- If a connected HDMI device does not accept the audio output of the unit, the HDMI device's audio sound may be distorted or may not output.
- When you connect a HDMI or DVI compatible device make sure of the following:
 - Try switching off the HDMI/DVI device and this unit. Next, switch on the HDMI/DVI device and leave it for around 30 seconds, then switch on this unit.
 - The connected device's video input is set correctly for this unit.
 - The connected device is compatible with 720 x 480i (or 576i), 720 x 480p (or 576p), 1 280 x 720p, 1 920 x 1 080i or 1 920 x 1 080p video input.
- Not all HDCP-compatible HDMI or DVI devices will work with this unit.
 - The picture will not be displayed properly with non-HDCP device.
 - This unit does not playback and TV screen is changed to black or green screen or the snow noise may occur on the screen.
- If there is noise or lines on the screen, please check the HDMI cable and use a higher version cable than High Speed HDMI™ cable.

Caution

- Changing the resolution when the connection has already been established may result in malfunctions. To solve the problem, turn off the unit and then turn it on again.
- When the HDMI connection with HDCP is not verified, TV screen is changed to black or green screen or the snow noise may occur on the screen. In this case, check the HDMI connection, or disconnect the HDMI cable.

Video Connection

Connect the VIDEO OUT jack on the unit to the video in jack on the TV by using a video cable.

You can hear the sound through the system's speakers.

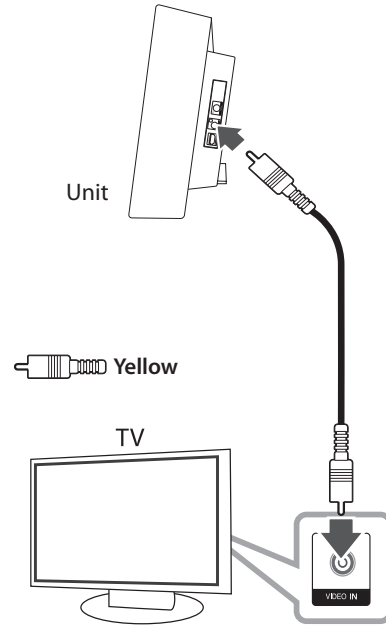

Resolution Setting

The unit provides several output resolutions for HDMI OUT and VIDEO OUT jacks. You can change the resolution by using [Setup] menu.

1. Press **HOME**.
2. Use **</>** to select the [Setup] and press **ENTER**. The [Setup] menu appears.



3. Use **^/v** to select [Display] option then press **>** to move to the second level.
4. Use **^/v** to select the [Resolution] option then press **>** to move to the third level.
5. Use **^/v** to select the desired resolution then press **ENTER** to confirm your selection.

! Note

If your TV does not accept the resolution you have set on the player, you can set resolution to 480p (or 576p) as follows:

Press **STOP** for more than 5 seconds.

Video Output Resolution

Displayed resolution in display window and outputted resolution may differ according to connection type.

[VIDEO OUT]: 480i (or 576i)

Optional Equipment Connection



2

Connecting

Listening to music from your portable player or external device

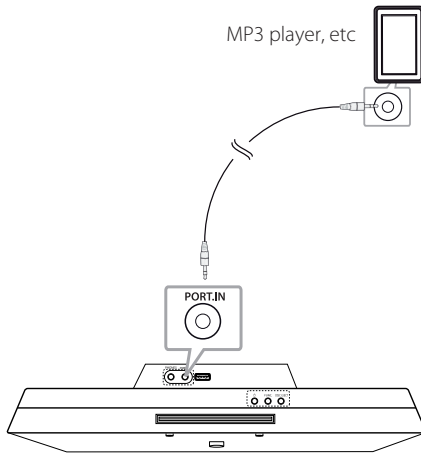
The unit can be used to play the music from many types of portable player or external devices. (Portable cable is not supplied as accessory with unit.)



1. Connect the external device to the **PORT. IN** connector of the unit.
2. Turn the power on by pressing .
3. Select the PORTABLE function by pressing  **FUNCTION** on the remote control or **FUNC.** on the unit.
4. Turn the external device on and start playing it.

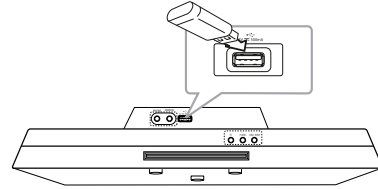

USB Operation

Connect the USB port of USB Memory (or MP3 player, etc.) to the USB port on the unit.





! Note

Removing the USB Device from the unit

1. Choose a different function/mode or press  **STOP** on the remote control or  on the unit twice in a row.
2. Remove the USB device from the unit.

CD Operation

1. Insert a disc in the disc slot with the label side forward.
2. Select the CD function by pressing  **FUNCTION** on the remote control or **FUNC.** on the unit.
3. Select a track/file you want to play by pressing  on the remote control.

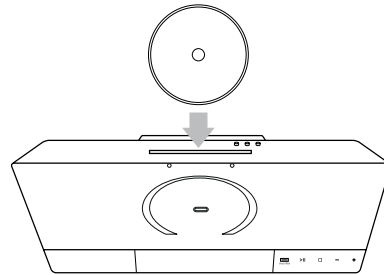

! Note

Music CDs or CD-R/CD-RW in music CD format can be only played. (12 cm disc)

| To | Do this |
|----------------------------------------------|-----------------------------------------------------------------------------------------------------------------------------------------------------------------------------------------------------------------------------------------------------------------------------------------------------------------------------------------|
| Stop | Press ■ STOP on the remote control or □ on the unit. |
| Playback | Press ▶ PLAY, MONO/STEREO on the remote control or > on the unit. |
| Pause | During playback, Press ▶ PLAY, MONO/STEREO on the remote control or > on the unit. |
| Skipping to the next/previous track/ file | During playback, press ⏮/⏭ on the remote control to go to the next track/file or to return to the beginning of the current track/file. Press ⏮ twice briefly to step back to the previous track/file. |
| Searching for a section within a track/ file | Press and hold ⏮/⏭ during playback and release it at the point you want to listen to. |
| Searching for a section within a folder | Press ⏮/⏭ . |
| Playing repeatedly or randomly | Press ↺ REPEAT on the remote control repeatedly, the display window will be changed in the following order, ↺ : The current track or file will be played back repeatedly. ↻ : All the tracks or files will be played back repeatedly. ⌘ : The tracks or files will be played back in random order. |

Antenna Connection

Connect the supplied FM antenna for listening to the radio.

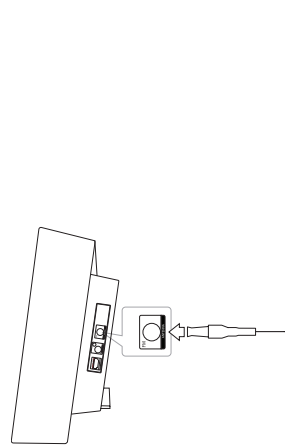

! Note

Be sure to fully extend the FM wire antenna. After connecting the FM wire antenna, keep it as horizontal as possible.

iPod/iPhone/iPad Connection

You can enjoy the sound with your iPod/iPhone/iPad. For details about iPod/iPhone/iPad, refer to the iPod/iPhone/iPad User Guide.

1. Press **△** on the unit. Then iPod/iPhone/iPad Dock will come out. Connect the iPod/iPhone/iPad firmly. Your iPod/iPhone/iPad is automatically turned on and starts recharging.

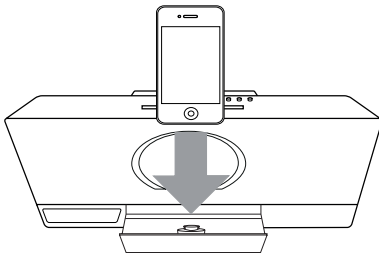

2. Press **FUNC.** on the unit or **FUNCTION** on the remote control to select iPod function.

| To | Do this | |
|---------------------------|---------|----------------------------|
| | ON UNIT | ON REMOTE |
| Pauses or restart | > | ▶ PLAY, MONO/STEREO |
| Skip | - | ◀◀/▶▶ |
| Search | - | Press and hold ◀◀/▶▶ |
| Move to the previous menu | - | </> |
| Move to the desired item | - | ∧/∨ |
| Chooses a item | - | ⊙ ENTER |

Compatible iPod/iPhone/iPad

- The unit supports the models as follows ;

iPod touch
iPod classic
iPod nano
iPhone 4S
iPhone 4
iPhone 3GS
iPhone 3 G
iPad2
iPad

For some models, the unit may not operate depending on the firmware version.

Depending on your iPod/iPhone/iPad's software version, you may not control your iPod/iPhone/iPad from the unit.

Note

- If this unit displays an error message, follow the message. An error message "ERROR".
 - Your iPod/iPhone/iPad is not connected firmly.
 - This unit recognizes your iPod/iPhone/iPad as an unknown device.
 - Your iPod/iPhone/iPad is exceptionally low in power.
 - ➔ The battery needs to be charged.
 - ➔ If you charge the battery while iPod/iPhone/iPad is extremely low in power, it may take longer to be charged.
- Depending on your iPod/iPhone/iPad's software version, it may not be possible to control your iPod/iPhone/iPad from this unit. We recommend installing the latest software version.
- If you use an application, make a call, or send and receive SMS text message, etc. on iPod touch or iPhone, disconnect it from iPod/iPhone/iPad dock of this unit and then use it.
- If you have a problem with your iPod/iPhone/iPad, please visit www.apple.com/support.
- In power off state, you can charge your iPod/iPhone/iPad by connecting it to iPod/iPhone/iPad Dock.
- You may need additional operation for iPod touch or iPhone, for example "unlock" by dragging the slider.

Adjust the setup settings

By using the Setup menu, you can make various adjustments to items such as picture and sound.

You can also set a language for the subtitles and the Setup menu, among other things. For details on each Setup menu item, see pages 22 to 25.

OSD Initial language settings - Optional

During the first use of this unit, the initial language setup menu appears on your TV screen. You must complete initial language selection before using the unit. English will be selected as the initial language.

1. Press **(POWER)** to turn the unit on. The language setup menu will appear on the screen.

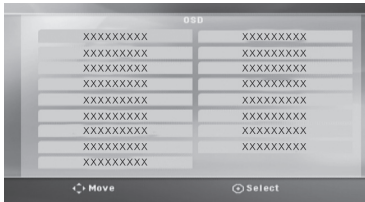

2. Use **^ / V / < / >** to select a language then press **ENTER**. The confirm menu will appear.

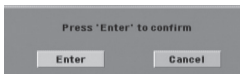

3. Use **< / >** to select the [Enter] then press **ENTER** to finish the language setup.

To display and exit the Setup menu

1. Press **HOME**.
Displays the [Home Menu].



2. Select an [Setup] by using **< / >**.
3. Press **ENTER**.
Displays the [Setup].
4. Press **HOME** or **BACK** to exit in the [Setup] Menu.

About help menu for Setup

| Menu | Buttons | Operation |
|----------------|--------------|-----------------------------------------|
| ▲▼ Move | ^ / V | Moving to another menu. |
| ◀ Move | < | Moving to previous level. |
| ▶ Move | > | Moving to next level or selecting menu. |
| Close | BACK | To exit the [Setup] menu. |
| Select | ENTER | To confirm menu. |

Language

Menu Language

Select a language for the Setup menu and then on screen display.

Disc Audio / Disc Subtitle / Disc Menu

Select the language you prefer for the audio track (disc audio), subtitles, and the disc menu.

[Original]

Refers to the original language in which the disc was recorded.

[Other]

To select another language, press numeric buttons and then **ENTER** to enter the corresponding 4-digit number according to the language code list on the page 37. If you enter the wrong language code, press **CLEAR**.

[Off (for Disc Subtitle)]

Turn off Subtitle.

Display

TV Aspect

Select which screen aspect to use is based on the shape of your TV screen.

[4:3]

Select when a standard 4:3 TV is connected.

[16:9]

Select when a 16:9 wide TV is connected.

Display Mode

The Display Mode setting works only when the TV Aspect mode is set to 4:3.

[Letterbox]

Displays a wide picture with bands on the upper and lower portions of the screen.

[Panscan]

Automatically displays the wide picture on the entire screen and cuts off the portions that do not fit. (If the disc/file is not compatible with Pan Scan, the picture is displayed at Letterbox ratio.)

Resolution

Sets the output resolution of the Component and HDMI video signal. Refer to "Resolution Setting" for details about the resolution (page 17).

[Auto]

If the HDMI OUT jack is connected to TVs providing display information (EDID), automatically selects the resolution best suited to the connected TV.

[1080p]

Outputs 1 080 lines of progressive video.

[1080i]

Outputs 1 080 lines of interlaced video.

[720p]

Outputs 720 lines of progressive video.

[480p (or 576p)]

Outputs 480 (or 576) lines of progressive video.

[480i (or 576i)]

Outputs 480 (or 576) lines of interlaced video.

Audio

DRC (Dynamic Range Control)

Make the sound clear when the volume is turned down (Dolby Digital only). Set to [On] for this effect.

Vocal

Select [On] to mix karaoke channels into normal stereo.

This function is effective for multi-channel karaoke DVDs only.

HD AV Sync

Sometimes Digital TV encounters a delay between picture and sound. If this happens, you can compensate by setting a delay on the sound so that it effectively 'waits' for the picture to arrive: this is called HD AV Sync. Use **▲ / ▼** (on the remote control) to scroll up and down through the delay amount, which you can set at anything between 0 and 300m sec.

Lock (Parental Control)

Initial Setting the Area Code:

When you use this unit for the first time, you have to set the Area Code.

1. Select the [Lock] menu and then press **>**.
2. Press **>**.
To access the [Lock] options, you must input the password you have created. Input a password and press **⊙ ENTER**. Enter it again and press **⊙ ENTER** to verify. If you make a mistake before pressing **⊙ ENTER**, press **CLEAR**.
3. Select the first character using **▲ / ▼** buttons.
4. Press **⊙ ENTER** and select the second character using **▲ / ▼** buttons.
5. Press **⊙ ENTER** to confirm your Area code selection.

Rating

Blocks playback of rated DVDs based on their contents. Not all discs are rated.

1. Select [Rating] on the [Lock] menu then press **>**.
2. Input a password and press **⊙ ENTER**.
3. Select a rating from 1 to 8 by using the **▲ / ▼** buttons.

[Rating 1-8]

Rating one (1) has the most restrictions and rating eight (8) is the least restrictive.

[Unlock]

If you select unlock, parental control is not active and the disc plays in full.

4. Press **⊙ ENTER** to confirm your rating selection.

Password

You can enter or change password.

1. Select [Password] on the [Lock] menu and then press **>**.
2. Press **⊙ ENTER**.
3. Input a password and press **⊙ ENTER**.
To change the password, press **⊙ ENTER** when the [Change] option is highlighted. Input a password and press **⊙ ENTER**. Enter it again and press **⊙ ENTER** to verify.
4. Press **HOME** to exit the menu.

Note

If you forget your password, you can clear it by using the following steps:

1. Select the [Setup] menu on the [Home Menu].
2. Input the 6-digit number "210499" and press **⊙ ENTER**. The password is cleared.

Others

DivX VOD

We provide you with the DivX® VOD (Video On Demand) registration code that allows you to rent and purchase videos using the DivX® VOD service.

For more information, visit www.divx.com/vod.

[Register]

Displays the registration code of your player.

[Deregister]

Deactivate your player and display the deactivation code.

Note

All the downloaded videos from DivX VOD can only be played back on this unit.

Area Code

Enter the code of the area whose standards were used to rate the DVD video disc, based on the list on the page 36.

1. Select [Area Code] on the [Lock] menu then press **>**.
2. Input a password and press **⊙ ENTER**.
3. Select the first character by using **Λ / V** buttons.
4. Press **⊙ ENTER** and select the second character by using **Λ / V** buttons.
5. Press **⊙ ENTER** to confirm your Area code selection.

Using the Home Menu

1. Press **HOME**.
Displays the [Home Menu].



2. Select an option by using **</>**.
3. Press **ENTER** to select option menu.
[Music] – Displays [MUSIC] menu.
[Movie] – Start video media's playback or displays the [MOVIE] menu.
[Photo] – Displays [PHOTO] menu.
[Setup] – Displays the [Setup] menu.

Note

You can not select the [Music], [Movie] or [Photo] option when the USB device is not connected or a disc is not inserted.

Basic Operations

1. Insert the disc in the disc slot or connect the USB device to the USB port.
2. Press **HOME**.
Displays the [Home Menu].
3. Select an option by using **</>**.
If you want to select the [Movie], [Photo] or [Music] option when you connect up to two devices, it appears as belows. Select a media then press **ENTER**.



4. Press **ENTER** to select option menu.

Note

- For the most Audio CD and DVD-ROM discs, playback starts automatically.
- The unit plays only music file contained in the USB storage device or disc automatically.

| To | Do this |
|----------------------------------------------------------------------------|-------------------------------------------------------------------------------------------------------------------------------------------------------------------------------------------------------------------------------------------------------------|
| Stop | Press ■ STOP . |
| Playback | Press ▶ PLAY, MONO/ STEREO . |
| Pause | Press ⏸ PAUSE/STEP . |
| Frame-by-Frame playback | Press ⏸ PAUSE/STEP repeatedly to play title Frame-by-Frame. (DVD, DivX only) |
| Skipping to the next/ previous chapter/ track/ file | During playback, press ⏮ / ⏭ SKIP to go to the next chapter/ track/ file or to return to the beginning of the current chapter/ track/ file. During playback, Press ⏮ SKIP twice briefly to step back to the previous chapter/ track/ file. |
| Locating a point quickly by playing a file in fast forward or fast reverse | During playback, press ⏩ / ⏪ SCAN repeatedly to select the required scan speed. To return to normal speed, press ▶ PLAY, MONO/ STEREO . |
| Playing repeatedly or randomly | Press REPEAT repeatedly, and the current title, chapter or track will be played back repeatedly or randomly. - DVD : Chapter/ Title/ Off - DivX : Title/ All/ Off - Audio CD/ MP3/ WMA : Track/ All/ Random/ Off |
| Slowing down the playing speed | In the pause mode, press ⏮ / ⏭ SCAN to select the required speed. (DVD, DivX only) The DivX file cannot be slow down reverse playback. |

Other Operation

Displaying Disc Information on-screen

You can display various information about the disc loaded on-screen.

- Press **□ INFO/DISPLAY** to show various playback information.
The displayed items differ depending on the disc type or playing state.
- You can select an item by pressing **▲ / ▼** and change or select the setting by pressing **< / >**.

- Title - Current title number/total number of titles.
- Chapter - Current chapter number/total number of chapters.
- Time - Elapsed playing time
Selected total time of current title/ file.
- Audio - Selected audio language or channel.
- Subtitle - Selected subtitle.
- Angle - Selected angle/total number of angles.

! Note

If any button is not pressed for a few seconds, the on-screen display disappears.

To display the DVD Menu

DVD

When you play a DVD which contains several menus, you can select the menu you want by using the **DISC MENU**.

1. Press **DISC MENU**. The disc's menu appears.
2. Select the menu by using **▲/▼/◀/▶**.
3. Press **⊙ENTER** to confirm.

To display the DVD title

DVD

When you play a DVD which contains several titles, you can select the title you want by using the **TITLE**.

1. Press **TITLE**. The disc's title appears.
2. Select the menu by pressing **▲/▼/◀/▶**.
3. Press **⊙ENTER** to confirm.

Changing subtitle code page

MOVIE

If the subtitle is not displayed properly, you can change the subtitle code page to view the subtitle file properly.

1. During playback, press **□ INFO/DISPLAY** to display the On-Screen display.
2. Use **▲/▼** to select the [Code Page] option.
3. Use **◀/▶** to select desired code option.
4. Press **↶ BACK** to exit the On-Screen display.

1.5 times speed playback

DVD

The 1.5 speed allows you to watch the pictures and to listen to the sound quicker than to play at a normal speed.

1. During playback, press **▶ PLAY, MONO/STEREO** to play at 1.5 times speed. "▶X1.5" will appear on the screen.
2. Press **▶ PLAY, MONO/STEREO** again to exit.

Resume playback

DVD MOVIE MUSIC ACD

The unit records the point where you pressed the **■ STOP** depending on the disc.

If "■" (Resume Stop) appears on the screen briefly, press **▶ PLAY, MONO/STEREO** to resume playback (from the scene point).

If you press **■ STOP** twice or unload the disc, "■" (Complete Stop) appears on the screen. The unit will clear the stopped point.

! Note

The resume point may be cleared when a button is pressed (for example; **⏻ (POWER)**, **▲ OPEN/CLOSE**, etc).

Last Scene Memory

DVD

This unit memorizes last scene from the last disc that is viewed. The last scene remains in memory even if you remove the disc from the unit or switch off the unit. If you load a disc that has the scene memorized, the scene is automatically recalled.

Screen Saver

The screen saver appears when you leave the unit in Stop mode for about five minutes.

Marked Playback

MUSIC ACD

The mark function enables you to store your favourite files from any disc or USB device in the unit memory.

1. Select [Music] on the [Home Menu].

Returning to the upper folder.
(MP3/WMA only)

File information will be displayed according to the ID3TAG information on the appropriate music file. (MP3 only)



Selecting all tracks/ files.

Deselecting all tracks/files.

Moving to the previous or next file list.

2. Select a desired music on the [List] by using the \wedge / \vee then press **MARKER** to appears the mark on the list.
3. Press \odot **ENTER** or \blacktriangleright **PLAY, MONO/STEREO**. Displays the play mode.
4. Select the play mode by using the \wedge / \vee and press \odot **ENTER**.

[Mark Play]

Marked playback.

[Current Play]

Normal playback.

! Note

If you want to select all files on the list, select [Select All] and press \odot **ENTER**.

To delete a Marker

1. Use \wedge / \vee to select the track/file that you wish to erase from the marked file.
2. Press **MARKER**.

To delete all Markers

Use $\wedge / \vee / < / >$ to select [Deselect All] then press \odot **ENTER** in program edit mode.

! Note

The markers are also cleared when the disc or USB device is removed, the unit is switched to power off or the function is switched to others.

Starting play from selected time

DVD MOVIE

To start playing at any chosen time on the file or title,

1. Press \square **INFO/DISPLAY** during playback.
2. Press \wedge / \vee to select the time clock icon and "--:--:" appears.
3. Input the required start time in hours, minutes, and seconds from left to right. If you enter the wrong numbers, press **CLEAR** to remove the numbers you entered. Then input the correct numbers.
For example, to find a scene at 1 hour, 10 minutes, and 20 seconds, enter "11020" by using numerical buttons.
4. Press \odot **ENTER** to confirm. Playback starts from the selected time.

Viewing a PHOTO file

PHOTO

This unit can play discs/USB with photo files.

1. Select [Photo] on the [Home Menu] and press **ENTER**.

Moving to the previous or next file list.



Returning to the upper folder.

2. Press **^ / V** to select a folder, and then press **ENTER**.
3. If you want to view a slide show, press **^ / V** to highlight a file and press **▶ PLAY, MONO/STEREO**.

About help menu in the [Photo] menu

| Menu | Buttons | Operation |
|---------------------|----------------------------|------------------------------------|
| ▶ Slide Show | ▶ PLAY, MONO/STEREO | Viewing a slide show. |
| ▲▼▲▼ Move | ^ / V / < / > | Moving to another file or content. |
| ⊙ Select | ⊙ ENTER | Viewing a particular file. |
| ↶ Close | ↶ BACK | Returning to the [Home Menu]. |

About help menu in the full screen

| Menu | Buttons | Operation |
|--------------------------|-----------------------|--------------------------------|
| Menu | ☐ INFO/DISPLAY | Displaying the Option menu. |
| ◀ / ▶ Prev./ Next | < / > | Moving to another file. |
| ↶ LIST | ↶ BACK | Returning to the [Photo] menu. |

Options while viewing a photo

You can use various options during viewing a photo in full screen.

1. While viewing a photo in full screen, press **☐ INFO/DISPLAY** to display the option menu.
2. Select an option using **^ / V / < / >**.

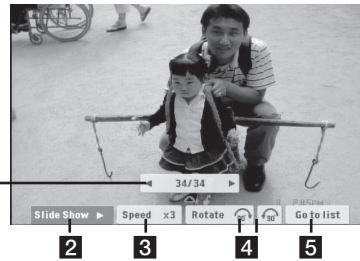

- 1 Current photo/ Total number of photos** – Use **< / >** to view previous/next photo.
- 2 Slide Show ▶ / ||** – Press **ENTER** to start or pause slide show.
- 3 Speed x3/ x2/ x1** – Use **ENTER** to select a delaying speed between photos in a slide show.
- 4 Rotate** – Press **ENTER** to rotate the photo.
- 5 Go to list** – Press **ENTER** to return [Photo] menu.

System Select - Optional

You must select the appropriate system mode for your TV system. Press and hold **II PAUSE/STEP** for more than five seconds to be able to select a system in the [Home Menu].

Note

If the USB device is connected or a disc is inserted, this function is not operated.

Displaying file information (ID3 TAG)

While playing an MP3 file containing file information, you can display the information by pressing  **INFO/DISPLAY**.

Turn off the sound temporarily

Press  **MUTE** to mute your sound.

You can mute the sound in order, for example, to answer the telephone. And "MUTE" will appear in the display window. To cancel mute function, press  **MUTE** again or adjust volume level by pressing **VOL (+/-)**.

Adjust the speaker level settings

You can adjust the sound level of each speaker.

1. Press **SPEAKER LEVEL** repeatedly to select a desired speaker to set.
2. Press **VOL -/+** to adjust the sound level of the selected speaker while the level setting menu is displayed on the display window.
3. Repeat and adjust the sound level of the other speakers.

Setting the Clock

1. Turn the unit on.
2. Press **CLOCK**.
3. Choose time mode by pressing **◀◀/▶▶** **SKIP**.
 - AM 12:00 (for an AM and PM display) or 0:00 (for a 24 hour display)
4. Press **⊙ ENTER** to confirm your selection.
5. Select the hours by pressing **◀◀/▶▶** **SKIP**.
6. Press **⊙ ENTER**.
7. Select the minutes by pressing **◀◀/▶▶** **SKIP**.
8. Press **⊙ ENTER**.
9. If you want to reset the clock, press and hold **CLOCK**.

! Note

- If you unplug the cord from an outlet, the clock setting you set won't be stored.
- If you set the clock, you can check the time by pressing **CLOCK** although the player is turned off.
- If you set the clock and alarm, you can check setting information by pressing **TIMER** although the unit is turned off. Then this function will work in everyday.
- Alarm function only works when the unit is turned off.

4

Operating

Using your player as an alarm clock

1. Turn the unit on.
2. Press **TIMER** to set the alarm function.
3. Alarm sound sources will blink. While each of sound sources blink, select the one you want by pressing **⊙ ENTER**.
4. "ON TIME" will blink. This is your desired time to turns unit on. Press **◀◀/▶▶** **SKIP** to change the hours and minutes and press **⊙ ENTER** to save.
5. The "OFF TIME" will blink. This is your desired time to turn unit off. Press **◀◀/▶▶** **SKIP** to change the hours and minutes and press **⊙ ENTER** to save.
6. The volume setting will blink. Press **◀◀/▶▶** **SKIP** to change the volume and press **⊙ ENTER** to save.
7. After complete setting, you can check the setting status.
8. You can adjust to turn alarm on or off by pressing **TIMER**.
 - Timer ON : Alarm function is turned on and you can check alarm setting status.
 - Timer OFF : Alarm function is turned off.
9. If you want to reset the alarm, press and hold **TIMER**.

Sleep Timer Setting

Press **SLEEP** on the remote control repeatedly to select delay time between 10 and 180 minutes. After delay time, the unit will turn off. (You can see the following order, 180 -> 150 -> 120 -> 90 -> 80 -> 70 -> 60 -> 50 -> 40 -> 30 -> 20 -> 10)

To cancel the sleep function, press **SLEEP** repeatedly until the display window get bright.

! Note

- You can check the remaining time before the unit turns off. Press **SLEEP**. The remaining time appears in the display window.
- Sleep function will work after dimmer function.

Dimmer

Press **SLEEP** once. The display window will be darkened by half. To cancel it, press **SLEEP** repeatedly until the display window get bright.

Radio Operations

Be sure that FM aerial is connected. (Refer to the page 19.)

Listening to the radio

1. Press **FUNCTION** until FM appears in the display window.
The last received station is tuned in.
2. Auto tuning : Press and hold **TUNING (-/+)** for about 2 seconds until the frequency indication starts changing, then release. Scanning stops when the unit tunes in a station.
Manual tuning: Press **TUNING (-/+)** repeatedly.
3. Adjust the volume by pressing **VOL (+/-)**.

Presetting the Radio Stations

You can preset 50 stations for FM .

Before tuning, make sure to turn down the volume.

1. Press **FUNCTION** until FM appears in the display window.
2. Select the desired frequency by pressing **TUNING (-/+)**.
3. Press **ENTER**. A preset number will blink in the display window.
4. Press **PRESET(+/-)** to select the preset number you want.
5. Press **ENTER**. The station is stored.
6. Repeat steps 2 to 5 to store other stations.
7. To listen a preset station, press **PRESET(+/-)**.

Deleting all the saved stations

1. Press and hold **CLEAR** for two seconds. "ERASEALL" will blink on the display window.
2. Press **CLEAR** to erase all saved radio stations.

Improving poor FM reception

Press **PLAY, MONO/STEREO**. This will change the tuner from stereo to mono. Then the reception will be better than before.

Sound adjustment

Setting the sound mode

This system has a number of pre-set surround sound fields. You can select a desired sound mode by using **SOUND EFFECT**.

The displayed items for the Equalizer may be different depending on sound sources and effects.

| On Display | Description |
|--------------------------------|--------------------------------------------------------------------------------------------------------------------------------------------|
| NATURAL | You can enjoy comfortable and natural sound. |
| AUTO EQ | Sets the sound equalizer on the mode that is the most similar to the genre which is included in the MP3 ID3 tag of song files. |
| POP CLASSIC JAZZ ROCK | This program lends an enthusiastic atmosphere to the sound, giving you the feeling you are at an actual rock pop, jazz or classic concert. |
| MP3 -- OPT | This function is optimized for compressible MP3 file. It improves the treble sound. |
| BASS (BASS BLAST) | Reinforces the treble, bass and surround sound effect. |
| LOUDNESS | Improves the bass and treble sound. |
| BYPASS | You can enjoy the sound without equalizer effect. |

Note

Maybe you need to reset the sound mode, after switching the input, sometimes even after the sound track/file is changed.

Troubleshooting

| PROBLEM | CORRECTION |
|--------------------------------------------------|----------------------------------------------------------------------------------------------------------|
| No power | Plug the power cord into the wall outlet securely. |
| No picture | Select the appropriate video input mode on the TV so the picture from the unit appears on the TV screen. |
| | Connect the video cables securely to both the TV and unit. |
| There is little or no sound | Select the correct input mode of the unit so you can hear the sound from the unit. |
| A DVD/CD will not play | Insert a disc. |
| | Insert a playable disc (check the disc type, color system and regional code). |
| | Enter your password or change the rating level. |
| Humming noise heard while a DVD or CD is playing | Clean the disc by using a soft cloth with outward strokes. |
| Radio stations can't be tuned in properly | Check the antenna connection and adjust its position. |
| | Attach an external aerial if necessary. |
| | Tune to the station manually. |
| | Preset some radio stations, see page 33 for details. |
| The remote control doesn't work well / at all | Point the remote control exactly at the unit. |
| | The remote is too far from the unit. Use the remote within 23 feet (7m) of the unit. |
| | Remove the obstacle between the remote control and the unit. |
| | The battery in the remote control is flat. Replace the battery with new one. |
| iPod/iPhone/iPad does not work. | Connect the player to the unit correctly. |

Area Code List

Choose an area code from this list.

| Area | Code | Area | Code | Area | Code | Area | Code |
|----------------|------|---------------|------|--------------------|------|-----------------|------|
| Afghanistan | AF | Fiji | FJ | Monaco | MC | Singapore | SG |
| Argentina | AR | Finland | FI | Mongolia | MN | Slovak Republic | SK |
| Australia | AU | France | FR | Morocco | MA | Slovenia | SI |
| Austria | AT | Germany | DE | Nepal | NP | South Africa | ZA |
| Belgium | BE | Great Britain | GB | Netherlands | NL | South Korea | KR |
| Bhutan | BT | Greece | GR | Antilles | AN | Spain | ES |
| Bolivia | BO | Greenland | GL | New Zealand | NZ | Sri Lanka | LK |
| Brazil | BR | Hong Kong | HK | Nigeria | NG | Sweden | SE |
| Cambodia | KH | Hungary | HU | Norway | NO | Switzerland | CH |
| Canada | CA | India | IN | Oman | OM | Taiwan | TW |
| Chile | CL | Indonesia | ID | Pakistan | PK | Thailand | TH |
| China | CN | Israel | IL | Panama | PA | Turkey | TR |
| Colombia | CO | Italy | IT | Paraguay | PY | Uganda | UG |
| Congo | CG | Jamaica | JM | Philippines | PH | Ukraine | UA |
| Costa Rica | CR | Japan | JP | Poland | PL | United States | US |
| Croatia | HR | Kenya | KE | Portugal | PT | Uruguay | UY |
| Czech Republic | CZ | Kuwait | KW | Romania | RO | Uzbekistan | UZ |
| Denmark | DK | Libya | LY | Russian Federation | RU | Vietnam | VN |
| Ecuador | EC | Luxembourg | LU | Saudi Arabia | SA | Zimbabwe | ZW |
| Egypt | EG | Malaysia | MY | Senegal | SN | | |
| El Salvador | SV | Maldives | MV | | | | |
| Ethiopia | ET | Mexico | MX | | | | |

Language code List

Use this list to input your desired language for the following initial settings: [Disc Audio], [Disc Subtitle] and [Disc Menu].

| Language | Code | Language | Code | Language | Code | Language | Code |
|-----------------|------|------------------|------|----------------|------|------------|------|
| Afar | 6565 | French | 7082 | Lithuanian | 7684 | Sindhi | 8368 |
| Afrikaans | 6570 | Frisian | 7089 | Macedonian | 7775 | Singhalese | 8373 |
| Albanian | 8381 | Galician | 7176 | Malagasy | 7771 | Slovak | 8375 |
| Ameharic | 6577 | Georgian | 7565 | Malay | 7783 | Slovenian | 8376 |
| Arabic | 6582 | German | 6869 | Malayalam | 7776 | Spanish | 6983 |
| Armenian | 7289 | Greek | 6976 | Maori | 7773 | Sudanese | 8385 |
| Assamese | 6583 | Greenlandic | 7576 | Marathi | 7782 | Swahili | 8387 |
| Aymara | 6588 | Guarani | 7178 | Moldavian | 7779 | Swedish | 8386 |
| Azerbaijani | 6590 | Gujarati | 7185 | Mongolian | 7778 | Tagalog | 8476 |
| Bashkir | 6665 | Hausa | 7265 | Nauru | 7865 | Language | Code |
| Basque | 6985 | Hebrew | 7387 | Nepali | 7869 | Tajik | 8471 |
| Bengali; Bangla | 6678 | Hindi | 7273 | Norwegian | 7879 | Tamil | 8465 |
| Bhutani | 6890 | Hungarian | 7285 | Oriya | 7982 | Telugu | 8469 |
| Bihari | 6672 | Icelandic | 7383 | Panjabi | 8065 | Thai | 8472 |
| Breton | 6682 | Indonesian | 7378 | Pashto, Pushto | 8083 | Tonga | 8479 |
| Bulgarian | 6671 | Interlingua | 7365 | Persian | 7065 | Turkish | 8482 |
| Burmese | 7789 | Irish | 7165 | Polish | 8076 | Turkmen | 8475 |
| Byelorussian | 6669 | Italian | 7384 | Portuguese | 8084 | Twi | 8487 |
| Chinese | 9072 | Japanese | 7465 | Quechua | 8185 | Ukrainian | 8575 |
| Croatian | 7282 | Kannada | 7578 | Rhaeto-Romance | 8277 | Urdu | 8582 |
| Czech | 6783 | Kashmiri | 7583 | Rumanian | 8279 | Uzbek | 8590 |
| Danish | 6865 | Kazakh | 7575 | Russian | 8285 | Vietnamese | 8673 |
| Dutch | 7876 | Kirghiz | 7589 | Samoan | 8377 | Volapük | 8679 |
| English | 6978 | Korean | 7579 | Sanskrit | 8365 | Welsh | 6789 |
| Esperanto | 6979 | Kurdish | 7585 | Scots Gaelic | 7168 | Wolof | 8779 |
| Estonian | 6984 | Laothian | 7679 | Serbian | 8382 | Xhosa | 8872 |
| Faroese | 7079 | Latin | 7665 | Serbo-Croatian | 8372 | Yiddish | 7473 |
| Fiji | 7074 | Latvian, Lettish | 7686 | Shona | 8378 | Yoruba | 8979 |
| Finnish | 7073 | Lingala | 7678 | | | Zulu | 9085 |

Trademarks and Licenses



HDMI, the HDMI logo and High-Definition Multimedia Interface are trademarks or registered trademarks of HDMI licensing LLC.



"DVD Logo" is a trademark of DVD Format/Logo Licensing Corporation.



Manufactured under license from Dolby Laboratories. Dolby and the double-D symbol are trademarks of Dolby Laboratories.



DivX®, DivX Certified® and associated logos are trademarks of Rovi Corporation or its subsidiaries and are used under license.



"Made for iPod," "Made for iPhone," and "Made for iPad" mean that an electronic accessory has been designed to connect specifically to iPod, iPhone, or iPad, respectively, and has been certified by the developer to meet Apple performance standards. Apple is not responsible for the operation of this device or its compliance with safety and regulatory standards. Please note that the use of this accessory with iPod, iPhone, or iPad may affect wireless performance.

Copyrights



It is forbidden by law to copy, broadcast, show, broadcast via cable, play in public, or rent copyrighted material without permission. This product features the copy protection function developed by Macrovision. Copy protection signals are recorded on some discs. When recording and playing the pictures of these discs picture noise will appear. This product incorporates copyright protection technology that is protected by U.S. patents and other intellectual property rights. Use of this copyright protection technology must be authorized by Macrovision, and is intended for home and other limited viewing uses only unless otherwise authorized by Macrovision. Reverse engineering or disassembly is prohibited.

CONSUMERS SHOULD NOTE THAT NOT ALL HIGH DEFINITION TELEVISION SETS ARE FULLY COMPATIBLE WITH THIS PRODUCT AND MAY CAUSE ARTIFACTS TO BE DISPLAYED IN THE PICTURE. IN CASE OF 525 OR 625 PROGRESSIVE SCAN PICTURE PROBLEMS, IT IS RECOMMENDED THAT THE USER SWITCH THE CONNECTION TO THE 'STANDARD DEFINITION' OUTPUT. IF THERE ARE QUESTIONS REGARDING OUR TV SET COMPATIBILITY WITH THIS MODEL 525p AND 625p UNIT, PLEASE CONTACT OUR CUSTOMER SERVICE CENTER.

Specifications

| General | |
|-------------------------|-------------------------------------|
| AC adapter requirements | DC 18 V, AC 200 - 240 V, 50 / 60 Hz |
| Power consumption | 30 W |
| Dimensions (W x H x D) | (470 x 210 x 116) mm |
| Net Weight (Approx.) | 3.2 kg |
| Operating temperature | 5 °C to 35 °C (41 °F to 95 °F) |
| Operating humidity | 5 % to 90 % |

| Inputs/ Outputs | |
|-------------------------|------------------------------------------------|
| VIDEO OUT | 1.0 V (p-p), 75 Ω, sync negative, RCA jack x 1 |
| HDMI OUT (video/audio): | 19 pin Type A, HDMI™ Connector |
| PORT. IN | 1.0 Vrms (3.5 mm stereo jack) |

| System | |
|-----------------------|---------------------------------------------------------------------------------------------------------------------------------------------------------------------------------------------------------------------------|
| Laser | Semiconductor laser, wavelength: 650 nm |
| Signal system | Standard NTSC/ PAL color TV system |
| Frequency response | 20 Hz to 20 kHz (48 kHz, 96 kHz, 192 kHz sampling) |
| Signal-to-noise ratio | More than 80 dB |
| Harmonic distortion | 0.05 % at 1 W |
| Dynamic range | More than 85 dB |
| Bus Power Supply | USB DC 5 V  500 mA iPod/iPhone/iPad DC 5 V  2.1 A |

| Amplifier | |
|-------------|---------------------------|
| Stereo mode | 20 W + 20 W (8Ω at 1 kHz) |
| T.H.D | 10% |

| CD | |
|-----------------------|-----------------|
| Frequency Response | 40 to 20 000 Hz |
| Signal-to-noise ratio | 75 dB |
| Dynamic range | 80 dB |

| Tuner | |
|-----------------|--------------------------------------------------|
| FM Tuning Range | 87.5 MHz to 108.0 MHz or 87.50 MHz to 108.00 MHz |

40 Appendix

| Speakers | |
|-------------------|------------|
| Type | built-in |
| Impedance Rated | 8 Ω |
| Rated Input Power | 10 W |
| Max. Input Power | 20 W |

- Design and specifications are subject to change without notice.

Maintenance

Handling the Unit

When shipping the unit

Please save the original shipping carton and packing materials. If you need to ship the unit, for maximum protection, re-pack the unit as it was originally packed at the factory.

Keeping the exterior surfaces clean

- Do not use volatile liquids such as insecticide spray near the unit.
- Wiping with strong pressure may damage the surface.
- Do not leave rubber or plastic products in contact with the unit for a long period of time.

Cleaning the unit

To clean the player, use a soft, dry cloth. If the surfaces are extremely dirty, use a soft cloth lightly moistened with a mild detergent solution. Do not use strong solvents such as alcohol, benzene, or thinner, as these might damage the surface of the unit.

Maintaining the Unit

The unit is a high-tech, precision device. If the optical pick-up lens and disc drive parts are dirty or worn, the picture quality could be diminished. For details, please contact your nearest authorized service center.

Notes on Discs

Handling Discs

Do not touch the playback side of the disc. Hold the disc by the edges so that fingerprints do not get on the surface. Never stick paper or tape on the disc.

Storing Discs

After playing, store the disc in its case. Do not expose the disc to direct sunlight or sources of heat and never leave it in a parked car exposed to direct sunlight.

Cleaning Discs

Fingerprints and dust on the disc can cause poor picture quality and sound distortion. Before playing, clean the disc with a clean cloth. Wipe the disc from the center to out.

Do not use strong solvents such as alcohol, benzene, thinner, commercially available cleaners, or anti-static spray intended for older vinyl records.



| | Телефон | Режим работы | Интернет |
|------------|-----------------------------------|-----------------------------------------------------|---------------------------------------------------|
| Россия | 8-800-200-7676 | Круглосуточно | http://www.lg.com |
| Беларусь | 8-820-0071-1111 | | |
| Латвия | 8-0003-271 | | |
| Литва | 8-800-30-800 | | |
| Эстония | 800-9990 | | |
| Украина | 0-800-303-000 | 8:00 - 21:00 (Пн.-Пят.) 9:00 - 18:00 (Суб., Вс.) | |
| Казахстан | 8-8000-805-805 | 9:00 - 18:00 (Пн.-Пят.) 9:00 - 18:00 (Суб.) | |
| | 2255 (для мобильных телефонов) | | |
| Кыргызстан | 8-0000-710-005 | Круглосуточно | |
| Узбекистан | | | |

Российская Федерация

Импортер LG Electronics RUS

Адрес импортера 143160 Российская Федерация, Московская область, Рузский район, сельское поселение Дороховское, 86 км. Минского шоссе, д.9

Адрес производителя : ЛГ Электроникс инк. Китай, г. Хучжоу, Индустриальный парк, Зона развития Зонг Каи, ул. Хью Фенг Донг, 13

Сделано в Китае

Қазақстан Республикасы

"All the claims (or proposals) related to the quality of products, as well as repairs and technical services should be addressed to "LG Electronics Almaty Kazakhstan", 050061, Kazakhstan, Almaty, Molodezhnaya Street 2A. Information about the other service centers can be provided by customer support service.

«Претензии (предложения) по качеству товара, ремонт и техническое обслуживание товара принимает: АО «Эл Джи Электроникс Алматы Казахстан», 050061, Республика Казахстан, г. Алматы, ул. Молодежная, 2А. Информацию о других сервисных центрах можно получить в службе поддержки клиентов».

Қазақстан Республикасы территориясында тұтынушылардан келіп түскен талаптар мен ұсыныстарды қарайтын және тауарды жөндеу мен техникалық қызмет көрсететін ұжым: АҚ «Эл Джи Электроникс Алматы Казахстан», 050061, Қазақстан Республикасы, Алматы қ., Молодежная, 2А. Басқа сервис орталықтары жайында мағлұматты "Тұтынушыға қызмет көрсету орталығына" телефон шалу арқылы білуге болады



Қытайда жасалған