



ENGLISH

РУССКИЙ

УКРАЇНСЬКА

КАЗАК

# OWNER'S MANUAL REFRIGERATOR

Please read this owner's manual thoroughly before operating and keep it handy for reference at all times.

# Electrical Connections (In the UK Only)

## Important

The wires in this mains lead are coloured in accordance with the following code:

GREEN AND YELLOW: EARTH  
BLUE: NEUTRAL  
BROWN: LIVE

This appliance must be earthed

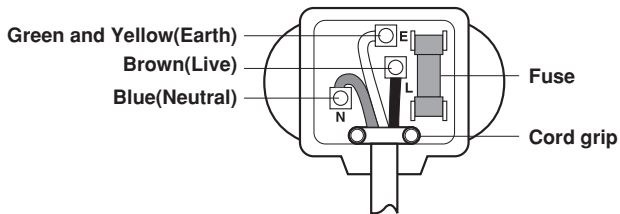

As the colours of the wires in the mains lead of this apparatus may not correspond with the coloured markings identifying the terminals in your plug, proceed as follows:

The wire which is coloured Green and Yellow must be connected to the terminal in the plug which is marked with the letter E or by the earth symbol ( $\perp$ ) or coloured Green or Green and Yellow.

The wire which is coloured Blue must be connected to the terminal which is marked with the letter N or coloured Black.

The wire which is coloured Brown must be connected to the terminal which is marked with the letter L or coloured Red.

If a 13 amp (BS 1363) plug is used, fit a 13 amp BS 1362 fuse.

## Registration

The model and serial number are found on the rear of this unit. This number is unique to this unit and not available to others. You should record requested information here and retain this guide as a permanent record of your purchase. Staple your receipt here.

Date of Purchase : \_\_\_\_\_

Dealer Purchased From : \_\_\_\_\_

Dealer Address : \_\_\_\_\_

Dealer Phone No. : \_\_\_\_\_

Model No. : \_\_\_\_\_

Serial No. : \_\_\_\_\_

# Table of Contents

<b>Introduction</b>	<b>Important Safety Instruction</b> ..... 4
	<b>Identification of Parts</b> ..... 10
<b>Installation</b>	<b>Installation</b> ..... 12
	<b>Starting</b> ..... 12
	<b>Climate class</b> ..... 12
<b>Operation</b>	<b>Temperature Control</b> ..... 13
	<b>Express Cool</b> ..... 14
	<b>Eco Friendly</b> ..... 14
	<b>Self Test</b> ..... 14
	<b>Lock</b> ..... 15
	<b>Power On/Off</b> ..... 15
	<b>Door Alarm</b> ..... 15
	<b>Vegetable Drawer</b> ..... 15
	<b>Removable Glass Shelf</b> ..... 16
	<b>Decondensation</b> ..... 16
<b>Water Dispenser</b> ..... 16	
<b>Suggestion On Food storage Care and Maintenance</b>	<b>Storing Food</b> ..... 17
	<b>General Information</b> ..... 18
	<b>Cleaning</b> ..... 18
<b>Trouble Shooting</b>	<b>Trouble Shooting</b> ..... 19
	<b>Product information</b> ..... 21

## Important Safety Instruction

### BASIC SAFETY PRECAUTIONS

This guide contains many important safety messages.

Always read and obey all safety messages.

This is the safety alert symbol. It alerts you to safety messages that inform you of hazards that can kill or hurt you or others or cause damage to the product. All safety messages will be preceded by the safety alert symbol and the hazard signal word DANGER, WARNING, or CAUTION. These words mean:

**⚠ DANGER** You will be killed or seriously injured if you don't follow instructions.

**⚠ WARNING** You can be killed or seriously injured if you don't follow instructions.

**⚠ CAUTION** Indicates an imminently hazardous situation which, if not avoided, may result in minor or moderate injury, or product damage only.

All safety messages will identify the hazard, tell you how to reduce the chance of injury, and tell you what can happen if the instructions are not followed.

### ⚠ WARNING

To reduce the risk of fire, electric shock, or injury to persons when using your product, basic safety precautions should be followed, including the following. Read all instructions before using this appliance.

#### 1. When connecting the power

**A dedicated outlet should be used.**

- Using several devices at one outlet may cause fire.
- The electric leakage breaker may damage food and the dispenser may be leaked.



**Do not allow the power plug to face upward or to be squeezed at the back of the fridge/freezer.**

Water may be flown into or the plug may be damaged, which causes fire or electric shock.

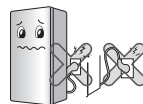

**Prevent the power cord from being squeezed or imprinted if the refrigerator is pushed in after the power plug is extracted during the installation.**

It becomes the cause of fire or electric shock.

When moving your appliance away from the wall, be careful not to roll over or damage the power cord.

**Do not allow the power cord bent or pressed by the heavy object to be damaged.**

It may damage the power cord to cause fire or electric shock.



**Do not extend or modify the length of the power plug.**

It causes electric shock or fire by the electric damage of the power cord or others.



**Unplug the power plug when cleaning, handling or replacing the interior lamp of the fridge/freezer.**

- It may cause electric shock or injury.
- When replacing the interior lamp of the fridge/freezer, make sure that the rubber ring for preventing the electric spark within the socket is not taken off.



## Important Safety Instruction

**Do not pull out the cord or touch the power plug with wet hands.**

It may cause electric shock or injury.



**Remove water or dust from the power plug and insert it with the ends of the pins securely connected.**

Dust, water or unstable connection may fire or electric shock.



**Pull out the power plug not by grasping the cord but the plug of its end.**

It may cause electric shock or short circuit to fire.



**Make sure of grounding.**

**Consult a qualified electrician or service person if the grounding instructions are not completely understood, or if you have doubts on whether the appliance is properly grounded or not.**

The incorrect grounding may cause breakdown and electric shock.

**Be sure to use grounded exclusive proper voltage consent for the power plug.**

It becomes the cause of fire.

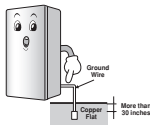

**When the power cord or the power plug is damaged or the holes of the outlet are loosed, do not use them.**

It may cause electric shock or short circuit to make fire.



**Wait for 5 minutes or longer when reconnecting the plug.**

It may cause the operation of the refrigerator to fail.



## 2. When using the fridge/freezer

**Do not place the heavy object or the dangerous object (container with liquid) on the fridge/freezer.**

It may be dropped to cause injury, fire or electric shock when opening or closing the door.



**Do not cling to the door or the shelves of the door or the cool chamber.**

It may make the fridge/freezer fallen down or damage the hands. Especially, do not allow the children to do the above.



**Prevent children from entering the product.**

It may endanger the life of a child if the child enters the refrigerator.



**Opening and closing the door of the refrigerator vigorously may cause the stored food in the refrigerator basket to fall by shock and hurt the foot, so take precautions.**

**Do not install the fridge/freezer in the wet place or the place which water or rain splashes.**

Deterioration of insulation of electric parts may cause electric leakage.



## Important Safety Instruction

**Do not use or store inflammable materials ether, benzene, alcohol, medicine, LP gas, spray or cosmetics near or in the fridge/freezer.**  
It may cause explosion or fire.

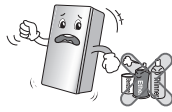

**Do not place the lit candle within the fridge/freezer to deodorize. Do not use drier to dry the inside, nor light a candle to remove odor.**  
It may cause explosion or fire.



**Do not store the medicine or the academic materials at the fridge/freezer.**

When the material with the strict temperature control is stored, it may be deteriorated or it may make an unexpected reaction to cause any risk.



**Do not use any combustible spray near the fridge/freezer.**  
It may become the cause of an explosion or fire.

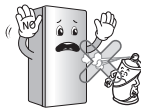

**Avoid the heating devices. Install in places away from the fire such as the place where flammable gas is leaked.**

It may cause fire.



**Do not place flower vase, cup, cosmetics, medicine or any container with water on the fridge/freezer.**

It may cause fire, electric shock or injury by dropping down.



**In case of thunder and lightning, or not in use for a long period of time, detach the power plug.**

There is a danger of electric shock or fire.



**Use the submerged fridge/freezer after checking it.**  
It may cause electric shock or fire.

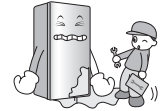

**When gas is leaked, do not touch the fridge/freezer or the outlet and ventilate the room immediately.**

- The explosion by spark may cause fire or burn.
- Because this fridge/freezer uses natural gas (isobutene, R600a) as the environment-friendly refrigerant, even a small amount (80~90g) is combustible. When the gas is leaked by the severe damage during delivering, installing or using the fridge/freezer, any spark may cause fire or burn.

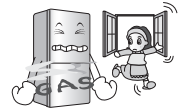

**Do not spray water at the outside or the inside of the fridge/freezer or do not clean it with benzene or thinner.**

Deterioration of insulation of electric parts may cause electric shock or fire.



**When any strange smell or smoke is detected from the fridge/freezer, disconnect the power plug immediately and contact to the service center.**

It may cause fire.



## Important Safety Instruction

**Do not allow any person except a qualified engineer to disassemble, repair or alter the fridge/freezer.**

It may cause injury, electric shock or fire.

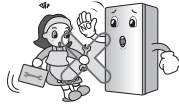

**Do not use the fridge/freezer for non-domestic purpose (storing medicine or testing material, using at the ship, etc.).**

It may cause an unexpected risk such as fire, electric shock, deterioration of stored material or chemical reaction.



**When disposing the fridge/freezer, remove the packing materials from the door.**

It may cause to lock out the child.



**This appliance is not intended for use by persons (including children) with reduced physical, sensory or mental capabilities, or lack of experience and knowledge, unless they have been given supervision or instruction concerning use of the appliance by a person responsible for their safety.**

**Children should be supervised to ensure that they do not play with the appliance.**

**Install the fridge/freezer on the solid and level floor.**

Installing it on the unstable place may cause death by falling down the fridge/freezer when opening or closing the door.



**Do not insert the hands or the metal stick into the exit of cool air, the cover, the bottom of the fridge/freezer, the heatproof grill (exhaust hole) at the backside.**

It may cause electric shock or injury.

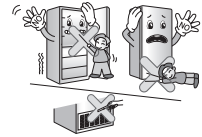

### ⚠ CAUTION

Violating this direction may cause injury or damage to house or contents. Always be careful, please.

**Do not touch food or containers in the freezer with wet hands.**

It may cause frostbite.



**Do not place the food in disorder inside the refrigerator.**

The food may fall during opening and closing the door of the refrigerator and hurt people.

**Do not put filled bottles in the freezer.**

It may freeze the contents to break the bottle to cause injury.



**Do not insert hands into the bottom of the fridge/freezer.**

The iron plate at the bottom may cause injury.



### Important Safety Instruction

Carry the fridge/freezer with the handle bar at the bottom of the front and the top of the rear.

Otherwise, your hands may be slipped to cause injury. Because the product is heavy, carrying it alone may hurt people or accidents may occur.

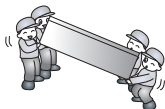

Because opening or closing the door of the fridge/freezer may cause injury to the person around it, be careful, please.

Opening or closing the door may cause feet or hands to be caught in the chink in door or the child to be get hurt by the corner.



Do not put any living animal in the fridge/freezer.



### Precaution

#### ▲ WARNING

- This fridge/freezer must be properly installed and located in accordance with the Installation Instruction before it is used.
- Never unplug your fridge/freezer by pulling on the power cord. Always grip plug firmly and pull straight out from the outlet.
- After your fridge/freezer is in operation, do not touch the cold surfaces in the freezer compartment, particularly when hands are damp or wet. Skin may adhere to these extremely cold surfaces.

### Accessibility of Supply Plug

The supply plug of the refrigerator-freezer should be placed in easy accessible position for quick disconnection in emergency.

### Supply Cord Replacement

If the supply cord is damaged, it must be replaced by the manufacturer or its service agent or a similarly qualified person in order to avoid a hazard.

### Danger

Risk of child entrapment.

Before you throw away your old refrigerator or freezer, take off the doors.

Leave the shelves in place so that children may not easily climb inside.

### Don't store

Don't store or use gasoline or other flammable vapors and liquids in the vicinity of this or any other appliance.

### Grounding (Earthing)

In the event of an electric short circuit, grounding (earthing) reduces the risk of electric shock by providing an escape wire for the electric current. In order to prevent possible electric shock, this appliance must be grounded. Improper use of the grounding plug can result in an electric shock.



## Important Safety Instruction

### ▲ WARNING

- ▲ Keep ventilation openings, in the appliance enclosure or in the built-in structure, clear of obstruction.
- ▲ Do not use mechanical devices or other means to accelerate the defrosting process, other than those recommended by the manufacturer.
- ▲ Do not damage the refrigerant circuit.
- ▲ Do not use electrical appliances inside the food storage compartments of the appliance, unless they are of the type recommended by the manufacturer.
- ▲ The refrigerant and insulation blowing gas used in the appliance require special disposal procedures. When disposal, please consult with service agent or a similarly qualified person.



This appliance contains a small amount of isobutane refrigerant (R600a), natural gas with high environmental compatibility, but it is also combustible. When transporting and installing the appliance, care should be taken to ensure that no parts of the refrigerating circuit are damaged. Refrigerant squirting out of the pipes could ignite or cause an eye injury. If a leak is detected, avoid any naked flames or potential sources of ignition and air the room in which the appliance is standing for several minutes.

In order to avoid the creation of a flammable gas air mixture if a leak in the refrigerating circuit occurs, the size of the room in which the appliance may be sited depends on the amount of refrigerant used. The room must be 1 m<sup>2</sup> in size for every 8 g of R600a refrigerant inside the appliance. The amount of refrigerant in your particular appliance is shown on the identification plate inside the appliance. Never start up an appliance showing any signs of damage. If in doubt, consult your dealer.

### ▲ CAUTION

- If the wall socket is loose, do not insert the power plug.  
It may cause electric shock or fire.
- Never unplug your refrigerator by pulling on the power cord. Always grip plug firmly and pull it straight out from the outlet.  
You may disconnect a wire and cause a short circuit.
- Do not use a wet or damp cloth when cleaning the plug. Remove any foreign matter from the power plug pins.  
Otherwise, there is a risk of fire.
- After unplugging the appliance, wait for at least five minutes before plugging it again to the wall socket.  
Abnormal operation of the freezer may cause material damage.
- If the appliance is not to be used for a long time, pull out the power plug.  
Any deterioration in the insulation may cause fire.
- Do not let children touch or play with the control panel on the front of the appliance.
- The refrigerant used in fridge/freezer and the gases in the insulation material require special disposal procedures. Ensure that none of the pipes on the back of the appliances are damaged prior to disposal.

### ▲ WARNING

Please do not use a dishwasher to clean the lower drawers; the high temperature may cause damage to the baskets which make them unusable.

## Identification of Parts

Model Name : GW-F401\*\*\*\*

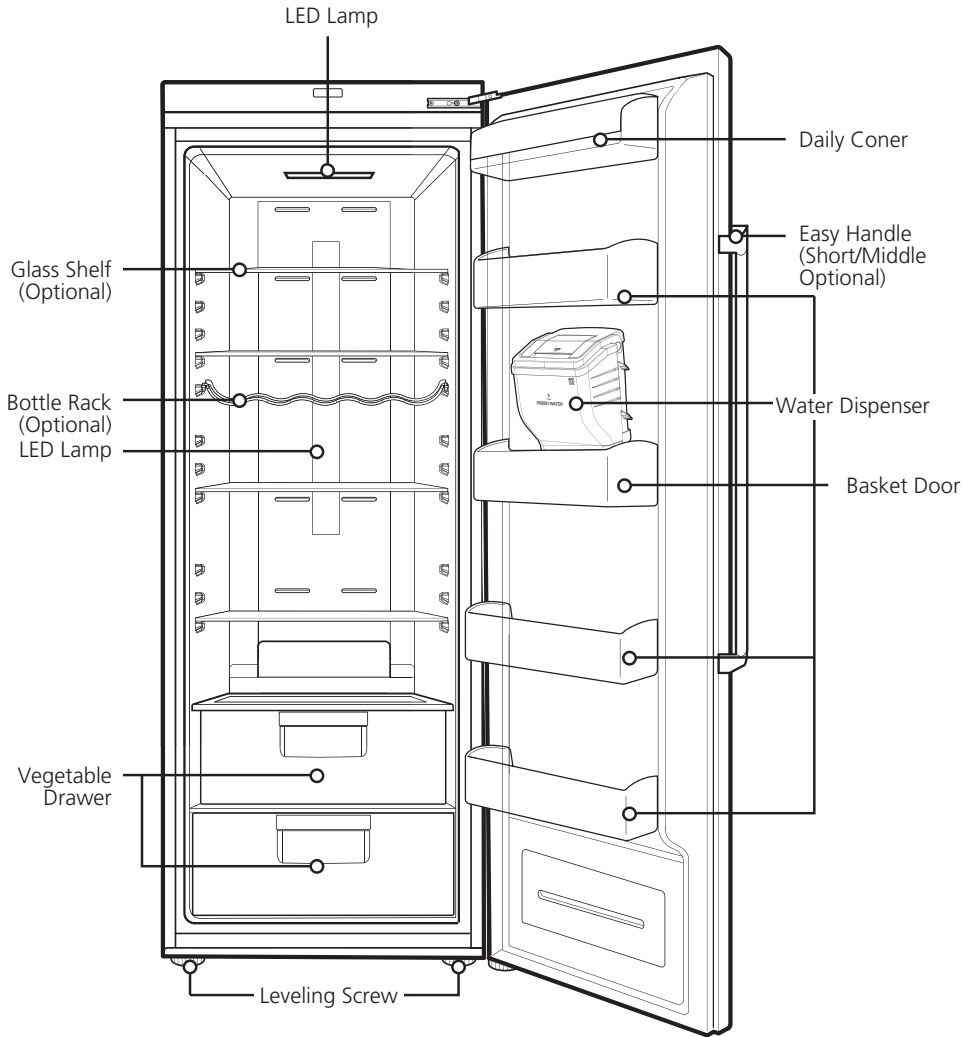

### Note

- If you find some parts missing from your unit, they may be parts only used in other models.
- It may a different the door opened appearance depending on the model.

Model Name : GW-B401\*\*\*\*

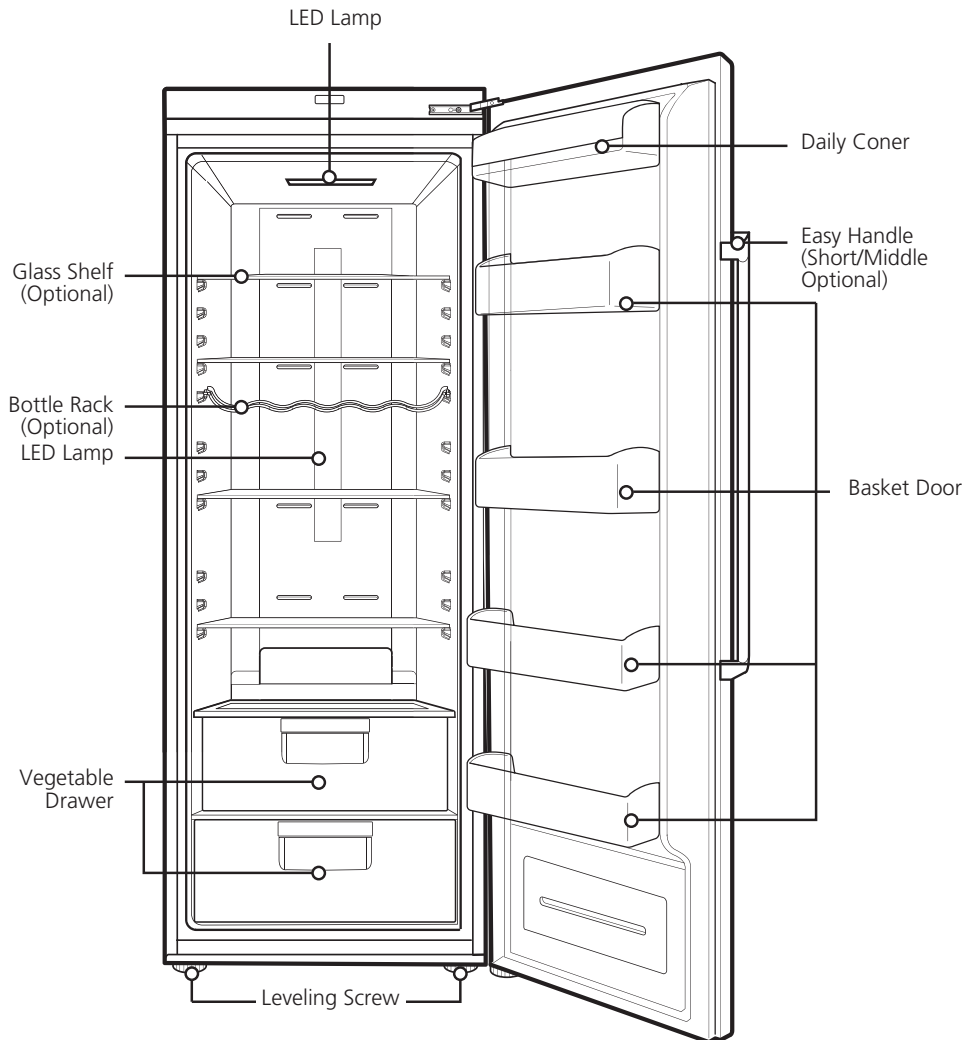

#### Note

- If you find some parts missing from your unit, they may be parts only used in other models.
- It may be different the door opened appearance depending on the model.

## Installation

1. Select a good location.  
Place your fridge where it is easy to use.
2. Avoid placing the unit near heat sources, direct sunlight or moisture.
3. To avoid vibration, the unit must be leveled.  
If required, adjust the leveling screws to compensate for the uneven floor.  
The front should be slightly higher than the rear to aid in door closing.  
Leveling screws can be turned easily by tipping the cabinet slightly.  
Turn the leveling screws counterclockwise (↺) to raise the unit, clockwise (↻) to lower it.
4. Clean your fridge thoroughly and wipe off all dust accumulated during shipping.
5. Connect the power supply cord (or plug) to the outlet. Don't double up with other appliances on the same outlet.

6. Product with handle shall be located at least 55 mm from the wall on the hinge side to open door by 90°

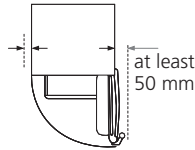

7. The warm air under bottom and rear side of the product have to release. Otherwise, This will increase the power consumption.

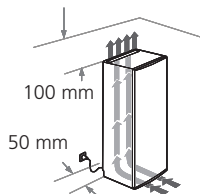

## Starting

When your fridge is installed, allow it 2-3 hours to stabilize at normal operating temperature prior to filling it with fresh foods.

If power plug is disconnected, allow 5 minutes delay before restarting.

Your fridge is now ready for use.

## Climate class

The appliance is designed to operate at the limited range of ambient temperature, depending on climate zones. Do not use the appliance at the temperature out of the limit. Climate class of your appliance is indicated on the label with technical description inside the fridge compartment.

Class	Symbol	Ambient temperature range °C
Extended temperate	SN	+10 ~ +32
Temperate	N	+16 ~ +32
Subtropical	ST	+16 ~ +38
Tropical	T	+16 ~ +43
Extended temperate -Tropical	SN-T	+10 ~ +43

## Temperature Control

Your fridge has controls that let you regulate the temperature in the fridge compartments.

### Display Panel For Temperature Control

#### Adjusting the temperatures and functions

※ It may a different the printing depending on the model.

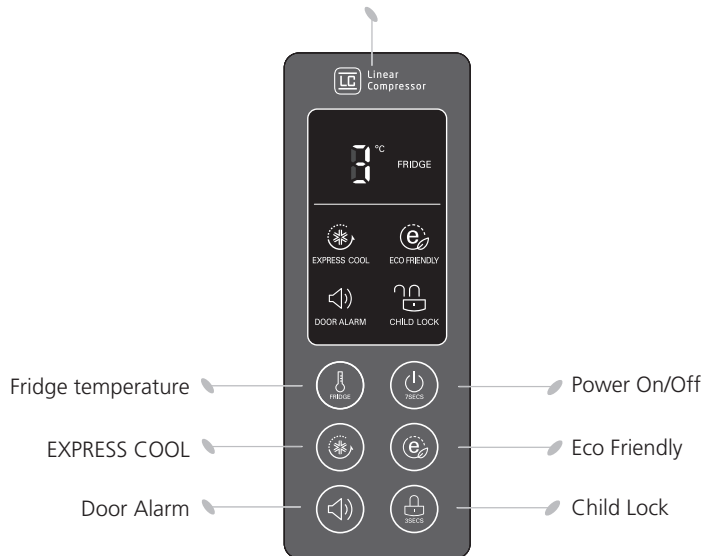

## EXPRESS COOL

< Exterior Type >



- Please select this function for prompt cooling.
- Press the Express Cool button once, and then the quick cooling operation starts with the lamp on.
- The Express Cool operation takes about 12 hours. When its operation ends, it automatically returns to the previous temperature setting. If you want to stop the quick cooling operation, press the Express Cool button once more, the lamp goes out, and the Express Cool operation stops and the refrigerator returns to the previous temperature setting.

## How to adjust the temperature in the Fridge compartment

< Exterior Type >



- The initial temperature of the Fridge Compartment is 3°C. You can now adjust the temperature of the Compartment as you want. By pressing the button, it is possible to change the temperature.

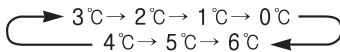

### Note

The actual inner temperature varies depending on the food status, as the indicated setting temperature is a target temperature, not actual temperature within Fridge. Refrigeration function is weak in the initial time. Please adjust temperature as above after using Fridge for minimum 2~3 days.

## Eco Friendly

< Exterior Type >



- This function makes the fridge work in a power saving mode which is useful for when you are away on holiday, by reducing energy consumption. Pressing 'ECO FRIENDLY' starts operation with lamp on and pressing it again stops the operation.

### Note

When the Eco Friendly mode is "ON", the other buttons will not operate. When you come back from Eco Friendly, press the Eco Friendly mode off so that other buttons work and the Fridge returns to previous temperature setting.

## Self Test

- This function automatically detects failure when failure is found in product during the use of Fridge.
- If the failure occurs at product and it does not operate by pressing any button and normal indication is not done, do not turn the power off and immediately contact with the local service center.
- A lot of time is needed for service engineer to detect the failed part by turning it off.

## Lock

< Exterior Type >

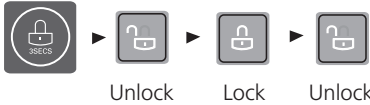

- Pressing this button stops operation of other buttons.
- "Locking" or "Un-Locking" is repeated whenever pressing the LOCK button. (For "Locking" press the "LOCK" button for 3 secs. For "Un-Locking" press the "LOCK" button for 3 secs.)
- When 'LOCK' is activated, pressing the other buttons would not work.

## Power On/Off

- This button turns the appliance on and off.
- Turning on and off is repeated whenever the ON/OFF button is pressed. (To turn the appliance off hold the ON/OFF button for 7 seconds. To turn the appliance on press the button shortly).



## Door Alarm

- When the door of the fridge is opened for a while, the alarm sounds. Please contact with the local service center if warning continue to sound even after closing the door.
- You can choice door alarm on/off pressing door alarm button shortly.



## Vegetable Drawer

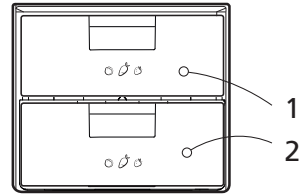

1. Moist Balance Crisper  
The structure of the lid ceiling keep fruits and Vegetables crisper and fresher longer.
2. Vegetable Drawer  
Store vegetables and fruits.

### How to separate the vegetable drawer

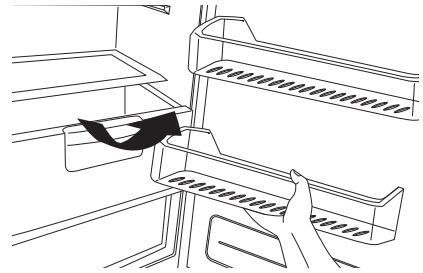

To separate the vegetable drawer first take out the bottom basket. To do it pull the drawer forward and the lift it up.

### How to Separate the Drawer, Cover

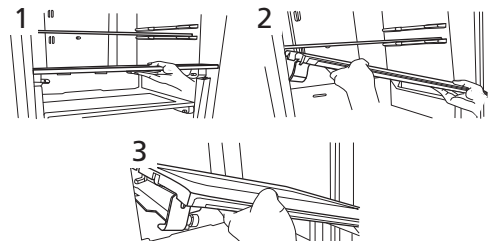

When separating the vegetable drawer, pull the vegetable drawer toward and then Lift the drawer.

1. Lift the front of the Drawer, Cover Slightly and pull the Cover, Assbly toward yourself.
2. Lean the Drawer, Cover slightly to one side.
3. Pull out the Drawer, Cover.

## Removable Glass Shelf

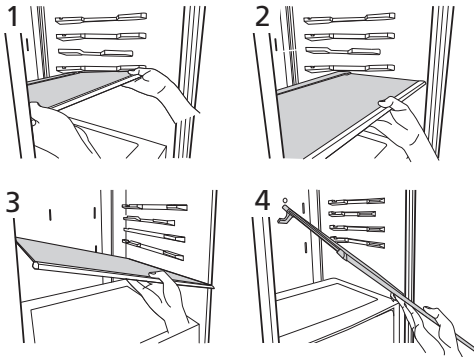

1. Lift the front of the removable glass shelf.
2. Pull the removable glass shelf toward door direction about 14 Cm.
3. Lean the glass shelf slightly to one side.
4. Separate the glass shelf to designated place.

## Decondensation

- Decondensation takes place automatically.
- The condensate water flows down to the evaporating tray and is evaporated automatically.

## Water Dispenser (Optional)

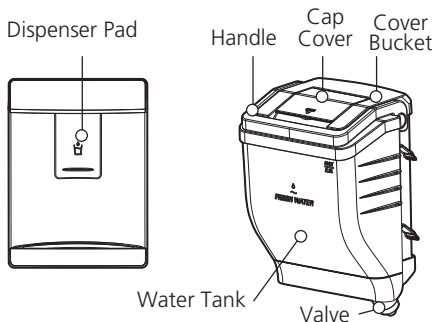

## Filling of WATER TANK

### How to Remove the Water Tank

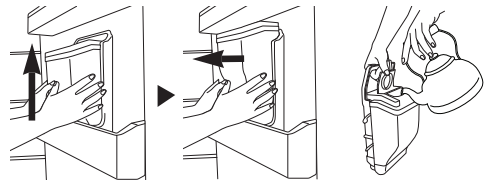

- The assembly is the reverse of removal.
- Be careful not to press on with valve.
- When you assemble water tank on the door, be careful to install certainly.

1. Pull out the water tank. Then open the cap cover.
2. Water can be filled up to 2.3 liter.
3. After filling potable water. Close the Cap Cover.

## Dispenser

1. Press the dispenser pad with a cup.
2. In The begining, push the pad(5 sec,3 times)
3. Remove the cup slowly from the pad to avoid dripping water from the nozzle.
4. If slowly removing a cup from the pad, water will not fall down.

### ⚠ CAUTION

- Do not use other beverage (milk, juice, carbonated beverage etc) than potable water. Especially beverage including grain must not be used (may result in failure).
- When you fill water tank with water, please let hot water cool before putting water tank in refrigerator.  
- Hot water cause malfunctioning.

### ⚠ WARNING

Fill with the potable water only.



## Storing Food

### ▲ CAUTION

- Do not store food which goes bad easily at low temperature, such as banana, and melon.
- Allow hot food to cool prior to storing. Placing hot food in the fridge could spoil other food, and lead to higher electric bills.
- When storing the food, use a container with a lid. This prevents moisture from evaporating, and helps food to keep its taste and nutrients.
- Do not block air vents with food. Smooth circulation of cold air keeps fridge temperature even.
- Do not open the door frequently. Opening the door lets warm air enter the fridge, and cause the temperature to rise.
- Never keep too many foods in door rack, as this may stop the door from fully closing.
- Do not refreeze food that has been thawed. This causes loss of taste and nutrition.
- Do not store pharmaceutical products, scientific materials or other temperature sensitive products in the refrigerator. Products that require strict temperature controls must not be stored in the refrigerator.
- If you want to quick cool new food, place it on the middle drawer of fridge compartment, and then press the Express Cooling button.

### Note

If you keep the fridge in a hot, and humid place, frequently open its door or place a lot of vegetables in it, dew may form in it, which has no effect on its performance. Remove the dew with a lint free cloth.

### Suggestion for energy saving

- Please do not keep the door open for a long time, close door in the shortest time.
- Too much food are not advised to be put in. Enough space should be kept for cool air circulating freely.
- Do not set the temperature of Fridge lower than needed. Do not put the food near the temperature sensor.
- Allow hot food to cool prior to storing. Placing hot food in the fridge could spoil other food, and lead to higher electric bills.
- Do not block air vents with food. Smooth circulation of cold air keeps Fridge temperature even.
- Do not open the door frequently. Opening the door lets warm air enter the Fridge, and cause temperature to rise.
- To keep a position of inner parts like as baskets, drawers, shelves and Fridge Supplied by manufacturer is the most efficient usage for energy saving.

### General Information

#### Power Failure

- 1~2 hour power failure does no harm to the foods stores. Try to avoid opening and closing the door too frequently.

#### If You Move

- Take out foods from the Fridge and firmly fix the loose items with tape.
- Turn the leveling screws until they stop before moving the Fridge. Otherwise the screw may scratch the floor or the Fridge cannot move.

#### To Reverse the Doors

- Your Fridge is designed with reversible doors, do that they may open from either the left of right hand side to suit your kitchen design.

#### To install refrigerators in pairs

- Your fridge can be installed with freezer in pairs.
- It can be installed by installation parts supplied like this.

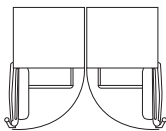

#### ▲ CAUTION

However When you want to reverse the doors or install your refrigerators in pairs, you must call to service agent. Revising the doors and installation condition is not covered by the warranty

### Cleaning

#### Before Cleaning

Be sure to unplug the power.

#### Exterior

Clean the outside of the Fridge with a soft cloth soaked with hot water or liquid detergent.

If you use a detergent, be sure to wipe it with a clean wet cloth.

#### Interior

Same as above.

#### After Cleaning

Check that the power cord is not damaged, power plug has not overheated, and that the power plug is tightly inserted into the outlet.

#### ▲ WARNING

Be sure to dry the appliance with a cloth after washing it with water.

Do not use abrasive, petroleum, benzene, thinner, hydrochloride acid, boiling water, rough brush, etc, as they may damage parts of the fridge/freezer.

#### Drip Tray

Wipe moisture out around the door part and the drip tray using a clean cloth.

#### Exterior Dispenser

Wipe moisture out of dispenser and on the dispenser pad using a cloth.

Before calling for service, check this list.

It may save you both time and expense.

This list includes common occurrences that are not the result of defective workmanship or materials in this appliance.

Problem	Possible Causes
<b>fridge/freezer does not operate</b>	<ul style="list-style-type: none"> <li>• Power plug may be unplugged from the electric outlet. Plug it in securely.</li> <li>• House fuse has blown or circuit breaker has tripped. Check and/or replace fuse and reset circuit breaker.</li> <li>• Power cut. Check house lights.</li> </ul>
<b>Fridge or Freezer Compartment Temperature too warm</b>	<ul style="list-style-type: none"> <li>• Temperature control not set on proper position. Refer to Temperature Control section.</li> <li>• Appliance is placed close to heat source.</li> <li>• Warm weather-frequent door openings.</li> <li>• Door left open for a long time.</li> <li>• Package holding door open or blocking air duct in freezer compartment.</li> </ul>
<b>Vibration or Rattling or Abnormal Noise</b>	<ul style="list-style-type: none"> <li>• The floor on which the fridge/freezer is installed may be uneven or the fridge/freezer may be unstable. Make it even by rotating the leveling screw.</li> <li>• Unnecessary objects placed in the back side of the fridge/freezer.</li> </ul>
<b>Frost or Ice Crystals on frozen Food</b>	<ul style="list-style-type: none"> <li>• Door may have been left ajar or package holding door open.</li> <li>• Too frequent or too long door openings.</li> <li>• Frost within package is normal.</li> </ul>
<b>Moisture forms on Cabinet Surface</b>	<ul style="list-style-type: none"> <li>• This phenomenon is likely to occur in a wet space. Wipe it with a dry towel.</li> </ul>
<b>Moisture collects inside</b>	<ul style="list-style-type: none"> <li>• Too frequent or too long door openings.</li> <li>• In humid weather, air carries moisture into fridge when doors are opened.</li> </ul>
<b>Fridge has odor</b>	<ul style="list-style-type: none"> <li>• Foods with strong odors should be tightly covered or wrapped.</li> <li>• Check for spoiled food.</li> <li>• Interior needs cleaning. Refer to CLEANING section.</li> </ul>

### Door not closing properly

- Food package is keeping door open.  
Move packages that keep door from closing.
- fridge/freezer is not level.  
Adjust the leveling screws.
- The floor on which the fridge/freezer is installed may be uneven or the fridge/freezer may be unstable.  
Slightly raise the front side with the leveling screw.

### Interior light does not work

- No power at outlet.
- When you want to replace the lamp, you must contact service agent.

#### Note

For more information about refrigerator service and use, you can find at the official site of LG at «Frequently Asked Questions» ([www.lg.com](http://www.lg.com)).



### DISPOSAL OF YOUR OLD APPLIANCE

1. When this crossed-out wheeled bin symbol is attached to a product it means the product is covered by the European Directive 2002/96/EC.
2. All electrical and electronic products should be disposed of separately from the municipal waste stream via designated collection facilities appointed by the government or the local authorities.
3. The correct disposal of your old appliance will help prevent potential negative consequences for the environment and human health.
4. For more detailed information about disposal of your old appliance, please contact your city office, waste disposal service or the shop where you purchased the product.

## Product information

<b>Model</b>			
<b>Producer Category</b>			
<b>Capacity (l)</b>	ISO Gross	Total Freezer Refrigerator	
	ISO Storage	Total Freezer Refrigerator	
<b>Weight (kg)</b>	Net / Packing Width x Height x Depth	Product Packing	
<b>Free standing / Built-in</b>		<b>Built-in</b>	<b>Built-in</b>
<b>Defrost system</b>		<b>Frost Free</b>	<b>Frost Free</b>
<b>Sound Power (dB)</b>			
<b>Energy Class</b>			
<b>Energy Consumption (kWh/year)</b>			
<b>Temperature rise time (hr)</b>			
<b>Freezing Capacity (kg/24hr)</b>			
<b>Refrigerant</b>			
<b>Star Rating</b>			
<b>Climate Class</b>			

※ Climate Class : SN - T (This appliance is intended to be used at an ambient temperature between 10°C and 43°C.)