



ENGLISH

ČEŠTINA

SOVENCINA

ROMANA

POLSKI

MAGYAR

HRVATSKI

SRPSKI

БЛГЛПРСКИ

МАКЕДОНСКИ

OWNER'S MANUAL STYLISH PORTABLE BOOM BOX

Please read this manual carefully before operating your set and retain it for future reference.

SB16 (SB16)



MFL67565207

Safety Information



CAUTION: TO REDUCE THE RISK OF ELECTRIC SHOCK DO NOT REMOVE COVER (OR BACK) NO USER-SERVICEABLE PARTS INSIDE REFER SERVICING TO QUALIFIED SERVICE PERSONNEL.

This lightning flash with arrowhead symbol within an equilateral triangle is intended to alert the user to the presence of uninsulated dangerous voltage within the product's enclosure that may be of sufficient magnitude to constitute a risk of electric shock to persons.



The exclamation point within an equilateral triangle is intended to alert the user to the presence of important operating and maintenance (servicing) instructions in the literature accompanying the product.



WARNING: TO PREVENT FIRE OR ELECTRIC SHOCK HAZARD, DO NOT EXPOSE THIS PRODUCT TO RAIN OR MOISTURE.

WARNING: Do not install this equipment in a confined space such as a book case or similar unit.

CAUTION: Do not block any ventilation openings. Install in accordance with the manufacturer's instructions.

Slots and openings in the cabinet are provided for ventilation and to ensure reliable operation of the product and to protect it from over heating. The openings shall be never be blocked by placing the product on a bed, sofa, rug or other similar surface. This product shall not be placed in a built-in installation such as a bookcase or rack unless proper ventilation is provided or the manufacturer's instruction has been adhered to.

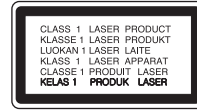

CAUTION: This product employs a Laser System. To ensure proper use of this product, please read this owner's manual carefully and retain it for future reference. Shall the unit require maintenance, contact an authorized service center. Use of controls, adjustments or the performance of procedures other than those specified herein may result in hazardous radiation exposure. To prevent direct exposure to laser beam, do not try to open the enclosure.

CAUTION concerning the Power Cord

Most appliances recommend they be placed upon a dedicated circuit;

That is, a single outlet circuit which powers only that appliance and has no additional outlets or branch circuits. Check the specification page of this owner's manual to be certain. Do not overload wall outlets. Overloaded wall outlets, loose or damaged wall outlets, extension cords, frayed power cords, or damaged or cracked wire insulation are dangerous. Any of these conditions could result in electric shock or fire. Periodically examine the cord of your appliance, and if its appearance indicates damage or deterioration, unplug it, discontinue use of the appliance, and have the cord replaced with an exact replacement part by an authorized service center. Protect the power cord from physical or mechanical abuse, such as being twisted, kinked, pinched, closed in a door, or walked upon. Pay particular attention to plugs, wall outlets, and the point where the cord exits the appliance. To disconnect power from the mains, pull out the mains cord plug. When installing the product, ensure that the plug is easily accessible.

This device is equipped with a portable battery or accumulator.

Safety way to remove the battery or the battery from the equipment: Remove the old battery or battery pack, follow the steps in reverse order than the assembly. To prevent contamination of the environment and bring on possible threat to human and animal health, the old battery or the battery put it in the appropriate container at designated collection points. Do not dispose of batteries or battery together with other waste. It is recommended that you use local, free reimbursement systems batteries and accumulators. The battery shall not be exposed to excessive heat such as sunshine, fire or the like.

CAUTION: The apparatus shall not be exposed to water (dripping or splashing) and no objects filled with liquids, such as vases, shall be placed on the apparatus.

You have to set the disc format option to [Mastered] in order to make the discs compatible with the LG players when formatting rewritable discs. When setting the option to Live File System, you cannot use it on LG players.

(Mastered/ Live File System : Disc format system for Windows Vista)

Disposal of your old appliance



1. When this crossed-out wheeled bin symbol is attached to a product it means the product is covered by the European Directive 2002/96/EC.
2. All electrical and electronic products should be disposed of separately from the municipal waste stream via designated collection facilities appointed by the government or the local authorities.
3. The correct disposal of your old appliance will help prevent potential negative consequences for the environment and human health.
4. For more detailed information about disposal of your old appliance, please contact your city office, waste disposal service or the shop where you purchased the product.

Disposal of waste batteries/accumulators



1. When this crossed-out wheeled bin symbol is attached to batteries/accumulators of Your product it means they are covered by European Directive 2006/66/EC.
2. This symbol may be combined with chemical symbols for mercury(Hg), cadmium(Cd) or lead(Pb) if the battery Contains more that 0.0005% of mercury,0.002% of cadmium or 0.004% of lead.
3. All batteries/accumulators should be disposed separately from the municipal waste stream via designated collection facilities appointed by the government or the local authorities.
4. The correct disposal of Your old batteries/accumulators will help to prevent potential negative consequences for the environment, animal and human health.
5. For more detailed information about disposal of Your old batteries/accumulators, please contact Your city office, waste disposal service or the shop where You purchased the product.



LG Electronics hereby declares that this/ these product(s) is/are in compliance with the essential requirements and other relevant provisions of Directive 2004/108/EC, 2006/95/EC, and 2009/125/EC.

European Standards Centre:

Krijgsman 1, 1186 DM Amstelveen
The Netherlands

- Please note that this is NOT a Customer Service contact point. For Customer Service Information, see Warranty Card or contact the dealer that you purchased this product.

Copyrights

It is forbidden by law to copy, broadcast, show, broadcast via cable, play in public, or rent copyrighted material without permission. This product features the copy protection function developed by Macrovision. Copy protection signals are recorded on some discs. When recording and playing the pictures of these discs picture noise will appear. This product incorporates copyright protection technology that is protected by U.S. patents and other intellectual property rights. Use of this copyright protection technology must be authorized by Macrovision, and is intended for home and other limited viewing uses only unless otherwise authorized by Macrovision. Reverse engineering or disassembly is prohibited.

CONSUMERS SHOULD NOTE THAT NOT ALL HIGH DEFINITION TELEVISION SETS ARE FULLY COMPATIBLE WITH THIS PRODUCT AND MAY CAUSE ARTIFACTS TO BE DISPLAYED IN THE PICTURE. IN CASE OF 525 OR 625 PROGRESSIVE SCAN PICTURE PROBLEMS, IT IS RECOMMENDED THAT THE USER SWITCH THE CONNECTION TO THE 'STANDARD DEFINITION' OUTPUT. IF THERE ARE QUESTIONS REGARDING OUR TV SET COMPATIBILITY WITH THIS MODEL 525p AND 625p UNIT, PLEASE CONTACT OUR CUSTOMER SERVICE CENTER.

Table of Contents

1 Getting Started

- 2 Safety Information
- 6 Accessories
- 6 Playable file Requirement
- 7 Front panel

2 Connecting

- 8 Power Source
 - 8 – Battery Installation
 - 8 – AC Power Cord Connection
- 9 Other Equipment Connection
 - 9 – USB Connection
 - 9 – Removing the USB Device from the unit
 - 9 – Compatible USB Devices
 - 9 – USB device requirement
 - 9 – PORT. IN Connection

3 System Setting

- 10 Basic Operations
- 10 Other Operations
- 11 Radio Operations
 - 11 – Listening to the radio
 - 11 – To turn off the radio
- 12 Recording to USB
 - 12 – To select recording bit rate and speed

4 Operating

- 13 Maintenance
 - 13 – Handling the Unit
 - 13 – Notes on Discs
- 13 Trademarks and Licenses

5 Troubleshooting

- 14 Troubleshooting

6 Appendix

- 15 Specifications

1

2

3

4

5

6

Accessories

Please check and identify the supplied accessories.

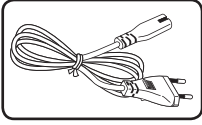

AC Power cable (1)

Playable file Requirement

MP3/WMA music file requirement:

MP3/WMA file compatibility with this unit is limited as follows :

- Sampling frequency : between 32 to 48 kHz (MP3), within 32 to 48kHz (WMA)
- Bit rate : between 32 to 320 kbps (MP3), 40 to 320 kbps (WMA)
- Maximum files : Under 999
- File extensions : ".mp3"/".wma"
- CD-ROM file format : ISO 9660/ JOLIET
- We recommend that you use Easy-CD creator, which creates an ISO 9660 file system.

Front panel

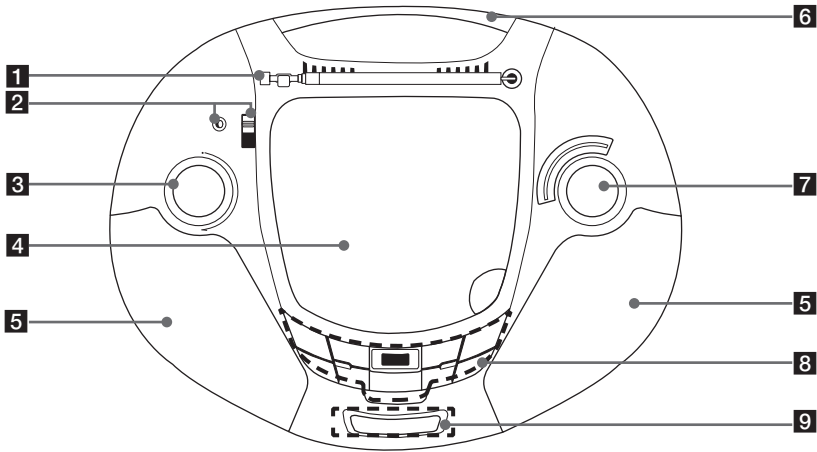

1 Antenna

2 PORT.IN

The player can be used to play the music from many types of portable player.

FUNCTION switch

Changes the function.

3 VOL (-/+)

Volume control.

4 Disc Door

5 Speaker

6 Handle

7 TUNING (-/+) DIAL

8 REPEAT

You can enjoy the music repeatedly or randomly.

PROG.

Plays back tracks in any order

USB/CD

Selects the USB/ CD function.

▶/|| Starts or pauses playback.

■ Stop

◀◀/▶▶ Skip/ search

▲▼ Search for a folder of MP3/ WMA files.

When a CD/ USB containing MP3/ WMA files in several folders is being played, press it to select the folder you want to play.

USB Connector

USB REC

Recording.

9 DISPLAY WINDOW

(Only CD and USB)

Power Source

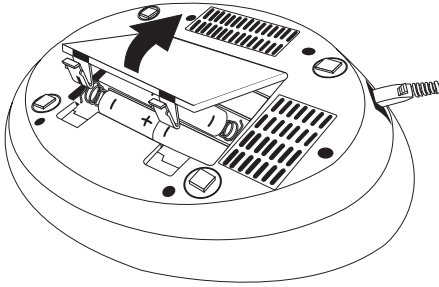

2

Connecting

! Note

- Unplug the AC power cord from the wall outlet if you do not to use for an extended period of time.
- To avoid damage from possible battery leakage, remove the batteries if you do not plan to use the unit for an extended period of time.
- When the batteries are weak, replace all the batteries with new ones.
- While the AC power cord connect to the wall outlet, the batteries are not worn out.
- Batteries (battery pack or batteries installed) shall not be exposed to excessive heat such as sunshine, fire or the like.

Battery Installation

1. Press and open the battery cover.
2. Put six "C" (R14) batteries (not supplied) into the compartment making sure the ⊕ and ⊖ should be correctly positioned.
3. Replace the battery cover.

AC Power Cord Connection

1. Connect one end of the AC power cord (included) to the AC IN socket.
2. Plug the other end into the wall outlet.

Other Equipment Connection

USB Connection

Connect the USB port of USB Memory (or MP3 player, etc.) to the USB port on the front of the unit.

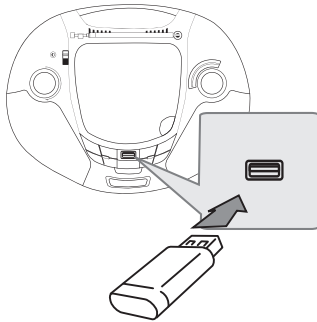

Removing the USB Device from the unit

1. Choose a different function mode or press **■** twice in a row.
2. Remove the USB device from the unit.

Compatible USB Devices

- MP3 Player : Flash type MP3 player.
- USB Flash Drive : Devices that support USB 2.0 or USB 1.1.
- The USB function of this unit does not support some USB devices.

USB device requirement

- Devices which require additional program installation connected to a computer, are not supported.
- Do not extract the USB device while in operation.
- For a large capacity USB, it may take longer than a few minute to be searched.
- To prevent data loss, back up all data.
- If you use a USB extension cable or USB hub, the USB device is not recognized.
- Using NTFS file system is not supported. (Only FAT(16/ 32) file system is supported.)
- This unit is not supported when the total number of files is 1 000 or more.
- External HDD, Card readers, Locked devices, or hard type usb devices are not supported.
- USB port of the unit cannot be connected to PC. The unit can not be used as a storage device.

PORT. IN Connection

Connect a output (earphone or line out) of portable device (MP3 or PMP etc) to the AUDIO input connector.

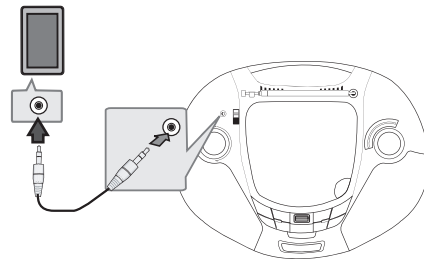

- A warning that excessive sound pressure from earphones and headphones can cause hearing loss.

Basic Operations

1. Insert the disc (Label facing up) or connect the USB device to the USB port.
2. Select the CD or USB function by pressing **USB/CD**.
3. Select a file (or track) you want to play by pressing **◀◀/▶▶**

To	Do this
Stop	Press ■ .
Playback	Press ▶/ .
Pause	Press ▶/
Skipping to the next/previous track/file	During playback, press ◀◀ or ▶▶ to go to the next track/ file or to return to the beginning of the current track/ file. Press ◀◀ twice briefly to step back to the previous track/ file.
Searching for a section within a track	Press and hold ◀◀ or ▶▶ during playback and release it at the point you want to listen to.
Playing repeatedly or randomly	Press REPEAT repeatedly, the display changes in the following order, REPEAT 1 -> REPEAT ALL -> RANDOM -> OFF.

Other Operations

Programmed Playback

The program function enables you to store your favourite files from any disc or USB device.

A program can contain 20 tracks.

1. Insert a CD or USB and wait for it to be order.
2. Press **PROG.** in stop status.
3. Press **◀◀** or **▶▶** to select a track.
4. Press **PROG.** again to save and select a next track.
5. Press **▶/||** to play the programmed music files.
6. To clear your selection, press **■** twice.

Note

The programs are also cleared when the disc or USB device is removed, the unit is switched to power off or the function is switched to others.

Listening to music from your portable player

The unit can be used to play the music from many types of portable player.

1. Connect the portable player to the **PORT. IN** (PORTABLE IN) connector on the unit.
2. Select the PORTABLE function by pressing **FUNCTION** switch.
3. Turn on the portable player and start it playing.

Radio Operations

Listening to the radio

1. Select the radio function by pressing **FUNCTION** switch.
2. Select either **FM** or **AM**
3. Select the radio station by using **TUNING** dial

To turn off the radio

Set **FUNCTION** switch to CD or PORT. IN, USB, to turn off your unit.

Recording to USB

You can record a various sound source to USB.

1. Connect the USB device to the unit.
2. Select a function in which you want to record playback a sound source first. (Only CD)

One track recording - You can record to USB after playing the file you want.

All tracks recording - You can record to USB after stopping.

Program list recording - After moving to the programmed list and you can record it to USB.

3. Start the recording by pressing **USB REC**.
4. To stop recording, press **■**.

To select recording bit rate and speed

1. Press **USB REC** for longer than 3 seconds.
2. Use **◀◀** or **▶▶** to select the bit rate.
3. Press **USB REC** again to select the recording speed.
4. Use **◀◀** or **▶▶** to select a desired recording speed.

X1 SPEED (R 1)

- You can listen to music while recording it.

X2 SPEED (R 2)

- You can just record the music file.

5. Press **USB REC** to finish the setting.

! Note

On radio or portable mode, you cannot set the recording speed.

! Note

- You can check the recording percentage rate for the USB record on the display window during the recording.
- During recording MP3/WMA, there is no sound.
- When you stop recording during playback, the file that has been recorded at that time will be stored. (AUDIO CD Only)
- Do not remove the USB device or turn off the unit during USB recording. If not, an incomplete file may be made and not deleted on PC.
- If USB recording does not work, messages like "NO USB", "ERR", "FUL" will be displayed on the display window.
- Multi card reader device or External HDD can not be used for USB recording.
- When you stop recording during playback, the file will not be stored. (MP3/WMA)
- You may not store more than 999 files.
- It'll be stored as follows

AUDIO CD	MP3/ WMA
■ CD_REC TRK_001 TRK_002 	■ FILE_REC ABC(File name) DEF(File name)

The making of unauthorized copies of copy-protected material, including computer programs, files, broadcasts and sound recordings, may be an infringement of copyrights and constitute a criminal offense. This equipment should not be used for such purposes.

**Be responsible
Respect copyrights**

Maintenance

Handling the Unit

When shipping the unit

Please save the original shipping carton and packing materials. If you need to ship the unit, for maximum protection, re-pack the unit as it was originally packed at the factory.

Keeping the exterior surfaces clean

- Do not use volatile liquids such as insecticide spray near the unit.
- Wiping with strong pressure may damage the surface.
- Do not leave rubber or plastic products in contact with the unit for a long period of time.

Cleaning the unit

To clean the player, use a soft, dry cloth. If the surfaces are extremely dirty, use a soft cloth lightly moistened with a mild detergent solution. Do not use strong solvents such as alcohol, benzene, or thinner, as these might damage the surface of the unit.

Maintaining the Unit

The unit is a high-tech, precision device. If the optical pick-up lens and disc drive parts are dirty or worn, the picture quality could be diminished. For details, please contact your nearest authorized service center.

Notes on Discs

Handling Discs

Never stick paper or tape on the disc.

Storing Discs

After playing, store the disc in its case. Do not expose the disc to direct sunlight or sources of heat and never leave it in a parked car exposed to direct sunlight.

Cleaning Discs

Do not use strong solvents such as alcohol, benzene, thinner, commercially available cleaners, or anti-static spray intended for older vinyl records.

Trademarks and Licenses



Troubleshooting

	PROBLEM	CAUSE	CORRECTION
General	No Power.	• The power cord is not plugged in.	• Plug in the power cord.
		• The batteries are not remaining.	• Change the batteries with a new ones.
	No sound.	• Check whether you select right function.	• Press FUNCTION switch and check the selected function.
CD	The unit does not start playback.	• An unplayable disc is inserted.	• Insert a playable disc.
		• No disc is inserted.	• Insert a disc.
		• The disc is dirty.	• Clean the disc.
		• The disc is inserted upside down.	• Place the disc with the label or printed side facing upwards.
RADIO	No sound.	• The function is not selected to the Radio.	• Select the function to the Radio.
	Some noise occurs.	• There are electronic devices near the player.	• Set the player far from the devices.

Specifications

General	
Power supply	Refer to main label.
Power consumption	Refer to main label.
Net Weight	1.6 kg
External dimensions (W x H x D)	(303 x 121 x 240) mm
Operating conditions Temperature	5 °C to 40 °C, Operation status: Horizontal
Operating humidity	5 % to 90 %

Tuner FM/AM	
FM Tuning Range	88 to 108 MHz
AM Tuning Range	530 to 1 620 kHz

Amplifier	
Output Power	0.5 W x 2

USB	
Bus Power Supply (USB)	DC 5 V  500 mA
USB Version	USB 2.0 or USB 1.1

CD	
Frequency Response	100 MHz to 18 kHz
Signal-to-noise ratio	61 dB
Dynamic range	56 dB

Speakers	
Type	1 Way Speaker
Impedance	8 Ω
Rated Input Power	1 W
Max. Input Power	2 W

- Design and specifications are subject to change without notice.

