



LG

Life's Good

ENGLISH

OWNER'S MANUAL

SIGNAGE DISPLAY

Please read this manual carefully before operating the your set and retain it for future reference.

SIGNAGE DISPLAY MODELS

47WV30

CONTENTS

4 ASSEMBLING AND PREPARING

- 4 Unpacking
- 5 Parts
- 6 To install in a Portrait Layout
- 6 Remove L-brackets before Installation
- 7 Moving Handles
 - 7 - Moving the device in a vertical position
 - 7 - Moving the device in a horizontal position
- 8 STORAGE METHOD FOR PANEL PROTECTION
 - 8 - Correct Method
 - 8 - Incorrect Method
- 9 Installing on a wall
- 10 EXTERNAL EQUIPMENT SETUP
 - 10 - IR RECEIVER
- 11 Tiling Displays
 - 11 - How to Join Sets - Installing Set 1
 - 12 - How to Join Sets - Installing Set 2
 - 13 - How to Join Sets - Installing Set 3
 - 14 - How to Join Sets - Installing Set 4
- 15 Inserting the Cable Holder

16 REMOTE CONTROL

- 18 Displaying the device name connected to an input port
- 19 Picture ID

20 USING THE MONITOR SET

- 20 Connecting to a PC
 - 20 - RGB connection
 - 21 - DVI to DVI connection
 - 21 - HDMI connection
 - 22 - Audio connection
 - 22 - IR Receiver connection

- 23 Adjusting the screen
 - 23 - Selecting an image mode
 - 23 - Customizing image options
 - 24 - Customizing PC display options
- 24 Adjusting the sound
 - 24 - Selecting a sound mode
 - 25 - Customizing sound options
- 25 Using additional options
 - 25 - Adjusting aspect ratio

27 ENTERTAINMENT

- 27 - Connecting to a wired network
- 28 - Network Status
- 29 - Connecting USB storage devices
- 30 - Browsing files
- 31 - Viewing movies
- 35 - Viewing photos
- 37 - Listening to music
- 39 - DivX registration code

41 CUSTOMIZING SETTINGS

- 41 Accessing main menus
 - 42 - PICTURE settings
 - 44 - AUDIO settings
 - 45 - TIME settings
 - 46 - OPTION settings
 - 48 - NETWORK settings

49 MAKING CONNECTIONS

- 50 Connecting to a HD receiver, DVD or VCR player
 - 50 - HDMI connection
 - 50 - DVI - HDMI connection
 - 51 - AV connection
- 51 Connecting to a USB

- 51 Connecting to the LAN
- 51 - LAN connection
- 52 Daisy Chain Monitors
- 52 - RGB Cable
- 52 - DVI Cable

53 TROUBLESHOOTING

- 53 General

55 SPECIFICATIONS

57 RS-232 CONTROL

67 LICENSE

NOTE

- The following three phenomena may occur due to the characteristics of the Super Narrow Bezel LCD. They are not related to the display's performance.
 1. The edges of the screen may become darker or shadows may appear.
 2. Light leakage may occur depending on the viewing angle.
 3. Some components such as the guide boss or clip may be visible on the edges of the screen.

ASSEMBLING AND PREPARING

Unpacking

Check your product box for the following items. If there are any missing accessories, contact the local dealer where you purchased your product. The illustrations in this manual may differ from the actual product and accessories.

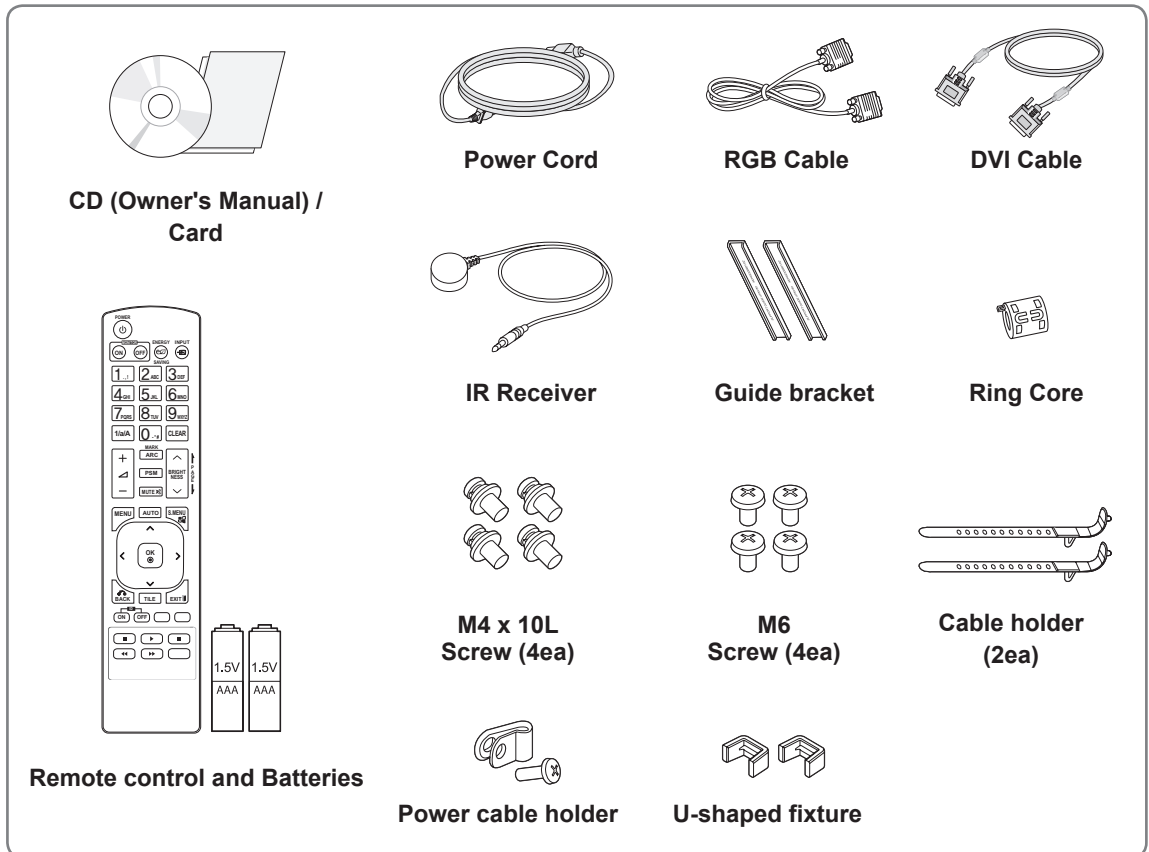

CAUTION

- Do not use any pirated items to ensure the safety and product life span.
- Any damages or injuries by using pirated items are not covered by the warranty.



NOTE

- The accessories supplied with your product may vary depending on the model.
- Product specifications or contents in this manual may be changed without prior notice due to upgrade of product functions.

• How to Use a Ring Core

A ring core reduces electromagnetic waves emitted from the IR receiver. Loop the cable through the core once, before using it as illustrated.



Parts

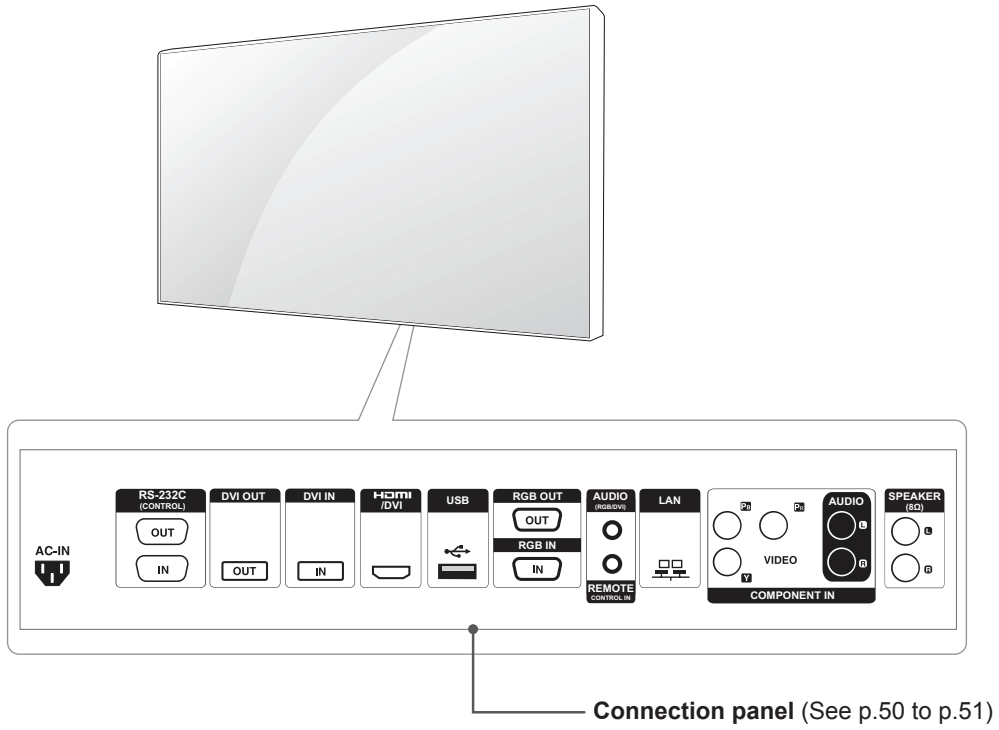

To install in a Portrait Layout

When installing in a Portrait Layout, rotate the monitor clockwise 90 degrees (when facing the screen).

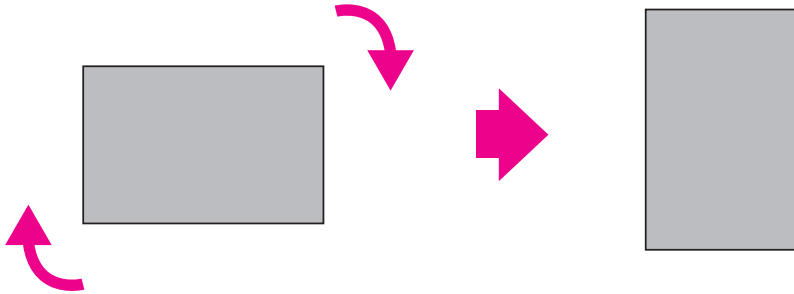

Remove L-brackets before Installation

Remove the L-brackets from each corner of the monitor before installing it.

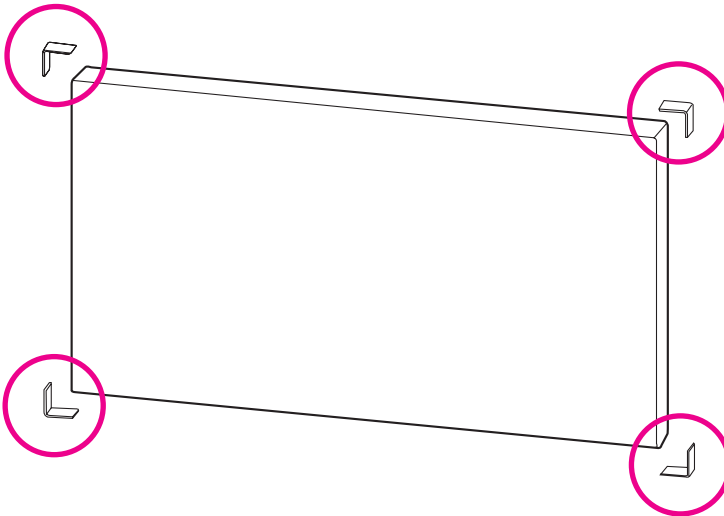

! NOTE

Keep the removed L-brackets and use them when moving the monitor later.

Moving Handles

Moving the device in a vertical position

Hold the vertical handles on the left and right sides or the left and right handles on the back of the display.

Moving the device in a horizontal position

Have the screen facing down and hold the vertical handles on the left and right sides.

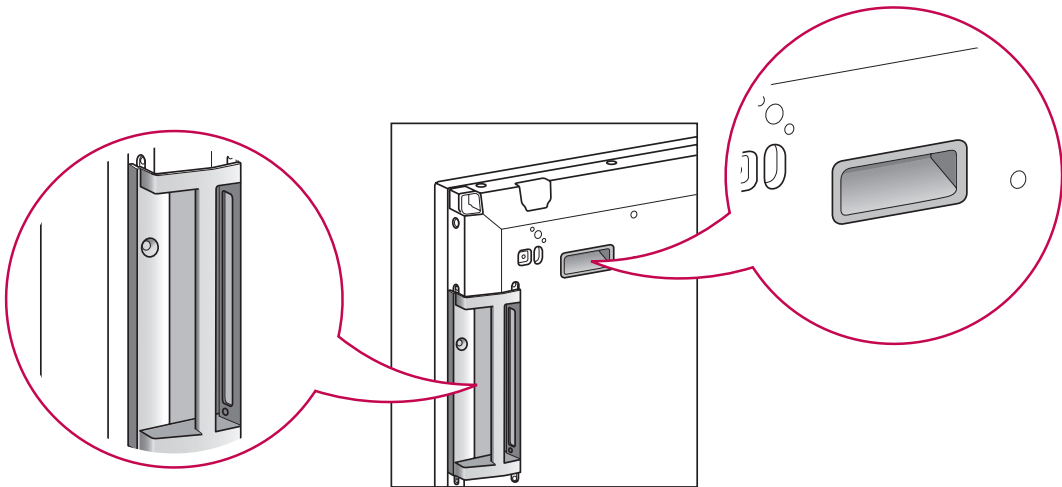
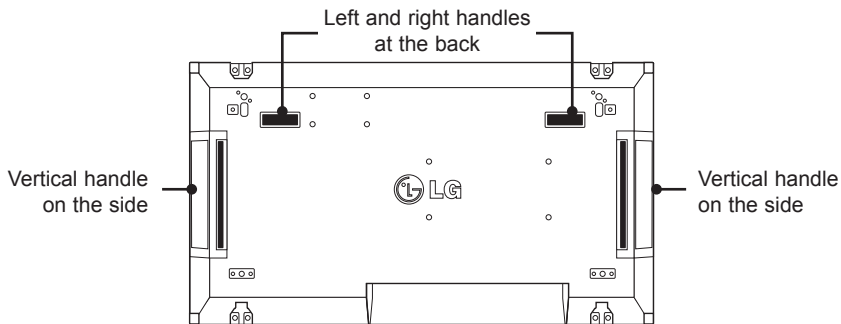

CAUTION

- Be careful not to directly touch the panel or expose it to shock when moving the monitor.
- Hold the monitor with the handles as the corners of the front panel are sharp, which may cause an injury.

STORAGE METHOD FOR PANEL PROTECTION

Correct Method

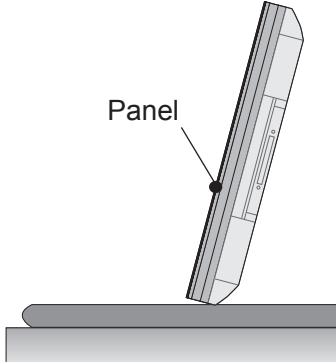

If the product needs to be set upright, hold both sides of the product, and tilt backward carefully for. Do not let the panel touch the floor.

Incorrect Method

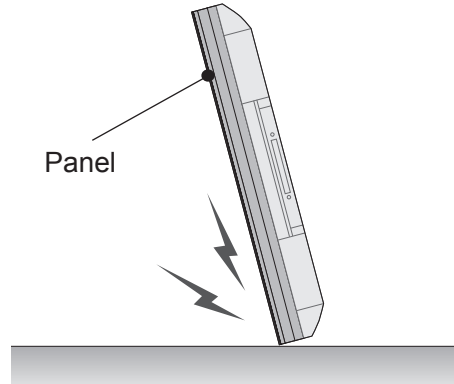

If the product is tilted onto the bezel, the bottom of the panel may be damaged.

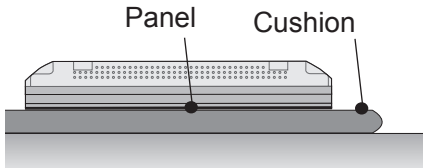

When laying down the product, lay a cushion on a flat floor. Put the product on it with the panel of the product facing down.

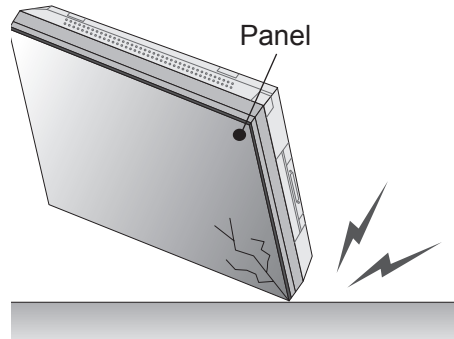

If the product is tilted onto the edge of the panel, the panel may be damaged.

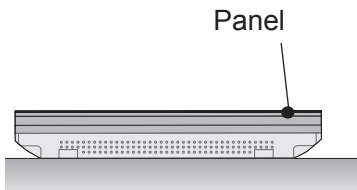

If there is not a cushion available, ensure the floor is clean and then lay the product down carefully with the panel facing either upward or downward. At this time, be careful for objects not to fall on the panel.

Installing on a wall

Install the monitor at least 10 cm away from the wall and leave about 10 cm of space at each side of the monitor to ensure sufficient ventilation. Detailed installation instructions can be obtained from your local retail store. Please refer to the manual to install and set up a tilting wall mounting bracket.

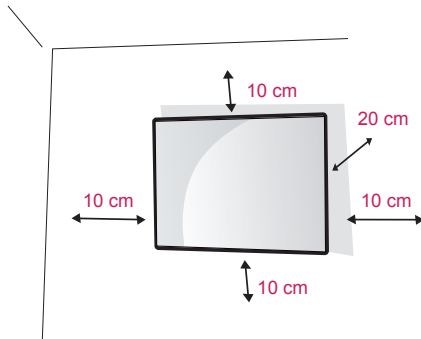

If you want to mount the monitor on the wall (optional), attach the wall mounting bracket to the rear of the monitor.

Make sure that the wall mounting bracket is securely fixed to the monitor and to the wall.

Use the wall mount plate and screws that comply with the VESA standard.

Use the wall mount plate and screws conforming to the VESA standard.

! NOTE

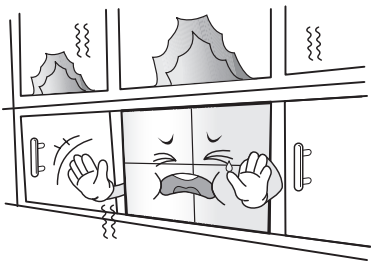

Do not install the product in a place with no ventilation (e.g., on a bookshelf or in a closet) or on a carpet or cushion. If there is no other option but to mount the product on the wall, make sure that sufficient ventilation is provided before installation.

- Failure to do so may result in a fire due to the increase in the internal temperature.

! CAUTION

- Disconnect the power cord first, and then move or install the Monitor set. Otherwise electric shock may occur.
- If you install the Monitor set on a ceiling or slanted wall, it may fall and result in severe injury. Use an authorized LG wall mount and contact the local dealer or qualified personnel.
- Do not over tighten the screws as this may cause damage to the Monitor set and void your warranty.
- Use the screws and wall mounts that meet the VESA standard. Any damages or injuries by misuse or using an improper accessory are not covered by the warranty.

! NOTE

- Use the screws that are listed on the VESA standard screw specifications.
- The wall mount kit includes an installation manual and necessary parts.
- The wall mount bracket is optional. You can obtain additional accessories from your local dealer.
- The length of screws may differ depending on the wall mount. Be sure to use the proper length.
- For more information, refer to the instructions supplied with the wall mount.

EXTERNAL EQUIPMENT SETUP

ENGLISH

IR RECEIVER

This allows a remote control sensor to be placed in a custom location. Then that display can control other displays via an RS-232 cable. Refer to page 19 for more information.

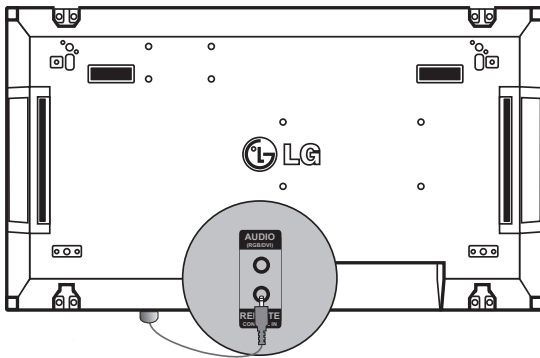

Tiling Displays

How to Join Sets - Installing Set 1

*Example of 2 x 2 tiling

* The numbers assigned in this example (#1, #2, #3, #4) are used to demonstrate the installation procedure to ensure it is easy to follow. These numbers have nothing to do with the Set ID that is used to operate the remote control.

Set the guide bracket into the bracket groove using screws and mount the set to the wall mount plate or the wall.

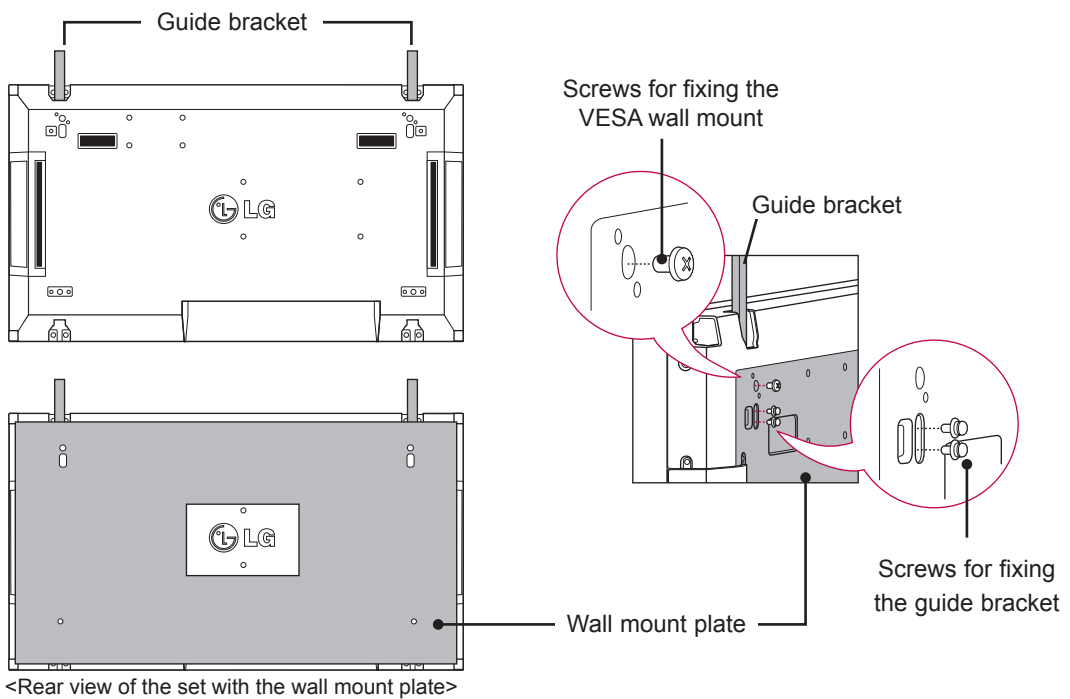

* The wall mount plate is shaded in gray in the illustration to help you see it.

How to Join Sets - Installing Set 2

Join Set 2 to Set 1 using the guide brackets on the top side of Set 1 and mount the two sets to the wall mount plate or the wall.

Remove the guide brackets after mounting the sets.

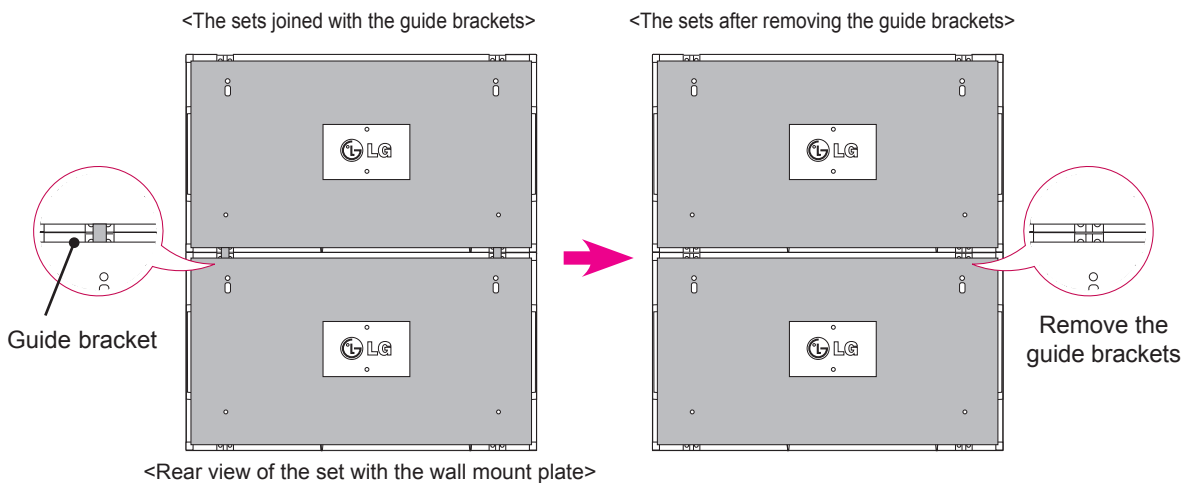

How to remove the guide brackets

- * Unscrew the guide bracket screws from the rear of the set and remove the guide brackets.
- * Once the screws are removed, the guide brackets will drop. You need to remove them through the gap on the sides of the set.
- * This can be done only when there is enough space between the set and the wall mount plate or the wall to unscrew the screws. (Please check whether there is enough space to remove the screws before fixing the guide brackets.)

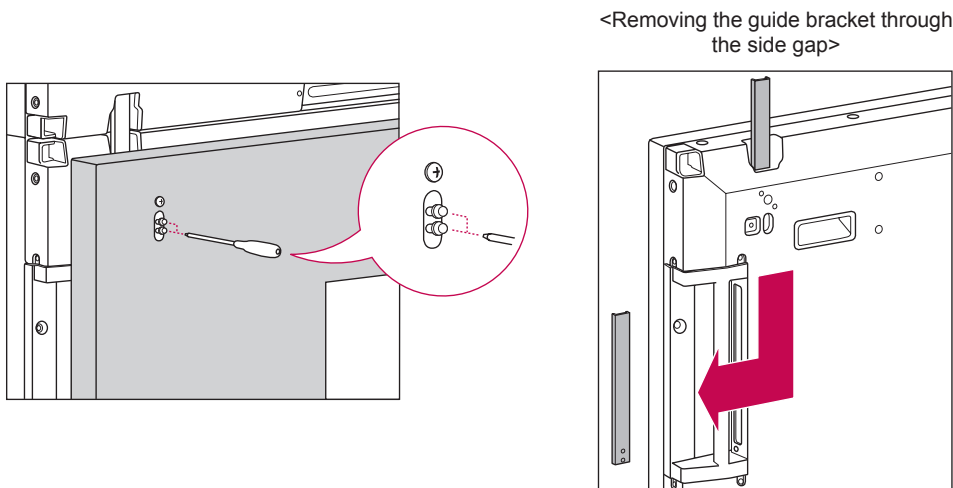

How to Join Sets - Installing Set 3

Fix the guide brackets to Set 3 following the steps above, and loosely mount the set to the wall mount plate or the wall.

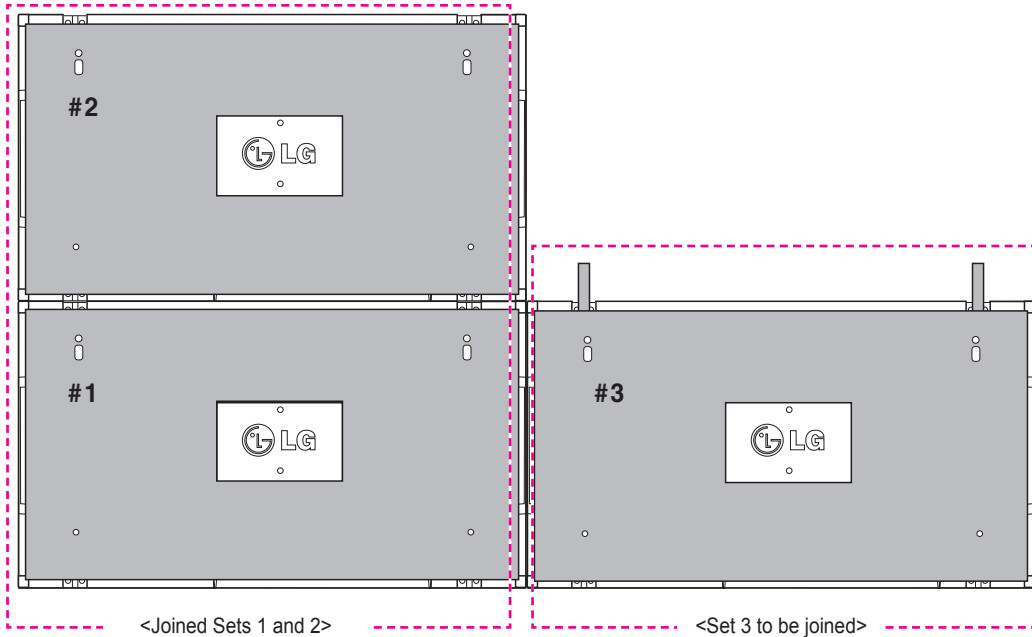

Minimize the space between the sides of the sets using the U-shaped fixture.

When the sets are joined with the minimum amount of space between them, firmly mount them to the wall mount plate or the wall.

When the sets are firmly mounted to the wall, remove the U-shaped fixtures.

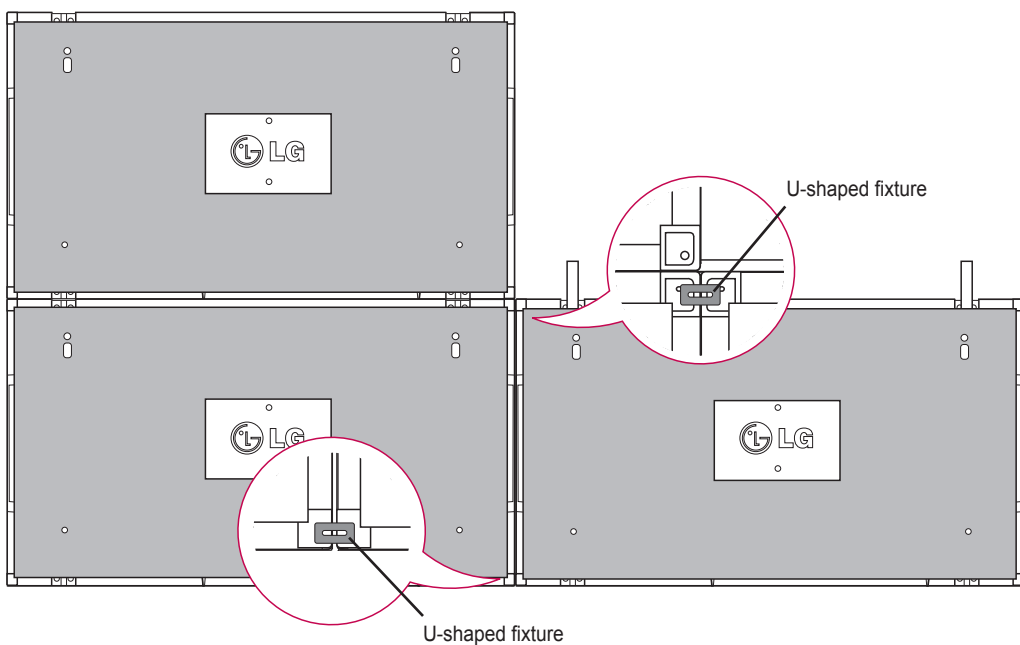

How to Join Sets - Installing Set 4

Loosely mount Set 4 to the wall mount plate or the wall and minimize the space between the sets using the U-shaped fixtures.

When Set 4 is firmly mounted to the wall, remove the U-shaped fixtures.

Remove the guide brackets. See <How to Join Sets - Installing Set2,3>.

Now the 2 x 2 tiling is complete.

You can tile in various combinations, such as 3 x 3.

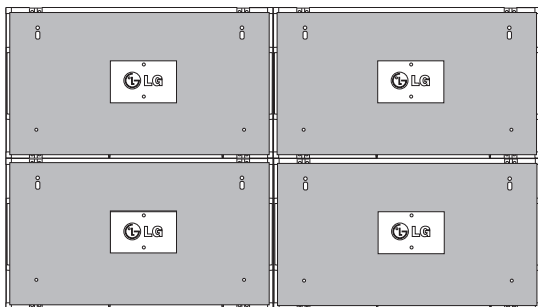

Set 4 joined to the rest of the sets
(2 x 2 tiling)

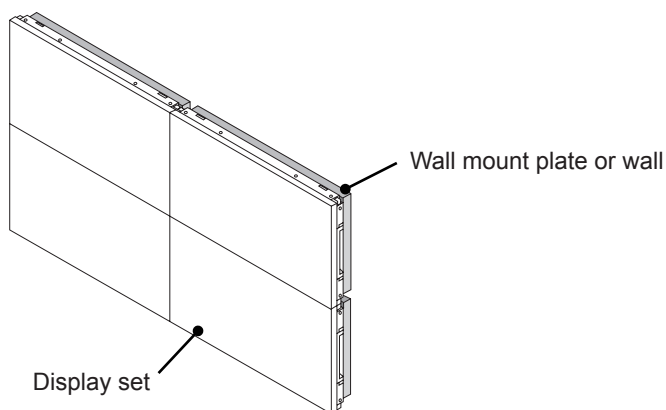

NOTE

- The guide brackets for tiling should only be used to join sets and should be removed once they are joined.
- The guide brackets should only be used as the assisting tool when tiling sets. The load applied to each set should be supported by the wall mount plate or the wall using a VESA wall mount (800 x 400).
- (Each set must be firmly mounted to the wall mount plate or the wall.)
- The guide brackets must be removed once the sets are joined. When joining the sets without removing the guide brackets, extra caution is required to prevent damage due to the set weight.
- The U-shaped fixtures must also be removed after mounting the set to the wall mount plate or the wall.
- You may mount the set without using the guide brackets or the U-shaped fixtures; this does not affect the performance of the device.

Inserting the Cable Holder

As illustrated, insert two cable holders into the holes at the bottom rear of the set to organize the cable bundles.

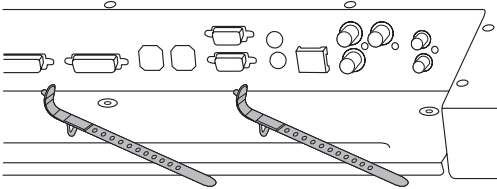

As illustrated, screw the power cable holder into the hole on the bottom rear of the set to hold the power cables together. (This is to put the power cables inside the holder.)

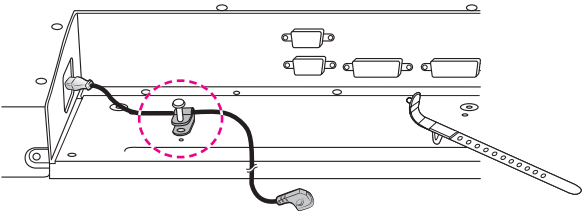

REMOTE CONTROL

The descriptions in this manual are based on the buttons of the remote control. Please read this manual carefully and use the Monitor set correctly.

To replace batteries, open the battery cover, replace batteries (1.5 V AAA) matching ⊕ and ⊖ ends to the label inside the compartment, and close the battery cover. To remove the batteries, perform the installation actions in reverse.

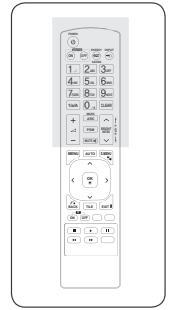
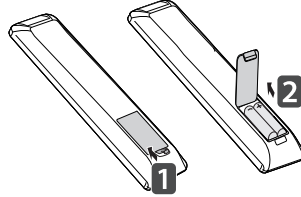

CAUTION

- Do not mix old and new batteries, as this may damage the remote control.

Make sure to point the remote control to the remote control sensor on the Monitor set.

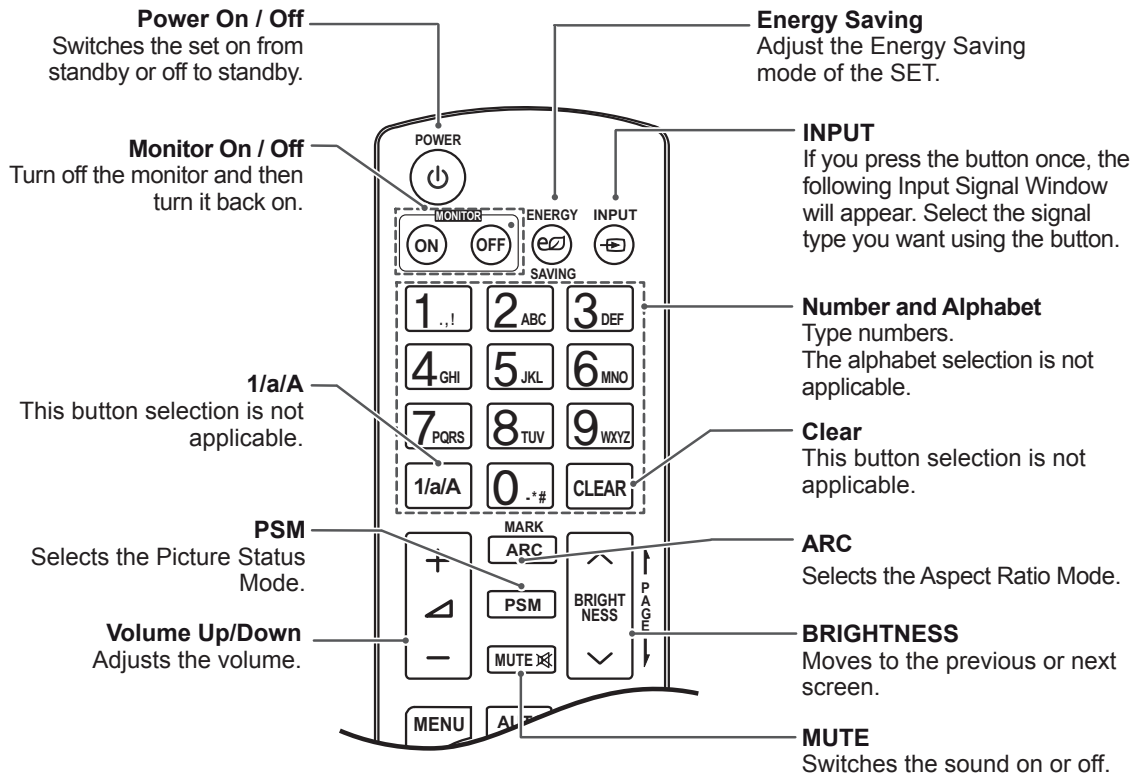

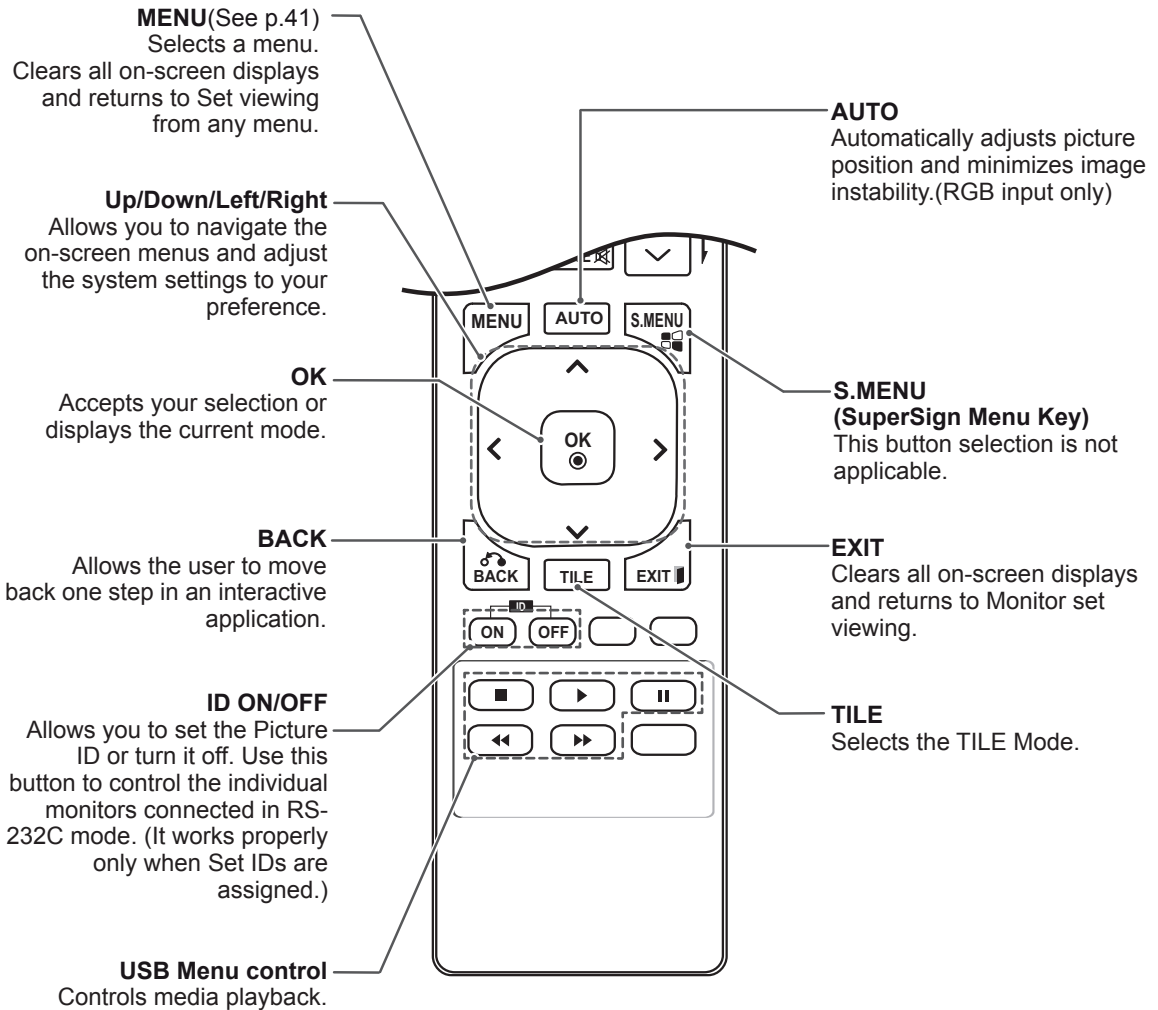
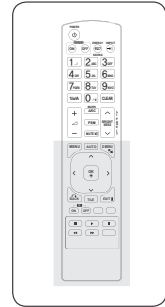

Displaying the device name connected to an input port

Display which devices are connected to which external input ports.

- 1 Access the Input list screen and press the blue (input label) button on the remote control.

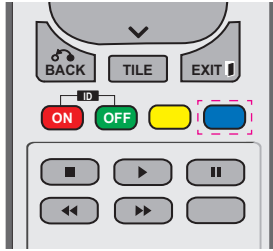

- 2 You can assign an input label for every input except USB.

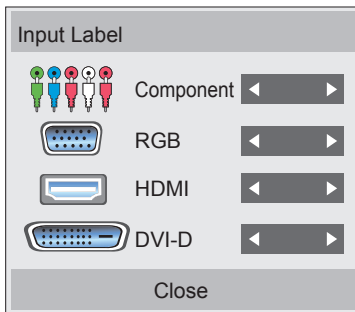

! NOTE

- External inputs supported: Component, RGB, HDMI, DVI-D
- Labels available : VCR, DVD, Set top box, Satellite, Game, PC, Blue-ray, HD-DVD
- The input labels are displayed on the Input Label screen or at the top left of the screen when you change the external input setting.
- For DTV/PC-compatible signals, such as 1080p 60 Hz, the screen settings may change according to the input label. The Just Scan option is available if a PC is connected as an external device.

Picture ID

Picture ID is used to change the settings of a specific display using a single IR receiver for multi-vision. The set receiving the IR signal communicates with another set via an RS232C connection. Each set is identified by a Set ID. If you assign the Picture ID using the remote control, only displays with the same Picture ID and Set ID can be controlled remotely.

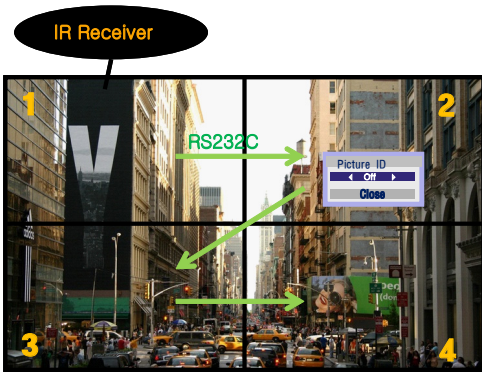

2X2 Multi-Vision (Total Set ID: 4)
Set IDs are assigned as shown in the picture.

- 1 Press the red ON button on the remote control to assign the Picture ID.

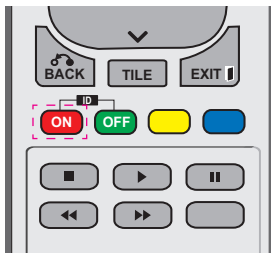

- 2 If you press the left/right buttons or press the ON button repeatedly, the Picture ID cycles through OFF and 0 to 4. Assign the ID you want.

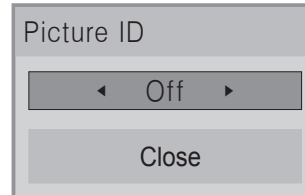

- If you assign the Set ID to each set with multi-vision, and then assign the Picture ID using the red button on the remote control, the key command is displayed for the set with the same Set ID and Picture ID. A set with different Set IDs and Picture IDs cannot be controlled by IR signals.
- For more information on how to assign the Set ID, see "Set ID" on page See p.46.

NOTE

- For example, if the Picture ID is assigned to 2, the upper right display (Set ID: 2) can be controlled by IR signals.
- For each set, you can change the settings for the PICTURE, AUDIO, TIME, NETWORK and MY MEDIA menus or the hot keys on the remote control.
- If you press the green OFF button for Picture IDs, the Picture IDs for all sets are turned off. If you then press any button on the remote control, all sets will start working again.
- Picture ID will be disabled while using the MY MEDIA menu.

USING THE MONITOR SET

Connecting to a PC

NOTE

- It is recommended to you use an HDMI connection for the best image quality.



CAUTION

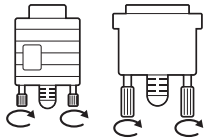

- Connect the signal input cable and tighten it by turning the screws clockwise.

RGB connection

Transmits an analog video signal from your PC to the Monitor set. Connect the PC and the Monitor set with the D-sub 15 pin cable as shown the following illustrations.

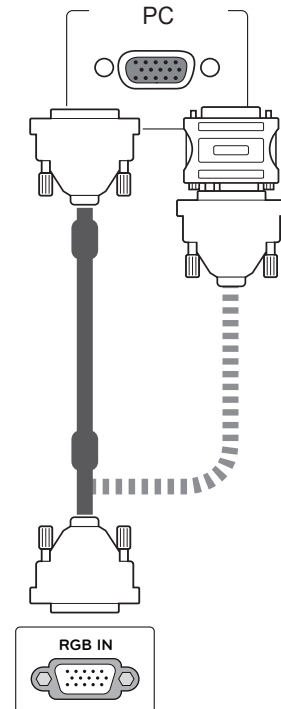

NOTE



- Apple computers may require an adapter to connect to this monitor. Call or visit their web site for more information.



CAUTION

- Do not press the screen with your finger for this damage the screen.
- Avoid displaying a fixed image on the screen for a long period of time to prevent image burn. Use a screensaver if possible.

DVI to DVI connection

Transmits the digital video signal from your PC to the Monitor set. Connect the PC and the Monitor set with the DVI to DVI cable as shown the following illustrations.

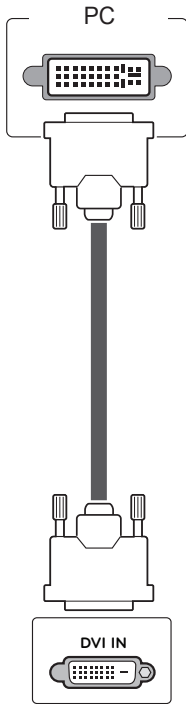

HDMI connection

Transmits the digital video and audio signals from your PC to the Monitor set. Connect the PC and the Monitor set with the HDMI cable as shown in the following illustrations. When using computer input with HDMI, you must set the label of that HDMI input to PC.

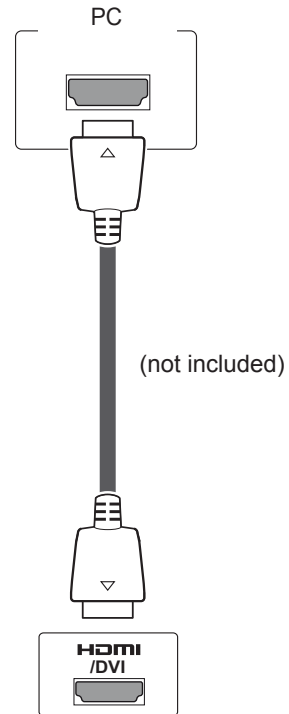

! NOTE

- If you do not use an optional external speaker, connect the PC to the Monitor set with audio cable.
- Use a shielded signal interface cable, such as D-sub 15 pin signal cable and DVI to HDMI cable, with a ferrite core to maintain standard compliance for the product.
- If you want to use HDMI-PC mode, you must set the input label to PC mode.

! NOTE

- Use a High Speed HDMI™ Cable.
- Please check the PC environment if you cannot hear the sound in HDMI mode.
- If you want to use HDMI-PC mode, you must set the input label to PC mode.

Audio connection

Transmits the audio signals from your PC to the Monitor set. Connect the PC and the Monitor set with the Audio cable as shown in the following illustrations. You should set PC as an input label to connect the PC to the Monitor set with an Audio connection.

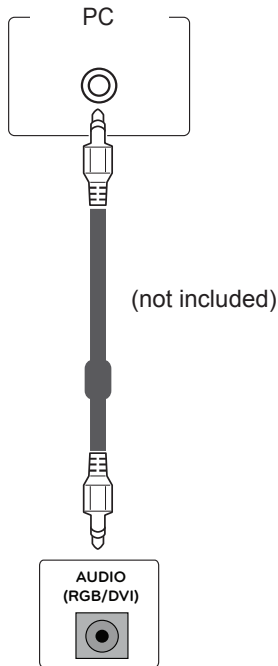

IR Receiver connection

Allows the use of a wired remote or IR receiver extension.



Adjusting the screen

Selecting an image mode

Display images using optimized settings by selecting one of the preset image modes.

- 1 Press **MENU** to access the main menus.
- 2 Press the Navigation buttons to scroll to **PICTURE** and press **OK**.
- 3 Press the Navigation buttons to scroll to **Picture Mode** and press **OK**.
- 4 Press the Navigation buttons to scroll to an image mode you want and press **OK**.

Mode	Description
Vivid	Adjusts the video image for the retail environment by enhancing the Contrast, Brightness, Color, and Sharpness .
Standard	Adjusts the image for the normal environment.
Cinema	Optimizes the video image for the cinematic look and enjoy movies as if you are in a movie theater.
Sports	Optimizes the video image for high and dynamic actions by emphasizing primary Colors such as white, grass, or sky blue.
Game	Optimizes the video image for a fast gaming screen such as PCs or games.

- 5 When you are finished, press **EXIT**. When you return to the previous menu, press **BACK**.

Customizing image options

Customize basic and advanced options of each image mode for the best screen performance.

- 1 Press **MENU** to access the main menus.
- 2 Press the Navigation buttons to scroll to **PICTURE** and press **OK**.
- 3 Press the Navigation buttons to scroll to **Picture Mode** and press **OK**.
- 4 Press the Navigation buttons to scroll to an image mode you want and press **OK**.
- 5 Select and adjust following options, and then press **OK**.

Option	Description
Backlight	Adjusts the brightness of the screen by controlling the LCD backlight. If you decrease the brightness level, the screen becomes darker and the power consumption will be reduced without any video signal loss.
Contrast	Increases or decreases the gradient of the video signal. You may use Contrast when the bright part of the image is saturated.
Brightness	Adjusts the base level of the signal in the image. You may use Brightness when the dark part of the image is saturated.
Sharpness	Adjusts the level of crispness in the edges between the light and dark areas of the picture. The lower the level, the softer the image.
Color	Adjusts intensity of all Colors .
Tint	Adjusts the balance between Red and Green levels.
Color Temperature	Set to warm to enhance hotter Colors such as red, or set to cool to make picture bluish.

Advanced Control	Customizes the advanced options. See more information about advanced options See p.43.
Picture Reset	Restores the options to the default setting.

- When you are finished, press **EXIT**.
When you return to the previous menu, press **BACK**.

Customizing PC display options

Customize options of each image mode for the best image quality.

- This function works in the following mode: RGB[PC] mode.

- Press **MENU** to access the main menus.
- Press the Navigation buttons to scroll to **PICTURE** and press **OK**.
- Press the Navigation buttons to scroll to **Screen** and press **OK**.
- Select and adjust following options, and then press **OK**.

Option	Description
Resolution	Selects a proper Resolution .
Auto Configure	Sets to adjust the screen Position , Size and Phase automatically. The displayed image may be unstable for a few seconds while the configuration is in progress.
Position/ Size/Phase	Adjusts the options when the image is not clear, especially when characters are shaky, after the auto configuration.
Reset	Restores the options to the default setting.

- When you are finished, press **EXIT**.
When you return to the previous menu, press **BACK**.

Adjusting the sound

Selecting an sound mode

Play the sound in its optimized settings by selecting one of the preset sound modes.

- Press **MENU** to access the main menus.
- Press the Navigation buttons to scroll to **AUDIO** and press **OK**.
- Press the Navigation buttons to scroll to **Sound Mode** and press **OK**.
- Press the Navigation buttons to scroll to a sound mode you want and press **OK**.

Mode	Description
Standard	Selects when you want standard-quality sound.
Music	Selects when you listen to music.
Cinema	Selects when you watch movies.
Sports	Selects when you watch sports events.
Game	Selects when you play games.

- When you are finished, press **EXIT**.
When you return to the previous menu, press **BACK**.

Customizing sound options

Customize options of each sound mode for the best sound quality.

- 1 Press **MENU** to access the main menus.
- 2 Press the Navigation buttons to scroll to **AUDIO** and press **OK**.
- 3 Press the Navigation buttons to scroll to **Sound Mode** and press **OK**.
- 4 Press the Navigation buttons to scroll to a sound mode you want and press **OK**.
- 5 Select and adjust following options, and then press **OK**.

Option	Description
Infinite Sound	LG's Infinity Sound option provides 5.1 channel stereo sound from two speakers.
Treble	Controls the dominant sounds in the output. When you turn up the treble, it will increase the output to the higher frequency range.
Bass	Controls the softer sounds in the output. When you turn up the bass, it will increase the output to the lower frequency range.
Reset	Resets the sound mode to the default setting.

- 6 When you are finished, press **EXIT**.
When you return to the previous menu, press **BACK**.

Using additional options

Adjusting aspect ratio

Resize the image to view the image at its optimal size by pressing **ARC** while you are watching Monitor set.



CAUTION

- If a fixed image displays on the screen for a long period of time, it will be imprinted and become a permanent disfigurement on the screen. This is "image burn" or "burn-in" and not covered by the warranty.
- If the aspect ratio is set to 4:3 for a long period of time, image burn may occur on the letterboxed area of the screen.



NOTE

You can also change the image size by accessing the main menus.

- **16:9:** The following selection will allow you to adjust the picture horizontally, in linear proportion, to fill the entire screen (useful for viewing 4:3 formatted DVDs).

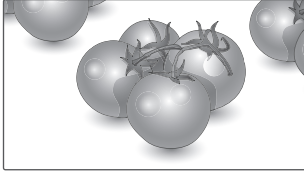

- **Zoom:** The following selection will allow you to view the picture without any alteration, while filling the entire screen. However, the top and bottom of the picture will be cropped.

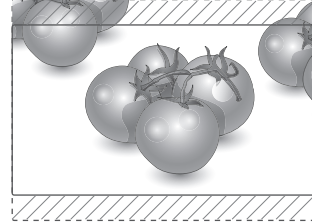

- **Just Scan:** Following Selection will lead to you view the picture of best quality without loss of original picture in high resolution image.
Note: If there is noise in original Picture, You can see the noise at the edge.



- **Cinema Zoom1:** Choose Cinema Zoom when you want to enlarge the picture in correct proportion.
Note: When enlarging or reducing the picture, the image may become distorted.

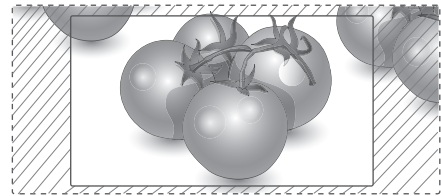

- **4:3:** The following selection will allow you to view a picture with an original 4:3 aspect ratio, gray bars will appear on both the left and right of the screen.

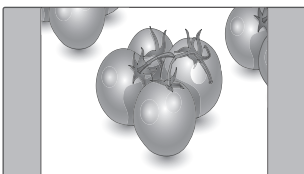

- **< or >** button: Adjust enlarge proportion of Cinema Zoom. The adjustment range is 1 to 16.
- **^ or v** button: Move the screen.

! **NOTE**

- You can only select **16:9, Just Scan, 4:3, Zoom, Cinema Zoom1** in Component and HDMI mode.
- You can only select **4:3, 16:9** in RGB-PC, HDMI-PC mode only.
- In HDMI/DVI-DTV, Component (over 720p) mode, **Just Scan** is available.

ENTERTAINMENT

Connecting to a wired network

(Depending on model)

Connect the display to a local area network (LAN) via the LAN port as shown on the following illustration and set up the network settings.

47WV30 only supports wired network connection. After making a physical connection, a small number of home networks may require the display network settings to be adjusted. For most home networks, the display will connect to automatically without any adjustments.

For detailed information, contact your internet provider or router manual.

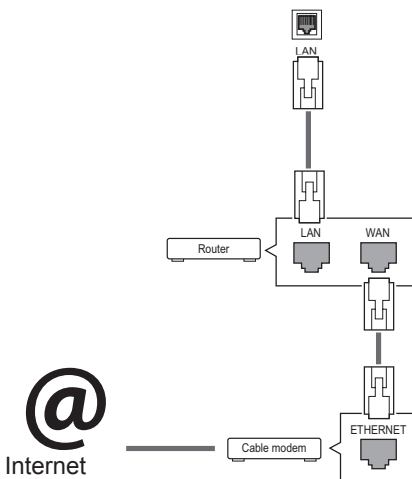

CAUTION

- Do not connect a modular phone cable to the LAN port.
- Since there are various connection methods, please follow the specifications of your telecommunication carrier or internet service provider.

To set up the network settings: (Even if your display has already connected automatically, running setup again will not harm anything),

- 1 Press **MENU** to access the main menus.
- 2 Press the Navigation buttons to scroll to **NETWORK** and press **OK**.
- 3 Press the Navigation buttons to select **Network Setting** and press **OK**.
- 4 If you already set Network Setting, select **Resetting**. The new connection settings resets the current network settings.
- 5 Select **IP Auto Setting** or **IP Manual Setting**.
 - If selecting **IP Manual Setting**, press the Navigation and Number buttons. IP addresses will need to be input manually.
 - **IP Auto Setting**: Select this if there is a DHCP server (Router) on the local area network (LAN) via wired connection, the display will automatically be allocated an IP address. If you're using a broadband router or broadband modem that has a DHCP (Dynamic Host Configuration Protocol) server function. The IP address will automatically be determined.
- 6 When you are finished, press **EXIT**.



CAUTION

- Network setting menu will not be available until the display connected to physical network.
- Since there are various connection methods, please follow the specifications of your telecommunication carrier or internet service provider.

NOTE

- If you want to access the Internet directly on your display, the internet connection should always be on.
- If you cannot access the Internet, check the network conditions from a PC on your network.
- When you use **Network Setting**, check the LAN cable or check if DHCP in the router is turned on.
- If you do not complete the network settings, the network may not work properly.

Tips for Network setting

- Use a standard LAN cable with this display. Cat5 or better with a RJ45 connector.
- Many network connection problems during set up can often be fixed by re-setting the router or modem. After connecting the display to the home network, quickly power off and/or disconnect the power cable of the home network router or cable modem. Then power on and/or connect the power cable again.
- Depending on the internet service provider (ISP), the number of devices that can receive internet service may be limited by the applicable terms of service. For details, contact your ISP.
- LG is not responsible for any malfunction of the display and/or the internet connection feature due to communication errors/malfunctions associated with your internet connection, or other connected equipment.
- LG is not responsible for problems within your internet connection.
- You may experience undesired results if the network connection speed does not meet the requirements of the content being accessed.
- Some internet connection operations may not be possible due to certain restrictions set by the Internet service provider (ISP) supplying your Internet connection.
- Any fees charged by an ISP including, without limitation, connection charges are your responsibility.
- A 10 Base-T or 100 Base-TX LAN port is required when using a wired connection to this display. If your internet service does not allow for such a connection, you will not be able to connect the display.

- A DSL modem is required to use DSL service and a cable modem is required to use cable modem service. Depending on the access method of and subscriber agreement with your ISP, you may not be able to use the internet connection feature contained in this display or you may be limited to the number of devices you can connect at the same time. (If your ISP limits sub-scription to one device, this display may not be allowed to connect when a PC is already connected.)
- The use of a “Router” may not be allowed or its usage may be limited depending on the policies and restrictions of your ISP. For details, contact your ISP directly.

Network Status

- 1 Press **MENU** to access the main menus.
- 2 Press the Navigation buttons to scroll to **NETWORK** and press **OK**.
- 3 Press the Navigation buttons to select **Network Status**.
- 4 Press **OK** to check the network status.
- 5 When you are finished, press **EXIT**.

Option	Description
Setting	Return to the network setting menu.
Test	Test the current network status after setting the network.
Close	Return to the previous menu.

Connecting USB storage devices

Connect USB storage devices such as a USB flash memory, external hard drive to the display and use multimedia features (See "Browsing files" on page 30).

Connect a USB flash memory or USB memory card reader to the Display as shown on the following illustration. The My media screen appears.

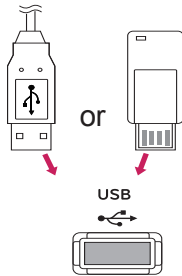

CAUTION

- Do not turn the display off or remove a USB storage device while EMF(my media) Menu is activated, as this could result in loss of files or damage to the USB storage device.
- Back up your files saved on a USB storage device frequently, as you may lose or damage the files and this may be not covered by the warranty.

Tips for using USB storage devices

- Only a USB storage device is recognizable.
- If the USB storage device is connected through a USB hub, the device is not recognizable.
- A USB storage device using an automatic recognition program may not be recognized.
- A USB storage device which uses its own driver may not be recognized.
- The recognition speed of a USB storage device may depend on each device.
- Please do not turn off the display or unplug the USB device when the connected USB storage device is working. When such device is suddenly separated or unplugged, the stored files or the USB storage device may be damaged.
- Please use only a USB storage device which was formatted as a FAT32 file system or NTFS file system provided with the Windows operating system. In case of a storage device formatted as a different utility program which is not supported by Windows, it may not be recognized.
- Please connect power to a USB storage device(over 0.5 A) which requires an external power supply. If not, the device may not be recognized.
- Please connect a USB storage device with the cable provided by the device maker.
- Some USB storage devices may not be supported or operated smoothly.
- File alignment method of USB storage device is similar to Window XP and filename support of up to 100 English characters.
- Be sure to back up important files since data stored in a USB memory device may be damaged. We will not be responsible for any data loss.

- If the USB HDD does not have an external power source, the USB device may not be detected. So be sure to connect the external power source.
 - Please use a power adaptor for an external power source. We do not guarantee an USB cable for an external power source.
- If your USB memory device has multiple partitions, or if you use a USB multi-card reader, you can use up to 4 partitions or USB memory devices.
- If a USB memory device is connected to a USB multi-card reader, its volume data may not be detected.
- If the USB memory device does not work properly, disconnect and reconnect it.
- How fast a USB memory device is detected differs from device to device.
- If the USB is connected in Standby Mode, specific hard disk will automatically be loaded when the display is turned on.
- The recommended capacity is 1 TB or less for a USB external hard disk and 32 GB or less for USB memory.
- Any device with more than the recommended capacity may not work properly.
- If a USB external hard disk with a “Energy Saving” function does not work, turn the hard disk off and on again to make it work properly.
- USB storage devices below USB 2.0 are supported as well. But they may not work properly in the movie list.
- Maximum of 999 folders or files can be recognized under one folder.

Browsing files

Access the photo, music, or movie lists and browse files.

- 1 Connect a USB storage device.
- 2 Press **MENU** to access the main menus.
- 3 Press the Navigation buttons to scroll to **My Media** and press **OK**.
- 4 Press Navigation buttons to scroll to **PHOTO LIST**, **MUSIC LIST**, or **MOVIE LIST** and press **OK**.

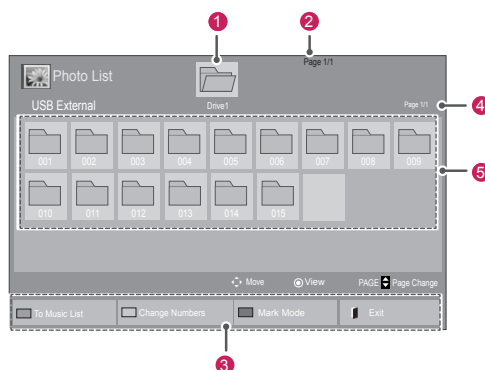
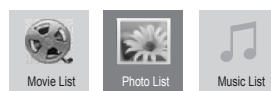

No.	Description
①	Moves to upper level folder
②	Current page/Total pages
③	Corresponding buttons on the remote control
④	Current page/ total pages of contents under the folder focused on ①
⑤	Contents under the folder focused on ①
Button	Description
Green button	Repeatedly, press the GREEN button to converted to Photo List->Music List , Music List->Movie List or Movie List->Photo List .
Yellow button	A method to view in 5 large thumbnail or simple list.
Blue button	Convert to Mark Mode.

Supported file format

Type	Supported file format																
Movie	<p>DAT,MPG,MPEG,VOB,AVI,DIVX,MP4,MKV,TS,TRP,TP,ASF,WMV,FLV)</p> <p>Movie(* .mpg/* .mpeg/* .dat/* .ts/* .trp/* .tp/* .vob/* .mp4/* .mov/* .mkv/* .divx/* .avi/* .asf/* .wmv/* .flv/* .avi(motion-jpeg)/* .mp4(motion-jpeg)/* .mkv(motion-jpeg))supporting file</p> <p>Video format : DivX3.11, DivX4.12, DivX5.x, DivX6, Xvid1.00, Xvid1.01, Xvid1.02, Xvid1.03, Xvid1.10 beta-1/beta-2, Mpeg-1, Mpeg-2, Mpeg-4, H.264/AVC, VC1, JPEG, Sorenson H.263</p> <p>Audio format : Dolby Digital, AAC, Mpeg, MP3, LPCM, HE-AAC, ADPCM, WMA</p> <p>Bit rate : within 32 kbps to 320 kbps(MP3)</p> <p>External Subtitle format : *.smi/* .srt/* .sub (MicroDVD,Subviewer1.0/2.0)/* .ass/* .ssa/* .txt(TMPlayer)/* .psb(PowerDivX)</p> <p>Internal Subtitle format : only, XSUB (It is the subtitle format used in DivX6 files)</p>																
Photo	<p>JPEG</p> <p>Baseline : 64 x 64 to 15360 x 8640 Progressive : 64 x 64 to 1920 x 1440</p> <ul style="list-style-type: none"> You can play JPEG files only. Non-supported files are displayed in the form of predefined icon. <p>Only 3D Models</p> <table border="1"> <thead> <tr> <th></th> <th>File Extensions</th> <th>Item</th> <th>Profile</th> </tr> </thead> <tbody> <tr> <td rowspan="2">2D</td> <td rowspan="2">jpeg jpg jpe</td> <td>supported file format</td> <td> <ul style="list-style-type: none"> SOF0: baseline SOF1: Extend Sequential SOF2: Progressive </td> </tr> <tr> <td>photo size</td> <td> <ul style="list-style-type: none"> Min: 64 X 64 Max-Normal Type: 15360 (W) X 8640 (H) Progressive Type: 1920 (W) X 1440 (H) </td> </tr> <tr> <td rowspan="2">3D</td> <td rowspan="2">mpo</td> <td>supported file format</td> <td>mpo</td> </tr> <tr> <td>photo size</td> <td> <ul style="list-style-type: none"> 4:3 size: 3,648 x 2,736 2,592 x 1,944 2,048 x 1,536 3:2 size: 3,648 x 2,432 </td> </tr> </tbody> </table>		File Extensions	Item	Profile	2D	jpeg jpg jpe	supported file format	<ul style="list-style-type: none"> SOF0: baseline SOF1: Extend Sequential SOF2: Progressive 	photo size	<ul style="list-style-type: none"> Min: 64 X 64 Max-Normal Type: 15360 (W) X 8640 (H) Progressive Type: 1920 (W) X 1440 (H) 	3D	mpo	supported file format	mpo	photo size	<ul style="list-style-type: none"> 4:3 size: 3,648 x 2,736 2,592 x 1,944 2,048 x 1,536 3:2 size: 3,648 x 2,432
	File Extensions	Item	Profile														
2D	jpeg jpg jpe	supported file format	<ul style="list-style-type: none"> SOF0: baseline SOF1: Extend Sequential SOF2: Progressive 														
		photo size	<ul style="list-style-type: none"> Min: 64 X 64 Max-Normal Type: 15360 (W) X 8640 (H) Progressive Type: 1920 (W) X 1440 (H) 														
3D	mpo	supported file format	mpo														
		photo size	<ul style="list-style-type: none"> 4:3 size: 3,648 x 2,736 2,592 x 1,944 2,048 x 1,536 3:2 size: 3,648 x 2,432 														

Music	<p>MP3</p> <p>Bit rate 32 to 320</p> <ul style="list-style-type: none"> Sampling rate MPEG1 Layer3 : 32 kHz, 44.1 kHz, 48 kHz Sampling rate MPEG2 Layer3 : 16 kHz, 22.05 kHz, 24 kHz Sampling rate MPEG2.5 Layer3 : 8 kHz, 11.025 kHz, 12 kHz
--------------	--

Viewing movies

This display will play media files from a USB drive or a DLNA server on your network.

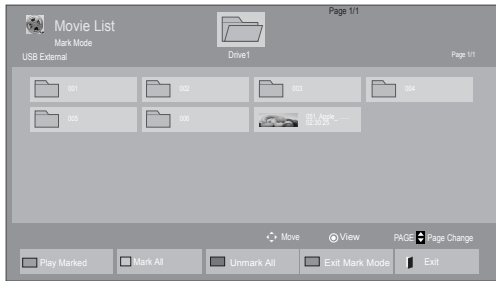
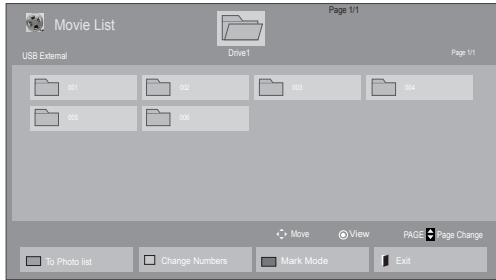

- 1 Press the Navigation buttons to scroll to **My Media** and press **OK**.
- 2 Press the Navigation buttons to scroll to **Movie List** and press **OK**.
- 3 Press the Navigation buttons to scroll to a folder you want and press **OK**.
- 4 Press the Navigation buttons to scroll to a file you want and press **OK**.



Menu	Description
Play Marked	Play the selected movie file. Once a movie file finishes playing, the next selected one will be played automatically.
Mark All	Mark all movie files on the screen.
Unmark All	Deselect all marked movie files.
Exit Mark Mode	Exit the Mark Mode.





5 Play a movie.

NOTE

- Non-supported files are displayed the preview image by icon only .
- Abnormal files are displayed in the form of bitmap .

6 Control playback by using the following buttons.



Button	Description
	Stops the playback
	Plays a video
	Pauses or resumes the playback
	Scans backward in a file
	Scans forward in a file
MENU	Show the Option menu.
BACK	Hide the menu on the full-sized screen.
EXIT	Return to Movie List .
< or >	Skips to specific points in a file during playback. The time of a specific point will appear on the status bar. In some files, this function may not work properly.
ENERGY SAVING	Press the ENERGY SAVING button repeatedly to increase the brightness of your screen.
AV MODE	Press the AV MODE button repeatedly to select the desired source.

Tips for using playing video files

- Some user-created subtitles may not work properly.
- Some special characters are not supported in subtitles.
- HTML tags are not supported in subtitles.
- Subtitles in languages other than the supported languages are not available.
- The screen may suffer temporary interruptions (image stoppage, faster playback, etc.) when the audio language is changed.
- A damaged movie file may not be played correctly, or some player functions may not be usable.
- Movie files produced with some encoders may not be played correctly.
- If the video and audio structure of recorded file is not interleaved, either video or audio is outputted.
- HD videos with a maximum of 1920x1080@25/30P or 1280x720@50/60P are supported, depending on the frame.
- Videos with resolutions higher than 1920x1080@25/30P or 1280x720@50/60P may not work properly depending on the frame.
- Movie files other than the specified types and formats may not work properly.
- Max bitrate of playable movie file is 20 Mbps. (only, Motion JPEG : 10 Mbps)
- We do not guarantee smooth playback of profiles encoded level 4.1 or higher in H.264/AVC.
- DTS Audio codec is not supported.
- A movie file more than 30 GB in file size is not supported for playback.
- A DivX movie file and its subtitle file must be located in the same folder.
- A video file name and its subtitle file name must be identical for it to be displayed.
- Playing a video via a USB connection that doesn't support high speed may not work properly.
- Files encoded with GMC(Global Motion Compensation) may not be played.

- When you are watching the movie by Movie List function, you can adjust an image by Energy Saving key on the remote control. User setup for each image mode does not operate.

Video options

- 1 Press **MENU** to access the **Pop-Up** menus.
- 2 Press the Navigation buttons to scroll to **Set Video Play., Set Video.** or **Set Audio.** and press **OK**.

NOTE

- Option values changed in **Movie List** does not affect **Photo List** and **Music List**.
- Option value changed in **Photo List** and **Music List** are changed likewise in **Photo List** and **Music List** excluding **Movie List**.
- When replaying the video file after stopping, you can play from where it stopped previously.

When you select the **Set Video Play**,

- 1 Press the Navigation buttons to scroll to show the **Picture Size, Audio Language, Subtitle Language** or **Repeat**.
- 2 Press the Navigation buttons to scroll to make appropriate adjustments.

Menu	Description
Picture Size	Selects your desired picture format during movie play.
Audio Language	Changes the Language Group of the audio during movie play. Files with a single audio track cannot be selected.
Subtitle Language	Turn on/off the subtitle.
Language	Activated for SMI subtitle and can select the language within the subtitle.
Code Page	Can select the font for subtitle. When set to default, same font as general menu will be used.
Sync	Adjusts the time synchronisation of the subtitle from -10 secs to +10 secs by steps of 0.5 secs during movie play.
Position	Changes the position of the subtitle either up or down during movie play.
Size	Selects your desired Subtitle size during movie play.

Repeat	Turn on/off repeat function of movie playback. When turned on, the file within the folder will be played back repeatedly. Even when the repeated playback is turned off, it can run the playback if the file name is similar to the previous file.
---------------	--

Code Page	Support Language
Latin1	English, Spanish, French, German, Italian, Swedish, Finnish, Dutch, Portuguese, Danish, Romanian, Norwegian, Albanian, Gaelic, Welsh, Irish, Catalan, Valencian
Latin2	Bosnian, Polish, Croatian, Czech, Slovak, Slovenian, Serbian, Hungarian
Latin4	Estonian, Latvian, Lithuanian
Cyrillic	Bulgarian, Macedonian, Russian, Ukrainian, Kazakh
Greek	Greek
Turkish	Turkish



NOTE

- Only 10,000 of sync blocks can be supported within the subtitle file.
- When playing a video, you can adjust the Picture Size by pressing the RATIO button.
- Subtitles in your language are only supported when the OSD menu is also in this language.
- The code page options may be disabled depending on the language of the subtitle files.
- Select the appropriate code page for the subtitle files.

When you select the **Set Video**,

- 1 Press the Navigation buttons to scroll to make appropriate adjustments.

When you select the **Set Audio**,

- 1 Press the Navigation buttons to scroll to show the **Sound Mode**, **Clear Voice II** or **Balance**.
- 2 Press the Navigation buttons to scroll to make appropriate adjustments.

Viewing photos

View image files saved in a USB storage device. The displays on the screen may differ from the model.

- 1 Press the Navigation buttons to scroll to **My Media** and press **OK**.
- 2 Press the Navigation buttons to scroll to **Photo List** and press **OK**.
- 3 Press the Navigation buttons to scroll to a folder you want and press **OK**.
- 4 Press the Navigation buttons to scroll to a file you want and press **OK**.

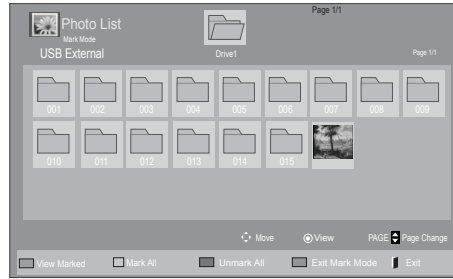
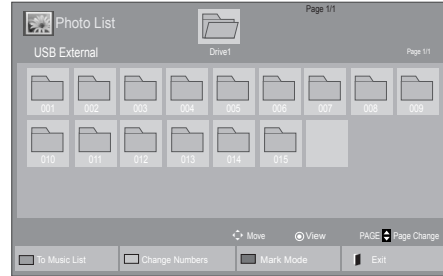

Menu	Description
View Marked	Display the selected photo file.
Mark All	Mark all photo files on the screen.
Unmark All	Deselect all marked photo files.
Exit Mark Mode	Exit the Mark Mode.

- 5 View photos.

NOTE

- Non-supported files are displayed the pre-view image by icon only
- Abnormal files are displayed in the form of bitmap

Using photo options

Use the following options while viewing photos.



Options

Number of selected photos

Option	Description
Slideshow	Starts or stops a slideshow with selected photos. If there are no selected photos, all photos saved in the current folder display during a slideshow. To set a slideshow speed, select Option .
BGM	Turns the background music on or off. To set the background music folder, select Option . You can adjust Option by MENU button on the remote control.
⤵ (Rotate)	Rotates photos clockwise (90°, 180°, 270°, 360°). <div style="border: 1px solid black; padding: 5px;"> <p>NOTE</p> <ul style="list-style-type: none"> The supported photo size is limited. You cannot rotate a photo if the resolution of the rotated width is larger than the supported resolution size. </div>
🔍	View the photo by zoom in 2, 4 times.

ENERGY SAVING	Press the ENERGY SAVING button repeatedly to change the brightness of your screen.
Option	<ul style="list-style-type: none"> Slide Speed: Selects a slideshow speed (Fast, Medium, Slow). BGM: Selects a music folder for the background music. <div style="border: 1px solid black; padding: 5px; margin-top: 10px;"> <p>NOTE</p> <ul style="list-style-type: none"> You cannot change the music folder while the background music is playing. You can only select the MP3 folder saved on the device that currently displays the photo. </div>
Hide	Hides the option window. To display the options, press OK .
EXIT	Return to Photo List .

Photo options

- 1 Press **MENU** to show the **Option** menus.
- 2 Press the Navigation buttons to scroll to **Set Photo View.**, **Set Video.** or **Set Audio.** and press **OK**.

NOTE

- Option values changed in **Movie List** does not affect **Photo List** and **Music List**.
- Option value changed in **Photo List** and **Music List** are changed likewise in **Photo List** and **Music List** excluding **Movie List**.

When you select the **Set Photo View**,

- 1 Press the Navigation buttons to scroll to select **Slide Speed** or **BGM..**
- 2 Press the Navigation buttons to scroll to make appropriate adjustments.

When you select the **Set Video**,

- 1 Press the Navigation buttons to scroll to make appropriate adjustments.

When you select the **Set Audio**,

- 1 Press the Navigation buttons to scroll to show the **Sound Mode**, **Clear Voice II** or **Balance**.
- 2 Press the Navigation buttons to scroll to make appropriate adjustments.

Listening to music

- 1 Press the Navigation buttons to scroll to **My Media** and press **OK**.
- 2 Press the Navigation buttons to scroll to **Music List** and press **OK**.
- 3 Press the Navigation buttons to scroll to a folder you want and press **OK**.
- 4 Press the Navigation buttons to scroll to a file you want and press **OK**.

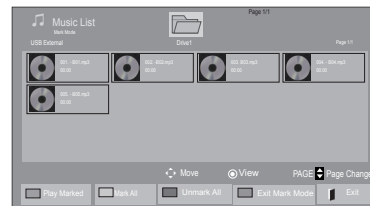
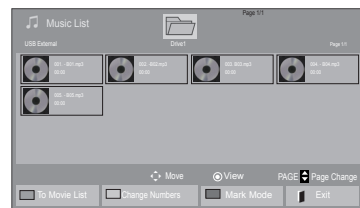

Menu	Description
Play Marked	Display the selected music file.
Mark All	Mark all music files on the screen.
Unmark All	Deselect all marked music files.
Exit Mark Mode	Exit the Mark Mode.

- 5 Play music.

6 Control playback by using the following buttons.

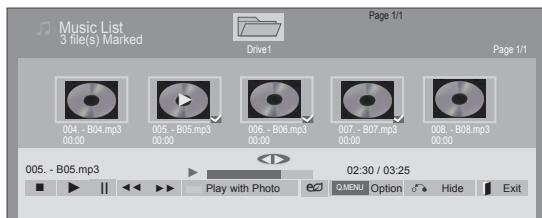

Button	Description
	Stops playback
	Plays a music file
	Pauses or resumes playback
	Skips to the next file
	Skips to the previous file
or	When playing, When you press the button, the previous music file will be played. When you press the button, the next music file will be played.
Green button	Start playing the selected music files and then move to the Photo List .
ENERGY SAVING	Press the ENERGY SAVING button repeatedly to change the brightness of your screen.
MENU	Show the Option menu.
Hide	Hides the option window. To display the options, press OK .
EXIT	When you press the EXIT button while the Music player is displayed, only the music will be stopped and the player will not return to normal viewing. When you press the EXIT button while the music is stopped or while the music player is hidden, the player will return to normal viewing.
< or >	When using the < or > button during playback a cursor indicating the position can be played.

Tips for playing music files

- This unit cannot support the ID3 Tag embedded MP3 files.

! NOTE

- Non-supported files are displayed the preview image by icon only
- Abnormal files are displayed in the form of bitmap
- A damaged or corrupted music does not play but displays 00:00 in playtime.
- A music downloaded from a paid service with copyright protection does not start but displays inappropriate information in playtime.
- If you press OK, buttons, screen saver is stopped.
- The PLAY() , Pause() , , ,
- You can use the button to select the next music and the button to select the previous music.



Music options

- 1 Press **MENU** to access the **Pop-Up** menus.
- 2 Press the Navigation buttons to scroll to **Set Audio Play.** or **Set Audio.** and press **OK**.

! NOTE

- Option values changed in **Movie List** does not affect **Photo List** and **Music List**.
- Option value changed in **Photo List** and **Music List** are changed likewise in **Photo List** and **Music List** excluding **Movie List**.

When you select the **Set Audio Play.**,

- 1 Press the Navigation buttons to scroll to select the **Repeat** or **Random**.
- 2 Press the Navigation buttons to scroll to make appropriate adjustments.

When you select the **Set Audio.**,

- 1 Press the Navigation buttons to scroll to select the **Sound Mode**, **Clear Voice II** or **Balance**.
- 2 Press the Navigation buttons to scroll to make appropriate adjustments.

DivX registration code

Registering the DivX code

Check and register the DivX registration code of your display so that you can rent or purchase the latest movies at www.divx.com/vod. To play a rented or purchased DivX file, the file's registration code should be same with your Display's DivX registration code.

- 1 Press **MENU** to access the main menus.
- 2 Press the Navigation buttons to scroll to **MY MEDIA** and press **OK**.
- 3 Press the Blue button.
- 4 Press the Navigation buttons to scroll to **DivX Reg. Code** and press **OK**.
- 5 View the registration code of your display.
- 6 When you are finished, press **EXIT**.
When you return to the previous menu, press **BACK**.

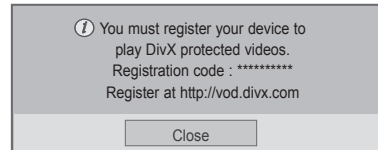

! NOTE

- Movie files are supported as follows
Resolution : under 1920x1080 WxH pixels
Frame rate : under 30 frames/sec(1920x1080), under 60 frames/sec(under 1280x720)
- Video Codec : MPEG 1, MPEG 2, MPEG 4, H.264/AVC, DivX 3.11, DivX 4.12, DivX 5.x, DivX 6, Xvid 1.00, Xvid 1.01, Xvid 1.02, Xvid 1.03, Xvid 1.10-beta1, Xvid 1.10-beta2, JPEG, VC1, Sorenson H.263/H.264.

Deactivating the DivX feature

Deactivate all of the devices through the web server and block devices from activating.

Delete the existing authentication information to receive a new DivX user authentication for the display. Once this function is executed, a DivX user authentication is required again to see DivX DRM files.

- 1 Press **MENU** to access the main menus.
- 2 Press the Navigation buttons to scroll to **MY MEDIA** and press **OK**.
- 3 Press the Blue button.
- 4 Press the Navigation buttons to scroll to **Deactivation** and press **OK**.
- 5 Press the Navigation buttons to select **Yes** to confirm.

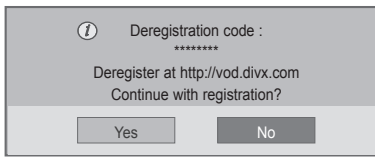

- 6 When you are finished, press **EXIT**.
When you return to the previous menu, press **BACK**.

NOTE

- If you do not use an optional external speaker, connect the PC to the Monitor set with the supplied audio cable.
- If you turn the Monitor set on when the set becomes cold, the screen may flicker. This is normal.
- Some red, green, or blue spots may appear on the screen. This is normal.

CUSTOMIZING SETTINGS

Accessing main menus

- 1 Press **MENU** to access the main menus.
- 2 Press the Navigation buttons to scroll to one of the following menus and press **OK**.
- 3 Press the Navigation buttons to scroll to the setting or option you want and press **OK**.
- 4 When you are finished, press **EXIT**.
When you return to the previous menu, press **BACK**.

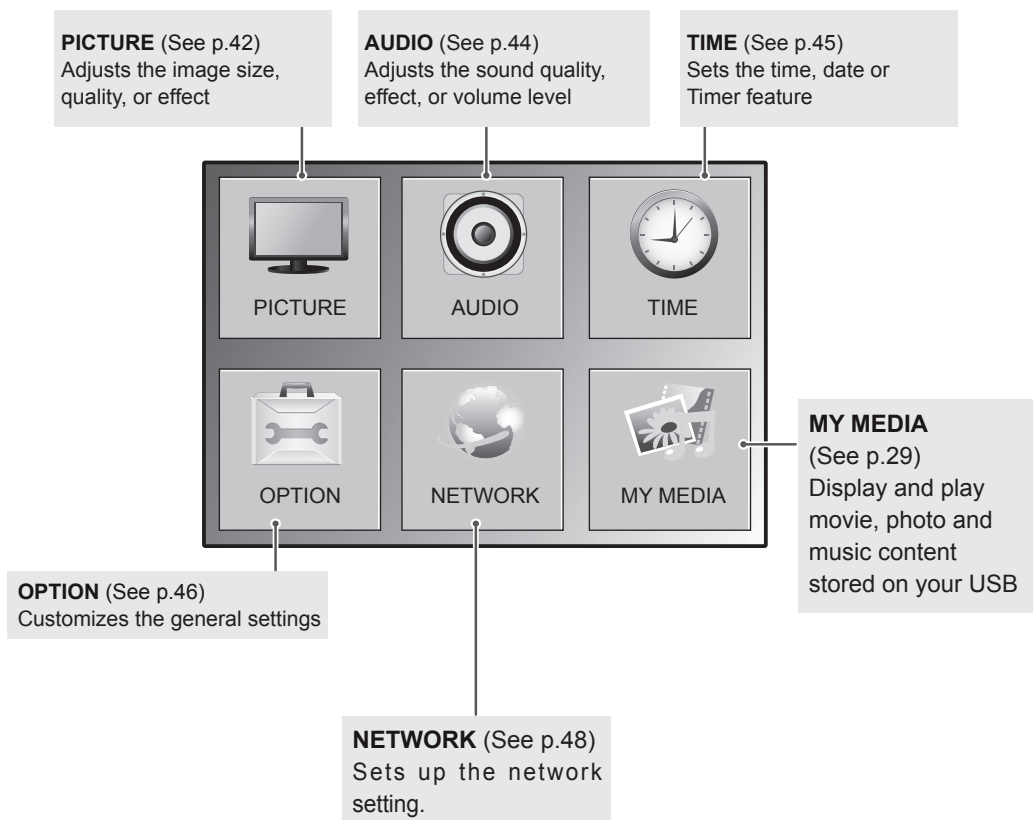

PICTURE settings

- 1 Press **MENU** to access the main menus.
- 2 Press the Navigation buttons to scroll to **PICTURE** and press **OK**.
- 3 Press the Navigation buttons to scroll to the setting or option you want and press **OK**.
 - To return to the previous level, press **BACK**.
- 4 When you are finished, press **EXIT**.
When you return to the previous menu, press **BACK**.

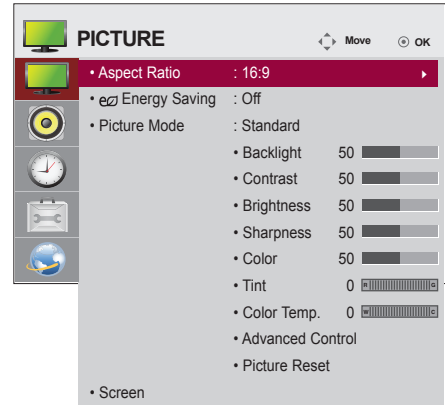

The available picture settings are described in the following:

Setting	Description
Aspect Ratio	Changes the image size to view images at its optimal size (See p.25).
Energy Saving	Sets to automatically adjust the screen brightness corresponding to the surroundings.
	Option
	Off The backlight is off.
	Minimum/ Medium/ Maximum Selects the brightness level of the backlight.
	Screen off The screen turns off in 3 seconds.
Picture Mode	Selects one of the preset image or customizes options in each mode for the best Monitor set screen performance. You are also able to customize advanced options of each mode. The available preset picture modes vary depending on the Monitor set .
	Mode
	Vivid Adjusts the video image for the retail environment by enhancing the contrast, brightness, Color, and sharpness.
	Standard Adjusts the image for the normal environment.
	Cinema Optimizes the video image for a cinematic look to enjoy movies as if you are in a movie theater.
	Sport Optimizes the video image for high and dynamic actions by emphasizing primary Colors such as white, grass, or sky blue.
	Game Optimizes the video image for a fast gaming screen such as PCs or games.
SCREEN (In RGB-PC Mode Only)	This option is enabled only when Input Select is set to Analog (RGB-PC) and the resolution is set to 1024x768, 1280x768, 1360x768 or 1366x768 on your PC.
	Option
	Resolution Selects a proper resolution. See "Specification" See p.55 for the recommended resolution for each model.
	Auto Configure Sets to adjust the screen position, clock, and phase automatically. The displayed image may be unstable for a few seconds while the configuration is in progress.
	Position/Size/ Phase Adjusts the options when the picture is not clear, especially when characters are shaky, after the auto configuration.
	Reset Restores the options to the default setting.

Basic image options

Setting	Description
Backlight	Adjusts the brightness of the screen by controlling the LCD backlight. If you decrease the brightness level, the screen becomes darker and the power consumption will be reduced without any video signal loss.
Contrast	Increases or decreases the gradient of the video signal. You may use Contrast when the bright part of the picture is saturated.
Brightness	Adjusts the base level of the signal in the picture. You may use Brightness when the dark part of the picture is saturated.
Sharpness	Adjusts the level of crispness in the edges between the light and dark areas of the picture. The lower the level, the softer the image.
Color	Adjusts intensity of all Colors.
Tint	Adjusts the balance between red and green levels.
Color Temperature	Set to warm to enhance hotter Colors such as red, or set to cool to make picture bluish.
Advanced Control	Customizes the advanced options.
Picture Reset	Restores the options to the default setting.

Advanced image options

Setting	Description
Dynamic Contrast (Off/Low/Medium/High)	Optimizes the contrast automatically according to the brightness of the reflection. (This function can be used only under Component.)
Dynamic Color (Off/Low/High)	Adjusts the Color of the reflection automatically to reproduce natural colours as close as possible. (This function can be used only under Component.)
Clear White (Off/Low/High)	Make the white area of screen brighter and more white.
Skin Color	It detects the skin area of video and adjusts it to express a natural skin color.
Noise Reduction (Off/Low/Medium/High)	Removing the noise up to the point where it does not damage the original picture. (This function can be used only under Component.)
Digital Noise Reduction (Off/Low/Medium/High)	This option reduces the noise produced while creating digital video signals.
Gamma (Low/Medium/High)	Set your own gamma value. On the monitor, high gamma values display whitish images and low gamma values display high contrast images.
Black Level Low/High	<ul style="list-style-type: none"> • Low: The reflection of the screen gets darker. • High: The reflection of the screen gets brighter. Function works in the following mode - Component, HDMI, DVI-D adjusts the contrast and the brightness of the screen using the black level of the screen.

AUDIO settings

- 1 Press **MENU** to access the main menus.
- 2 Press the Navigation buttons to scroll to **AUDIO** and press **OK**.
- 3 Press the Navigation buttons to scroll to the setting or option you want and press **OK**.
 - To return to the previous level, press **BACK**.
- 4 When you are finished, press **EXIT**.
When you return to the previous menu, press **BACK**.

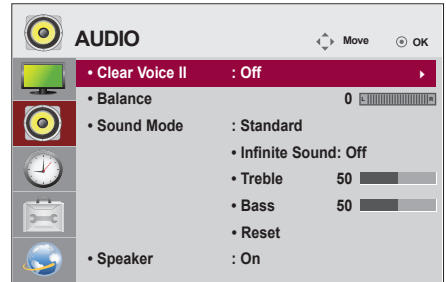

The available audio options are described in the following:

Setting	Description
Clear Voice II	By differentiating the human sound range from others, it helps users listen to human voices better.
Balance	Use this function to balance sound from the left and right speakers.
Sound Mode	The best sound tone quality will be selected automatically depending on the video type that you're currently watching.
Mode	
Standard	The most commanding and natural audio.
Music	Select this option to enjoy the original sound when listening to the music.
Cinema	Select this option to enjoy sublime sound.
Sports	Select this option to watch sports broadcasting.
Game	To enjoy dynamic sound when playing a game.
<div style="border: 1px solid gray; padding: 10px; margin: 10px 0;"> <p>NOTE</p> <p>If sound quality or volume is not at the level you want, it is recommended to use a separate home theater system or amplifier to cope with different user environments.</p> </div>	
Option	
Infinite Sound	LG's Infinity Sound option provides 5.1 channel stereo sound from two speakers.
Treble	Controls the dominant sounds in the output. When you turn up the treble, it will increase the output to the higher frequency range.
Bass	Controls the softer sounds in the output. When you turn up the bass, it will increase the output to the lower frequency range.
Reset	Resets the sound mode to the default setting.
Speaker	Turns on the internal speaker of the set when using an external Hi-Fi system. You can use the speaker as an audio output device even if there is no video input.

TIME settings

- 1 Press **MENU** to access the main menus.
- 2 Press the Navigation buttons to scroll to **TIME** and press **OK**.
- 3 Press the Navigation buttons to scroll to the setting or option you want and press **OK**.
 - To return to the previous level, press **BACK**.
- 4 When you are finished, press **EXIT**.
When you return to the previous menu, press **BACK**.

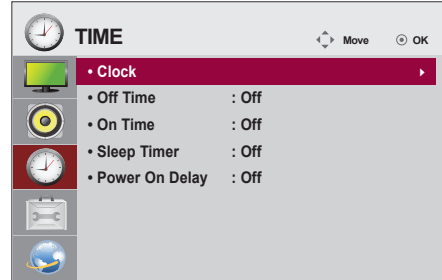

The available time settings are described in the following:

Setting	Description
Clock	If the current time is incorrect, reset the clock manually. 1) Press the MENU button and then use $\wedge \vee < >$ button to select the TIME menu,input OK button to enter. 2) Press the $>$ button and then use $\wedge \vee$ button to select Clock menu. 3) Press the $>$ button and then use $< >$ button to select date 4) Press the $\wedge \vee$ button and then use $< >$ button to set the hour(00h to 23h). 5) Press the $\wedge \vee$ button and then use $< >$ button to set the minutes(00 min to 59 min).
On/Off Time	The off time automatically switches the set to standby at the pre-set time. 1) Press the MENU button and then use $\wedge \vee < >$ button to select the TIME menu,input OK button to enter. 2) Press the $>$ button and then use $\wedge \vee$ button to select On/Off Timer . 3) Press the $>$ button and then use $< >$ button to select date 4) Press the $\wedge \vee$ button and then use $< >$ button to set the hour(00h to 23h). 5) Press the $\wedge \vee$ button and then use $< >$ button to set the minutes(00 min to 59 min). 6) Press the $\wedge \vee$ button ,According to the personal needs, choose to add button.
Sleep Timer	The power is automatically turned off when the time set by a user is passed. 1) Press the MENU button and then use $\wedge \vee < >$ button to select the TIME menu,input OK button to enter 2) Press the $>$ button and then use $\wedge \vee$ button to select Sleep Timer menu. 3) Press the $\wedge \vee$ button and then use \vee button to select the minutes(Off to 240 min).
Power on delay	When connecting multiple monitors and turning the power on, the monitors are turned on individually to prevent overload.

OPTION settings

- 1 Press **MENU** to access the main menus.
- 2 Press the Navigation buttons to scroll to **OPTION** and press **OK**.
- 3 Press the Navigation buttons to scroll to the setting or option you want and press **OK**.
 - To return to the previous level, press **BACK**.
- 4 When you are finished, press **EXIT**.
When you return to the previous menu, press **BACK**.

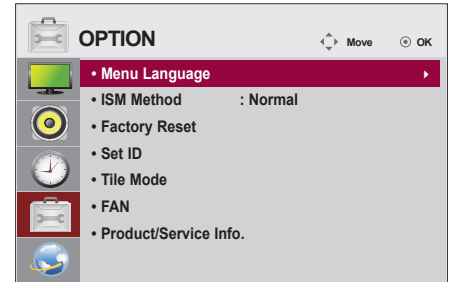

The available option settings are described in the following:

Setting	Description
Menu Language	To choose the language in which the control names are displayed.
ISM Method	Leaving a fixed image on the screen for a long time may cause damage to the screen and cause image burn-in. To use the product for a long period of time, use a screen saver on the PC or utilize the residual image prevention function on the product, and when the product is not used, turn off the power. Burn-in and related problems are not covered by the warranty on this product.
	Setting
	Normal Sets it if image sticking is never a problem
	White wash Removes a ghost image on the screen. Use sparingly. Watch the sets normally for a while before using this feature to see if the ghost image disappears on its own.
	Color wash Removes a ghost image on the screen. The color block with the screen moved a little and the white pattern are alternately displayed. It is difficult to see the after image on all colors. Once it has been corrected it will not be visible in any color.
Factory Reset	Select this option to return to the default factory settings.
Set ID	You can assign a unique Set ID NO (name assignment) to each product when several products are connected for display. Specify the number (1 to Total Set ID) using the button and exit. Use the assigned Set ID to individually control each product using the Product Control Program.
	<div style="border: 1px solid black; padding: 10px;"> <p>NOTE</p> <p>If you change SET ID No, the value of 'Power On Delay' will be set to (SET ID No)/3(sec) to prevent power consumption overload. ex) SET ID No = 31 → Power On Delay = 10(=31/3)</p> </div>

Setting	Description	
Tile Mode	Setting	
	Tile Mode	You can display the image on multiple sets and view it in a larger size. To use the Tile Mode on multiple sets with same signal.
	Auto Config.	This option optimizes the screen when you connect the set to a new computer or change to a different mode. If you are not satisfied with the adjustment, you can manually change the "Position" or "Size".
	Position	You can set the position.
	Size	You can set the size.
	Natural	The image is omitted by the distance between the screens to be naturally shown.
	Reset	Function to initialize and release Tile. All Tile setting are released when selecting Tile recall and the screen returns to Full screen.
FAN	Setting	
	Mode	This option indicates the monitor's internal temperature and controls the fan. <ul style="list-style-type: none"> • Auto: Switches the fan on and off according to the set temperature. • On: The fan is always switched on. • Manual: Switches the fan on and off according to user settings.
	Hysteresis	The difference in temperature between when the fan is switched on and when it is off.
	Set Temperature	Set the temperature at which the fan is switched on.
	Current Temperature	Current temperature inside the set.
	 NOTE We recommend that you use the Auto mode to prevent any malfunctions resulting from incorrect fan settings.	
Product/Service Info.	This option shows information about the set.	

NETWORK settings

- 1 Press **MENU** to access the main menus.
- 2 Press the Navigation buttons to scroll to **NETWORK** and press **OK**.
- 3 Press the Navigation buttons to scroll to the setting or option you want and press **OK**.
 - To return to the previous level, press **BACK**.
- 4 When you are finished, press **EXIT**.
 - When you return to the previous menu, press **BACK**.

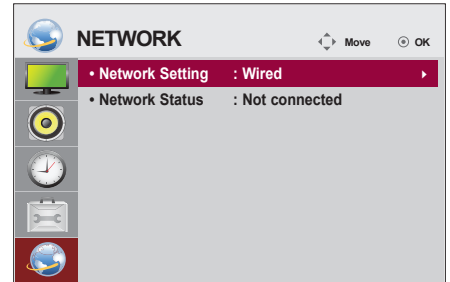

The available option settings are described in the following:

Setting	Description
Network Setting	Configure the network settings.(See p.27)
Network Status	Display the network status.(See p.28)



NOTE

- Network setting menu will not be available until the display connected to physical network.

MAKING CONNECTIONS

Connect various external devices to the ports on the Monitor set's back panel.

- 1 Find an external device you want to connect to your Monitor set shown in the following illustration.
- 2 Check the connection type of the external device.
- 3 Go to the appropriate illustration and check the connection details.

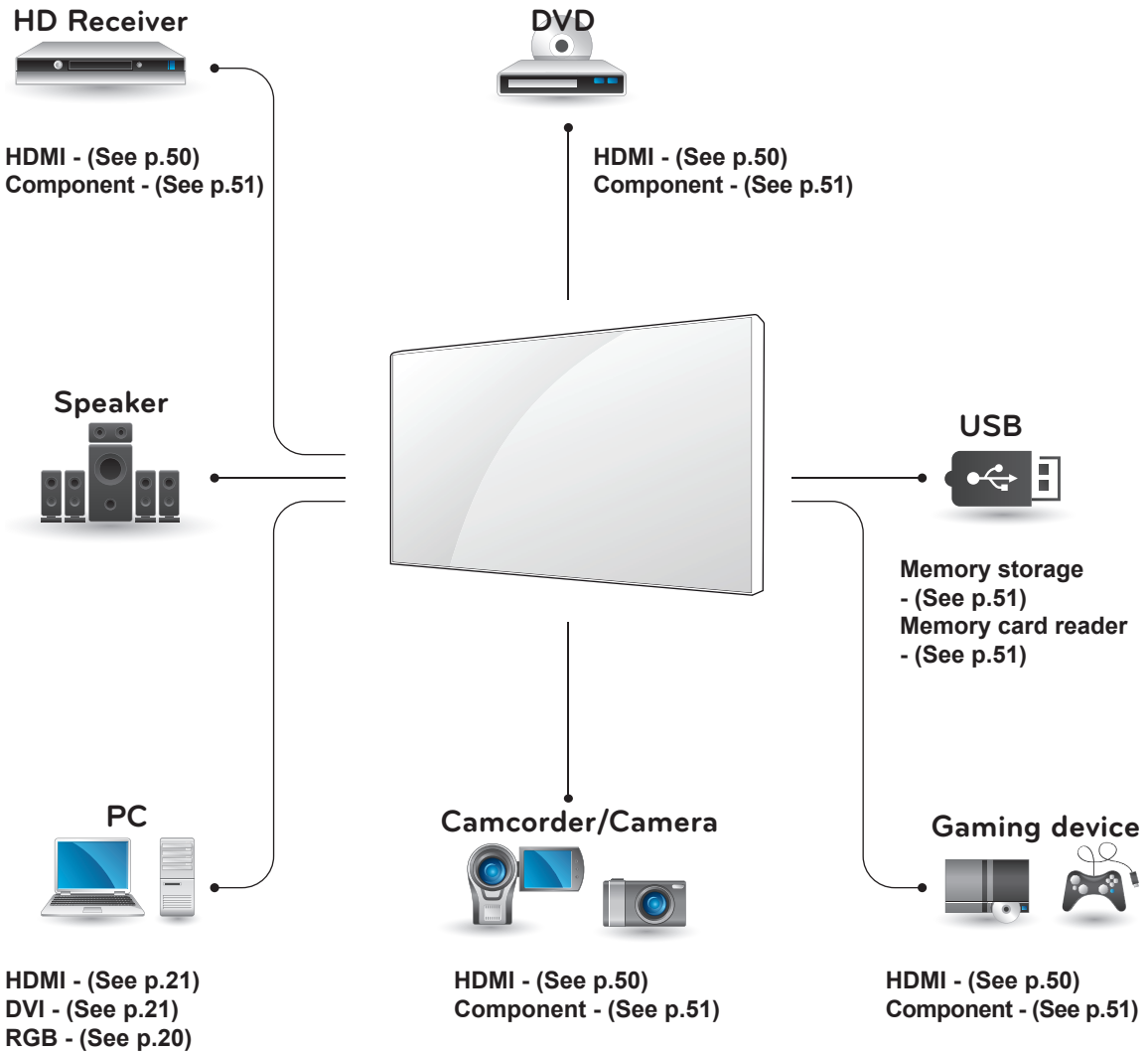

NOTE

If you connect a gaming device to the Monitor set, use the cable supplied with the gaming device.

Connecting to a HD receiver, DVD or VCR player

Connect a HD receiver, DVD, or VCR player to the Monitor set and select an appropriate input mode.

HDMI connection

Transmits the digital video and audio signals from an external device to the Monitor set. Connect the external device and the Monitor set with the HDMI cable as shown on the following illustration.

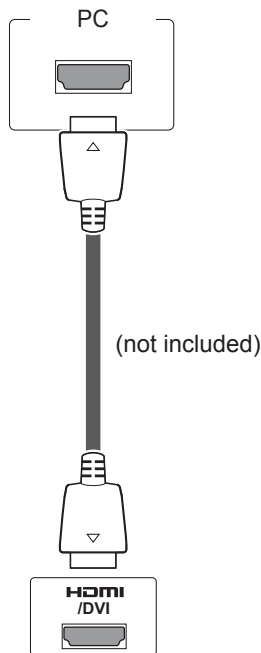

DVI - HDMI connection

Transmits the digital video signal from an external device to the Monitor set. Connect the external device and the Monitor set with the DVI-HDMI cable as shown in the following illustration. To transmit an audio signal, connect an optional audio cable.

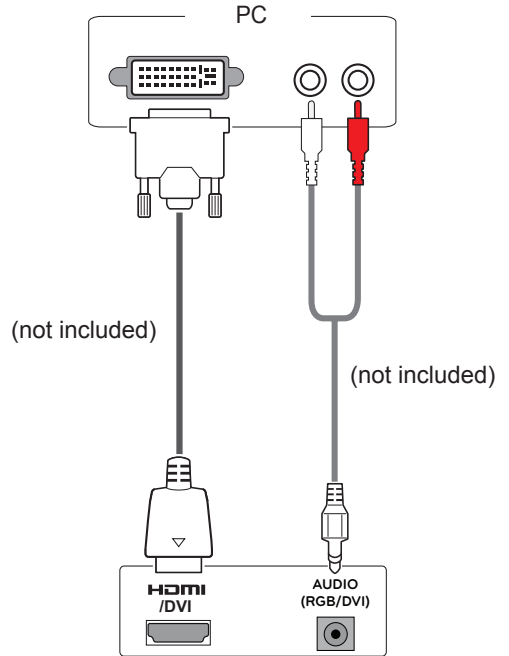

NOTE

- Use a High Speed HDMI™ Cable.
- High Speed HDMI™ Cables are tested to carry an HD signal up to 1080p and higher.
- Dolby Digital is not supported.



CAUTION

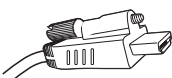

- When connecting an HDMI cable as illustrated, remove the screw on the HDMI connector first.

AV connection

Transmits the analog video and audio signals from an external device to the Monitor set. Connect the external device and the Monitor set with a component video cable and composite audio cable as shown on the following illustration.

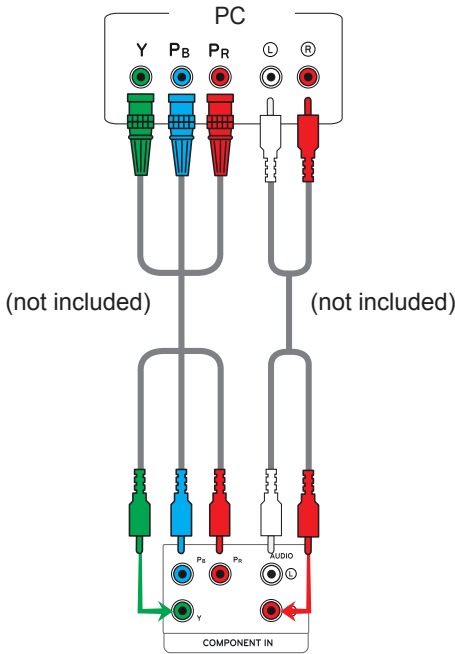

Connecting to the LAN

LAN connection

Connect the LAN cable.

A Using a router(Switching Hub)

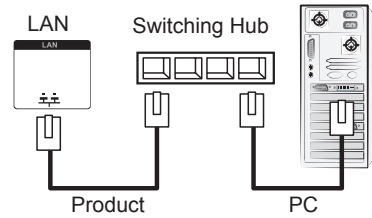

B Using the Internet.

Connecting to a USB

Connect a USB storage device such as a USB flash memory, external hard drive, MP3 player or a USB memory card reader to the Monitor set and access the USB menu to use various multimedia files. **"Connecting USB storage devices"** on See p.29 and **"Browsing files"** on See p.30

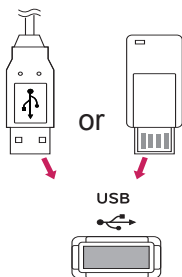

Daisy Chain Monitors

Use this function to share the RGB video signal with other monitors without having to use a separate signal splitter box.

- To use different products connected to each other Connect one end of the signal input cable (15-pin D-Sub Signal Cable) to the RGB OUT connector of product 1 and connect the other end to the RGB IN connector of other products

RGB Cable

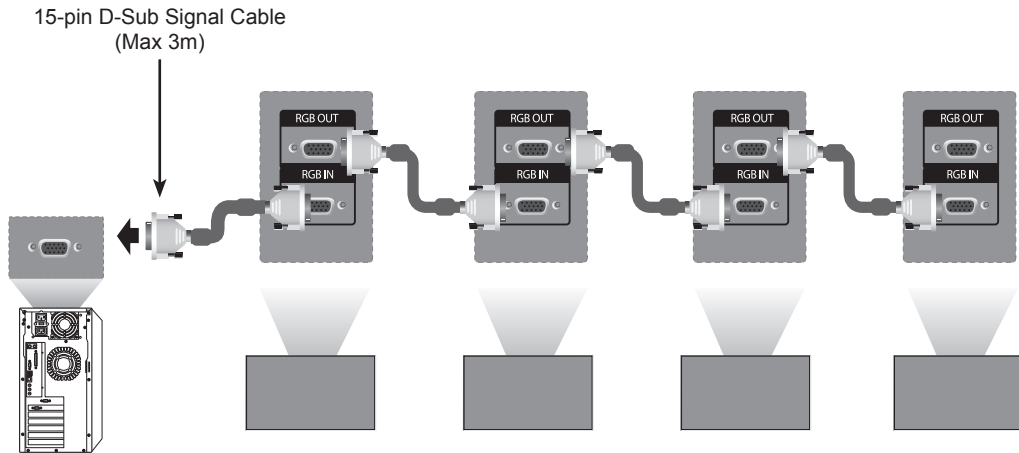

DVI Cable

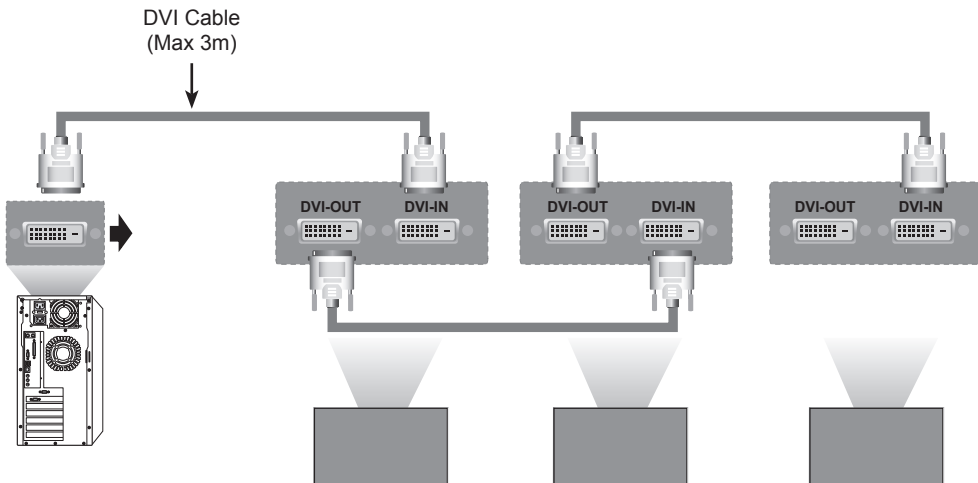

NOTE

- When multi-connecting in/out cascade format, no loss cables are recommended.
- Since the image quality may decrease when multiple monitors are connected, an amplifier may be required in certain instances.

TROUBLESHOOTING

General

No image is displayed

Problem	Resolution
Is the product power cord connected?	<ul style="list-style-type: none"> See if the power cord is properly connected to the outlet.
Does the 'Invalid Format' message appear?	<ul style="list-style-type: none"> The signal from the PC (video card) is out of the vertical or horizontal frequency range of the product. Adjust the frequency range by referring to the Specifications in this manual. * Maximum resolution RGB : 1366 x 768 @ 60 Hz HDMI/DVI : 1366 x 768 @ 60 Hz
Does the 'No Signal' message appear?	<ul style="list-style-type: none"> The signal cable between PC and product is not connected. Check the signal cable. Press the 'INPUT' menu in the remote Control to check the input signal.

NOTE

- Vertical frequency: To enable the user to watch the product display, screen image should be changed tens of times every second like a fluorescent lamp. The vertical frequency or refresh rate is the times of image display per second. The unit is Hz.
- Horizontal frequency: The horizontal interval is the time to display one vertical line. When 1 is divided by the horizontal interval, the number of horizontal lines displayed every second can be tabulated as the horizontal frequency. The unit is kHz.

The screen image looks abnormal.

Problem	Resolution
Is the screen position wrong?	<ul style="list-style-type: none"> • D-Sub analog signal - Press the "AUTO" button in the remote control to automatically select the optimal screen status that fits into the current mode. If adjustment is not satisfactory, use the Position OSD menu. • See if the video card resolution and frequency are supported by the product. If the frequency is out of range, set to the recommended resolution in the Control Panel "Display" Setting menu.
Do thin lines appear on the background screen?	<ul style="list-style-type: none"> • D-Sub analog signal - Press the "AUTO" button in the remote control to automatically select an optimal screen status that fits into the current mode. If adjustment is not satisfactory, use the size OSD menu.
Horizontal noise appears or the characters look blurred.	<ul style="list-style-type: none"> • D-Sub analog signal - Press the "AUTO" button in the remote control to automatically select an optimal screen status that fits into the current mode. If adjustment is not satisfactory, use the Phase OSD menu.
The screen is displayed abnormally.	<ul style="list-style-type: none"> • The proper input signal is not connected to the signal port. Connect the signal cable that matches with the source input signal.

After-image appears on the product.

Problem	Resolution
After-image appears when the product is turned off.	<ul style="list-style-type: none"> • If you use a fixed image for a long time, the pixels may be damaged quickly. Use the screen-saver function.

The audio function does not work.

Problem	Resolution
No sound?	<ul style="list-style-type: none"> • See if the audio cable is connected properly. • Adjust the volume. • See if the sound is set properly.
Sound is too dull.	<ul style="list-style-type: none"> • Select the appropriate equalize sound.
Sound is too low.	<ul style="list-style-type: none"> • Adjust the volume.

Screen color is abnormal.

Problem	Resolution
Screen has poor color resolution (16 colors).	<ul style="list-style-type: none"> • Set the number of colors to more than 24 bits (true color) Select Control Panel - Display - Settings - Color Table menu in Windows.
Screen color is unstable or mono-colored.	<ul style="list-style-type: none"> • Check the connection status of the signal cable. Or, re-insert the PC video card.
Do black spots appear on the screen?	<ul style="list-style-type: none"> • Several pixels (red, green, white or black color) may appear on the screen, which can be attributable to the unique characteristics of the LCD panel. It is not a malfunction of the LCD.

SPECIFICATIONS

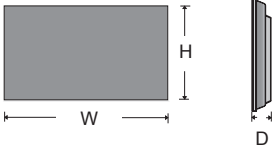
LCD Panel	Screen Type	1192.8 mm Wide (46.96 inch) TFT (Thin Film Transistor) LCD (Liquid Crystal Display) Panel. Visible diagonal size : 1192.8 mm
	Pixel Pitch	0.5415 mm (H) x 0.5415 mm (V)
Video Signal	Max. Resolution	RGB : 1366 x 768 @ 60 Hz HDMI/DVI : 1366 x 768 @ 60 Hz - It may not be supported depending on the OS or video card type.
	Recommended Resolution	RGB : 1366 x 768 @ 60 Hz HDMI/DVI : 1366 x 768 @ 60 Hz - It may not be supported depending on the OS or video card type.
	Horizontal Frequency	RGB : 30 kHz to 68 kHz HDMI/DVI : 30kHz to 68 kHz
	Vertical Frequency	RGB : 56 Hz to 75 Hz HDMI/DVI : 56 Hz to 63 Hz
	Synchronization Type	Separate Sync, Composite Sync, Digital, SOG
Input Connector		15-pin D-Sub type, HDMI/DVI(digital), COMPONENT, RS-232C, LAN, USB
Power	Rated Voltage	AC 100-240 V~ 50 / 60 Hz 2.2 A
	Power Consumption	On Mode : 220 W Max. Off Mode : ≤ 0.5 W
Dimensions (Width x Height x Depth) / Weight	 <p>* Wall Bracket available VESA 800 x 400</p>	
	1047 mm x 592 mm x 91.1 mm / 29 kg	
Environmental conditions	Operating Temperature	5 °C to 40 °C
	Operating Humidity	10 % to 80 %
	Storage Temperature	-20 °C to 60 °C
	Storage Humidity	5 % to 95 %

* Applicable only for models that support the speakers

Audio	RMS Audio Output	10 W + 10 W (R + L)
	Input Sensitivity	0.7 Vrms
	Speaker Impedance	8 Ω

Product specifications shown above may be changed without prior notice due to upgrade of product functions.

PC supported mode

Resolution	Horizontal Frequency(kHz)	Vertical Frequency(Hz)
1 720 x 400	31.468	70.8
*2 640 x 480	31.469	59.94
*3 800 x 600	37.879	60.317
4 832 x 624	49.725	74.55
*5 1024 x 768	48.363	60
*6 1280 x 720	44.772	59.855
*7 1360 x 768	47.72	59.799
*8 1366 x 768	47.71	59.79
*9 1280 x 1024	63.981	60.02

1 to 9: RGB Mode

* : HDMI/DVI mode

DTV Mode

Resolution	Component	HDMI/DTV
480i	o	x
576i	o	x
480p	o	o
576p	o	o
720p	o	o
1080i	o	o

RS-232 CONTROL

- You can control several products at a time by connecting them to a single PC.
- In the Option menu, Set ID must be between 1 and 225 without being duplicated.

Connecting the cable

Connect the RS-232C cable as shown in the picture.

- The RS-232C protocol is used for communication between the PC and product. You can turn the product on/off, select an input source or adjust the OSD menu from your PC. This monitor features two RS-232 ports. One input and one output. This allows you to daisy-chain monitors without having to use a splitter box.

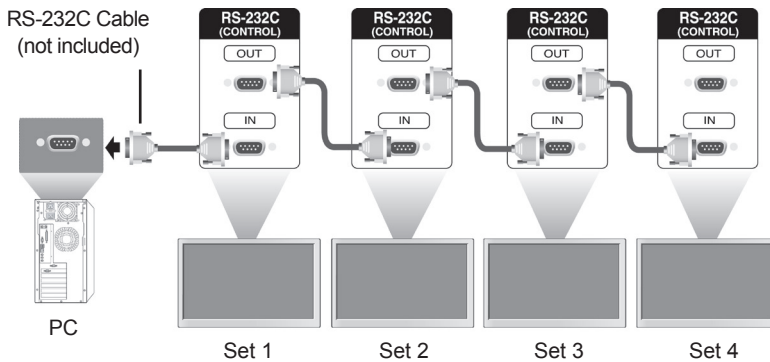

NOTE

15 mm or less



- Use RS-232C cables as shown in the picture.
- If a cable bigger than the ones shown in the picture is used in the connector, the connection may not be flawless due to interference between the cables.

RS-232C Configurations

7-Wire Configurations (Cross-over RS-232C cable)

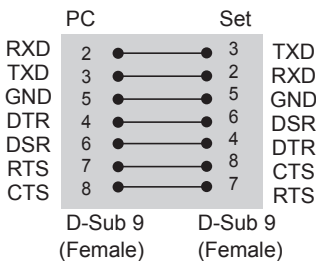

3-Wire Configurations (Not Standard)

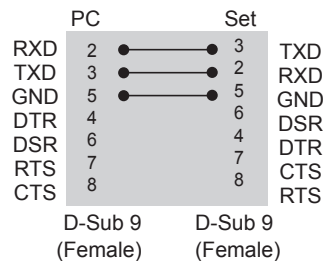

Communication Parameter

- Baud Rate : 9600 baud Rate (UART)
- Data Length : 8 bit
- Parity Bit : None
- Stop Bit : 1bit
- Flow Control : None
- Communication Code : ASCII code
- Use a crossed (reverse) cable

Command Reference List

	COMMAND		DATA
	1	2	
01. Power	k	a	00 to 01
02. Input Select	x	b	refer to 02. Input Select
03. Aspect Ratio	k	c	refer to 03. Aspect Ratio
04. Volume Mute	k	e	00 to 01
05. Volume Control	k	f	00 to 64
06. Contrast	k	g	00 to 64
07. Brightness	k	h	00 to 64
08. Color	k	i	00 to 64
09. Tint	k	j	00 to 64
10. Sharpness	k	k	00 to 64
11. OSD Select	k	l	00 to 01
12. Treble	k	r	00 to 64
13. Bass	k	s	00 to 64
14. Balance	k	t	00 to 64
15. Color Temperature	x	u	00 to 64
16. ISM mode	j	p	refer to 16. ISM Method
17. Energy Saving	j	q	refer to 17. Energy Saving
18. Auto Configuration	j	u	01
19. Key	m	c	refer to 19. Key
20. Tile Mode	d	d	00 to 01
21. Tile H Position	d	e	00 to 64
22. Tile V Position	d	f	00 to 64
23. Tile H Size	d	g	00 to 64
24. Natural Mode (in Tile Mode)	d	j	00 to 01
25. Picture mode	d	x	00 to 04
26. Sound mode	d	y	01 to 05
27. Elapsed Time Return	d	l	FF
28. Speaker	d	v	00 to 01
29. Sleep Time	f	f	00 to 08
30. Power On Delay	f	h	00 to 64
31. Language	f	i	00 to 08
32. Reset	f	k	00 to 02
33. H Position	f	q	00 to 64
34. V Position	f	r	23 to 41
35. H Size	f	s	00 to 64
36. FAN Control	d	o	00 to 01
37. FAN Fault check	d	w	FF
38. Temperature Value	d	n	FF

Transmission / Receiving Protocol

	COMMAND		DATA
	1	2	
39. Serial No. Check	f	y	FF
40. S/W Version	f	z	FF
41. Tile Matrix	d	k	11 to FF
42. Tile ID	d	i	Refer to 42. Tile ID

Transmission

[Command1][Command2][][Set ID][][Data][Cr]

- [Command 1]: First command to control the set.
- [Command 2]: Second Command to control the set.
- [Set ID]: Set ID wants to communicate with the set. Command for test is 00.
- [DATA]: Information passed to the set.
- [Cr]: Carriage Return. ASCII code '0x0D'.
- []: ASCII code space '0 x 20'.

Acknowledgement

[a][][Set ID][][OK/NG][Data][x]

- In a like manner, if other functions transmit 'FF' data based on this format, Acknowledgement data feedback presents status about each function.
- Note: In this mode, display will send the acknowledgement after power on processing completion. There might be a time delay between command and acknowledgement.
- Refer to 'Real data mapping' for hexadecimal data to decimal data.
- No acknowledgement signal will be sent from display, if Set ID in transmission signal is set to '00'(=0x00).

Transmission / Receiving Protocol

01. Power (Command : k a)

To control Power On / Off of the display.

Transmission

[k][a][][Set ID][][Data][Cr]

Data 00 : Power Off

01 : Power On

Acknowledgement

[a][][Set ID][][OK/NG][Data][x]

* In a like manner, if other functions transmit 'FF' data based on this format, Acknowledgement data feedback presents status about each function.

* Note: In this modes, display will send the acknowledgement after power on processing completion. There might be a time delay between command and acknowledgement.

* Refer to 'Real data mapping' for hexadecimal data to decimal data.

02. Input Select (Command : x b)

To select input source for display.

Transmission

[x][b][][Set ID][][Data][Cr]

Data 40: Component

60: RGB PC

90: HDMI

91: DVI

Acknowledgement

[b][][Set ID][][OK/NG][Data][x]

* Use this feature depending on your model

03. Aspect Ratio (Command : k c)

To adjust the screen format.

Transmission

[k][c][][Set ID][][Data][Cr]

Data 01: 4:3

02: 16:9

04: Zoom

09: Just scan(720p or more)

10 to 1F: Cinema Zoom 1 to 16

Acknowledgement

[c][][Set ID][][OK/NG][Data][x]

04. Volume Mute (Command : k e)

To select screen mute on/off.

Transmission

[k][e][][Set ID][][Data][Cr]

Data 0 : Volume Mute On (Volume Off)

1 : Volume Mute Off (Volume On)

Acknowledgement

[e][][Set ID][][OK/NG][Data][x]

05. Volume Control(Command : k f)

To adjust volume.

You can also adjust volume with the volume buttons on remote control.

Transmission

[k][f][][Set ID][][Data][Cr]

Data 00 to 64: Volume 0 to 100

* Refer to 'Real data mapping' for hex decimal value.

Acknowledgement

[f][][Set ID][][OK/NG][Data][x]

06. Contrast (Command: k g)

To adjust screen contrast.

You can also adjust contrast in the PICTURE menu.

Transmission

[k][g][][Set ID][][Data][Cr]

Data 00 to 64: Contrast 0 to 100

Acknowledgement

[g][][Set ID][][OK/NG][Data][x]

07. Brightness (Command: k h)

To adjust screen brightness.

You can also adjust contrast in the PICTURE menu.

Transmission

[k][h][][Set ID][][Data][Cr]

Data 00 to 64: Brightness 0 to 100

Acknowledgement

[h][][Set ID][][OK/NG][Data][x]

08. Color (Command: k i)

To adjust screen color.

You can also adjust contrast in the PICTURE menu.

Transmission

[k][i][][Set ID][][Data][Cr]

Data 00 to 64: Color 0 to 100

Acknowledgement

[i][][Set ID][][OK/NG][Data][x]

09. Tint (Command: k j)

To adjust screen tint.

You can also adjust contrast in the PICTURE menu.

You can also adjust tint on AV and Component input source.

Transmission

[k][j][][Set ID][][Data][Cr]

Data 00 to 64: Tint 0 to 100 (R50 to G50)

Acknowledgement

[j][][Set ID][][OK/NG][Data][x]

10. Sharpness (Command: k k)

To adjust screen sharpness.

You can also adjust contrast in the PICTURE menu.

You can also adjust tint on AV and Component input source.

Transmission

[k][k][][Set ID][][Data][Cr]

Data 00 to 64: Sharpness 0 to 100

Acknowledgement

[k][][Set ID][][OK/NG][Data][x]

11. OSD Select (Command: k l)

To select OSD(On Screen Display) on/off.

Transmission

[k][l][][Set ID][][Data][Cr]

Data 00: OSD off

01: OSD on

Acknowledgement

[l][][Set ID][][OK/NG][Data][x]

12. Treble (Command: k r)

To adjust treble.

You can also adjust treble in the Audio menu.

Transmission

[k][r][][Set ID][][Data][Cr]

Data 00 to 64: Treble 0 to 100

Acknowledgement

[r][][Set ID][][OK/NG][Data][x]

13. Bass (Command: k s)

To adjust bass.

You can also adjust treble in the Audio menu.

Transmission

[k][s][][Set ID][][Data][Cr]

Data 00 to 64: Bass 0 to 100

Acknowledgement

[s][][Set ID][][OK/NG][Data][x]

14. Balance (Command: k t)

To adjust balance.

You can also adjust treble in the Audio menu.

Transmission

[k][t][][Set ID][][Data][Cr]

Data 00 to 64: Left 50 to Right 50

Acknowledgement

[t][][Set ID][][OK/NG][Data][x]

15. Color Temperature (Command: x u)

To adjust color temperature.

You can also adjust color temperature in the Picture menu.

Transmission

[x][u][][Set ID][][Data][Cr]

Data 00 to 64: Warm 50 to Cool 50

Acknowledgement

[u][][Set ID][][OK/NG][Data][x]

16. ISM Method (Command: j p)

To select ISM method for avoiding having a fixed image remain on screen.

Transmission

[j][p][][Set ID][][Data][Cr]

Data 04: White Wash

08: Normal

20: Color Wash

Acknowledgement

[p][][Set ID][][OK/NG][Data][x]

17. Energy Saving (Command: j q)

To control the energy saving function.

Transmission

[j][q][][Set ID][][Data][Cr]

Data 00: Off

01: Minimum

02: Medium

03: Maximum

05: Screen Off

Acknowledgement

[q][][Set ID][][OK/NG][Data][x]

18. Auto Configuration (Command: j u)

To adjust picture position and minimize image shaking automatically.

Auto configuration only works in RGB-PC mode.

Transmission

[j][u][][Set ID][][Data][Cr]

Data 01: Set

Acknowledgement

[u][][Set ID][][OK/NG][Data][x]

19. Key (Command: m c)

To send IR remote control code.

Transmission

[m][c][][Set ID][][Data][Cr]

Data IR_KEY_CODE

Acknowledgement

[c][][Set ID][][OK/NG][Data][x]

When display is in the standby mode, display will turn on by Power button of remote control only.

20. Tile mode (Command: d d)

To select a tile mode.

Transmission

[d][d][][Set ID][][Data][Cr]

Data 00: Off

01: On

Acknowledgement

[d][][Set ID][][OK/NG][Data][x]

21. Tile H Position (Command: d e)

To set the Horizontal position.

Transmission

[d][e][][Set ID][][Data][Cr]

Data 00 to 64: Left Max to Right Max

Acknowledgement

[e][][Set ID][][OK/NG][Data][x]

22. Tile V Position (Command: d f)

To set the Vertical Position.

Transmission

[d][f][][Set ID][][Data][Cr]

Data 23 to 41: Bottom Max to Top Max

Acknowledgement

[f][][Set ID][][OK/NG][Data][x]

23. Tile H Size (Command: d g)

To set the Horizontal size.

Transmission

[d][g][][Set ID][][Data][Cr]

Data 00 to 64: Min to Max

Acknowledgement

[g][][Set ID][][OK/NG][Data][x]

24. Natural Mode (in Tile Mode) (Comman : d j)

To assign the Tile Natural mode for Tiling function.

Transmission

[d][j][][Set ID][][Data][Cr]

Data 00: Off

01: On

Acknowledgement

[j][][Set ID][][OK/NG][Data][x]

25. Picture Mode (Comman : d x)

To select the picture mode.

Transmission

[d][x][][Set ID][][Data][Cr]

Data 00: Vivid

01: Standard(User)

02: Cinema

03: Sport

04: Game

Acknowledgement

[x][][Set ID][][OK/NG][Data][x]

26. Sound Mode (Comman : d y)

To select the sound mode.

Transmission

[d][y][][Set ID][][Data][Cr]

Data 01: Standard

02: Music

03: Cinema

04: Sport

05: Game

Acknowledgement

[y][][Set ID][][OK/NG][Data][x]

27. Elapsed Time Return (Command: d l)

To read the panel used time.

Transmission

[d][l][][Set ID][][Data][Cr]

Data FF: Data should be always ff in hexadecimal.

Acknowledgement

[l][][Set ID][][OK/NG][Data][x]

* Returned data means used hours in hexadecimal.

28. Speaker (Command: d v)

To select speaker on/off.

Transmission

[d][v][][Set ID][][Data][Cr]

Data 00: Off

01: On

Acknowledgement

[v][][Set ID][][OK/NG][Data][x]

29. Sleep Time (Command: f f)

To set sleep time.

Transmission

[f][f][][Set ID][][Data][Cr]

Data 00: Off

01: 10 min.

02: 20 min.

03: 30 min.

04: 60 min.

05: 90 min.

06: 120 min.

07: 180 min.

08: 240 min.

Acknowledgement

[f][][Set ID][][OK/NG][Data][x]

30. Power On Delay (Command: f h)

To set the schedule delay when the power is turned on(unit: second).

Transmission

[f][h][][Set ID][][Data][Cr]

Data 00 to 64: 0 to 100sec.

Acknowledgement

[h][][Set ID][][OK/NG][Data][x]

31. Language (Command: f i)

To set language for OSD.

Transmission

[f][i][][Set ID][][Data][Cr]

Data 00: Korean
01: Chinese
02: Japanese
03: English
04: French
05: German
06: Italian
07: Portuguese
08: Spanish(EU)
09: Russian

Acknowledgement

[i][][Set ID][][OK/NG][Data][x]

32. Reset (Command: f k)

To execute the Picture, Screen and Factory reset function.

Transmission

[f][k][][Set ID][][Data][Cr]

Data 00: Picture Reset
01: Screen Reset
02: Factory Reset

Acknowledgement

[k][][Set ID][][OK/NG][Data][x]

33. H Position (Command: f q)

To set the Horizontal position.

* This function only works in Tile Off mode.

Transmission

[f][q][][Set ID][][Data][Cr]

Data 00 to 64: Left 50 to Right 50

Acknowledgement

[q][][Set ID][][OK/NG][Data][x]

34. V Position (Command: f r)

To set the Vertical position.

* This function only works in Tile Off mode.

Transmission

[f][r][][Set ID][][Data][Cr]

Data 23 to 41: Bottom 15 to Top 15

Acknowledgement

[r][][Set ID][][OK/NG][Data][x]

35. H Size (Command: f s)

To set the Horizontal size.

* This function only works in Tile Off mode.

Transmission

[f][s][][Set ID][][Data][Cr]

Data 00 to 64: Size -50 to +50

Acknowledgement

[s][][Set ID][][OK/NG][Data][x]

36. FAN Control (Command: d o)

To set Fan control on/off.

* This function only works in Tile Off mode.

Transmission

[d][o][][Set ID][][Data][Cr]

Data 00: Auto
01: On
02: Manual

Acknowledgement

[o][][Set ID][][OK/NG][Data][x]

37. FAN Fault Check (Command: d w)

To set Fan control on/off.

* This function only works in Tile Off mode.

Transmission

[d][w][][Set ID][][Data][Cr]

Data FF: Data should be always ff in hexadecimal.

Acknowledgement

[w][][Set ID][][OK/NG][Data][x]

Data 00: Abnormal State

01: Normal State

38. Temperature Value (Command: d n)

To read the inside temperature of the display.

Transmission

[d][n][][Set ID][][Data][Cr]

Data FF: Data should be always ff in hexadecimal.

Acknowledgement

[n][][Set ID][][OK/NG][Data][x]

39. Serial No. Check (Command: f y)

To read the serial numbers.

Transmission

[f][y][][Set ID][][Data][Cr]

Data FF: Data should be always ff in hexadecimal.

Acknowledgement

[y][][Set ID][][OK/NG][Data][x]

40. S/W Version (Command: f z)

To read the software version.

Transmission

[f][z][][Set ID][][Data][Cr]

Data FF: Data should be always ff in hexadecimal.

Acknowledgement

[z][][Set ID][][OK/NG][Data][x]

41. Tile Matrix (Command: d k)

To set tile row and columne

Transmission

[d][k][][Set ID][][Data][Cr]

Data 11 to FF: 1st byte - Tile Row value

2nd byte - Tile Column value

* If Data is 00, 01 or 10, those commands won't work

Acknowledgement

[k][][Set ID][][OK/NG][Data][x]

42. Tile ID (Command: d i)

To set Tile ID.

Transmission

[d][i][][Set ID][][Data][Cr]

Data 01 to E1: Tile ID 01 to 225**

FF: Read Tile ID

* Data should not be larger than (Tile Row) x (Tile Column)

Acknowledgement

[i][][Set ID][][OK/NG][Data][x]

* NG will be returned if Data is larger than (Tile Row) x (Tile Column), except 0xFF.

IR CODE (Hex)	Function	Remark
08	POWER	Remocon Botton
C4	MONITOR ON	Remocon Botton
C5	MONITOR OFF	Remocon Botton
95	Every Saving	Remocon Botton
0B	INPUT	Remocon Botton
10	Number 0	Remocon Botton
11	Number 1	Remocon Botton
12	Number 2	Remocon Botton
13	Number 3	Remocon Botton
14	Number 4	Remocon Botton
15	Number 5	Remocon Botton
16	Number 6	Remocon Botton
17	Number 7	Remocon Botton
18	Number 8	Remocon Botton
19	Number 9	Remocon Botton
02	VOL+	Remocon Botton
03	VOL-	Remocon Botton
E0	BRIGHTNESS ^ (Page Up)	Remocon Botton
E1	BRIGHTNESS v (Page Down)	Remocon Botton
79	ARC (MARK)	Remocon Botton
4D	PSM	Remocon Botton
09	MUTE	Remocon Botton
43	MENU	Remocon Botton
99	AUTO	Remocon Botton
40	^	Remocon Botton
41	v	Remocon Botton
06	>	Remocon Botton
07	<	Remocon Botton
44	OK	Remocon Botton
28	BACK	Remocon Botton
7B	TILE	Remocon Botton
5B	EXIT	Remocon Botton
72	ID ON(Red)	Remocon Botton
71	ID OFF(Green)	Remocon Botton
63	Yellow	Remocon Botton
61	Blue	Remocon Botton
B1	■	Remocon Botton
B0	▶	Remocon Botton
BA		Remocon Botton
8F	◀◀	Remocon Botton
8E	▶▶	Remocon Botton

LICENSE

A different license is supported depending on the model. Visit www.lg.com for more information on the license.



HDMI, the HDMI logo and High-Definition Multimedia Interface are trademarks or registered trademarks of HDMI Licensing LLC.



ABOUT DIVX VIDEO: DivX® is a digital video format created by DivX, LLC, a subsidiary of Rovi Corporation. This is an official DivX Certified® device that plays DivX video. Visit divx.com for more information and software tools to convert your files into DivX videos.

ABOUT DIVX VIDEO-ON-DEMAND: This DivX Certified® device must be registered in order to play purchased DivX Video-on-Demand (VOD) movies. To obtain your registration code, locate the DivX VOD section in your device setup menu. Go to vod.divx.com for more information on how to complete your registration.

DivX Certified® to play DivX® video up to HD 1080p, including premium content.

DivX®, DivX Certified® and associated logos are trademarks of Rovi Corporation or its subsidiaries and are used under license.

Covered by one or more of the following U.S. patents: 7,295,673; 7,460,668; 7,515,710; 7,519,274



Manufactured under license from Dolby Laboratories. "Dolby" and the double-D symbol are trademarks of Dolby Laboratories.



Make sure to read the Safety Precautions before using the product. Keep the Owner's Manual(CD) in an accessible place for future reference. The model and serial number of the SET is located on the back and one side of the SET. Record it below should you ever need service.

MODEL _____

SERIAL _____

ENERGY STAR is a set of power-saving guidelines issued by the U.S. Environmental Protection Agency(EPA).



As an ENERGY STAR Partner LGE U. S. A.,Inc. has determined that this product meets the ENERGY STAR guidelines for energy efficiency.

Temporary noise is normal when powering ON or OFF this device.