



OWNER'S MANUAL

CLEANING ROBOT

Before using, please carefully read the Safety Precautions pages to allow for safe operation of the product. After reading the operation manual, please keep it in an easily accessible location.

VR6170LVM
VR6171LVM



MFL67021515

www.lg.com

FEATURES

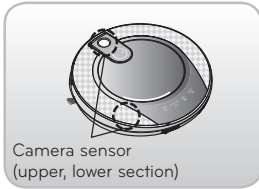

Images of the ceiling and floor are obtained from the sensors of the upper and lower cameras, and through this, the location of HOM-BOT 2.0 will be confirmed, therefore, elaborate cleaning can be accomplished for every part of the room.

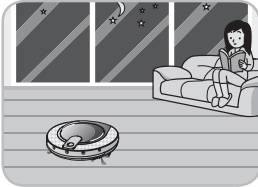

As the noise levels are at a quiet 60dB(A), cleaning can be performed at night.

*60dB(A)

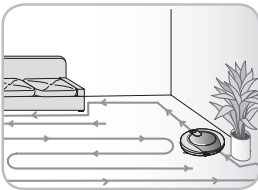

The HOM-BOT 2.0 has two auto cleaning modes that can be selected by the user.

*Spatial expansion mode, zigzag mode



The HOM-BOT 2.0 also has voice confirmation and instruction that can be easily understood by the user.

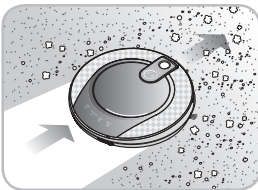

The use of the ultra microfiber mop accessory allows finer dust to be collected. (option)

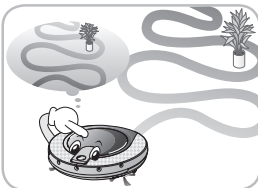

HOM-BOT 2.0 memorizes the location for cleaning.

* Minimizes the overlapping of cleaning area

CONTENTS

1

BEFORE THE USE

- 2~4 Safety precautions
- 5 Included with product
- 6~7 Parts description
- 8~9 Button functions
- 10 Display status information
- 11 Before you start
- 12 Overview

2

METHOD OF USE

- 13 How to install the home station
- 14 How to turn the HOM-BOT 2.0 power supply on & off
- 15 How to start and stop cleaning
- 16~17 How to charge the battery
- 18 Cleaning modes
- 19 Auxiliary cleaning modes
- 20 Timer cleaning
- 21 Mop cleaning (option)
- 22 Location search function

3

HANDLING METHOD AFTER USE

- 23 Cleaning the dust bin
- 24 Cleaning the dust bin filter
- 25 Cleaning the brush
- 26 Cleaning the sensor/charging terminal
- 27 Cleaning the side brush
- 28 Cleaning the ultra microfiber mop (option)

4

ADDITIONAL INFORMATION

- 29~31 Troubleshooting
- 32 Before you call for service

5

REFERENCE

- 33 Product specifications
- 34 Open source software notice

SAFETY PRECAUTIONS

The purpose of the safety precautions described below is for the user to use the product safely and correctly to prevent any unexpected risk of injury or damage.

Basic safety precautions

After reading this manual, please keep it in an easily accessible location.



This is the safety alert symbol. This symbol alerts you to potential hazards that can result in property damage and/or serious bodily harm or death.



WARNING Indicates a hazardous situation which, if not avoided, could result in death or serious injury.



CAUTION Indicates a hazardous situation which, if not avoided, could result in minor or moderate injury.



WARNING

1. This appliance is not intended for use by persons (including children) with reduced physical, sensory or mental capabilities, or lack of experience and knowledge, unless they have been given supervision or instruction concerning use of the appliance by a person responsible for their safety.
2. Children should be supervised to ensure that they do not play with the appliance.
3. If the supply cord is damaged, it must be replaced by LG Electronics Service Agent in order to avoid a hazard
4. This appliance can be used by children aged from 8 years and above and persons with reduced physical, sensory or mental capabilities or lack of experience and knowledge if they have been given supervision or instruction concerning use of the appliance in a safe way and understand the hazards involved. Children shall not play with the appliance. Cleaning and user maintenance shall not be made by children without supervision.

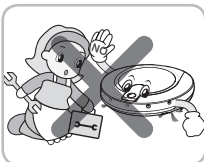

For your safety, do not remove the battery from the HOM-BOT 2.0. If you need to replace the battery or the HOM-BOT 2.0, take it to the nearest authorized LG Electronics service center or dealer for assistance.

Failure to follow this warning can cause fire or product failure.

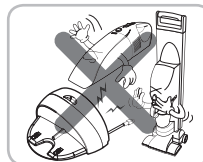

Never use the HOM-BOT 2.0 with a battery and/or home station from any other product than the HOM-BOT 2.0.

Doing so can cause fire or product failure.

SAFETY PRECAUTIONS

! WARNING

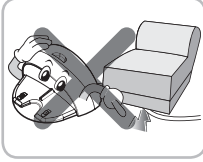

Make sure the power cord of the home station is not crushed under a heavy object or damaged by contact with sharp objects.

Failure to follow this warning can cause electric shock, fire or product failure. If the power cord is broken, do not plug it in. Take the product to an LG Electronics Authorised service repairer.

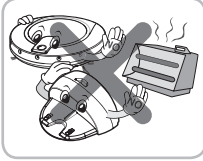

Do not place the home station and the HOM-BOT 2.0 near a heating device.

Doing so can cause product deformation, fire, or product failure.

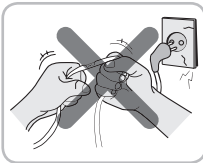

Do not force the power plug to bend. Do not use the power plug when it has been damaged or loosened.

Doing so can cause fire or product failure.

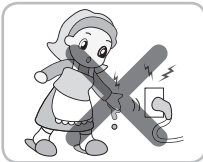

Do not touch the power plug with wet hands.

Doing so can cause electric shock.

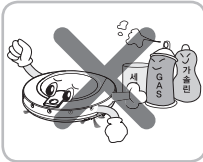

Do not spray or suck in inflammable materials, surfactants, or drinking water in the vicinity of the HOM-BOT 2.0.

Doing so can cause fire or product failure.

* Inflammable materials: gasoline, thinner, etc.

* Surfactant: detergent, articles for bath, etc.



Do not insert any part of the body, such as a hand or foot, below the brush or wheels of the HOM-BOT 2.0 while in use.

Doing so can cause injury or product damage.



Do not operate the HOM-BOT 2.0 on narrow and high furniture such as a wardrobe, refrigerator, desk, table, etc.

Doing so can cause injury, product failure or damage which is not covered by the warranty.

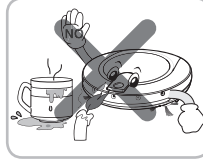

Do not use the HOM-BOT 2.0 when candles or fragile objects are placed on the floor.

Doing so can cause fire or product failure.

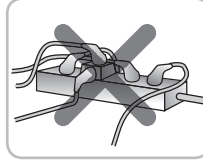

Always use a dedicated outlet with 5A or above.

If multiple appliances are connected to an outlet simultaneously, they can generate enough heat to cause a fire.

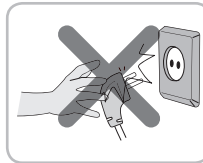

When pulling out the power plug, always pull it out by grabbing the plug, not the cord. When pulling out the power plug, do not to touch the prongs with your fingers.

Doing so can cause an electric shock.

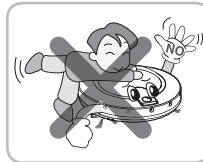

Do not allow children or pets to play with or rest upon the HOM-BOT 2.0 at any time. Do not use the HOM-BOT 2.0 while an object is hanging from it.

Doing so can cause injury or product damage.

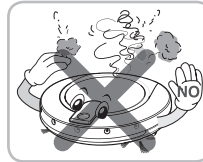

Turn the power supply off immediately if any abnormal sound, odor, or smoke is generated from the HOM-BOT 2.0.

Failure to do so can cause fire or product failure.



Do not operate the HOM-BOT 2.0 in a room where a child is sleeping.

Doing so can cause injury or product damage.

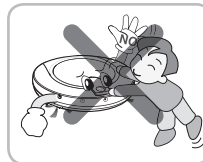

Do not leave Children or pets near the HOM-BOT 2.0 unsupervised.

Doing so can cause injury or product damage.

! CAUTION

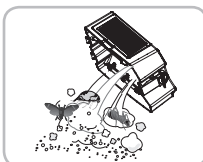

Frequently empty the dust bin and maintain its cleanliness.

The dust collected in the dust bin can trigger allergies and may contain harmful insects.

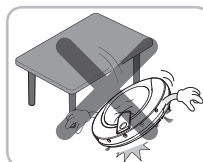

Do not drop the HOM-BOT 2.0 or subject it to strong impacts.

Doing so can cause injury or product failure not covered by the warranty.

SAFETY PRECAUTIONS

! CAUTION

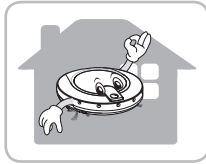

Use the HOM-BOT 2.0 indoors only.

Using it outdoors can cause product failure and irreparable damage to the unit.

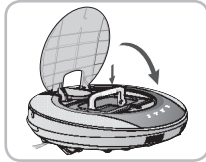

Close the cover of the dust bin on the main unit before start cleaning.

If the cover is not closed, it can cause injury or product damage.

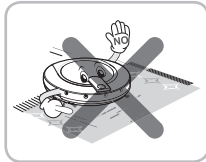

In rare cases, the HOM-BOT 2.0's brush can damage the carpet. If this happens, immediately stop the cleaning operation.

When a carpet has long tassels, the tassels can be damaged.

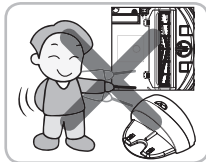

Do not let the main unit and charging terminal of the home station come into contact with metallic objects.

Doing so can cause product failure.



Do not put water, detergent, etc. into the HOM-BOT 2.0.

Doing so can cause product failure. Do not put any water or detergent on the HOM-BOT 2.0. If liquids get inside of the HOM-BOT 2.0, turn off the power supply and contact an LG Electronics sales agent or customer care center.

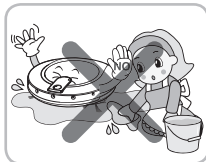

If the floor is wet or has wet spots, wipe them up before using the HOM-BOT 2.0. Do not use the HOM-BOT 2.0 on a wet surface.

Failure to do so can cause product failure.

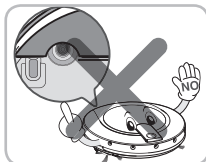

When attaching the mop, do not block the bottom camera sensor.

Blocking the bottom camera sensor may not allow the product to work smoothly.

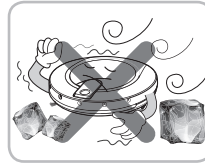

Do not expose the HOM-BOT 2.0 to cold temperatures (less than -5°C) for a long period of time.

Doing so can cause product failure.



Remove any cable or long string on the floor.

Cable or string can get tangled in the wheels of HOM-BOT 2.0 to cause product failure or the cord can be disconnected.

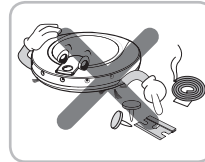

Do not allow the HOM-BOT 2.0 to sweep up liquids, blades, thumb tacks, kindling, etc.

These items can cause product failure.

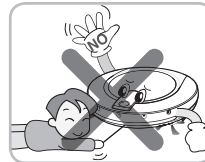

Do not put sharp objects into the opening of the HOM-BOT 2.0's supersonic sensor.

Doing so can cause product failure.

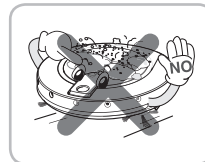

Do not use the HOM-BOT 2.0 when the dust bin is completely filled up.

Doing so can cause product failure.

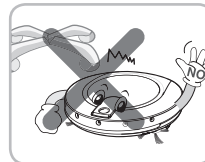

When the robot cleaner is operating, it may hit the chair leg, desk leg, table leg or other narrow pieces of furniture.

For quicker and better cleaning, place the dining chairs on top of the dining table.

✓ Tip

Check the following items before use:

- Empty the dust bin after it fills up.
- Remove any cables or long strings from the floor.
- Remove any moisture from the floor before cleaning.
- Close the cover of the dust bin before cleaning.
- Remove fragile or unnecessary objects from the room to be cleaned.
For example, remove expensive ceramics and valuables from the floor.
- Confirm whether the battery has sufficient power, and if it is low, recharge it.
- Close the doors of any room that you do not want the HOM-BOT 2.0 to enter.
During cleaning, the HOM-BOT 2.0 may enter another room and continue cleaning.
- Do not use this product in the room where a child is sleeping alone. The child can be hurt.
- Remove towels, foot towel or any other thin cloth from the floor as they can get caught by the brush.
- Cleaning will not proceed smoothly on carpets with tassels or carpets thicker than 8 mm (0.315 in). It may be more convenient to arrange them before using the product.

INCLUDED WITH PRODUCT

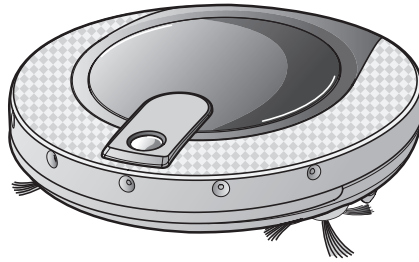

HOM-BOT 2.0



Remote controller

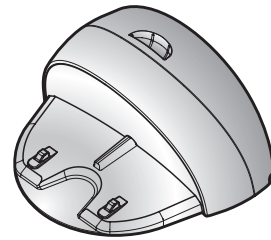

Home station

► Figures can be different from actual objects.

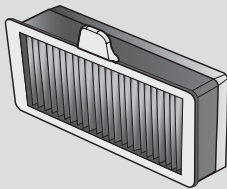

Dust bin filter (spare)



Quick guide

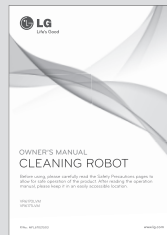

Operation manual



Side brush
(2 pieces)

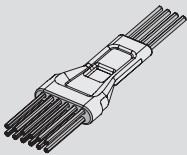

Brush for cleaning filter

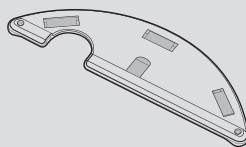

Mop plate

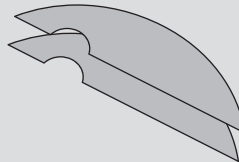

Ultra microfiber mop
(2 pieces) (option)

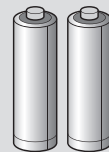

Dry cell for
remote controller
(2 units of AAA size)

PARTS DESCRIPTION - HOM-BOT 2.0

Plan view

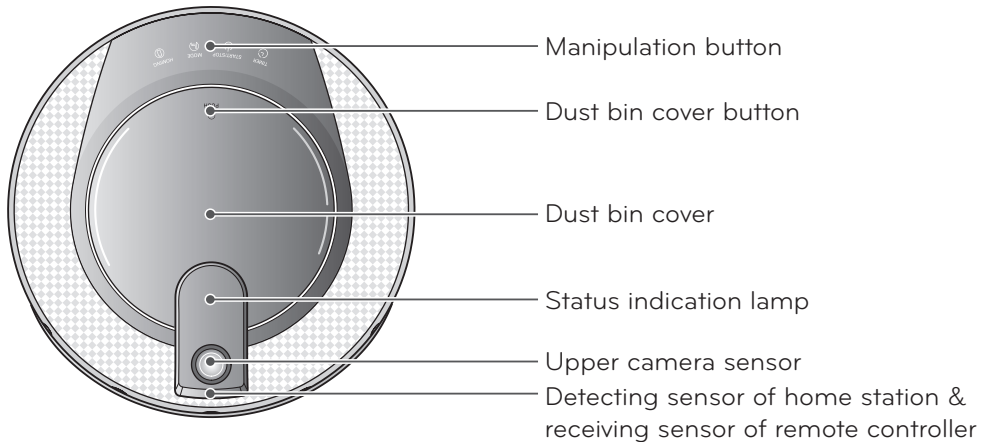

Front view

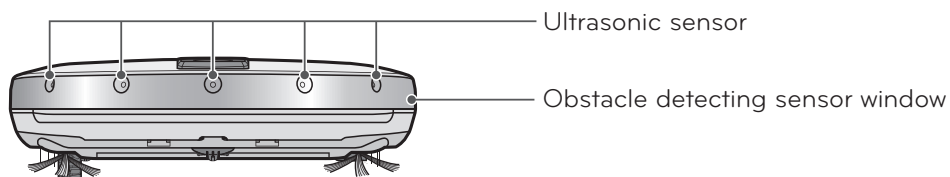

Rear view

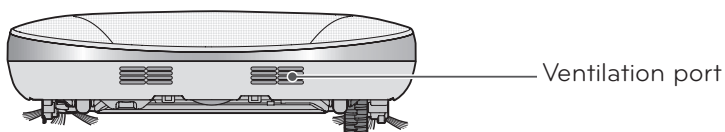

Bottom view

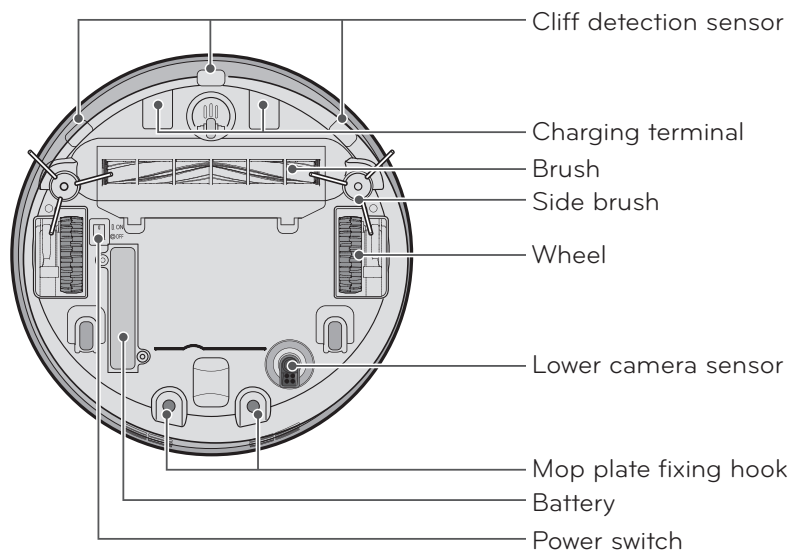

► Figures can be different from actual objects.

PART DESCRIPTION – HOME STATION / DUST BIN

Home station

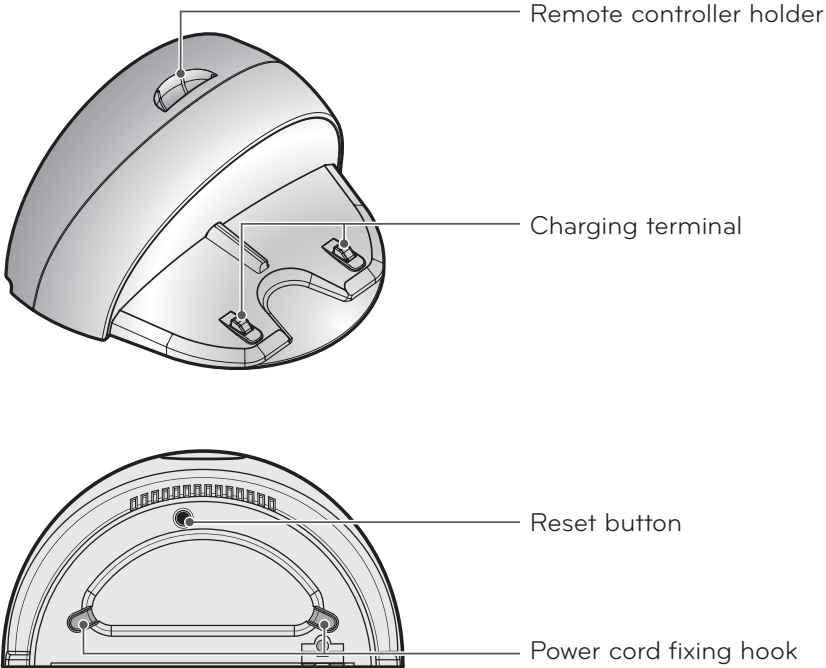

Dust bin

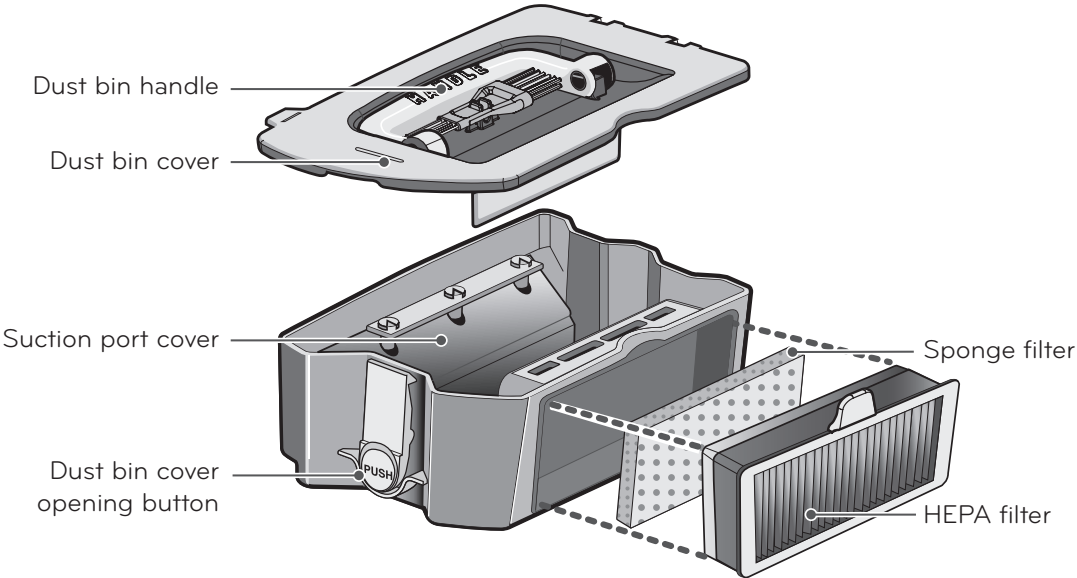

► Figures can be different from actual objects.

BUTTON FUNCTIONS – HOM-BOT 2.0

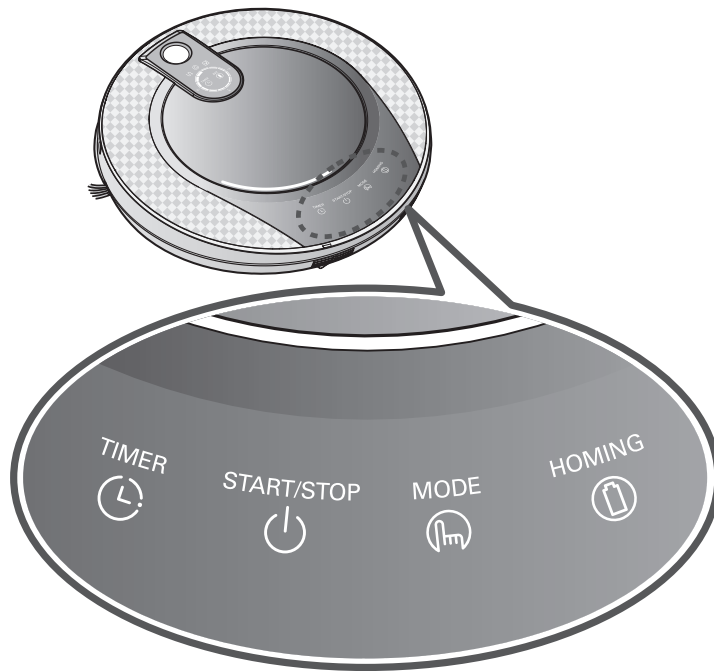

Timer button

- Use the TIMER button to start cleaning after a set amount of time has elapsed.
- The timer can be set from 1 to maximum of 12 hours in 1 hour units.
- When starting the timer clean outside of the home station, the cleaning time can be reduced. Therefore use the product while attached to the home station as much as possible.
- The timer setting is restricted if there is no dust bin.

START/STOP button

- Press the START/STOP button to turn the HOM-BOT 2.0 on/off or start/stop cleaning.
- Press the START/STOP button while the HOM-BOT 2.0 is on and it will automatically start cleaning.
- If the START/STOP button is pressed during automatic cleaning, the HOM-BOT 2.0 will stop cleaning.
- Press and hold the START/STOP button for approximately two seconds to turn off the HOM-BOT 2.0.
- If the button is pressed while in the timer mode, the reservation will be canceled.

CLEAN MODE button

- Press this button to change the cleaning mode.
- When the product is attached to the home station and when the timer is set, spot cleaning mode cannot be selected.

HOMING button

- Press the HOMING button to move the HOM-BOT 2.0 to the home station for battery charging.
- When cleaning is complete or the battery is low, the device will automatically move to the home station to charge the battery even without pressing the HOMING button.

BUTTON FUNCTIONS – REMOTE CONTROL

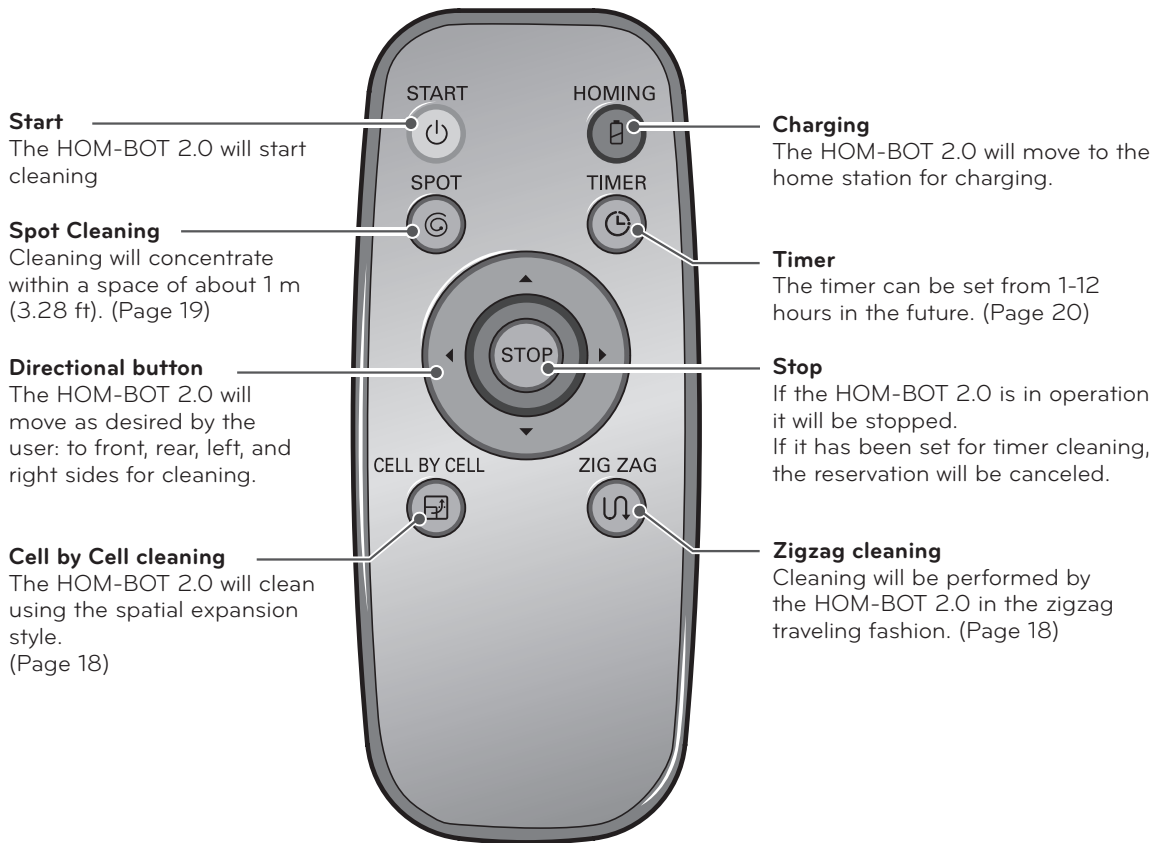

Tip

- The HOM-BOT 2.0's power supply cannot be turned on with the remote control.
- If the main unit is turned off, the remote control will not be activated.
- To turn on/off the power supply, use START/STOP button on the top of HOM-BOT 2.0.
- In order to do spot cleaning, timer cleaning, zigzag cleaning, and spatial expansion cleaning, you must first stop the operation of the HOM-BOT 2.0.

DISPLAY STATUS INFORMATION

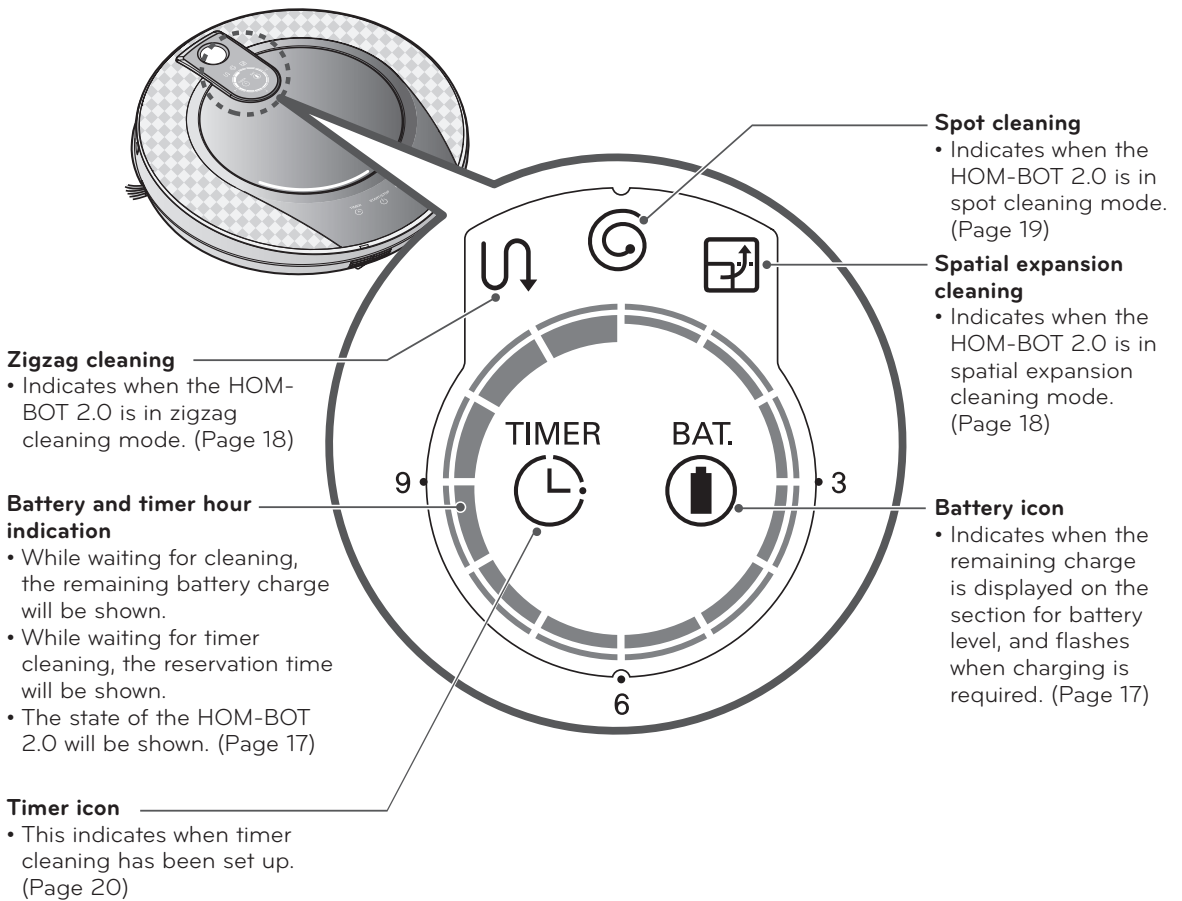

Tip

- Once the cleaning mode is selected, it will be maintained even when the power is turned off.
- To cancel the timer setting, press the STOP button on the remote control or the START/STOP button on the HOM-BOT 2.0.

BEFORE YOU START

Check these items before cleaning

- Do not use this device in a room where a child is left alone. The child could be injured.
- Remove fragile or unnecessary objects from the room to be cleaned. Especially, remove expensive ceramics and valuables from the floor.
- Close the cover of the dust bin before cleaning.
- Remove any moisture that might be on the floor.
- Remove cables, strips, towels, mat etc. from the floor so they will not get caught by the brush.
- Confirm whether battery charge is sufficient, and if it is low, recharge it.
- Empty the dust bin if it is full.
- Close the doors of any room that you do not want the HOM-BOT 2.0 to enter. During cleaning, the HOM-BOT 2.0 may enter another room and continue cleaning.
- When the mop is attached, HOM-BOT 2.0 will not be able to go over thresholds of 5mm or higher. If you are not planning to use the mop for cleaning, separate the mop before using HOM-BOT 2.0.

Loading the remote controller battery

1. Open the battery cover by lifting the rear hook of the remote controller.
2. Insert two AAA batteries, checking for +, - nodes while loading.
3. Close the battery cover completely so that the batteries will not fall out.

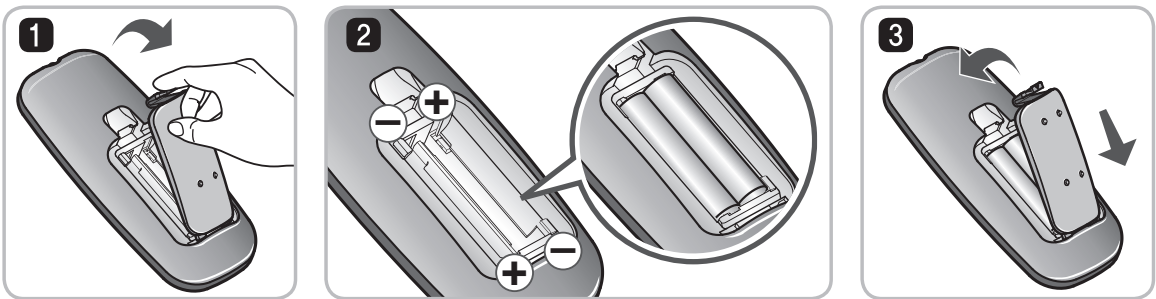

Precautions while using the remote control

- Only press one button at a time.
- Do not drop or subject it to forceful impact.
- Do not store it near devices that give off heat, fire or hot air.
- Certain fluorescent lamps, such as 3 wavelength fluorescent lamps, can interfere with the activation of the remote control. Therefore, use it as far away as possible from such lamps.
- If the remote control is far from the HOM-BOT 2.0 when activated, it may fail to operate properly. Use the device within 3 m (9.84 ft) of the HOM-BOT 2.0 if possible.

OVERVIEW

1

Install the home station. (Page 13)

Insert the power cord plug into an outlet and locate the station against a wall. If power is not supplied to the home station, the HOM-BOT 2.0 will not charge.

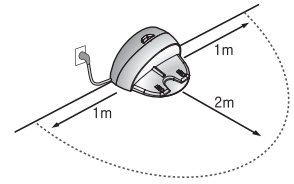

2

Turn on the power supply of the HOM-BOT 2.0. (Page 14)

Turn on the power switch located on the bottom of the HOM-BOT 2.0 and press the upper START/STOP button to turn on the power supply.

※ If the power supply is not turned on, refer to page 14.

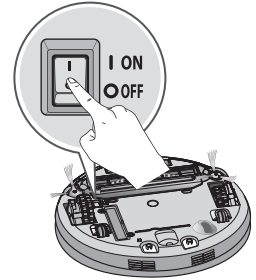

3

Check the dust bin.

Check the cleanness of the dust bin before start cleaning and close the cover of the dust bin on the main unit.

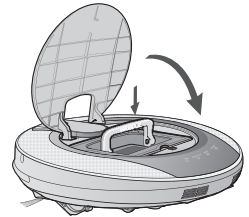

4

Start cleaning. (Page 15)

Press the START/STOP button once again while the HOM-BOT 2.0 is turned on. You will hear the sound of cleaning and cleaning will begin.

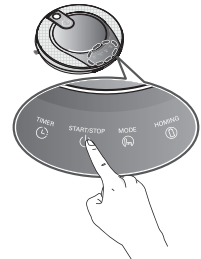

5

Automatic charge. (Page 16-17)

The HOM-BOT 2.0 will self-diagnose and automatically return to the home station to recharge before the complete discharge of the battery. It takes approximately three hours to charge the battery.

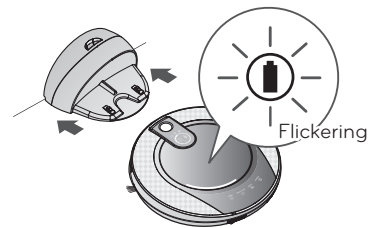

6

Use the cleaning mode and auxiliary functions. (Page 18-22)

With the HOM-BOT 2.0 and remote controller button, the cleaning method and auxiliary functions can be used. Zigzag or spatial expansion cleaning method can be selected for the cleaning mode and manual cleaning, spot cleaning, timer cleaning and micro fiber mop cleaning can be selected for auxiliary function.



< Warning > When HOM-BOT 2.0 is operated with the cover of the dust bin open, it can cause an injury or serious damage to the product.

HOW TO INSTALL THE HOME STATION

How to Install the Home Station

1. Position the home station against a wall, to prevent sliding during docking, on hard level flooring.

Remove objects within 3 ft. to the right and left side and within 6 ft. to the front.

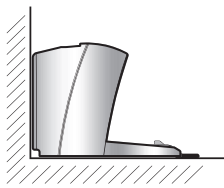

O

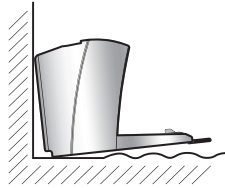

X

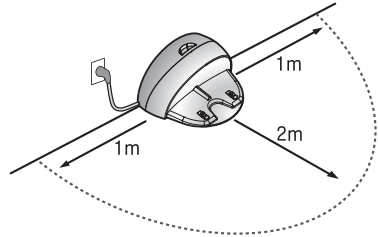

2. Plug the power cord into an outlet.

Wrap the power cord around the fixed hook on the back side of the home station or along the wall surface so that the travel path of the HOM-BOT 2.0 will not be obstructed.

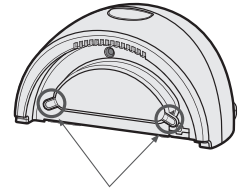

Fixing hook of power cord

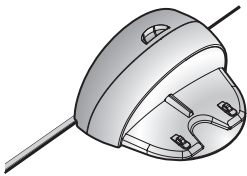

O

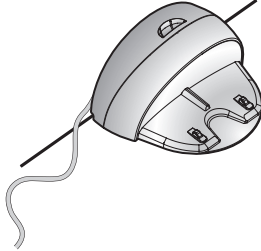

X

3. Fix the home station against the wall so that it does not move.

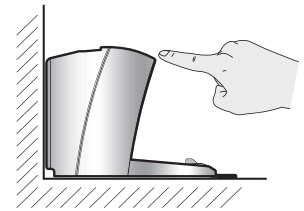

4. When the remote controller is not used, store it on the remote controller holder on the home station.

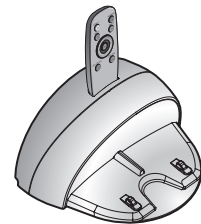

Tip

- Always keep the home station plugged in. If the home station is not plugged in, the HOM-BOT 2.0 will not return to the station to charge automatically.

< Warning >

Do not operate the HOM-BOT 2.0 if it has a damaged cord or plug, if it is not working properly, or if it has been damaged or dropped. To avoid hazard, the cord must be replaced by LG Electronics, Inc. or a qualified service person.

HOW TO TURN THE HOM-BOT 2.0 POWER SUPPLY ON & OFF

Turning on the main power supply

To turn the power supply on, turn the HOM-BOT 2.0 upside down on a smooth/soft surface and check whether the main power supply switch is turned on.

* Please make sure to remove the dust bin before flipping the main body. Otherwise, the dust in the dust bin may fall out.

If the main power supply switch is turned off, turn on the switch.

* When turning on the power switch, do not press the button located at the upper section of the HOM-BOT 2.0. Operation of the button can be delayed.

* Turn off the power switch if the HOM-BOT 2.0 will not be used for a long period of time, in order to protect the battery.

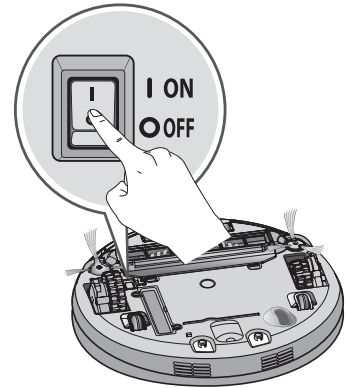

Turning on from Stand By power.

When the HOM-BOT 2.0 is not at the Home Station, and is in the Stand by mode, press the 'START/STOP' button for more than 1 second. The HOM-BOT 2.0 will be turned on and a melody will be sounded.

* HOM-BOT 2.0 will automatically return to the home station to recharge when the charge is low during operation, or if left idle with no cleaning command for more than 10 minutes.

* Do not operate HOM-BOT 2.0 on tables or desks. It will result in an injury or damage to the product when it starts to search for the home station after 10 minutes.

Be sure to turn the main power off from the on/off switch on the underside of the unit when placing HOM-BOT 2.0 on high furniture for storage purposes

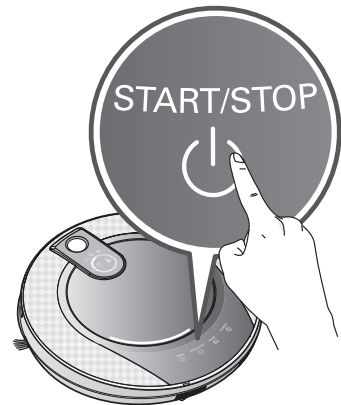

Turning off the power supply

Press the START/STOP button for two seconds while the HOM-BOT 2.0 is turned on. A melody will sound when the power is turned off.



Tip

- If the power cannot be turned on, do the following.
 - Turn on the power switch and wait for more than 3 seconds.
 - Press the 'START/STOP' button when the power switch is turned on.
 - If the power is not turned on or if there is no display but only the "Ting" sound, put the HOM-BOT 2.0 on the home station.
 - If there is no change even when HOM-BOT 2.0 is attached to the home station, press the reset switch located on the rear side of the home station for 3 seconds while the HOM-BOT 2.0 is attached on the home station.

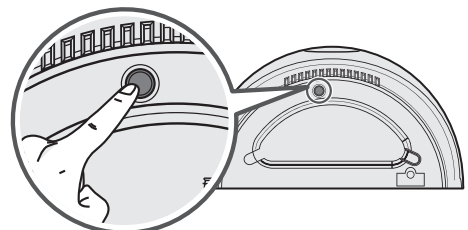

HOW TO START AND STOP CLEANING

Using the buttons on the HOM-BOT 2.0

After the HOM-BOT 2.0 is turned on, press the START/STOP button to begin cleaning. A melody will sound and cleaning will begin.

Press the START/STOP button during the cleaning cycle to stop cleaning.

- * When the 'START/STOP' button is pressed while the power supply of the HOM-BOT 2.0 is turned off, the power will be turned on. Press the 'START/STOP' button one more time to start cleaning.

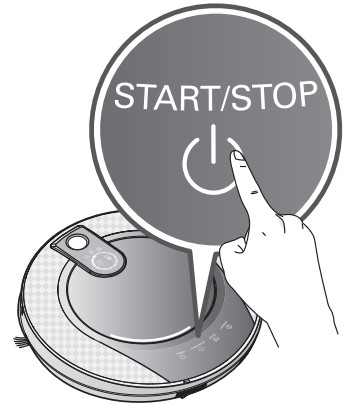

Using the remote control

After the HOM-BOT 2.0 is turned on, press the START button on the remote control. A melody will sound and cleaning will begin.

Press the STOP button during the cleaning cycle to stop cleaning.

- * The HOM-BOT 2.0 cannot be turned on from Stand By, by using the remote control when the power of the HOM-BOT 2.0 is off. When the power is off, press the 'START/STOP' button on the upper side of HOM-BOT 2.0 to turn the power on and to allow the remote to be used.



- * During cleaning, collisions can happen when the sensor cannot detect objects because of their shape (Thin chair and table leg, furniture corner). When this happens, the internal impact detecting sensor will avoid the obstacles by using a backward motion.
- * If the HOM-BOT 2.0 is set to start cleaning at a location away from the home station, put the device on a flat floor in order to prevent a malfunction of the obstacle detecting sensor. In addition, start cleaning from a location where there are not any obstacles such as curtains or walls within 30 cm (11.8 in) of the HOM-BOT 2.0.



Tip

For best results:

- Briefly scan the area to be cleaned for big and small objects that will cause difficulty for the HOM-BOT 2.0.
- If cleaning is started when the HOM-BOT 2.0 is at the home station, the device can rapidly be returned to the home station as the current home position has been accurately read.
- For the safety of the HOM-BOT 2.0, a threshold of more than 10mm (0.4 in) cannot be crossed.
- When the rag plate is installed, to prevent the 2nd contamination by the contaminated rag, it cannot go over door sill of 5mm or higher.

HOW TO CHARGE THE BATTERY

Automatic charging

The HOM-BOT 2.0 returns to the home station at the end of a cleaning cycle or when its battery is running low. When cleaning is started from the Home-station, HOM-BOT 2.0 will show better performance in automatic recharge. (Even in the wide area where the Robot vacuum cleaner cannot see the signal from Home-station, the Robot will remember the location if the cleaning is started from the station.)

- ※ In the event that the unit returns to the Home Station due to a low battery, cleaning will be started, after the charging, from the nearest place of the area which has not been cleaned before. (Page 17)
- ※ If HOM-BOT 2.0 is unable to dock to the home station on its first attempt, it will try again until it docks successfully.
- ※ When HOM-BOT 2.0 completed all areas that it can clean, it will return to the home station even when the battery level is not low.
- ※ HOM-BOT 2.0 will automatically return to the home station to recharge when the charge is low during operation, or if left idle with no cleaning command for more than 10 minutes.
- ※ Do not operate HOM-BOT 2.0 on tables or desks. It will result in an injury or damage to the product when it starts to search for the home station after 10 minutes.
Be sure to turn the main power off from the on/off switch on the underside of the unit when placing HOM-BOT 2.0 on high furniture for storage purposes.

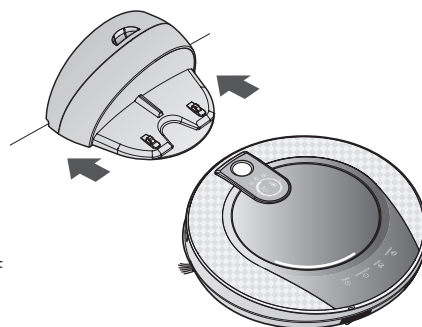

Manual charging

If using the HOM-BOT 2.0 for the first time or when charging the battery during cleaning, you can manually charge the battery.

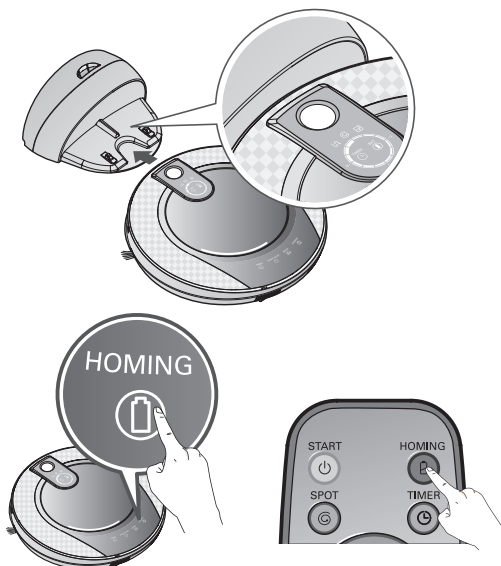

Method 1. Attach the HOM-BOT 2.0 to the home station by aligning to the front side of the home station. A melody sound will be generated along with an audio message to start charging.

- ※ If an audio message saying "Turn on the main power switch on the bottom of the unit" is generated repeatedly when the HOM-BOT 2.0 is attached to the home station, please check the power switch and turn it on.

Method 2. When the HOMING button of the remote control or the HOM-BOT 2.0 is pressed, charging will start by automatically generating a searching sound and returning the HOM-BOT 2.0 to the home station.

- ※ If the HOM-BOT 2.0 does not start cleaning from the home station or if the HOM-BOT 2.0 is manually charged by pressing the charge button, it may take slightly longer to find the home station.
- ※ If the HOM-BOT 2.0 stays within 10 cm (3.9 in) of the front of the charging terminal while the power supply is turned on, it will automatically be returned to the home station and charging will begin.

Tip Take the following precautions when using the home station:

- If foreign material is caught in the charging terminal, charging may not proceed smoothly. Wipe the terminal from time to time with a dry cloth after the power plug is disconnected.
- To prevent electric shock, do not touch the charging terminal with any metallic objects.
- To avoid fire or electric shock, never disassemble or modify the home station.
- Do not to place the home station or power plug near to a heating appliance.

HOW TO CHARGE THE BATTERY

Remaining Battery Charge Indicator

The remaining battery charge can be confirmed from the charge indication light, which will indicate charge as follows:

- During charging, the charge remaining indication light will flicker.
- When charging is completed at the home station, only the battery icon will illuminate to save power.
- The battery icon will flicker when battery charging is required.

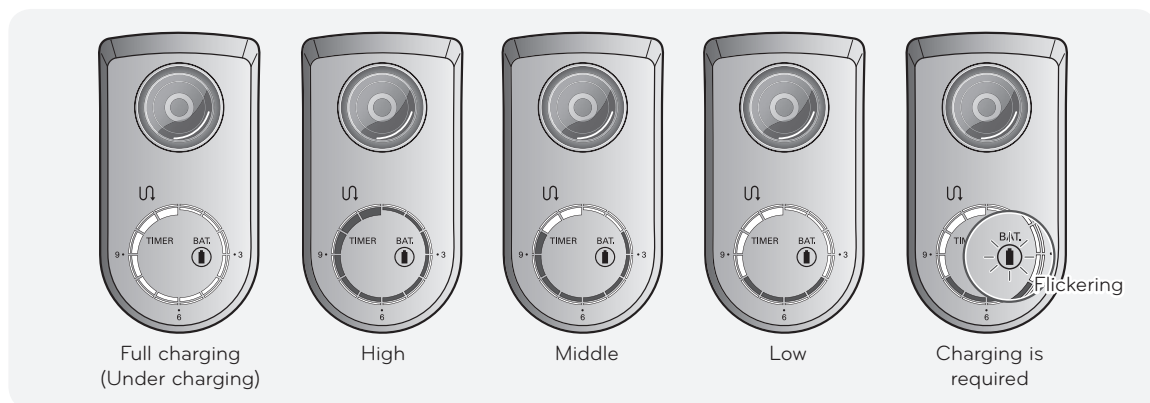

* If there is still an area to be cleaned when the HOM-BOT 2.0 is returned to the home station for charging, the selected cleaning mode is displayed.

- When the battery is fully charged, it cleans the area that remains to be cleaned. (Perform 1 time)
- During charging, when the cleaning mode is displayed, pressing the START button on the remote controller or the START/STOP button on HOM-BOT 2.0 will cause the HOM-BOT 2.0 to search for the un-cleaned area and start cleaning.
- Pressing the mode selection button (ZIGZAG, CELL BY CELL) will start the cleaning process from the beginning.

The status indication lamp while the robot is charged (In spatial expand mode)

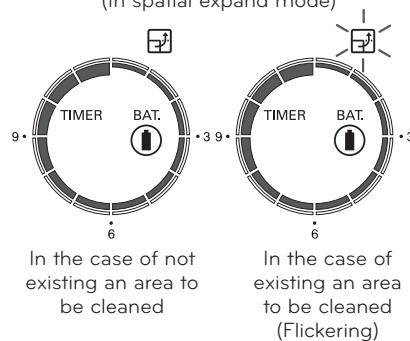

If the Battery is Not Charging

Check 1:

If the battery is not charging even when the HOM-BOT 2.0 is attached to the home station, check the following items.

- Turn the power switch on the bottom of the HOM-BOT 2.0 off once and then on again.
- Check the power lamp of the home station.
- Wipe the terminal on the home station with a dry cloth

Check 2:

If the battery is still not charging after the previous check, try the following.

- Attach the HOM-BOT 2.0 to the home station.
- Press the reset button at the rear of the home station for three seconds.

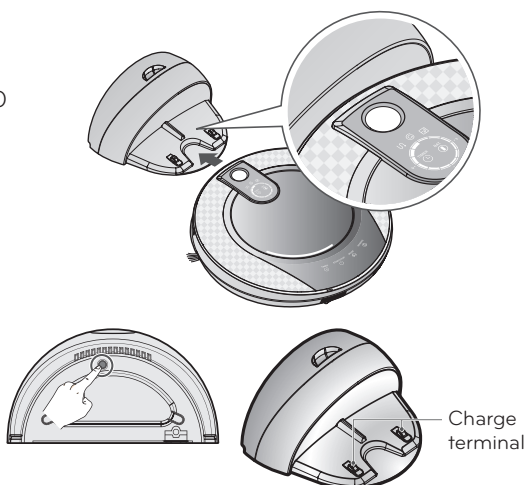

CLEANING MODES

Zigzag Cleaning

With zigzag cleaning, total inside of the house will be cleaned with the repetition of zigzag traveling.

If rapid cleaning is desired, use zigzag cleaning.

When pressing 'ZIGZAG' button of remote controller, zigzag cleaning will be started while zigzag cleaning icon is indicated at the state indication lamp.

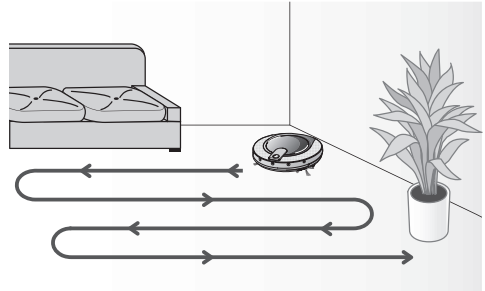
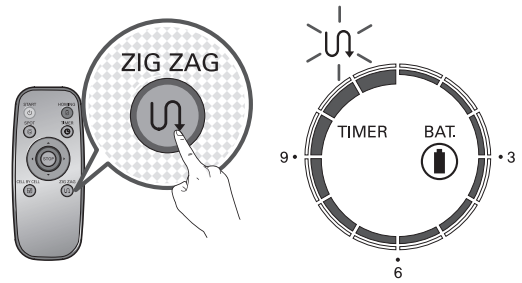

Spatial Expansion Cleaning

With spatial expansion cleaning, the cleaning will be performed by dividing the inside of the house into partial square spaces.

If elaborate cleaning is desired, use spatial expansion cleaning.

When pressing 'Cell by Cell' button of remote controller, spatial expansion cleaning will be started while spatial expansion cleaning icon is indicated at the state indication lamp.

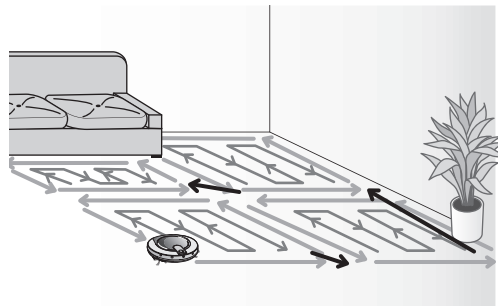
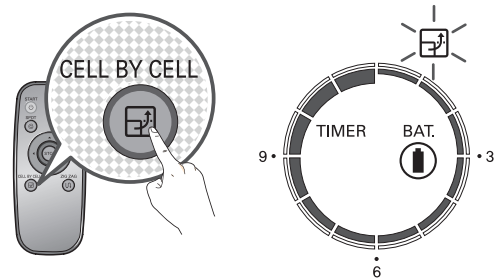

The 1st stage:

The maximum outline of 3m x 3m of cleaning area will be cleaned. (The size of outline will be changed in accordance with the shape of the house inside.)

The 2nd stage:

Inside of the outline will be cleaned with zigzag traveling.

When the 1st, 2nd stages are completed, the inside of the house will be cleaned through the repetition of above cleaning method as the device is being moved to the next cleaning area.



Tip

- Once set up, the cleaning mode will be maintained even after the power supply is turned off.
- During operation, if a mode change is required, press the STOP button and then select the mode.

AUXILIARY CLEANING MODES

Manual cleaning

This method of cleaning involves manually moving the HOM-BOT 2.0 by pressing the directional (arrow) buttons on the remote control.

The interior space will be cleaned by the HOM-BOT 2.0 as it is being moved to the front, rear, or rotated to the left and right side according to the input of the directional buttons.

If it meets an obstacle during manual cleaning (straight driving), it stops.

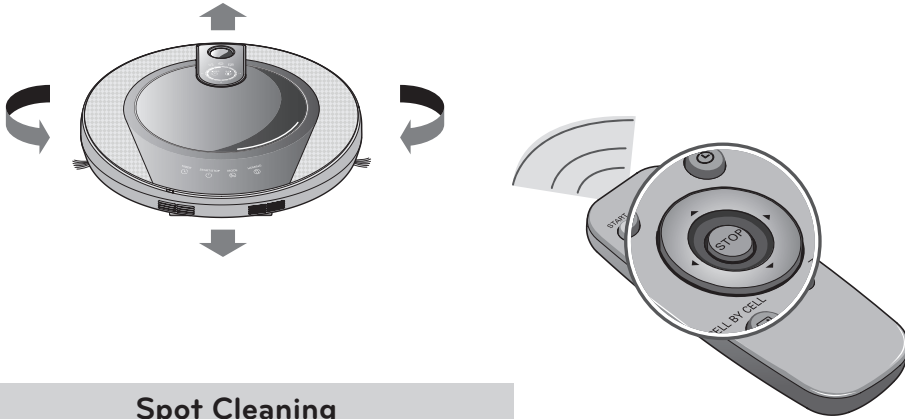

Spot Cleaning

Use this cleaning method when concentrated cleaning of a small interior space is required.

After moving the HOM-BOT 2.0 to the location to be cleaned, press the SPOT button on the remote control.

The spot cleaning icon will illuminate on the HOM-BOT 2.0, and concentrated cleaning will be performed for a space within a radius of 1 m (3.28 ft).

* During charging, the spot cleaning button on the remote control will not activate.

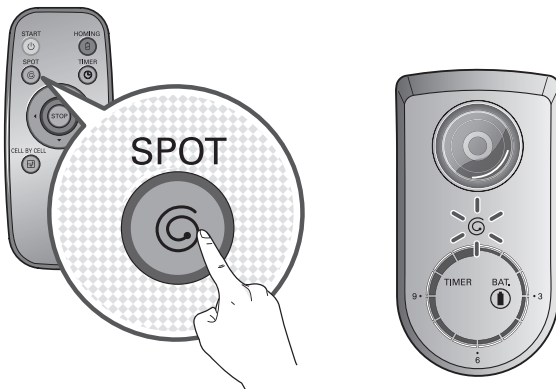

It stops at the started position after completing the cleaning (takes 4~5 min.).

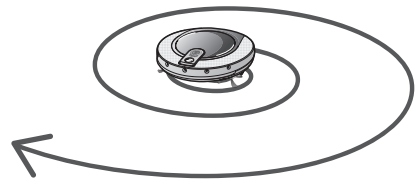

* The following device show weaker on inhalation than ordinary vacuum cleaner, but with rotation brush and side rotation brushes, the device shows similar performance on cleaning as ordinary vacuum cleaner.

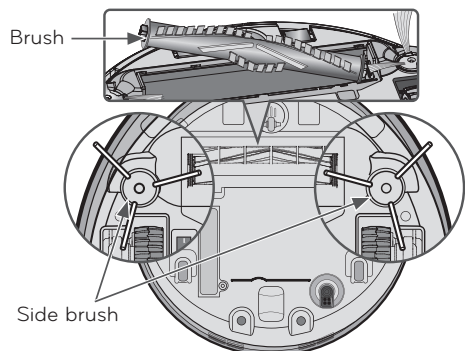

TIMER CLEANING

Set the timer to schedule the cleaning and begin in 1-12 hours. The timer setting is restricted if there is no dust bin.

1. By pressing the TIMER button on the remote control or the HOM-BOT 2.0, a cleaning time can be scheduled.

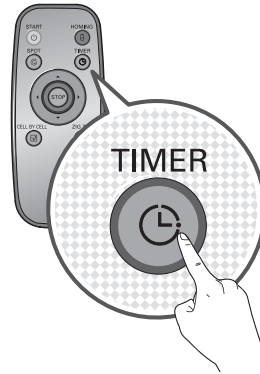

2. Adjust the time as much as desired by multiple presses of the TIMER button. Each time you press the button, the time will increase by one hour.

- The start time can be set up to a maximum of 12 hours and once set up, the time in hours, will be indicated by the status indication lamps.

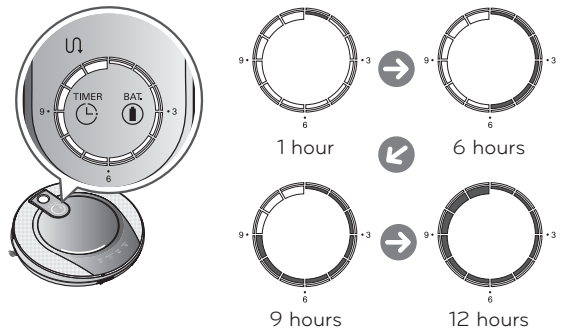

3. After setting up the start time, press the START/STOP button on the HOM-BOT 2.0 or wait about five seconds. When the timer setting is complete, a melody will sound, and the timer indicator will remain on.

- If the timer is set, timer icon of a clock shape is displayed on the status indicator lamp.



Tip

- When the set up time elapses, cleaning will start automatically.
- Use the timer setting when the HOM-BOT 2.0 is attached to the home station. If the timer is set while HOM-BOT 2.0 is away from the home station, the cleaning time can be shortened.
- To cancel the timer setting during the set up time, press the STOP button on the remote control or the START/STOP button on the HOM-BOT 2.0.

MOP CLEANING (OPTION)

By attaching the ultra microfiber mop, you can effectively use the HOM-BOT 2.0 to remove dust.

When the mop plate is attached, the HOM-BOT 2.0 will not climb on to carpets or over thresholds, in order to prevent transferring dirt from the mop.

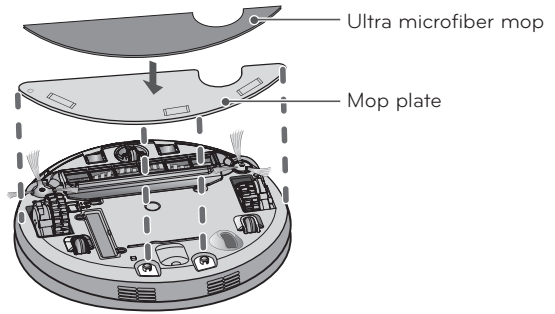

For mop cleaning, mount the mop and mop plate to the HOM-BOT 2.0 according to the following instructions:

1. Attach the ultra microfiber mop to the Velcro of the mop plate as shown in the figure.

※ To prevent the HOM-BOT 2.0 from malfunctioning, attach the mop so that the mop attaching guide will not be covered by the mop.

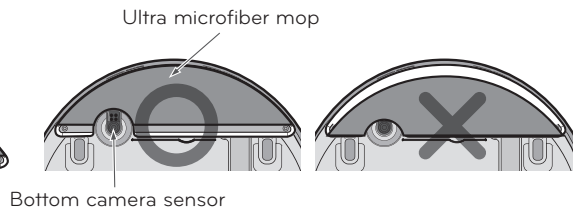
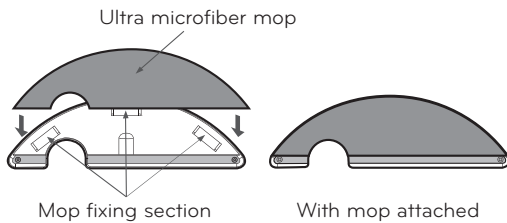
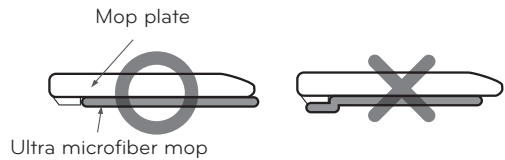

2. Accurately match up and insert the mop plate fixing hook on the lower section of the HOM-BOT 2.0 into the fixing groove of the mop plate.

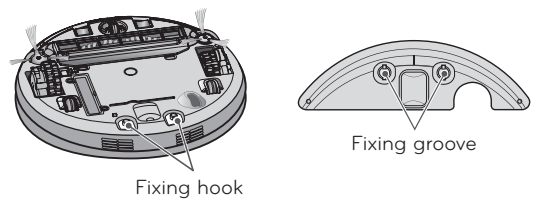

3. When you accurately match up and press the mop plate to the rear side of the HOM-BOT 2.0, it will mount with a clicking sound.

※ Be careful to properly mount the mop plate, or it can separate during cleaning.



Tip

- To avoid odors, wash any foreign material or dust off the mop after cleaning is complete.
- To avoid staining floors, do not use the ultra microfiber mop to clean when dirt is mixed with liquids such as coffee or ink.
- To avoid damage to carpets from the Velcro or dirt transfer from the mop, do not clean the carpet while the mop plate or mop is attached.
- Keep the ultra microfiber mop dry. Do not use it on wet surfaces. If there is moisture, it can interfere with the navigation.

LOCATION SEARCH FUNCTION

HOM-BOT 2.0 remembers its location while cleaning.

If the user moves the HOM-BOT 2.0 while it is operating, it will search its location with the location search function to continue from previous location.

When the user removes any abnormal condition of HOM-BOT 2.0 or moves the location arbitrarily, the location search function will activate.

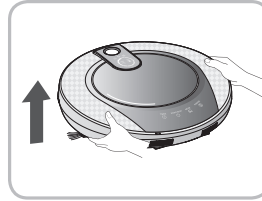

Change location

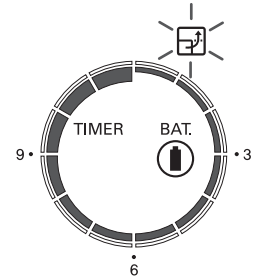

When the location search function is activated, the cleaning mode of the status indicator will flash

1. Locate HOM-BOT 2.0 near the location where HOM-BOT 2.0 was moved.

- * Location search is more effective when HOM-BOT 2.0 is closer to the location where it was moved.
- * If it goes out of diameter of 1m from the occurrence position, it becomes difficult to search the position.

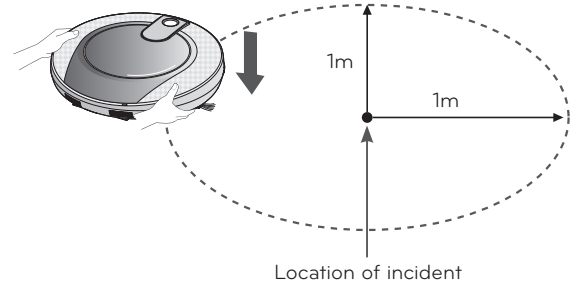

2. Press the START/STOP button on HOM-BOT 2.0 or START button on the remote controller. HOM-BOT 2.0 will start the location search function along with an audio guide.

- * When the location search is successfully completed, HOM-BOT 2.0 will continue to the cleaning from where it was moved. If position search fails, it will start again from the beginning.

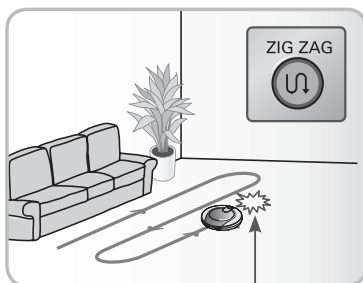

Location of incident

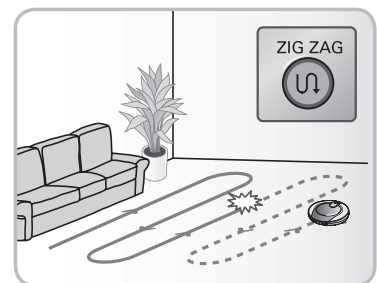

Tip

- When the power is turned off after the location search function is set, the location search function will be canceled.
- Location search is more effective when HOM-BOT 2.0 is closer to the location where it was moved.
- After position search function is set, if timer is set or it is recharged, then the setting will be cancelled.

CLEANING THE DUST BIN

If the dust bin is full, suction power can be weakened. Clean the dust bin before and after each cleaning session. Clean the dust bin using the following sequence:

1. Open the dust bin cover by pressing the PUSH button on the HOM-BOT 2.0.

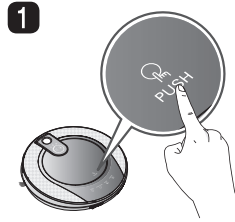

2. Grab the handle of the dust bin and pull it upward.

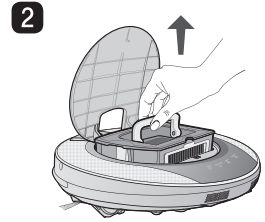

3. Separate the HEPA filter and the inside sponge filter by removing the HEPA filter
* To clean the dust bin filter, refer to page 24.

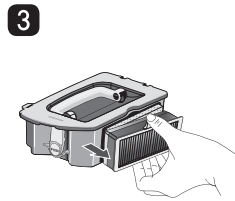

4. Lift the cover upward while pressing the separation button on the dust bin.

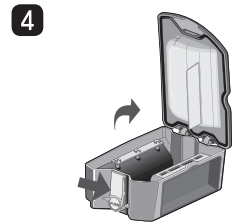

5. Empty the dust bin and clean it with a cleaning brush or under running water.
* Please use vacuum cleaner when cleaning the filter.
(Be sure to fully dry the filter after washing it. It may affect inhalation or can make smell.)

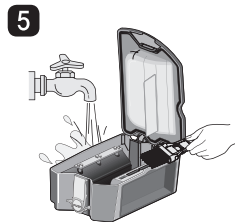

6. After cleaning with water, completely dry the dust bin in a well-ventilated area out of the direct sunlight.

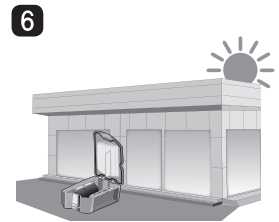

7. When you have completed cleaning the dust bin, close the cover and replace the sponge filter and HEPA filter.

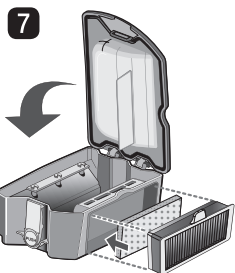

8. Put the dust bin into the HOM-BOT 2.0 and close the dust bin cover.

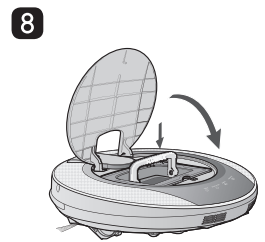

Tip

- After cleaning, always mount the dust bin filters (HEPA filter, sponge filter) to the dust bin. If they are not mounted, dust may enter the HOM-BOT 2.0 interior and cause product failure.
- After cleaning the dust bin, make sure to start the operation with the dust bin installed. If it is operated without the dust bin, voice message, "please check the dust bin" will sound.

CLEANING THE DUST BIN FILTER

The dust bin filters are comprised of the HEPA filter and the sponge filter.
Clean the HEPA filter and the sponge filter according to the following sequence:

1. Separate the HEPA filter and the inside sponge filter by removing the HEPA filter (as shown).

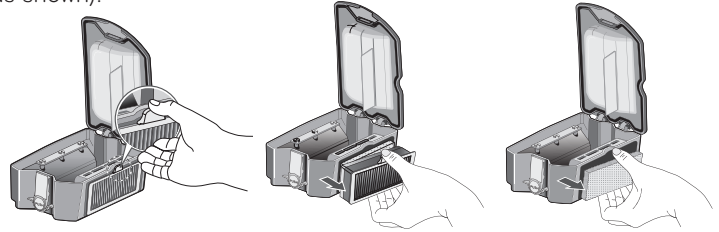

2. Carefully clean any fine dust off the HEPA filter and the sponge filter with a vacuum cleaner or water.

※ When cleaning the filter with vacuum cleaner, be careful not to suck the sponge filter with vacuum cleaner.

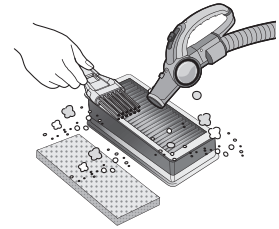

3. After washing the HEPA filter and the sponge filter with water, place them out of direct sunlight and allow them to dry completely.

※ Please use vacuum cleaner when cleaning the filter. (Be sure to fully dry the filter after washing it. It may affect inhalation or can make smell.)

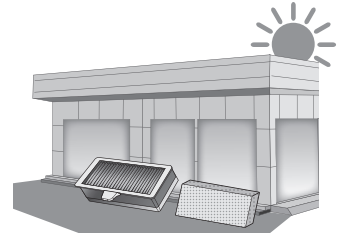

4. Mount the cleaned HEPA filter and sponge filter into the dust bin according to the sequence shown to the right. When assembling the filter, the filter handle should face upward.

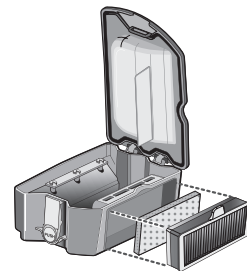
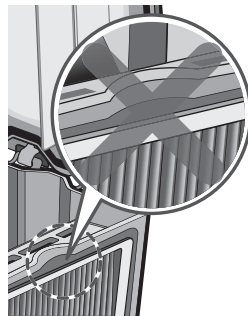
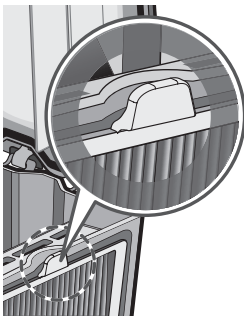

Tip

- For better performance of HOM-BOT 2.0, please clean the HEPA filter once a week using cleaning brush or vacuum cleaner.

CLEANING THE BRUSH

The brush, located on the bottom of the HOM-BOT 2.0, helps with the suction of foreign objects. Perform the following steps to clean the brush:

※ Please make sure to remove the dust bin before flipping the main body. Otherwise, the dust in the dust bin may fall out.

- 1 Lay a smooth cloth on the floor. Turn the HOM-BOT 2.0 over and put the HOM-BOT 2.0 on the cloth. Turn off the power switch before cleaning.

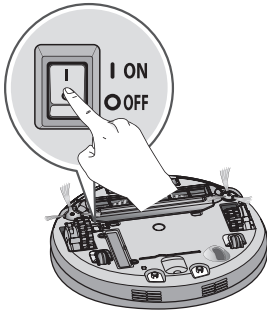

- 2 Separate the cover by pressing the fixing hook and pulling upward.

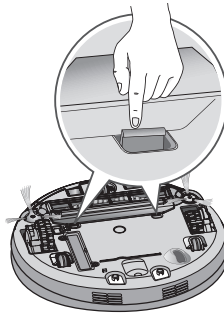

- 3 Wearing gloves turn the brush until the separation groove of the brush appears.

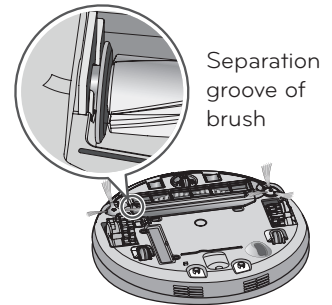

- 4 Grab the brush and remove by pulling it up.

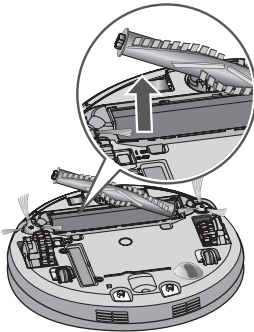

- 5 Clean the brush with a vacuum cleaner, scissors, etc.

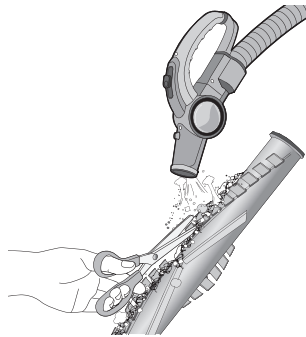

- 6 Insert the fixing hook on the side of the brush (marked with the square) by matching it to the fixing groove of the brush.

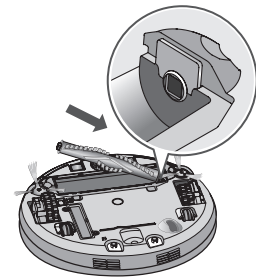

- 7 Insert the fixing hook on the opposite side of the brush (marked with a rounded rectangle) by matching it to the separation groove of the brush.

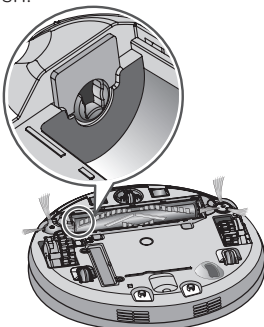

- 8 Insert the fixing guide in front of the brush by matching it to the fixing groove located on the main unit.

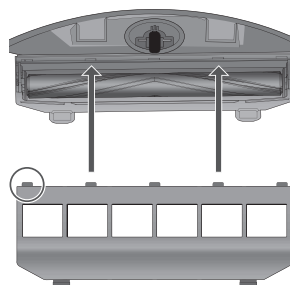

- 9 Close the cover by pressing it down until you hear a click from the fixing hook. ※ Be careful that the side brush is not caught by the cover.

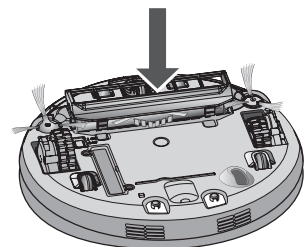

CLEANING THE SENSOR/CHARGING TERMINAL

There are sensors on the HOM-BOT 2.0 that can detect obstacles, stairways and the home station for charging the battery. In order to maintain the performance of the HOM-BOT 2.0, regularly clean the sensors and charging terminal as follows:

1. Lay a smooth cloth on the floor, overturn the HOM-BOT 2.0 and put it on the cloth.
*** Please make sure to remove the dust bin before flipping the main body. Otherwise, the dust in the dust bin may fall out.**
2. Turn off the power switch on the bottom of the HOM-BOT 2.0. Injury can be caused by the activation of the HOM-BOT 2.0 if the main power is not turned off.
3. Use a smooth cloth or cleaning brush to wipe the dust off each sensor and the charging terminal as described below.

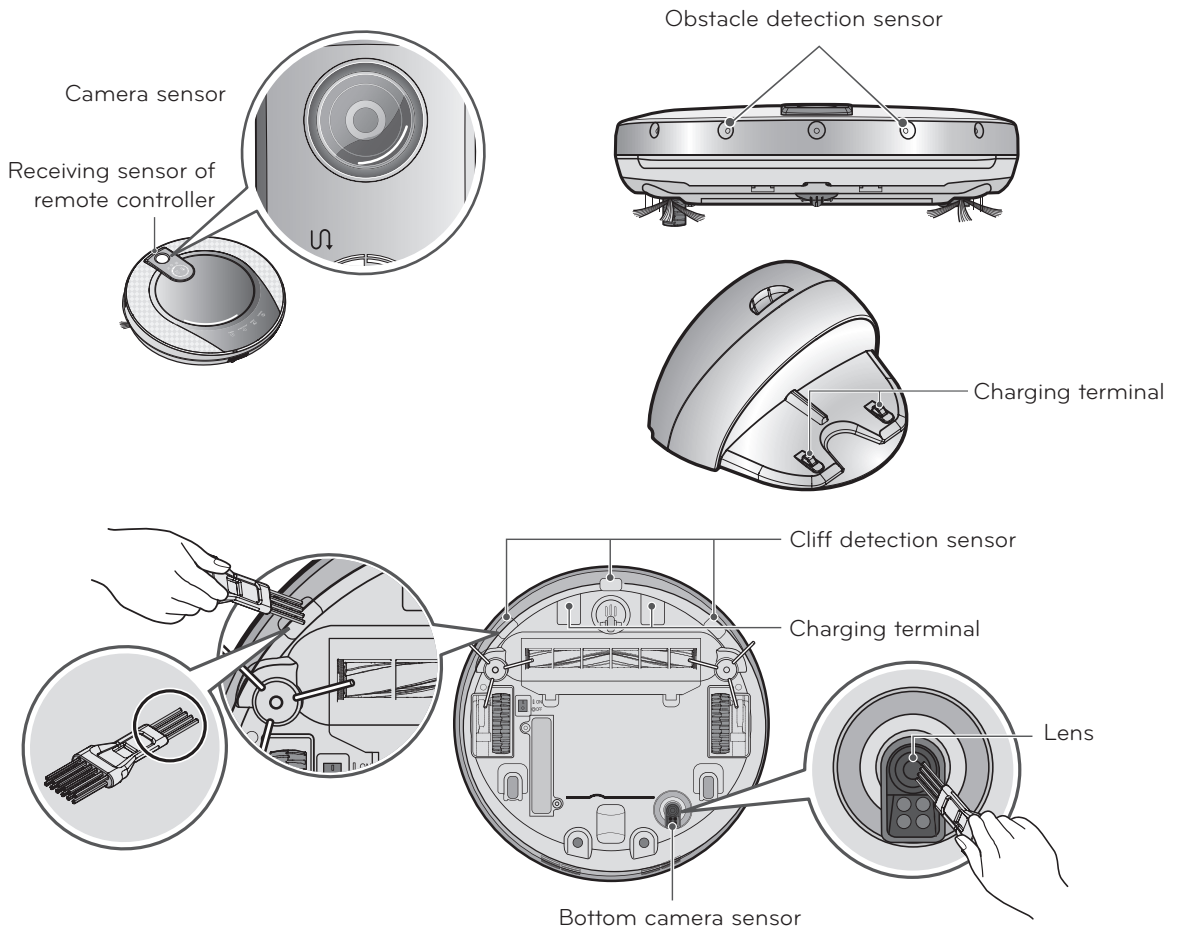
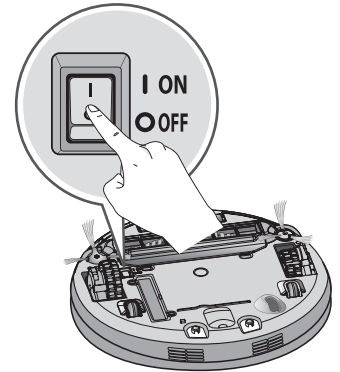

*** The device may move backwards while operating when the cliff sensor or bottom camera sensor is contaminated.**

Please clean the sensor with soft brush or cleaning brush.



Tip

- Do not clean the HOM-BOT 2.0 by directly spraying it with water, thinner, benzene, etc.
- Call the service center if the sensor or charging terminal is damaged. Sensor and terminal damage can cause the product to malfunction.

CLEANING THE SIDE BRUSH

Foreign objects/materials such as hair can easily adhere to the side brush. Remove such materials at least once a week.

If excessive amounts of foreign materials are stuck to the brush, there is the risk of damage to the brushes.

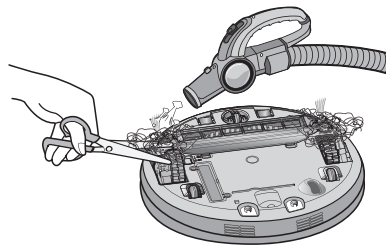

If the floor is rough or walls are frequently cleaned, the side brush may bend or become damaged. In this case, use the following method to straighten the side brush.

1. The following procedure is helpful in restoring deformed brushes.
2. Turn off the power supply by pressing the START/STOP button on the HOM-BOT 2.0 for two seconds.
3. Place the HOM-BOT 2.0 at the end of a table to make cleaning the side brush easier. Make sure that the HOM-BOT 2.0 is not in danger of falling.
4. Soak the side brush in warm water.
5. Press down on the side brush for about ten seconds so that it is completely submerged in the water.
6. Slowly wipe the side brush by sliding it through your hand.
7. Rotate the side brush and repeat steps 4-6 for each section of the brush.
8. Use the side brush only after it has completely dried.

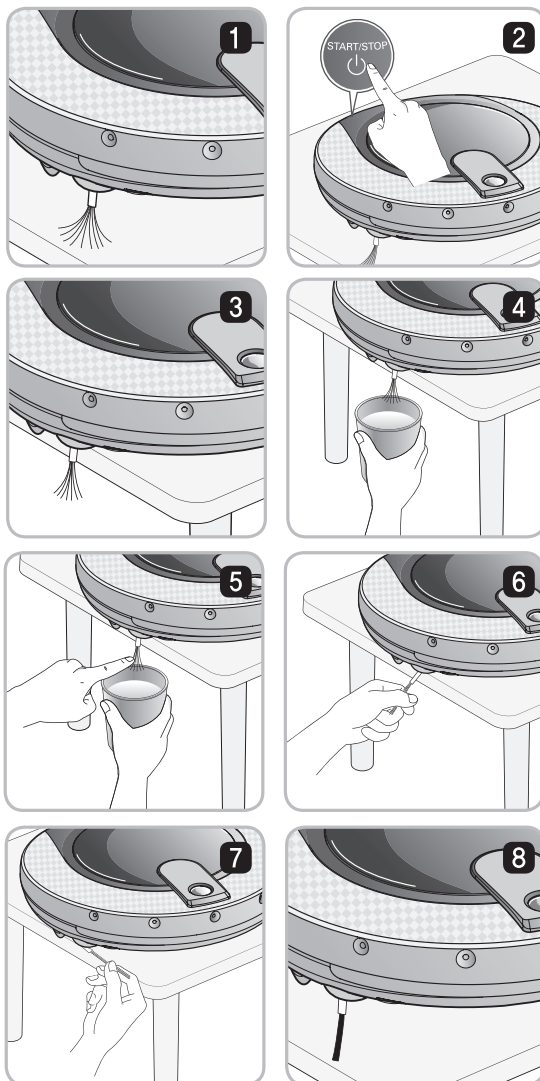

How to change the side brush

1. Remove the screw and separate the side brush.
2. Exchange and re-assemble new side brushes.

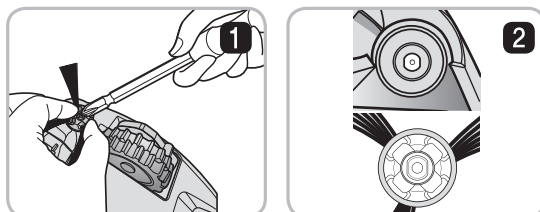

CLEANING THE ULTRA MICROFIBER MOP (OPTION)

To avoid odors, dirt and dust should be washed off the mop after it is used for cleaning. Follow these directions to wash the ultra microfiber mop:

1. Separate the ultra microfiber mop from the mop plate.

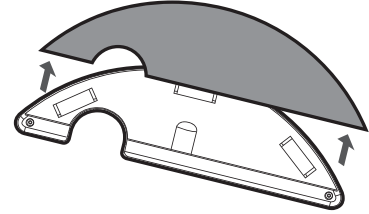

2. Carefully clean it with water.



3. Use the mop only after allowing it to dry completely in a sunny, well-ventilated area.

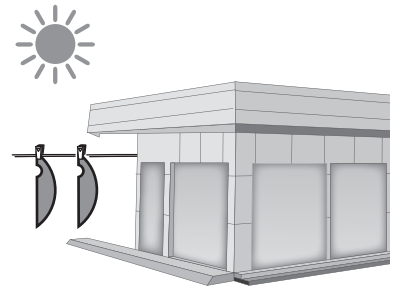

Tip

- To avoid product malfunction, only use the ultra microfiber mop provided with the HOM-BOT 2.0.
- Additional microfiber mops can be purchased by visiting a nearby LG Electronics service center.

TROUBLESHOOTING

When the voice, "Please check the wheels", is announced.

If the unit becomes stuck or suspended and the wheels do not allow the unit to move, the voice, "Please check the wheels", will be announced.

- Is a wheel trapped in the front door, balcony, stairway, etc?
 - ▶ Move the HOM-BOT 2.0 on to the flat floor.

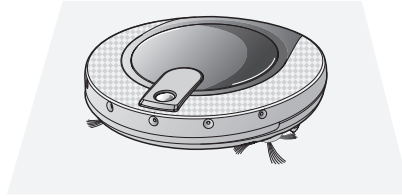
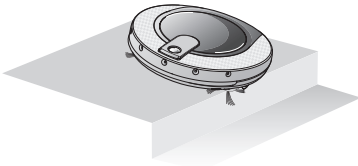

- Is any foreign material wound around the wheel?
 - ▶ Lay smooth cloth on the floor, overturn the HOM-BOT 2.0, and put it on the cloth. Remove foreign material by confirming the wheel.
 - ※ **Please make sure to remove the dust bin before flipping the main body. Otherwise, the dust in the dust bin may fall out.**

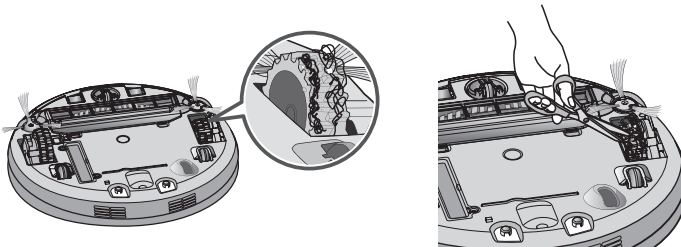

- Is the HOM-BOT 2.0 stuck?
 - ▶ After removing the part that is stuck, place the HOM-BOT 2.0 on flat floor.

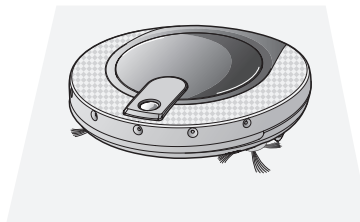
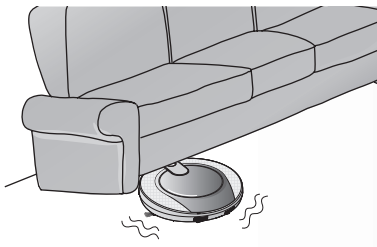

TROUBLESHOOTING

When the voice, "Please check the dust bin", is announced

When an abnormality is detected with the dust bin, the voice, "Please check the dust bin", is announced.

- Is the dust bin fitted correctly?
 - ▶ Open the dust bin cover, and if check if the dust bin is actually fitted. The unit will not operate without the dust bin.
 - ▶ If the dust bin cover is opened, close the cover before operating the unit.

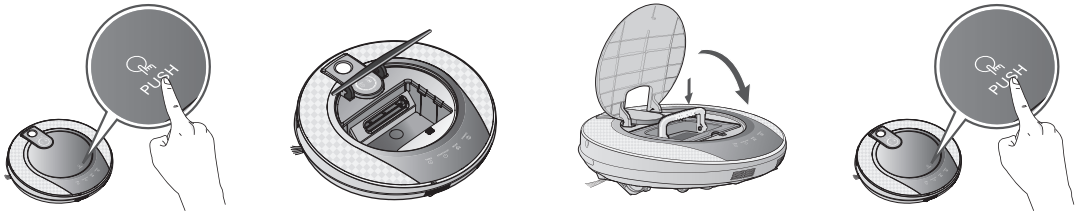

When the voice, "Battery is low", is announced.

When remaining amount of battery is almost nil, the voice, "Battery is low", is generated.

- Initiate battery charging of HOM-BOT 2.0 by moving it to the home station.
 - ▶ If HOM-BOT 2.0 is attached to the docking station, it will start the recharging with the recharging start melody.

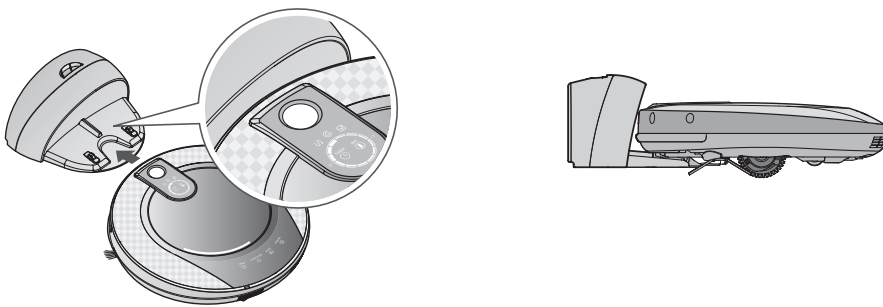

TROUBLESHOOTING

When the voice, "Please check the brush", is announced

When the HOM-BOT 2.0 detects that the brush is not functioning properly, you will hear the message "Please check the brush."

Lay a smooth cloth on the floor, overturn the HOM-BOT 2.0, and place it on the cloth.

*** Please make sure to remove the dust bin before flipping the main body.
Otherwise, the dust in the dust bin may fall out.**

• The side brush is stuck.

▶ Remove any foreign materials such as cables, thread or hair caught in the side brush or the brush.

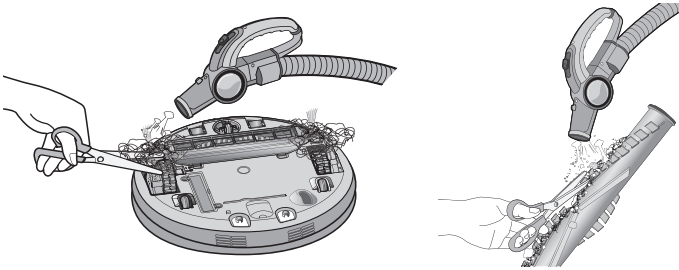

▶ Confirm the correct assembly of the brush by checking the separation groove of the brush.

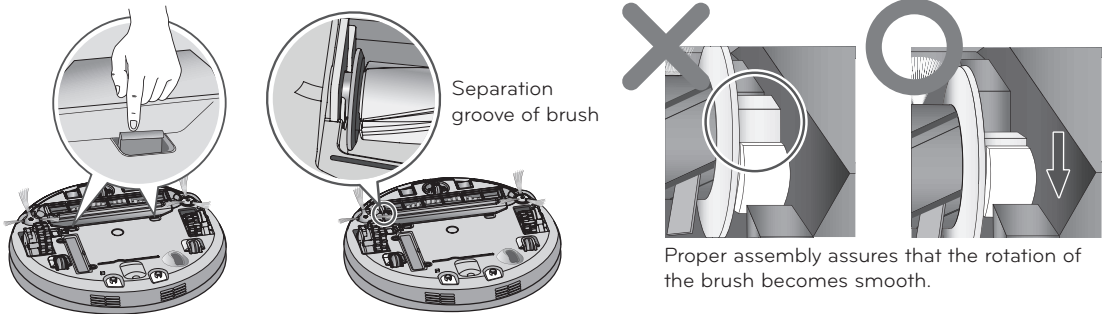

• The brush is making a loud, abnormal sound.

▶ Remove the brush from the HOM-BOT 2.0 and remove any foreign material from the brush.

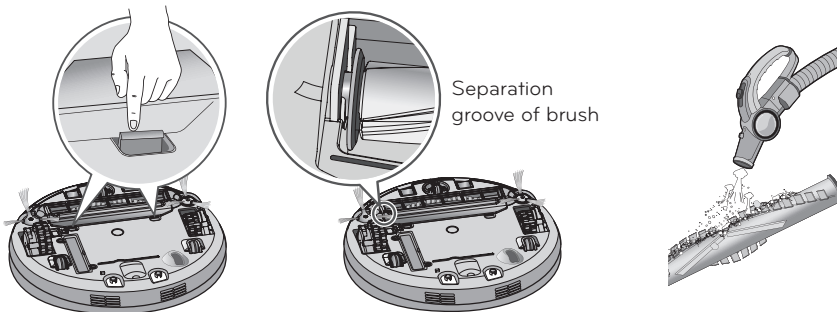

*** For a more detailed description of this process, refer to the instructions on page 25.**

BEFORE YOU CALL FOR SERVICE

Confirm before reporting the failure of HOM-BOT 2.0.

| Problem | Solutions (Reference page) |
|--|---|
| The HOM-BOT 2.0 will not activate. | <ul style="list-style-type: none"> ▶ Confirm that the power switch is turned on. (Page 14) ▶ Confirm that the battery has been charged. (Page 17) |
| Movements or travel path are abnormal. | <ul style="list-style-type: none"> ▶ Carefully wipe the sensor with a smooth cloth. (Page 26) ▶ If the ultra microfiber mop is attached, confirm that it is mounted properly. (Page 21) ▶ Turn on the power switch off and on. |
| Suction power becomes weak. | <ul style="list-style-type: none"> ▶ Check whether there is foreign material blocking the suction port. (Page 25) ▶ Empty the dust bin. (Page 23) ▶ Clean the dust bin filter. (Page 24) |
| Noise becomes louder. | <ul style="list-style-type: none"> ▶ Confirm that the dust bin has been mounted properly. ▶ Confirm that the dust bin filter has been mounted properly. (Page 24) ▶ Check whether foreign material is caught in the brush. (Page 25) ▶ Please check if there is any tape, gum or other kind of foreign materials are on the wheel. |
| The HOM-BOT 2.0 cannot be activated with the remote control. | <ul style="list-style-type: none"> ▶ Replace the remote control batteries. (Page 11) ▶ Confirm that the control is within the coverage area of the main unit, which is less than 3 m or 9.84 ft. (Page 11) ▶ Check whether the main power switch on the bottom is turned on. (Page 14) |
| The brush does not rotate. | <ul style="list-style-type: none"> ▶ Clean the brush. (Page 25) ▶ Confirm that the brush has been mounted properly. (Page 25) |
| The HOM-BOT 2.0 will not charge. | <ul style="list-style-type: none"> ▶ Remove objects around the home station. (Page 13) ▶ Confirm that the power supply is connected to the home station. (Page 13) ▶ Wipe the charging terminal with a dry cloth. ▶ Press the reset button on the back of the home station for 3 seconds while the HOM-BOT 2.0 is attached to the home station. (Page 14) |
| Automatically starts searching for home station. Automatically turns the power off. | HOM-BOT 2.0 will automatically return to the home station to recharge when it's left uncharged or without cleaning order for more than 10 minutes. |
| The power supply cannot be turned on. | Check that the power switch is turned on. (Page 14) |

PRODUCT SPECIFICATIONS

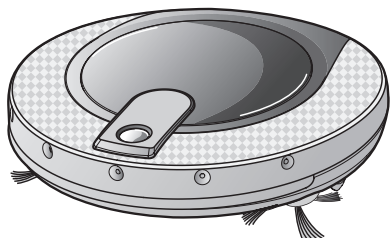

| Item/Model | LG HOM-BOT 2.0 VR6170LVM, VR6171LVM |
|--------------------------|---|
| External Dimensions | Φ 360 mm X 90 mm |
| Weight | 3.2 kg |
| Power Consumption | 18 W |
| Battery (Fully Charging) | DC 16.8 V |
| Traveling Velocity | 350 mm/sec |
| Use Time | Approx. 100 minutes (Based on general wooden floor) |
| Charging Time | 3 hours |
| Main Functions | Obstacle detection Fall prevention Timer cleaning Error indication Location search Automatic, manual charging Dry mop (Wiping) Corner cleaning Voice output Map building Spot cleaning Spatial expansion cleaning Zigzag cleaning |

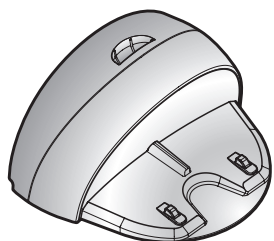

| Item/Model | Home Station VR607 |
|------------------------|--------------------------|
| External Dimensions | 245 mm X 193 mm X 132 mm |
| Rating | 230 V~ 50 Hz |
| Output Voltage/Current | 17.1 V / 1.1 A |
| Power Consumption | 23 W |

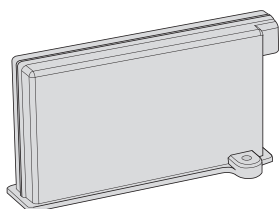

| Item/Model | Battery |
|------------|-----------------------------|
| Type | Lithium Ion Polymer Battery |

REFERENCE ITEMS

Open source software notice

To obtain the source code under GPL, LGPL, MPL and other open source licenses, that is contained in this product, please visit <http://opensource.lge.com>.

In addition to the source code, all referred license terms, warranty disclaimers and copyright notices are available for download.



Disposal of waste batteries/accumulators

1. When this crossed-out wheeled bin symbol is attached to batteries/accumulators of Your product it means they are covered by European Directive 2006/06/EC.
2. This symbol may be combined with chemical symbols for mercury(Hg), cadmium(Cd) or lead(Pb) if the battery Contains more that 0.0005% of mercury, 0.002% of cadmium or 0.004% of lead.
3. All batteries/accumulators should be disposed separately from the municipal waste stream via designated collection facilities appointed by the government or the local authorities.
4. The correct disposal of Your old batteries/accumulators will help to prevent potential negative consequences for the environment, animal and human health.
5. For more detailed information about disposal of Your old batteries/accumulators, please contact Your city office, waste disposal service or the shop where You purchased the product.



Disposal of your old appliance

1. When this crossed-out wheeled bin symbol is attached to a product it means the product is covered by the European Directive 2002/96/EC.
2. All electrical and electronic products should be disposed of separately from the municipal waste stream via designated collection facilities appointed by the government or the local authorities.
3. The correct disposal of your old appliance will help prevent potential negative consequences for the environment and human health.
4. For more detailed information about disposal of your old appliance, please contact your city office, waste disposal service or the shop where you purchased the product.

