



OWNER'S MANUAL

Smart TV Upgrader

Please read this manual carefully before operating your set and retain it for future reference.

SP520/SP520N

P/NO : SAC35454707

Safety information



CAUTION: TO REDUCE THE RISK OF ELECTRIC SHOCK DO NOT REMOVE COVER (OR BACK) NO USER-SERVICEABLE PARTS INSIDE REFER SERVICING TO QUALIFIED SERVICE PERSONNEL.



This lightning flash with arrowhead symbol within an equilateral triangle is intended to alert the user to the presence of uninsulated dangerous voltage within the product's enclosure that may be of sufficient magnitude to constitute a risk of electric shock to persons.



The exclamation point within an equilateral triangle is intended to alert the user to the presence of important operating and maintenance (servicing) instructions in the literature accompanying the product.

WARNING: TO PREVENT FIRE OR ELECTRIC SHOCK HAZARD, DO NOT EXPOSE THIS PRODUCT TO RAIN OR MOISTURE.

WARNING: Do not install this equipment in a confined space such as a book case or similar unit.

CAUTION: Do not block any ventilation openings. Install in accordance with the manufacturer's instructions.

Slots and openings in the cabinet are provided for ventilation and to ensure reliable operation of the product and to protect it from over heating. The openings shall be never be blocked by placing the product on a bed, sofa, rug or other similar surface. This product shall not be placed in a built-in installation such as a bookcase or rack unless proper ventilation is provided or the manufacturer's instruction has been adhered to.

CAUTION concerning the Power Cord

To disconnect power from the mains, pull out the mains cord plug. When installing the product, ensure that the plug is easily accessible.

CAUTION: The apparatus shall not be exposed to water (dripping or splashing) and no objects filled with liquids, such as vases, shall be placed on the apparatus.

This device is equipped with a portable battery or accumulator.

Safety way to remove the battery or the battery from the equipment:

Remove the old battery or battery pack, follow the steps in reverse order than the assembly. To prevent contamination of the environment and bring on possible threat to human and animal health, the old battery or the battery put it in the appropriate container at designated collection points. Do not dispose of batteries or battery together with other waste. It is recommended that you use local, free reimbursement systems batteries and accumulators. The battery shall not be exposed to excessive heat such as sunshine, fire or the like.

Disposal of your old appliance



1. When this crossed-out wheeled bin symbol is attached to a product it means the product is covered by the European Directive 2002/96/EC.
2. All electrical and electronic products shall be disposed of separately from the municipal waste stream via designated collection facilities appointed by the government or the local authorities.
3. The correct disposal of your old appliance will help prevent potential negative consequences for the environment and human health.
4. For more detailed information about disposal of your old appliance, please contact your city office, waste disposal service or the shop where you purchased the product.

Disposal of waste batteries/accumulators



1. When this crossed-out wheeled bin symbol is attached to batteries/accumulators of Your product it means they are covered by European Directive 2006/66/EC.
2. This symbol may be combined with chemical symbols for mercury(Hg), cadmium(Cd) or lead(Pb) if the battery Contains more that 0.0005% of mercury, 0.002% of cadmium or 0.004% of lead.
3. All batteries/accumulators should be disposed separately from the municipal waste stream via designated collection facilities appointed by the government or the local authorities.
4. The correct disposal of Your old batteries/ accumulators will help to prevent potential negative consequences for the environment, animal and human health.
5. For more detailed information about disposal of Your old batteries/accumulators, please contact Your city office, waste disposal service or the shop where You purchased the product.

For Wireless product European Union Notice

CE 0984!

LG Electronics hereby declares that this/ these product(s) is/are

in compliance with the essential requirements and other relevant provisions of Directive 1999/5/EC, 2004/108/EC, 2006/95/EC and 2009/125/EC.

Please contact to the following address for obtaining a copy of the DoC (Declaration of Conformity).

European Standards Centre:

Krijgsman 1, 1186 DM Amstelveen, The Netherlands

- Please note that this is NOT a Customer Service contact point. For Customer Service Information, see Warranty Card or contact the dealer that you purchased this product.

Indoor use only.

RF Radiation Exposure Statement

This equipment should be installed and operated with minimum distance 20cm between the radiator and your body.

Notes on Copyrights

Recording equipment should be used only for lawful copying and you are advised to check carefully what is lawful copying in the area in which you are making a copy. Copying of copyright material such as films or music is unlawful unless permitted by a legal exception or consented to by the rights owner.

Table of Contents

1 Getting Started

- 2 Safety information
- 6 Introduction
 - 6 – About the “” symbol display
 - 6 – File requirement
 - 8 – About DLNA
 - 8 – Certain system requirements
 - 8 – Compatibility notes
- 9 Main unit
- 9 Remote control

2 Connecting

- 10 Connecting the AC adapter
- 10 HDMI connecting to your TV
 - 11 – Resolution setting
- 12 Connecting to an amplifier
 - 12 – Connecting to an amplifier via HDMI Output
 - 13 – Connecting to an amplifier via Digital Audio Output
- 14 Connecting to your home network
 - 14 – Wired network connection
 - 15 – Wired network setup
 - 16 – Wireless network connection
 - 16 – Wireless network setup
- 19 USB device connection
 - 19 – Playback content in the USB device

3 System Setting

- 20 Settings
 - 20 – Adjust the setup settings
 - 20 – [DISPLAY] menu
 - 21 – [LANGUAGE] menu
 - 22 – [AUDIO] menu
 - 23 – [NETWORK] menu
 - 23 – [OTHERS] menu

4 Operating

- 25 General playback
 - 25 – Using [HOME] menu
 - 25 – Playing a file media from a USB device
 - 25 – Playing a file media from a network server
 - 26 – Wi-Fi Direct™ connection
 - 28 – Basic operations for video and audio content
 - 29 – Basic operations for photo content
- 29 Advanced playback
 - 29 – Enlarge the playback image
 - 29 – Repeat playback
 - 29 – Viewing content information
 - 30 – Changing content list view
 - 30 – Selecting a subtitle file
 - 31 – Options while viewing a photo
 - 31 – Listening to music while slide show
- 32 On-Screen display
 - 32 – Displaying content information
 - 32 – Playing from selected time
 - 32 – Listening to a different audio track
 - 32 – Selecting a subtitle language
 - 33 Using the Premium

5 Troubleshooting

- 34 Troubleshooting
- 34 - General
- 34 - Picture
- 35 - Resetting
- 35 - Network
- 35 - Customer support
- 35 - Open source software notice

6 Appendix

- 36 Network software update
- 36 - Network update notification
- 36 - Software update
- 37 About Nero MediaHome 4 Essentials
- 37 - System requirements
- 38 - Installing Nero MediaHome 4 Essentials
- 39 - Sharing files and folders
- 40 Trademarks and licenses
- 41 Audio output specifications
- 42 Specifications
- 43 Maintenance
- 43 - Handling the unit
- 43 Important information relating to network services

1

2

3

4

5

6

Introduction

1 About the “⊘” symbol display

“⊘” may appear on your TV display during operation and indicates that the function explained in this owner’s manual is not available on that specific media.

File requirement

Movie files

File Location	File Extension	Codec Format	Audio Format	Subtitle
USB, DLNA, Windows PC	“.avi”, “.divx”, “.mpg”, “.mpeg”, “.mkv”, “.mp4”, “.asf”, “.wmv”, “.m4v” (DRM free)	DIVX3.xx, DIVX4.xx, DIVX5.xx, DIVX6.xx (standard playback only), XVID, H.264/MPEG-4 AVC, VC-1 SM (WMV3), MPEG1, MPEG2	Dolby Digital, MP3, WMA, AAC, Dolby Digital Plus	SubRip (.srt / .txt), SAMI (.smi), SubStation Alpha (.ssa/.txt), MicroDVD (.sub/.txt), VobSub (.sub), SubViewer 1.0 (.sub), SubViewer 2.0 (.sub/.txt), TMUnit (.txt), DVD Subtitle System (.txt)
USB, DLNA, Mac PC	“.avi”, “.divx”, “.mpg”, “.mpeg”, “.mkv”, “.mp4”, “.m4v” (DRM free)	DIVX3.xx, DIVX4.xx, DIVX5.xx, DIVX6.xx (standard playback only), XVID, H.264/MPEG-4 AVC, VC-1 SM (WMV3), MPEG1, MPEG2	Dolby Digital, MP3, WMA, AAC, Dolby Digital Plus	SubRip (.srt / .txt), SAMI (.smi), SubStation Alpha (.ssa/.txt), MicroDVD (.sub/.txt), SubViewer 1.0 (.sub), SubViewer 2.0 (.sub/.txt), TMUnit (.txt), DVD Subtitle System (.txt)

Music files

File Location	File Extension	Sampling Frequency	Bitrate	Note
USB, DLNA, Windows PC	“.mp3”, “.wma”, “.m4a” (DRM free)	within 32 - 48 kHz (WMA), within 16 - 48 kHz (MP3)	within 20 - 320 kbps (WMA), within 32 - 320 kbps (MP3)	Some audio files are not supported on this unit.
DLNA, Mac PC	“.mp3”, “.m4a” (DRM free)	within 16 - 48 kHz (MP3)	within 32 - 320 kbps (MP3)	

Photo files

File Location	File Extension	Recommended Size	Note
USB, DLNA, Windows PC	“.jpg”, “.jpeg”, “.png”	Less than 4,000 x 3,000 x 24 bit/pixel Less than 3,000 x 3,000 x 32 bit/pixel	Progressive and lossless compression photo image files are not supported.
DLNA, Mac PC	“.jpg”, “.jpeg”, “.png”		

! Note

- The file name is limited to 180 characters.
- Maximum files/Folder: Less than 2000 (total number of files and folders)
- Depending on the size and number of the files, it may take several minutes to read the content on the media.
- File compatibility may differ depending on the server.
- Because the compatibility on DLNA server are tested on the bundle DLNA server (Nero MediaHome 4 Essentials) environment, file requirements and playback functions may differ depending on media servers.
- Supplied bundle DLNA server for Macintosh edition has limitations in file compatibility, such as ASF, WMA and WMV.
- The file requirements on page 6 are not always compatible. There may have some restrictions by file features and media server's ability.
- Playing video subtitle files are only available on DLNA media server created by supplied Nero MediaHome 4 Essentials software on this player package.
- The files from removable media such as USB drive etc. on your media server may not be shared properly.
- This unit cannot support the ID3 Tag embedded MP3 file.
- The total playback time of audio file indicated on the screen may not correct for VBR files.
- HD video files contained on the USB 1.0/1.1 may not played properly. USB 2.0 are recommended to play back HD video files.
- This unit supports H.264/MPEG-4 AVC profile Main, High at Level 4.1. For a file with higher level, the warning message will appear on the screen.
- This unit does not support files that are recorded with GMC or Qpel.
- GMC – Global Motion Compensation
- Qpel – Quarter pixel

About DLNA

This Unit is a DLNA Certified digital media unit that can display and play movie, photo and music content from your DLNA-compatible digital media server (PC and Consumer Electronics).

The Digital Living Network Alliance (DLNA) is a cross-industry organization of consumer electronics, computing industry and mobile device companies. Digital Living provides consumers with easy sharing of digital media through your home network.

The DLNA certification logo makes it easy to find products that comply with the DLNA Interoperability Guidelines. This unit complies with DLNA Interoperability Guidelines v1.5.

When a PC running DLNA server software or other DLNA compatible device is connected to this unit, some setting changes of software or other devices may be required. Please refer to the operating instructions for the software or device for more information.

Certain system requirements

For high definition video playback:

- High definition display that has HDMI input jacks.

For Dolby® Digital Plus audio playback:

- An amplifier/receiver with a built-in (Dolby Digital, Dolby Digital Plus) decoder.
- Main, center, surround speakers and subwoofer as necessary for chosen format.

Compatibility notes

- If you experience compatibility problems, please contact an authorized Customer Service Center.
- Dolby Digital Plus are supported with maximum 7.1 channels if you use HDMI connection for the audio output of the unit.

Main unit

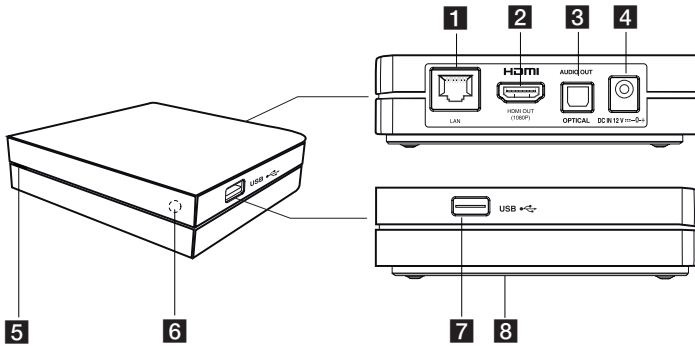

- 1** LAN port
- 2** HDMI OUT (1080p)
- 3** OPTICAL AUDIO OUT
- 4** DC IN 12V (AC adapter input)

- 5** Power indicator
- 6** Remote sensor
- 7** USB port
- 8** RESET

* RESET button is located at the bottom of the unit.

Remote control

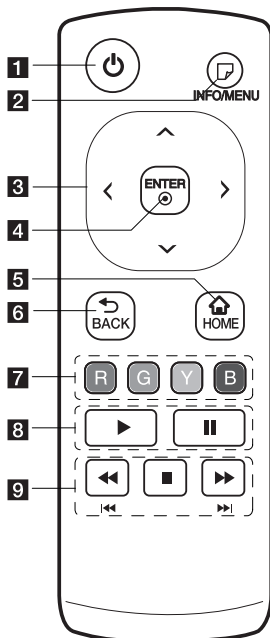

- 1** **⏻ (POWER)**: Switches the unit ON or OFF.
- 2** **ℹ (INFO/MENU)**: Displays or exits On-Screen Display.
- 3** **Direction buttons**: Selects an option in the menu.
- 4** **ENTER (⊙)**: Enters the selected item.
- 5** **HOME (🏠)**: Displays or exits the Home Menu.
- 6** **BACK (↶)**: Exits the menu or return to the previous screen.
- 7** **Colored (R, G, Y, B) buttons**: Use to navigate screen menus. They are also used for [Premium] menu.
- 8** **▶**: Starts playback.
⏸: Pauses playback.

- 9** **⏮/⏭**: Searches backward or forward.
⏮/⏭: Press and hold for two seconds to skip previous/next chapter or file.
■: Stops playback.

Battery Installation

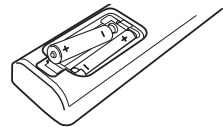

Remove the battery cover on the rear of the Remote Control, and insert two R03 (size AAA) batteries with **+** and **-** matched correctly.

Connecting the AC adapter

Connect the unit to the power supply with the supplied AC adapter.
Connect the power cord to the adapter, and then plug the other end into an AC outlet.

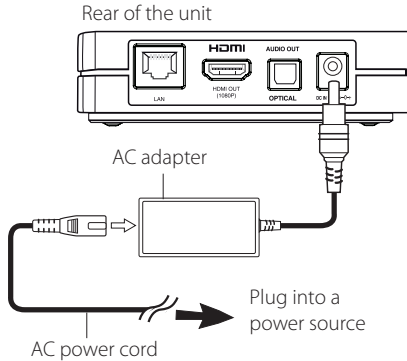

- Contact an electrical parts distributor for assistance in selecting a suitable AC plug adapter or AC power cord set.
- This AC adapter is manufactured by Asian Power Devices Inc.

Caution

Only use the AC adapter supplied with this device. Do not use a power supply from another device or manufacturer. Using any other power cable or power supply may cause damage to the device and void your warranty.

HDMI connecting to your TV

If you have a HDMI TV or monitor, you can connect it to this unit using a HDMI cable (Type A, High Speed HDMI™ Cable). Connect the HDMI jack on the unit to the HDMI jack on a HDMI compatible TV or monitor.

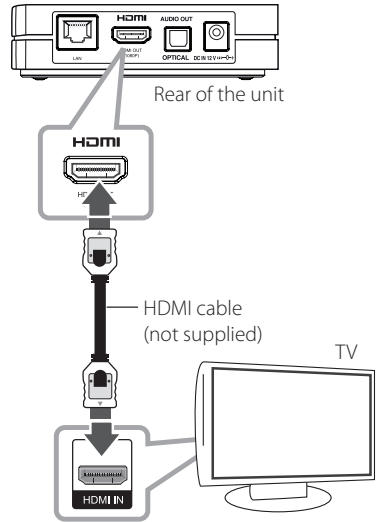

Set the TV's source to HDMI (refer to TV's Owner's manual).

Note

- If you select a resolution manually and then connect the HDMI jack to TV and your TV does not accept it, the resolution setting is set to [Auto].
- If you select a resolution that your TV does not accept, the warning message will appear. After changing resolution, if you cannot see the screen, please wait 20 seconds and the resolution will automatically revert back to the previous resolution.
- The 1080p video output frame rate may be automatically set to either 24 Hz or 50. Hz depending both on the capability and preference of the connected TV.

Additional Information for HDMI

- When you connect a HDMI or DVI compatible device make sure of the following:
 - Try switching off the HDMI/DVI device and this unit. Next, switch on the HDMI/DVI device and leave it for around 30 seconds, then switch on this unit.
 - The connected device's video input is set correctly for this unit.
 - The connected device is compatible with 720x576p, 1280x720p, 1920x1080i or 1920x1080p video input.
- Not all HDCP-compatible HDMI or DVI devices will work with this unit.
 - The picture will not be displayed properly with non-HDCP device.

! Note

- If a connected HDMI device does not accept the audio output of the unit, the HDMI device's audio sound may be distorted or may not output.
- When you use HDMI connection, you can change the resolution for the HDMI output. (Refer to "Resolution Setting" on page 11)
- Select the type of video output from the HDMI OUT jack using [HDMI Color Setting] option on the [Setup] menu (see page 21).
- Changing the resolution when the connection has already been established may result in malfunctions. To solve the problem, turn off the unit and then turn it on again.
- When the HDMI connection with HDCP is not verified, TV screen is changed to black screen. In this case, check the HDMI connection, or disconnect the HDMI cable.
- If there are noises or lines on the screen, please check the HDMI cable (length is generally limited to 4.5 m(15 ft)).

Resolution setting

The unit provides several output resolutions for HDMI OUT. You can change the resolution using [Setup] menu.

1. Press HOME (🏠).
2. Use </> to select the [Setup] and press ENTER (⊙). The [Setup] menu appears.
3. Use ^/∨ to select [DISPLAY] option then press > to move to the second level.
4. Use ^/∨ to select the [Resolution] option then press ENTER (⊙) to move to the third level.

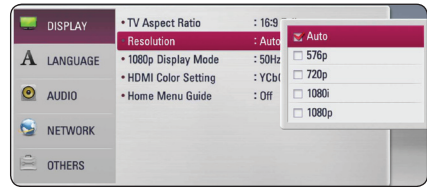

5. Use ^/∨ to select the desired resolution then press ENTER (⊙) to confirm your selection.

Connecting to an amplifier

Make one of the following connections, depending on the capabilities of your existing equipment.

- HDMI Audio connection (page 12)
- Digital Audio connection (page 13)

Since many factors affect the type of audio output, see "Audio Output Specifications" on page 41 for details.

About Digital Multi-channel sound

A digital multi-channel connection provides the best sound quality. For this, you need a multi-channel Audio/Video Receiver that supports one or more of the audio formats supported by your unit. Check the logos on the front of the Audio/Video receiver and the manual. (PCM Stereo, Dolby Digital, Dolby Digital Plus)

Connecting to an amplifier via HDMI Output

Connect the unit's HDMI OUT jack to the corresponding jack on your amplifier using a HDMI cable.

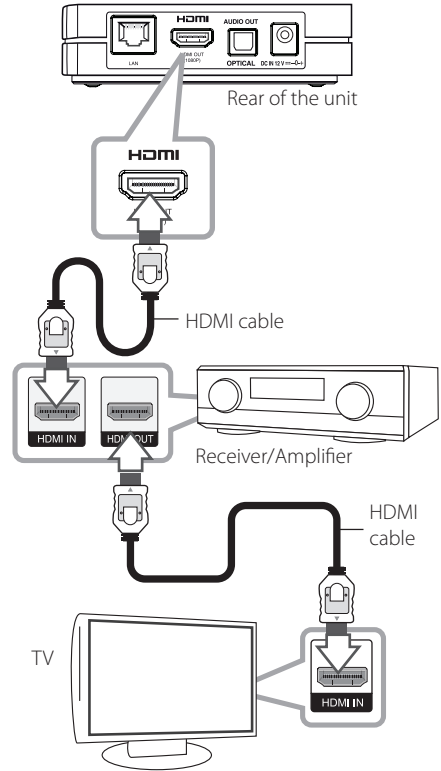

Connect the amplifier's HDMI output jack to HDMI input jack on your TV using a HDMI cable if your amplifier has HDMI output jack.

You will need to activate the unit's digital output. (See "[AUDIO] Menu" on page 22)

Connecting to an amplifier via Digital Audio Output

Connect the unit's OPTICAL AUDIO OUT jack to the corresponding in jack (OPTICAL) on your amplifier using an optional digital audio cable.

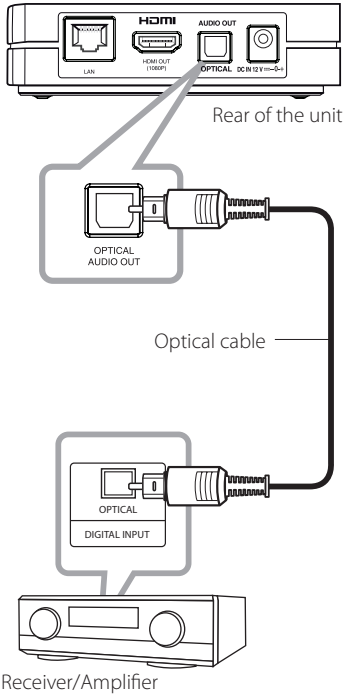

You will need to activate the unit's digital output.
(See "[AUDIO] Menu" on page 22.)

Connecting to your home network

This unit can be connected to a local area network (LAN) via the LAN port on the rear panel or the internal wireless module.

By connecting the unit to a broadband home network, you have access to services such as software updates and online content services.

Wired network connection

Using a wired network provides the best performance, because the attached devices connect directly to the network and are not subject to radio frequency interference.

Please refer to the documentation for your network device for further instructions.

Connect the unit's LAN port to the corresponding port on your Modem or Router using a commercially available LAN or Ethernet cable.

! Note

- When plugging or unplugging the LAN cable, hold the plug portion of the cable. When unplugging, do not pull on the LAN cable but unplug while pressing down on the lock.
- Do not connect a modular phone cable to the LAN port.
- Since there are various connection configurations, please follow the specifications of your telecommunication carrier or internet service provider.
- If you want to access content from PCs or DLNA servers, this unit must be connected to the same local area network with them via a router.

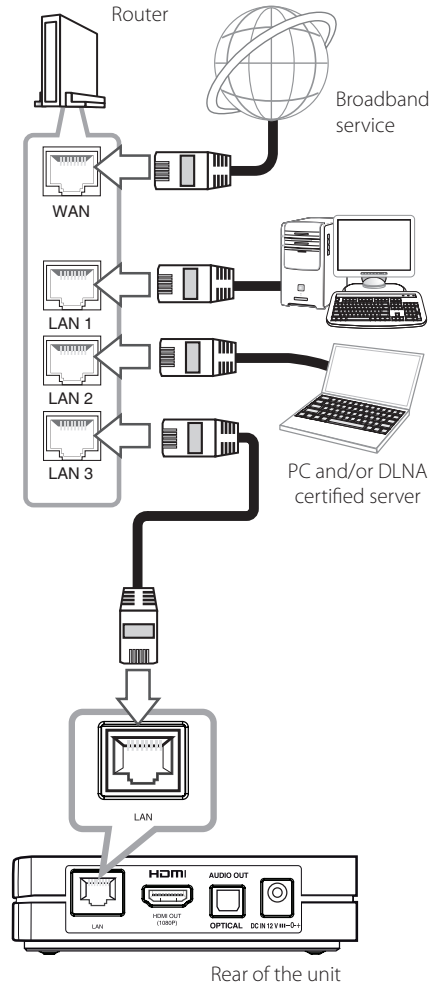

Wired network setup

If there is a DHCP server on the local area network (LAN) via wired connection, this unit will automatically be allocated an IP address. After making the physical connection, a small number of home networks may require the unit's network setting to be adjusted. Adjust the [NETWORK] setting as follow.

Preparation

Before setting the wired network, you need to connect the broadband internet to your home network.

1. Select [Connection Setting] option in the [Setup] menu then press ENTER (⊙).

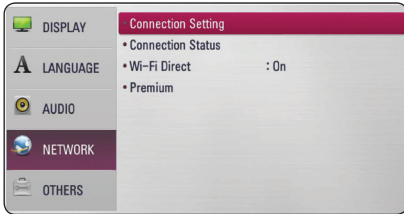

2. The [Connection Setting] menu appear on the screen. Use \wedge/\vee to select the [Wired] and press ENTER (⊙).

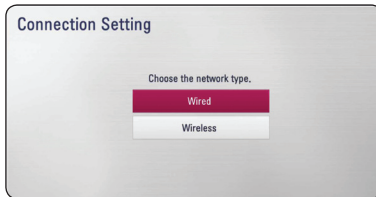

3. Use $\wedge/\vee/\lt;/\gt$ to select the IP mode between [Dynamic] and [Static].

Normally, select [Dynamic] to allocate an IP address automatically.

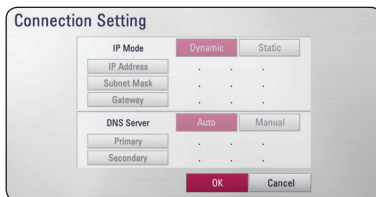

Note

If there is no DHCP server on the network and you want to set the IP address manually, select [Static] then set [IP Address], [Subnet Mask], [Gateway] and [DNS Server] using $\wedge/\vee/\lt;/\gt$.

4. Select [OK] and press ENTER (⊙) to apply network settings.
5. The unit will ask you to test the network connection. Select [OK] and press ENTER (⊙) to complete the network connection.
6. If you select [Test] and press ENTER (⊙) at step 5 above, the network connection status is displayed on the screen. You can also test it on the [Connection Status] in the [Setup] menu.

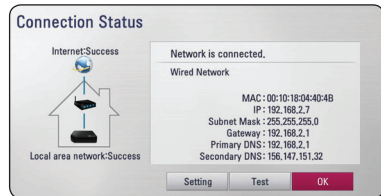

Wireless network connection

Another connection option is to use an Access Point or a wireless router. The network configuration and connection method may vary depending on the equipment in use and the network environment.

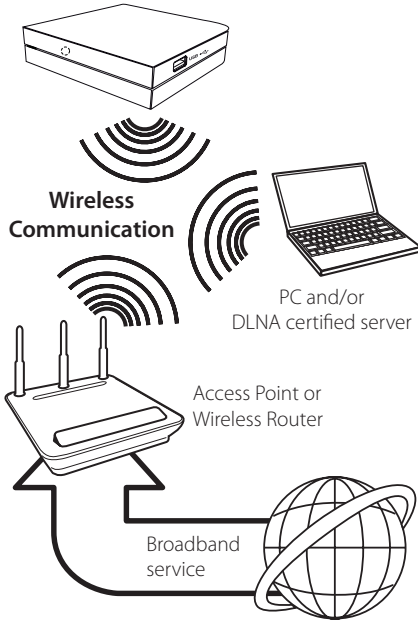

Refer to the setup instructions supplied with your access point or wireless router for detailed connection steps and network settings.

For best performance, a direct wired connection from this unit to your home network's router or cable/DSL modem is always the best option. If you do chose to use the wireless option, note that performance can sometimes be affected by other electronic devices in the home.

Wireless network setup

For the wireless network connection, the unit needs to be set up for network communication. This adjustment can be done from the [Setup] menu. Adjust the [NETWORK] setting as follow. Setting up the access point or the wireless router is required before connecting the unit to the network.

Preparation

Before setting the wireless network, you need to:

- Connect the broadband internet to the wireless home network.
- Set the access point or wireless router.
- Note the SSID and security code of the network.

1. Select [Connection Setting] option in the [Setup] menu then press ENTER (Ⓞ).

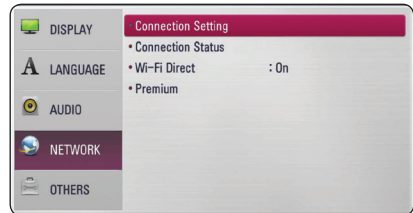

- The [Connection Setting] menu appear on the screen. Use \wedge / \vee to select [Wireless] and press ENTER (⊙).
- Select [Yes] and press ENTER (⊙) to continue. The new connection settings reset the current network settings.
- The unit scans the all available access points or wireless routers within range and display them as a list. Use \wedge / \vee to select an access point or wireless router on the list, and then press ENTER (⊙).

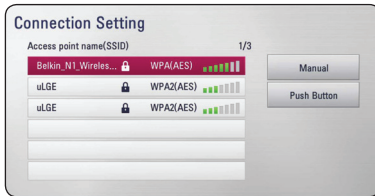

If you have security on your access point or wireless router, verify that the WEP or WPA key that was entered into the unit matches the router's information exactly. You need to input the security code as necessary.

! Note

- WEP security mode generally have 4 keys available on an access point or wireless router's setting. If your access point or wireless router use WEP security, enter the security code of the key "No.1" to connect on your home network.
- An Access Point is a device that allows you to connect to your home network wirelessly.
- If your access point or wireless router supports the PIN Code configuration method based on WPS(Wi-Fi Protected Setup), press yellow (Y) colored button and note the code number on the screen. And then, enter the PIN number on a setting menu of your access point or wireless router to connect. Refer to the documentation for your network device.

[Manual] – Your access point may not be broadcasting its access point name (SSID). Check your router settings through your computer and either set your router to broadcast SSID, or manually enter the access point name (SSID) in [Manual].

[Push Button] – If your access point or wireless router that supports the Push Button Configuration method, select this option and press the Push Button on your access point or wireless router within 120 counts. You do not need to know the access point name (SSID) and security code of your access point or wireless router.

- Use $\wedge / \vee / < / >$ to select the IP mode between [Dynamic] and [Static]. Normally, select [Dynamic] to allocate an IP address automatically.

! Note

If there is no DHCP server on the network and you want to set the IP address manually, select [Static] then set [IP Address], [Subnet Mask], [Gateway] and [DNS Server] using $\wedge / \vee / < / >$. If you make a mistake while entering a number, press [\leftarrow] to clear the highlighted part.

- Select [OK] and press ENTER (⊙) to apply network settings.
- The unit will ask you to test the network connection. Select [OK] and press ENTER (⊙) to complete the network connection.
- If you select [Test] and press ENTER (⊙) at step 7 above, the network connection status is displayed on the screen. You can also test it on the [Connection Status] in the [Setup] menu.

Notes on Network Connection:

- Many network connection problems during set up can often be fixed by re-setting the router or modem. After connecting the unit to the home network, quickly power off and/or connect the power cable of the home network router or cable modem. Then power on and/or connect the power cable again.
- Depending on the internet service provider (ISP), the number of devices that can receive internet service may be limited by the applicable terms of service. For details, contact your ISP.
- Our company is not responsible for any malfunction of the unit and/or the internet connection feature due to communication errors/malfunctions associated with your broadband internet connection, or other connected equipment.
- Some internet content may require a higher bandwidth connection.
- Even if the unit is properly connected and configured, some internet content may not operate properly because of internet congestion, the quality or bandwidth of your internet service, or problems at the provider of the content.
- Some internet connection operations may not be possible due to certain restrictions set by the Internet service provider (ISP) supplying your broadband Internet connection.
- Any fees charged by an ISP including, without limitation, connection charges are your responsibility.
- A 10 Base-T or 100 Base-TX LAN port is required for wired connection to this unit. If your internet service does not allow for such a connection, you will not be able to connect the unit.
- You must use a Router to use xDSL service.
- A DSL modem is required to use DSL service and a cable modem is required to use cable modem service. Depending on the access method of and subscriber agreement with your ISP, you may not be able to use the internet connection feature contained in this unit or you may be limited to the number of devices you can connect at the same time. (If your ISP limits subscription to one device, this unit may not be allowed to connect when a PC is already connected.)
- The use of a "Router" may not be allowed or its usage may be limited depending on the policies and restrictions of your ISP. For details, contact your ISP directly.
- The wireless network operate at 2.4 GHz radio frequencies that are also used by other household devices such as cordless telephone, Bluetooth® devices, microwave oven, and can be affected by interference from them.
- Turn off all unused network equipment in your local home network. Some devices may generate network traffic.
- For the purpose of the better transmission, placing the unit from the access point as close as possible.
- In some instances, placing the access point or wireless router at least 0.45 m (1.5 ft.) above the floor may improve the reception.
- Move closer to the access point if possible or re-orient the unit so there is nothing between it and the access point.
- The reception quality over wireless depends on many factors such as type of the access point, distance between the unit and access point, and the location of the unit.
- Set your access point or wireless router to Infrastructure mode. Ad-hoc mode is not supported.

USB device connection

This unit can play video, audio and photo files contained in the USB device.

Playback content in the USB device

1. Insert a USB device to the USB port until it fits into place.

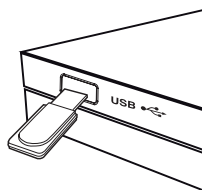

When you connect the USB device on the HOME menu, the unit plays an audio file contained in the USB storage device automatically. If the USB storage device is containing various types of files, a menu for the file type selection will appear.

File loading may takes few minutes depending on the number of content stored in the USB storage device. Press ENTER (⊙) while [Cancel] is selected to stop loading.

2. Press HOME (🏠).
3. Select [Movie], [Photo] or [Music] using </>, and press ENTER (⊙).
4. Select the [USB] option using ^ / v, and press ENTER (⊙).

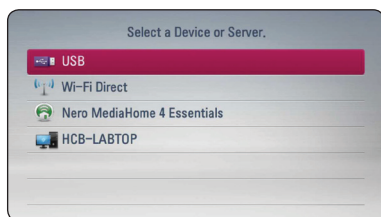

5. Select a file using ^ / v / </>, and press ▶ or ENTER (⊙) to play the file.
6. Withdraw the USB device carefully.

! Note

- This unit supports USB flash drive/external HDD formatted in FAT16, FAT32 and NTFS when accessing files (audio, photo, video).
- This unit can support up to 8 partitions of the USB device.
- Do not extract the USB device during operation (play, etc.).
- A USB device which requires additional program installation when you have connected it to a computer, is not supported.
- USB device: USB device that supports USB1.1 and USB2.0.
- Movie, music and photo files can be played. For details of operations on each file, refer to relevant pages.
- Regular back up is recommended to prevent data loss.
- If you use a USB extension cable, USB HUB or USB Multi-reader, the USB device may not be recognized.
- Some USB device may not work with this unit.
- Digital camera and mobile phone are not supported.
- USB Port of the unit cannot be connected to PC. The unit cannot be used as a storage device.

Settings

Adjust the setup settings

You can change the settings of the unit in the [Setup] menu.

1. Press HOME (🏠).



2. Use </> to select the [Setup] and press ENTER (⊙). The [Setup] menu appears.

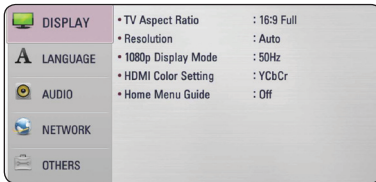

3. Use ^/v to select the first setup option, and press > to move to the second level.

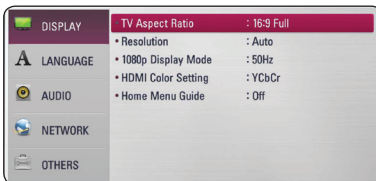

4. Use ^/v to select a second setup option, and press ENTER (⊙) to move to the third level.



5. Use ^/v to select a desired setting, and press ENTER (⊙) to confirm your selection.

[DISPLAY] menu

TV Aspect Ratio

Select a TV aspect ratio option according to your TV type.

[4:3 Letter Box]

Select when a standard 4:3 TV is connected. Displays theatrical images with masking bars above and below the picture.

[4:3 Pan Scan]

Select when a standard 4:3 TV is connected. Displays pictures cropped to fill your TV screen. Both sides of the picture are cut off.

[16:9 Original]

Select when a 16:9 wide TV is connected. The 4:3 picture is displayed with an original 4:3 aspect ratio, with black bars appearing at the left and right sides.

[16:9 Full]

Select when a 16:9 wide TV is connected. The 4:3 picture is adjusted horizontally (in a linear proportion) to fill the entire screen.

! Note

You cannot select [4:3 Letter Box] and [4:3 Pan Scan] option when the resolution is set to higher than 720p.

Resolution

Sets the output resolution of the HDMI video signal. Refer to page 11 for details about the resolution setting.

[Auto]

If the HDMI OUT jack is connected to TVs providing display information (EDID), automatically selects the resolution best suited to the connected TV.

[1080p]

Outputs 1080 lines of progressive video.

[1080i]

Outputs 1080 lines of interlaced video.

[720p]

Outputs 720 lines of progressive video.

[576p]

Outputs 576 lines of progressive video.

1080p Display Mode

When the resolution is set to 1080p, select [24 Hz] for smooth presentation of film material (1080p/24 Hz) with a HDMI-equipped display compatible with 1080p/24 Hz input.

! Note

- When you select [24 Hz], you may experience some picture disturbance when the video switches video and film material. In this case, select [50 Hz].
- Even when [1080p Display Mode] is set to [24 Hz], if your TV is not compatible with 1080p/24 Hz, the actual frame frequency of the video output will be 50 Hz to match the video source format.

HDMI Color Setting

Select the type of output from the HDMI OUT jack. For this setting, please refer to the manuals of your display device.

[YCbCr]

Select when connecting to a HDMI display device.

[RGB]

Select when connecting to a DVI display device.

Home Menu Guide

This function allows you to display or delete the guide bubble on the Home Menu. Set this option to [On] for displaying guide.

[LANGUAGE] menu

Display Menu

Select a language for the [Setup] menu and on-screen display.

[AUDIO] menu

Set the unit's Audio options according to the type of audio system you use.

! Note

Since many factors affect the type of audio output, see "Audio Output Specifications" on page 41 for details.

HDMI / Digital Output

[PCM Stereo]

Select if you connect this unit's HDMI OUT or DIGITAL AUDIO OUT jack to a device with two-channel digital stereo decoder.

[Primary Pass-Thru]

Select if you connect this unit's DIGITAL AUDIO OUT and HDMI OUT jack to a device with LPCM and Dolby Digital, Dolby Digital Plus.

Sampling Freq. (Digital Audio Output)

[192 kHz]

Select this if your A/V Receiver or Amplifier is capable of handling 192 kHz signals.

[96 kHz]

Select this if your A/V Receiver or Amplifier is not capable of handling 192 kHz signals. When this choice is made, this unit automatically converts any 192 kHz signals to 96 kHz so your system can decode them.

[48 kHz]

Select this if your A/V Receiver or Amplifier is not capable of handling 192 kHz and 96 kHz signal. When this choice is made, this unit automatically converts any 192 kHz and 96 kHz signals to 48 kHz so your system can decode them.

Check the documentation for your A/V Receiver or Amplifier to verify its capabilities.

DRC (Dynamic Range Control)

This function allows you to listen to a movie at a lower volume without losing clarity of sound.

[Off]

Turns off this function.

[On]

Compress the dynamic range of the Dolby Digital or Dolby Digital Plus audio output.

[Auto]

The dynamic range of the Dolby Digital and Dolby Digital Plus are operated as same as the [On] mode.

! Note

The DRC setting can be changed only the unit is in complete stop mode.

[NETWORK] menu

The [NETWORK] settings are needed to use the software update, Web Browser and online content services.

Connection Setting

If your home network environment is ready to connect the unit, the unit needs to be set the wired or wireless network connection for network communication. (See "Connecting to your Home Network" on page 14.)

Connection Status

If you want to check the network status on this unit, select the [Connection Status] options and press ENTER (⊙) to check whether a connection to the network and the internet have been established.

Wi-Fi Direct

This player is a Wi-Fi Direct™ certified device. Wi-Fi Direct™ is the technology that devices to connect each other without connecting to an Access point or a router. Set this option to [On] for activating the Wi-Fi Direct™ mode. Refer to page 26 for the device connection.

Premium

[Country Setting]

Select your area for displaying proper services and content on the [Premium] feature.

[OTHERS] menu

DivX® VOD

ABOUT DIVX VIDEO: DivX® is a digital video format created by DivX, LLC, a subsidiary of Rovi Corporation. This is an official DivX Certified® device that plays DivX video. Visit divx.com for more information and software tools to convert your files into DivX videos.

ABOUT DIVX VIDEO-ON-DEMAND: This DivX Certified® device must be registered in order to play purchased DivX Video-on-Demand (VOD) movies. To obtain your registration code, locate the DivX VOD section in your device setup menu. Go to vod.divx.com for more information on how to complete your registration.

[Register]

Displays the registration code of your unit.

[Deregister]

Deactivate your unit and display the deactivation code.

! Note

All the downloaded videos from DivX(R) VOD with this unit's registration code can only be played on this unit.

Auto Power Off

The screen saver appears when you leave the unit in Stop mode for about five minutes. If you set this option to [On], the unit automatically turns off within 25 minutes since the Screen Saver is displayed. Set this option to [Off] to leave the screen saver until the unit is operated by the user.

Network Play

This function allows you to control the playback of media streamed from DLNA media server by a DLNA certified smartphone. Most DLNA certified smartphone has a function to control the playback media on your home network. Set this option to [On] for allowing your smartphone to control this unit. Refer to instructions of your DLNA certified smartphone or the application for more detailed information.

Note

- This unit and the DLNA Certified Smartphone must be connected to the same network.
- To use the [Network Play] function using a DLNA certified smartphone, press HOME (🏠) to display the home menu before connecting to this unit.
- While controlling the unit using the [Network Play] function, the remote control may not work.
- Available file formats described on page 6 are not always supported on [Network Play] function.

Factory Set

You can reset the unit to its original factory settings.

Note

If you reset the unit to its original factory settings using [Factory Set] option, you have to set all the activation for the online services and network settings again.

Software

[Information]

Displays the current software version.

[Update]

You can update the software by connecting the unit directly to the software update server (see page 36).

Disclaimer Notice

Press ENTER (⊙) to view the notice of Network Service Disclaimer.

General playback

Using [HOME] menu

The home menu appears when you press HOME (🏠). Use $\wedge / \vee / < / >$ to select a category and press ENTER (⊙).

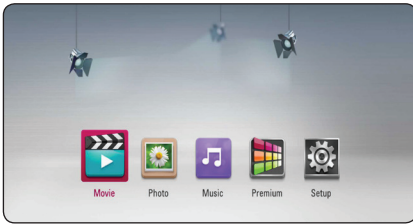

- | | |
|----------|--|
| 1 | [Movie] - Plays video content. |
| 2 | [Photo] - Plays photo content. |
| 3 | [Music] - Plays audio content. |
| 4 | [Premium] - Displays the Premium Home screen. |
| 5 | [Setup] - Adjusts the system settings. |

Playing a file media from a USB device

This unit can play video, audio and photo files contained in the USB device.

1. Insert a USB device into the USB port until it fits into place.
2. Press HOME (🏠).
3. Select [Movie], [Photo] or [Music] using $< / >$, and press ENTER (⊙).
4. Select [USB] option using \wedge / \vee , and press ENTER (⊙).
5. Select a file using $\wedge / \vee / < / >$, and press \blacktriangleright or ENTER (⊙) to play the file.

Playing a file media from a network server

This unit can play video, audio and photo files located in a PC or a DLNA server through your home network.

1. Check the network connection and settings (page 14).
2. Press HOME (🏠).
3. Select [Movie], [Photo] or [Music] using $< / >$, and press ENTER (⊙).
4. Select a DLNA media server or a share folder on your PC on the list using \wedge / \vee , and press ENTER (⊙).

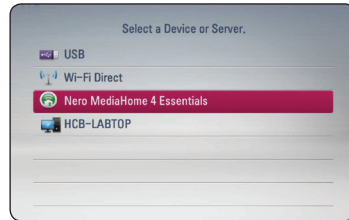

If you want to rescan available media server, press the green (G) colored button.

5. Select a file using $\wedge / \vee / < / >$, and press ENTER (⊙) to play the file.

! Note

- The file requirements are described on page 6.
- The thumbnail of the unplayable files can be displayed, but those cannot be played on this unit.
- The subtitle file name and video file name have to be the same and located at the same folder.
- The playback and operating quality may be affected by your home network condition.
- You may experience connection problems depending on your server's environment.

Entering a network user ID and the password

Depending on your PC's environment, you may need to enter a network user ID and the password for accessing a shared folder.

1. The keyboard menu appears automatically if the network user ID and the password are required.
2. Use $\wedge / \vee / < / >$ to select a character then press ENTER (Ⓞ) to confirm your selection on the virtual keyboard.

To enter a letter with an accent mark, press \square (INFO/MENU) to display the extended character set.

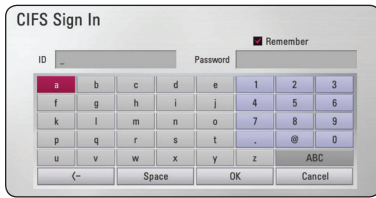

[Cancel] – Clear all entered characters.

[Space] – Inserts a space at the cursor position.

[<-] – Deletes the previous character at the cursor position.

[ABC / abc / #+ -= &] – Change the keyboard menu settings to capital letters, small letters or symbols.

3. When you finish entering the network user ID and password, select [OK] using $\wedge / \vee / < / >$ and press ENTER (Ⓞ) to access the folder.

The network user ID and password will be remembered after accessing the folder for your convenience. If you do not want the network user ID and password to be remembered, press red (R) colored button to un-tick the [Remember] check box before accessing the folder.

Wi-Fi Direct™ connection

Connecting to a Wi-Fi Direct™ certified device

This player can play movie, music and photo files located in a Wi-Fi Direct™ certified device. The Wi-Fi Direct™ technology make the player to be directly connected to a Wi-Fi Direct™ certified device without connecting to a network device such as an access point.

1. Set the [Wi-Fi Direct] option on the [Setup] menu to [On] (page 23).
2. Press HOME (🏠).
3. Select [Movie], [Photo] or [Music] using $< / >$, and press ENTER (Ⓞ).
4. Select [Wi-Fi Direct] option using \wedge / \vee , and press ENTER (Ⓞ).

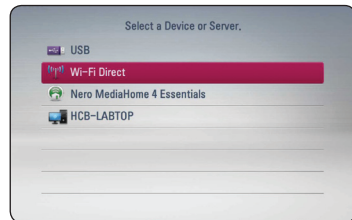

5. Select a Wi-Fi Direct™ device on the list using \wedge / \vee , and press ENTER (Ⓞ).

Wi-Fi Direct™ connection will be automatically proceeded.

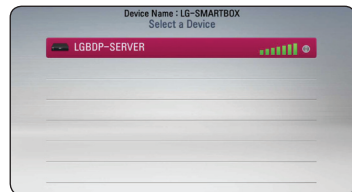

If the Wi-Fi Direct™ device supports the PIN Code configuration method based on WPS (Wi-Fi Protected Setup), select a device on the list and press yellow (Y) coloured button. Note the PIN number on the screen. And then, enter the PIN number on a setting menu of the device to connect.

If you want to rescan equipped Wi-Fi Direct™ device, press the green (G) coloured button.

6. Select a server that shared from the connected Wi-Fi Direct™ device using \wedge/\vee , and press ENTER (⊙) to navigate the server.

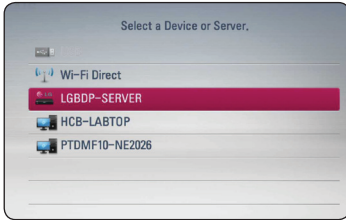

To select a server from the device list, files or folders must be shared by DLNA server from the connected Wi-Fi Direct™ device.

7. Select a file using $\wedge/\vee/</>$, and press ENTER (⊙) to play the file.

Note

- For the purpose of the better transmission, placing the player from the Wi-Fi Direct™ certified server as close as possible.
- This unit can connect only 1 device at a time. Multiple connection is not available.
- If you try to connect wireless network while a device is connected by Wi-Fi Direct™ function, Wi-Fi Direct™ connection will be force disconnected.
- If this player and Wi-Fi Direct™ device are connected to the different local area network, Wi-Fi Direct™ connection may not available.
- If a Wi-Fi Direct™ certified device is not in Wi-Fi Direct standby mode, this player cannot find the device.

Connecting to a Wi-Fi equipped devices

This player can connect to a general Wi-Fi device using Wi-Fi Direct™ function.

1. Set the [Wi-Fi Direct] option on the [Setup] menu to [On] (page 23)
2. Press HOME (🏠).
3. Select [Movie], [Photo] or [Music] using $</>$, and press ENTER (⊙).
4. Select [Wi-Fi Direct] option using \wedge/\vee , and press ENTER (⊙).

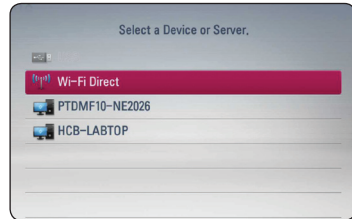

5. Press red (R) coloured button to display the [Network name (SSID)], [Security Option] and [Encryption] of the player.



6. On your Wi-Fi device, make a network connection to this player, using [Network name (SSID)], [Security Option] and [Encryption] at step 5 above.
7. Press BACK (↶) twice to display the device list.

- Select a server that shared from the connected Wi-Fi device using **▲/▼**, and press ENTER (**⊙**) to navigate the server.



To select a server from the device list, files or folders must be shared by DLNA server from the connected device.

- Select a file using **▲/▼/◀/▶**, and press ENTER (**⊙**) to play the file.



Note

In case of connection to a Wi-Fi equipped device, PIN connection does not work.

Basic operations for video and audio content

To stop playback

Press **■** while playback.

To pause playback

Press **⏸** while playback.

Press **▶** to resume playback.

To play frame-by-frame (Video)

Press **⏮** while movie playback.

Press **⏮** repeatedly to play Frame-by-Frame playback.

To scan forward or backward

Press **⏪** or **⏩** to play fast forward or fast reverse during playback.

You can change the various playback speeds by pressing **⏪** or **⏩** repeatedly.

To slow down the playing speed

While the playback is paused, press **⏩** repeatedly to play various speeds of slow motion.

To skip to the next/previous file

During playback, press **⏮** or **⏭** and hold for two seconds to go to the next file or to return to the beginning of the current track/file.

Press **⏮** twice briefly to step back to the previous file.

In the file list menu of a server, there may have many types of content in a folder together. In this case, press **⏮** or **⏭** and hold for two seconds to go to the previous or next content with same type.

Basic operations for photo content

To play a slide show

Press **▶** to start slide show.

To stop a slide show

Press **■** while slide show.

To pause a slide show

Press **||** while slide show.

Press **▶** to re-start the slide show.

To skip to the next/previous photo

While viewing a photo in full screen, press **<** or **>** to go to the previous or next photo.

Advanced playback

Enlarge the playback image

1. During playback, press green (G) colored button to display the [Zoom] menu.
2. Use red (R) or green (G) colored button to zoom out or in the picture. You can move through the zoomed picture using **▲/▼/◀/▶** buttons.
3. To return to the normal picture size, press yellow (Y) colored button.
4. Press **BACK (⏪)** to exit the [Zoom] menu.

Repeat playback

During playback, press red (R) colored button repeatedly to select a desired repeat mode.

Music files

🔄Track – The current track or file will be played back repeatedly.

🔄All – All the tracks or files will be played back repeatedly.

🔄 – The tracks or files will be played back in random order.

🔄🔄All – All the tracks or files will be played back repeatedly in random order.

To return to normal playback, press red (R) colored button repeatedly to select [Off].

Viewing content information

The unit can display the content information.

1. Select a file using **▲/▼/◀/▶**.
2. Press **□** (INFO/MENU) to display the option menu.
3. Select the [Information] option using **▲/▼**, and press **ENTER (⊙)**.

The file information appears on the screen.

! Note

The information displayed on the screen may not correct comparing actual content information.

Changing content list view

On the [Movie], [Music] or [Photo] menu, you can change the content list view.

Method 1

Press red (R) colored button repeatedly.

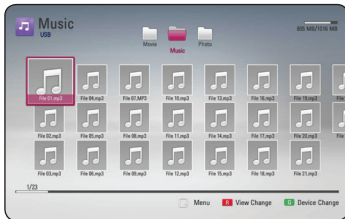
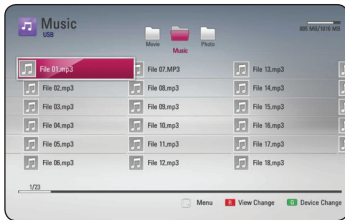

Selecting a subtitle file

If the subtitle file name is different from the video file name, you need to select the subtitle file on the [Movie] menu before playing the movie.

1. Use $\wedge / \vee / \leftarrow / \rightarrow$ to select the subtitle file you wish to play in the [Movie] menu.
2. Press ENTER (Ⓞ).

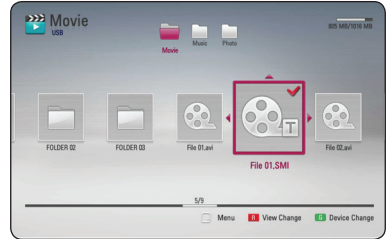

Press ENTER (Ⓞ) again to deselect the subtitle file. Selected subtitle file will be displayed when you play the video file.

! Note

- If you press \blacksquare while playback, the subtitle selection is cancelled.
- This function is not available for playing file on a server via home network.

Method 2

1. On the content list, press \square (INFO/MENU) to display the option menu.
2. Use \wedge / \vee to select the [View Change] option.
3. Press ENTER (Ⓞ) to change the content list view.

Options while viewing a photo

You can use various options during viewing a photo in full screen.

1. While viewing a photo in full screen, press \square (INFO/MENU) to display the option menu.
2. Select an option using \wedge / \vee .

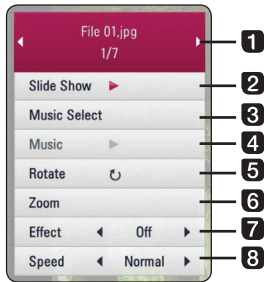

1 Current photo/Total number of photos
– Use \leftarrow / \rightarrow to view previous/next photo.

2 Slide Show – Press ENTER (⊙) to start or pause slide show.

3 Music Select – Select the background music for the slide show (page 31).

4 Music – Press ENTER (⊙) to start or pause background music.

5 Rotate – Press ENTER (⊙) to rotate the photo clockwise.

6 Zoom – Press ENTER (⊙) to display the [Zoom] menu.

7 Effect – Use \leftarrow / \rightarrow to select a transition effect between photos in a slide show.

8 Speed – Use \leftarrow / \rightarrow to select a delaying speed between photos in a slide show.

3. Press BACK (⏪) to exit the option menu.

Listening to music while slide show

You can display photo files while listening to audio files.

1. While viewing a photo in full screen, press \square (INFO/MENU) to display the option menu.
2. Use \wedge / \vee to select [Music Select] option, and press ENTER (⊙) to display the [Music Select] menu.
3. Use \wedge / \vee to select a device, and press ENTER (⊙).

Device that you can select are differ depending on the location of the photo file you are displaying in full screen.

Photo location	Available Device
USB	USB
Share Folder (PC)	Share Folder (PC)
DLNA server	DLNA server

4. Use \wedge / \vee to select a file or a folder you wish to play.

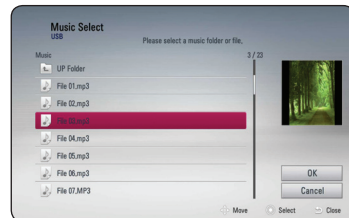

Select \square and press ENTER (⊙) to display the upper directory.

! Note

When selecting the audio file from a server, folder selection is not available. Only file selection is available.

5. Use \rightarrow to select [OK], and press ENTER (⊙) to complete music selection.

On-Screen display

You can display and adjust various information and settings about the content.

Displaying content information

1. While playback, press  (INFO/MENU) to show various playback information.



- 1 Title** – current title number/total number of titles
- 2 Time** – elapsed playing time/total playback time
- 3 Audio** – selected audio language or channel
- 4 Subtitle** – selected subtitle.
- 5 Code Page** – selected subtitle code page (page 30).
- 6 TV Aspect Ratio** – selected TV aspect Ratio.
- 7 Picture Mode** – selected picture mode.

2. Select an option using \wedge / \vee .
3. Use \langle / \rangle to adjust the selected option value.
4. Press BACK () to exit the On-Screen display.

Note

- If no button is pressed for a few seconds, the on-screen display disappears.
- Available items may differ depending on titles.

Playing from selected time

1. Press  (INFO/MENU) during playback. The time search box shows the elapsed playing time.
2. Select the [Time] option using \wedge / \vee .
3. Press \langle / \rangle to skip the playback 60 seconds forward or backward.
4. Starts playback from selected time.

Note

- This function may not work on some titles.
- This function may not work depending on the file type and ability of the DLNA server.



Listening to a different audio track

1. During playback, press  (INFO/MENU) to display the On-Screen display.
2. Use \wedge / \vee to select the [Audio] option.
3. Use \langle / \rangle to select desired audio language, audio track or audio channel.

Note

Immediately after you have switched sound, there may be a temporary discrepancy between the display and actual sound.

Selecting a subtitle language

1. During playback, press  (INFO/MENU) to display the On-Screen display.
2. Use \wedge / \vee to select the [Subtitle] option.
3. Use \langle / \rangle to select desired subtitle language.
4. Press BACK () to exit the On-Screen.

Using the Premium

You can use various content services via Internet with the Premium feature.

1. Check the network connection and settings (page 14).
2. Press HOME (🏠).
3. Select the [Premium] using </>, and press ENTER (⊙).

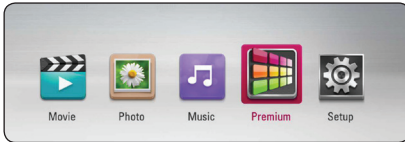

4. Select an online service using ^/v/</>, and press ENTER (⊙).

! Note

- Detailed information of each service, contact to the content provider or visit support link of the service.
- The content of Premium services and service related information, including user interface, is subject to changes. Please refer to the web site of each service for most up-to-date information.
- Using Premium features with wireless network connection may result in improper streaming speed by interference from household devices that are using radio frequencies.
- When you are first time to access [Premium] feature, current country setting appears. If you want to change the country setting, select [Edit] and press ENTER (⊙).

Troubleshooting

General

Symptom	Cause & Solution
No Power.	<ul style="list-style-type: none"> Plug the power cord into the wall outlet securely.
Cannot play movie, photo or audio files.	<ul style="list-style-type: none"> The files are not recorded in a format that the unit can play. The unit does not support the codec of the video file.
The remote control does not work properly.	<ul style="list-style-type: none"> The remote control is not pointed at the remote sensor of the unit. The remote control is too far from the unit. There is an obstacle in the path of the remote control and the unit. The batteries in the remote control are exhausted. We recommend using alkaline batteries.
The connected USB storage device is not recognized.	<ul style="list-style-type: none"> Try another different USB cable, some of USB cable may not support enough current for normal USB operation. If you use a USB extension cable or USB HUB, the USB devices may not be recognized. An USB device which requires additional program installation when you have connected it to a computer is not supported. This unit supports only USB Flash Drive and USB External HDD with FAT16, FAT32 or NTFS format.

Picture

Symptom	Cause & Solution
There is no picture.	<ul style="list-style-type: none"> Select the appropriate video input mode on the TV so the picture from the unit appears on the TV screen. Check the [HDMI Color Setting] in the [Setup] menu is set to the appropriate item that conforms to your video connection. Your TV may not support the resolution you have set on the unit. Change the resolution that your TV accepts. The player's HDMI OUT jack is connected to a DVI device that does not support copyright protection.
Picture noise appears.	<ul style="list-style-type: none"> Set the resolution which your TV accepts.

Resetting

Symptom	Cause & Solution
You can reset the unit as follows.	<ul style="list-style-type: none"> • Press RESET button on the unit. This will force the unit to power off. • Unplug the power cord, wait at least five seconds, and then plug it in again.

Network

Symptom	Cause & Solution
Streaming video services (such as YouTube™, etc.) are often stopped or “buffer” during playback.	<ul style="list-style-type: none"> • Your broadband service speed may not be fast enough to stream video services. Contact your Internet Service Provider (ISP) and increase the broadband speed is recommended.
Shared folder or files from your PC or a media server are not displayed on the device list.	<ul style="list-style-type: none"> • The fire wall or anti-virus software on your media server is running. Turn off the fire wall or anti-virus software running on your PC or media server. • The unit is not connected to the local area network that your PC or the media server are connected.
Cannot connect the unit to the access point or wireless LAN router.	<ul style="list-style-type: none"> • The wireless communication may be interrupted from household devices that are using radio frequencies. Move the unit away from them.
Access point is not displayed on the “Access point name” list.	<ul style="list-style-type: none"> • The access point or wireless LAN router may not broadcast its SSID. Set your access point to broadcast its SSID through your computer. • Your network device such as access point may not set with available frequency range and channel that this unit can support. Try setting the frequency range and channel on the network device setting.

Customer support

You can update the Unit using the latest software to enhance the products operation and/or add new features. To obtain the latest software for this unit (if updates have been made), please visit <http://www.lg.com/global/support/> or contact LG Electronics customer care center.

Open source software notice

To obtain the corresponding source code under GPL, LGPL and other open source licenses, please visit <http://opensource.lge.com>. All referred license terms, warranty disclaimers and copyright notices are available to download with the source code.

Network software update

Network update notification

From time to time, performance improvements and/or additional features or services may be made available to units that are connected to a broadband home network. If there is new software available and the unit is connected to a broadband home network, the unit will inform you about the update as follows.

Option 1:

1. The update menu will appear on the screen when you turn on the unit.
2. Use **</>** to select a desired option and then press ENTER (⊙).

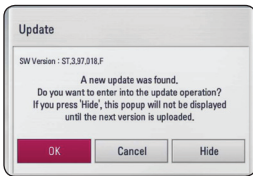

[OK]	Starts the software update.
[Cancel]	Exits the update menu and displays it next booting.
[Hide]	Exits the update menu and it does not appear until next software is uploaded in the update server.

Option 2:

If the software update is available from the update server, the “Update” icon appears in the Home menu. Press blue (B) colored button to start the update procedure.

Software update

You can update the unit using the latest software to enhance the products operation and/or add new features. You can update the software by connecting the unit directly to the software update server.

! Note

- Before updating the software in your unit, remove USB Device from the unit.
- Before updating the software in your unit, turn the unit off and then turn it back on.
- During the software update procedure, do not turn off the unit or disconnect AC power, or do not press any button.
- If you cancel the update, turn off the power and turn it on for stable performance.
- This unit cannot be updated to previous software version.

1. Check the network connection and settings (page 14).
2. Select [Software] option in the [Setup] menu then press ENTER (⊙).
3. Select [Update] option, and press ENTER (⊙).

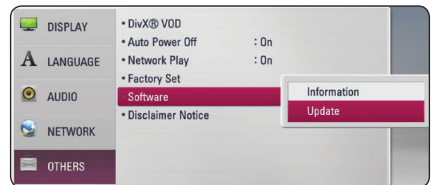

The unit will check for the newest update.

! Note

- Pressing ENTER (⊙) while checking for the update will end the process.
- If there is no update available, the Message, “No update is found.” appears. Press ENTER (⊙) to return to the [Home Menu].

4. If a newer version exists, the message “Do you want to update?” appears.
5. Select [OK] to start update. (Selecting [Cancel] will end the update.)

! Caution

Do not turn off the power during the software update.

6. When update is completed, the message, "Update is complete." will appear, and then power will turn off automatically after 5 seconds.
7. Turn the power back on. The system now operates with the new version.

Note

The Software Update function may not work properly depending on your internet environment. In this case, you can obtain the latest software from the authorized LG Electronics Service Center then update your unit. Refer to "Customer Support" on page 35.

About Nero MediaHome 4 Essentials

Nero MediaHome 4 Essentials is a software for sharing video, audio and photo files stored on your computer to this unit as a DLNA-compatible digital media server.

Note

- The Nero MediaHome 4 Essentials CD-ROM is designed for PCs and should not be inserted in this unit or in any product other than a PC.
- The supplied Nero MediaHome 4 Essentials CD-ROM is a customized software edition only for sharing files and folders to this unit.
- The supplied Nero MediaHome 4 Essentials software does not support following functions: Transcoding, Remote UI, TV control, Internet services and Apple iTunes
- The supplied Nero MediaHome 4 Essentials software can be downloaded at
 - Windows : <http://www.nero.com/download.php?id=nmhlgewin>
 - Mac OS : <http://www.nero.com/download.php?id=nmhlgemac>
- This manual explains operations with the English version of Nero MediaHome 4 Essentials as examples. Follow the explanation referring to the actual operations of your language version.

System requirements

Windows PC

- Windows® XP (Service Pack 2 or higher), Windows Vista® (no Service Pack required), Windows® 7 (no Service Pack required), Windows® XP Media Center Edition 2005 (Service Pack 2 or higher), Windows Server® 2003
- Windows Vista® 64-bit edition (application runs in 32-bit mode)
- Windows® 7 64-bit edition (application runs in 32-bit mode)

- Hard drive space: 200 MB hard drive space for a typical installation of Nero MediaHome stand-alone
- 1.2 GHz Intel® Pentium® III or AMD Sempron™ 2200+ processors
- Memory: 256 MB RAM
- Graphics card with at least 32 MB video memory, minimum resolution of 800 x 600 pixels, and 16-bit color settings
- Windows® Internet Explorer® 6.0 or higher
- DirectX® 9.0c revision 30 (August 2006) or higher
- Network environment: 100 Mb Ethernet, WLAN

Macintosh

- Mac OS X 10.5 (Leopard) or 10.6 (Snow Leopard)
- Macintosh computer with an Intel x86 processor
- Hard drive space: 200 MB hard drive space for a typical installation of Nero MediaHome stand-alone
- Memory: 256 MB RAM

Installing Nero MediaHome 4 Essentials

Windows

Start up your computer, and insert the supplied CD-ROM disc into your computer's CD-ROM drive. An installation wizard will walk you through the quick and uncomplicated installation process. To install Nero MediaHome 4 Essentials, proceed as follows:

1. Close all Microsoft Windows programs and exit any anti-virus software that may be running.
2. Insert the supplied CD-ROM disc into your computer's CD-ROM drive.
3. Click [Nero MediaHome 4 Essentials].
4. Click [Run] to start installation.
5. Click [Nero MediaHome 4 Essentials]. The installation is prepared and the installation wizard appears.
6. Click the [Next] button to display the serial number input screen. Click [Next] to go to the next step.
7. If you accept all conditions, click [I accept the License Conditions] check box and click [Next]. Installation is not possible without this agreement.
8. Click [Typical] and click [Next]. The installation process is started.
9. If you want to take part in the anonymous collection of data, select the check box and click the [Next] button.
10. Click the [Exit] button to complete the installation.

MAC OS X

1. Start up your computer, and insert the supplied CD-ROM disc into your computer's CD-ROM drive.
2. Browse the CD-ROM drive and open the "MediaHome_4_Essentials_MAC" folder.
3. Double-click the "Nero MediaHome.dmg" image file. The Nero MediaHome window is opened.
4. In the Nero MediaHome window, drag the Nero MediaHome icon either to the Applications folder within the window or to any other desired location.
5. You can now start the application by double-clicking the Nero MediaHome icon in the location you dragged it to.

Sharing files and folders

On your computer, you must share the folder contained video, audio and/or photo content to play them on this player.

This parts explains the procedure for selecting the shared folders on your computer.

1. Double-click the "Nero MediaHome 4 Essentials" icon.
2. Click [Network] icon on the left and define your network name in the [Network name] field. The Network name you enter will be recognized by your player.
3. Click [Shares] icon on the left.
4. Click [Local Folders] tab on the [Shares] screen.
5. Click [Add] icon to open the [Browse Folder] window.
6. Select the folder containing the files you want to share. The selected folder is added to the list of shared folders.
7. Click [Start Server] icon to start the server.

Note

- If the shared folders or files are not displayed on the unit, click the folder on the [Local Folders] tab and click [Rescan Folder] at the [More] button.
- Visit www.nero.com for more information and software tools.

Trademarks and licenses



HDMI, the HDMI logo and High-Definition Multimedia Interface are trademarks or registered trademarks of HDMI licensing LLC.



Manufactured under license from Dolby Laboratories. Dolby and the double-D symbol are trademarks of Dolby Laboratories.



DLNA®, the DLNA Logo and DLNA CERTIFIED® are trademarks, service marks, or certification marks of the Digital Living Network Alliance.



The Wi-Fi CERTIFIED Logo is a certification mark of the Wi-Fi Alliance.



DivX®, DivX Certified® and associated logos are trademarks of Rovi Corporation or its subsidiaries and are used under license.

DivX Certified® to play DivX® video up to HD 1080p, including premium content.

Covered by one or more of the following U.S. patents : 7,295,673; 7,460,668; 7,515,710; 7,519,274

Audio output specifications

Jack/Setting Source	Digital Output (DIGITAL AUDIO OUT) * ³	
	PCM Stereo	Primary Pass-Thru
Dolby Digital	PCM 2ch	Dolby Digital
Dolby Digital Plus	PCM 2ch	Dolby Digital
Linear PCM 2ch	PCM 2ch	PCM 2ch
Linear PCM 5.1ch	PCM 2ch	PCM 2ch
Linear PCM 7.1ch	PCM 2ch	PCM 2ch

Jack/Setting Source	HDMI OUT	
	PCM Stereo	Primary Pass-Thru * ¹ * ²
Dolby Digital	PCM 2ch	Dolby Digital
Dolby Digital Plus	PCM 2ch	Dolby Digital Plus
Linear PCM 2ch	PCM 2ch	Linear PCM 2ch
Linear PCM 5.1ch	PCM 2ch	Linear PCM 5.1ch
Linear PCM 7.1ch	PCM 2ch	Linear PCM 7.1ch

*1 The secondary and interactive audio may not be included in the output bitstream if [Digital Output] or [HDMI] option is set to [Primary Pass-Thru]. (Except LPCM Codec: the output always include interactive and secondary audio.)

*2 This unit automatically selects the HDMI audio according to the decoding capability of the connected HDMI device even though [HDMI] option is set to [Primary Pass-Thru].

*3 On the [Digital Output] audio output, the sampling frequency of DIGITAL AUDIO OUT is limited to 96 kHz.

- If the HDMI OUT jack is connected to your TV with High Speed HDMI™ Cable and Dolby Digital Plus is outputted from HDMI OUT jack, DIGITAL AUDIO OUT jack is limited to "PCM 2ch" (When the HDMI and DIGITAL AUDIO OUT are connected simultaneously).
- The audio is outputted as PCM 48 kHz/16 bit for MP3/WMA file.
- You must select a digital audio output and a maximum sampling frequency that your Amplifier (or AV receiver) accepts using [Digital Output], [HDMI] and [Sampling Freq.] options on the [Setup] menu (see page 22).
- If the audio format of the digital output does not match the capabilities of your receiver, the receiver will produce a strong, distorted sound or no sound at all.
- Multi-channel Digital Surround Sound via digital connection can only be obtained if your receiver is equipped with a Digital Multi-channel decoder.

Specifications

General	
Power Supply	Refer to the main label or refer to the main label on the bottom
Power consumption	
AC adapter	DA-18B12
Dimensions (W x H x D)	Approx. 110 x 29 x 110 mm
Net Weight (Approx.)	0.28 kg
Operating temperature	5 °C to 35 °C
Operating humidity	5 % to 90 %

Outputs	
HDMI OUT (video/audio)	19 pin (Type A, HDMI™ Connector)
DIGITAL AUDIO OUT (OPTICAL)	3 V (p-p), Optical jack x 1

System	
Signal system	Standard PAL color TV system
LAN port	Ethernet jack x 1, 10BASE-T / 100BASE-TX
Wireless LAN (internal antenna)	IEEE 802.11b/g/n (2.4 GHz band)
Bus Power Supply (USB)	DC 5 V  500 mA

- Design and specifications are subject to change without notice.

Maintenance

Handling the unit

When shipping the unit

Please save the original shipping carton and packing materials. If you need to ship the unit, for maximum protection, re-pack the unit as it was originally packed at the factory.

Cleaning the unit

To clean the unit, use a soft, dry cloth. If the surfaces are extremely dirty, use a soft cloth lightly moistened with a mild detergent solution. Do not use strong solvents such as alcohol, benzine, or thinner, as these might damage the surface of the unit.

Keeping the exterior surfaces clean

- Do not use volatile liquids such as insecticide spray near the unit.
- Wiping with strong pressure may damage the surface.
- Do not leave rubber or plastic products in contact with the unit for a long period of time.

Important information relating to network services

All information, data, documents, communications, downloads, files, text, images, photographs, graphics, videos, webcasts, publications, tools, resources, software, code, programs, applets, widgets, applications, products and other content ("Content") and all services and offerings ("Services") provided or made available by or through any third party (each a "Service Provider") is the sole responsibility of the Service Provider from whom it originated.

The availability of and access to Content and Services furnished by the Service Provider through the LGE Device are subject to change at any time, without prior notice, including, but not limited to the suspension, removal or cessation of all or any part of the Content or Services.

Should you have any inquiry or problem related to the Content or Services, you may refer to the Service Provider's website for the most up-to-date information. LGE is neither responsible nor liable for customer service related to the Content and Services. Any question or request for service relating to the Content or Services should be made directly to the respective Content and Service Providers.

Please note that LGE is not responsible for any Content or Services provided by the Service Provider or any changes to, removal of, or cessation of such Content or Services and does not warrant or guaranty the availability of or access to such Content or Services.

