



OWNER'S MANUAL

WASHING MACHINE

Please read this manual carefully before operating your washing machine and retain it for future reference.

WD-23600
WD-CD1307VM



P/No.: MFL48165939

www.lg.com

C ontents

Contents	2
-----------------------	---

Product feature	3
------------------------------	---

Warnings

Important safety instructions	4
Save these instructions	4

Specification	6
----------------------------	---

Installation

Transit bolts	7
Removing transit bolts	7
Installation place requirement	8
Positioning	8
Electrical connection	9
Connecting water supply hose	10
Installation of drain hose	12
Level adjustment	13

Care before washing

Before the first washing	14
Caring before washing	14

Adding detergent

Adding detergent and fabric softener ..	15
---	----

How to use washer

Washing program table	17
Control Panel	18
Additional program	19
- Power	19
- Program	19
- Start/Pause	20
- Door Lock	20
- Detecting	20
- Wash	20
- Child Lock	21
- Rinse	21
- Spin	22
- Water Temperature	22
- Add Load	23
- Time Delay	23
- Tub Clean	24
- Dry	25
- Display	27

Thank you for buying a LG Fully Automatic Washing Machine.

Please read your owner's manual carefully, it provides instruction on safe installation, use and maintenance. Retain it for future reference.

Record the model and serial number of your washing machine.

Model No.

Serial No.

Date of Purchase

Maintenance

The water inlet filter	28
The drain pump filter	29
Dispenser drawer	30
The drawer recess	30
The washing drum	30
The water circulation nozzle & steam nozzle	31
Cleaning your washer	31
Winterizing instructions	31

Troubleshooting guide

Diagnosing problems	32
Error messages	35
Using SMARTDIAGNOSIS™	36

Terms of warranty



■ Direct Drive System

The advanced Brushless DC motor directly drives the drum without belt and pulley.



■ 6 Motion

Washer is able to perform various drum actions or a combination of different actions depending on the wash program selected. Combined with a controlled spin speed and the ability of the drum to rotate both left and right, the wash performance of the machine is greatly improved, giving you perfect results every time.



■ Water Circulation

Sprays detergent solution and water onto the load over and over. Clothes are soaked more quickly and thoroughly during wash cycle. The detergent suds can be removed more easily by the water shower during rinse cycle. The water circulation system uses both water and detergent more efficiently.



■ Tilted Drum and Extra Large Door Opening

Tilted drum and extra large opening make it possible to load and unload clothing more easily.

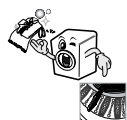

■ Embossing drum & waved lifter

Embossing drum enhances the washing performance and reduces clothes damage. The waved lifter spray and help clothes to enhance washing performance during the washing cycle.



■ Automatic Wash Load Detection

Automatically detects the load and optimizes the washing time.



■ Built-in Heater

Internal heater helps to maintain water temperature at its optimum level for selected cycles.



■ Child Lock

The Child lock prevents children from pressing any button to change the settings during operation.

Warnings

READ ALL INSTRUCTIONS AND EXPLANATION OF THE INSTALLATION BEFORE USE



WARNING!

For your safety, the information in this manual must be followed to minimize the risk of fire or explosion, electric shock, or to prevent property damage, personal injury, or loss of life.

IMPORTANT SAFETY INSTRUCTIONS

WARNING : To reduce the risk of fire, electric shock, or injury to persons when using the washer, follow basic precautions, including the following:

- Before installation, check exterior damages. If it has, do not install.
- Do not install or store the washer where it will be exposed to the weather.
- Do not tamper with controls.
- Do not repair or replace any part of the washer or attempt any servicing unless specifically recommended in the user-maintenance instructions or published user-repair instructions that you understand and have the skills to carry out.
- Keep the area underneath and around your appliances free of combustible materials such as lint, paper, rags, chemicals, etc.
- Close supervision is necessary if this appliance is used by or near children. Do not allow children to play on, with, or inside this or any other appliance.
- Keep small animals away from the appliance.
- Do not leave the washer door open.
An open door could entice children to hang on the door or crawl inside the washer.
- Never reach into washer while it is moving. Wait until the drum has completely stopped.
- The laundry process can reduce the flame retardant of fabrics.
- To avoid such a result, carefully follow the garment manufacturer's wash and care instructions.
- Do not wash or dry articles that have been cleaned in, washed in, soaked in, or spotted with combustible or explosive substances (such as wax, oil, paint, gasoline, degreasers, dry-cleaning solvents, kerosene, etc.) which may ignite or explode. Oil may remain in the tub after a whole cycle resulting in fire during drying. So, do not load oiled clothes.
- Do not slam the washer door closed or try to force the door open when locked. This could result in damage to the washer.
- When the machine runs high temperature, the front door may be very hot. Don't touch it.
- To minimize the possibility of electric shock, unplug this appliance from the power supply or disconnect the washer at the household distribution panel by removing the fuse or switching off the circuit breaker before attempting any maintenance or cleaning.
- When unplugging power cord, do not pull out by grasping the cord. Otherwise, the power cord may be damaged.
- Never attempt to operate this appliance if it is damaged, malfunctioning, partially disassembled, or has missing or broken parts, including a damaged cord or plug.
- Before discarding an old machine unplug it. Render the plug useless. Cut off the cable directly behind the appliance to prevent misuse.
- When a product was under water, Please call service center. The risk of electric shock and fire.

*** Do not push down the door excessively, when washer door open.
This could topple over the washer.**

SAVE THESE INSTRUCTIONS

GROUNDING INSTRUCTIONS

This appliance must be grounded. In the event of malfunction or breakdown, grounding will reduce the risk of electric shock by providing a path of least resistance for electric current. This appliance is equipped with a cord having an equipment-grounding conductor and grounding plug. The plug must be plugged into an appropriate outlet that is properly installed and grounded in accordance with all local codes and ordinance.

- Do not use an adapter or otherwise defeat the grounding plug.
- If you don't have the proper outlet, consult an electrician.

WARNING : Improper connection of the equipment-grounding conductor can result in risk of electric shock. Check with a qualified electrician or serviceman if you are in doubt as to whether the appliance is properly grounded. Do not modify the plug provided with the appliance - if it does not fit the outlet, have a proper outlet installed by a qualified electrician.

Warnings

To minimize the risk of fire in a tumble dryer, the following should be observed:

- Items that have been spotted or soaked with vegetable or cooking oil constitute a fire hazard and should not be placed in a tumble dryer.

Oil-affected items can ignite spontaneously, especially when exposed to heat sources such as in a tumble dryer. The items become warm, causing an oxidation reaction in the oil. Oxidation creates heat. If the heat cannot escape, the items can become hot enough to catch fire. Piling, stacking or storing oil-affected items can prevent heat from escaping and so create a fire hazard.

If it is unavoidable that fabrics that contain vegetable or cooking oil or have been contaminated by hair care products be placed in a tumble dryer they should first be washed in hot water with extra detergent-this will reduce, but not eliminate, the hazard. Washed in hot water with extra detergent-this will reduce, but not eliminate, the hazard. The 'cool down' cycle of tumble dryers should be used to reduce the temperature of the items. They should not be removed from the tumble dryer or piled or stacked while hot.

- Items that have been previously cleaned in, washed in, soaked in or spotted with petrol/gasoline, dry-cleaning solvents or other flammable or explosive substances should not be placed in a tumble dryer.

Highly flammable substances commonly used in domestic environments include acetone, denatured alcohol, petrol/gasoline, kerosene, spot removers (some brands), turpentine, waxes and wax removers.

- Items containing foam rubber (also known as latex foam) or similarly textured rubber-like materials should not be dried in a tumble dryer on a heat setting. Foam rubber materials can, when heated, produce fire by spontaneous combustion.

- Fabric softeners or similar products should not be used in a tumble dryer to eliminate the effects of static electricity unless this practice is specifically recommended by the manufacturer of the fabric softener or product.

- Undergarments that contain metal reinforcements should not be placed in a tumble dryer.

Damage to the tumble dryer can result if metal reinforcements come loose during drying. When available a drying rack could be used for such items.

- Plastic articles such as shower caps or babies waterproof napkin covers should not be placed in a tumble dryer.

- Rubber-backed articles, clothes fitted with foam rubber pads, pillows, galoshes and rubber-coated tennis shoes should not be placed in a tumble dryer.

S pecification

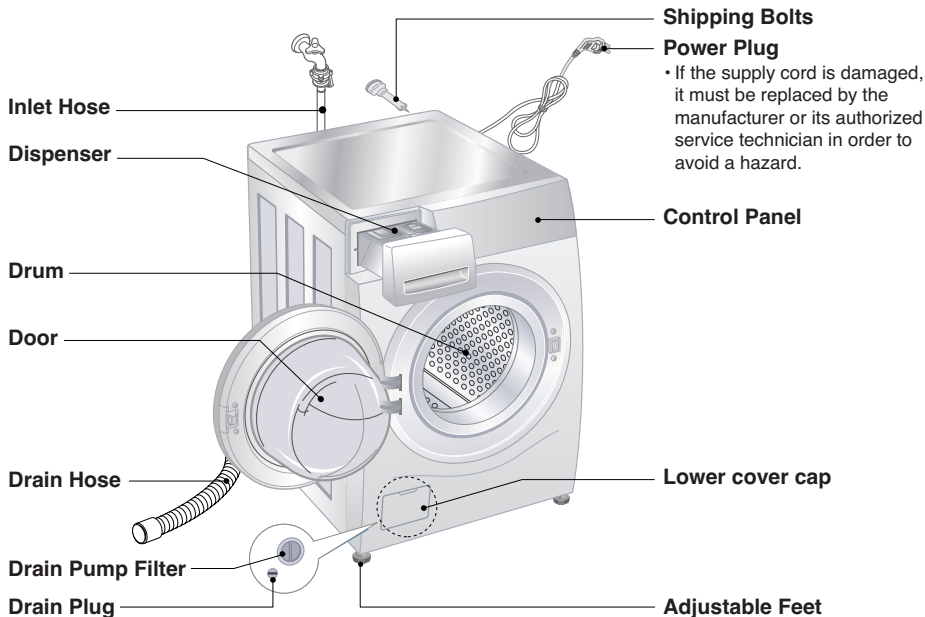

■ Name	: Front loading washing machine
■ Power supply	: 220-240 V~, 50 Hz
■ Size	: 645 mm(W) x 770 mm(D) x 940 mm(H)
■ Weight	: 86 kg
■ Wash capacity (Max. Watt)	: 13 kg (2200 W)
■ Dry capacity (Max. Watt)	: 7 kg (2200 W)
■ Spin speed	: Extra Low / Low / Medium / High / Extra High
■ Water consumption	: 156 ℓ
■ Permissible water pressure	: 1.0 - 10.0 kgf / cm ² (100 - 1000 kPa)

* The appearance and specifications may be varied without notice to improve the units quality.

* Specifications subject to change by manufacturer.

■ Accessories

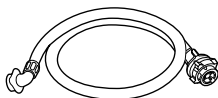

Inlet hose (1EA)



Spanner

Installation

Install or store where it will not be exposed to temperatures below freezing or exposed to the weather.

Properly ground washer to conform with all governing codes and ordinances.

The base opening must not be obstructed by carpeting when the washing machine is installed on a carpeted floor.

In countries where there are areas which may be subject to infestation by cockroaches or other vermin, pay particular attention to keeping the appliance and its surroundings in clean condition at all times.

Any damage which may be caused by cockroaches or other vermin will not be covered by the appliance guarantee.

■ Transit bolts

The appliance is fitted with transit bolts to prevent internal damage during transport.

- Packing and all transit bolts must be removed before using the washer.
- ☞ When unpacking the base, be sure to remove the additional packing support in the middle of the base packing.

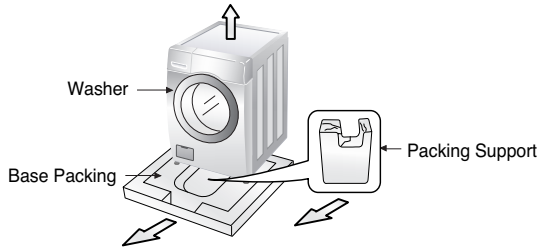

■ Removing transit bolts

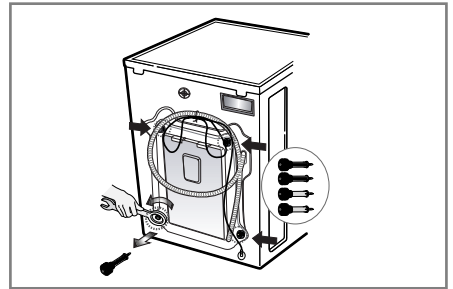
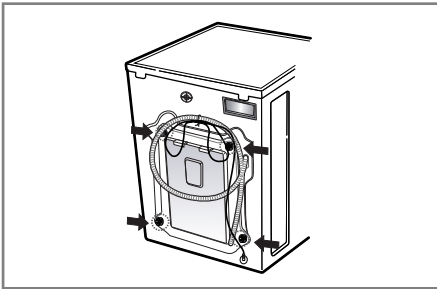

1. To prevent internal damage during transport, the special 4 bolts are locked. Before operating the washer, remove the bolts along with the rubber bungs.

- If they are not removed, it may cause heavy vibration, noise and malfunction.

2. Unscrew the 4 bolts with the spanner supplied.

3. Take out the 4 bolts along with the rubber bungs by slightly twisting the bung. Keep the 4 bolts and the spanner for future use.

- Whenever the appliance is transported, the transit bolts must be refitted.

4. Close the holes with the caps supplied.

I nstallation

■ Installation place requirement

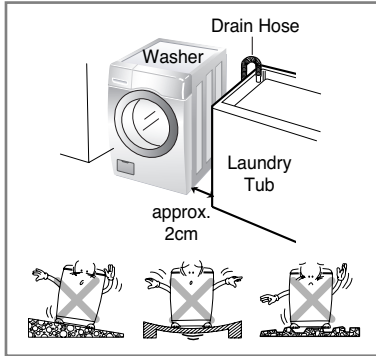

Level floor :

Allowable slope under entire washer is 1°

Power outlet :

Must be within 1.5 meters of either side of location of washer. Do not overload the outlet with more than one appliance.

Additional Clearance :

For wall, door and floor modeling is required.

(10cm : rear / 2cm : right & left side)

Do not place or store laundry products on top of washer at any times.

They can damage the finish or controls.

■ Positioning

Install the washer on a flat hard floor.

Make sure that air circulation around the washer is not impeded by carpets, rug etc.

- Before placing the washer on tiles, apply a rubber mat under the feet.
- Never try to correct any unevenness in the floor with pieces of wood, cardboard or similar materials under the washer.
- If it is impossible to avoid positioning the washer next to a gas cooker or coal burning stove, an insulating covered with aluminum foil on the side facing the cooker or stove, must be inserted between the two appliance.
- The washer must not be installed in rooms where the temperature can drop below 0°C.
- Please ensure that when the washer is installed, it is easily accessible for the engineer in the event of a breakdown.
- With the washer installed adjust all four feet using the transit bolt spanner provided ensuring the appliance is stable, and a clearance of approximately 20mm is left between the top of the washer and the underside of the work-top.
- The installation instructions shall state that the openings must not be obstructed by a carpet if it has ventilation openings in the base.

Installation

■ Electrical connection

1. Do not use an extension cord or double adapter.
 2. If the supply cord is damaged, it must be replaced by the manufacturer or its service agents or similarly qualified person in order to avoid a hazard.
 3. Always unplug the machine and turn off the water supply after use.
 4. Connect the machine to an earthed socket in accordance with current wiring regulations.
 5. The appliance must be positioned so that the plug is easily accessible.
- Repairs to the washing machine must only be carried out qualified personnel. Repairs carried out by inexperienced persons may cause injury or serious malfunctioning. Contact your local service center
 - Do not install your washing machine in rooms where temperatures below freezing may occur. Frozen hoses may burst under pressure. The reliability of the electronic control unit may be impaired at temperatures below freezing point.
 - If the appliance is delivered in the winter months and temperatures are below freezing : Store the washing machine at room temperature for a few hours before putting it into operation.

CAUTION

This appliance is not intended for use by young children or infirm persons without supervision. Young Children should be supervised to ensure that they do not play with appliance.

CAUTION

CAUTION concerning the Power Cord

Most appliances recommend they be placed upon a dedicated circuit; that is, a single outlet circuit which powers only that appliance and has no additional outlets or branch circuits. Check the specification page of this owner's manual to be certain.

Do not overload wall outlets. Overloaded wall outlets, loose or damaged wall outlets, extension cords, frayed power cords, or damaged or cracked wire insulation are dangerous. Any of these conditions could result in electric shock or fire. Periodically examine the cord of your appliance, and if its appearance indicates damage or deterioration, unplug it, discontinue use of the appliance, and have the cord replaced with an exact replacement part by an authorized servicer.

Protect the power cord from physical or mechanical abuse, such as being twisted, kinked, pinched, closed in a door, or walked upon. Pay particular attention to plugs, wall outlets, and the point where the cord exits the appliance.

If this appliance is supplied from a cord extension set or electrical portable outlet device, the cord extension set or electrical portable outlet device must be positioned so that it is not subject to splashing or ingress of moisture.

Installation

■ Connecting water supply hose

- Water supply pressure must be between 100 kPa and 1000 kPa (1.0 ~ 10.0 kgf / cm²).
- Do not strip or crossthread when connecting inlet hose to the valve.
- If the water supply pressure is more than 1000 kPa, a decompression device should be installed.
- Periodically check the condition of the hose and replace the hose if necessary.

► Step1 : Check rubber seal inlet hose

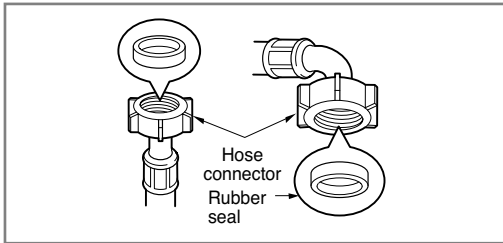

- Two rubber seals are supplied with the water inlet hoses. They are used for preventing water leaks. Make sure the connection to taps is sufficiently tight.

► Step2 : Connect hose to water tap

Type-A : Connecting Screw-type hose to tap with thread

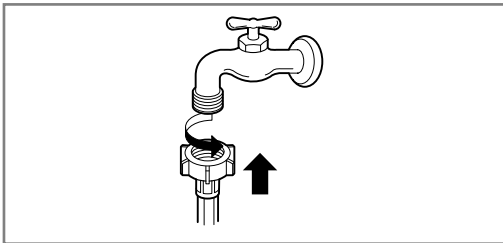

- Screw the hose connector onto water supply tap.

Type-B : Connecting Screw-type hose to tap without thread

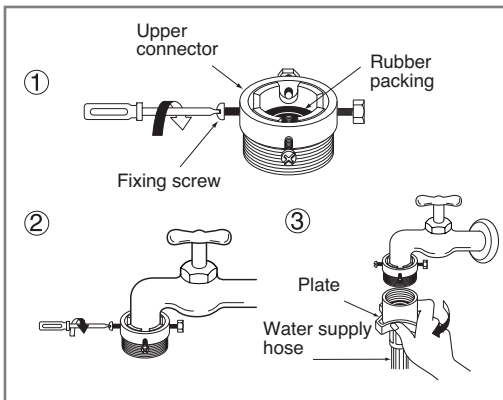

1. Unscrew the adapter ring plate and the 4 adapter retaining screws.
2. Push the adapter onto the end of the tap so that the rubber seal forms a watertight connection. Tighten the adapter ring plate and the 4 screws.
3. Push the water supply hose vertically upwards so that the rubber packing within the hose can adhere completely to the tap and then tighten it by screwing it to the right.

Installation

Type-C : Connecting one touch type hose to tap without thread

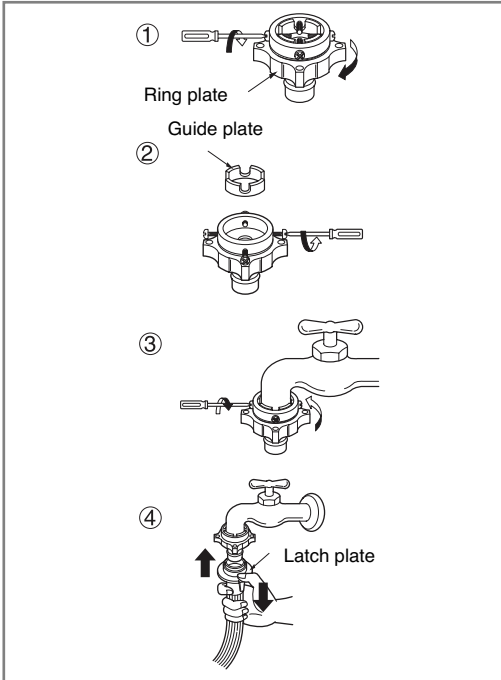

1. Unscrew the adapter ring plate and the 4 adapter retaining screws.
2. Remove the guide plate if the tap is too large to fit the adapter.
3. Push the adapter onto the end of the tap so that the rubber seal forms a watertight connection. Tighten the adapter ring plate and the 4 screws.
4. Pull the connector latch plate down, push the inlet hose onto the adapter, and release the connector latch plate. Make sure the adapter locks into place.



After connecting inlet hose to water tap, turn on the water taps to flush out foreign substances (dirt, sand or sawdust) in the water lines. Let water drain into a bucket, and check the water temperature.

► Step3: Connect hose to washer

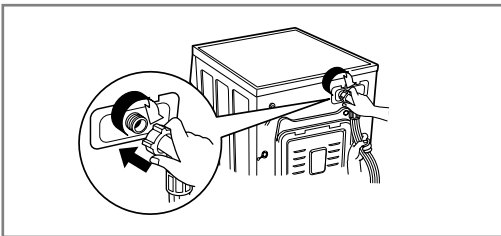

- Make sure that there are no kinks in the hose and that they are not crushed.
- **When your washer has two valves.**
- The Inlet hose which has red connector is for the hot water tap.
- If the washer has two valves, the energy is saved by using hot valve.



After completing connection, if water leaks from the hose, repeat the same steps. Use the most conventional type of faucet for water supply. In case the faucet is square or too big, remove the spacing ring before inserting the faucet into the adaptor.

Use the horizontal tap

Horizontal tap



Extension tap



Square tap



Installation

This equipment is not designed for maritime use or for use mobile installations such as caravans, aircraft etc.

Turn off the stopcock if the machine is to be left for any length of time (e.g. holiday), especially if there is no floor drain(gully) in the immediate vicinity.

When disposing of the appliance, cut off the mains cable, and destroy the Plug.

Disable the door lock to prevent young children being trapped inside.

Packaging material (e.g. Films, Styrofoam) can be dangerous for children. There is a risk of suffocation ! Keep all packaging well away from children

■ Installation of drain hose

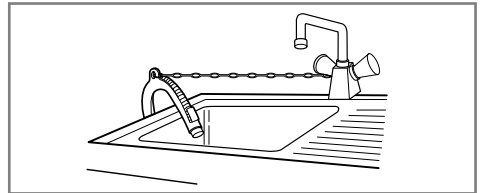
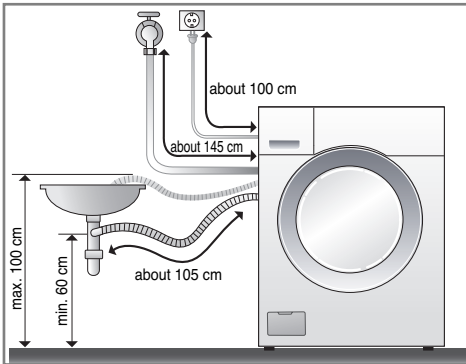

- When installing the drain hose to a sink, secure it tightly with a string.
- Proper securing of the drain hose will protect the floor from damage due to water leakage should the drain hose become loose.

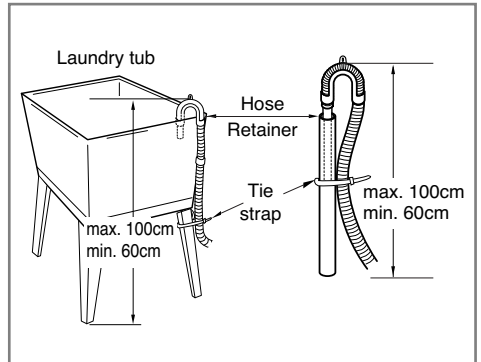
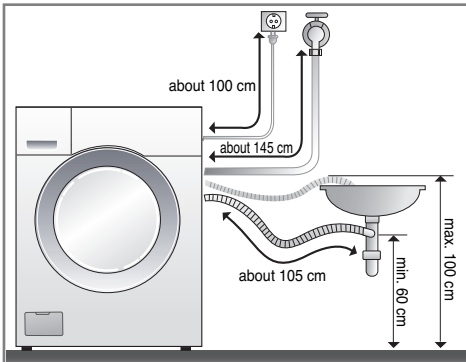

- The drain hose should not be placed higher than 100 cm above the floor. Water in the washer does not drain or drains slowly.
- Proper securing of the drain hose will protect the floor from damage due to water leakage.
- When the drain hose is too long, do not force back into the washer. This will cause abnormal noise, malfunction, and water leakage.

Installation

■ Level adjustment



1. Adjusting the washing machine level properly prevents excessive noise and vibration.
Install the appliance on a solid and level floor surface, preferably in a corner of the room.

NOTE Timber or suspended type flooring may contribute to excessive vibration and unbalance errors.

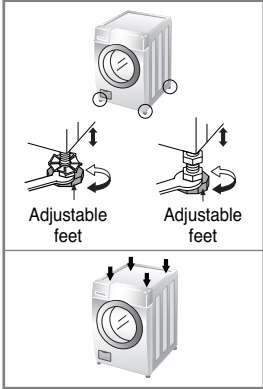

2. If the floor is uneven, adjust the adjustable feet as required. (do not insert pieces of wood etc. under the feet)
Make sure that all four feet are stable and resting on the floor and then check that the appliance is perfectly level. (use a spirit level)

※ *After the washer is level, tighten the lock nuts up towards of the base of the washer. All lock nuts must be tightened.*

NOTE In the case that the washing machine is installed on a raised platform, it must be securely fastened in order to eliminate the risk that it might fall off.

※ *Diagonal Check*

*When pushing down the edges of the washing machine top plate diagonally, the machine should not move up and down at all. (Please, check both of two directions)
If machine rocks when pushing the machine top plate diagonally, adjust the feet again.*

■ Concrete floors

- The installation surface must be clean, dry and level.
- Install washer on a flat hard floor.

■ Tile floors (Slippery floors)

- Position each foot on the Tread Mate and level the machine to suit. (Cut Tread Mate into 70x70 mm sections and stick the pieces on to the dry tile where machine is to be placed.)
- ※ *Tread Mate is a self adhesive material used on ladders & steps that prevents slipping.*

■ Wooden floors (Suspended floors)

- Wooden floors are particularly susceptible to vibration.
- To prevent vibration we recommend you place rubber cups under each foot, at least 15mm thick under the washer, secured to at least 2 floor beams with screws.
- If possible install the washer in one of the corners of the room, where the floor is more stable.

※ *Insert the rubber cups to reduce vibration.*

※ *Rubber cups (p/no. 4620ER4002B) can be purchased from the LG spare parts department.*

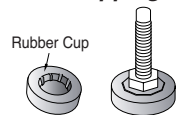

※ It can be purchased from hardware suppliers.

Important!

- Proper placement and levelling of the washer ensures long, regular and reliable operation.
- The washer must be absolutely horizontal and stand firmly in position.
- It must not “Seesaw” across corners under load.
- The installation surface must be clean, free from floor wax and other lubricant coatings.
- Do not let the feet of the washer get wet. If feet of the washer get wet, slipping may occur.

Care before washing

■ Before the first washing

Select a cycle (COTTON 60°C, add a half load of detergent) allow the unit to wash without clothing. This will remove residues from the drum that may have been left during manufacturing.

■ Caring before washing

1. Care Labels

Look for a care label on your clothes. This will tell you about the fabric content of your garment and how it should be washed.

2. Sorting

To get the best results, Sort clothes into loads that can be washed with the same wash cycle. Water temperature and spin speed and different fabrics need to be washed in different ways. Always sort dark colors from pale colors and whites. Wash separately as dye and lint transfer can occur causing discoloration of white etc. If possible, do not wash heavily soiled items with lightly soiled one.

Soil (Heavy, Normal, Light)

Color (White, Lights, Darks)

Lint (Lint producers, Collectors)

Separate clothes according to amount of soil.

Separate white fabrics from colored fabrics.

Wash lint producers and lint collectors separately.

3. Caring before loading

■ **Combine large and small items in a load. Load large items first. Large items should not be more than half the total wash load.**

Do not wash single items. This may cause an out-of-balance load. Add one or two similar items.

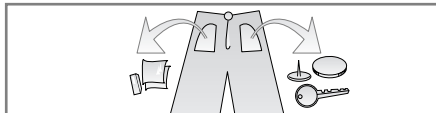

- Check all pockets to make sure that they are empty. Items such as nails, hair clip, matches, pens, coins and keys can damage both your washer and your clothes.

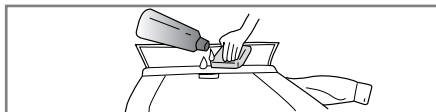

- Pre treat dirt and stains by brushing a little detergent dissolved in water onto stains like collars and cuffs to help shift dirt.

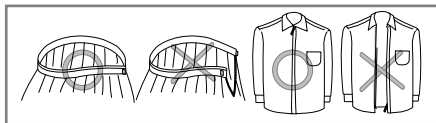

- Close zippers, hooks and strings to make sure that these items don't snag on other clothes.

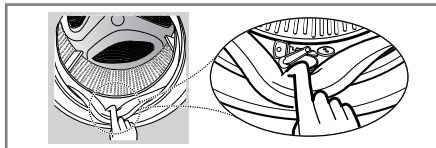

- Check the folds of the flexible gasket (gray) and remove any small articles, if any.
- Check inside of the drum and remove any left items in it for next wash cycle.



- Remove any clothing or items on the flexible gasket to prevent clothing and the gasket damages.

Adding detergent

■ Adding detergent and fabric softener

1. The Dispenser Drawer

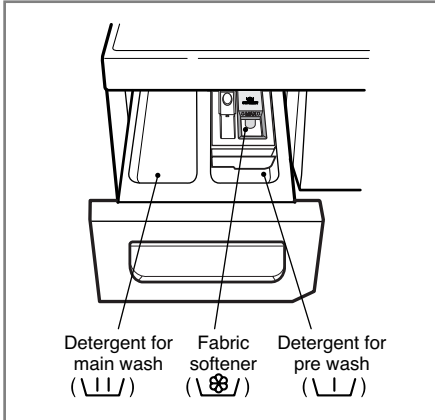

- Main wash only → \ \ /
- Pre Wash + Main Wash → \ \ / • \ \ /

2. Adding Fabric Softener

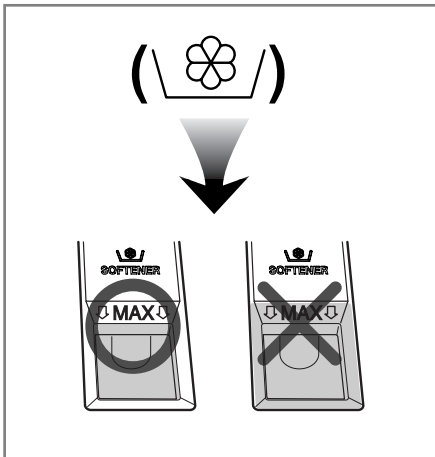

- Do not exceed the maximum fill line. Close the dispenser drawer slowly. Overfilling can cause early dispensing of the fabric softener which could stain clothes.
- Do not leave the fabric softener in the detergent drawer for more than 2 days. (Fabric softener could harden)
- Softener will automatically be added during the last rinse cycle.
- Do not open the drawer when water is supplied.
- Solvents(benzene, etc) are not allowable.

NOTE Do not pour fabric softener directly on the cloths

A dding detergent

3. Detergent dosage

- *The detergent should be used according to the instruction of the detergent manufacture.*
 - *If too much detergent is used, too many suds can occur and this will decrease the washing result or cause heavy load to the motor.*
 - *Use powder detergent only for the front loading washer.*
- * *If suds occur too much, pleas reduce the detergent amount.*
- Detergent usage may need to be adjusted for water temperature, water hardness, size and soil level of the load. For best results, avoid oversudsing.

4. Water softener

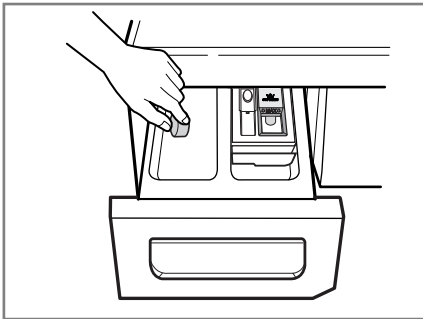

- A water softener, such as Anti limescale (Clagon) can be used to cut down on the use of detergent in extremely hard water areas. Dispense according to the amount specified on the packaging. First add detergent and then the water softener.
- Use the quantity of detergent as for soft water.

* Tips

Full load : according to manufacturer's recommendation.
Part load : 3/4 of the normal amount.
Minimum load : 1/2 of full load.

- Detergent is flushed from the dispenser at the beginning of the cycle.

5. Using the Tablets

- 1) Open the door and Tablets into the drum.

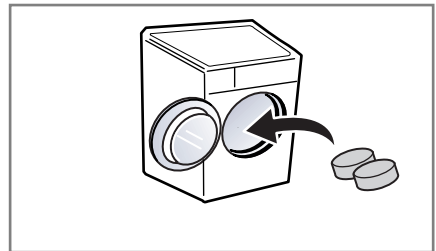

- 2) Load the laundry into the drum.

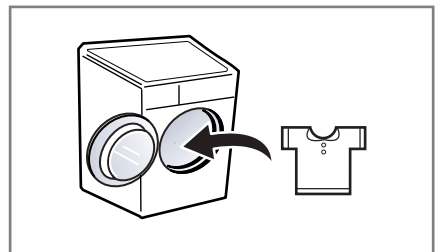

- 3) Close the door.

H ow to use washer

■ Washing program table

• Recommended courses according to the laundry type.

Program	Fabric Type	Proper Temp. (Option)	Additional Option	Maximum Load
Cotton	Color fast garments (shirts, night dresses, pajamas...) and lightly soiled white cotton (underwear...)	40°C (Cold, 60°C)	Pre Wash, Intensive, Normal, Light, Shoes Wash, No Wash, Time Delay, Dry	Rating
Sports Wear	This cycle is suitable for sports wear such as jogging clothes and running wear.	40°C (Cold)	Normal, No Wash, Time Delay	Less than 5.0kg
Dark Wash	Use this cycle to wash "multi-color" clothes to maintain their color	40°C (Cold)	Normal, No Wash, Time Delay, Dry	Less than 5.0kg
Cold Wash	This cycle is suitable for lightly soiled clothing. Use this cycle to save energy, by using cold water while ensuring proper washing.	Cold	Pre Wash, Intensive, Normal, Light, No Wash, Time Delay, Dry	Rating
Wool 	Enable to wash wool fabrics. (Please use detergent for machinewashable woolens).	40°C (Cold)	Normal, No Wash, Time Delay	Less than 4.0kg
Duvet	This cycle is for large items such as bed cover, pillows, sofa covers, etc.	Cold (40°C)	Normal, Light, No Wash, Time Delay	1 king size (9 Tog)
Rinse + Spin	Rinse and Spin	-	Time Delay, Dry	-
Refresh	Cotton mixed, Polyeter mixed Dress shirts, blouses (It just makes wrinkled clothes easy to iron)		Time Delay	5 items
Speed Wash	Lightly soiled clothing and small loads	40°C (Cold)	Normal, No Wash, Time Delay, Dry	Less than 5.0kg
Silent	Color fast garments (Shirts, nightdresses, pajamas, etc.) and lightly soiled white cotton (underwear).	40°C (60°C, Cold)	Normal, Intensive, Pre Wash, Time Delay, Dry, No Wash, Light	Less than 5.0kg
Sanitary	Heavily soiled underwear, work clothes, diapers, etc	95°C	Normal, No Wash, Time Delay, Dry	Less than 3.0kg
Heavy Duty	Heavily soiled cotton fabrics	60°C (40°C)	Pre Wash, Intensive, Normal, No Wash, Time Delay, Dry	Less than 3.0kg



The wool wash cycle of this machine has been approved by Woolmark for the washing of machine washable Woolmark products provided that the products are washed according to the instructions on the garment label and those issued by the manufacturer of this washing machine M0806.

* **Notes** : Neutral detergent is recommended. The wool cycle features gentle tumbling and low-speed spin for garment care.

How to use washer

Control panel

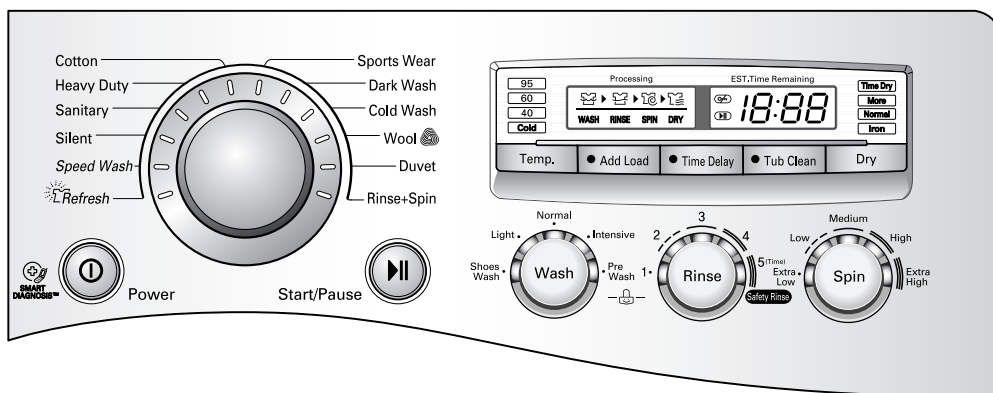

1. Cotton automatically selected upon power on.

- Press the **Power** (⏻) button to start.
- Press the **Start/Pause** (⏸) button.
- Initial condition
 - *Rinse : 3*
 - *Water temperature : 40°C*
 - *Spin : High*
 - *Program : Cotton*

2. Manual Selecting

- Press the **Power** (⏻) button to turn the washer on.
- Select the desired cycle with the program dial and if required, make any changes to the washing conditions by pressing the buttons accordingly.

For selecting the each conditions, please refer to the Page19~page27.

- Press the **Start/Pause** button to commence the cycle.

How to use washer

SMARTDIAGNOSIS™ function is available only for the products with a SMARTDIAGNOSIS™ mark.

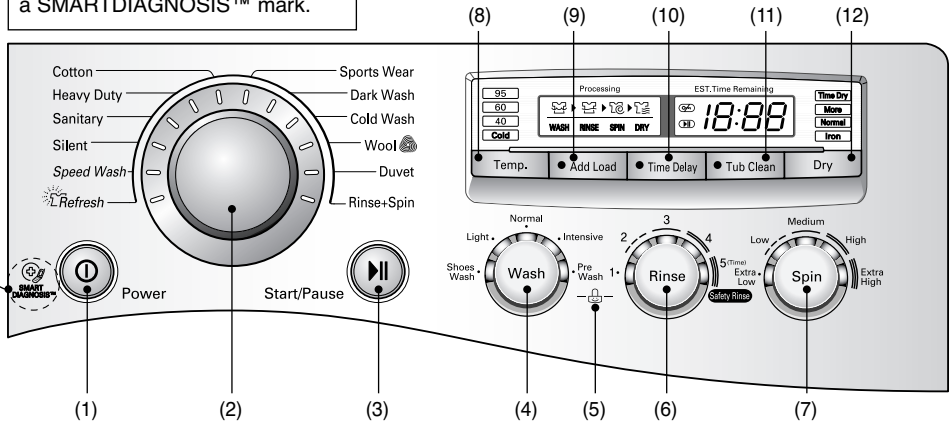

- | | | | |
|-------------------------|-------------------|-------------------------|-------------------------|
| (1) Button: Power | (4) Button: Wash | (7) Button: Spin | (10) Button: Time Delay |
| (2) Dial: Program | (5) Child lock | (8) Button: Temperature | (11) Button: Tub Clean |
| (3) Button: Start/Pause | (6) Button: Rinse | (9) Button: Add Load | (12) Button: Dry |

Power



1. Power

- Press the Power (⏻) button to turn power on and off.
- To cancel the **Time Delay** function, the Power (⏻) button must be pressed.

2. Initial Program

- When the Power (⏻) button is pressed, the washer is ready for Cotton program. And the other initial conditions as follows.
- So, if you want to advance into the washing cycle without changing the program, just press **Start/Pause** (⏸) button and then the washer will proceed.

■ Initial program

- Cotton Program / Rinse:3 / 40°C / High

Program

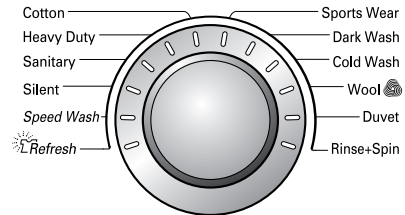

- 12 programs are available according to the laundry type.
- Dial lamp will light up to indicate selected program.
- When **Start/Pause** (⏸) button is pressed, the Cotton program is automatically selected.
- By turning the Program dial, the program is Selected in order of "Cotton – Sports Wear – Dark Wash – Cold Wash – Wool – Duvet – Rinse+Spin – Refresh – Speed Wash – Silent – Sanitary – Heavy Duty".

For information regarding laundry type for each program, please refer to page 17.

How to use washer

Start/Pause



1. Start

- This **Start/Pause** button is used to start wash cycle or pause the wash cycle.

2. Pause

- If temporary stop of wash cycle is needed, press "**Start/Pause**" button.
- When in Pause, the power is turned off automatically after 4 minutes.

NB. The door will not open before 1 to 2 minutes when Pause is selected, or at the end of the wash cycle.

Door Lock



- Lights whenever the door of the washer is locked.
- The door can be unlocked by pressing the Start/Pause button to stop the washer.
- The door can be opened after a short delay.

Detecting



- While the "Detecting" is shown in the display the machine rotates slowly and detects how many laundries are loaded in the drum. It will take a few seconds.

Wash



1. Pre Wash

- Use this option for loads that need pretreatment. This adds 16 minutes of pre washing before draining.
- When using Pre Wash option, do not use a liquid detergent for the main wash. Use powder for the main wash.

2. Intensive

- If the laundry is heavily soiled "Intensive" option is effective.
- By selecting the Intensive option, the wash time may be extended, depending on the program selected.
- To use this option select the Intensive option once before the wash programme is started.

3. Normal

- This option is automatically selected in every course except for Rinse+Spin.

4. Light

- This cycle is suitable for lightly soiled clothing.

5. Shoes Wash

- Use this option when you want to wash slippers or shoes.

✳ *Depending on the usage condition, steam could not be operated.*

How to use washer

Child Lock

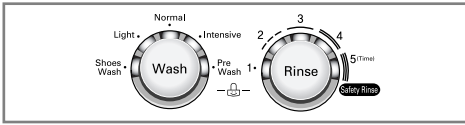

Use this option to prevent unwanted use of the washer or to keep cycle settings from being changed while the washer is operating.

- Child lock can be set by pressing and holding the **Wash** and **Rinse** button simultaneously. (About three seconds)

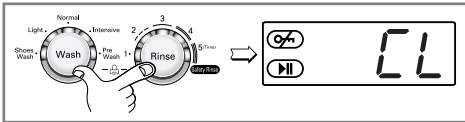

- When **CHILD LOCK** is set, the **Child Lock** indicator will appear and all buttons are disabled except the **POWER** button.
- To deactivate Child lock system, press and hold the **Wash** and **Rinse** button simultaneously again. (About three seconds)

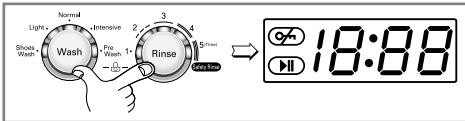

- To change to the desired program, whilst in child lock mode.

1. Press and hold both **Wash** and **Rinse** button together once again. (About three seconds)
2. Press the **Start/Pause** button.
3. Select the desired program and press the **Start/Pause** button again.

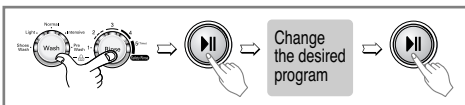

NOTE

- **CHILD LOCK** lasts after the end of cycle. If you want to deactivate this function, Press and hold the **Wash** and **Rinse** button simultaneously for 3 seconds.

Rinse

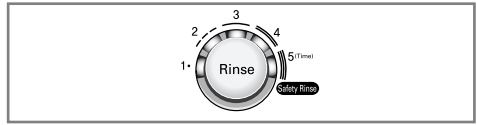

- By pressing the Rinse button, the Rinse type can be selected.

- **Duvet, Silent** perform 4 Rinses.
- **Cotton, Sports Wear, Dark Wash, Cold Wash, Wool, Sanitary, Heavy Duty** perform 3 Rinses.
- **Speed Wash** performs 2 Rinses.
- **Rinse+Spin** performs 1 Rinse.

The matching indicator lamp will light up for identification.

How to use washer

Spin

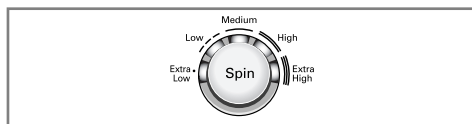

- By pressing the Spin button, the spin speed can be chosen.

1. Spin selection

- Spin speed is available according to the Program as follows.
- **Rinse+Spin & Speed Wash & Sanitary & Heavy Duty**
Medium - High - Extra High - Extra Low - Low
- **Cotton & Cold Wash**
High - Extra High - Extra Low - Low - Medium
- **Dark Wash & Silent**
Low - Medium - High - Extra High - Extra Low
- **Sports Wear**
Extra Low
- **Wool**
Low – Extra Low
- **Duvet**
Medium – Extra Low – Low

Water Temperature

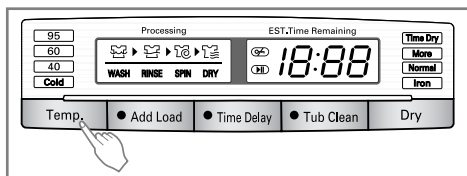

- By pressing the Temp. button, the water temperature can be selected.
- Water temperature can be selected as below according to the program.
- **Cotton & Silent**
40°C – 60°C – Cold
- **Sports Wear & Dark Wash & Wool & Speed Wash**
40°C – Cold
- **Cold Wash**
Cold
- **Duvet**
Cold – 40°C
- **Sanitary**
95°C
- **Heavy Duty**
60°C – 40°C

*The required temperature lamp will light up for identification.
For the more detailed information, please refer to the page 17.*

How to use washer

Add Load

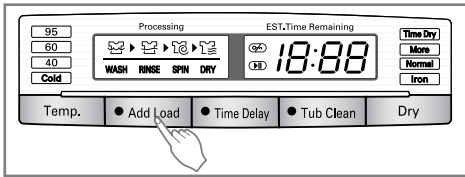

Use this function to add loads or remove the foreign material.

- How to use “Add Load”
 - Press the “Add Load” button.
 - Close the door after add loads or remove the foreign material (e.g. coin or pin etc.)
 - Press the “Start/Pause” button.
- Open the door when “Door Lock” is off after checking the safety.
- Results when choosing “Add Load” during cycles
 - When the tub is spinning: Tub stops and “Door Lock” is off.
 - When water temperature in the tub is higher than 45°C: “Add Load” is not available with short warning sound for safety.
 - When lots of water is in the tub: “Door Lock” is off after draining by safe water level.
- “Add Load” doesn’t work when “Tub Cleaning” course is in progress for safety

NOTE

Put the laundry into the tub completely. Laundry caught in between door closing part can damage door packing (rubber part) and might cause failure.

Time Delay

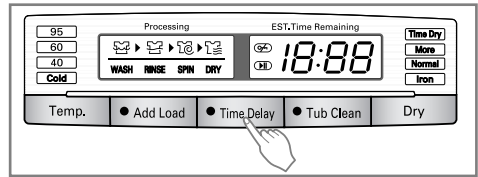

Preparing washing before starting “Time Delay”

- Turn on the water tap.
- Load laundry and close the door.
- Place the detergent and fabric softener in the drawer.
- How to set “Time Delay”
 - Press **Power** (⏻) button.
 - Turn the **Program** dial to select the program you require.
 - Press **Time Delay** button and set the desired time.
 - Press the **Start/Pause** (⏸) button.
- If **Time Delay** button is pressed, “3:00” is displayed. The maximum delayed time is 19:00 hours and the minimum time is 3:00 hours.
- Each pressing of the button advances time delay by one hour.
- To cancel the time delay, press the **Power** (⏻) button.
- **Time Delay** is ‘expected time’ from the present to the completion of washing cycle or selected process (Wash, Rinse, Spin).
- *According to the condition of water supply and temperature, the delayed time and the actual washing time may vary.*

How to use washer

Tub Clean

Use this function to sanitize drum to remove any bacteria and keep the drum clean.

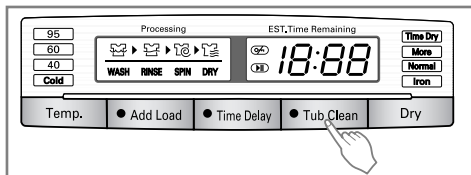

1. Press the Power button.
 - Close the door.
 - Add the detergent or antibacterial detergent to the container.
 - Add the liquid chloride bleach to the liquid detergent container or powder chloride detergent to the detergent container for main wash.
2. Press the “Tub Clean” Button.
 - “Tub Clean” Course will be set and all button are inoperable.
3. Press the “Start” button.
 - The door will be locked and the Tub Clean will start.

Powder detergent or bleach	Liquid detergent or bleach
54 g	54 ml
<p>Powder bleach/detergent</p>	<p>Liquid bleach/detergent</p> <p>Liquid detergent/bleach reference line (MAX)</p> <ul style="list-style-type: none"> • If you add more than the reference line, it may be directly added to the laundry.

- Do not add more than the designated amount for the chloride bleach. If you add too much chloride bleach, it may cause problems to the washer.

NOTE

Auto Tub clean notification function(보정)

- When you turn on the power by pressing the Power button, and the following sign is shown on the panel, it means that you need to clean the drum. Press the Tub Clean button to clean the Tub.
- If you want to proceed with normal wash course and not the Tub Clean, turn the course selection dial or press the button of the course and cycle you want.
- If you do not proceed with the Tub Clean, this message will appear on the panel at every 30 times.
- If you proceed with the Tub Clean, the message will not appear until the next time you need to clean the tub.
- Even though it may differ by the frequency of use of the washer, the auto drum clean notification generally appears once every one to two months.

How to use washer

Dry

NOTE The maximum drying capacity for this model is 7 kg. When loading, please use the maximum drying capacity indicator behind the door as shown below.

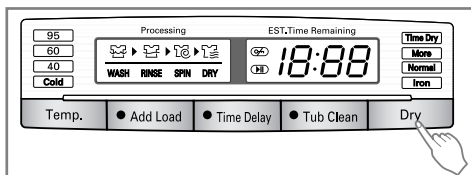

- Do not overload above the maximum drying capacity indicator. Items must be able to tumble freely.
- This washer-dryer's automatic process from washing to drying can be selected easily.
- For most even drying, make sure all articles in the clothes load are similar in material and thickness.
- By pressing the button, you can select. Normal → More → 60 → 90 → 120 → 150 → Iron.







1. Drying Automatic guide

- Use your Automatic Cycles to dry most loads. Electronic sensors measure the temperature of the exhaust to increase or decrease drying temperatures for faster reaction time and tighter temperature control.
- Recommend Automatic drying course for clothes type.
 - a) Iron – Will leave clothes slightly damp, ideal for ironing
 - b) Normal – Will dry clothes enough to be removed and folded, ideal for everyday clothes such as cottons.
 - c) More – Will ensure maximum drying performance.

NOTE:

The estimated drying time varies from the actual drying time when in the Automatic mode. The type of fabric, size of the load, and the dryness selected, do affect the drying times.

* The standard laundry weight which shows how much laundry to put into the washer.

Sorts of laundry			
Single weight	Diaper	Shirt	Short-sleeved
	95g	200g	300g
Sorts of laundry			
Single weight	Underwear	Nightclothes	Jean
	50g	500g	600g

H ow to use washer

2. Manual Drying time guide

- By pressing the Dry button, the drying time can be selected.
- Drying course can last up to 150min. When selecting drying only, drying course will start after spinning, unless the spin omitted.
- These drying times are given as a guide to help you set your dryer for manual drying. Drying times can vary greatly depending on dampness, room temperature and type of fabric and your own experience will be your best guide.

Woolen Articles

- Do not tumble dry woolen articles. Pull them to their original shape and dry them flat.
- Some woven and loop knit materials may shrink, by varying amounts, depending on their quality.
- Always stretch not these type of garments immediately after drying.

Permanent Press and Synthetics

- Do not overload your dryer
- Take out permanent press articles as soon as the dryer stops to reduce wrinkles.

Fiber or Leather Materials

- Always check the manufacture's instructions.

Baby clothes and Night Gowns

- Always check the manufacture's instructions.

Rubber and Plastics

- Do not dry any items made from or containing rubber or plastics, such as:
 - a) aprons, bibs, chair covers
 - b) curtains and table cloths
 - c) bathmats

Fiber glass

- Do not dry fiberglass articles in your dryer. Glass particles left in the dryer could be picked up by your clothes the next time you use the dryer and irritate your skin.

3. Completion of Drying

- When drying cycle is completed, "End" is displayed on the display.

H ow to use washer

Display



1. Special function display

- When Child lock is selected, the “**CL**” is displayed
- When time delay is selected, it shows the remaining time before the finish of the selected program.

■ Est. Time Remaining

- This display shows the estimated time remaining in the cycle when operating.
- This washer automatically detects the wash load (weight) and optimizes the washing time. After detecting, the display will show the adjusted time remaining.

■ Status Indicator

- It shows elapsed time of the cycle the washer is operating.

2. Self diagnose display

- If the washer encounters a fault during operation, the associated fault will be displayed.

“**PE**” : Water pressure sensing error

“**FE**” : Problem of overfilling water

“**DE**” : Door is not closed

“**LE**” : Over load in motor

“**IE**” : Water inlet trouble

“**UE**” : Drainage trouble

“**UE**” : Unbalanced load

“**TE**” : Water temperature trouble

“**dHE**” : Dry heater or thermostat trouble.

If these error letters are displayed, please refer to the troubleshooting page 35 and follow the guide.

3. Completion of washing

- When washing cycle is completed, “**End**” is displayed on the “*Multi display*”.

4. Time left

- During washing cycle, the remaining washing time is displayed.
- Recommended program by manufacturer.

- **Refresh**: around 30 minutes

- **Silent**: around 1 hour and 10 minutes

- **Cotton**: around 2 hours and 43 minutes

- **Heavy Duty**: around 1 hour and 59 minutes

- **Sanitary**: around 1 hour and 59 minutes

- **Speed Wash**: around 49 minutes

- **Rinse+Spin**: around 18 minutes

- **Duvet**: around 1 hour and 30 minutes

- **Wool**: around 52 minutes

- **Cold Wash**: around 1 hour and 32 minutes

- **Dark Wash**: around 1 hour and 7 minutes

- **Sports Wear**: around 1 hour and 12 minutes

- The washing time may vary by the amount of laundry, water pressure, water temperature and other washing conditions.

- If an unbalanced load is detected or if the suds removing program operates, the wash time may be extended.

(Max. increasing time is 45 minutes.)

Maintenance

- * Before cleaning the washer interior, unplug the electrical power cord to avoid electrical shock to avoid electrical shock hazards.
- * When disposing of the appliance, cut off the mains cable, and destroy the plug Disable the door lock to prevent young children being trapped inside.

■ The water inlet filter

- " *! E* " error message will blink on the control panel when water does not enter the detergent drawer.

- If water is very hard or contains traces of lime deposit, the water inlet filter may become clogged.

It is therefore a good idea to clean it from time to time.

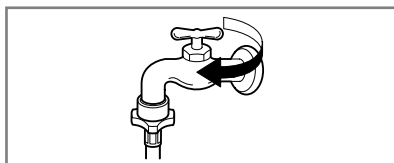

1. Turn off the water tap.

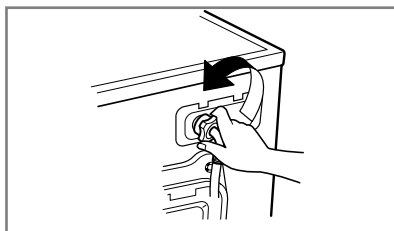

2. Unscrew the water inlet hose.

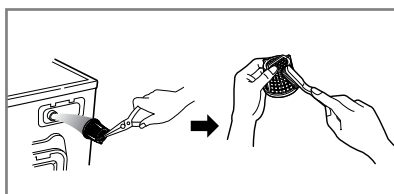

3. Clean the filter using a hard bristle brush.

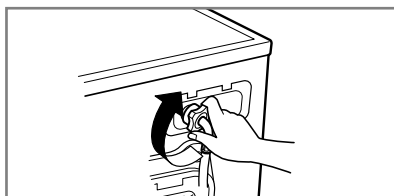

4. Tighten up the inlet hose.

Maintenance

■ The drain pump filter

- * The drain filter collects threads and small objects left in the laundry.
Check regularly that the filter is clean to ensure smooth running of your machine.

⚠ CAUTION First drain using the drain hose and then open the pump filter to remove whatever any threads or objects.

Be careful when draining if the water is hot.

- * Allow the water to cool down before cleaning the drain pump, carrying out emergency emptying or opening the door in an emergency.

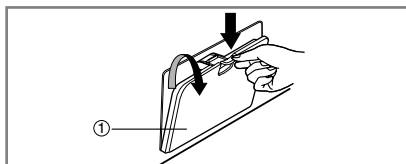

1. Open the lower cover cap (①) by using a finger. Turn the drain plug (②) to pull out the hose.

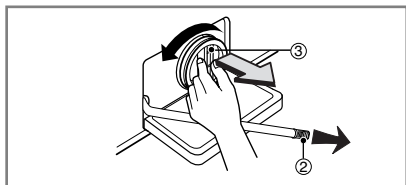

2. Unplug the drain plug (②), allowing the water to flow out. At this time use a vessel to prevent water flowing on to the floor. When water does not flow any more, turn the pump filter (③) open to the left.

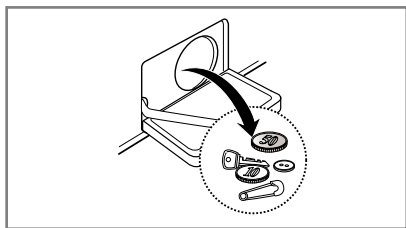

3. Remove out any foreign material from the pump filter (③).

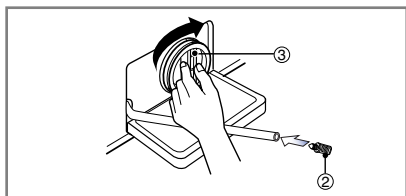

4. After cleaning, turn the pump filter (③) clockwise and insert the drain plug (②) to the original place. Close the lower cover cap.

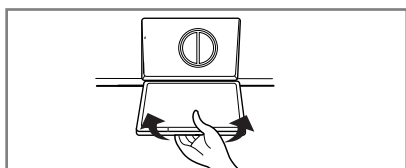

Maintenance

■ Dispenser drawer

- * After a while detergents and fabric softeners leave a deposit in the drawer.
- It should be cleaned from time to time with a jet of running water.
- If necessary it can be removed completely from the machine by pressing the catch downward and by pulling it out.
- To facilitate cleaning, the upper part of the fabric softener compartment can be removed.

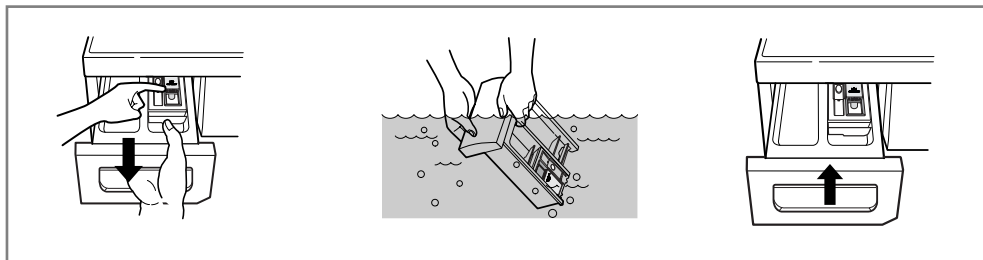

■ The drawer recess

- * Detergent can also accumulate inside the recess which should be cleaned occasionally with an old toothbrush.
- Once you have finished cleaning, replace the drawer and run a rinse cycle without laundry.

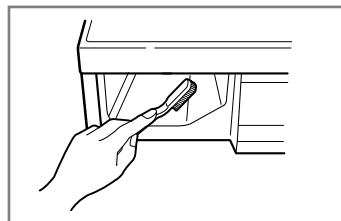

■ The washing drum

- If you live in a hard water area, limescale may continuously build up in places where it cannot be seen and thus not easily removed. Over time the build up of scale clogs appliances, and if it is not kept in check, expensive maintenance or repairs may result.
- Although the washing drum is made of Stainless steel, specks of rust can be caused by small metal articles (paper clips, safety pins) which have been left in the drum.
- The washing drum should be cleaned from time to time.
- If you use descaling agents, dyes or bleaches, make sure they are suitable for washing machine use.
- * Descaler may contain chemicals that may damage part of your washing machine.
- * Remove any spots with a stainless steel cleaning agent.
- * Never use steel wool.

Maintenance

■ The water circulation nozzle & steam nozzle

- Clean the water circulation nozzle, if clogged.

■ Cleaning your washer

1. Exterior

Proper care of your washer can extend its life.

The outside of the machine can be cleaned with warm water and a neutral non abrasive household detergent.

Immediately wipe off any spills. Wipe with damp cloth.

Try not to hit surface with sharp objects.

* IMPORTANT: Do not use methylated spirits, diluents or similar products.

2. Interior

Dry around the washer door opening, flexible gasket and door glass.

Run washer through a complete cycle using hot water.

Repeat process if necessary.

NOTE Remove hard water deposits using only cleaners labeled as safe for washing machine.

■ Winterizing instructions

If the washer is stored in an area where freezing may occur or moved in freezing temperatures, follow these instructions to prevent damage to the washer:

1. Turn off water supply tap.
2. Disconnect hoses from water supply and drain water from hoses.
3. Plug electrical cord into a properly grounded electrical outlet.
4. Add 1gallon(3.8L) of nontoxic recreational vehicle(RV) antifreeze into an empty wash drum. Close the door.
5. Set spin cycle and let washer spin for 1minute to drain out all water.
Not all of the RV antifreeze will be expelled.
6. Unplug electrical power cord, dry the drum interior, and close the door.
7. Remove dispenser drawer, drain and dry excessive water from the compartments.
8. Store washer in an up right position.
9. To remove antifreeze from washer after storage, run empty washer through a complete cycle using detergent. Do not add wash load.

Troubleshooting guide

* This washing machine is equipped with automatic safety functions which detect and diagnose faults at an early stage and react appropriately.

When the machine does not function properly or does not function at all, check the following points before you contact your service provider.

■ Diagnosing Problem

Symptom	Possible Cause	Solution
Rattling and clanking noise	<ul style="list-style-type: none"> Foreign objects such as coins or safety pins maybe in drum or pump. 	<p>Stop washer and check drum and drain filter.</p> <p>If noise continues after washer is restarted, call your authorised service centre.</p>
Thumping sound	<ul style="list-style-type: none"> Heavy wash loads may produce a thumping sound. This is usually normal. 	<p>If sound continues, washer is probably out of balance. Stop and redistribute wash load.</p>
Vibrating noise	<ul style="list-style-type: none"> Have all the transit bolts and packing been removed? Are all the feet resting firmly on the ground? 	<p>If not removed during installation. Refer to Installation guide for removing transit bolts.</p> <p>Wash load may be unevenly distributed in drum. Stop washer and rearrange wash load.</p>
Water leaks.	<ul style="list-style-type: none"> Fill hoses or drain hose are loose at tap or washer. House drain pipes are clogged. There is something between the gasket and the glass. 	<p>Check and tighten hose connections.</p> <p>Unclog drain pipe. Contact plumber if necessary.</p> <p>Clean the gasket and the glass with the towel.</p>
Over sudsing	<ul style="list-style-type: none"> Too much detergent or unsuitable detergent may cause excessive foaming which may result in water leaks, and vibration during spin. 	
Water does not enter washer or it enters slowly	<ul style="list-style-type: none"> Water supply is not adequate in area. Water supply tap is not completely open. Water inlet hose(s) are kinked. The filter of the inlet hose(s) clogged. 	<p>Check another tap in the house.</p> <p>Fully open tap.</p> <p>Straighten hose.</p> <p>Check the filter of the inlet hose.</p>

Troubleshooting guide













Symptom	Possible Cause	Solution
Water in the washer does not drain or drains slowly.	<ul style="list-style-type: none"> • Drain hose is kinked or clogged. • The drain filter is clogged. 	<p>Clean and straighten the drain hose.</p> <p>Clean the drain filter.</p>
Washer does not start	<ul style="list-style-type: none"> • Electrical power cord may not be plugged in or connection may be loose. • House fuse blown, circuit breaker tripped, or a power outage has occurred. • Water supply tap is not turned on. 	<p>Make sure plug fits tightly in wall outlet.</p> <p>Reset circuit breaker or replace fuse. Do not increase fuse capacity. If problem is a circuit overload, have it corrected by a qualified electrician. Turn on water supply tap.</p>
Washer will not spin	* Check that the door is firmly shut.	Close the door and press the Start/Pause button. After pressing the Start/Pause button, it may take a few moments before the clothes washer begins to spin. The door must lock before spin can be achieved.
Door does not open	The door lock will only release After 2~3 minutes, either at the end of the cycle or after pressing the Start/ Pause button During a wash.	Once started, the door can not be opened for safety reasons. Wait one or two minutes before opening the door to give the electric locking mechanism time to release.
Display stuck on 6min left.	This washing machine checks the condition of the clothes at 6min left to evaluate if they are dried or not. If the clothes are not dried, the washing machine will continue to dry for an extended period. The 6 min display will then count down after this period	Check the weight of clothes. The weight of the clothes should be less than 6kg.
Washer pauses for longer intervals than normal during tumbling.	The bowl will tumble for 3 seconds and then pause for 50 seconds repeatedly for part of the wash cycle. This is normal during the standard course & Hand Wash & Wool cycles. * Standard course: Cotton 40°C, Normal, Rinse-3, Spin-High	This action allows the more delicate clothes to soak which assists in stain removal.

Troubleshooting guide

Symptom	Possible Cause	Solution
Wash cycle time delayed	<ul style="list-style-type: none">• It takes time to balance the laundry before the spin cycle	<p>The washing time may vary by the amount of laundry, water pressure, water temperature and other usage conditions.</p> <p>If the imbalance is detected or if the suds removing program works, the wash time shall be increased.</p> <p>Stop the wash and pull out the laundry then put it again to untwist</p>
Dry problem	<ul style="list-style-type: none">• Does not dry	<p>Do not overload.</p> <p>Check that the washer is draining properly to extract adequate water from the load.</p> <p>Clothes load is too small to tumble properly. Add a few towels.</p>

Troubleshooting guide

■ Error Messages

Symptom	Possible Cause	Solution
	<ul style="list-style-type: none"> • Water supply is not adequate in area • Water supply taps are not completely open. • Water inlet hose(s) are kinked. • The filter of the inlet hose(s) are clogged. 	Check another tap in the house. Fully open tap. Straighten hose(s). Check the filter of the inlet hose(s).
	<ul style="list-style-type: none"> • Drain hose is kinked or clogged. • The drain filter is clogged. 	Clean and straighten the drain hose. Clean the drain filter.
	<ul style="list-style-type: none"> • Load is too small. • Load is out of balance. • The appliance has an unbalance detection and correction system. If individual heavy articles are loaded (ex. bath mat, both robe, etc.), this system may stop spinning or even interrupt the spin cycle altogether. • If the laundry is still too wet at the end of the cycle, add smaller articles of laundry to balance the load and repeat the spin cycle. 	Add 1 or 2 similar items to help balance the load. Rearrange load to allow proper spinning
	 <ul style="list-style-type: none"> • Is the door opened or not completely closed? 	Close the door completely. * If “dE” is not released, call for service.
		Unplug the power plug and call for service.
	<ul style="list-style-type: none"> • Water overfills due to the faulty water valve. 	Close the water tap. Unplug the power plug. Call for service.
	<ul style="list-style-type: none"> • Water level sensor has malfunctioned. 	
		
	<ul style="list-style-type: none"> • Over load in motor. 	
	<ul style="list-style-type: none"> • Check water supply. 	Turn the tap on If “dHE” is not released, unplug power plug and call service.
	<ul style="list-style-type: none"> • The washer experienced a power failure. 	Restart the cycle.

Troubleshooting guide

NOTE

- If the moisture inside the drum is not removed well after the use, it can cause odor or stains (Mold). After using the washer, keep the door open until the moisture inside the drum dries up.

■ Using SMARTDIAGNOSIS™

- Only use this feature when instructed to do so by the call center.
The transmission sounds similar to a fax machine, and so has no meaning except to the call center.
- SMARTDIAGNOSIS™ cannot be activated if the washer does not power up.
If this happens, then troubleshooting must be done without SMARTDIAGNOSIS™.

If you experience problems with your washer, call to Customer Information Center. Follow the call center agent's instructions, and do the following steps when requested:

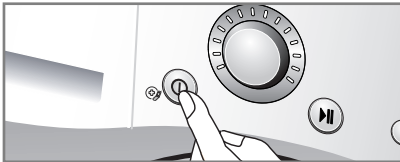

1. Press the Power button to turn on the washer.
Do not press any other buttons or turn the cycle selector knob.

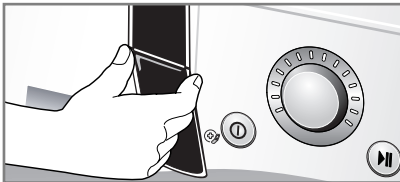

2. When instructed to do so by the call center, place the mouthpiece of your phone very close to the Power button.

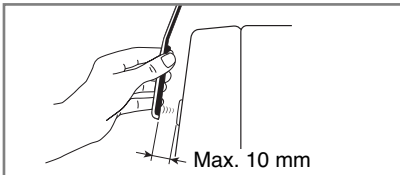
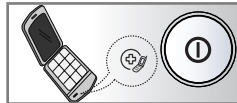

3. Press and hold the "Temp." button for three seconds, while holding the phone mouthpiece to the icon or Power button.
 4. Keep the phone in place until the tone transmission has finished.
This takes about 17 seconds, and the display will count down the time.
 - For best results, do not move the phone while the tones are being transmitted.
 - If the call center agent is not able to get an accurate recording of the data, you may be asked to try again.
 - Pressing the Power button during the transmission will shut off the SMARTDIAGNOSIS™.
 5. Once the countdown is over and the tones have stopped, resume your conversation with the call center agent, who will then be able to assist you using the information transmitted for analysis at the call to Customer information center.
- * Smart Diagnosis is a troubleshooting feature designed to assist, not replace, the traditional method of troubleshooting through service calls. The effectiveness of this feature depends upon various factors, including, but not limited to, the reception of the cellular phone being used for transmission, any external noise that may be present during the transmission, and the acoustics of the room where the machine is located. Accordingly, LG does not guarantee that Smart Diagnosis would accurately troubleshoot any given issue.

What Is Not Covered:

- Service trips to your home to teach you how to use the product.
- If the product is connected to any voltage other than that shown on the rating plate.
- If the fault is caused by accident, neglect, misuse or Act of God.
- If the fault is caused by factors other than normal domestic use or use in accordance with the owner's manual.
- Provide instruction on use of product or change the set-up of the product.
- If the fault is caused by pests for example, rats or cockroaches etc..
- Noise or vibration that is considered normal for example water drain sound, spin sound, or warming beeps.
- Correcting the installation for example, leveling the product, adjustment of drain.
- Normal maintenance which recommended by the owner's manual.
- Removal of foreign objects / substances from the machine, including the pump and inlet hose filter for example, grit, nails, bra wires, buttons etc.
- Replace fuses in or correct house wiring or correct house plumbing.
- Correction of unauthorized repairs.
- Incidental or consequential damage to personal property caused by possible defects with this appliance.
- If this product is used for commercial purpose, it is not warranted.

(Example : Public places such as public bathroom, lodging house, training center, dormitory)

If the product is installed outside the normal service area, any cost of transportation involved in the repair of the product, or the replacement of a defective part, shall be borne by the owner.

