



ENGLISH

OWNER'S MANUAL MUSIC IN STYLE DOCKING SPEAKER

Please read this manual carefully before operating your set and retain it for future reference.

ND1520



MFL67565030

Safety Information



CAUTION: TO REDUCE THE RISK OF ELECTRIC SHOCK DO NOT REMOVE COVER (OR BACK) NO USER-SERVICEABLE PARTS INSIDE REFER SERVICING TO QUALIFIED SERVICE PERSONNEL.



This lightning flash with arrowhead symbol within an equilateral triangle is intended to alert the user to the presence of uninsulated dangerous voltage within the product's enclosure that may be of sufficient magnitude to constitute a risk of electric shock to persons.

The exclamation point within an equilateral triangle is intended to alert the user to the presence of important operating and maintenance (servicing) instructions in the literature accompanying the product.



WARNING: TO PREVENT FIRE OR ELECTRIC SHOCK HAZARD, DO NOT EXPOSE THIS PRODUCT TO RAIN OR MOISTURE.

WARNING: Do not install this equipment in a confined space such as a book case or similar unit.

NOTICE : For safety marking information including product identification and supply ratings, please refer to the main label on the bottom of the apparatus.

CAUTION concerning the Power Cord

Most appliances recommend they be placed upon a dedicated circuit;

That is, a single outlet circuit which powers only that appliance and has no additional outlets or branch circuits. Check the specification page of this owner's manual to be certain. Do not overload wall outlets. Overloaded wall outlets, loose or damaged wall outlets, extension cords, frayed power cords, or damaged or cracked wire insulation are dangerous. Any of these conditions could result in electric shock or fire. Periodically examine the cord of your appliance, and if its appearance indicates damage or deterioration, unplug it, discontinue use of the appliance, and have the cord replaced with an exact replacement part by an authorized service center. Protect the power cord from physical or mechanical abuse, such as being twisted, kinked, pinched, closed in a door, or walked upon. Pay particular attention to plugs, wall outlets, and the point where the cord exits the appliance. To disconnect power from the mains, pull out the mains cord plug. When installing the product, ensure that the plug is easily accessible.

This device is equipped with a portable battery or accumulator.

Safety way to remove the battery or the battery from the equipment: Remove the old battery or battery pack, follow the steps in reverse order than the assembly. To prevent contamination of the environment and bring on possible threat to human and animal health, the old battery or the battery put it in the appropriate container at designated collection points. Do not dispose of batteries or battery together with other waste. It is recommended that you use local, free reimbursement systems batteries and accumulators. The battery shall not be exposed to excessive heat such as sunshine, fire or the like.

CAUTION: The apparatus shall not be exposed to water (dripping or splashing) and no objects filled with liquids, such as vases, shall be placed on the apparatus.

Table of Contents

1 Getting Started

- 2 Safety Information
- 5 Unique Features
 - 5 – Made for iPod/iPhone
 - 5 – Portable In
 - 5 – Alarm
 - 5 – Radio(FM)
 - 5 – Time Sync
- 5 Accessories
- 5 Introduction
 - 5 – Symbol Used in this Manual
- 6 Front panel
- 7 Back panel
- 8 Connecting the AC adapter

2 Operating

- 9 Overall Operation
- 10 Basic Operations
 - 10 – iPod/iPhone Operations
 - 10 – Compatible iPod/iPhone
- 11 Setting the Clock
 - 11 – Using your unit as an alarm clock
 - 11 – SNOOZE
 - 11 – Dimmer
- 12 – Sleep Timer Setting
- 12 Radio Operations
 - 12 – Antenna Connection
 - 13 – Presetting the Radio Stations
- 13 Advanced Operation
 - 13 – Listening to music from your external device

3 Troubleshooting

- 14 Troubleshooting

4 Appendix

- 15 Trademarks and Licenses
- 16 Specifications
- 17 Handling the Unit

Unique Features

Made for iPod/iPhone

Enjoys music from iPod/iPhone with simple connection.

Portable In

Listens to music from your portable device.

Alarm

Sets alarm which go off at desired time.

Radio(FM)

Listens to the radio.

Time Sync

Sets your unit's clock automatically by using iPod/iPhone.

Accessories

Please check and identify the supplied accessories.

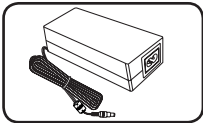

AC adapter(1)

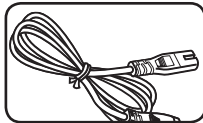

Power cord(1)

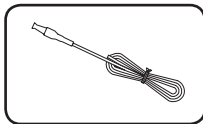

FM antenna(1)

Introduction

Symbol Used in this Manual

! Note

Indicates special notes and operating features.

! Caution

Indicates cautions for preventing possible damages from abuse.

Front panel

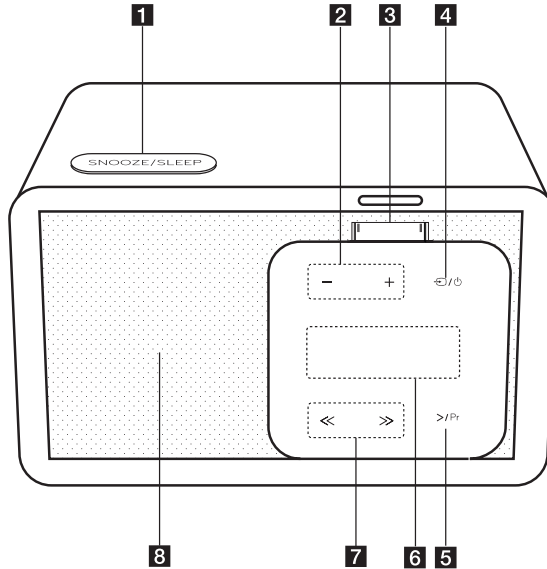

1 SNOOZE/SLEEP

- Wakes you up every 10 minutes while alarm function activates.
- Turns the unit off automatically at specific time.





2 - / + (VOLUME)

Adjusts speaker volume.

3 iPod/iPhone Dock

Connects an iPod/iPhone.

4 /

- Selects the function and input source.
- Turns on : Press  / .
- Turns off : Press and hold  / .

5 >/Pr

- Selects and listens programme of radio : Press >/Pr in FM mode.
- Store radio station : Press and hold >/Pr in FM mode.
- Starts presetting a station.

6 Display window

Shows the status.

7 <</>> (SKIP/SEARCH)

- SKIP : Press <</>>.
- SEARCH : Press and hold <</>>.
- In FM mode, tunes in the desired radio station and selects a preset number.

8 Speaker

Back panel

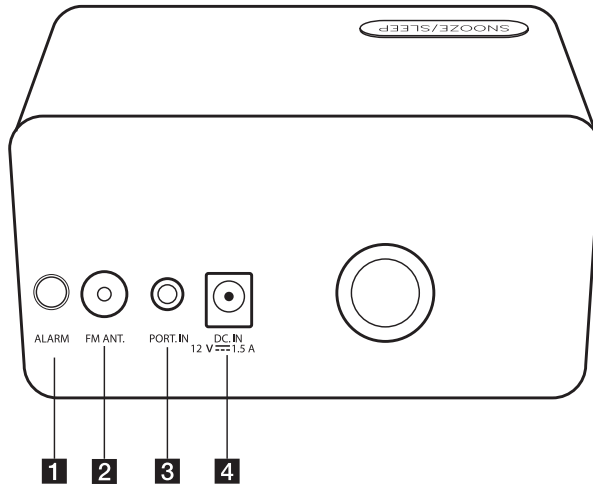

1 ALARM

- Sets the alarm timer.
- Turns off the alarm.
- Displays alarm setting.

2 FM ANT.

3 PORT.IN

Listens to music from your portable device.

4 DC.IN 12 V 1.5 A (AC adapter input)

Connecting the AC adapter

1

Getting Started

1. Connect the supplied AC power cord to the AC adapter.
2. Connect the AC adapter cable to DC.IN adapter input.
3. Plug the AC power cord into an AC outlet. Then the unit goes into standby mode.

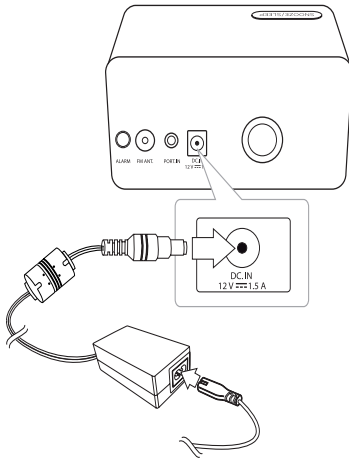





! Caution

Only use the AC adapter supplied with this device. Do not use a power supply from another device or manufacturer. Using any other power cable or power supply may cause damage to the device and void your warranty.

Overall Operation

You can operate the unit by using these button. To get more information, refer to the table below.

Mode Button	Standby	IPOD	PORT	FM	During alarm setting	During alarm operation
- / +	-	VOL -/+	VOL -/+	VOL -/+	VOL -/+	VOL -/+
Press 	Power on	Changes each of functions	Changes each of functions	Changes each of functions	Stops alarm setting Changes each of functions	Power off
Press and hold 	Power on	Power off	Power off	Power off	Stops alarm setting Power off	Stops alarm function Power off
	-	Skip -/+	-	Tune -/+	VOL -/+ Sets an hour and minute	-
Press 	-	Play/Pause	-	Listens a preset station	Stores alarm sources	-
Press and hold 	-	-	-	Selects a preset number	-	-
SNOOZE/ SLEEP	-	Sleep (Dimmer)	Sleep (Dimmer)	Sleep (Dimmer)	Stops alarm setting Sleep (Dimmer)	SNOOZE
Press ALARM	Activates or deactivates alarm	Activates or deactivates alarm	Activates or deactivates alarm	Activates or deactivates alarm	Stops alarm setting	Stops alarm function Power off
Press and hold ALARM	Starts alarm setting	Starts alarm setting	Starts alarm setting	Starts alarm setting	Stops alarm setting	Stops alarm function Power off

Basic Operations

iPod/iPhone Operations

You can enjoy the sound with your iPod/iPhone. For details about iPod/iPhone, refer to the iPod/iPhone User Guide.

1. Connect the iPod/iPhone firmly. If you turn this unit on, your iPod/iPhone is automatically turned on and starts recharging .

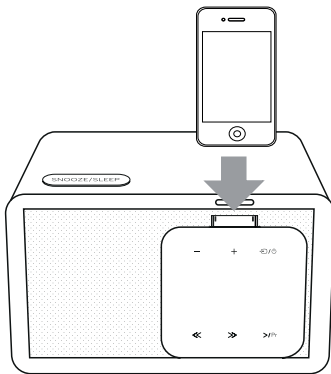

2. Press \odot/ϕ to select IPOD function.

To	Do this
Pauses or restart	Press $>/Pr$.
Skip	During playback, press \ll / \gg to go to the next file or to return to the beginning of the current file. During playback, press \ll twice briefly to step back to the previous file.
Search	Press and hold \ll / \gg during playback and release it at the point you want to listen to.

Compatible iPod/iPhone

- The unit supports the models as follows ;
iPod touch
iPod classic
iPod nano
iPhone 4S
iPhone 4
iPhone 3GS
iPhone 3G

Depending on your iPod/iPhone's software version, you may not control your iPod/iPhone from the unit.

Depending on your iPod/iPhone device, you may not control your iPod/iPhone from the unit.

! Note

- If this unit displays an error message, follow the message. An error message "ERR".
 - Your iPod/iPhone is not connected firmly.
 - This unit recognizes your iPod/iPhone as an unknown device.
 - Your iPod/iPhone is exceptionally low in power.
 - ➔ The battery needs to be charged.
 - ➔ If you charge the battery while iPod/iPhone is extremely low in power, it may take longer to be charged.
- Depending on your iPod/iPhone's software version, it may not be possible to control your iPod/iPhone from this unit. We recommend installing the latest software version.
- If you use an application, make a call, or send and receive SMS text message, etc. on iPod touch or iPhone, disconnect it from iPod/iPhone dock of this unit and then use it.
- If you have a problem with your iPod/iPhone, please visit www.apple.com/support.
- In standby mode, you can charge your iPod/iPhone by connecting it to iPod/iPhone Dock.
- You may need additional operation for iPod touch or iPhone, for example "unlock" by dragging the slider.

Setting the Clock

Connect the iPod/iPhone firmly. Then the clock setting in the display window will synchronize with your iPod/iPhone.

After the unit synchronized with your iPod/iPhone for clock setting, there will be a time difference between the iPod/iPhone and the unit. In standby mode, the clock won't synchronized with your iPod/iPhone.

! Note

Check the current time on iPod/iPhone is correct or not. If not, reset it correctly depending on present time. Wrong time on the iPod/iPhone may result in the time difference between your iPod/iPhone and the unit.

Using your unit as an alarm clock

1. Turn the unit on or off.
2. Press and hold **ALARM** to set the alarm function.
3. The alarm sound sources blinks. (FM(TUNER)/IPOD). While each of sound sources blinks, select the one you want by pressing **>/Pr**. If you select FM(TUNER) mode, you can select the station you set before by pressing **<</>>**.
4. "ON (TIME)" setting is displayed. The hour setting blinks. Press **<</>>** to select the hour and then press **>/Pr** to save.
5. The minute setting blinks. Press **<</>>** to select the minute and then press **>/Pr** to save.
6. The volume settings blinks. Press **<</>>** to change the volume and then press **>/Pr** to save.
7. You can check the setting status.
8. If you want to reset the alarm, repeat steps 2-6.



SNOOZE

While alarm activates, snooze function wakes you up every 10 minutes if you press **SNOOZE/SLEEP**. If the time you set is up, the unit turns on automatically and the alarm function works. If you press **SNOOZE/SLEEP**, the alarm function stops working. "ZZZ" and "🔔" will blink. The alarm sounds again in 10 minutes.

Dimmer

Press **SNOOZE/SLEEP** once. The display window will be darkened by half. To cancel it, press **SNOOZE/SLEEP** repeatedly until the display window get bright.

Note

- If you don't set clock on your iPod/iPhone, the unit will not be synchronized with the clock with your iPod/iPhone.
- If you unplug the cord from an outlet, the clock setting you set won't be stored.
- After setting a clock function, you can set alarm function.
- Since the alarm goes off if you don't press any button for 30 minute, the alarm will stop working automatically.
- If you set the clock and alarm, you can check the time and alarm icon "🔔" by pressing **ALARM** although the unit is stand by mode.
- If you activate the alarm, the alarm icon "🔔" will appear in the display window.
- If you deactivate the alarm, the alarm icon "🔔" will disappear in the display window.
- Alarm function only works when the unit is turned off.
- If the time you set is up, the unit will be turned on automatically.
- After alarm function works, you can turn it off by pressing **ALARM** or  / .
- You can only set 12 : 00. (for an PM display)

Sleep Timer Setting

While listening to music or radio, press **SNOOZE/SLEEP** repeatedly to select delay time between 10 and 180 minutes. After delay time, the unit will turn off. (You can see the following order, 180 -> 150 -> 120 -> 90 -> 80 -> 70 -> 60 -> 50 -> 40 -> 30 -> 20 -> 10)

To cancel the sleep function, press **SNOOZE/SLEEP** repeatedly until the display window get bright.





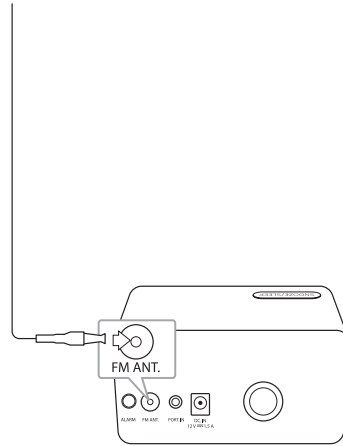

Note

- You can check the remaining time before the unit turns off by pressing **SNOOZE/SLEEP**.
- Sleep function will work after dimmer function.

Radio Operations**Antenna Connection**

Connect the FM wire antenna to FM antenna connector.



1. Press  /  repeatedly until FM appears in the display window. The last received station is tuned in.
2. Auto tuning : Press  /  for about 2 seconds until the frequency indication starts changing, then release. scanning stops when the unit tunes in a station.
Manual tuning: Press  /  repeatedly.
3. Adjust the volume by pressing **- / + (VOLUME)** .

Presetting the Radio Stations

You can preset 10 stations for FM.

Before tuning, make sure that you have turned down the volume.

1. Press repeatedly until FM appears in the display window.
2. Select the desired frequency by using .
3. Press and hold . A preset number will blink in the display window.
4. Press to select the preset number you want.
5. Press . The station is stored.
6. Repeat the steps 2 to 5 to store other stations.
7. To listen a preset station, press and then to select a preset station.

Note

- If all stations have already been preset, "FULL" will appear in the display window for a moment and then a preset number will blink. To change the preset number, repeat the steps 4-5.
- You can not delete preset stations.
- Although all stations were preset, you can preset a station by overwriting the previous station.
- While listening to radio if you press and hold , a preset number you listened to lastly will blink first to overwrite the previous station.
- While listening to a preset station if you want to change it's preset number at a same frequency, press and hold . And then change a preset number by pressing .

Advanced Operation

Listening to music from your external device

The unit can be used to play the music from many types of external device. (Portable cable is not supplied as an accessory with this unit.)

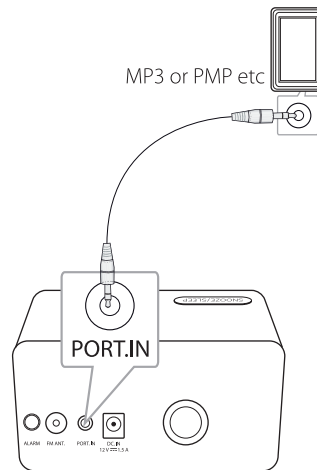

1. Connect the external device to the **PORT.IN** connector of the unit.
2. Turn the power on by pressing .
3. Select the PORT (PORTABLE) function by pressing .
4. Turn the external device on and start playing it.

Troubleshooting

Problem	Correction
No Power.	<ul style="list-style-type: none"> • Plug in the power cord. • Check the condition by operating other electronic devices.
No sound.	Press  and check the selected function.
Radio stations cannot be tuned in properly.	<ul style="list-style-type: none"> • Adjust its position. • Tune to the station manually. • Preset some radio stations, see page 13 for details.
iPod/iPhone does not work.	Connect iPod/iPhone to the unit correctly.
Clock does not displayed.	Connect iPod/iPhone to the unit correctly.

Trademarks and Licenses



"Made for iPod" and "Made for iPhone" mean that an electronic accessory has been designed to connect specifically to iPod or iPhone respectively, and has been certified by the developer to meet Apple performance standards. Apple is not responsible for the operation of this device or its compliance with safety and regulatory standards.

Please note that the use of this accessory with iPod, iPhone may affect wireless performance.

Specifications

General	
AC adapter requirements	DC 12 V $\overline{\text{---}}$ 1.5 A, 100 - 240V, 50/ 60 Hz
Power consumption	18 W
Dimensions (W x H x D)	158 x 88 x 67(87) mm
Net Weight (Approx.)	0.57 kg
Operating temperature	5 °C to 35 °C (41 °F to 95 °F)
Operating humidity	5 % to 90 %
Bus Power Supply	iPod/iPhone : DC 5 V $\overline{\text{---}}$ 1 A

Inputs	
PORT. IN	500 mV (3.5 mm stereo jack)

Tuner	
FM Tuning Range	87.5 MHz to 108.0 MHz or 87.50 MHz to 108.00 MHz

Amplifier	
Output Power	5 W X 1ch (8 Ω at 1 kHz)
T.H.D	10 %

Speakers	
Type	built-in
Impedance Rated	8 Ω
Rated Input Power	5 W
Max Input Power	10 W

- Design and specifications are subject to change without notice.

Handling the Unit

When shipping the unit

Please save the original shipping carton and packing materials. If you need to ship the unit, for maximum protection, re-pack the unit as it was originally packed at the factory.

Keeping the exterior surfaces clean

Do not use volatile liquids such as insecticide spray near the unit.

Wiping with strong pressure may damage the surface.

Do not leave rubber or plastic products in contact with the unit for a long period of time.

Cleaning the unit

To clean the player, use a soft, dry cloth. If the surfaces are extremely dirty, use a soft cloth lightly moistened with a mild detergent solution. Do not use strong solvents such as alcohol, benzine, or thinner, as these might damage the surface of the unit.

