



**LG**

Life's Good

ENGLISH

ARABIC

Owner's Manual

# REFRIGERATOR FREEZER

Please read this manual carefully before operating  
your set and retain it for future reference

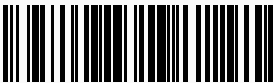

MFL67606302

P/NO : MFL67606302

[www.lg.com](http://www.lg.com)



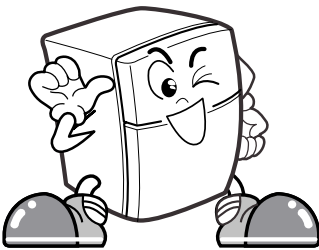

# CONTENTS

IMPORTANT SAFETY INFORMATION.....	3
INSTALLATION .....	10
INNER PARTS .....	11
OPERATIONS .....	12
<b>CT6 / CT4 / CT3</b>	
Starting	
Before Setting The Temperature	
Door Alarm	
Lamp Auto-Off Feature	
Self Test	
Controls For Freezer Compartment	
Controls For Refrigerator Compartment	
Super Cool	
Child Lock	
Green Ion Door Cooling(Optional)	
Ice Making(Optional)	
Convertible Corner/Fresh Zone	
Vegetable Drawer	
Defrosting	
Deodorizer(Optional)	
Dairy Corner(Optional)	
Water Dispenser(Optional)	
SUGGESTIONS ON FOOD STORAGE.....	18
CLEANING .....	19
GENERAL INFORMATION .....	21
IMPORTANT WARNINGS .....	22
BEFORE CALLING FOR SERVICE.....	23



# IMPORTANT SAFETY INFORMATION



## WARNING

-  Keep the air vents clear of obstruction.
-  Do not use mechanical devices or other means to accelerate the defrosting process, other than those recommended by the manufacturer.
-  Do not damage the refrigerant circuit.
-  Do not use electrical appliances inside the food storage compartment, unless they are recommended by the manufacturer.
-  The refrigerant and insulation blowing gas used in the appliance requires special disposal procedures. When disposal, please consult with services agent or a similarly qualified person.

## BASIC SAFETY PRECAUTIONS

This guide contains many important safety messages. Always read and obey all safety messages.

 This is a safety alert symbol. It alerts you to safety messages that inform you of hazards that can hurt or seriously injured or cause damage to the product. All safety messages will be preceded by the safety alert symbol and the hazard signal word DANGER, WARNING, or CAUTION. These words mean:

	<b>DANGER</b>	You will be hurt or seriously injured if you don't follow instructions.
	<b>WARNING</b>	To reduce the risk of fire, electric shock, or injury to persons when using your product, basic safety precautions should be followed, including the following. Read all instructions before using this appliance.
	<b>CAUTION</b>	Indicates an imminently hazardous situation which, if not avoided, may result in minor or moderate injury, or product damage only.

All safety messages will identify the hazard, tell you how to reduce the chance of injury, and tell you what can happen if the instructions are not followed.

## If gas used is R600a

This appliance contains a small amount of isobutane refrigerant (R600a), natural gas with high environmental compatibility, but it is also combustible. When transporting and installing the appliance, care should be taken to ensure that no parts of the refrigerating circuit are damaged. Refrigerant squirting out of the pipes could ignite or cause an eye injury. If a leak is detected, avoid any naked flames or potential sources of ignition and air the room in which the appliance is standing for several minutes.

In order to avoid the creation of a flammable gas air mixture if a leak in the refrigerating circuit occurs, the size of the room in which the appliance may be sited depends on the amount of refrigerant used. The room must be 1m<sup>2</sup> in size for every 9g of R600a refrigerant inside the appliance. The amount of refrigerant in your particular appliance is shown on the identification plate inside the appliance. Never start up an appliance showing any signs of damage. If in doubt, consult your dealer.

# DISPOSAL OF YOUR OLD APPLIANCE



1. When this crossed-out wheeled bin symbol is attached to a product it means the product is covered by the e-waste (Management and Handling) Rules, 2011.
2. All electrical & electronic products should be disposed of separately from the municipal waste stream via designated collection facilities appointed by the government or the local authorities.
3. The correct disposal of your old appliance will help prevent potential negative consequences for the environment and human health.
4. For more detailed information about disposal of your old appliance, please contact your city office, waste disposal service or the shop where you purchased the product.
5. This product does not contain any of the hazardous substances as specified in the rule 13 (1) and (2) of the e-waste (Management and Handling) Rules, 2011.

## ⚠ WARNING

To reduce the risk of fire, electric shock, or injury to persons when using your product, basic safety precautions should be followed, including the following. Read all instructions before using this appliance.

## IMPORTANT SAFETY INFORMATION

### 1. When connecting the power

#### Dedicated outlet should be used.

- Using several devices at one outlet may cause fire.

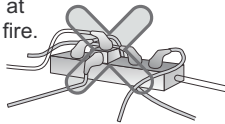

#### Do not allow the power plug to face upward or to be squeezed at the back of the refrigerator.

Plug may get damaged, which causes fire or electric shock.

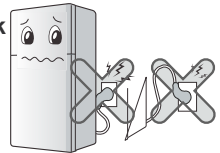

#### Do not allow the power cord to bend or pressed by heavy object.

It may damage the power cord and cause fire or electric shock.



#### Do not extend or modify the length of the power plug.

It damages the power cord and cause electric shock or fire.

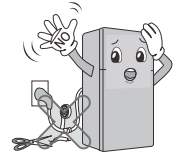

#### Unplug the power plug while cleaning, handling or replacing the interior LED lamp of the refrigerator.

- It may cause electric shock or injury.



#### Do not pull out the cord or touch the power plug with wet hands.

- It may cause electric shock or injury.

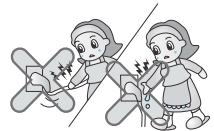

# IMPORTANT SAFETY INFORMATION

## 1. When connecting the power

**Remove water or dust from the power plug and insert it with the ends of the pins securely connected.**

Dust, water or unstable connection may cause fire or electric shock.

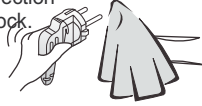

**Make sure of grounding.**

Incorrect grounding may cause breakdown and electric shock.

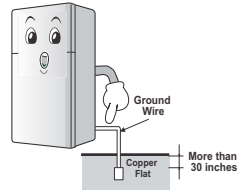

**When the power cord or the power plug is damaged or the holes of the outlet are loosed, do not use them.**

It may cause electric shock or short circuit.

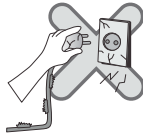

## 2. When using the refrigerator

**Do not place heavy object or the dangerous object (container with liquid) on the refrigerator.**

It may fall and cause injury, fire or electric shock when opening or closing the door.



**Do not cling to the door or the shelves of the door or home bar of the freezer or the cool chamber.**

It may make the refrigerator fall over or damage the hands. Especially, do not allow the children to do the above.



**Do not install the refrigerator in wet place or place where water or rain splashes.**

Deterioration of insulation of electric parts may cause electric leakage.



**Do not use or store inflammable materials like ether, benzene, alcohol, medicine, LP gas, spray or cosmetics near or in the refrigerator.**

It may cause explosion or fire.

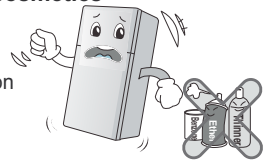

**Do not use drier to dry the inside, nor light a candle to remove odor**

It may cause explosion or fire.

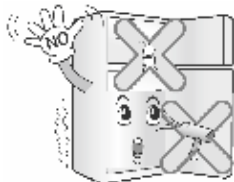

**Do not store medicine or academic materials in the refrigerator.**

When the material with strict temperature control is stored, it may be deteriorated or it may make an unexpected reaction to cause any risk.

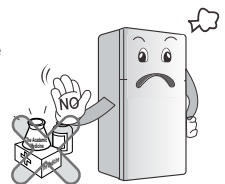

# IMPORTANT SAFETY INFORMATION

## 2. When using the refrigerator

**Do not use the combustible spray near the refrigerator.**

It may cause fire.

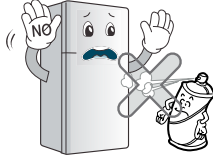

**Avoid heating devices.**

It may cause fire.

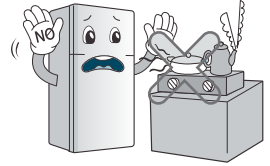

**Do not place flower vase, cup, cosmetics, medicine or any container with water on the refrigerator.**

It may cause fire, electric shock or injury by dropping down.

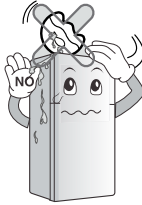

**Use the submerged refrigerator only after checking it.**

It may cause electric shock or fire.

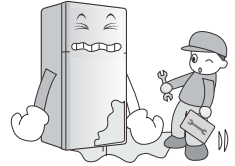

**When gas is leaked, do not touch the refrigerator or the outlet and ventilate the room immediately.**

During the handling / delivering, installation if used gas is (1) Tetrafluoroethane (R134a) - in spite of being Environment friendly & Non flammable, it may cause irritation to skin, eyes with small amount of vapor, hence proper ventilation across the Refrigerator area is must.

(2) Natural Gas (isobutene, R600a) - is an environment-friendly refrigerant, even a small amount (80~90g) is combustible. When the gas is leaked

due to severe damage during delivering, installing or using the refrigerator, any spark may cause fire or burn.

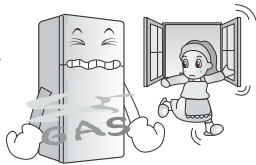

**Do not spray water at the outside or the inside of the refrigerator or do not clean it with benzene or thinner.**

Deterioration of insulation of electric parts may cause electric shock or fire.

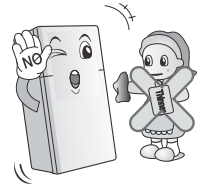

**When any strange smell or smoke is detected from the refrigerator, disconnect the power plug immediately and contact to the service center.**

It may cause fire.

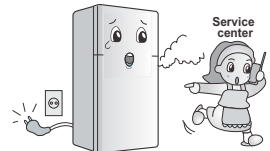

# IMPORTANT SAFETY INFORMATION

## 2. When using the refrigerator

**Do not allow any person except the qualified engineer to disassemble, repair or alter the refrigerator.**

It may cause injury, electric shock or fire.

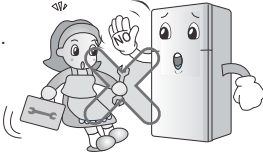

**Do not use the refrigerator for non-domestic purpose (storing medicine or testing material, using at the ship, etc.).**

It may cause an unexpected risk such as fire, electric shock, deterioration of stored material or chemical reaction.

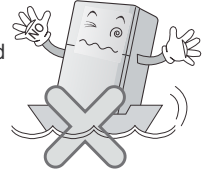

**When disposing the refrigerator, remove the packing materials from the door.**

It may cause to lock out the child.



**Install the refrigerator on a solid and level floor.**

Installing it on an unstable place may cause injury by falling down the refrigerator when opening or closing the door.

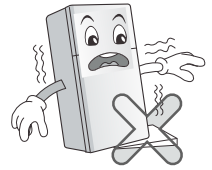

**Do not insert hand or metal stick into the exit of cool air, cover, bottom of the refrigerator, heat proof grill (exhaust hole) at backside.**

It may cause electric shock or injury.

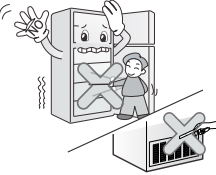

**What to do with your old refrigerator,**

Your refrigerator contains liquid (refrigerant, lubricant) made of recyclable materials. All these materials must be sent to a recycling waste disposal site as they can be reused after a specific recycling process.



**In case of thunder and lightning, or if not in use for a long period of time, detach the power plug.**

There is a danger of electric shock or fire.



**Place all the components in the right places before connecting the power.**

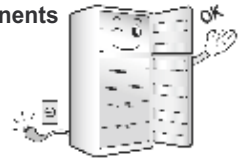

**Do not remove the back cover.**



**Never leave lit candles on the fridge, high risk of causing fire or product damage.**

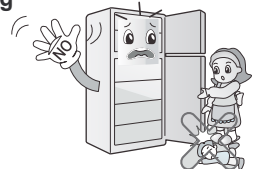

# IMPORTANT SAFETY INFORMATION

## ⚠ CAUTION

Violating these directions may cause injury or damage to health, house or furniture. Always be careful, please.

**Do not touch food or containers at the freezer with wet hands.**

It may cause frostbite.

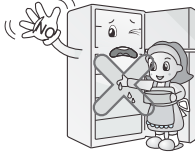

**Wait for 5 minutes or longer when reconnecting the plug.**

It may cause the operation of the freezer to fail.



**Do not put bottle in the freezer.**

It may freeze the contents to break the bottle to cause injury.



**Pull out the power plug not by grasping the cord. But by the plug of its end.**

It may cause electric shock or short circuit to fire.



**Carry the refrigerator with the handle bar provided at the bottom-front and top-rear of the refrigerator.**

Otherwise, your hands may be slipped to cause injury.

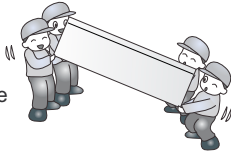

**Do not insert hand into the bottom of the refrigerator.**

The iron plate of the bottom may cause injury.

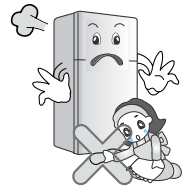

**Opening or closing the door of the refrigerator may cause injury to the person around it, please be careful.**

Opening or closing the door may cause feet or hands to be caught in the chink in door or child hand get hurt by the corner.

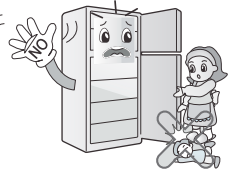



# IMPORTANT SAFETY INFORMATION

Do not put any living animal in the refrigerator.



Do not use carbonated water. Gas pressure may cause leakage.

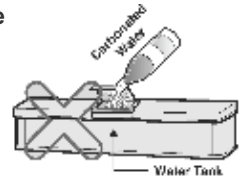

Do not lean on the doors, Hinges may deregulate themselves, causing air leak and performance deterioration

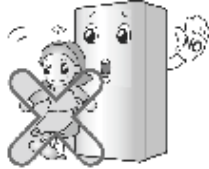

Clean the water tank according to the instructions.

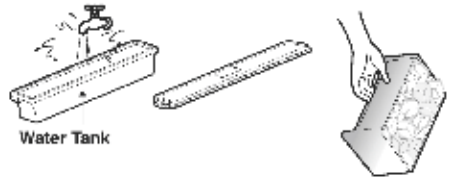

Movable parts like shelf, basket, etc should be handled with care.

May get damaged or break if dropped.

Use only water. If any other liquid is used, the operation of the system may be deteriorated. If a problem occurs by using any liquid other than water, the manufacturer will not be responsible.

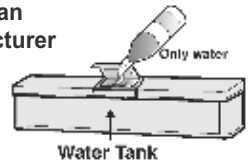

## WARNING



Please do not use a dishwasher to clean the lower drawers; the high temperature may cause damage to the baskets which make them unusable.

THIS REFRIGERATOR IS MANUFACTURED WITH GREAT CARE, AND UTILIZES THE LATEST IN TECHNOLOGY.

WE ARE CONFIDENT THAT YOU WILL BE FULLY SATISFIED WITH IT'S PERFORMANCE AND RELIABILITY.

BEFORE YOU START YOUR REFRIGERATOR, PLEASE READ THIS BOOKLET CAREFULLY. IT PROVIDES EXACT INSTRUCTIONS FOR INSTALLATION, OPERATION AND MAINTENANCE, AND ALSO SUPPLIES SOME USEFUL HINTS.

## INSTALLATION

1. Select a good location.  
Place your refrigerator where it is easy to use.
2. Avoid placing the unit near heat sources, direct sunlight or moisture.
3. To ensure proper air circulation around the fridge -freezer, please maintain sufficient space on both the sides as well as top and maintain at least 2 inches (5 cm) from the rear wall.
4. To avoid vibrations, the unit must be level. If required, adjust the leveling screws to compensate for unevenness of the floor. The front should be slightly higher than the rear to aid in door closing. Leveling screws can be turned easily by tipping the cabinet slightly.  
Turn the leveling screws clockwise(  ) to raise the unit, counterclockwise(  ) to lower it.
5. Don't install this appliance below 5 °C. It may cause the debasement of the refrigerator.

## NEXT

1. Clean your refrigerator thoroughly and wipe off all dust accumulated during shipping.
2. Install accessories such as ice cube box, etc., in their proper places. They are packed together to prevent possible damage during shipment.
3. Connect the power supply cord (or plug) to the outlet. Don't double up with other appliances on the same outlet.
4. Prior to storing food, leave your refrigerator on for 2 or 3 hours.  
Check the flow of cold air in the freezer compartment to ensure proper cooling. Your refrigerator is now ready for use.

# INNER PARTS

## Water Dispenser Model-

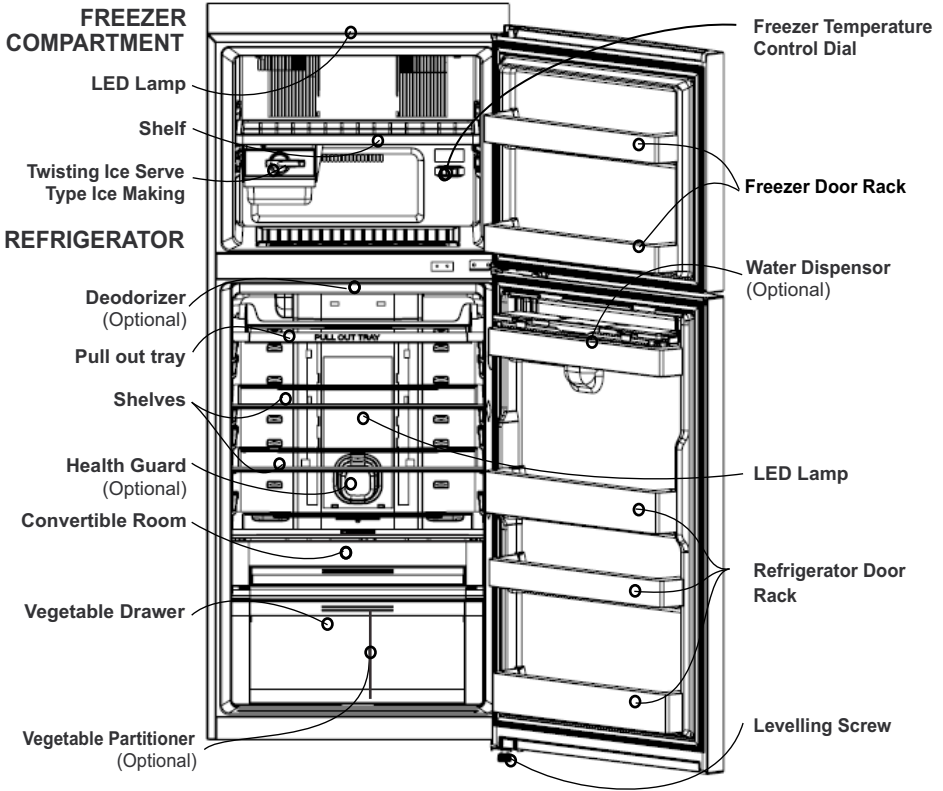

### NOTE

- This guide covers several different models. The refrigerator you have purchased may have some or all of the features shown above.
- To keep a position of inner parts like as baskets, drawers and shelves supplied by manufacturer is the most efficient usage for energy saving.

### SUGGESTION FOR ENERGY SAVING

- Please do not keep the door open for a long time, close door in the shortest time.
- Too much food are not advised to be put in enough space should be kept for cool air circulating freely.
- Do not set the temperature of refrigerator lower than needed. Do not put the food near the temperature sensor.
- Allow hot food to cool prior to storing. Placing hot food in the fridge-freezer could spoil other food, and lead to higher electric bills.
- Do not block air vents with food. Smooth circulation of cold air keeps fridge-freezer temperature even.
- Do not open the door frequently. Opening the door lets warm air enter the fridge-freezer, and cause temperature to rise.

# INNER PARTS

## Non Water Dispenser Model-

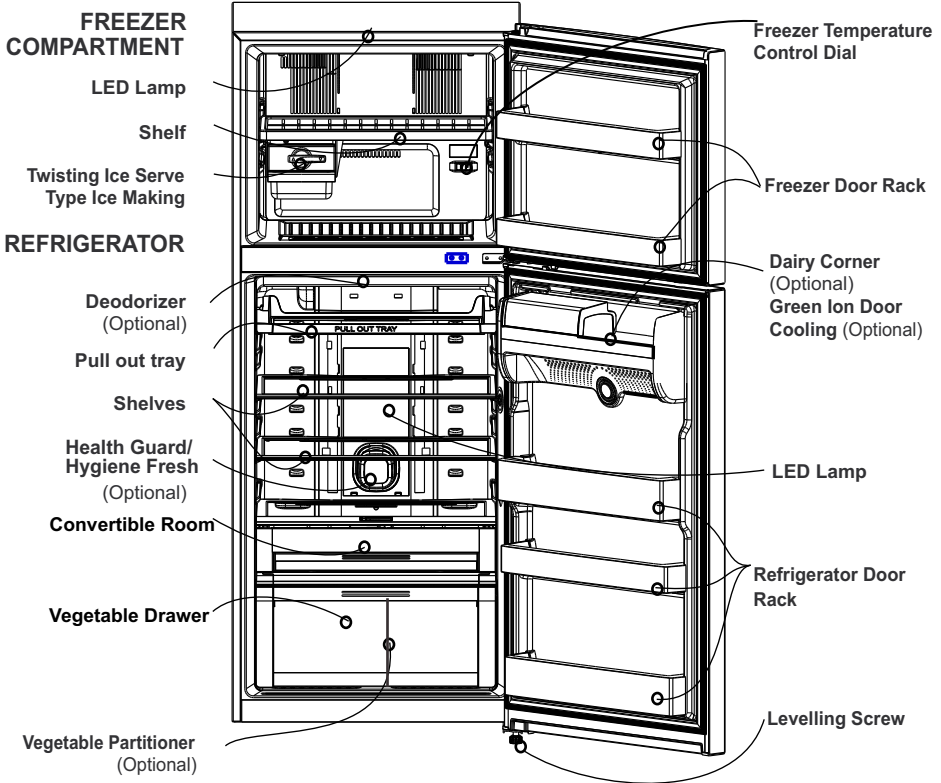

### NOTE

- This guide covers several different models. The refrigerator you have purchased may have some or all of the features shown above.
- To keep a position of inner parts like as baskets, drawers and shelves supplied by manufacturer is the most efficient usage for energy saving.

### SUGGESTION FOR ENERGY SAVING

- Please do not keep the door open for a long time, close door in the shortest time.
- Too much food are not advised to be put in enough space should be kept for cool air circulating freely.
- Do not set the temperature of refrigerator lower than needed. Do not put the food near the temperature sensor.
- Allow hot food to cool prior to storing. Placing hot food in the fridge-freezer could spoil other food, and lead to higher electric bills.
- Do not block air vents with food. Smooth circulation of cold air keeps fridge-freezer temperature even.
- Do not open the door frequently. Opening the door lets warm air enter the fridge-freezer, and cause temperature to rise.

# OPERATIONS

## STARTING

When your refrigerator is first installed, allow it (7-8 hours) to stabilize at normal operating temperatures prior to filling it with fresh or frozen foods.

If operation is interrupted, wait 5 minutes before restarting.

## BEFORE SETTING THE TEMPERATURE

- The temperature of the refrigerator is kept constant regardless of changes in room temperature. It is recommended that, once set, the temperature settings (the controls for the refrigerator and freezer compartments) not be changed unless necessary.
- This refrigerator has one temperature control button for the refrigerator compartment and one temperature control dial for the freezer compartment.
- The default setting of the temperature control button for the refrigerator compartment is '3°C'.
- The default setting of the temperature control dial for the freezer compartment is '4'.
- This refrigerator has a temperature sensor in the refrigerator compartment. It will start and stop the compressor automatically as needed.

## DOOR ALARM

When the door of the refrigerator or the freezer is open for 1 minute, an alarm will sound three times. If the door remains open, the alarm will repeat every 30 seconds.

## LAMP AUTO OFF FEATURE

When the door is open for 7 minutes or longer, the lamp inside goes off automatically to save energy and prevent overheating. However, the alarm sound continues until the door is closed.

## SELF TEST

- Your refrigerator contains a built-in diagnostic capability. If it develops a malfunction in certain areas, it will display an error code to assist the repair technician. While an error code is displayed, other control and display functions will not operate.
- If an error code is displayed, contact a service center. Do not disconnect the power cord from the outlet.

## CONTROLS FOR FREEZER COMPARTMENT

- The higher number the control setting is, the lower the temperature of the freezer compartment becomes.
- Since the temperature of the refrigerator and freezer compartments is controlled with a fixed amount of cooled air, the refrigerator compartment will be warmer if the freezer compartment becomes colder.
- When the freezer compartment is not cold enough in winter, adjust the control for the freezer to High (4-7).

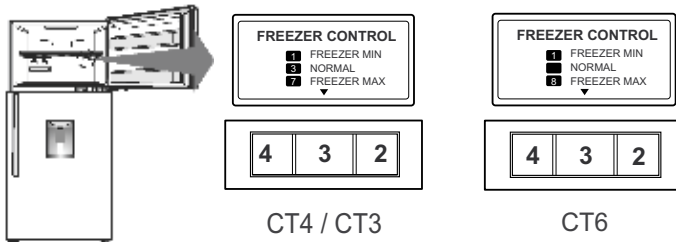

- Setting the Freezer Knob at   will satisfy 4 STAR. Setting the Freezer Knob at NORMAL will have sufficient freezing effect, so it is recommended to set the Knob at NORMAL.

# OPERATIONS

## CONTROLS FOR FREEZER COMPARTMENT

### ☐ FOR INTERNAL CONTROLLER MODEL

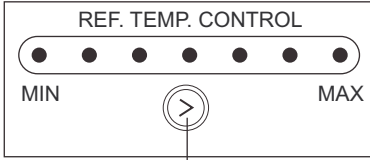

Ref. Temp Control Button

The default setting of the temperature control button for the refrigerator compartment is **NORMAL**.

To control the refrigerator temperature, press the **REF. TEMP CONTROL** button.

Whenever pressing the button, LED emitting the light. The temperature is set in 7 steps, from **MIN** to **MAX** cooling. (**MIN** = warmest, **MAX** = coldest temperature)

### ☐ FOR EXTERNAL CONTROLLER MODEL

Display graphic can be different, depend on the type of your refrigerator.

- Display



- Press 'REFRIGERATOR' button to control refrigerator temperature.
- Whenever pressing the button, the LED emits light.
- Press 'HEALTH GUARD/HYGIENE FRESH' button to operate hygiene fresh motor (optional).
- The number showing up on the LED luminesce indicate the temperature of refrigerator compartment.
- You can select the desired setting point seven steps, from '0°C' to '6°C'.
  - Display
    - Press (b) button, refrigerator temperature will be down each 1°C.
    - Press (a) button, 1) Hygiene fresh motor will be on. 2) power mode on. 3) off.

# OPERATIONS

## FAST FREEZING

- The FAST FREEZING feature operates when the refrigerator first turn on. The compressor and circulating fan operate at maximum cooling capacity to quickly lower the refrigerator temperature. It shuts off automatically.



- If warm food is placed into the refrigerator, FAST FREEZING can be started with the button on the control panel. FAST FREEZING will shut off when the temperature reaches the proper level or it can be shut off manually by pressing the FAST FREEZING button.

## CHILD LOCK (OPTIONAL)

- CHILD LOCK

Press and hold the child lock button for 3 seconds to lock the child lock. When it is locked, the Lock LED will be on and the other button will not operate. To unlock, press and hold the CHILD LOCK button for 3 seconds again.



## GREEN ION DOOR COOLING (OPTIONAL)

- The anion coating in the duct cover purifies the air and helps stored foods remain fresh longer.
- If water of foreign substances enter the cool air vent while cleaning, efficiency will be lowered. In addition, if gasket is damaged, efficiency may be lowered owing to the escape of cool air.

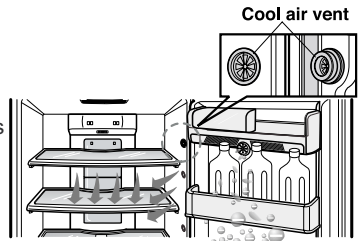

## Twisting Ice Serve Type

- To make ice cubes, fill the ice tray with water and insert in its position.
- To remove ice cubes, hold the lever of the tray and pull turn gently. Then, ice cubes drop in to the ice cube box.

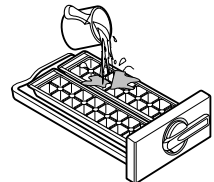
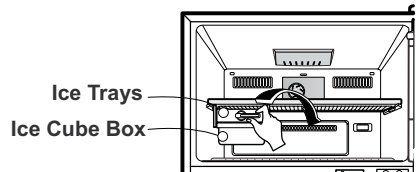

## WARNING

- Do not use anything other than water.
- Fill the water up to the marked line.

# OPERATIONS

## CONVERTIBLE CORNER

- When the door is opened, the warmer air can't influence in the fresh zone. So you can store food more fresh in it.
- Inserted convertible room must be placed at its position. If door is opened, it can't fill the role of it.

### How to use

- Vegetable Corner or Fresh Corner can be used through the control of knob.
- Check the position of knob prior to store the food.
- Do not locate the knob on the middle point.

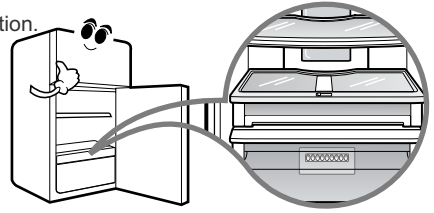

## VEGETABLE DRAWER

### Magic Crispers

- Magic Crispers provide fresher-tasting fruit and vegetables by letting you easily keep humidity inside the drawer.
- A lattice on the underside of the cover to efficiently hold or release moisture.
- Sealing structure keep the humidity.

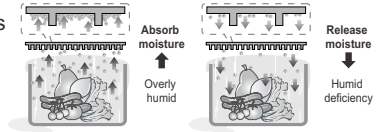

### Vegetable Partitioner(Optional)

- Fix the partitioner by inserting it at the rear side of vegetable box as shown in the figure.

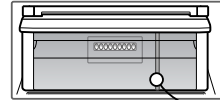

**Partitioner  
(Optional)**



# OPERATIONS

## WATER DISPENSER

### NOTE

- Pour water after the water tank is in position.
- Necessarily separate the water tank to clean it or when not in use
- When the water tank is not in position after filling it with water, water can leak out by the valve.

### • Pouring water in the water tank

1. Open the cover cap and pour water into the water tank.

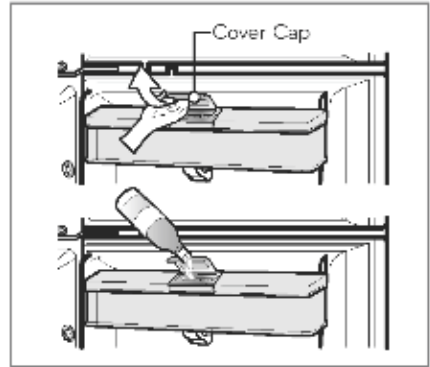

2. Close the cover cap.

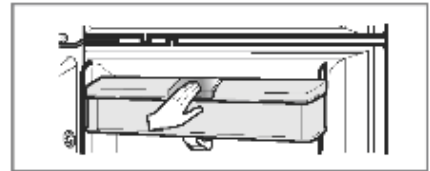

3. The water tank is optional removable part which can be applied to enlarge the storage capacity. You can use the upper basket after removing the water tank and closing the hole with a plug.

The plug is enclosed with the egg tray.

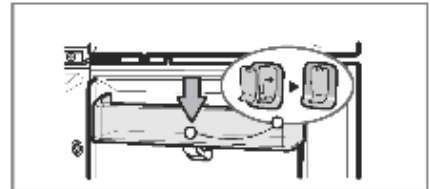

### Caution

Do not use anything other than water, even hot water needs to be cooled before being poured in to the water tank.  
Do not fill more than the indicated level .

### • Drinking Water

1. Press the dispenser pad with cup.
2. The water is released when the dispenser pad is pressed. The pad returns to its original position when the cup is removed and the water stops its flow.

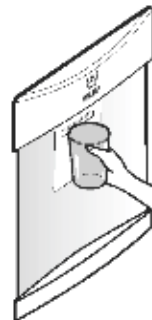

# OPERATIONS

## DEFROSTING

- Defrosting takes place automatically.
- The defrosted water flows down to the evaporating tray which is located in the lower back side of the refrigerator and is evaporated automatically.

## DEODORIZER (OPTIONAL)

- Unpleasant odor of food in fresh food compartment is deodorized with no harm to the user and the food.

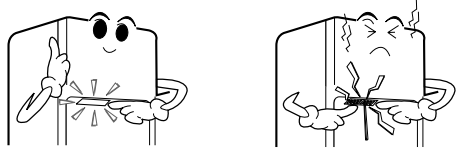

### How to use

- As Deodorizer is located in cooling air inlet for circulating air in fresh food compartment, there is no need for any handling.
- Do not prick the cooling air inlet with a sharp tip because Deodorizer may get damaged.
- When storing food with strong odor, wrap it or store it in a container with a lid because odor may be passed on to other foods.

### Re-Using of Deodorizer

- Deodorizer can be revived and re-used.
- Separate the Deodorizer from the refrigerator
- Use hair drier to remove moisture or malodor and oxidize under sunlight to decompose malodor by ultraviolet.

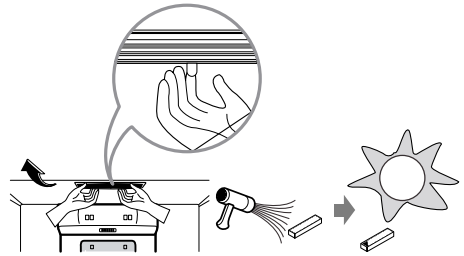

## DAIRY CORNER (OPTIONAL)

- Dairy corner cover can be moved right and left with the help of protruded handle.

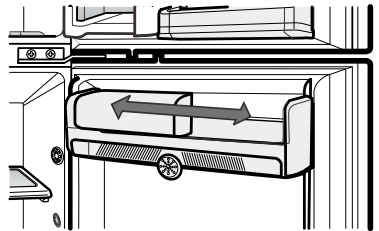

### How to remove the cover for cleaning

- Slide the cover to the center of basket and align the hole with both sides of the basket.
- After aligning, turn basket from back to front and pull out with both hands.

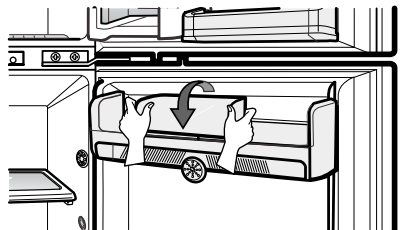

# SUGGESTIONS ON FOOD STORAGE

## STORING FOOD

- Store fresh food in the refrigerator compartment. How food is frozen and thawed is an important factor in maintaining its freshness and flavor.
- Do not store food which goes bad easily at low temperatures, such as bananas, pineapples, and melons.
- Allow hot food to cool prior to storing. Placing hot food in the refrigerator could spoil other food, and lead to higher electric bills!
- When storing the food, cover it with vinyl wrap or store in a container with a lid. This prevents moisture from evaporating, and helps food to keep its taste and nutrients.
- Do not block air vents with food. Smooth circulation of chilled air keeps refrigerator temperatures even.
- Do not open the door frequently. Opening the door lets warm air enter the refrigerator, and cause temperatures to rise.

## FREEZER COMPARTMENT

- Do not store bottles in the freezer compartment - they may break when frozen.
- Do not refreeze food that has been thawed. This causes loss of taste and nutrition.
- When storing frozen food like ice cream for a long period, place it on the freezer shelf, not in the door rack.
- Loading for Freezing - It is recommended to load newly introduced foods on the following position for freezing:

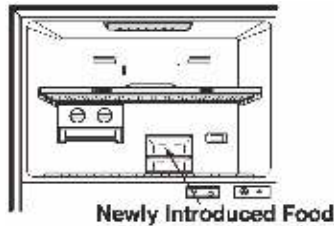

- Freezer Door Basket, marked (\*\*) is -12°C compartment, that is suitable for short term storage of frozen food (optional).

## REFRIGERATOR COMPARTMENT

- Avoid placing moist food on deep interior refrigerator shelves, it could freeze by direct contact with chilled air. To avoid this it is better to store food in the covered container.
- It is desirable to store moist food (especially vegetable and fruit) in the vegetable storage compartment. If it is necessary to store on a shelf of the refrigerator, put it close to the door away from the back wall of the refrigerator to avoid being frozen by direct contact with chilled air.
- Always clean food prior to refrigeration. Vegetables and fruits should be washed and wiped, and packed food should be wiped clean, to prevent adjacent food from spoiling.
- When storing eggs in their storage rack, ensure that they are fresh, and always store them in a upright position, which keeps them fresh for longer time.

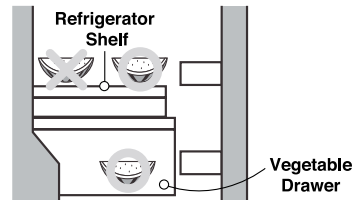

# CLEANING

It is important that your refrigerator is kept clean to prevent undesirable odors. Spilled food should be wiped immediately, since it may acidify and stain plastic surfaces if allowed to settle.

Never use metallic scouring pads, brushes, coarse abrasive cleaners or strong alkaline solutions on any surface.

Before you clean, remember that damp objects will stick or adhere to extremely cold surfaces. Do not touch frozen surfaces with wet or damp hands.

**EXTERIOR** - Use a lukewarm solution of mild soap or dish washable solution to clean the durable finish of your refrigerator. Wipe with a clean, damp cloth and then dry.

**INTERIOR** -Regular cleaning of the interior and interior parts is recommended. Use a lukewarm solution of mild soap or dish washable solution to clean the durable finish of your refrigerator. Wipe with a clean, damp cloth and then dry.

**INTERIOR PARTS** - Wash compartment shelves, door racks, storage trays and magnetic door seals etc. Use a lukewarm solution of mild soap or dish washable solution to clean the durable finish of your refrigerator. Wipe with a clean, damp cloth and then dry.

## WARNING

Always remove power cord from the wall outlet prior to cleaning. Wipe excess moisture with a sponge or cloth to prevent water or liquid from getting into any electrical part and causing electric shock. Do not use flammable or toxic cleaning liquids.

- Caution for Cleaning - Not to use : Surface active agent, Car wax, Anti-corrosive, All sorts of oil, Gasoline, Acids, Wax.
- Mild detergents, dish washable solutions and soapy water can be used
- Careless usage can lead to colour change.

## Caution

1. Use lukewarm water when cleaning.
2. Water Tank: Do not use anything other than water. If any other liquid is used, please rinse the tank three to four times with water.

# CLEANING

## WATER DISPENSER

### Grille -

Wipe with a clean, damp cloth and then dry using dry cloth.

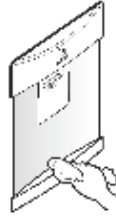

### Water Tank -

#### 1. Water Filling

It is not necessary to remove the water tank in order to fill it (it can be filled by opening the water tank cap).

**NOTE**

- Before closing door, close the cap and clamp tightly.
- Do not use liquids containing sugar or carbonated drinks.

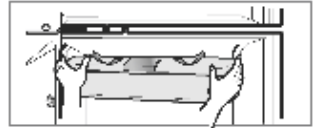

#### 2. Disassembly

Lift the water tank, gripping a side and bottom of water tank.

**NOTE**

Before disassembly of water tank, drain all water from the dispenser



#### 3. Assembly

If by some cause the water tank is dislocated, place it again at its original position. Verify that the valve is assembled correctly in the hole of the door. Once assembled push down and check the tank position with line.

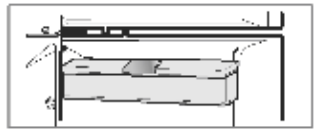

### Water Tank -

#### 1. Remove the tank cover.

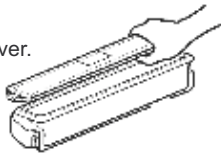

2. Clean the inside and outside of the water tank with dishwashing detergent and rinse thoroughly under running water. Dry the water with a cloth.

3. Clean the inside and outside of the cover and cap with dishwashing detergent and rinse thoroughly under running water. Dry the water with a cloth.

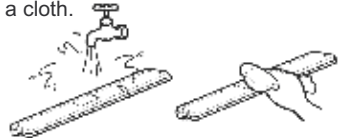

4. Assemble the cover with tank and clamp it with the help of snaps provided, further assemble it in refrigerator door

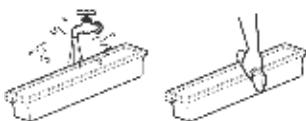

# GENERAL INFORMATION

## VACATION TIME

During average length vacations, you will probably find it best to leave the refrigerator in operation. Place freezable items in freezer for longer life. When you plan to be away for an extended period, remove all food, disconnect the power cord, clean the interior thoroughly, and leave each door OPEN to prevent odor formation.

## POWER FAILURE

Most power failures are corrected in an hour or two and will not affect your refrigerator temperatures. However, you should minimize the number of door openings while the power is off. During power failures of longer duration, place a block of dry ice on top of your frozen packages.

## IF YOU MOVE

Remove or securely fasten down all loose items inside the refrigerator. To avoid damaging the leveling screw(s), turn them all the way into the base.

## ANTI-CONDENSATION PIPE

The outside wall of the refrigerator cabinet may sometimes get warm, especially just after installation.

Don't be alarmed.

This is due to the anti-condensation pipe, which pumps hot refrigerant to prevent "sweating" on the outer cabinet wall.

Anti-Condensation Pipe

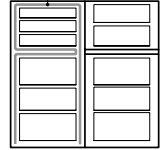

## Caution

### Electrical Shock Hazard

Before replacing a burned-out light bulb, either unplug the refrigerator or turn off power at the circuit breaker or fuse box.

**NOTE :** Moving the control to OFF position does not remove power from the light circuit.

# IMPORTANT WARNINGS

## DO NOT USE AN EXTENSION CORD

If possible, connect the refrigerator to its own individual electrical outlet to prevent it and other appliances or household lights from causing an overload that could cause a power outage.

## ACCESSIBILITY OF SUPPLY PLUG

The refrigerator-freezer should be in such a position that the supply plug is accessible for quick disconnection when an accident happens.

## SUPPLY CORD REPLACEMENT

If the supply cord is damaged, it must be replaced by the manufacturer or its service agent or a similarly qualified person in order to avoid a hazard.

## ABOUT GROUNDING (EARTHING)

In the event of an electric short circuit, grounding (earthing) reduces the risk of electric shock by providing an escape wire for the electric current.

In order to prevent possible electric shock, this appliance must be grounded.

Improper use of the grounding plug can result in an electric shock. Consult a qualified electrician or service person if the grounding instructions are not completely understood, or if you have doubts on whether the appliance is properly grounded.

## DO NOT MODIFY OR EXTEND THE POWER CORD LENGTH.

It will cause electric shock or fire.

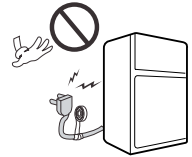

## VERY DANGEROUS ATTRACTION

An empty refrigerator can be a dangerous attraction to children. Remove either gaskets, latches, lids or the entire door from your unused appliance, or take some other action to make it harmless.

This appliance must be grounded (earthed).

**DON'T WAIT! DO IT NOW!**

**Do not store inflammable materials, explosives or chemicals in the refrigerator.**

## Disposal of the old appliance

This appliance contains fluid (refrigerant, lubricant) and is made of parts and materials which are reusable and/or recyclable.

All the important materials should be sent to the collection center of waste material and can be reused after rework (recycling). For take back, please contact with the local agency.

"This appliance is not intended for use by persons (including children) with reduced physical, sensory or mental capabilities, or lack of experience and knowledge, unless they have been given supervision or instruction concerning use of the appliance by a person responsible for their safety.

Children should be supervised to ensure that they do not play with the appliance."

# BEFORE CALLING FOR SERVICE

SERVICE CALLS CAN OFTEN BE AVOIDED!

IF YOU FEEL YOUR REFRIGERATOR IS NOT OPERATING PROPERLY, CHECK THESE POSSIBLE CAUSES FIRST :

PROBLEM	POSSIBLE CAUSES
REFRIGERATOR DOES NOT OPERATE	<ul style="list-style-type: none"><li>• Has a house fuse blown or circuit breaker tripped?</li><li>• Has the power cord plug been removed or loosened from the electrical wall outlet?</li></ul>
REFRIGERATOR OR FREEZER COMPARTMENT TEMPERATURE TOO WARM	<ul style="list-style-type: none"><li>• Temperature control not set on proper position.</li><li>• Appliance is placed close to wall or heat source.</li><li>• Warm weather-frequent door openings.</li><li>• Door left open for a long time.</li><li>• Large amount of foods are kept in the refrigerator.</li></ul>
ABNORMAL NOISE(S)	<ul style="list-style-type: none"><li>• Refrigerator is installed in a weak or uneven place, or leveling screw needs adjusting.</li><li>• Unnecessary objects placed in the back side of the refrigerator.</li></ul>
REFRIGERATOR HAS ODOR	<ul style="list-style-type: none"><li>• Foods with strong odors should be tightly covered or wrapped.</li><li>• Interior needs cleaning.</li></ul>
DEW FORMS ON THE CABINET SURFACE	<ul style="list-style-type: none"><li>• Not unusual during periods of high humidity.</li><li>• Door may have been left ajar.</li></ul>