



LG

Life's Good

ENGLISH

OWNER'S MANUAL MUSIC IN STYLE DOCKING SPEAKER

Please read this manual carefully before operating your set and retain it for future reference.

ND5520



MFL67562911

<http://www.lg.com>

Safety Information



CAUTION: TO REDUCE THE RISK OF ELECTRIC SHOCK DO NOT REMOVE COVER (OR BACK) NO USER-SERVICEABLE PARTS INSIDE REFER SERVICING TO QUALIFIED SERVICE PERSONNEL.



This lightning flash with arrowhead symbol within an equilateral triangle is intended to alert the user to the presence of uninsulated dangerous voltage within the product's enclosure that may be of sufficient magnitude to constitute a risk of electric shock to persons.



The exclamation point within an equilateral triangle is intended to alert the user to the presence of important operating and maintenance (servicing) instructions in the literature accompanying the product.

WARNING: TO PREVENT FIRE OR ELECTRIC SHOCK HAZARD, DO NOT EXPOSE THIS PRODUCT TO RAIN OR MOISTURE.

WARNING: Do not install this equipment in a confined space such as a book case or similar unit.

NOTICE: For safety marking information including product identification and supply ratings, please refer to the main label on the bottom of the apparatus.

CAUTION concerning the Power Cord

Most appliances recommend they be placed upon a dedicated circuit;

That is, a single outlet circuit which powers only that appliance and has no additional outlets or branch circuits. Check the specification page of this owner's manual to be certain. Do not overload wall outlets. Overloaded wall outlets, loose or damaged wall outlets, extension cords, frayed power cords, or damaged or cracked wire insulation are dangerous. Any of these conditions could result in electric shock or fire. Periodically examine the cord of your appliance, and if its appearance indicates damage or deterioration, unplug it, discontinue use of the appliance, and have the cord replaced with an exact replacement part by an authorized service center. Protect the power cord from physical or mechanical abuse, such as being twisted, kinked, pinched, closed in a door, or walked upon. Pay particular attention to plugs, wall outlets, and the point where the cord exits the appliance. To disconnect power from the mains, pull out the mains cord plug. When installing the product, ensure that the plug is easily accessible.

This device is equipped with a portable battery or accumulator.

Safety way to remove the battery or the battery from the equipment: Remove the old battery or battery pack, follow the steps in reverse order than the assembly. To prevent contamination of the environment and bring on possible threat to human and animal health, the old battery or the battery put it in the appropriate container at designated collection points. Do not dispose of batteries or battery together with other waste. It is recommended that you use local, free reimbursement systems batteries and accumulators. The battery shall not be exposed to excessive heat such as sunshine, fire or the like.

CAUTION: The apparatus shall not be exposed to water (dripping or splashing) and no objects filled with liquids, such as vases, shall be placed on the apparatus.

Table of Contents

1 Getting Started

- 2 Safety Information
- 4 Main Features
 - 4 – Made for iPod/iPhone/iPad
 - 4 – Portable In
 - 4 – USB Playback
 - 4 – Alarm
 - 4 – Radio (FM)
 - 4 – Time Sync
 - 4 – LG Bluetooth Remote
- 4 Accessories
- 4 Introduction
 - 4 – Symbol Used in This Manual
- 5 Playable File Requirement
 - 5 – MP3/WMA Music File Requirement
 - 5 – Compatible USB Devices
 - 5 – USB Device Requirement
- 6 Remote Control
- 7 Front Panel
- 7 Back Panel
- 7 Top Panel
- 8 Control Panel
- 9 Connecting the AC Adapter
- 9 Setting the Clock
 - 9 – Setting the Clock Automatically
 - 10 – Setting the Clock Manually

2 Operating

- 11 Basic Operations
 - 11 – iPod/iPhone/iPad Operation
 - 11 – Compatible iPod/iPhone/iPad
 - 12 – USB Operation
 - 13 – Listening to Music from Your External Device
 - 13 – How to Affix the Ferrite Core
- 14 Radio Operations
 - 14 – Antenna Connection
 - 14 – Listening to the Radio
 - 14 – Presetting the Radio Stations
 - 14 – Deleting All the Saved Stations
 - 14 – Improving Poor FM Reception
- 15 Using a Bluetooth Wireless Technology
 - 15 – Listening to Music of a Bluetooth Device
 - 16 – Using Bluetooth App
- 18 Other Operations
 - 18 – Using Your Unit as an Alarm Clock
 - 18 – Activate and Deactivate the Alarm Timer
 - 18 – Stop Alarm Ring
 - 18 – Snoozing
 - 18 – Resume Playback
 - 18 – Playing Repeatedly or Randomly
 - 19 – Dimmer
 - 19 – Sleep Timer Setting
 - 19 – Setting the Sound Mode
 - 19 – Turning off the Sound Temporarily
 - 19 – Charging Your Android Phone

3 Troubleshooting

- 20 Troubleshooting

4 Appendix

- 21 Trademarks and Licenses
- 21 Handling the Unit
- 22 Specifications

Main Features

Made for iPod/iPhone/iPad

Enjoys music from iPod/iPhone/iPad with simple connection.

Portable In

Listens to music from your portable device.

USB Playback

Enjoys music from USB with simple connection.

Alarm

Sets alarm which go off at desired time.

Radio (FM)

Listens to the radio.

Time Sync

Sets this unit's clock automatically by connecting iPod/iPhone/iPad or by activating Bluetooth connection through "LG Bluetooth Remote" app.

LG Bluetooth Remote

You can control this unit with your iPod touch/iPhone/iPad or Android device via Bluetooth. This unit and your device must be paired for Bluetooth. Visit "Apple App Store" or "Google Android Market (Google Play Store)" or use the QR code shown below to search for "LG Bluetooth Remote" app. For detailed information, refer to page 16-17.



(Android OS)



(Apple iOS)

Accessories

Please check and identify the supplied accessories.

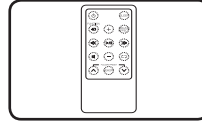

Remote control (1)

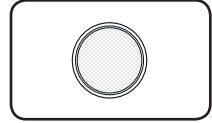

Battery (1)

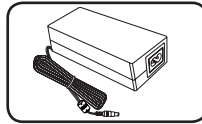

AC adapter (1)

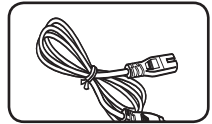

Power cord (1)

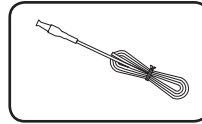

FM antenna (1)

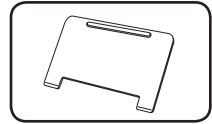

Stand for iPad (1)

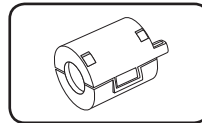

Ferrite Core (1)

Introduction

Symbol Used in This Manual

! Note

Indicates special notes and operating features.

⚠ Caution

Indicates cautions for preventing possible damages from abuse.

Playable File Requirement

MP3/WMA Music File Requirement

MP3/WMA file compatibility with this unit is limited as follows :

- Sampling frequency : within 32 to 48 kHz (MP3), within 32 to 48 kHz (WMA)
- Bit rate : within 32 to 320 kbps (MP3), 40 to 192 kbps (WMA)
- Maximum files : Under 999
- File extensions : “.mp3”/“.wma”

Compatible USB Devices

- MP3 Player : Flash type MP3 player.
- USB Flash Drive :
Devices that support USB1.1.
- The USB function of this unit does not support all USB devices.

USB Device Requirement

- Devices which require additional program installation when you have connected it to a computer, are not supported.
- Do not extract the USB device while in operation.
- For a large capacity USB, it may take longer than a few minutes to be searched.
- To prevent data loss, back up all data.
- If you use a USB extension cable or USB hub, the USB device is not recognized.
- Using NTFS file system is not supported. (Only FAT(16/ 32) file system is supported.)
- This unit is not supported when the total number of files is 1 000 or more.
- External HDD, Card readers, Locked devices, or hard type USB devices, mobile phone are not supported.
- USB port of the unit cannot be connected to PC. The unit cannot be used as a storage device.
- Some USB may not work with this unit.
- This unit can charge iPod/iPhone by connecting it to USB port in power on.
- This unit cannot charge iPad by connecting it to USB port even in power on.
- When you connect smart phone by using USB port, you can only charge it in power on. (Some smart phone may not be charged.)

Remote Control

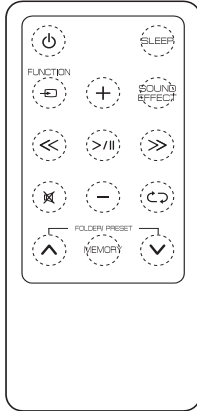

POWER : Switches the unit ON or OFF.

SLEEP : Sets the sleep timer.

FUNCTION : Selects the function and input source.

+/- (Volume) : Adjusts speaker volume.

SOUND EFFECT : Chooses sound impressions.

<</>> (Skip/Search) :

- Skips Fast backward or Forward.
- Searches for a section within a file.

>/II (Play/Pause) : Starts or pauses playback.

MUTE : Mutes the sound.

REPEAT : Selects a play mode. (ONE/DIR/ALL/RAND(RANDOM)/OFF)

FOLDER/PRESET ^/V :

- Selects the folder or file you want to play.
- Chooses a preset number for a radio station.

MEMORY :

- Stores the preset stations.
- Deletes the preset stations.

! Caution

The battery used in this device may present a fire or chemical burn hazard if mistreated. Do not recharge, disassemble, incinerate, or heat above 100 °C (212 °F). Replace the battery part no. CR2025 only. Use of another battery may present a risk of fire or explosion. Dispose of used battery. Keep battery away from children. Do not disassemble or dispose of in fire.

Battery Installation

1. Turn the battery compartment lid counterclockwise by using a coin. Then take the battery compartment lid out.

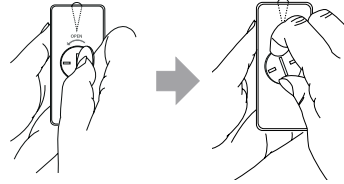

2. Insert and fix the battery with the plus(+) facing in the same direction as the plus(+) on the battery compartment lid.

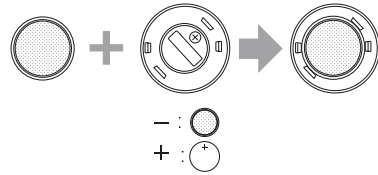

3. Put the battery compartment lid on the remote control and turn it clockwise to close.

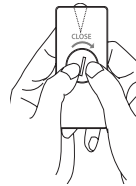

! Caution

Do not open the battery compartment lid by using your finger. Or else, your nail would be broken.

Front Panel

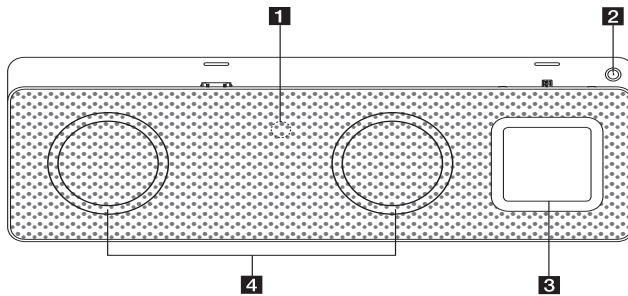

- 1 Remote Sensor**
- 2**  Switches the unit ON or OFF.
- 3 Control panel**
- 4 Speaker**

Back Panel

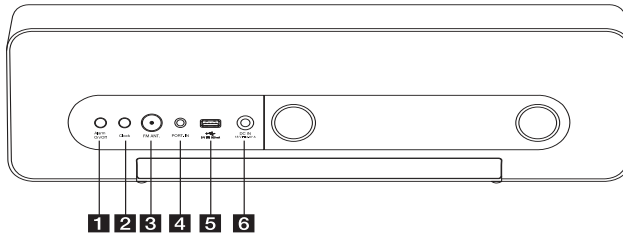

- 1 Alarm On/Off**
 - Sets the alarm timer.
 - Turns off the alarm.
 - Displays alarm setting.
- 2 Clock**
Sets the clock and checks the time.
- 3 FM ANT.**
- 4 PORT.IN (3.5 mm)**
Listens to music from your portable device.
- 5 USB Port**
Plays music file by connecting the USB device.
- 6 DC IN 18 V $\overline{\text{---}}$ 2.67 A** (AC adapter input)

Top Panel

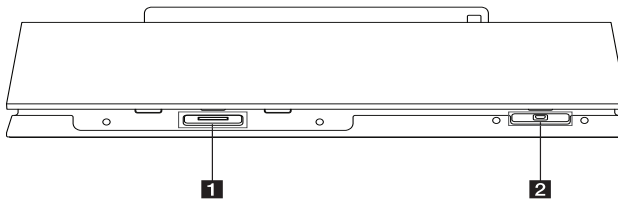

- 1 iPod/iPhone/iPad Dock**
Connects an iPod/iPhone/iPad.
- 2 Android phone Dock (Micro USB)**
Connects an Android phone.

Control Panel

- **Switch function :**

Taps  or swipes left or right with your finger.
Selects the function and input source.
(IPOD/BT(Bluetooth)/PORT/FM/USB)

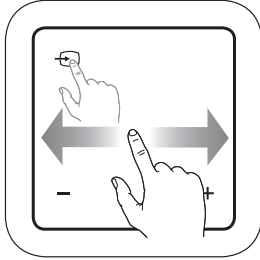

- **Play/Pause :**

Taps the center position to play back or pause.

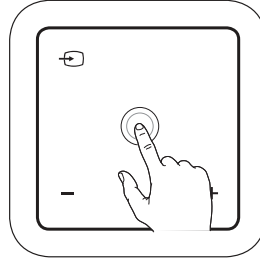

- **Skip/Search :**

- Skips Fast backward or Forward.
- Searches for a section within a file.

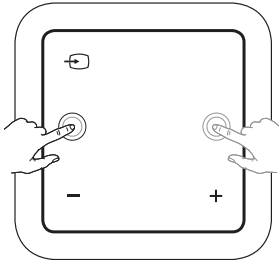

- **-/+ (Volume) :**

Adjusts speaker volume.

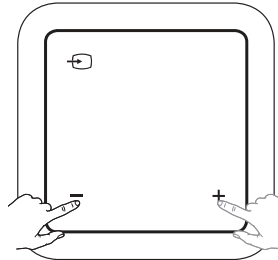

- **Up/Down :**

- Selects the folder or file you want to play.
- Chooses a preset number for a radio station.

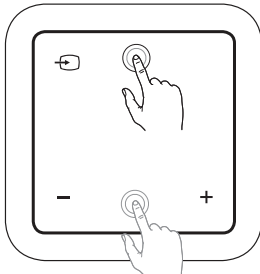

Connecting the AC Adapter

1. Connect the supplied AC power cord to the AC adapter.
2. Connect the AC adapter cable to DC IN adapter input.
3. Plug the AC power cord into an AC outlet. Then the unit goes into standby mode.

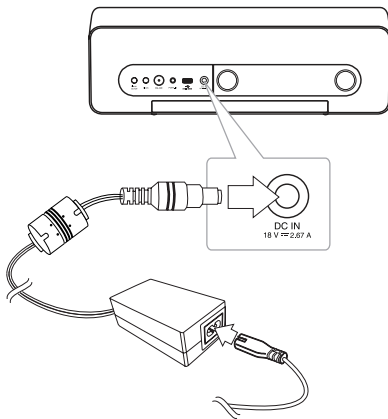

Caution

Only use the AC adapter supplied with this device. Do not use a power supply from another device or manufacturer. Using any other power cable or power supply may cause damage to the device and void your warranty.

Setting the Clock

Note

If the power has been interrupted or the power plug has been disconnected, the clock setting is erased.

Setting the Clock Automatically

Note

- Make sure that your iPod/iPhone/iPad or your Android device has set the clock correctly.
- In standby mode, the clock will not synchronize with your iPod/iPhone/iPad or your Android device.
- In auto clock synchronization, "LG Bluetooth Remote" app has priority over the docking system.
- The 24 hour format can be set only for Android OS.

Setting the Clock by Synchronizing with Your iPod/iPhone/iPad

Connect the iPod/iPhone/iPad firmly. Then the clock setting in the control panel will synchronize with your iPod/iPhone/iPad.

Note

The synchronized time may be slightly different from that of your iPod/iPhone/iPad.

Setting the Clock through "LG Bluetooth Remote" App

Install "LG Bluetooth Remote" app on your iPod/iPhone/iPad or your Android device. (see page 16-17)

Your unit's clock will be automatically synchronized with your device by activating Bluetooth connection through "LG Bluetooth Remote" app.

Setting the Clock Manually

If necessary, you can set the clock manually.

1. Press and hold **Clock** on the back panel for two seconds.
 - The clock digits begin to blink.
2. Press **◀ / ▶** to select the 12/24 hour format.
 - 12:00 (for a PM display) or 0:00 (for a 24 hour display)
3. Press **>||**.
 - The hour digits begin to blink.
4. Press **◀ / ▶** to set the hour.
5. Press **>||**.
 - The minutes digits begin to blink.
6. Press **◀ / ▶** to set the minute.
7. Press **>||**.

Note

If you want to reset the clock, repeat steps 1-7.

Basic Operations

iPod/iPhone/iPad Operation

You can enjoy the sound from your iPod/iPhone/iPad through this unit. For details about iPod/iPhone/iPad, refer to the iPod/iPhone/iPad User Guide.

! Note

Install the supplied stand for iPad to keep iPad stable before you place the iPad.

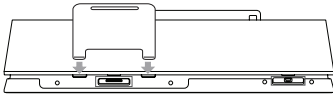

1. Connect the iPod/iPhone/iPad firmly. When this unit is connected to power, your iPod/iPhone/iPad is automatically turned on and starts recharging even in standby mode.

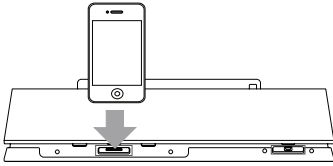

2. Press **FUNCTION** or **↔** to select IPOD function.

To	Do this
Play	Press >
Pause	During playback, Press >
Skip	During playback, press << / >> to go to the next file or to return to the beginning of the current file. During playback, press << twice briefly to step back to the previous file.

To	Do this
Search	Press and hold << / >> during playback and release it at the point you want to listen to.

Compatible iPod/iPhone/iPad

The unit supports the models as follows ;

- iPod touch 1G, 2G, 3G, 4G
- iPod nano 2G, 3G, 4G, 5G, 6G
- iPhone 3G / iPhone 3GS
- iPhone 4 / iPhone 4S
- iPad / iPad 2

! Note

- An error message "ERROR" appears when :
 - your iPod/iPhone/iPad is not connected firmly.
 - this unit recognizes your iPod/iPhone/iPad as an unknown device.
 - your iPod/iPhone/iPad is exceptionally low in power.
 - ➔ The battery needs to be charged.
 - ➔ If you charge the battery while iPod/iPhone/iPad is extremely low in power, it may take longer to be charged.
- You may not control your iPod/iPhone/iPad from this unit due to malfunction of iPod/iPhone/iPad.
- Depending on your iPod/iPhone/iPad's software version, it may not be possible to control your iPod/iPhone/iPad from this unit. We recommend installing the latest software version.
- If you use an application, make a call, or send and receive SMS text message, etc. on iPod touch/iPhone/iPad, disconnect it from iPod/iPhone/iPad dock of this unit and then use it.
- If you have a problem with your iPod/iPhone/iPad, please visit www.apple.com/support.
- iPod touch, iPhone and iPad have any difference in operation other than iPod. You may need any additional control to use them with this unit. (e.g. "slide to unlock")

USB Operation

1. Connect the USB device to the USB port.
2. Select the USB function by pressing **FUNCTION** or **↶**.

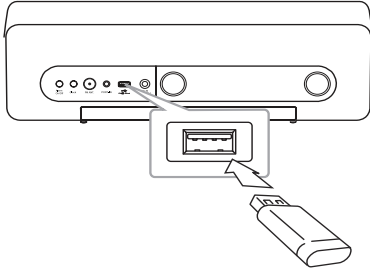

Note

Removing the USB Device from the unit.

1. Choose a different function/mode.
2. Remove the USB device from the unit.

To	Do this
Play	Press >
Pause	During playback, press >
Skip	During playback, press <</>> to go to the next file or to return to the beginning of the current file. During playback, press << twice briefly to step back to the previous file.
Search	Press and hold <</>> during playback and release it at the point you want to listen to.

Note

- During playback, if you change to another function, then return to the USB function, and then press **>||**, you can listen to music from last point you played.
- The playing time is displayed until 59 minutes and 59 seconds.
- USB Folders/Files are recognized as below.

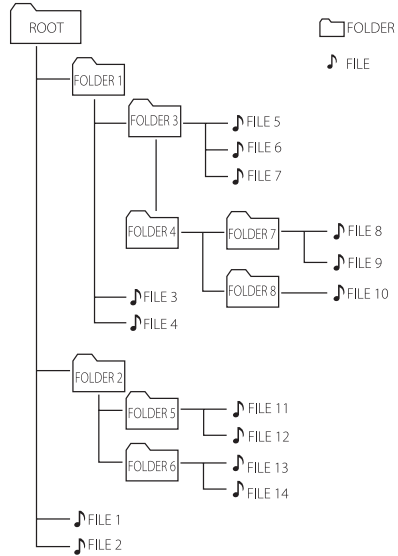



- If there is no file in a folder, the folder will not appear.
- Folders will be presented as the following order; ROOT → FOLDER 1 → FOLDER 3 → FOLDER 7 → FOLDER 8 → FOLDER 5 → FOLDER 6
- File will be played from **FILE No.1** to **FILE No.14** one by one.
- Files and folders will be presented in order recorded and may be presented differently according to the record circumstances.
- *ROOT : The first screen you can see when a computer recognize the USB is "ROOT".

Listening to Music from Your External Device

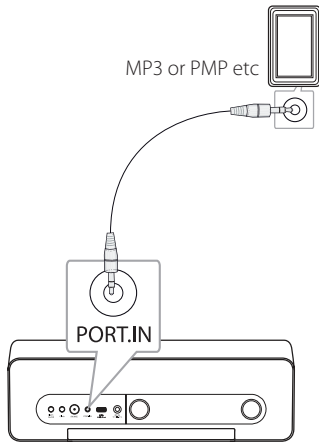
The unit can be used to play the music from many types of external device. (Portable cable is not supplied as an accessory with this unit.)



1. Connect the external device to the **PORT.IN** connector of the unit.
2. Turn the power on by pressing .
3. Select the PORT (PORTABLE) function by pressing  **FUNCTION** or .
4. Turn the external device on and start playing it.

How to Affix the Ferrite Core

You must affix a core (supplied with the model you purchased) in order to reduce or eliminate electrical interference.

1. Pull the stopper [a] of the ferrite core to open.
2. Wind the portable cable and FM antenna around the ferrite core once.
3. Close the ferrite core until it clicks.

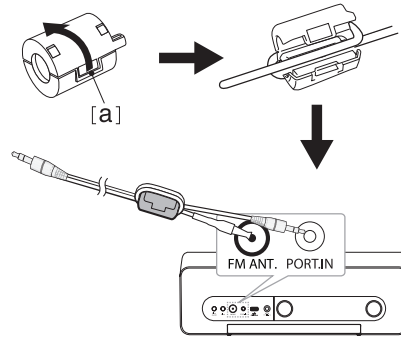

Radio Operations

Antenna Connection

Connect the FM wire antenna to FM antenna connector.

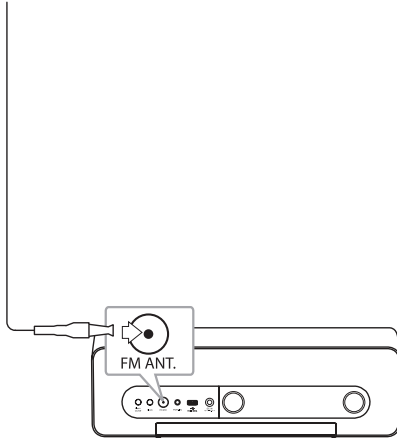

Listening to the Radio

1. Press **FUNCTION** or repeatedly until FM appears in the control panel. The last received station is tuned in.
2. Auto tuning : Press **<</>>** for about 2 seconds until the frequency indication starts changing, then release. Scanning stops when the unit tunes in a station.
Manual tuning : Press **<</>>** repeatedly.
3. Adjust the volume by pressing **-/+** (Volume).

Presetting the Radio Stations

You can store up to 10 FM preset stations.

Before tuning, make sure that you have turned down the volume.

1. Press **FUNCTION** or repeatedly until FM appears in the control panel.
2. Select the desired frequency by using **<</>>**.
3. Press **MEMORY**. A preset number will blink in the control panel.
4. Press **FOLDER/PRESET ^/V** to select the preset number you want.
5. Press **MEMORY**. The station is stored.
6. Repeat the steps 2 to 5 to store other stations.

Press **FOLDER/PRESET ^/V** to select a preset station.

Deleting All the Saved Stations

Press and hold **MEMORY** for two seconds. "CLR" will flash up. Press **MEMORY** again. Then all the saved stations are deleted.

Improving Poor FM Reception

Press **>||**. This will change the tuner from stereo to mono and usually improve the reception.

! Note

- If all stations have already been preset, "FULL" will appear in the control panel for a moment and then a preset number will blink.
- Although all stations were preset, you can preset a station by overwriting the previous station.
- You can not delete the preset stations one by one.

Using a Bluetooth Wireless Technology

About Bluetooth

Bluetooth® is wireless communication technology for short range connection.

The available range is within 10 meters.

(The sound may be interrupted when the connection interfered by the other electronic wave or you connect the bluetooth in the other rooms.) Connecting individual devices under Bluetooth® wireless technology does not incur any charges. A mobile phone with Bluetooth® wireless technology can be operated via the Cascade if the connection was made via Bluetooth® wireless technology. Available Devices : Mobile phone, MP3, Laptop, PDA.



Bluetooth Profiles

In order to use Bluetooth wireless technology, devices must be able to interpret certain profiles. This unit is compatible with following profile.

A2DP (Advanced Audio Distribution Profile)

Listening to Music of a Bluetooth Device

Before you start the pairing procedure, make sure the Bluetooth feature is turned on in to your Bluetooth device. Refer to your Bluetooth device's user guide. Once a pairing operation is performed, it does not need to be performed again.

1. Select the Bluetooth function by using the  **FUNCTION** or . Appears "BT" and "BT READY" in the control panel.
2. Operate the Bluetooth device and perform the pairing operation. When searching for this unit with the Bluetooth device, a list of the devices found may appear in the Bluetooth device display depending on the type of Bluetooth device. Your unit appears as "LG AUDIO ND5520".
3. Enter the PIN code.
PIN code : 0000
4. When this unit successfully is connected with your Bluetooth device, Bluetooth LED of this unit lights up and "PAIR" appears in the control panel.

Note

Depending on the Bluetooth device type, some device have a different pairing way.

5. Listen to music.
To play a music stored on your Bluetooth device, refer to your Bluetooth device's user guide.

Note

- The sound may be interrupted when the connection interfered by the other electronic wave.
- You cannot control the Bluetooth device with this unit.
- Pairing is limited one Bluetooth device per one unit and multi-pairing is not supported.
- Although the distance between your Bluetooth and the set is less than 10m, there are obstacles between both, your Bluetooth device cannot be connected.
- Depending on the type of the device, you may not be able to use the Bluetooth function.
- When not connected the Bluetooth, "BT" and "BT READY" appears on the control panel.
- The electrical malfunction due to devices using same frequency such as Medical equipment, Microwaves or wireless LAN devices, the connection will be disconnected.
- When someone stands and interrupts communication between Bluetooth device and the player, the connection will be disconnected.
- If the gotten away of the distance between Bluetooth and the unit, the sound quality is lower and lower. The connection will disconnect when the space between the Bluetooth and the unit gets out of the operating range of Bluetooth.
- The device with Bluetooth wireless technology is disconnected, if you turn off the main unit or put the device away from the main unit more than 10m.
- If the Bluetooth device is disconnected, you should connect the Bluetooth device to your unit.

Using Bluetooth App**About "LG Bluetooth Remote" App**

"LG Bluetooth Remote" app brings a suite of new features to this unit.

To enjoy more features, you are recommended to download and install free "LG Bluetooth Remote" app.

Install "LG Bluetooth Remote" App onto Your Bluetooth Device

1. Install "LG Bluetooth Remote" app through QR code. Use the scanning software to scan the QR code.



(Android OS)



(Apple iOS)

2. Tap an icon for installation.
3. Tap an icon for downloading.

Note

- Make sure that your Bluetooth device is connected to the Internet.
- Make sure that your Bluetooth device has a scanning software application. If you don't have one, download one from "Apple App Store" or "Google Android Market (Google Play Store)".

Install “LG Bluetooth Remote” App by Docking Your iPod/iPhone/iPad onto This Unit

1. Connect your iPod/iPhone/iPad to iPod/iPhone/iPad Dock. The display for downloading “LG Bluetooth Remote” will be linked automatically (Apple iOS only).
2. Tap an icon for installation.
3. Tap an icon for downloading.

Install “LG Bluetooth Remote” App through “Apple App Store” or “Google Android Market (Google Play Store)”

1. Tap the “Apple App Store” icon or “Google Android Market (Google Play Store)” icon.
2. In the search bar, type in the “LG Bluetooth Remote” and search it.
3. In the search result list, find and tap “LG Bluetooth Remote” to start downloading Bluetooth app.
4. Tap an icon for installation.
5. Tap an icon for downloading.

! Note

- Make sure that your Bluetooth device is connected to the Internet.
- Make sure that your Bluetooth device is equipped with “Apple App Store” or “Google Android Market (Google Play Store)”.

Activate Bluetooth with “LG Bluetooth Remote” App

“LG Bluetooth Remote” app helps to connect your bluetooth device to this unit.

1. Tap “LG Bluetooth Remote” app icon on the home screen to open “LG Bluetooth Remote” app, and go to the main menu.
2. Tap [Setting] and select the unit you want.
3. If you want to get more information to operate, tap [Setting] and [Help].

! Note

- If you place your iPod/iPhone/iPad into the dock of this unit while your iPod/iPhone/iPad is connected to this unit by Bluetooth connection, the Bluetooth connection is deactivated.
- If this unit is BT mode and you connect your iPod/iPhone/iPad to this unit after connecting your iPod/iPhone/iPad to this unit by Bluetooth connection, the function is automatically switched to IPOD mode. Then if you disconnect your iPod/iPhone/iPad from this unit, it is automatically connected to this unit by Bluetooth connection.
- The Bluetooth connection of iPod/iPhone/iPad is not activated while iPod/iPhone/iPad is placed into the dock of this unit.
- This unit does not support the multi-pairing. If this unit is already connected with other Bluetooth device, disconnect that device and then try again.
- If you use “LG Bluetooth Remote” app for operation, there would be some differences between “LG Bluetooth Remote” app and the supplied remote control. Use the supplied remote control as necessary.
- Depending on the Bluetooth device, “LG Bluetooth Remote” app may not work.
- “LG Bluetooth Remote” app for Apple iOS is slightly different from that of Android OS.
- The connection you’ve made may be disconnected if you select other application or change the setting of the connected device via “LG Bluetooth Remote” app. In such a case, please check the connection status.

Other Operations

Using Your Unit as an Alarm Clock



1. Make sure that you have set the clock correctly. (See "Setting the Clock" on page 9-10.)
2. Press and hold **Alarm On/Off** on the back panel.
3. The alarm sound sources blink. (FM (Tuner)/USB/IPOD) While each of sound sources blinks, select the one you want by pressing **>||**. If you select FM (Tuner) mode, you can select the station you preset by pressing **<</>>**.
4. "ON (Time)" setting is displayed. The hour setting blinks. Press **<</>>** to select the hour and then press **>||** to save.
5. The minute setting blinks. Press **<</>>** to select the minute and then press **>||** to save.
6. The volume setting blinks. Press **<</>>** to change the volume and then press **>||** to save.

! Note

- Alarm function only works when this unit is turned off.
- You can check the setting status by pressing **Alarm On/Off** on the back panel two times.
- If you want to reset the alarm, repeat steps 2-6.

Activate and Deactivate the Alarm Timer

Press **Alarm On/Off** repeatedly on the back panel to activate or deactivate the timer.

- If the timer is activated, "" is displayed.
- If the timer is deactivated, "" is not displayed.

Stop Alarm Ring

- When the alarm rings, press **Alarm On/Off** on the back panel or press .
- The alarm stops but the alarm settings remain.

! Note

- If you don't set clock on your iPod/iPhone/iPad, the unit will not be synchronized for the clock with your iPod/iPhone/iPad.
- If you unplug the cord from an outlet, the alarm setting you set is not stored.
- After setting a clock function, you can set alarm function.
- If you do not press any button for 30 minutes after the alarm goes off, the alarm will shut off automatically.
- If you set the clock and alarm, you can check the time and alarm icon "" by pressing **Alarm On/Off** although the unit is standby mode.
- If the time you set is up, the unit will be turned on automatically.
- You can only set 12 hour format. (for a PM display)

Snoozing

The snoozing function wakes you up every 10 minutes if you tap anywhere on the control panel while the alarm activates.

"ZZZ" appears and "" blinks. To cancel the snoozing function, press **Alarm On/Off** or .

Resume Playback

The unit memorizes the point where you pressed **>||**. Press **>||** to resume playback.

Playing Repeatedly or Randomly

Press  repeatedly. Then the current file will be played back repeatedly or randomly. (ONE/DIR/ALL/RAND(RANDOM)/OFF)

Dimmer

Press **SLEEP** once. The control panel will be darkened by half. To cancel it, press **SLEEP** repeatedly until the control panel get bright.

Sleep Timer Setting

While listening to music or radio, press **SLEEP** repeatedly to select delay time between 10 and 180 minutes. After delay time, the unit will turn off. (You can see the following order, 180 -> 150 -> 120 -> 90 -> 80 -> 70 -> 60 -> 50 -> 40 -> 30 -> 20 -> 10)

To cancel the sleep function, press **SLEEP** repeatedly until the control panel get bright.

! Note

- You can check the remaining time before the unit turns off by pressing **SLEEP**.
- Sleep function will work after dimmer function.

Setting the Sound Mode

This system has a number of pre-set sound fields. You can select a desired sound mode by using **SOUND EFFECT**.

The displayed items for the equalizer may be different depending on sound sources and effects.

On Display	Description
POP CLASSIC JAZZ ROCK	This program lends an enthusiastic atmosphere to the sound, giving you the feeling you are at an actual rock pop, jazz or classic concert.
BYPASS	You can enjoy the sound without equalizer effect.

! Note

Maybe you need to reset the sound mode, after switching the input, sometimes even after the sound file is changed.

Turning off the Sound Temporarily

Press **MUTE** to mute the sound. You can mute the sound in order, for example, to answer the telephone. And "MUTE" will appear in the control panel. To cancel mute function, press **MUTE** again or adjust volume level by pressing +/- (Volume).

Charging Your Android Phone

! Note

- By docking your Android phone, this unit can only charge it.
- You can enjoy music from your Android device via Bluetooth.

To charge your Android phone, you need to connect it in the dock for Android phone.

1. Check the orientation of the micro USB connector on your Android phone.

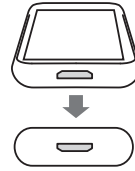

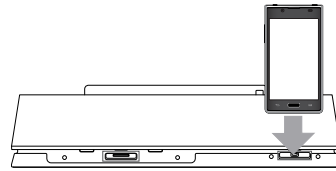

2. Connect your Android phone in the dock for Android phone.



! Note

- Only Android Phone can be charged and its charging time may vary depending on your Android Phone.
- Some Android Phone may not be charged.
- Depending on the position and orientation of the micro USB connector on your Android phone, connect it in portrait or landscape position.

Troubleshooting

Problem	Cause & Correction
No Power.	<ul style="list-style-type: none"> • Plug in the power cord. • Check the condition by operating other electronic devices.
No sound.	<ul style="list-style-type: none"> • Press  FUNCTION or  and check the selected function. • Adjust the volume. • Check that the sound of the unit is muted.
Radio stations cannot be tuned in properly.	<ul style="list-style-type: none"> • Adjust its position. • Tune to the station manually. • Preset some radio stations, see page 14 for details.
iPod/iPhone/iPad does not work.	Connect iPod/iPhone/iPad to the unit correctly.
Clock does not displayed.	<ul style="list-style-type: none"> • Power has been interrupted or the power plug has been disconnected. • Reset the clock (see page 9-10).
The control panel is not bright.	Check that the dimmer function is activated.
The remote control does not work properly.	There is an obstacle in the path of the remote control and the unit.

Trademarks and Licenses



"Made for iPod," "Made for iPhone," and "Made for iPad" mean that an electronic accessory has been designed to connect specifically to iPod, iPhone, or iPad, respectively, and has been certified by the developer to meet Apple performance standards. Apple is not responsible for the operation of this device or its compliance with safety and regulatory standards. Please note that the use of this accessory with iPod, iPhone, or iPad may affect wireless performance.



Bluetooth® wireless technology is a system which allows radio contact between electronic devices within a max. range of 10 meters.

Connecting individual devices under Bluetooth® wireless technology does not incur any charges. A mobile phone with Bluetooth® wireless technology can be operated via the Cascade if the connection was made via Bluetooth® wireless technology.

The Bluetooth® word mark and logos are owned by the Bluetooth® SIG, Inc. and any use of such marks by LG Electronics is under license.

Other trademarks and trade names are those of their respective owners.

Handling the Unit

When Shipping the Unit

Please save the original shipping carton and packing materials. If you need to ship the unit, for maximum protection, re-pack the unit as it was originally packed at the factory.

Keeping the Exterior Surfaces Clean

Do not use volatile liquids such as insecticide spray near the unit.



Wiping with strong pressure may damage the surface.

Do not leave rubber or plastic products in contact with the unit for a long period of time.

Cleaning the Unit

To clean the player, use a soft, dry cloth. If the surfaces are extremely dirty, use a soft cloth lightly moistened with a mild detergent solution. Do not use strong solvents such as alcohol, benzene, or thinner, as these might damage the surface of the unit.

Specifications

General	
AC adapter requirements	DC 18 V  2.67 A, 100 - 240 V, 50/60 Hz
Power consumption	48 W
Dimensions (W x H x D)	(436 x 152 x 115) mm
Net Weight (Approx.)	2.3 kg
Operating temperature	5 °C to 35 °C (41 °F to 95 °F)
Operating humidity	5 % to 90 %
USB/Micro USB	5 V  500 mA
iPod/iPhone/iPad	5 V  2.1 A

Inputs	
PORT. IN	0.5 Vrms (3.5 mm stereo jack)

Tuner	
FM Tuning Range	87.5 MHz to 108.0 MHz or 87.50 MHz to 108.00 MHz

Amplifier	
Output Power	15 W X 2 ch (8 Ω at 1 kHz)
T.H.D	10 %

Speakers	
Type	built-in
Impedance Rated	8 Ω
Rated Input Power	15 W
Max Input Power	30 W

- Design and specifications are subject to change without notice.

