



LG

Life's Good

OWNER'S MANUAL

Digital & Analog DVD recorder/VCR player combi

Please read this manual carefully before operating
your set and retain it for future reference.

RC689D

P/NO : MFL65225520

www.lg.com



Safety Information



CAUTION
RISK OF ELECTRIC SHOCK
DO NOT OPEN



CAUTION: TO REDUCE THE RISK OF ELECTRIC SHOCK DO NOT REMOVE COVER (OR BACK) NO USER-SERVICEABLE PARTS INSIDE REFER SERVICING TO QUALIFIED SERVICE PERSONNEL.



This lightning flash with arrowhead symbol within an equilateral triangle is intended to alert the user to the presence of uninsulated dangerous voltage within the product's enclosure that may be of sufficient magnitude to constitute a risk of electric shock to persons.



The exclamation point within an equilateral triangle is intended to alert the user to the presence of important operating and maintenance (servicing) instructions in the literature accompanying the product.

WARNING: TO PREVENT FIRE OR ELECTRIC SHOCK HAZARD, DO NOT EXPOSE THIS PRODUCT TO RAIN OR MOISTURE.

WARNING: Do not install this equipment in a confined space such as a book case or similar unit.

CAUTION: Do not block any ventilation openings. Install in accordance with the manufacturer's instructions.

Slots and openings in the cabinet are provided for ventilation and to ensure reliable operation of the product and to protect it from over heating. The openings shall be never be blocked by placing the product on a bed, sofa, rug or other similar surface. This product shall not be placed in a built-in installation such as a bookcase or rack unless proper ventilation is provided or the manufacturer's instruction has been adhered to.

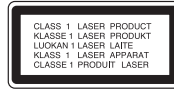

CAUTION: This product employs a Laser System. To ensure proper use of this product, please read this owner's manual carefully and retain it for future reference. Shall the unit require maintenance, contact an authorized service center. Use of controls, adjustments or the performance of procedures other than those specified herein may result in hazardous radiation exposure. To prevent direct exposure to laser beam, do not try to open the enclosure. Visible laser radiation when open. DO NOT STARE INTO BEAM.

CAUTION concerning the Power Cord

Most appliances recommend they be placed upon a dedicated circuit;

That is, a single outlet circuit which powers only that appliance and has no additional outlets or branch circuits. Check the specification page of this owner's manual to be certain. Do not overload wall outlets. Overloaded wall outlets, loose or damaged wall outlets, extension cords, frayed power cords, or damaged or cracked wire insulation are dangerous. Any of these conditions could result in electric shock or fire. Periodically examine the cord of your appliance, and if its appearance indicates damage or deterioration, unplug it, discontinue use of the appliance, and have the cord replaced with an exact replacement part by an authorized service center. Protect the power cord from physical or mechanical abuse, such as being twisted, kinked, pinched, closed in a door, or walked upon. Pay particular attention to plugs, wall outlets, and the point where the cord exits the appliance. To disconnect power from the mains, pull out the mains cord plug. When installing the product, ensure that the plug is easily accessible.

This device is equipped with a portable battery or accumulator.

Safety way to remove the battery or the battery from the equipment: Remove the old battery or battery pack, follow the steps in reverse order than the assembly. To prevent contamination of the environment and bring on possible threat to human and animal health, the old battery or the battery put it in the appropriate container at designated collection points. Do not dispose of batteries or battery together with other waste. It is recommended that you use local, free reimbursement systems batteries and accumulators. The battery shall not be exposed to excessive heat such as sunshine, fire or the direct sun light.

CAUTION: The apparatus shall not be exposed to water (dripping or splashing) and no objects filled with liquids, such as vases, shall be placed on the apparatus.

- The appliance is not intended for use by young children or infirm persons without supervision.
- Young Children should be supervised to ensure that they do not play with appliance.
- If the appliance is supplied from a cord extension set or an electrical portable outlet device, the cord extension set on electrical portable outlet device must be positioned so that it is not subject to splashing or ingress of moisture.

Notes on Copyrights

- Recording equipment should be used only for lawful copying and you are advised to check carefully what is lawful copying in the area in which you are making a copy. Copying of copyright material such as films or music is unlawful unless permitted by a legal exception or consented to by the rights owner.
- This product incorporates copyright protection technology that is protected by U.S. patents and other intellectual property rights. Use of this copyright protection technology must be authorized by Rovi Corporation, and is intended for home and other limited viewing uses only unless otherwise authorized by Rovi Corporation. Reverse engineering or disassembly is prohibited.
- CONSUMERS SHOULD NOTE THAT NOT ALL HIGH DEFINITION TELEVISION SETS ARE FULLY COMPATIBLE WITH THIS PRODUCT AND MAY CAUSE ARTIFACTS TO BE DISPLAYED IN THE PICTURE. IN CASE OF 625 PROGRESSIVE SCAN PICTURE PROBLEMS, IT IS RECOMMENDED THAT THE USER SWITCH THE CONNECTION TO THE 'STANDARD DEFINITION' OUTPUT. IF THERE ARE QUESTIONS REGARDING OUR TV SET COMPATIBILITY WITH THIS MODEL 625p UNIT PLEASE CONTACT OUR CUSTOMER SERVICE CENTRE

Table of Contents

Getting Started

- 3 Safety Information
- 8 Introduction
 - 8 - About the "O" Symbol Display
 - 8 - Symbols Used in this Manual
 - 8 - Supplied Accesories
 - 8 - What is SIMPLINK?
- 9 - Recordable Discs
- 10 - Recommended recordable DVD discs
- 10 - Playable Discs
- 10 - Regional Code
 - 11 - File compatibility
- 12 Remote control
- 13 Front panel
- 13 Rear panel

Connecting

- 14 Connecting to Your TV
 - 14 - Antenna connection to your TV and this unit
 - 15 - HDMI Connection
 - 16 - Component Video Connection
- 16 Connecting to an Amplifier
 - 16 - Connecting to an Amplifier via Digital Audio Output
 - 17 - Connecting to an Amplifier via 2 Channel Audio Output
- 18 - Accessory Audio/Video (A/V) Connections to Recorder
 - 18 - Connecting a Digital Camcorder
- 19 USB device connection
 - 19 - Playback content in the USB device
 - 19 - Compatible USB Flash Drive
- 20 Auto Set Up

System Setting

- 21 Home Menu Overview
- 21 General Settings
 - 21 - Adjust the Setup Settings
 - 22 - Auto Programming
 - 22 - Manual Channel Add
 - 22 - Program Edit
 - 24 - Auto Clock Set
 - 24 - Manual Clock Set
- 26 Language Settings
- 27 Audio Settings
- 28 Lock Settings
- 30 Recording Settings
- 31 Disc Settings
- 33 Network Settings
 - 33 - Software Update
 - 33 - System Information

Operating

- 34 General Explanation of On-Screen Display
 - 34 - Displaying Information While Watching TV
 - 34 - Displaying Information on-screen
- 35 TV Viewing
 - 35 - Viewing the EPG (Electronic Programme Guide)
 - 36 - Program Selection
- 38 Playing a DVD
 - 38 - Playback Setup
 - 38 - General Features
- 41 Playing a VCR
 - 41 - Preparation
 - 41 - Normal Playback
 - 42 - Playing a DivX Movie Disc
 - 44 - Playing an Audio CD or MP3/WMA Disc
 - 45 - Viewing a JPEG File
- 47 DVD Recording
 - 47 - DVD Recording
 - 48 - Basic Recording from a TV
 - 49 - Instant Timer Recording
 - 49 - Timer Recording
 - 51 - Recording from External Components
 - 52 DVD Editing

- 52 - Title List and Chapter List Menu
Overview
- 53 - VR Mode: Original and Playlist Editing
- 60 Dubbing
- 60 - Dubbing from VCR to DVD
- 60 - Recording from DV Input
- 61 - Recording from a Digital Camcorder

Troubleshooting

- 62 Troubleshooting
- 62 - General
- 62 - Resetting the unit
- 63 - Playback
- 63 - Recording
- 64 - HDMI

Appendix

- 65 Controlling a TV with the Supplied
Remote Control
- 65 - Setting up the remote to control your
TV
- 66 Area Code List
- 67 Language code List
- 68 Trademarks and Licenses
- 69 Specifications
- 71 Maintenance
- 71 - Handling the Unit
- 71 - Notes on Discs

1

2

3

4

5

6

7

8

Introduction

About the “⊘” Symbol Display

“⊘” may appear on your TV display during operation and indicates that the function explained in this owner’s manual is not available on that specific media.

Symbols Used in this Manual

! Note

Indicates special notes and operating features.

! Caution

Indicates cautions for preventing possible damages from abuse.

A section whose title has one of the following symbols are applicable only to the disc represented by the symbol.

DVD ALL	All DVD discs listed below
-RW_{VR}	DVD-RW with VR recording mode
-RW_{Video}	DVD-RW with Video recording mode
+RW	DVD+RW disc
-R	DVD-R disc
+R	DVD+R (DL) disc
DVD	DVD-Video disc
ACD	Audio CDs
MP3	MP3 files
WMA	WMA files
JPEG	JPEG files
VCR	Video Tape
DivX	DivX files

Supplied Accessories

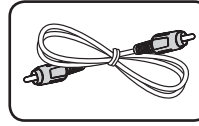

Video cable (1)

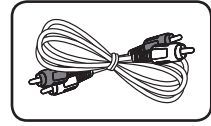

Audio cables (1)

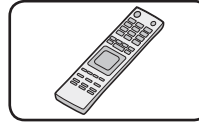

Remote control (1)

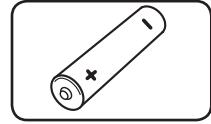

Batterie (1)

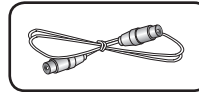



RF cable (1)

What is SIMPLINK?

Some functions of this unit are controlled by TV’s remote control when this unit and LG TV with SIMPLINK are connected through HDMI connection.

- Controllable functions by LG TV’s remote control; Play, Pause, Scan, Skip, Stop, Power Off, etc.
- Refer to the TV owner’s manual for the details of SIMPLINK function.
- LG TV with SIMPLINK function has the logo as shown above.

Recordable Discs

	<p>DVD-RW:</p> <ul style="list-style-type: none"> - DVD-RW discs can be formatted for VR mode recording or Video mode recording. - These Discs can be recorded on repeatedly. Recordings can be erased, then you can record again on the same Disc. <p>[VR mode]</p> <ul style="list-style-type: none"> - Recordings can be extensively edited. - Playable only on VR mode compatible players (after finalization). <p>[Video mode]</p> <ul style="list-style-type: none"> - Playable on regular DVD players (after finalization) - Limited editing features.
	<p>DVD-R:</p> <ul style="list-style-type: none"> - These Discs can be recorded only once. After you finalize a DVD-R, you cannot record on it or edit it. - DVD-R discs can be only formatted to Video mode. - Playable on regular DVD players (after finalization). - Limited editing features.
	<p>DVD+RW:</p> <ul style="list-style-type: none"> - These Discs can be recorded on repeatedly. Recordings can be erased, then you can record again on the same Disc. - Playable on DVD+RW compatible players (automatically finalization). - The edited contents are playable on DVD+RW compatible players only after finalization. - Recordings can be edited the title/chapter



DVD+R:

- These Discs can be recorded only once. After you finalize a DVD+R, you cannot record on it or edit it any more.
- Playable on DVD+R compatible players (after finalization).
- Any edited contents are not be compatible on DVD+R compatible players. (Hide, chapter combine, added chapter mark, etc.)
- Limited title/chapter editing features.

Note for recording

Disc type	Disc format	Recording mod	Functions
DVD	Video format	n/a	Playback only
DVD-RW	Video Recording format	VR mode	Playback, recording, Original/Playlist editing
	Video format (default)	Video mode	Playback, limited recording, limited editing
DVD-R	Video format	Video mode	Playback, limited recording, limited editing
DVD+RW	+RW Video format	DVD+RW	Playback, limited recording, Title/Chapter editing
DVD+R	+R Video format	DVD+R	Playback, limited recording, limited Title/Chapter editing

Recommended recordable DVD discs

DVD-R	Mitsubishi (8x, 16x), Verbatim (8x, 16x)
DVD-RW	Mitsubishi (8x, 16x), Verbatim (8x, 16x), JVC (4x), Maxell (4x)
DVD+R	Mitsubishi (8x, 16x), Verbatim (8x, 16x)
DVD+R(DL)	Mitsubishi (2.4x, 8x)
DVD+RW	Mitsubishi (8x, 16x), HP (4x), Verbatim (4x), Ricoh (4x)

Note

If a DVD-RW/DVD+RW disc is recorded using a personal computer or other DVD recorder, you cannot format the disc using this recorder. So if you want to use the disc on this recorder, you must format the disc using the original recorder.

Note

- Depending on the conditions of the recording equipment or the CD-R/RW (or DVD±R/RW) disc itself, some CD-R/RW (or DVD±R/RW) discs cannot be played on the unit.
- Do not attach any seal or label to either side (the labeled side or the recorded side) of a disc.
- Do not use irregularly shaped CDs (e.g., heart-shaped or octagonal). Doing so may result in malfunctions.
- Depending on the recording software & the finalization, some recorded discs (CD-R/RW, DVD±R/RW) may not be playable.
- DVD-R/RW, DVD+R/RW and CD-R/RW discs recorded using a personal computer or a DVD or CD Recorder may not play if the disc is damaged or dirty, or if there is dirt or condensation on the Recorder's lens.
- If you record a disc using a personal computer, even if it is recorded in a compatible format, there are cases in which it may not play because of the settings of the application software used to create the disc. (Check with the software publisher for more detailed information.)
- This player requires discs and recordings to meet certain technical standards in order to achieve optimal playback quality. Pre-recorded DVDs are automatically set to these standards. There are many different types of recordable disc formats (including CD-R containing MP3 or WMA files) and these require certain pre-existing conditions to ensure compatible playback.
- Customers should note that permission is required in order to download MP3 / WMA files and music from the Internet. Our company has no right to grant such permission. Permission should always be sought from the copyright owner.

Playable Discs

	DVD-VIDEO (8 cm / 12 cm disc) Discs such as movies that can be purchased or rented.
	Audio CD (8 cm / 12 cm disc) Music CDs or CD-Rs/CD-RWs in music CD format that can be purchased
	CD-R/RW (8 cm / 12 cm disc) CD-R/CD-RW discs that contain audio titles, DivX, MP3, WMA, or JPEG files.

Regional Code

This unit has a regional code printed on the rear of the unit. This unit can play only DVD discs labeled same as the rear of the unit or "ALL".

File compatibility

Overall

Available File extensions: ".jpg", ".jpeg", ".avi", ".divx", ".mpg", ".mpeg", ".mp4", ".mp3", ".wma"

- Some wav files are not supported on this player.
- The file name is limited to 180 characters.
- Depending on the size and number of the files, it may take several minutes to read the contents on the media.

Maximum Files/Folder: Less than 1999 (total number of files and folders)

CD-R/RW, DVD±R/RW Format:
ISO 9660+JOLIET, UDF and UDF Bridge format

Video Files

Available resolution size: 720 x 576 (W x H) pixels

Playable subtitle: ".smi", ".srt",

Playable Codec format: "DIV3", "MP43", "DIVX", "DX50"

Playable Audio format: "AC3", "PCM", "MP2", "MP3", "WMA"

- Not all the WMA Audio format is compatible with this unit.

Sampling frequency: within 8 - 48 kHz (MP3), within 32 - 48kHz (WMA)

Bit rate: within 8 - 320kbps (MP3), 32 - 192kbps (WMA)

! Note

- HD video files contained on the CD or USB 1.0/1.1 may not played properly.
- This player supports H.264/MPEG-4 AVC profile Main, High at Level 4.1. For a file with higher level, the warning message will appear on the screen.
- This player does not support files that are recorded with GMC*¹ or Qpel*². Those are video encoding techniques in MPEG4 standard, like DivX or XVID have.
*1 GMC – Global Motion Compensation
*2 Qpel – Quarter pixel

Audio Files

Sampling frequency: within 8 - 48 kHz (MP3), within 32 - 48kHz (WMA)

Bit rate: within 8 - 320kbps (MP3), 32 - 192kbps (WMA)

! Note

- This unit cannot support the ID3 Tag embedded MP3 file.
- The total playback time indicated on the screen may not correct for VBR files.

Photo Files

Recommended size:

Less than 4MB recommended

- Progressive and lossless compression photo image files are not supported.
- Depending on the size and number of the JPEG files, it may take several minutes to read the contents of the media.

Remote control

1

Getting Started

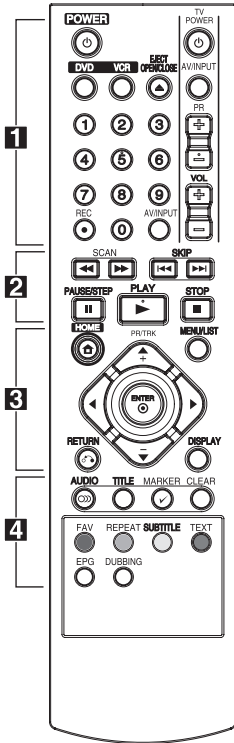

Battery Installation

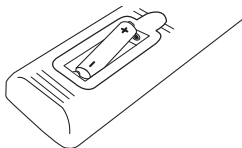

Remove the battery cover on the rear of the Remote Control, and insert two R03 (size AAA) batteries with + and - matched correctly.

..... **1**

POWER (⏻): Switches the unit ON or OFF.

DVD: Selects the unit's mode to DVD.

VCR: Selects the unit's mode to VCR.

EJECT, OPEN/CLOSE: Opens and closes the disc tray and ejects the tape in the VCR deck.

0-9 numerical buttons: Selects numbered options in a menu.

REC (●): Starts recording. Press repeatedly to set the recording time.

AV/INPUT: Changes the input to use for recording (Tuner, AV1-2, or DV IN).

TV Control Buttons: See page 65.

..... **2**

SCAN (◀▶):
 - DVD: Search backward or forward.
 - VCR: Rewinds/Advances the tape during the **stop/play** mode for fast reverse/forward picture search.

SKIP (◀◀▶▶): Go to next or previous chapter/track or file.

PAUSE/STEP (⏸): Pause playback or recording temporarily.

PLAY (▶): Starts playback.

STOP (■): Stops playback or recording.

..... **3**

HOME (🏠): Accesses or removes the HOME menu.

MENU/LIST: Accesses menu on a DVD disc, Title List or Playlist menu.

◀/▶/▲/▼ (left/right/up/down): Navigates on-screen displays.

PR/CH TRK (+/-): Select channel programme of the recorder. To adjust tracking. To control vertical tremble during picture still.

ENTER (⊙): Acknowledges menu selection or displays the TV info.

DISPLAY: Accesses On-Screen Display.

RETURN (↶): Exits the menu or back to previous step.

..... **4**

AUDIO (🔊): Selects an audio language or audio channel.

TITLE: Displays the disc's Title menu, if available.

MARKER (✓): Marks any point during playback.

CLEAR:
 - Removes a mark on the Marker Search menu.
 - Reset tape counter to zero.

EPG: Displays the EPG menu.

Colored buttons: Use when tuned to a teletext program of a digital broadcast. The function of each button will be described on-screen, and changes depending on the screen being displayed.

FAV: Displays the favorite programme list.

REPEAT: Repeats a desired section or sequence.

SUBTITLE: Selects a subtitle language.

TEXT: Switches between teletext mode and normal TV viewing.

EPG: Displays the EPG menu.

DUBBING: Press to copy VCR to DVD)

Front panel

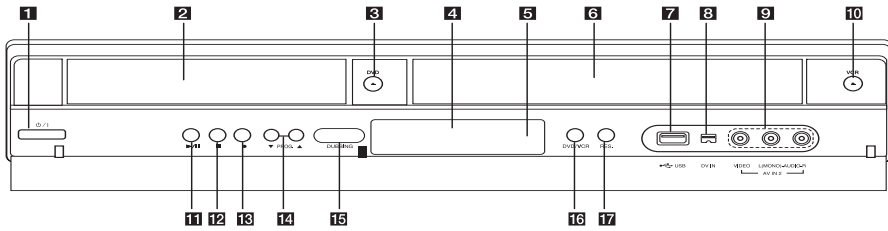

- | | | | |
|----------|------------------------------------|-----------|------------------|
| 1 | ⏻/I (Power) | 10 | VCR/▲ |
| 2 | Disc Tray | 11 | ▶ (PLAY/PAUSE) |
| 3 | DVD/▲ | 12 | ■ (STOP) |
| 4 | Display window | 13 | ● (Recording) |
| 5 | Remote Sensor | 14 | PROG. (▼ / ▲) |
| 6 | Cassette Compartment (VCR deck) | 15 | DUBBING |
| 7 | USB Port | 16 | DVD/VCR |
| 8 | DV IN | 17 | RES. |
| 9 | AV IN 2 (VIDEO/AUDIO (Left/Right)) | | |

Rear panel

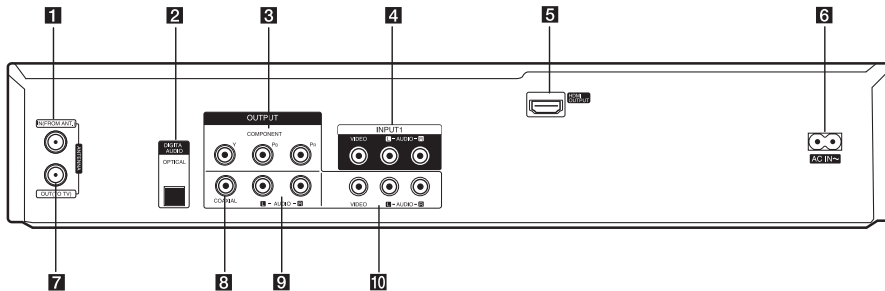

- | | | | |
|----------|--------------------------------|-----------|---------------------------------|
| 1 | ANTENNA IN (FROM ANT.) | 6 | AC Power Cord |
| 2 | OPTICAL (DIGITAL AUDIO OUTPUT) | 7 | ANTENNA OUT (TO TV) |
| 3 | COMPONENT OUTPUT (Y Pb Pr) | 8 | COAXIAL OUTPUT |
| 4 | VIDEO/AUDIO INPUT (Left/Right) | 9 | AUDIO OUTPUT (Left/Right) |
| 5 | HDMI OUTPUT | 10 | VIDEO/AUDIO OUTPUT (Left/Right) |

Connecting to Your TV

Make one of the following connections, depending on the capabilities of your existing equipment.

- Antenna connection to your TV and this unit (page 14)
- HDMI connection (page 15)
- Component Video connection (page 16)

! Note

- Depending on your TV and other equipment you wish to connect, there are various ways you could connect the unit. Use only one of the connections described in this manual.
- Please refer to the manuals of your TV, Stereo System or other devices as necessary to make the best connections.
- Make sure the player is connected directly to the TV. Tune the TV to the correct video input channel.
- Do not connect the player's AUDIO OUT jack to the phono in jack (record player) of your audio system.
- Do not connect your player via your VCR. The image could be distorted by the copy protection system.

Antenna connection to your TV and this unit

Remove the antenna cable plug from your TV set and insert it into the antenna socket at the back of the recorder. Plug one end of the antenna cable into the TV socket on the recorder and the other end into the antenna input socket on your TV set.

Connect one end of the RF cable to ANTENNA OUT (TO TV) jack on the unit and other end to ANTENNA IN jack on your TV. Passes the signal from the ANTENNA IN jack to your TV/monitor.

Connect the ANTENNA IN jack on the unit. If you want to use an indoor antenna, use one with a signal amplifier rated at 5V, 100mA and set [Antenna Feed 5V] to [ON] in the setup menu (See page 25).

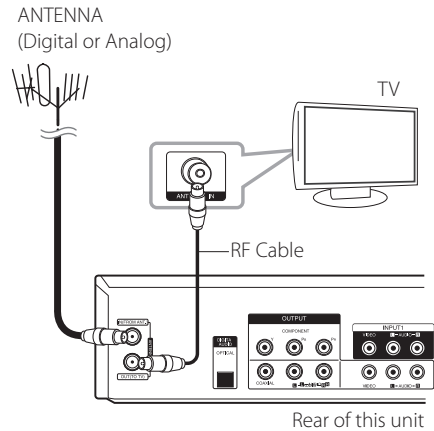

! Note

Please observe that this recorder is not designed for the reception of regular digital cable-TV signals (QAMsignal). Despite this, operators of smaller cable networks may have chosen to distribute the digital terrestrial signals (COFDM-signal) in the network. In this case this recorder may well be used. Check with your landlord if you are insecure about what type of TV-signal that is provided in the wall antenna outlet.

HDMI Connection

If you have a HDMI TV or monitor, you can connect it to this player using a HDMI cable (Type A). Connect the HDMI jack on the unit to the HDMI jack on a HDMI compatible TV or monitor.

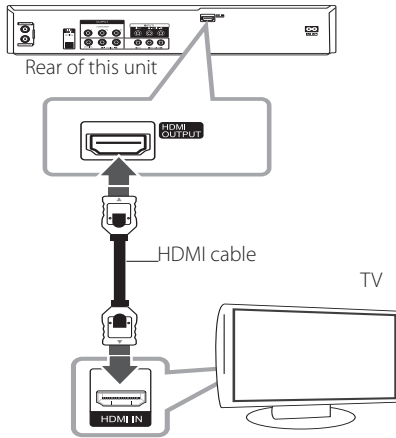

Set the TV's source to HDMI (refer to TV's Owner's manual).

Additional Information for HDMI

- When you connect a HDMI or DVI compatible device make sure of the following:
 - Try switching off the HDMI/DVI device and this player. Next, switch on the HDMI/DVI device and leave it for around 30 seconds, then switch on this player.
 - The connected device's video input is set correctly for this unit.
 - The connected device is compatible with 720x480p, 1280x720p, 1920x1080i or 1920x1080p video input.
- Not all HDCP-compatible HDMI or DVI devices will work with this player.
 - The picture will not be displayed properly with non-HDCP device.
 - This player does not playback and TV screen is changed to black screen.

Note

- When you use the HDMI connection, you can change the resolution (576i, 576p, 720p, or 1080i) for the HDMI output using RES. button on the front panel.
- If your TV is NOT capable of handling 96 kHz sampling frequency, set the [Sampling Freq.] option to [48 kHz] on the setup menu (See page 27).
- When this choice is made, this unit will automatically convert any 96 kHz signals to 48 kHz so your system can decode them.
- If your TV is not equipped with Dolby Digital and MPEG decoder, set the [Dolby Digital] and [MPEG] options to [PCM] on the setup menu (See page 27).
- If your TV is not equipped with DTS decoder, set the [DTS] options to [OFF] on the setup menu (See page 27). To enjoy DTS multi channel surround, you must connect this recorder to a DTS compatible receiver via one of this recorder's digital audio outputs.
- The arrow on the cable connector body should face up for correct alignment with the connector on the recorder. If your TV is NOT capable of handling 96 kHz sampling frequency, set the [Sampling Freq.] option to [48 kHz] on the setup menu (See page 27).

About HDMI

HDMI (High Definition Multimedia Interface) supports both video and audio on a single digital connection for use with DVD Players, Set-Top Boxes, and other AV devices.

HDMI was developed to provide the technologies of HDCP (High Definition Contents Protection). HDCP is used to protect digital content transmitted and received.

HDMI has the capability to support standard, enhanced, or high-definition video plus standard to multi-channel surround-sound audio, HDMI features include uncompressed digital video, a bandwidth of up to 5 gigabytes per second, one connector (instead of several cables and connectors), and communication between the AV source and AV devices such as DTVs.

Component Video Connection

Connect the COMPONENT VIDEO OUT jacks on the player to the corresponding input jacks on the TV using component video cable. Connect the left and right AUDIO OUT jacks of the player to the audio left and right IN jacks on the TV using the audio cables.

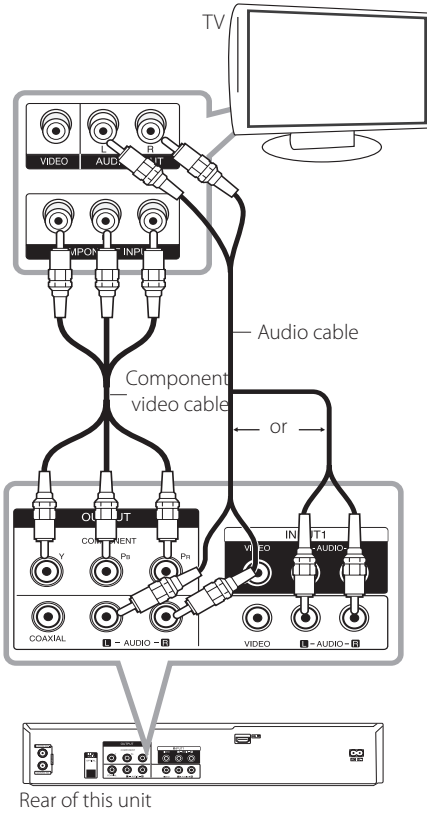

Note
Set the resolution to 576p for progressive signal using RES. button on the front panel.

Connecting to an Amplifier

Connecting to an Amplifier via Digital Audio Output

Connecting to an amplifier equipped with two channel analog stereo

Connecting to an amplifier equipped with two channel digital stereo (PCM) or to an Audio/Video receiver equipped with a multi-channel decoder (Dolby Digital™, MPEG 2, or DTS)

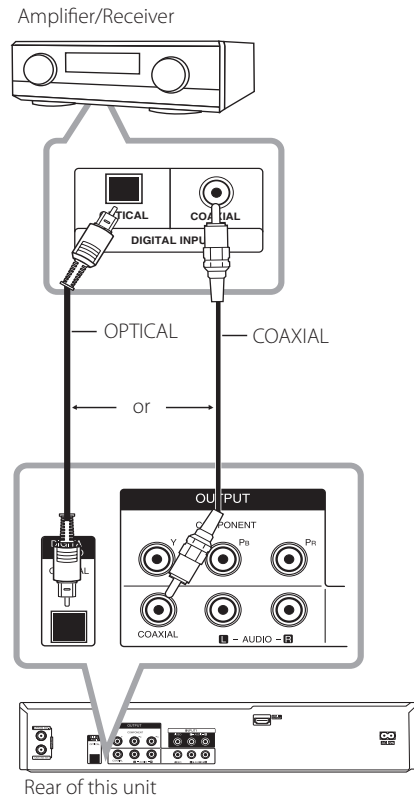

1. Connect one of the Recorder's DIGITAL AUDIO OUTPUT jacks (OPTICAL or COAXIAL) to the corresponding in jack on your amplifier. Use an optional digital (Optical or Coaxial) audio cable.
2. You will need to activate the Recorder's digital output. (See [Audio Settings] on page 27).

! Note

- If the audio format of the digital output does not match the capabilities of your receiver, the receiver will produce a strong, distorted sound or no sound at all.
- Six Channel Digital Surround Sound via digital connection can only be obtained if your receiver is equipped with a Digital Multi-channel decoder.
- To see the audio format of the current DVD in the on-screen display, press AUDIO.
- This Recorder does not perform internal (2 channel) decoding of a DTS sound track. To enjoy DTS multi channel surround, you must connect this Recorder to a DTS compatible receiver via one of this Recorder's digital audio outputs.
- While viewing a digital channel, the 2 channel stereo audio is only output through the audio output jacks.
- A digital multi-channel connection provides the best sound quality. For this you need a multi-channel Audio/Video receiver that supports one or more of the audio formats supported by your Recorder (MPEG 2, Dolby Digital and DTS). Check the receiver manual and the logos on the front of the receiver.

Connecting to an Amplifier via 2 Channel Audio Output

Connect the Left and Right 2CH AUDIO OUT jacks on the player to the audio left and right jacks on your amplifier, receiver, or stereo system using audio cables.

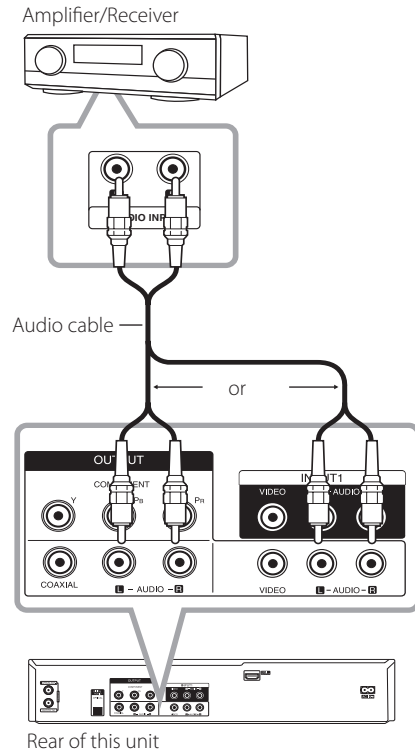

Connection to Another device

Accessory Audio/Video (A/V) Connections to Recorder

Connect the input jacks (AV IN 2) on the recorder to the audio/video out jacks on your accessory component, using audio/video cables.

Jack panel of Accessory Component (VCR, Comcorder, etc.)

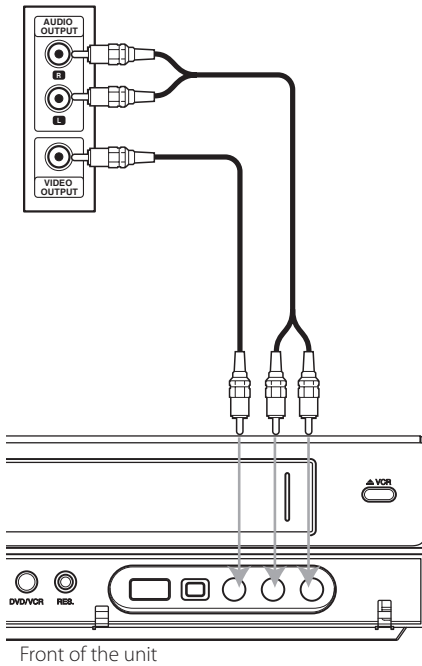

Connecting a Digital Camcorder

Using the front panel DV IN jack, it is possible to connect a DV digital camcorder or video deck or DVD-R/RW recorder and digitally transfer DV tapes or DVD-R/RW discs to DVD-R/RW.

Use a DV cable (not supplied) to connect the DV in/out jack of your DV camcorder/video deck to the front panel DV IN jack of this recorder.

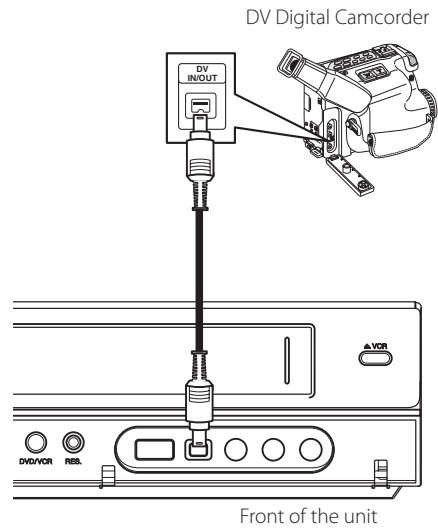

Note

- This jack is for connection to DV equipment only. It is not compatible with digital satellite tuners or D-VIDEO video decks.
- Disconnecting the DV cable while recording a contents of the connected digital camcorder may result in malfunction.

USB device connection

This unit can play movie, music and photo files contained on a USB device.

Playback content in the USB device

1. Insert a USB device into the USB port until it fits into place.

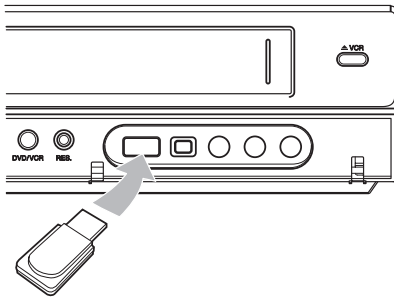

2. Press HOME (🏠).
3. Select [Movie], [Photo] or [Music] using ◀/▶, and press ENTER (⊙).

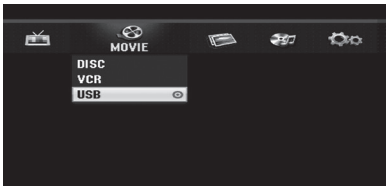

4. Select the [USB] option using ▼/▲ and press ENTER (⊙).

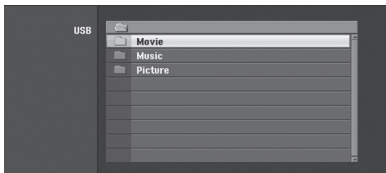

5. Select a file using ▼/▲, and ENTER (⊙) to play the file.
6. Withdraw the USB device carefully.

Compatible USB Flash Drive

1. USB Flash Drive which require additional program installation when you have connected it to a computer, is not supported.
2. USB Flash Drive: USB Flash Drive that support USB1.1.

! Note

- The contents on the disc cannot be moved or copied to USB Flash Drive.
- Keep the USB Flash Drive out of reach of children. If swallowed, seek medical advice immediately.
- This unit supports only USB Flash Drive with FAT16 or FAT32 format.
- The USB Flash Drives which require additional program installation when you have connected it to a computer are not supported.
- This unit is compatible with the Flash type USB device that supports USB 1.1.
- This unit may not support some USB Flash Drives.
- Do not extract the USB Flash Drive during operation (play, etc.). It may cause a malfunction on this unit.

Auto Set Up

After the POWER is pressed for the first time to turn on the unit or after resetting the unit, the Initial Setup Wizard function sets the language, tuner channels and clock automatically.

1. Select a language for the Setup menu and onscreen display. Use ▼/▲ to select a language then press ENTER (⊙).



Press RETURN (↵) to skip the Initial Setup.

2. Check your antenna connections. Press ENTER (⊙) to move next step.

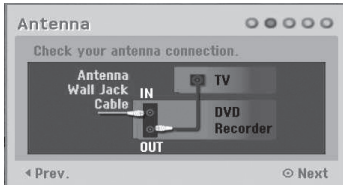

Press ◀ to go back to the previous level.

3. Use ▼/▲ to select the clock Set option then press ENTER (⊙).

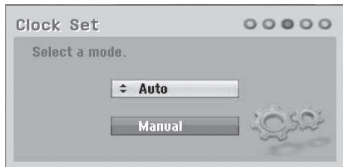

[Auto]

When Channel auto search is completed the actual Time and Date are also set automatically. (See "Auto Clock Set" on page 24)

[Manual]

Enter the necessary information for year, date and time.

◀/▶ (left/right): Moves the cursor to the previous or next column.

▼/▲ (up/down): Changes the setting at the current cursor position.

Press ENTER (⊙) to confirm your setting.

4. Use ▼/▲ to select the [Digital], [Analog] or [All] and press ▶.

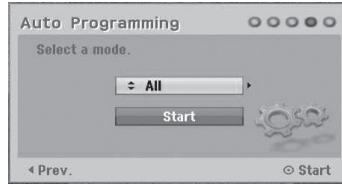

5. Press ENTER (⊙) to begin the channel search.

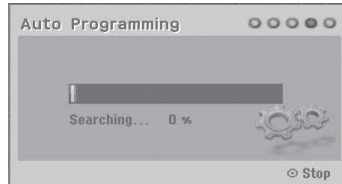

6. Press ENTER (⊙) to exit the menu.

! Note

You can reset the Initial Setup Wizard from the [Factory Set] in the setup menu. (see page 25).

System Setting

Home Menu Overview

From the Home Menu screen you can access all the Media for playback and recording of the unit.

1. Press HOME (🏠). The Home menu appears.
The unit will be in tuner mode always when the Home menu appears.

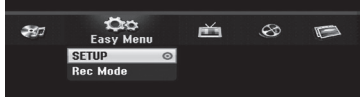

2. Use ◀/▶ to select the desired option.

[Easy Menu]

Setup: Displays Setup menu.

Rec. Mode: Displays Record Mode setup menu. (See page 30)

[RECORD]

Timer Record: Displays [Timer Record] menu. (See page 49-50).

[MOVIE]

VCR: Playing a VCR. (page 41-42)

DISC:

- Displays TITLE LIST menu for recordable disc (page 52)
- Playing a DVD (page 38-40).

USB: Displays [Movie List] menu for USB Flash Drive.

[PHOTO]

DISC: Displays [Photo List] menu for disc.

USB: Displays [Photo List] menu for USB Flash Drive.

[MUSIC]

DISC: Displays [Music List] menu for disc.

USB: Displays [Music List] menu for USB Flash Drive.

3. Use ◀/▶ to select the desired option.
Press ENTER (⊙) to confirm your selection.
4. Press HOME (🏠) to exit the Home menu.

! Note

The Movie, Photo and Music menus are only enable when there are the Movie, Photo and Music contents.

General Settings

Adjust the Setup Settings

You can change the settings of the unit in the [SETUP] menu.

1. Press HOME (🏠).
2. Use ◀/▶ to select the [SETUP] and press ENTER (⊙). The [SETUP] menu appears.

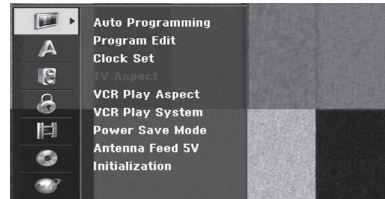

3. Use ▼/▲ to select the first setup option, and press ▶ to move to the second level.

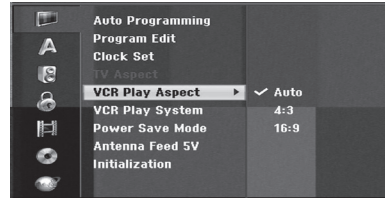

4. Use ▼/▲ to select a second setup option, and press ▶ to move to the third level.

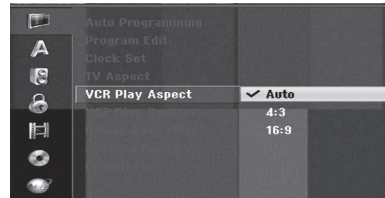

5. Use ▼/▲ to select a desired setting, and press ENTER (⊙) to confirm your selection.

Auto Programming

This recorder is equipped with a frequency synthesized tuner capable of receiving the analog and digital channels.



1. Display [SETUP] menu.
2. Select the [Auto Programming] option then press **▶**.
3. Press **▶** to move to the second level.
4. Use **▼/▲** to select the [Digital], [Analog] or [All] and press **▶**.
5. Press ENTER (⊙) to begin the channel search. The tuner will automatically cycle through all available channels in the area and place them in the tuner's memory.

Manual Channel Add

This feature manually adds channels.

! Note

Password is needed to access the [Auto Programming] option if [Lock System] option is set to [On].

1. Select the [Program Edit] option then press **▶**.
2. Use **▼/▲** to select the [Add Channel] option then press ENTER (⊙).
3. Use **▼/▲** to select [Analog] for analog channel or [Digital] for digital channel then press **▶**.
4. Use **▼/▲** to select a channel number. Searches for a channel automatically. Searching stops when the recorder tunes in a channel.
5. Press ENTER (⊙) to add the channel.

Switching the program list to DIGITAL TV, ANALOG TV, or RADIO

1. Press **▲** to move the highlight position to top of the program list.
2. Press **◀/▶** to select a [DIGITAL TV], [ANALOG TV] or [RADIO]. Selected program list appears.

Program Edit

You can edit a channel manually (add, delete, name, move, etc.).

! Note

Password is needed to access the [Auto Programming] option if [Lock System] option is set to [On].



1. Display [SETUP] menu.
2. Use **▼/▲** to select [Program Edit], and press **▶**.
3. Use **▼/▲** to select the [Edit], and press ENTER (⊙). Program List menu appears.
4. Use **▼/▲** to select a Ch. number then press ENTER (⊙). Program List options appears on the left side of the menu display.
5. Use **▼/▲** to select an option then press ENTER (⊙) to confirm.

[Favorite]

Set the memorized channel to favorite channel. (favorite channel shows **FAV** icon.)

[Delete]

Deletes the program from program list.

[Move] (Analog channel only)

Moves the program's location on the program list.

[Block]

Blocks the program.

[Station Rename] (Analog channel only)

Edits the station name.

[Program Edit] (Analog channel only)

Edits the selected program.

6. Press RETURN (↵) repeatedly to exit Program List menu

Program Edit

You can perform a search to select and store an TV channels manually.

1. Use ▼/▲ to select a program on the Program List menu then press ENTER (⊙).
Program List options appears on the left side of the Program List menu.
2. Use ▼/▲ to select [Program Edit] option from the options then press ENTER (⊙).
Program Edit menu appears.



3. See the descriptions on below to use Program Edit menu.

◀/▶ (**left/right**): Moves the cursor to the previous or next column.

▼/▲ (**up/down**): Changes the setting at the current cursor position.

[PR]

Indicates program number (display only).

[Seek]

Searches a station automatically.

Use ◀/▶ to select Seek option then press ▼/▲. Searching stops when the recorder tunes in a station.

[Ch.]

Changes the channel number to edit. Use ◀/▶ to select Ch. option then press ▼/▲.

[MFT]

Changes the frequency for fine tuning.

Use ◀/▶ to select MFT option then press ▼/▲.

[NICAM]

Set the NICAM function to for the program On or Off.

4. Choose OK then press ENTER (⊙) to confirm the setting and returns to the Program List menu.

Station Rename

You can name stations independently. Names can be up to 5 characters long.

1. Use ▼/▲ to select a program on the Program List menu then press ENTER (⊙).
Program List options appears on the left side of the Program List menu.
2. Use ▼/▲ to select [Station Rename] option from Program List options then press ENTER (⊙). Keyboard menu appears.



3. Enter a name for the station. Use ◀/▶/▼/▲ to select a character then press ENTER (⊙) to confirm your selection.

[Alphabet Capital/Alphabet Small] – Change the keyboard menu settings to capital letters, small letters.

[Symbol] – Switches the keyboard to symbol characters.

[Space] – Inserts a space at the cursor position.

[Delete] – Clear all entered characters.

[◀/▶] – Moves cursor to left or right.

[OK] – Select to finish.

[Cancel] – Select to exit the menu.

4. Choose [OK] icon then press ENTER (⊙) to fix the name and returns to the Program List menu.

Sort TV channels manually

You can sort the program's position on the Program List menu.

1. Use ▼/▲ to select a program on the Program List menu then press ENTER (⊙).
Program List options appears on the left side of the Program List menu.
2. Use ▼/▲ to select [Move] option from Program List options then press ENTER (⊙).
3. Use ▼/▲ to select a desired position then press ENTER (⊙) to store.

Deleting a program

You can delete a program on the Program List menu.

1. Use ▼/▲ to select a program on the Program List menu then press ENTER (⊙).
Program List options appears on the left side of the Program List menu.
2. Use ▼/▲ to select [Delete] option from Program List options then press ENTER (⊙).
The Program is deleted.

Setting the NICAM ON/OFF

This DVD recorder can receive Hi-Fi sound transmissions in NICAM Stereo. However, if sound distortion occurs, due to poor reception, you can switch Off.

Auto Clock Set

When Channel auto search is completed the actual Time and Date are also set automatically. If the time in the recorder display is not correct, the clock must be set manually.

1. Select [Clock set] option then press ►.
2. Use ▼/▲ to select [Auto] option then press ENTER (⊙).
3. If the clock that has automatically set is different with your local clock, you can add more time using [Time Offset] option. (For example, when summer time is started in local area.) Press ► to select [Time Offset] option.
4. Press ▼/▲ to select a value then press ENTER (⊙) (0, 30, 60, 90, 120). Select "0" if the clock that has automatically set is identified with your local clock.

5. Select your region in the [Time Zone] option to set a time relative to area. If the summer time has started in your region, select the [Time Zone] option and increase or decrease time using ▼/▲, and press ENTER (⊙).

Note

- There are cases where the TV station does not send, or sends wrong date and/or time information and the recorder sets the incorrect time.
- If this happens, we recommend that you set the clock manually.

Manual Clock Set

1. Select [Clock set] option then press ►.
2. Use ▼/▲ to select [Manual] option then press ENTER (⊙).
3. Enter the necessary information for date and time.
 - ◀/▶ (left/right): Moves the cursor to the previous or next column.
 - ▼/▲ (up/down): Changes the setting at the current cursor position.
4. Press ENTER (⊙) to confirm your setting.

TV Aspect

To record a wide screen format programme successfully the correct type of wide screen signal must be broadcast by the TV station.

You can choose:

[4:3 Letter Box]

Select when a standard 4:3 TV is connected. Displays theatrical images with masking bars above and below the picture.

[4:3 Pan Scan]

Select when a standard 4:3 TV is connected. The video material formatted in the Pan & Scan style is played back in that style (Both sides of the picture are cut off).

[16:9 Wide]

Select when a 16:9 wide TV is connected.

VCR Play Aspect

You can choose:

[AUTO]

Automatically plays back Wide-Screen programmes as Wide-Screen and Normal programmes as normal.

[4:3]

Only for playing back Normal format recordings (4:3).

[16:9]

Only for playing back Wide-Screen format recordings (16:9).

VCR Play System

Your video recorder uses triple colour standards, Auto, PAL and MESECAM. During play your video player should select the colour system automatically, however if you experience problems you may need to do it manually.

Power Save Mode

You can set up the unit into an economic power save mode.

Nothing is displayed in the display window.

[ON]

Power Save Mode is active..

[OFF]

Power Save Mode is not active.

Antenna Feed 5V

If you are using indoor antenna with a signal amplifier rated at DC 5V, 100mA, the recorder can supply power through ANTENNA IN jack.

1. Display [Setup] menu.
2. Use ◀/▶/▼/▲ to select the [Antenna Feed 5V], and press ENTER (⊙).
3. Use ▼/▲ to select [ON] and press ENTER (⊙) to supply antenna power.

! Note

The [Antenna Feed 5V] option must be set to [OFF] when your indoor antenna is supplied the power from the mains. If you set the [Antenna Feed 5V] option to [ON] for the indoor antenna which is supplied power from the mains, it may cause serious defect to this unit.

Initialization

You can reset the recorder to its original factory settings.

[Factory Set] If you need to, you can reset the recorder to all its factory settings. Some options cannot be reset. (DVD Rating, Password, and Area Code) Select [Factory Set] icon then press ENTER (⊙) and auto setup menu will appear, see page 20.

1. Select [Initialization] option then press ▶.
2. Press ENTER (⊙) and then confirm message will appear.
3. Use ◀/▶ to select [Yes] or [No] then press ENTER (⊙).

Language Settings

Display Menu

Select a language for the [Setup] menu and on-screen display.

Disc Menu/Disc Audio/Disc Subtitle

Select the language you prefer for the audio track (disc audio), subtitles, and the disc menu.

[Original]

Refers to the original language in which the disc was recorded.

[Other]

Press ENTER (Ⓞ) to select another language. Use number buttons then press ENTER (Ⓞ) to enter the corresponding 4-digit number according to the language code list on page 67

[Off] (Disc Subtitle only)

Turn off Subtitle.

! Note

Depending on the disc, your language setting may not work

DTV Audio

Digital channels sometimes provide multiple audio tracks, often in a different language. You can set a default audio language with this setting.

! Note

If provided by the broadcaster, you can also select a different audio language while viewing TV by pressing AUDIO repeatedly.

DTV Subtitle

Digital channels sometimes provide subtitle, often in a different language. You can set a default subtitle language with this setting.

- If available, you can also select a subtitle language while viewing digital TV viewing, press SUBTITLE repeatedly.
- If subtitles are available, the DTV subtitle icon appears on the program information display to indicate that you can select one of those subtitle options with the SUBTITLE button.

! Note

DTV Subtitle will appear only if provided by the broadcaster.

DivX Subtitle

If the movie subtitle is not displayed properly, change the subtitle language code that supports your language.

1. Display [Setup] menu.
2. Use ◀/▶/▼/▲ to select the [DivX Subtitle], and press ENTER (Ⓞ).
5. Use ▼/▲ to select a language code that supports your language.

! Note

You can change the subtitle language code while a movie is in playback. Press and hold SUBTITLE for 3 seconds during playback. The language code will appear. Use ▼/▲ to select another language code until the subtitle is displayed properly and then press ENTER (Ⓞ).

Audio Settings

Each DVD disc has a variety of audio output options. Set the recorder's Audio Output according to the type of audio system you use.

Dolby Digital

[PCM]

Select when connected to a 2-channel digital stereo amplifier. The Recorder's digital audio outputs sounds in the PCM 2ch format when you play a DVD video disc recorded on the Dolby Digital recording system.

[Bitstream]

Select [Bitstream] if you connected the Recorder's DIGITAL OUT jack to a Dolby Digital decoder (or an amplifier or other equipment with a Dolby Digital decoder).

DTS

[OFF]

If you select [OFF], the DTS signal is not output through the DIGITAL OUT jack.

[Bitstream]

Select [Bitstream] if you connected the Recorder's DIGITAL OUT jack to a DTS decoder (or an amplifier or other equipment with a DTS decoder).

MPEG

[PCM]

Select when connected to a 2-channel digital stereo amplifier. The Recorder's digital audio outputs sounds in the PCM 2ch format when you play a DVD video disc recorded on the MPEG2 recording system.

[Bitstream]

Select [Bitstream] if you connected the Recorder's DIGITAL OUT jack to a MPEG decoder (or an amplifier or other equipment with a MPEG decoder).

Sampling Freq.

If your receiver or amplifier is NOT capable of handling 96 kHz signals, select 48 kHz. When this choice is made, this unit will automatically convert any 96 kHz signals to 48 kHz so your system can decode them. If your receiver or amplifier is capable of handling 96 kHz signals, select 96 kHz. When this choice is made, this unit will pass each type of signal through without any further processing.

DRC (Dynamic Range Control)

With the DVD format, you can hear a program's sound track in the most accurate and realistic presentation possible, thanks to digital audio technology. However, you may wish to compress the dynamic range of the audio output (the difference between the loudest sounds and the quietest ones). Then, you may listen to a movie at a lower volume without losing clarity of sound. Set DRC to ON for this effect.

Lock Settings

Lock System

Allows you to set up specific programs and ratings through blocking schemes. Also allows you to activate or disable all of the lock schemes previously set up. A password is required to gain access to the lock menu options. When the Lock System is set to [OFF], the DTV Rating is not effective.

1. Select [Lock System] option then press **▶**.
2. To access the Lock Menu options, you must input the 4-digit password you created.
If you have not yet entered a password you are prompted to do so. Input a 4-digit password. Enter it again to verify. If you make a mistake, press CLEAR repeatedly to delete numbers one by one then correct it.
3. Select [ON] or [OFF] using the **▼/▲** buttons.
4. Press ENTER (⊙) to confirm your setting.

DVD Rating

1. Select a rating from 1 to 8 using the **▼/▲** buttons.

[1]-[8]

Rating one (1) has the most restrictions and rating eight (8) is the least restrictive

[No Limit]

If you select [No Limit], parental control is not active and the disc plays in full.

2. Press ENTER (⊙) to confirm your rating selection, then press HOME (🏠) to exit the menu.
3. Press EJECT, OPEN/CLOSE (⬆️) to activate parental control.

! Note

If you set a rating for the recorder, all disc scenes with the same rating or lower are played. Higher rated scenes are not played unless an alternate scene is available on the disc. The alternative must have the same rating or a lower one. If no suitable alternative is found, playback stops. You must enter the 4-digit password or change the rating level in order to play the disc.

Parental Guidance

Viewing of some digital TV programmes can be limited according to the age limit you set.

1. Display [Setup] menu.
2. Use **▼/▲** to select [Parental Guidance] and press ENTER (⊙).
3. Input the password using numerical buttons. If you have not set your password yet, input and press ENTER (⊙).

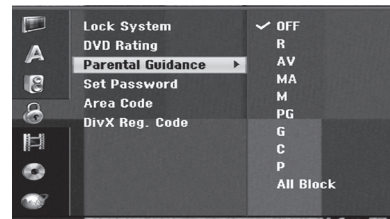

4. Use **▼/▲** to set the limitation level and press ENTER (⊙).
Refer to the table below for the rating levels.

[OFF]

You can view all programs.

Rating Level	Age
P	5-6
C	7-8
G	9-10
PG	11-12
M	13-14
MA	15-16
AV	17
R	18

[All Block]

All programs are locked. To view a programme, you must input the 4-digit password you have created.

Set Password

1. Select [Set Password] option then press ►.
2. Follow step 2 as shown in [Lock System] above.

[Change]

Enter the new password twice after entering the current password.

[Delete]

Delete the current password after entering the current password. If you delete password, All of Rating options are set to default.

3. Press HOME (🏠) to exit the menu.

! Note

If you forget your password

If you forget your password, you can reset it using the following steps.

1. Press HOME (🏠) and the Home menu appears.
2. Select [Setup] and press ENTER (⊙).
3. Input the 6-digit number [210499]. When the message appears, select [OK] then press ENTER (⊙). The password will be reset.
4. Enter a new password as described above. If you delete your password, all ratings will be reset to the default setting. The default setting is to allow all programs to be viewed in full.

DivX Reg. Code

We provide you the DivX® VOD (Video On Demand) registration code that allows you to rent and purchase videos using the DivX® VOD service. For more information, visit www.divx.com/vod.

1. Select [DivX Reg. Code] option then press ►.
2. Press while enter is selected and the registration code will appear.
3. Use the registration code to purchase or rent the videos from DivX® VOD service at www.divx.com/vod. Follow the instructions and download the video onto a disc for playback on this unit.

! Note

All the downloaded videos from DivX® VOD can only be played back on this recorder.

DivX Registration Code

ABOUT DIVX VIDEO: DivX® is a digital video format created by DivX, Inc. This is an official DivX Certified device that plays DivX video.

Visit www.divx.com for more information and software tools to convert your files into DivX video.

ABOUT DIVX VIDEO-ON-DEMAND: This DivX Certified® device must be registered in order in to play DivX Video-on-Demand (VOD) content. To generate the registration code, locate the DivX VOD section in the device setup menu. Go to vod.divx.com with this code to complete the registration process and learn more about DivX VOD.

Area Code

Enter the Area Code whose standards were used to rate the DVD video disc, based on the list in the reference chapter (see page 66).

1. Select [Area Code] option then press ►.
2. Follow step 2 as shown [Lock System].
3. Select the first character using ▼/▲ buttons.
4. Shift the cursor using ► buttons and select the second character using ▼/▲ buttons.
5. Press ENTER (⊙) to confirm your area code selection, then press HOME (🏠) to exit the menu.

Recording Settings

Rec Mode Set

You can set the picture quality for recording; XP (High Quality), SP (Standard Quality), LP (Low Quality), EP (Extend Quality), MLP (Maximum Long Play)

1. Select the [Rec Mode Set] option then press ►.
2. Use ▼/▲ to select a desired Rec Mode Set (XP, SP, LP, EP or MLP).

[XP] – Highest quality setting, gives about 1 hour of recording time on a DVD (4.7GB).

[SP] – Default quality, sufficient for most applications, gives about 2 hours of recording time on a DVD (4.7GB).

[LP] – Slightly lower video quality, gives about 4 hours of recording time on a DVD disc (4.7GB).

[EP] – Low video quality, gives about 6 hours of recording time on a DVD (4.7GB).

[MLP] – The longest recording time with the lowest video quality, gives you about 14 hours of recording time on a DVD (4.7GB).

3. Press ENTER (⊙) to confirm your selection, then press HOME (🏠) to exit the menu.

! Note

You may see a fragmented picture or distorted subtitle during playing back the contents recorded in EP and MLP mode.

Rec Aspect

When recording, you can set the recording aspect ratio to suit the material you're recording (16:9 or 4:3).

! Note

When DVD recording, you can set the recording aspect ratio to suit the material you're recording (16:9 or 4:3).

DV Rec Audio

You need to set this if you have a camcorder using 32kHz/12-bit sound connected to the front panel DV IN jack. Some digital camcorders have two stereo tracks for audio. One is recorded at the time of shooting; the other is for overdubbing after shooting.

[Audio 1]

On the Audio 1 setting, the sound that was recorded while shooting is used..

[Audio 2]

On the Audio 2 setting, the overdubbed sound is used.

TV Rec Audio

When TV recording with bilingual, you can choose audio channel to record.

[Main+Sub]

Main language and Sub language.

[Main]

Main language only

[Sub]

Sub language only.

Auto Chapter

When DVD recording, chapter markers are put in specified setting. You can change this interval to 5 minutes, 10 minutes or 15 minutes. If you select [None], switch off automatic chapter marking altogether with the [None] setting.

Disc Settings

Disc Format

If you load a completely blank disc, the recorder will initialize the disc.

[DVD-R]

The recorder initialize the disc to Video mode. The recording mode will always be Video mode.

[DVD-RW/DVD+RW/DVD+R(DL)]

The Initialize menu will appears. Select [OK] then press ENTER (⊙). DVD-RW disc is initialized to Video mode.

Also, you can reformat the DVD-RW/DVD+RW from the Setup menu as below.

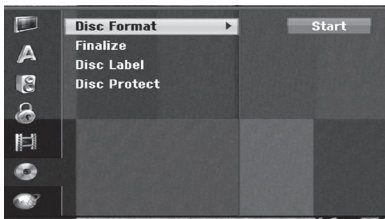

1. Select [Disc Format] option then press ►.
2. Press ENTER (⊙) while [Start] is selected. Format Disc menu appears.
3. Use ◀/▶ to select a desired mode (VR Mode or Video Mode) then press ENTER (⊙). Confirm message will appear. For DVD+RW discs, go to step 4.
4. Use ◀/▶ to select [OK] then press ENTER (⊙). It takes a few moments to initialize the disc.

! Caution

If you want to change the disc format, everything recorded on the disc will be erased.

Finalize

Finalizing [fixes] the recordings in place so that the disc can be played on a regular DVD player or computer equipped with a suitable DVD-ROM drive.

Finalizing a disc creates a menu screen for navigating the disc. This is accessed by pressing MENU/LIST or TITLE.

! Caution

- Once you have finalized a DVD-R and DVD+R disc, you cannot edit or record anything else on that disc.
- You can record and edit a DVD-RW disc by choosing [Unfinalize] option.
- You can edit or record on the DVD+RW disc even after finalizing.

1. Select [Finalize] option then press ►.

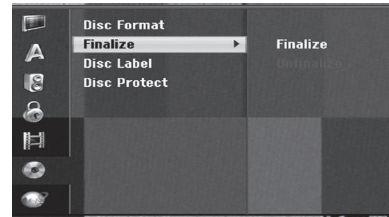

2. Press ENTER (⊙) while [Finalize] is selected. Finalize menu appears.
3. Select [OK] then press ENTER (⊙). The recorder starts finalizing the disc.

! Note

- How long finalization takes depends on the type of disc, how much is recorded on the disc, and the number of titles on the disc.
- DVD+R DL disc can take up to 30 minutes to finalize.
- If you load a DVD-RW that has already been finalized, you can 'Unfinalize' it by choosing Unfinalize from the Finalize menu. After doing this, you can edit and re-record onto the disc.
- You cannot unfinalize a DVD-R and DVD+R disc.
- If [Disc Protect] option is set to [ON], the finalize is not available. To finalize, set [Disc Protect] option to [OFF].

Disc Label

Use this to enter a name for the disc. This name appears when you display disc information on-screen.

The disc name can be up to 32 characters long.

For discs formatted on a different Recorder, you will see only a limited character set.

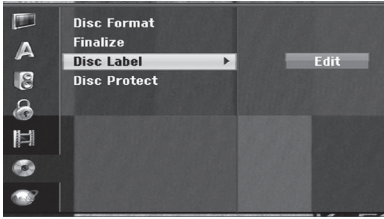

1. Display [Setup] menu.
2. Use ▼/▲ to select the [Disc Label] option.
3. Press ► to move to the third level. [Edit] icon is highlighted.
4. Press ENTER (⊙).
Keyboard menu appears.



5. Enter a name for the disc. Use ◀/▶/▼/▲ to select a character then press ENTER (⊙) to confirm your selection. Refer step 3 as shown on page 23 (Station Rename).

Remote control buttons for entering a name

▶ (PLAY)

Inserts a space at the cursor position.

⏏ (PAUSE/STEP)

Deletes the previous character at the cursor position.

⏏ (STOP), CLEAR

Only for playing back Wide-Screen format recordings (16:9).

[Numbers (0~9)]

Enters the character of corresponding location on the selected column.

[MENU/LIST, DISPLAY]

Switches the keyboard type (English/Latin Capital, English/Latin Lowercase, Symbols) 6
Choose OK then press ENTER (⊙) to fix the name and return to the Setup menu.

6. Press HOME to exit the menu.

Disc Protect

When recording in DVD+RW / +R disc or VR mode formatted DVD-RW disc, set to ON to prevent accidental recording, editing or deleting of the disc loaded. If you need to unlock the disc to make edits, select OFF.

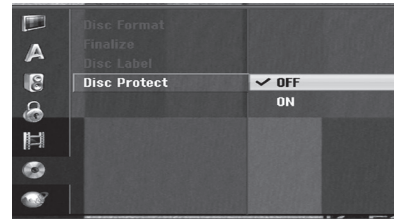

Network Settings

Software Update

Your recorder is able to receive updates to some of its features and functions. These updates will occur automatically, usually at times when the recorder would likely be turned off.

If your recorder is on when an update is sent, you may experience a disruption in reception for a few hours. The recorder turns off then turn the unit back on after the update is complete.

Please consult the [System Info] screen to check for an upgrade planned by service provider or distributor.

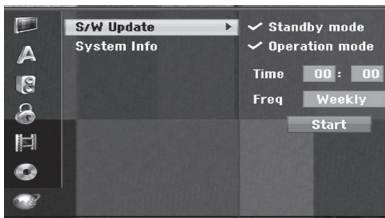

Caution

Your recorder must be plugged into AC power to receive any updates. Do not unplug your recorder while an update is in progress.

[Standby mode]

Press ENTER (Ⓞ) to update the software when this unit is turned off. Check mark appears.
(Updated time: At every 3:00, 9:00, 15:00 and 21:00 o'clock)

[Operation Mode]

Press ENTER (Ⓞ) to update the software when this unit is turned on. Check mark appears.

[Time] – Set time to update the software.

[Freq] – Selects frequency to update the software. (Weekly or Dalily)

[Start] – Press ENTER (Ⓞ) to update right now.

Note

If the recorder is turned on, the update is not activated during recording, Timeshift, viewing teletext or program guide, etc.

System Information

Shows system information. (software version, DTV Signal Quality and DTV Signal Strength)

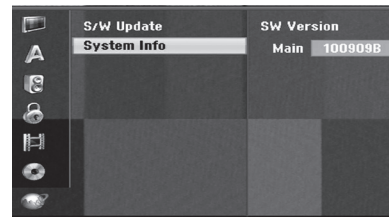

General Explanation of On-Screen Display

This manual gives basic instructions for operating the Recorder. Some DVDs require specific operation or allow only limited operation during playback. When this occurs, the symbol appears on the TV screen, indicating that the operation is not permitted by the Recorder or is not available on the disc.

Displaying Information While Watching TV

During viewing the TV, press DISPLAY to display/remove the information displayed on-screen. e.g., when DVD-RW in VR mode is inserted.

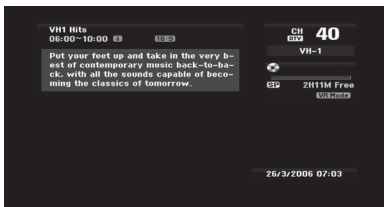

- You can select an item by pressing ▼/▲ and change or select the setting by pressing ◀/▶. For details about each item, see the pages in parenthesis.

[TITLE]

Current title (or track) number/total number of titles (or tracks) (page 38).

[CHAPTER]

Current chapter number/total number of chapters (page 38).

[TIME]

Elapsed playing time (page 39)

[AUDIO]

Selected audio language (DVD VIDEO only) or audio channel (page 40).

[SUBTITLE]

Selected subtitle (page 40).

[ANGLE]

Selected angle/total number of angles (page 39).

[SOUND]

Selected sound mode (page 40).

- To remove the on-screen display, press DISPLAY or RETURN(↵) repeatedly until it disappears.

! Note

If no button is pressed for 7 seconds, the on-screen display disappears.

Displaying Information on-screen

You can display various information about the disc or tape loaded on-screen.

- Press DISPLAY once to show current status. Example : DVD-Video disc.

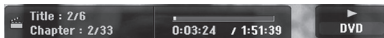

- Press DISPLAY once again to show various playback information. The items displayed differ depending on the disc type or playing status.



TV Viewing

Viewing the EPG (Electronic Programme Guide)

The Electronic Programme Guide schedule and program information for digital programs. They also provide local over-the-air programs information including conventional digital programs. Use the Electronic Programme Guide to find programs easily and conveniently and to view schedule and descriptive program information for the programs.

To Display the Program Guide

Press the EPG button on your remote control.

To Exit the Program Guide

Press the RETURN (↵) button to return to the last program you tuned to.

To change guide menu

The guide screen provides two search menus.

Press yellow color button when the Program Guide is displayed.

- Now/Next: The screen shows now and next programs.



- 8 Days: The screen shows programs within 8 days.



To navigate through programs on the Guides

Use ◀/▶/▼/▲ on your remote control to navigate the guide screen.

You can move faster through programs by scrolling page-by-page with the ◀◀ or ▶▶ buttons on the remote control. Each button stroke scrolls one page up or down.

To tune to another current channel

Use ◀/▶/▼/▲ to select a current channel then press ENTER (⊙). You can watch the channel.

To display the Full Information window

You can view detail informations for the highlighted program. Press blue color button to display detail information window. To exit the detail information window, press blue color button again.

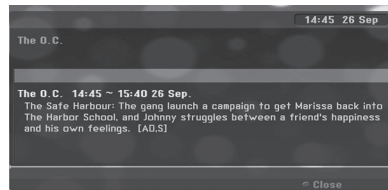

To change date

When the Program Guide with 8 days is displayed, you can also change the date of the Program Guide by pressing the green color button then use ◀/▶ to select a date then press ENTER (⊙).

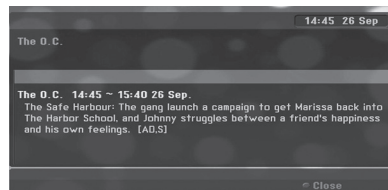

Timer Recording with Program Guide

You can set a timer record using program guide with 8 days.

1. Display Program Guide with 8 days.
2. Select a program then press red color button. The red timer icon will be displayed and the program will be memorized by the recorder. You can check the programming on the Timer Record List menu (see page 50).
3. To release the timer recording, select the program then press red color button. The red timer icon disappears.

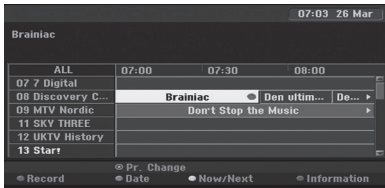

Program Selection

You can select a program as shown below.

Number buttons

Use Number (0-9) buttons to select a program directly.

FAV button

Press to scroll through your favorite programs.

PR +/- buttons

Use PR +/- on the remote control or PROG ▼/▲ on the front panel to cycle the recorder through the programs in memory.

Program List

Three types of program lists are provided for easy and quick program searching.

ANALOG TV: The list of all analog TV programs.

DIGITAL TV: The list of all digital TV programs.

RADIO: The list of all Radio programs.

Displaying Channel List and Changing Channel

You can display channel list using the ENTER (⊙) button and switch into other channel on the channel list.

1. Press ENTER (⊙) while watching a program to display the channel list.
2. Select your desired channel using the ▼/▲ and press ENTER (⊙) to change the channel.

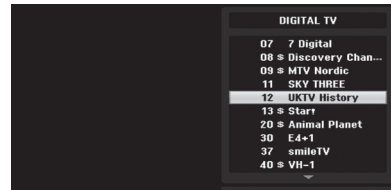

Switching Program List

You can switch the program list to DIGITAL TV, ANALOG TV, or RADIO.

1. Press ▲ to move the highlight position to top of the program list.
2. Press ◀/▶ to select a [DIGITAL TV], [ANALOG TV], or [RADIO]. Selected program list appears.

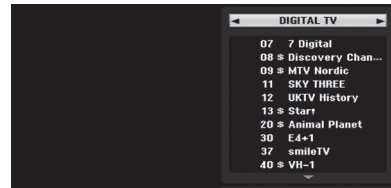

Displaying the Favorite Program List

You can display favorite channel list: The list of the favorite channels with several-groups that you can organise channels by your private taste.

! Note

To set a favorite program, use [Program Edit] option in the Setup menu. (See page 22-23.)

1. Press ENTER (⊙) while watching a program to display the program list.
2. Press Red button. The favorite options appears.
3. Press ▼/▲ to select a favorite option then press ENTER (⊙).

Teletext Operation

Teletext is an optional function, therefore only those with the teletext system can receive the teletext broadcast.

Teletext is a free service broadcast by some TV stations which gives up-to-the-minute information on news, weather, television programs, share prices and many other topics.

The teletext decoder can support the SIMPLE systems. SIMPLE (standard teletext) consists of a number of pages which are selected by directly entering the corresponding page number.

Teletext in Service

The recorder gives you access to teletext which is greatly improved in various aspects such as text and graphics. This teletext can be accessed by special teletext services and specific services which broadcast teletext.

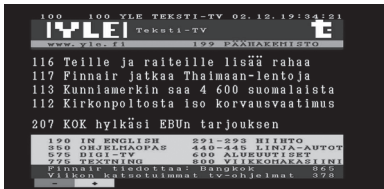

1. Press number or PR (+/-) buttons to select a program which broadcast teletext.
2. Press TEXT to access on the teletext.
3. Follow the indications on teletext and move onto the next or previous step by pressing color (RED or GREEN) or SKIP (◀◀/▶▶) buttons and so on.
4. Press TEXT or RETURN (↵) to switch off teletext and return to TV viewing.

Teletext on/off

1. Press TEXT to switch to teletext.
The initial page or last page appears on the screen.
Two page numbers, TV station name, date and time are displayed on the screen headline. The first page number indicates your selection, while the second shows the current page displayed.
2. Press TEXT or RETURN (↵) to switch off teletext.

! Caution

- If your TV is in zoom mode, the Teletext menu screen may be cut off.
- In this case, set the TV's zoom mode to normal to display the menu screen properly.

Page selection

1. Enter the desired page number as a three digit number with the numbered buttons.
If during selection you press a wrong number, you must complete the three digit number and then reenter the correct page number.
2. Use RED/GREEN buttons to move up and down pages.

Playing a DVD

Playback Setup

Before using the remote control, press the DVD button to select the device to be operated.

Turn the TV on and select the video input source connected to the Recorder.

Audio system: Turn the audio system on and select the input source connected to the Recorder.

1. Press OPEN/CLOSE (▲) to open the disc tray.
2. Load your chosen disc in the tray, with the playback side down.
3. Press OPEN/CLOSE (▲) to close the tray. READ appears on the display window, and playback starts automatically. If playback does not start, press ► (PLAY).
In some cases, the disc menu might appear instead.

! Note

If a menu screen is displayed

- The menu screen may be displayed first after loading a DVD which contains a menu.
- Use the ◀/▶/▼/▲ buttons to select the title/chapter you want to view, then press ENTER (⊙) to start playback.
- Press TITLE or MENU/LIST to return to the menu screen.
- If Parental Control is set and the disc is not within the Rating settings (not authorized), the 4-digit code must be entered and/or the disc must be authorized (see "DVD Rating", on page 28).
- DVDs may have a Region Code. Your recorder will not play discs that have a region code different from your recorder. The region code for this recorder is 2 (two). channels for cable subscribers.

General Features

! Note

Unless stated otherwise, all operations described use the remote control. Some features may also be available on the Setup menu.

Moving to another TITLE

When a disc has more than one title, you can move to another title as follows:

Press DISPLAY twice then use ▼/▲ to select the title icon. Then, press the appropriate numbered button (0-9) or ◀/▶ to select a title number.

Moving to another CHAPTER/ TRACK

When a title on a disc has more than one chapter/track, you can move to another chapter/track as follows:

Press SKIP (◀◀/▶▶) briefly during playback to select the next chapter/track or to return to the beginning of the current chapter/track.

Press SKIP (◀◀) twice briefly to step back to the previous chapter/track.

To go directly to any chapter/track during playback, press DISPLAY twice. Then, use ▼/▲ to select chapter icon (or select track icon). Then, enter the chapter/track number using the numbered buttons (0-9) or press ◀/▶.

Search

1. Press SCAN (◀◀ or ▶▶) during playback. The recorder will now go into SEARCH mode.
2. Press SCAN (◀◀ or ▶▶) to select the required speed: ◀ (Reverse play), ◀◀, ◀◀◀, ◀◀◀◀, ◀◀◀◀◀, ◀◀◀◀◀◀, ◀◀◀◀◀◀◀ (backward) or ▶, ▶▶, ▶▶▶, ▶▶▶▶, ▶▶▶▶▶, ▶▶▶▶▶▶ (forward).
With a DivX disc the Search speed changes: ◀◀, ◀◀◀, ◀◀◀◀, ◀◀◀◀◀ (backward) or ▶, ▶▶, ▶▶▶, ▶▶▶▶, ▶▶▶▶▶ (forward).
3. To exit SEARCH mode, press ► (PLAY).

Still Picture and Frame-by-Frame Playback

1. Press PAUSE/STEP (II) during playback.
The recorder will now go into PAUSE mode.
2. You can advance or back up the picture frame-by-frame by pressing ◀/▶ repeatedly during PAUSE mode.
3. To exit PAUSE mode, press ▶ (PLAY).

! Note

- The picture frame-by-frame in reverse is not available for Video CD.
- You can advance the picture frame-by-frame by pressing PAUSE/STEP (II) repeatedly on the remote control.

Slow Motion

1. Press PAUSE/STEP (II) during playback.
The recorder will now go into PAUSE mode.
2. Press SCAN (◀◀ or ▶▶) during PAUSE mode.
The Recorder will enter SLOW mode.
3. Use the SCAN (◀◀ or ▶▶) to select the required speed:
◀◀ 1/16, ◀◀ 1/8, ◀◀ 1/4, or ◀◀ 1/2 (backward), or ▶▶ 1/16, ▶▶ 1/8, ▶▶ 1/4, or ▶▶ 1/2 (forward).
4. To exit Slow Motion mode, press ▶ (PLAY).

Time Search

The Time Search function allows you to start playing at any chosen time on the disc.

1. Press DISPLAY twice during playback.
The on-screen display appears on the TV screen. The Time Search box shows the elapsed playing time of the current disc.
2. Within 7 seconds, use ▼/▲ to select the Time Search icon in the on-screen display. The “-:--:--” appears in the Time Search box.
3. Within 7 seconds, use the number buttons to enter the required start time. Enter hours, minutes, and seconds from left to right in the box.
You can not enter an invalid time.
If you enter the wrong numbers, press ◀/▶ to move the under bar () to the wrong number. Then enter the correct numbers.

4. Within 7 seconds, press ENTER (⊙) to confirm the start time.
Playback starts from the selected time on the disc.

Checking the Contents of DVD Video Discs:

Menus DVDs may contain menus that allow you to access special features. To open the disc menu, press MENU/LIST. Then, press the appropriate number button to select an option. Or, use the ◀/▶/▼/▲ buttons to highlight your selection, then press ENTER (⊙).

Title Menu

1. Press TITLE.
If the current title has a menu, the menu will appear on the TV screen. Otherwise, the disc menu may appear.
2. The menu may contain camera angles, spoken language and subtitle options, and chapters for the title.

Disc Menu

1. Press MENU/LIST.
The disc menu is displayed.
2. To remove the disc menu, press MENU/LIST again.

Camera Angle

If the disc contains scenes recorded at different camera angles, you can change to a different camera angle during playback.

1. Press DISPLAY twice during playback.
2. Use ▼/▲ to select the ANGLE icon.
3. Press ◀/▶ repeatedly to select a desired angle.

! Note

The Camera Angle icon is displayed on the TV screen when alternate angles are available.

Changing the Audio Soundtrack

Press AUDIO then press ◀/▶ repeatedly during playback to hear a different audio language or audio soundtrack if available.



Note

Some discs feature both Dolby Digital and DTS soundtracks. There is no analog audio output when DTS is selected. To listen to the DTS soundtrack, connect this recorder to a DTS decoder via one of the digital outputs. See page 16-18 for connection details.

Last Condition Memory

This Recorder memorizes last scene from the last disc that is viewed. The last scene remains in memory even if you remove the disc from the Recorder or switch off the Recorder. If you load a disc that has the scene memorized, the scene is automatically recalled.



Note

- Settings are stored in memory for use any time.
- This recorder does not memorize settings of a disc if you switch off the recorder before commencing to play it.

Changing the Audio Channel

With DVD-RW discs recorded in VR mode that have both a main and a Bilingual audio channel, you can switch between Main (L), Bilingual (R), or a mix of both (Main + Bilingual) by pressing AUDIO.

4

Operating

3D Surround

This unit can produce a 3D Surround effect, which simulates multi-channel audio playback from two conventional stereo speakers, instead of the five or more speakers normally required to listen to multichannel audio from a home theater system.

1. Press DISPLAY twice during playback. The On-Screen Display appears on the TV screen.
2. Use ▼/▲ to select the Sound icon in the On-Screen Display.
3. Use ◀/▶ to select "3D SUR".
To turn off the 3D Surround effect, select "NORMAL".

Subtitles

Press SUBTITLE then press ◀/▶ repeatedly during playback to see the different subtitle languages.

Playing a VCR

Preparation

- Before using the remote control, press the VCR button to select the device to be operated.
- Turn the TV on and select the video input source connected to the Recorder.
- Audio system: Turn the audio system on and select the input source connected to the Recorder.

Normal Playback

1. Insert a prerecorded video cassette.
The indicator will light and the Recorder will powerup automatically.
- Make sure that the TIMER indicator in the display window is not lighted. If it is, press POWER once.
- If a tape without a safety tab is inserted, the Recorder will start playback automatically.

2. Press ► (PLAY) once.
PLAY icon appears on the TV screen.

It is not necessary to select the tape speed for playback. It will be automatically selected by the Recorder.

3. Press STOP (■) to stop playback.
STOP icon appears on the TV screen.

If the tape reaches the end before STOP (■) is pressed, the Recorder will automatically stop, rewind and eject the tape, and turn itself off.

! Note

- If you wish to watch the DVD playback during the VCR playback, press DVD (or DVD/VCR) to change to DVD mode and perform the DVD playback.
- You cannot playback for the both DVD and VCR at the same time.

Tracking Control

Auto Tracking

The automatic tracking function adjusts the picture to remove snow or streaks.

The AUTO TRACKING function works in the following cases:

- A tape is played back for the first time.
- Tape speed (SP, LP) changes.
- Streaks or snow appear because of scratches on the tape.

Manual Tracking

If noise appears on the screen during playback, press either PR/TRK (▼/▲) on the remote control or PROG. (▼/▲) on the front panel until the noise on the screen is reduced.

- In case of vertical jitter, adjust these controls very carefully.
- Tracking is automatically reset to normal when the tape is ejected or the power cord is unplugged for more than 3 seconds.

Special Effect Playback

Special effects playback notes

- Horizontal lines (noise bars) will appear on the TV screen. This is normal.
- The audio is automatically muted during special effect modes, so there is no sound during search.
- During the high-speed picture search modes, a short time is needed to stabilize tape speed when re-entering the PLAY mode. Slight interference may be observed during this time.

Search

This function lets you visually search forward and backward for a desired scene on your tape.

1. Press SCAN (◀◀ or ▶▶) during playback.
The Recorder will be activated in the SEARCH mode.
- If the Recorder is left in the SEARCH mode for more than 3 minutes, the Recorder will automatically enter the PLAY mode, to protect the tape and video heads.
2. To return to playback, press ► (PLAY).

Still Picture and Frame-by-Frame Playback

1. Press **II** (PAUSE/STEP) during playback.
A still picture appears on the TV screen.
 - If a still picture vibrates vertically, stabilize it by using PR/TRK (**▼/▲**) on the remote control.
 - If the Recorder is left in the STILL mode for more than 5 minutes, the Recorder will automatically enter the STOP mode to protect the tape and video heads.
2. Press **II** (PAUSE/STEP) repeatedly to advance the video picture one frame at a time while viewing a still picture.
3. To return to playback, press **▶** (PLAY).

Slow Motion

1. While in still mode, press SCAN (**▶▶**).
The tape will be played back at a speed 1/19 times slower than the normal speed.
 - During slow playback, use PR/TRK (**▼/▲**) on the Remote Control to minimize noise bands.
 - If slow motion mode continues for more than 3 minutes, the Recorder will automatically change to normal play mode.
2. To return to playback, press **▶** (PLAY).

Counter Memory Function

This is useful if there is a section of tape you want to view immediately after recording or if you want to return to the same point several times.

1. Begin recording or playing a tape.
2. Press DISPLAY repeatedly to display the real-time counter on the TV screen.
3. At the point you want to locate later, reset the realtime counter to 0:00:00 by pressing CLEAR. Continue to play or record.
4. Press STOP (**■**) when recording or playback finishes.
5. Press **↶** (RETURN).
The tape automatically stops when the tape counter returns to about "0:00:00".

Playing a DivX Movie Disc

Using this unit you can play DivX disc. Before playing DivX files, read "About DivX movie files" on right.

1. Insert a disc and close the tray. The Movie menu appears on the TV screen.
2. Press **▼/▲** to select a folder, and press ENTER (**⊙**). A list of files in the folder appears. If you are in a file list and want to return to the Folder list, use the **▼/▲** buttons on the remote to highlight **⌂** and press ENTER (**⊙**).



3. If you want to view a particular file, press **▼/▲** to highlight a file and press **▶** (PLAY). You can use variable playback functions. Refer to pages 38-40.
4. Press **■** (STOP) to stop the playback.
The Movie menu appears.

Notice for displaying the DivX subtitle

If the subtitle does not display properly during playback, press **II** (PAUSE/STEP) when the subtitle is displayed and press and hold SUBTITLE about 3 seconds then press **◀/▶** to select another language code until the subtitle is displayed properly.

Movie menu options

1. Press ▼/▲ to select a folder/file on the Movie menu then press ENTER (⊙).
Movie menu options appear.
2. Press ▼/▲ to select an option, and press ENTER (⊙).

[Play]

Start playback the selected title.

[Open]

Opens the folder and a list of files in the folder appears.

About DivX movie files

DivX disc compatibility with this recorder is limited as follows:

- Available resolution size of the DivX file is under 720x576 (W x H) pixel.
- The DivX subtitle file name has to be identified with the DivX file name to display by this unit.
- The total number of files and folders on the disc should be less than 1999.
- If the number of the screen frame is over 29,97 frames per second, this unit may not operate normally.
- If the video and audio structure of recorded file is not interleaved, returns to the menu screen.
- If the file is recorded with GMC, the unit supports only 1-point of the record level.

* GMC?

GMC is the acronym for Global Motion Compensation. It is an encoding tool specified in MPEG4 standard. Some MPEG4 encoders, like DivX, have this option.

There are different levels of GMC encoding, usually called 1-point, 2-point, or 3-point GMC.

Playable DivX file

“.avi”, “.divx”

Playable DivX subtitle

“.smi”, “.srt”, “.sub (Micro DVD format only)”, “.txt (Micro DVD format only)”

- DivX subtitle except those listed above is not displayed on the TV screen.

Playable Codec format

“DIV3”, “MP43”, “DIVX”, “DX50”

Playable Audio format

“AC3”, “PCM”, “MP2”, “MP3”, “WMA”

- Sampling frequency: within 8 - 48 kHz (MP3), within 32 - 48kHz (WMA)
- Bit rate: within 8 - 320kbps (MP3), 32 - 192kbps (WMA)

CD-R format

ISO 9660 and JOLIET

DVD±R/RW format

ISO 9660 (UDF Bridge format)

Playing an Audio CD or MP3/WMA Disc

The Recorder can play audio CDs. Also, the Recorder can play MP3/WMA formatted recordings on CD-ROM, CD-R, CD-RW, DVD±R or DVD±RW disc.

Before playing MP3/WMA recordings, read the notes on MP3/WMA Recordings on page 45.

1. Insert a disc and close the tray.
AUDIO CD or MP3/WMA CD menu appears on the TV screen.



AUDIO CD Menu MP3/WMA CD Menu

2. Use **▼/▲** to select a track then press **▶** (PLAY). Playback starts.
During playback, the current track's elapsed playing time will appear on the display window and menu.
Playback will stop at the end of the disc.

! Note

- You can view TV channel or video input source by pressing RETURN. If you want to return to the Music menu, press MENU/LIST.
- If you select a MP3 and press DISPLAY, the file informations are displayed. Press DISPLAY again to remove the file informations.
- If you select a folder and press DISPLAY, the number of subfolders and number of MP3/WMA files in the folder are displayed.
- If you are in a file list and want to return to the Folder list, use the **v/v** to highlight and press ENTER (⊙) to return to the previous menu screen.

3. To stop playback at any other time, press **■** (STOP).

Music menu options

1. To display menu options, select a track (or folder) on the menu then press ENTER (⊙).
2. Use **▼/▲** to select an option then press ENTER (⊙) to confirm your selection.

Music-Audio CD menu options

[Play]

Starts playback the selected track.

[Random]

Plays tracks in random order.

[Program add]

Adds the track(s) to Program List.

Music-CD menu options

• When you select a track.

[Play]

Starts playback the selected track.

[Random]

Plays tracks in random order.

[Program add]

Adds the track(s) to Program List.

• When you select a folder.

[Open]

Displays sub-folders and MP3/WMA files only in the folder.

Pause

1. Press **||** (PAUSE/STEP) during playback.
2. To return to playback, press **▶** (PLAY) or press **||** (PAUSE/STEP) again.

Moving to Another Track

- Press SKIP (**⏪** or **⏩**) briefly during playback to go to the next track or to return to the beginning of the current track.
- Press SKIP (**⏩**) twice briefly to step back to the previous track.
- On an Audio CD, to go directly to any track, enter the track number using the numbered buttons (0-9) during playback on the Track List.

Search (Audio CD only)

1. Press SCAN (◀◀ or ▶▶) during playback.
The recorder will now go into SEARCH mode.
2. Press SCAN (◀◀ or ▶▶) to select the required speed: ◀◀, ◀◀◀, ◀◀◀◀ (backward) or ▶▶, ▶▶▶, ▶▶▶▶ (forward).
Search speed and direction are indicated on the menu screen.
3. To exit SEARCH mode, press ▶ (PLAY).

Notes on MP3/WMA Recordings

About MP3

- An MP3 file is audio data compressed by using the MPEG1 audio layer-3 file-coding scheme. We call files that have the ".mp3" file extension "MP3 files".
- The recorder can not read an MP3 file that has a file extension other than ".mp3".

About WMA (Window Media Audio)

- An WMA file is a Microsoft audio compression technology.
- WMA (Windows Media Audio) offers double the audio compression of the MP3 format.

MP3/WMA Disc compatibility with this recorder is limited as follows:

1. CD-R physical format should be "ISO 9660" and "JOLIET".
2. If you record MP3/WMA files using the software which cannot create a FILE SYSTEM, for example "Direct-CD" etc., it is impossible to playback MP3/WMA files. We recommend that you use "Easy-CD Creator", which creates an ISO9660 or JOLIET file system.
3. Total number of files and folders on the disc should be less than 1999.

This Recorder requires discs/recordings to meet certain technical standards in order to achieve optimal playback quality. Pre-recorded DVDs are automatically set to these standards. There are many different types of recordable disc formats (including CD-R containing MP3 or WMA files) that require certain pre-existing conditions (see above) to insure compatible playback.

Customers should also note that permission is required in order to download MP3/WMA files and music from the Internet. Our company has no right to grant such permission. Permission should always be sought from the copyright owner.

Viewing a JPEG File

The recorder can play discs with JPEG files. Before playing JPEG recordings, read "Notes on JPEG Recordings" on page 46.

1. Insert a disc and close the tray.
The Photo menu appears on the TV screen.
2. Use ◀/▶/▼/▲ to select a folder, then press ENTER (⊙). Open icon is highlighted on the left side of the menu.



3. Press ENTER (⊙).
A list of files in the folder appears.

! Note

If the icon displays in the Photo menu, it means you cannot see those JPEG files.

4. Use ◀/▶/▼/▲ to select a file, then press ENTER (⊙).
The options appear on the left side of the menu.



! Note

- If you are in a file list and want to return to the Folder list, use the ▼/▲ buttons on the remote to highlight the icon and press ENTER (⊙).
- You can view TV channel or video input source by pressing ⏪ (RETURN). If you want to return to the Photo menu, press MENU/LIST.

5. Use ▼/▲ to select [Full Screen] option then press ENTER (⊙).



- To stop viewing at any time, press ■ (STOP). The Photo menu reappears.

Skip Images

While viewing a picture, press SKIP (◀◀ or ▶▶) once to advance to the next file or return to the previous file.

Rotate Images

Use ▼/▲ while viewing a picture to flip the picture clockwise or counterclockwise.

View Slide Shows

- Select [Slide Show] option on the Photo menu.
- Press ENTER (⊙). The Slide Show menu appears.

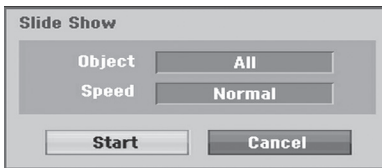

- Use ◀/▶/▼/▲ to set the options.

[Object]

Selected file or All files.

[Speed]

Sets the speed for Slide Show (Slow, Normal, or Fast).

- Select the Start option then press ENTER (⊙) to start the Slide Show.
- Press ■ (STOP) to stop the Slide Show and returns to the Photo menu.

! Note

Use the MARKER button to select multiple files.

Notes on JPEG Recordings

- Depending on the size and number of the JPEG files, it may take several minutes to read the contents of the media. If you don't see an on-screen display after several minutes, some of the files are too big — reduce the resolution of the JPEG files to less than 4 mega pixels and burn another disc.
- The total number of files and folders are free but the total number of files on the folder should be less than 1999.
- Some discs may be incompatible due to different recording formats or the condition of the discs.
- When you are using software such as “Easy CD Creator” to burn JPEG files on a CD-R, ensure that all selected files have the “.jpg” extension before copying them into the CD layout.
- If the files have “.jpe” extensions, please rename them as “.jpg” files.
- File names without the “.jpg” extension cannot be read by this recorder, even though the files are shown as JPEG image files in Windows Explorer®.
- Progressive and lossless compression JPEG image files are not supported.

DVD Recording

DVD Recording

Notes for DVD recording

- This Recorder cannot record CD-R or CD-RW discs.
- Fingerprints and small scratches on a disc can affect playback and/or recording performance. Please take proper care of your discs.
- The company does not hold any responsibility to compensate the contents which should have been recorded, and any losses or damages (e.g. losses of business profit, or business intermission) that may arise from malfunction of this recorder (not recording/editing as intended).
- The recording times shown are not exact because the recorder uses variable bit-rate video compression. This means that the exact recording time will depend on the material being recorded.
- When recording a TV broadcast, if the reception is poor or the picture contains interference, the recording times may be shorter.
- The unit cannot record the DTV caption on the recordable DVD disc.
- If you record still pictures or audio only, the recording time may be longer.
- The displayed times for recording and time remaining may not always add up to exactly the length of the disc.
- The recording time available may decrease if you heavily edit a disc.
- If using a DVD-RW disc, make sure you change the recording format (Video mode or VR mode) before you record anything on the disc. See page 25 (Initialize) for how to do this.
- When using a DVD-R or DVD+R disc, you can keep recording until the disc is full, or until you finalize the disc. Before you start a recording session, check the amount of recording time left on the disc.
- When using a DVD-RW disc in Video mode, recording time available will only increase if you erase the last title recorded on the disc.
- The Delete Title option in the Title List (Original) menu only hides the title, it does not actually erase the title from the disc and increase the recording time available (except for the last recorded title on a DVD-RW disc in Video mode).
- Overwrite recording is available using DVD+RW discs.
- When using a DVD+R/RW, the recorder will execute the Menu-making operation to update the new title and editing when removing the disc from the recorder.
- The recordable time is limited to 12 hours for a title.
- If the unit detects the copy-protected signal while recording, the recording will be paused temporarily until the signal switches to recordable signal.

Recording time and picture quality

There are five preset recording quality modes:

[XP] – Highest quality setting, gives about 1 hour of recording time on a DVD (4.7GB).

[SP] – Default quality, sufficient for most applications, gives about 2 hours of recording time on a DVD (4.7GB).

[LP] – Slightly lower video quality, gives about 4 hour of recording time on a DVD disc (4.7GB).

[EP] – Low video quality, gives about 6 hours of recording time on a DVD (4.7GB).

[MLP] – The longest recording time with the lowest video quality, gives you about 14 hours of recording time on a DVD (4.7GB).

Note

You may see a fragmented picture during playing back the contents recorded in EP or MLP mode.

Restrictions on video recording

- You cannot record copy-protected video using this recorder. Copy-protected video includes DVD-Video discs and some satellite broadcasts. If copy-protected material is encountered during a recording, recording will pause or stop automatically and an error message will be displayed on-screen.
- Video that is 'copy-once only' can only be recorded using a DVD-RW disc in VR mode.

Copy control signals	Recordable disc	
Copy-Free	-RW _{VR}	-RW _{Video}
	+RW	-R
	+R	
Copy-Once	-RW _{VR} Ver.1.1, Ver.1.2 with CPRM*	
Copy-Never	None	
* The recorded disc can be played only on CPRM compatible equipment		

TV Broadcast	Selected Audio	Broadcast Audio		Monitor Audio
		L Ch	R Ch	
MONO	MONO	MONO	MONO	MONO
STEREO	STEREO	L	R	STEREO
	Left	L	L	Left
	Right	R	R	Right
	MONO	MONO	MONO	MONO
MONO + SA	MONO	MONO	MONO	MONO
	SAP	SAP	SAP	SAP
STEREO + SAP	STEREO	L	R	STEREO
	SAP	SAP	SAP	SAP
	MONO	MONO	MONO	MONO

If you set the audio channel to SAP (Second Audio Program), but there is no SAP channel being broadcast, the main audio (mono or stereo) will be recorded.

- Press ● (REC) once to start recording.
The REC indicator lights in the display window.
- Press ■ (STOP) to stop recording.

! Note

- The maximum numbers of DVD titles are as show below;
 - DVD-R/RW: 99
 - DVD+R/RW: 49
- If the Recorder is powered off during DVD recording, the recording will not be saved.

Basic Recording from a TV

Follow the instructions below to record a TV program. Recording starts immediately and continues until the disc is full or you stop the recording.

- Switch on the Recorder, select the device (DVD) for recording and load a recordable disc. Also make sure that the TV input is set to this recorder.
- Set a recording mode as necessary settings. Refer to page 30.
- Select the TV channel to record.
- Use AUDIO to select the audio channel for analog channel or audio language for digital channel to record.

The table below shows what will be recorded on the different settings for different types of analog broadcast. The last column (Monitor Audio) shows what you'll hear as it is recording.

Instant Timer Recording

Instant Timer Recording allows you to make a recording easily of a preset length without using the program timer.

1. Follow steps 1-4 as shown left (Basic Recording from a TV).
2. Press ● (REC) repeatedly to select the recording time length. Recording starts after the first press. DVD: Each subsequent press increases the recording time by 10 minutes.

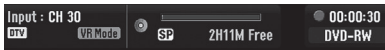

Checking the Recording Time

Press ● (REC) or DISPLAY once to check the recording time. The recalled setting will automatically return to the TV screen for a moment. Also, remaining time of recording is shown in the display window.

To Extend the Recording Time

The recording time can be extended anytime by pressing ● (REC). Each subsequent press increases the recording time by 10 minutes (DVD).

To Pause the Recording

1. Press || (PAUSE/STEP) to pause the recording.
2. When you want to continue recording, press || (PAUSE/STEP) or ● (REC).

! Note

- If you press || (PAUSE/STEP) during the Instant Timer Recording, it will be canceled.
- The Recorder will automatically power off when the Instant Timer Recording ends.

Timer Recording

1. Press HOME (🏠) and the Home menu appears.
2. Select [RECORD] > [Timer Record] and press ENTER (⊙).



3. Select [NEW] and press ENTER (⊙). The Timer Record menu will appear.

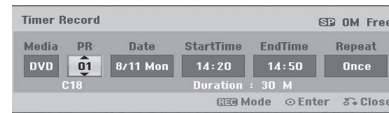

[PR] – Choose a channel that memorized in this Recorder, or one of the external inputs from which to record (AV1 or AV2).

[Date] – Choose a date up to 1 month in advance, or select a daily or weekly program.

[Start Time] – Set the recording start time.

[End Time] – Set the recording end time.

[Repeat] – Choose a desired repeat (Once, Daily (Monday - Friday), or Weekly).

4. Enter the necessary information for your timer recording(s).
 - ◀/▶ (left/right) – Move the cursor left/right
 - ▼/▲ (up/down) – Change the setting at the current cursor position.
 - Press RETURN (↵) to return to the [Timer Record List] menu.
5. Press ENTER (⊙) to save the program.

6. The [Rec. OK] on the [Check] field on the [Timer Record List] menu indicates the timer recording is programmed correctly.

[Rec OK] – Indicates the Timer Record is in recordable condition.

[No Disc] – There is no disc in the disc tray.

[Invalid disc] – The inserted disc is not recordable.

[Unrecordable] – There is no space to record on the disc.

[Lack Space] – The space on the disc is insufficient.

[Duplicate Date] – The space on the disc is insufficient.

7. Press RETURN (↵) to exit the [Timer Record List] menu.

Note

- You must insert a recordable disc.
- The Timer indicator lights on the front panel display.
- The Recorder will record the audio according to the current TV tuner setting. Use AUDIO to select the audio channel for analog channel to record before switching the Recorder to Standby mode.
- For digital TV recording with multiple audio languages, set audio language from the [DTV Audio] in sub-menu of the Setup menu (see page 26).
- The Recorder will automatically power off when the Timer Recording ends.
- There is a short delay when a timer recording finishes to confirm the recorded program. If two timer recordings are set to record sequentially (one right after the other), the very beginning of the later program may not be recorded.
- You must press ■ (STOP) to stop the Timer Recording.
- The Timer Recording function allows you to record up to 16 programs within a period of one month.

Checking Timer Recording Details

Programming can be checked whenever the Recorder is turned on.

1. Press HOME (🏠) and the Home menu appears.
2. Select [RECORD] > [Timer Record] and press ENTER (⊙).
3. Use ▼/▲ to select a program.
4. Press ENTER (⊙) to edit the selected program. Timer Record menu appears.

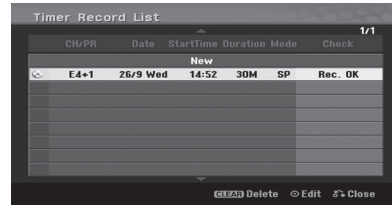

Canceling a Timer Recording

You can clear a timer setting anytime before the recording actually starts.

Use ▼/▲ to select a program you want to erase on the [Timer Recorder List] menu, then press CLEAR and select [OK] then press ENTER (⊙).

Stopping a Timer Recording in Progress

After a timer recording has started, you can still cancel the program.

- You can stop a timer recording in progress. Press ■ (STOP) and the confirm message will appear. Press ENTER (⊙) to stop the recording or press RETURN (↵) to continue the recording.

Recording from External Components

You can record from an external component, such as a camcorder or VCR, connected to any of the Recorder's external inputs.

1. Make sure that the component you want to record from is connected properly to the Recorder. See page 18.
2. Press AV/INPUT repeatedly to select the external input to record from.

[AV1] – AV1 mounted on back panel.

[AV2] – AV IN 3 VIDEO, AUDIO (L/R) mounted on front panel.

[DV] – DV Input mounted on front panel.

3. Load a recordable disc.
4. Set a recording mode as necessary settings. Refer to page 30.
5. Press ● (REC) once to start recording. The REC indicator lights in the display window.
6. Press ■ (STOP) to stop recording.

! Note

- Check that the Audio In settings DV Rec Audio are as you want them. See page 30.
- If your source is copy-protected using CopyGuard, you will not be able to record it using this recorder. See Copyright on page 3 for more details.
- Recording continues until you press ■ (STOP) or the disc is full.
- To record for a fixed length of time, see [Instant Timer Recording] on page 49.
- When unit is on any external inputs mode (AV1, AV2 and DV) the PR (▼/▲) buttons don't work, press AV/INPUT (on remote) repeatedly to select the TV mode, and then select the TV channels.

DVD Editing

Title List and Chapter List Menu Overview

Using the Title List menu you can edit video content. The editing features available in the Title List menu depend on whether you are editing video on DVD, and whether you're editing Original content, or a Playlist.

There are two ways to edit VR mode DVD-RW discs. You can directly edit the Original content of the disc, or you can create and edit a Playlist. The Playlist doesn't actually change any of the content on the disc, but just controls how the content is played back.

1. Press MENU/LIST to display the Title List menu. Playback should be stopped when you do this.
- When selecting titles, use the ▼/▲ buttons to display the previous/next page if there are more than six titles.
- If you are editing a VR mode disc, press MENU/LIST to switch between Original and Playlist menu.
- Press DISPLAY to display the information of selected title on the Title List menu.
- After selecting a title or chapter on the Title List or Chapter List menu, then press ENTER (⊙). The menu options on the left side of the menu. Use ▼/▲ to select an option then press ENTER (⊙) to confirm your selection.
2. To exit the Title List menu, press RETURN (↵) repeatedly.

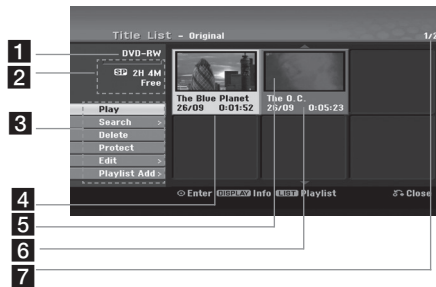

- 1 Current media.
- 2 Indicates the record mode, free space, and elapsed time progress bar.
- 3 Menu options: To display menu option, select a title or chapter then press ENTER (⊙). The options displayed differ depending on the disc type.

[Play] – Start playback of the selected title or chapter. The hidden titles and chapters on the DVD+R/RW cannot be played back.

[Search]

- [Chapter] : Displays Chapter List of the Title.
- [Time] : Search time for you want start point of the title.

[Delete] – Deletes the title or chapter. (page 55)

[Move] – Moves chapter position on [Chapter List - Playlist] menu (page 56).

[Protect] – Protects accidental recording, editing or deleting of the title.(page 57)

[Edit] – Edits or Deletes a part of the title.

- [Title Name] : Edits the title name. (page 55).
- [Delete Part] : Deletes a part of the Title (page 55).
- [Divide] : Divides a title into two (page 57).
- [Hide (Show)] : Hides (or Shows) the selected title or chapter. (page 56-57)

[Playlist Add] – Adds the title or chapter to the Playlist. (page 53)

[Title] – Displays Title List of the chapter.

[Combine] – Combines two chapters into one (page 58).

[Full Play] – Starts playback of the selected title including the hidden chapters.

- 4 Currently selected title.
- 5 Shows the selected title number and total number of titles.
- 6 Thumbnail.
- 7 Shows the title name, recorded date, and recording length.

VR Mode: Original and Playlist Editing

Titles, Chapters and Parts

Titles in the disc's original content contain one or more chapters. When you add a disc's title into the Playlist, all the chapters within that title also added. In other words, chapters in the Playlist behave exactly as chapters on original content. From the Original and Playlist menu you can add or delete parts. Adding a chapter or title to the Playlist creates a new title made up of a section (ie., chapter) of an Original title. Deleting a part removes part of a title from the Original or Playlist menu.



Caution

- When editing using the Delete, Add and Move functions, the start and end frames may not be exactly as set in the start and end point display.
- During Playlist playback, you may notice a momentary pause between edits. This is not a malfunction.

Is editing a DVD like editing a video tape?

No. When you edit a video tape you need one video deck to play the original tape and another to record the edits. With DVD, you edit by making a 'Playlist' of what to play and when to play it. On playback, the Recorder plays the disc according to the Playlist.

About word 'Original' and 'Playlist'

-RWvR

Throughout this manual, you will often see the words Original and Playlist to refer to the actual content and the edited version.

- **Original:** content refers to what's actually recorded on the disc.
- **Playlist:** content refers to the edited version of the disc — how the Original content is to be played.

Making a New Playlist

-RWvR

Use this function to add an Original title or chapter to the Playlist. When you do this, the whole title or chapter are put into the Playlist (you can delete bits you don't need later - see [Deleting an Original or Playlist title/chapter] on page 54).

The title appears in the Playlist complete with the chapter markers that appear in the Original. However, if you add more chapter markers to the Original later, these are not automatically copied over into the Playlist title.

1. Choose a title or chapter on the [Title List-Original] menu or [Chapter List-Original] menu to put into the Playlist, then press ENTER (⊙). The menu options appears on the left side of the menu.
2. Use ▼/▲ to select [Playlist Add] option then press ▶.

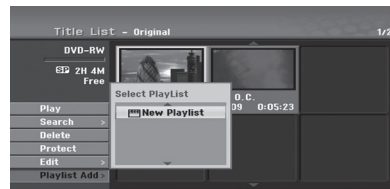

3. Select [New Playlist] then press ENTER (⊙). The new title appears in the updated Playlist. All chapters of the title are added to the Playlist.



Adding Additional Title / Chapters to the Playlist

-RWVR

You can add an Original title or chapter to add to a Playlist title even if it is already registered.

1. Choose a title or chapter on the [Title List-Original] menu or [Chapter List-Original] menu to put into the Playlist, then press ENTER (⊙). The menu options appears on the left side of the screen.
2. Use ▼/▲ to select [Playlist Add] from menu options then press ▶.



3. Choose a Title List-Playlist that is already registered to insert a title or chapter, then press ENTER (⊙).
4. Repeat steps 1-3 to add additional title or chapter on the Playlist. You can view the added chapters on the [Chapter List-Playlist] menu.



5. Press RETURN (↵) to exit, or MENU/LIST to go back to the [Title List-Original] menu.

Deleting an Original or Playlist Title/Chapter

When you erase a title or chapter from the Playlist menu, you only remove it from the Playlist; the title/chapter remains in the Original menu.

If you choose to delete a title or chapter from the Original (title/chapter) menu, the title or chapter is actually deleted from the disc and the remaining time available for recording increases. Titles/chapters deleted from the Original are also removed from the Playlist.

! Note

It may not be possible to delete chapters that are less than 3 seconds long.

1. Use ◀/▶/▼/▲ to choose a chapter or title you want to delete on the [Title List] or [Chapter List] menu then press ENTER (⊙). The menu options appears on the left side of the screen.
2. Select [Delete] option from the options on the menu.
Example: Title List (DVD-RW)



3. Press ENTER (⊙) to confirm. The confirm message for deleting will appear.
4. Use ◀/▶ to select [OK] then press ENTER (⊙). The selected chapter or title is deleted. After pressing ENTER (⊙), the new, updated menu is displayed.
5. Repeat steps 1 - 4 to continue to delete from the menu.
6. Press RETURN (↵) repeatedly to exit the menu.

! Note

- When DVD+RW recording, the deleted title's name is changed to [Deleted Title].
- If more than two titles are repeatedly deleted, the titles are combined into one.
- When you are deleting a title or chapter, only the last one on DVD+R/RW, DVD-RW (Video mode) increases remaining recording time.
- The Chapter delete function is only available on DVD-RW (VR mode).

Deleting a Part

-RWVR

You can delete a part which you do not want in the title.

- Use **◀/▶/▼/▲** to choose a title you want to delete on the Title List menu then press **ENTER (⊙)**.
The options appears on the left side of the menu.
- Select **[Edit] > [Delete Part]** option then press **ENTER (⊙)**.
[Edit] menu appears on the TV screen.
Example: Edit (Delete Part) (DVD-VR)



- Use play, pause step, search and slow-motion to find the starting point.
- Press **ENTER (⊙)** at the starting point of the section you want to delete.
[End Point] icon is highlighted.
The part is indicated on the Progress Bar.
- Use play, pause step, search and slow-motion to find the ending point.
- Press **ENTER (⊙)** at the ending point of the section you want to delete.
You can cancel the selected point, use **▼/▲** to select [Cancel] icon then press **ENTER (⊙)**.
- If you finish to edit, select [Done] icon then press **ENTER (⊙)**.
The confirm message for deleting will appear.
Use **◀/▶** to select [OK] then press **ENTER (⊙)**.
The selected part is deleted from the title and Title List menu appears.

! Note

- It may not be possible to delete parts that are less than 3 seconds long.
- If you select [Cancel] then press **ENTER (⊙)**, the Recorder will go to previous option and into Pause mode.

Naming a Title

-RWVR **-RWVideo** **+RW** **-R** **+R**

You can name the titles.

- Choose the title you want to name on the Title List menu, then press **ENTER (⊙)**.
The menu options appears on the left side of the menu.
- Use **▼/▲** to select **[Edit] > [Title Name]** option then press **ENTER (⊙)**.
Keyboard menu appears.



- Enter a name for the title. Use **◀/▶/▼/▲** to select a character then press **ENTER (⊙)** to confirm your selection.

[Language] – Selects a keyboard type.

[Space] – Inserts a space at the cursor position.

[Delete] – Deletes the character to the left of the cursor position.

[◀/▶] – Moves the cursor left or right.

[OK] – Confirms the name you have entered.

[Cancel] – Deletes all characters and exits the Keyboard menu.

! Note

Remote Control buttons for entering a name

- ▶ (PLAY):** Inserts a space at the cursor position.
- ⏸ (PAUSE/STEP):** Deletes the character to the right of the cursor position.
- ⏮ (SKIP (◀◀/▶▶)):** Moves the cursor left or right.
- ◀ (STOP), CLEAR:** Deletes the character to the left of the cursor position.
- 0-9:** Enters the character corresponding to the selected column.
- MENU/LIST, DISPLAY:** Switches the keyboard type.provider.

- Choose [OK] then press ENTER (⊙) to fix the name and return to the previous menu screen.
- Press RETURN (↵) repeatedly to exit the menu.

Note

- Names can be up to 32 characters long.
- For discs formatted on a different recorder, you will see only a limited character set.
- When recording on DVD-R, DVD-RW or DVD+R discs, the entered name is displayed on the u unit only after finalization.

Time Search



You can select start point of the title.

- Choose Use ◀/▶/▼/▲ to choose a title on the Title List menu then press ENTER (⊙). The options appears on the left side of the menu.
- Choose Select [Search] > [Time] option then press ENTER (⊙). [Time] menu appears on the TV screen.

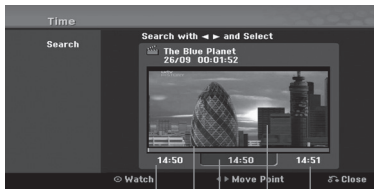

Start time |
 Selected point |
 Selected time |
 Current picture |
 End time |

- Choose Use ◀/▶ to find the point you want to start. The point increase 1 minute step. If you press and hold ◀/▶ then the point increase 5 minute step.
- Choose Press ENTER (⊙) to start selected point.

Moving a Playlist Chapter



Use this function to re-arrange the playing order of Playlist chapters on the Chapter List-Playlist menu.

Note

This function is not available if there is only one chapter.

- Select a chapter on the Chapter List-Playlist menu.
- Press ENTER (⊙). The menu options appears on the left side of the menu.
- Use ▼/▲ to select [Move] option from Playlist options then press ENTER (⊙).



- Use ◀/▶/▼/▲ to choose the place you want to move the chapter then press ENTER (⊙). After pressing ENTER (⊙), the updated menu is displayed.

Hide a Chapter/Title



You can skip playing chapters or titles without deleting from the disc.

- Use ◀/▶/▼/▲ to choose a chapter or title you want to hide on the [Title List] or [Chapter List] menu, then press ENTER (⊙). Options appear on the left side of the screen.
- Select [Edit] > [Hide] option. Example: Title List (DVD+RW)



4 Operating

- Press ENTER (⊙) to confirm.
The chapter's or title's thumbnail will dim.

! Note

- If you select a hidden chapter or title on the Title List or Chapter List menu, you can 'show' it by choosing [Show] option on the menu. After doing that, you are able to see the chapter or title.
- You can play hidden chapter or title using [Full Play] option in the menu.

Protect a Title

-RWVR **+RW** **-R** **+R**

Use this function to protect against accidental recording, editing or deleting of the title.

- Press MENU/LIST to display the [Title List] menu.
- Use ◀/▶/▼/▲ to choose a title you want to protect then press ENTER (⊙).
Options appear on the left side of the screen.
- Select [Protect] from the options.
Example: Title List (DVD-R)



- Press ENTER (⊙) to confirm.

! Note

If you select a title that has already been protected on the Title List menu, you can 'unprotect' it by choosing [Unprotect] option from the Title List menu options. After doing that, you can edit and delete the title.

Divide One Title Into Two

+RW

Use this command to split a title up into two new titles.

- On the Title List menu, select a title you want to divide then press ENTER (⊙).
The menu options appears on the left side of the screen.
- Select [Edit] > [Divide] option.
Example: Title List (DVD+RW)



- Press ENTER (⊙).
[Edit (Divide)] menu appears.

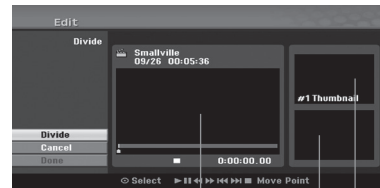

Current picture |
The second title's thumbnail |
The first title's thumbnail |

- Use play, pause step, search and slow-motion to find the point you want to divide the title.
- Select [Divide] option then press ENTER (⊙) at the point.
To reset the point, select [Cancel] option then press ENTER (⊙). Repeat from step 4.
- Choose [Done] option then press ENTER (⊙) to fix the dividing point.
The title is divided into two new titles. It take up to 6 minutes to divide.

! Note

The dividing point may not be selected if the point is less than 3 seconds long.

Combining Two Chapters Into One

-RW/VR

+RW

+R

Use this function to combine two adjacent chapters into one.

- On the Chapter List menu, select the second chapter of the two chapters you want to combine then press ENTER (⊙).
The menu options appears on the left side of the screen.
- Use ▼/▲ to select [Combine] option.
The combine indicator appears between the two chapters you want to combine.
Example: Title List (DVD-VR)



- Press ENTER (⊙) to combine the chapters.
- Repeat steps 1 - 3 to continue to combine from the menu.
- Press ↵ (RETURN) repeatedly to exit the menu.

! Note

This function cannot operate listed as below;

- If there is only one chapter within the title.
- If you select first chapter.
- If two chapters created by erasing a part from an original title.
- If two chapters created from different titles.
- If two chapters created by moving an order from an original title.

Overwriting Recording

+RW

To overwrite a new video recording on a previously recorded title, follow these steps. This feature is not available for DVD+RW, that always record at the end of the Disc.

- Select input source you want to record (TV channel, AV1, AV2, DV).
- Press MENU/LIST to display the Title List menu.

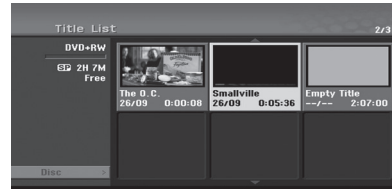

- Use ▼/▲/◀/▶ to choose a title you want to overwrite.
- Press ● (REC) to start overwrite recording.
Overwrite recording starts from the start point of the title.
- Press ■ (STOP) to stop the overwrite recording.
The new title is created and updated menu is displayed.

! Note

- This function is not available for a protected title.
- If you overwrite the longer recording than the current title on the fully recorded disc, the next title is overwritten.
- If next title is protected, the overwriting stops at the starting point of the title.

Viewing Title List menu displayed on other DVD Recorders or Players

+RW **+R**

You can view the Title List menu displayed on the other DVD player that is capable of playing DVD+RW or DVD+R discs.

1. Insert DVD+R or DVD+RW disc recorded already.
2. On DVD mode, press TITLE in Play mode or Stop mode.

Title List menu will appear as shown below.



3. To play back a title, select the title you want then press ENTER (⊙) or ► (PLAY).

! Note

You can remove the Title List menu by pressing ■ (STOP).

! Note

- Unfinalized DVD+RW is playable on regular units.
- The edited contents of a DVD+R (DL) disc are compatible on regular DVD players only after finalization.
- Any edited contents of the DVD+R (DL) disc are not compatible on regular units. (Hide, chapter combine, added chapter mark, etc.)
- How long finalization takes depends on the type of disc, how much is recorded on the disc, and the number of titles on the disc.
- DVD+R (DL) disc can take up to 30 minutes to finalize.

Playing Your Recordings on Other DVD Players (Finalizing a Disc)

Most regular DVD players can play finalized discs recorded in Video mode, finalized DVD+R or DVD+RWs. A small number of players can also play DVD-RW discs recorded in VR mode, finalized or not. Check the manual that came with the other player to check what formats of discs it will play.

Finalizing 'fixes' the recordings and editings in place so that the disc can be played on a regular DVD player or computer equipped with a suitable DVD-ROM drive.

Finalizing a Video mode disc creates a menu screen for navigating the disc. The menu can be accessed by pressing MENU/LIST or TITLE. To finalize a disc, refer to [Finalize] on page 31.

Dubbing

Dubbing from VCR to DVD

You can copy the contents of a Video tape to a DVD using the DUBBING button. This allows you to archive your old Video tapes to DVD.

1. Insert a blank DVD disc in the DVD deck and close the disc tray.
2. Insert the video tape you wish to copy into the VCR deck.
3. Select VCR mode by pressing VCR on the remote control or pressing DVD/VCR on the front panel.
4. Find the place on the Video tape from which you want to start dubbing using the PLAY, FF, REW and PAUSE functions. For best results, pause playback at the point from which you want to record.
5. Press the DUBBING button.
The Dubbing popup appears.

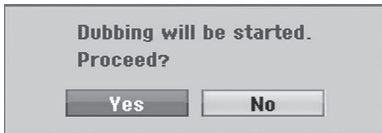

6. Use ◀/▶ to select [YES] then press ENTER (⊙)
7. To stop dubbing at any other time, press ■ (STOP).
Dubbing will stop automatically when the Video tape ends.

! Note

If you press PAUSE during Dubbing mode, both the DVD and VCR decks go into Pause mode. While in Pause mode, you can adjust the VCR playback position using PLAY, REW, FF, PAUSE/STEP, etc. The DVD deck will remain in Pause mode. To resume Dubbing.

Recording from DV Input

Before DV dubbing

You can connect a DV-equipped camcorder to this recorder using a single DV cable for input and output of audio, video, data and control signals.

- This recorder is only compatible with DV-format (DVC-SD, DV25) camcorders. Digital satellite tuners and Digital VIDEO video recorders are not compatible.
- You cannot connect more than one DV camcorder at a time to this recorder.
- You cannot control this recorder from external equipment connected via the DV IN jack (including two recorders).
- It may not always be possible to control the connected camcorder via the DV IN jack.
- Digital camcorders can usually record audio as stereo 16-bit/48kHz, or twin stereo tracks of 12-bit/32kHz. This recorder can only record one stereo audio track. Set [DV Rec Audio] option to Audio 1 or Audio 2 as required (see page 30).
- Audio input to the DV IN jack should be 32 or 48kHz (not 44.1kHz).
- Picture disturbance on the recording may occur if the source component pauses playback or plays an unrecorded section of tape, or if the power fails in the source component, or the DV cable becomes disconnected.

Recording from a Digital Camcorder

You can record from a digital camcorder connected to the DV IN jack on the front panel of this recorder. Using the recorder's remote, you can control both the camcorder and this recorder.

Before recording, make sure that the audio input for the DV IN jack is set up (see page 30).

! Note

- The source signal must be DVC-SD format.
- Some camcorders cannot be controlled using this recorder's remote.
- If you connect a second DVD Recorder using a DV cable, you cannot control the second DVD Recorder from this one.
- You can't control this unit remotely from a component connected to the DV IN jack.
- You can't record date and time information from a DV cassette.

1. Make sure your digital camcorder is connected to the front panel DV IN jack. See page 18.
2. Check that the DV audio input is as you require. You can choose between Audio 1 (original audio) and Audio 2 (overdubbed audio).
 - DV Input is set from the DV Rec Audio in sub-menu of the Setup menu. See DV Rec Audio on page 30 for more information.
3. Press AV/INPUT repeatedly to select the DV input. DV appears in the display window.
4. Find the place on the camcorder tape that you want to the recording to start from. For best results, pause playback at the point from which you want to record.
 - Depending on your camcorder, you can use this recorder's remote to control the camcorder using the STOP, PLAY and PAUSE functions.
5. Press ● (REC) once to start recording.
 - Recording is automatically stopped if the recorder detects no signal.
 - You can pause or stop the recording by pressing ■ (PAUSE/STEP) or ■ (STOP). You cannot control the camcorder from this remote control during recording.
 - In Video mode, the final frame of the recording may remain displayed on screen for a while after recording stops.

DV-Related Messages

You may see the following messages appear on your TV screen when using the DV IN jack.

- Not connected to Camcorder.
The camcorder is not connected properly, or the camcorder is switched off.
- Too many devices connected.
The DV jack on this recorder supports connection to just one camcorder.
- Check the tape.
There is no cassette loaded into the connected equipment.
- Uncontrollable device.
This recorder cannot control the camcorder.
- Updating the information.
Camcorder is updating the information for DV.
- Camera mode.
Camcorder is set to camera mode.

Troubleshooting

General

Symptom	Cause & Solution
The Power does not turned on.	<ul style="list-style-type: none"> • Plug the power cord into the wall outlet securely.
The unit does not start playback.	<ul style="list-style-type: none"> • Insert a playable disc. (Check the disc type, color system, and regional code.) • Place the disc with the playback side down. • Place the disc on the disc tray correctly inside the guide. • Clean the disc. • Cancel the Rating function or change the rating level.
The angle cannot be changed.	<ul style="list-style-type: none"> • Multi-angles are not recorded on the DVD Video being played. • The angle cannot be changed for the titles recorded on this unit.
Cannot play movie, photo or audio files.	<ul style="list-style-type: none"> • The files are not recorded in a format that the unit can play. • The unit does not support the codec of the movie file.
The channel is not found or stored.	<ul style="list-style-type: none"> • Check your antenna connection.
The remote control does not work properly.	<ul style="list-style-type: none"> • The remote control is not pointed at the remote sensor of the unit. • The remote control is too far from the unit. • There is an obstacle in the path between the remote control and the unit. • The batteries in the remote control are exhausted. • The remote's manufacturer code returned to the default setting when you replaced the batteries. Reset the code (page 65).

Resetting the unit

Symptom	Cause & Solution
If you observe any of the following symptoms.	<ul style="list-style-type: none"> • The unit is plugged in, but the power will not turn on or off. • The front panel display is not working. • The unit is not operating normally.
You can reset the unit as follows.	<ul style="list-style-type: none"> • Press and hold the POWER (⏻) button for at least five seconds. This will force the unit to power off then turn the unit back on. • Unplug the power cord, wait at least five seconds, and then plug it in again.

Playback

Symptom	Cause & Solution
Cannot play a disc recorded using this unit on other player.	<ul style="list-style-type: none"> Finalize the disc (see page 31). Check the disc compatibility of the player. Place the disc on the disc tray correctly inside the guide. Discs recorded with copy-once material cannot be played on other players.
The subtitle language cannot be changed or turned off.	<ul style="list-style-type: none"> Subtitles are not recorded on the DVD Video being played. The subtitle cannot be changed for the titles recorded on this unit.
Cannot play MP3/WMA/JPEG/MPEG4 files.	<ul style="list-style-type: none"> The files are not recorded in a format that the unit can play. The unit does not support the codec of the MPEG4 movie file. The resolution is higher than the unit can support.

Recording

Symptom	Cause & Solution
Cannot record or does not record successfully.	<ul style="list-style-type: none"> Check the remaining space on the disc. If your source is copy-protected, you cannot record it using this unit. Use a VR mode formatted disc for copy-once material. Video that is 'copy-once only' can only be recorded using a DVD-RW disc in VR mode disc with CPRM. The power may have failed during recording. In DVD mode, you cannot record the rated digital program, no signal, audio only, scrambled program, etc. If the unit detects an unrecordable signal as described above during recording, the recording will be paused. The recording will be continued when recordable signal is detected in pause mode. If the paused recording is continued for an hour, the recording will be stopped automatically with the message. If you set a DTV rating for the unit and higher rated digital programs are received, the program cannot be recorded. Change the DTV rating level in order to record it.
Timer record does not record successfully.	<ul style="list-style-type: none"> Clock is not set to correct time. The start time of the timer recording is past. Two timer recordings may have overlapped, in which case only the earlier one will record completely. When setting the recording programme, make sure you set the recorder's built-in tuner, not the TV's built-in tuner. If the inserted disc is damaged, the recording may not complete successfully.

Stereo Audio Record and/ Playback is not present.	<ul style="list-style-type: none"> • TV is not Stereo-compatible. • Broadcast programme is not in stereo format. • The A/V Output jacks on the unit are not connected to TV A/V In jacks.
Even though the timer is set, the recorder will not record when.	<ul style="list-style-type: none"> • There is no disc loaded. • A non-recordable disc is loaded. • Disc Protect is set to [ON] in the Disc menu (see page 32). • There are already 99 titles (DVD-RW, DVD-R), 49 titles (DVD+RW, DVD+R(DL)) recorded on the disc.
You cannot enter a timer programme when.	<ul style="list-style-type: none"> • A recording is already underway. • The time you're trying to set has already passed. • There are already 16 timer programs set.
If two or more timer programs overlap.	<ul style="list-style-type: none"> • The earlier programme takes priority. • When the earlier program finishes, the later program starts. • If two programs are set to start at exactly the same time, the program entered first takes priority. If the disc is damaged, the recording may not complete successfully. In this case even though the Check field shows [Rec. OK], it may not be

HDMI

Symptom	Cause & Solution
The connected HDMI device does not display any picture.	<ul style="list-style-type: none"> • Try disconnecting then reconnecting the HDMI cable. • Try switching the power of the HDMI device off then back on. • The video input of the connected device is set correctly for this unit. • The HDMI cable you are using is fully HDMI-compliant. Using a non-standard cable may result in no picture being output. • Not all HDCP-compatible DVI devices will work with this unit.
The connected HDMI device does not output sound.	<ul style="list-style-type: none"> • Some HDMI-compatible devices do not output sounds (check the manual that came with the connected device). • If your TV is not capable of handling 96 kHz sampling frequency, set the [Sampling Freq.] option to [48 kHz] on the setup menu. When this choice is made, this unit will automatically convert any 96 kHz signals to 48 kHz so your system can decode them. • If your TV is not equipped with Dolby Digital and MPEG decoder, set the [Dolby Digital] and [MPEG] options to [PCM] on the setup menu. • If your TV is not equipped with DTS decoder, set the [DTS] options to [OFF] on the setup menu. To enjoy DTS multi channel surround, you must connect this unit to a DTS compatible receiver via one of this unit's digital audio outputs.

Controlling a TV with the Supplied Remote Control

You can control your TV using the buttons below.

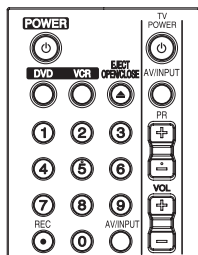

By pressing	You can
(TV POWER)	Turn the TV on or off.
AV/INPUT	Switch the TV's input source between the TV and other input sources.
PR/TRK (+/-)	Scan up or down through memorized channels.
VOL +/-	Adjust the volume of the TV

Note

Depending on the unit being connected, you may not be able to control your TV using some of the buttons.

Setting up the remote to control your TV

You can operate your TV with the supplied remote control.

If your TV is listed in the table below, set the appropriate manufacturer code.

1. While holding down (TV POWER) button, and press the manufacturer code for your TV with the numerical buttons (see the table below).

Manufacturer	Code Number
LG	1(Default), 2
Zenith	1, 3, 4
GoldStar	1, 2
Samsung	6, 7
Sony	8, 9
Hitachi	4

2. Release the (TV POWER) button to complete setting.

Depending on your TV, some or all buttons may not function on the TV, even after entering the correct manufacturer code. When you replace the batteries of the remote, the code number you have set may be reset to the default setting. Set the appropriate code number again.

Area Code List

Choose an area code from this list.

Area	Code	Area	Code	Area	Code	Area	Code
Afghanistan	AF	Fiji	FJ	Monaco	MC	Singapore	SG
Argentina	AR	Finland	FI	Mongolia	MN	Slovak Republic	SK
Australia	AU	France	FR	Morocco	MA	Slovenia	SI
Austria	AT	Germany	DE	Nepal	NP	South Africa	ZA
Belgium	BE	Great Britain	GB	Netherlands	NL	South Korea	KR
Bhutan	BT	Greece	GR	Antilles	AN	Spain	ES
Bolivia	BO	Greenland	GL	New Zealand	NZ	Sri Lanka	LK
Brazil	BR	Hong Kong	HK	Nigeria	NG	Sweden	SE
Cambodia	KH	Hungary	HU	Norway	NO	Switzerland	CH
Canada	CA	India	IN	Oman	OM	Taiwan	TW
Chile	CL	Indonesia	ID	Pakistan	PK	Thailand	TH
China	CN	Israel	IL	Panama	PA	Turkey	TR
Colombia	CO	Italy	IT	Paraguay	PY	Uganda	UG
Congo	CG	Jamaica	JM	Philippines	PH	Ukraine	UA
Costa Rica	CR	Japan	JP	Poland	PL	United States	US
Croatia	HR	Kenya	KE	Portugal	PT	Uruguay	UY
Czech Republic	CZ	Kuwait	KW	Romania	RO	Uzbekistan	UZ
Denmark	DK	Libya	LY	Russian Federation	RU	Vietnam	VN
Ecuador	EC	Luxembourg	LU	Saudi Arabia	SA	Zimbabwe	ZW
Egypt	EG	Malaysia	MY	Senegal	SN		
El Salvador	SV	Maldives	MV				
Ethiopia	ET	Mexico	MX				

Language code List

Use this list to input your desired language for the following initial settings: [Disc Audio], [Disc Subtitle] and [Disc Menu].

Language	Code	Language	Code	Language	Code	Language	Code
Afar	6565	French	7082	Lithuanian	7684	Sindhi	8368
Afrikaans	6570	Frisian	7089	Macedonian	7775	Singhalese	8373
Albanian	8381	Galician	7176	Malagasy	7771	Slovak	8375
Ameharic	6577	Georgian	7565	Malay	7783	Slovenian	8376
Arabic	6582	German	6869	Malayalam	7776	Spanish	6983
Armenian	7289	Greek	6976	Maori	7773	Sudanese	8385
Assamese	6583	Greenlandic	7576	Marathi	7782	Swahili	8387
Aymara	6588	Guarani	7178	Moldavian	7779	Swedish	8386
Azerbaijani	6590	Gujarati	7185	Mongolian	7778	Tagalog	8476
Bashkir	6665	Hausa	7265	Nauru	7865	Language	Code
Basque	6985	Hebrew	7387	Nepali	7869	Tajik	8471
Bengali; Bangla	6678	Hindi	7273	Norwegian	7879	Tamil	8465
Bhutani	6890	Hungarian	7285	Oriya	7982	Telugu	8469
Bihari	6672	Icelandic	7383	Panjabi	8065	Thai	8472
Breton	6682	Indonesian	7378	Pashto, Pushto	8083	Tonga	8479
Bulgarian	6671	Interlingua	7365	Persian	7065	Turkish	8482
Burmese	7789	Irish	7165	Polish	8076	Turkmen	8475
Byelorussian	6669	Italian	7384	Portuguese	8084	Twi	8487
Chinese	9072	Japanese	7465	Quechua	8185	Ukrainian	8575
Croatian	7282	Kannada	7578	Rhaeto-Romance	8277	Urdu	8582
Czech	6783	Kashmiri	7583	Rumanian	8279	Uzbek	8590
Danish	6865	Kazakh	7575	Russian	8285	Vietnamese	8673
Dutch	7876	Kirghiz	7589	Samoan	8377	Volapük	8679
English	6978	Korean	7579	Sanskrit	8365	Welsh	6789
Esperanto	6979	Kurdish	7585	Scots Gaelic	7168	Wolof	8779
Estonian	6984	Laothian	7679	Serbian	8382	Xhosa	8872
Faroese	7079	Latin	7665	Serbo-Croatian	8372	Yiddish	7473
Fiji	7074	Latvian, Lettish	7686	Shona	8378	Yoruba	8979
Finnish	7073	Lingala	7678			Zulu	9085

Trademarks and Licenses



Manufactured under license from Dolby Laboratories. Dolby and the double-D symbol are trademarks of Dolby Laboratories.



HDMI, the HDMI logo and High-Definition Multimedia Interface are trademarks or registered trademarks of HDMI licensing LLC.



"DVD Logo" is a trademark of DVD Format/Logo Licensing Corporation.



DivX®, DivX Certified® and associated logos are trademark of DivX, Inc., and are used under license.

Specifications

General	
Power requirements	AC 200-240 V, 50/60 Hz
Power consumption	23 W
Dimensions (W x H x D)	Approx. 430 x 78.5 x 260 mm (w x h x d)
Net Weight (Approx.)	4.2 kg
Operating temperature	5 °C to 35 °C (41 °F to 95 °F)
Television system	Analog: PAL B/G colour system Digital: DVB-T Standard Compliant
Operating humidity	5 % to 90 %

Recording	
Recording format	DVD Video Recording, DVD-VIDEO
Recordable media	DVD-RW, DVD-R, DVD+RW, DVD+R, DVD+R(Double Layer)
Recordable time	DVD (4.7GB): Approx. 1 hours (XP mode), 2 hours (SP mode), 4 hours (LP mode), 6 hours (EP mode), 14 hours (MLP mode) DVD+R DL (8.5GB): Approx. 3 hours (XP mode), 3.8 hours (SP mode), 7.3 hours (LP mode), 9.1 hours (EP mode), 21 hours (MLP mode)
Video recording format	Sampling frequency: 27MHz, Compression format: MPEG2
Audio recording forma	Sampling frequency: 48kHz, Compression format: Dolby Digital

Input	
ANTENNA IN	Digital and Analog, 75 ohms
VIDEO IN	1.0 Vp-p 75 ohms, sync negative, RCA jack x 1
AUDIO IN	2.0 Vrms more than 47 kohms, RCA jack (L, R) x 1
DV IN	4 pin (IEEE 1394 standard)

Outputs	
COMPONENT VIDEO OUT	(Y) 1.0 V (p-p), 75 Ω, sync negative, RCA jack x 1 (Pb)/(Pr) 0.7 V (p-p), 75 Ω, RCA jack x 2
HDMI OUT (video/audio)	19 pin (HDMI standard, Type A)
ANALOG AUDIO OUT	2.0 Vrms (1 kHz, 0 dB), 600 Ω, RCA jack (L, R) x 1
DIGITAL IN (OPTICAL/COAXIAL)	3 V (p-p), Optical jack x 1 / 0.5 V (p-p), 75 Ω, RCA jack x 1

System	
Signal system	Standard PAL color TV system
Frequency response	20 Hz to 20 kHz (48 kHz, 96 kHz, 192 kHz sampling)
Signal-to-noise ratio	More than 100 dB (ANALOG OUT connectors only)
Harmonic distortion	Less than 0.008%
Dynamic range	More than 95 dB
Bus Power Supply (USB)	DC 5 V  500 mA

- Design and specifications are subject to change without notice.

Maintenance

Handling the Unit

When shipping the unit

Please save the original shipping carton and packing materials. If you need to ship the unit, for maximum protection, re-pack the unit as it was originally packed at the factory.

Keeping the exterior surfaces clean

- Do not use volatile liquids such as insecticide spray near the unit.
- Wiping with strong pressure may damage the surface.
- Do not leave rubber or plastic products in contact with the unit for a long period of time.

Cleaning the unit

To clean the player, use a soft, dry cloth. If the surfaces are extremely dirty, use a soft cloth lightly moistened with a mild detergent solution. Do not use strong solvents such as alcohol, benzene, or thinner, as these might damage the surface of the unit.

Maintaining the Unit

The unit is a high-tech, precision device. If the optical pick-up lens and disc drive parts are dirty or worn, the picture quality could be diminished. For details, please contact your nearest authorized service center.

Notes on Discs

Handling Discs

Do not touch the playback side of the disc. Hold the disc by the edges so that fingerprints do not get on the surface. Never stick paper or tape on the disc.

Storing Discs

After playing, store the disc in its case. Do not expose the disc to direct sunlight or sources of heat and never leave it in a parked car exposed to direct sunlight.

Cleaning Discs

Fingerprints and dust on the disc can cause poor picture quality and sound distortion. Before playing, clean the disc with a clean cloth. Wipe the disc from the center to out.

Do not use strong solvents such as alcohol, benzene, thinner, commercially available cleaners, or anti-static spray intended for older vinyl records.

