



OWNER'S MANUAL SMART CAR AUDIO

Please read this manual carefully before operating your set and retain it for future reference.

LCF620IP



ENGLISH

DEUTSCH

FRANÇAIS

ESPAÑOL

ITALIANO

PORTUGUÊS

EMHNIKA

Safety Information



CAUTION: TO REDUCE THE RISK OF ELECTRIC SHOCK DO NOT REMOVE COVER (OR BACK) NO USER-SERVICEABLE PARTS INSIDE REFER SERVICING TO QUALIFIED SERVICE PERSONNEL.

 This lightning flash with arrowhead symbol within an equilateral triangle is intended to alert the user to the presence of uninsulated dangerous voltage within the product's enclosure that may be of sufficient magnitude to constitute a risk of electric shock to persons.

 The exclamation point within an equilateral triangle is intended to alert the user to the presence of important operating and maintenance (servicing) instructions in the literature accompanying the product.

WARNING: TO PREVENT FIRE OR ELECTRIC SHOCK HAZARD, DO NOT EXPOSE THIS PRODUCT TO RAIN OR MOISTURE.

WARNING: Do not install this equipment in a confined space such as a book case or similar unit.

 Always operate the vehicle in a safe manner. Do not become distracted by the vehicle while driving, and always be fully aware of all driving condition. Do not change settings,

or any functions. Pull over in a safe and legal manner before attempting such operations.

 Do not use for many hours at extremely low or high temperature. (-10 °C to 60 °C)

 To reduce the risk of electric shock, do not remove the cover or back of this product. There are no user-serviceable parts inside. Refer servicing to qualified service personnel.

 To reduce the risk of fire or electric shock, do not expose this product to dripping or splashing water, rain, or moisture.

 The temperature of unit's outside can be extremely high, please use the unit after proper installation in your vehicle.

 This unit cannot play 8 cm disc (use 12 cm disc only).

 While driving, keep the sound volume at a proper level.

 Do not drop it and avoid heavy impacts at anytime.

 This unit is for vehicles with a 12-volt battery and negative grounding. Before installing it in a recreational vehicle, lorry or bus, check the battery voltage. To avoid shorts in the electrical system, be sure to disconnect the E battery cable before beginning the installation.



CAUTION: This product employs a Laser System. To ensure proper use of this product, please read this owner's manual carefully and retain it for future reference. Shall the unit require maintenance, contact an authorized service centre.

Use of controls, adjustments or the performance of procedures other than those specified herein may result in hazardous radiation exposure. To prevent direct exposure to laser beam, do not try to open the enclosure.

This device is equipped with a portable battery or accumulator.

Safe way to remove the battery or the battery from the equipment:

Remove the old battery or battery pack, follow the steps in reverse order than the assembly. To prevent contamination of the environment and bring on possible threat to human and animal health, the old battery or the battery put it in the appropriate container at designated collection points. Do not dispose of batteries or battery together with other waste. It is recommended that you use local, free reimbursement systems batteries and accumulators. The battery shall not be exposed to excessive heat such as sunshine, fire or the like.

Disposal of waste batteries/ accumulators

1. When this crossed-out wheeled bin symbol is attached to batteries/accumulators of Your product it means they are covered by European Directive 2006/66/EC.
2. This symbol may be combined with chemical symbols for mercury(Hg), cadmium(Cd) or lead(Pb) if the battery Contains more that 0.0005% of mercury, 0.002% of cadmium or 0.004% of lead.
3. All batteries/accumulators should be disposed separately from the municipal waste stream via designated collection facilities appointed by the government or the local authorities.
4. The correct disposal of Your old batteries/accumulators will help to prevent potential negative consequences for the environment, animal and human health.
5. For more detailed information about disposal of Your old batteries/accumulators, please contact Your city office, waste disposal service or the shop where You purchased the product.

Disposal of your old appliance

1. When this crossed-out wheeled bin symbol is attached to a product it means the product is covered by the

European Directive 2002/96/EC.

2. All electrical and electronic products shall be disposed of separately from the municipal waste stream via designated collection facilities appointed by the government or the local authorities.

3. The correct disposal of your old appliance will help prevent potential negative consequences for the environment and human health.

4. For more detailed information about disposal of your old appliance, please contact your city office, waste disposal service or the shop where you purchased the product.



LG Electronics hereby declares that this/these product(s) is/are in

compliance with the essential requirements and other relevant provisions of Directive 2004/108/EC, 2006/95/EC and 2009/125/EC.

European Standards Centre:

Krijgsman 1, 1186 DM Amstelveen The Netherlands

- Please note that this is NOT a Customer Service contact point. For Customer Service Information, see Warranty Card or contact the dealer that you purchased this product.

Table of Contents**1 Getting Started**

- 2 Safety Information
- 4 Front panel
- 4 Remote control
- 5 – Battery Installation

2 Connecting

- 5 Installation
- 5 – Basic Installation
- 5 – Removing the existing receiver unit
- 5 – ISO-DIN Installation
- 6 About detachable control panel
- 7 Connection
- 7 – Connecting to a car

3 Operating

- 8 Operation
- 8 – Basic operations
- 8 – Turning off the sound temporarily
- 8 – Using EQ (Equalizer)
- 8 – Using 3D SOUND
- 8 – Checking the clock

- 8 – Turning off the display light
- 8 – Resetting the unit
- 8 – Adjusting the general settings
- 9 Listening to a CD
- 9 – Pausing or restarting CD playback
- 9 – Searching for a section within a track / file
- 9 – Skipping to another track/ file
- 9 – Checking information about your music
- 9 – Playing back tracks / files in a way you want
- 10 Listening to music from an external device
- 10 – Preventing radical changes in volume as switching sources
- 10 Listening to the radio
- 10 – Storing desired frequencies manually
- 11 – Listening to a preset station
- 11 – Adjusting TUNER settings
- 12 Using a USB device
- 12 – Moving to another drive
- 12 – Quick search of a desired file
- 12 – Playable USB device Requirement
- 12 – Recording to USB device
- 12 Listening to music by connecting iPod / iPhone
- 12 – Pausing or restarting playback
- 12 – Searching for a section within a file
- 12 – Skipping to another file
- 13 – Checking information about your music
- 13 – Playing back files in a way you want
- 13 – Playing back files by music menus
- 13 – iPod / iPhone CONTROL MODE
- 13 – Compatible iPod / iPhone models

4 Troubleshooting

- 14 Troubleshooting

5 Appendix

- 15 Specifications

1

2

3

4

5

Front panel

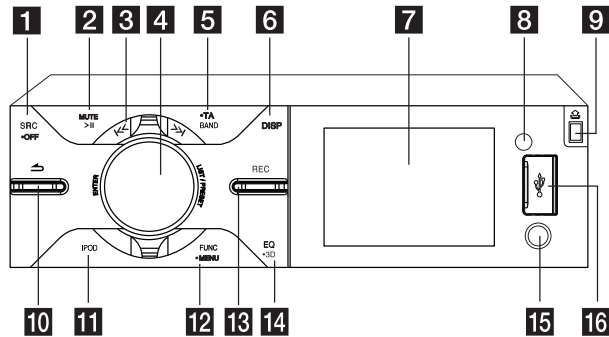

- 1 SRC / • OFF**
- When pressed, selects function sources.
- When pressed and held, powers unit on or off.
- 2 >||**
Plays and pauses playback.
MUTE
Temporarily stops the sound.
- 3 |<< / >>|**
Skip / Search / Seek / Tune
- 4 ENTER / LIST / PRESET (Volume knob)**
- Adjusts volume level.
- Confirms the settings.
- Checks tracks, files or preset stations.
- 5 BAND**
- Selects a band in Tuner mode.
- Moves to a next USB drive.
- **TA** (Optional)
- Searches stations that have TA / TP information, when it is pressed and held.
- 6 DISP**
- Press it, you can check the clock time.
- Press and hold it, you can turn on/off the display window and the light of LED buttons.
- 7** Display window
- 8** Remote Sensor
- 9** Opens the front panel.

- 10** Returns to the previous step.
- 11 iPod**
Activates iPod/iPhone CONTROL MODE.
- 12 FUNC**
In each mode, sets playback items.
- **• MENU**
Activates setting menu.
- 13 REC**
Recording to USB.
- 14 EQ / • 3D**
Improves sound quality.
- When pressed, selects the EQ function.
- When pressed and held, selects the 3D SOUND function.
- 15 AUX**
If connected to other portable player, you can enjoy music from it on the unit.
- 16 USB port**

Remote control

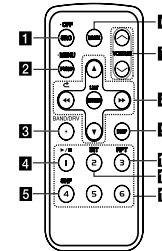

- 1 SRC / • OFF**
- When pressed, selects function sources.
- When pressed and held, powers unit off.
- 2 FUNC**
When pressed, sets playback items in each mode.
- **• MENU**
When pressed and held, activates setting menu.
- 3 BAND**
Selects a band in Tuner mode.
DRV
Moves to a next USB drive.
- 4 ▶ / ||** Plays or pauses playback.
- 5 SHF** Shuffles playback.
- 6 MUTE** Temporarily stops the sound.
- 7 VOLUME ▲ / ▼**
Adjusts volume level.

8 ◀◀ ▶▶

Skip / Search / Seek / Tune



Returns to the previous step.



- List up / down
- Adjusts settings.
- Moves 10 MP3 / WMA tracks backward or forward if there is no folder or one folder on a CD/ USB.
- Moves to the previous or next folder if there are more than 2 folders on a CD/ USB.

ENTER / LIST

- Confirms the settings.
- Checks tracks, files or preset stations.

9 DISP

- Press it, you can check the clock time.
- Press and hold it, you can turn on/off the display window and the light of LED buttons.

10 RPT

Repeats playback.

11 INT

Intro scan.

12 Numeric buttons (1 to 6)

Selects a numbered preset station in TUNER.

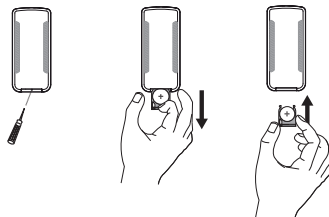
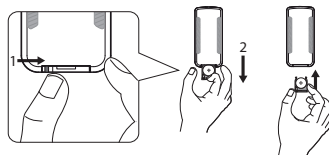
Battery Installation**Type 1****Type 2****Note**

- Use only one CR2025 (3 V) lithium battery.
- Remove the battery if the remote control is not used for a long period of time.
- Do not leave the product in a hot or humid place.
- Do not handle the battery with metallic tools.
- Do not store the battery with metallic materials.

Installation**Basic Installation**

Before installing, make sure that the ignition-switch is set to OFF and remove the terminal of the car battery to avoid short-circuiting.

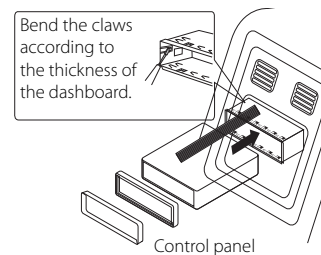

1. Remove the existing receiver unit.
2. Make the necessary connections.
3. Install the installation sleeve.
4. Install the unit into the installation sleeve.

Removing the existing receiver unit

If there is already an installation sleeve for the receiver unit in the dashboard, it must be removed.

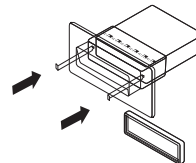

1. Remove the rear support from the unit.
2. Remove the control panel and trim ring from the unit.
3. Insert the lever into the hole on one side of the unit. Perform the same operation on the other side and pull the unit out from the mounting sleeve.

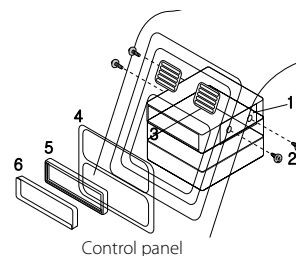
ISO-DIN Installation

1. Slide the unit into the ISO-DIN frame.
2. Fit screws removed from the old unit.
3. Slide the unit and frame into the dash opening.
4. Install the dash panel or adapter plate. (According to models, this step may not be needed.)
5. Install the trim ring to the unit.
6. Install the control panel to the unit.

About detachable control panel

Attaching the control panel

1. Attach part **A** of the control panel to part **B** of the unit.

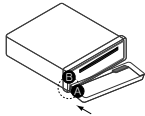

2. Attach part **C** of the control panel to part **D** of the unit while pushing the control panel to left.

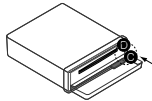

3. Close the control panel.

Caution

- The control buttons may not work properly if the control panel is not attached properly. If this occurs, gently press the display.
- Do not leave the control panel in any area exposed to high temperatures or direct sunlight.
- Do not drop the control panel or otherwise subject it to strong impact.
- Do not allow such volatile agents as benzene, thinner, or insecticides to come into contact with the surface of the control panel.

Detaching the control panel

1. Press the  to open the control panel.

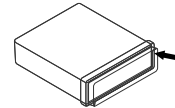

2. Push the control panel to left.

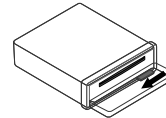

3. Pull the control panel out of the unit.
4. Put the detached control panel into the protective case.

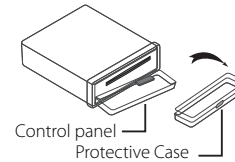

Note

Periodically wipe the contacts on the back of the control panel with a cotton swab moistened with alcohol. For safety, turn off the ignition before cleaning, and remove the key from the ignition switch.

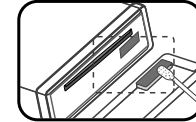

Connection

Connecting to a car

Before installing, make sure that the ignition-switch is set to OFF and remove the terminal of the car battery to avoid short-circuiting.

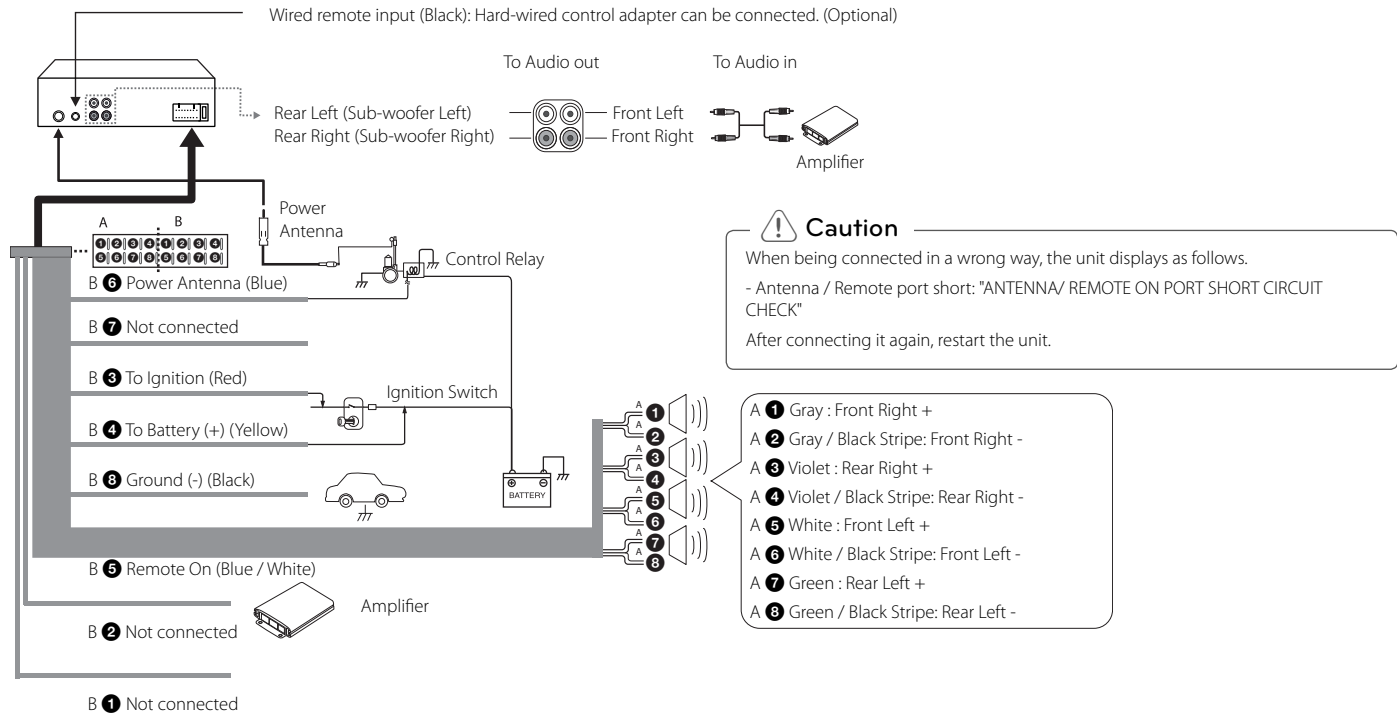

Operation

Basic operations

1. Turn the unit on by pressing any key on the unit.
2. Select a source by pressing SRC.
3. Rotate the volume knob to adjust the volume on the unit.
Or press VOLUME ▲ / ▼ on the remote control.

Turning off the sound temporarily

1. Press MUTE to mute your unit.
Or press MUTE on the remote control.
2. Press it again to cancel

Using EQ (Equalizer)

EQ is to increase or decrease the signal strength of audio frequencies. The function helps you to enjoy sound more plentifully.

Press EQ on the unit repeatedly. The indicator lights up in the following order.

B-BOOST (BASS BOOSTER) → POP → CLASSIC → ROCK → JAZZ → VOCAL → SALSA → SAMBA → REGGAE → RUSSY → USER1 → USER2 → Off (Not displayed)

Using 3D SOUND

This mode delivers outstanding surround sound.

1. Press and hold EQ/•3D.
2. Press and hold it again to cancel.

Note

- 3D SOUND is only available when you use the CD/ USB. (Except iPod/ iPhone)
- When you are recording, 3D SOUND will be turned off automatically.

Checking the clock

1. Press DISP
2. Press it again to cancel

Turning off the display light

1. Press and hold DISP.
2. Press and hold it again to turn it on.

Note

Under the light-off condition, press any key, the light is turned on and then off automatically if you don't press it within a few seconds.

Resetting the unit

You can reset the unit when it does not operate properly.

1. Detach the control panel.
Refer to page 6 for detaching the control panel.
2. Press the RESET hole with a sharp object.

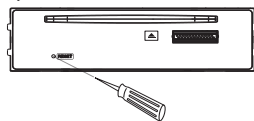

Adjusting the general settings

You can adjust [SOUND], [LIGHT] and [OTHER] settings.

On the unit

1. Press and hold • MENU.
2. Rotate the volume knob to select [SOUND], [LIGHT], or [OTHER] and press it.
3. Rotate the volume knob to select the item and press it.
4. Rotate the volume knob clockwise or counterclockwise to adjust the level.
5. Press the volume knob to confirm the setting.
If you want to return to the previous step, press ↶.

On the Remote Control

1. Press and hold FUNC / • MENU.
2. Press ▲ / ▼ to select [SOUND], [LIGHT], or [OTHER] and press ENTER.
3. Press ▲ / ▼ to select the mode and press ENTER.
4. Press ▲ / ▼ to adjust the level.
5. Press ENTER to confirm the setting.
If you want to return to the previous step, press ↶.

For [SOUND] setting

You can adjust sound quality by adjusting the level BAL (left/right speaker), FAD (front/rear speaker), SW (Subwoofer), SW-F (Subwoofer frequency), A-EQ (Auto EQ).

- When you set the EQ to USER 1/2 mode. : You can adjust the level of BAS (bass), MID (middle), TRB (treble).

- SW (Subwoofer)
You can adjust the volume of subwoofer.
- SW-F (Subwoofer frequency)
OFF/ SW 55 Hz/ SW 85 Hz/ SW 120 Hz
You can enable the subwoofer.
- A-EQ (Auto EQ) OFF/ ON
AUTO EQ operates only in the music file supported with genre in the device.
When you set AUTO EQ to ON, POP, CLASSIC, ROCK, or JAZZ is automatically selected according to the music genre.

For [LIGHT] setting

You can adjust the light effects by adjusting LED MODE, USER LED, DIM, or DIM LV.

- LED MODE : You can change the LED window color.
LED AUTO/ LED USER / LED 01 to 27
- USER LED
Making the desired LED color by adjusting the each level of RED, GREEN, and BLUE. (USER LED is only available when you set LED MODE to LED USER.)

- DIM (Dimmer) OFF / ON : You can change the brightness of the display window during the power-on status.

Settings	Description
DIM ON	The display window becomes dark.
DIM OFF	The display window becomes bright.

- DIM LV (Dimmer Level) : When you set DIM to ON, you can adjust the dimmer level. (-2, -1, 0, +1, +2)

For [OTHER] setting

- AUX (Auxiliary) ON / OFF
It is possible to use auxiliary equipment with this unit. Activate the auxiliary setting when using auxiliary equipment connected to this unit.
- DEMO OFF / ON
You can change the initial indication on the display to information name (function name, EQ name, etc...) while listening to a source.
- BEEP 2ND / ALL
BEEP 2ND : The beep is generated when a key is pressed for longer than 2 seconds.
BEEP ALL : The beep is generated when any key is pressed.

- CLK (Clock)
For the model RDS is not supported unit or even for a RDS supported unit.
- When RDS CT information is not received and then you set CT to OFF, you can adjust the time by yourself. Set the clock as follows ;
1. Select a source to TUNER.
2. Press the FUNC to select the CT and then set CT to OFF. (Refer to the " Adjusting TUNER settings " on the page 11 for setting the CT (Clock Time) ON / OFF)
3. Press and hold • MENU on the unit to select [OTHER] and then select CLK by rotating the volume knob.
4. Set the hour by rotating the volume knob.
5. Press the volume knob to confirm the hour.
6. Set the minute by rotating the volume knob.
7. Press the volume knob to confirm the minute.
- When RDS CT information is received; The clock is displayed according to the RDS CT information.
- When RDS is not supported, set the clock according to 3 to 7 steps.

Listening to a CD

1. Press the to open the control panel.
2. Insert a CD.
3. Close the control panel.

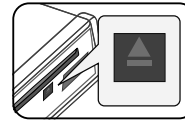

Note
Make sure to press after pressing to eject a disc. Refer to the picture above.

Pausing or restarting CD playback

1. Press on the unit to pause playback.
Or press on the remote control.
2. Press it to resume playback.

Searching for a section within a track / file

1. Push and hold clockwise or counterclockwise on the unit for about 1 second during playback.
Or press and hold on remote control.
2. Press on the unit at the point you want.
Or press on the remote control.

Skipping to another track/ file

Push clockwise or counterclockwise on the unit.

Or press / on the remote control.

Or

1. Press the volume knob on the unit.
Or press ENTER on the remote control.
2. Rotate the volume knob on the unit to select a desired ROOT or folder and press it.
Or press / and press ENTER on the remote control.
3. Rotate the volume knob on the unit to select a desired track / file and press it.
Or press / and press ENTER on the remote control.

Note
To skip to previous track, push counterclockwise within 3 seconds of playing time.

Checking information about your music

MP3 / WMA files often come with tags. The tag gives the Title, Artist or Album.
Press DISP repeatedly during MP3 / WMA / CD TEXT file playback. If there is no information, "NO TEXT" will be shown in the display window.

Playing back tracks / files in a way you want

For using applicable buttons





1. Press INT / RPT / SHE.
2. Press it again to cancel.
Or





Using the FUNC button

On the unit

1. Press FUNC.
2. Rotate the volume knob to select an item and press it.
3. Rotate the volume knob to select the option.
4. Press the volume knob to set the option.
If you want to return to the previous step, press .

On the Remote Control

1. Press FUNC / • MENU.
2. Press  /  to select an item and press it.
3. Press  /  to select the option.
4. Press ENTER to set the option.
If you want to return to the previous step, press .

- RPT (Repeat)
The current selected tracks / files (1 RPT) or folder ( RPT) on the disc is played repeatedly.
- SHF (Shuffle)
Each files in the current selected folder ( SHF) or all of the tracks / files (SHF) on the disc is played randomly. During random playback, even if you push  counterclockwise, you won't go back to the previous track/ file.
- INT (Intro Scan)
The first 10 seconds of all tracks / files (INT) or each files in the current selected folder ( INT) on the disc are played.

! Note

MP3 / WMA Disc compatibility with this unit is limited as follows:

1. Sampling Frequency / 8 kHz to 48 kHz (MP3) 22.05 kHz to 48 kHz (WMA).
2. Bit rate / within 8 kbps to 320 kbps (include VBR) (MP3) 32 kbps to 320 kbps (WMA).
3. CD-R / CD-RW file system should be "ISO 9660".
4. If you record MP3 / WMA files using software which cannot create a FILE SYSTEM, for example "Direct-CD" etc., it will not be possible to playback MP3 / WMA files. We recommend that you use "Easy-CD Creator" which creates an ISO 9660 file system.

You have to set the disc format option to [Mastered] in order to make the discs compatible with the LG players when formatting rewritable discs. When setting the option to Live File System, you cannot use it on LG players.

(Mastered / Live File System : Disc format system for Windows Vista)





Customers should also note that permission is required in order to download MP3 / WMA files and music from the Internet. Our company has no right to grant such permission. Permission should always be sought from the copyright owner.

Listening to music from an external device









1. Connect an external device to the AUX jack with line input cable.
2. Set a source to AUX.
3. Play the connected Auxiliary Equipment.

Preventing radical changes in volume as switching sources





Only when you set AUX to ON as switching sources, you can adjust the volume level of each source to prevent radical changes in volume by selecting GAIN 0 / +6.

1. Press FUNC on the unit.
Or press FUNC / • MENU on the remote control.
 2. Rotate the volume knob on the unit.
Or press  /  on the remote control to set the option. (GAIN 0 / +6)
 3. Press the volume knob on the unit.
Or press ENTER on the remote control to confirm the setting.
 4. If you want to return to the previous step, press .
- Or press  on the remote control.

Listening to the radio

1. Press SRC repeatedly to select a source to TUNER.
2. Press BAND repeatedly to select a desired band.
3. For manual search, Push and hold  /  clockwise or counterclockwise on the unit until "MANUAL" is displayed. Then push it repeatedly to select a desired frequency.
Or press and hold  /  on the remote control.
For auto search, Push  /  clockwise or counterclockwise on the unit. Then "SEARCH" is displayed. (Except MW)
Or press  /  on the remote control.

Storing desired frequencies manually

1. Press BAND to select a desired band you want to store.
2. Select the desired frequency by using  /  on the unit.
Or use  /  on the remote control.
3. press the volume knob and rotate the volume knob to select a preset station among 1 to 6 and then press and hold the volume knob until the beep sound is heard.
Or press and hold one of preset buttons among 1 to 6 on the remote control until the beep sound is heard.
4. Repeat steps 1 to 3 to preset other stations.

Note

When a station is stored on the preset numbers on which another station of the same band has already been preset, the previously preset station is automatically erased.

Listening to a preset station

1. Press BAND repeatedly to select a desired band.
2. Press the volume knob on the unit. Or press ENTER on the remote control.
3. Rotate the volume knob to select a preset station. Or press ▲ / ▼ on the remote control.
4. Press the volume knob. Or press ENTER on the remote control. Or

Press BAND and then press the desired preset button among 1 to 6 on the remote control.

Adjusting TUNER settings

On the unit

1. Press FUNC.
2. Rotate the volume knob to select an item and press it.
3. Rotate the volume knob to set the option and press it.
4. If you want to return to the previous step, press ↶.

On the Remote Control

1. Press FUNC / • MENU.
2. Press ▲ / ▼ to select an item and press ENTER.
3. Press ▲ / ▼ to set the option and press ENTER.
4. If you want to return to the previous step, press ↶.

- PTY (Program type, RDS (OPTIONAL)) It searches the radio stations by program type of FM tuner. The program types are displayed as follows.

NEWS	FINANCE	EASY M
AFFAIRS	CHILDREN	LIGHT M
INFO	SOCIAL	CLASSICS
SPORT	RELIGION	OTHER M
EDUCATE	PHONE IN	JAZZ
DRAMA	TRAVEL	COUNTRY
CULTURE	LEISURE	NATION M
SCIENCE	DOCUMENT	OLDIES
VARIED	POP M	FOLK M
WEATHER	ROCK M	

- A / S (Auto Store)
The six strongest broadcasting frequencies will be stored under preset button 1 to 6 in the order of their signal strength. To cancel, press the volume knob.
- P / S (Preset scan)
Each preset station appears. To cancel, press the volume knob.
- SENS (Tuner sensitivity) MID / HI / LOW
In an area in which signal reception is weak, it helps the tuner to search more stations. The weaker the reception is, the lower option you should set to.

RDS (OPTIONAL)

- AF (Alternative Frequency) ON / OFF
When the reception quality drops, the tuner automatically changes to another station in the network, broadcasting a better reception quality, using the PI and AF codes.
- REG (Region) ON / OFF
REG ON : The unit switches to another station, within the same network, broadcasting the same program when the receiving signals from the current station become weak.
REG OFF : The unit switches to another station, within the same network when the receiving signals from the current station become weak. (In this mode, the program may differ from the one currently received.)
- TA (Traffic Announcement) ALARM / SEEK
TA ALARM : When the tuned station has no TP information for 5 seconds, a double beep sound is output.
TA SEEK : When the tuned station does not receive TP information for 5 seconds, the receiver retunes to the next station that has the TP information.
- PI (Programme Identification) SOUND / MUTE
PI SOUND : When the frequency of a tuned station switches to an AF (Alternative frequency) with an unidentified PI, it keeps the sound.
PI MUTE : When the frequency of a tuned station switches to an AF with an unidentified PI, it mutes the sound until the PI is identified.
- CT (Clock Time) ON / OFF
You can use the RDS CT information to update the time. When RDS CT information is not received and then you set CT to OFF, you can adjust the time by yourself. Refer to the page 9 for setting the clock.

Using an USB device

1. Open the USB cover.
2. Connect the USB device.
3. Press SRC repeatedly to select a source to USB.

Moving to another drive

When connecting this unit to multi reader, press BAND on the unit (or DRV on remote control) to go the next drive. Each time you press the button, the driver modes change.

Quick search of a desired file

1. Press the volume knob on the unit.
Or press ENTER on the remote control.
2. Rotate the volume knob on the unit to select a desired ROOT or folder and press it.
Or press ▲ / ▼ and press ENTER on the remote control.
3. Rotate the volume knob on the unit to select a desired file and press it.
Or press ▲ / ▼ and press ENTER on the remote control.

! Note

Other functions are same with "Listening to a CD". Refer to page 9 to 10.

Playable USB device Requirement

- Do not extract the USB device during operation (play, etc.).
- An USB device which requires additional programme installation when you have connected it to a computer, is not supported.
- Regular back up is recommended to prevent data loss.
- If you use a USB extension cable, USB HUB, USB Multi-reader, or external HDD, the USB device may not be recognized.
- When you connect a partitioned USB device into the unit, only the first partition is recognized on it.
- Some USB device may not work with this unit.
- Digital camera and mobile phone are not supported.
- USB Port of the unit cannot be connected to PC. The unit cannot be used as a storage device.
- Using NTFS file system is not supported. (Only FAT (16 / 32) file system is supported.)
- MTP (Media Transfer Protocol) device is not supported.

Recording to USB device

1. Open the USB cover and connect it to the unit.
2. Select CD or FM tuner.
3. Press REC to start recording.
For one track/ file recording, press it once.
For all tracks or files in the current selected folder recording, press and hold it until the beep sound is heard.
4. Press it again to stop.

! Note

- Only in CD and FM tuner, recording is available.
- Do not remove the USB device during recording, or an incomplete file may be made and not deleted on PC.
- When USB device memory is full, "MEMORY FULL" displays and stops recording.
- While FM tuner recording, the broadcastings are recorded as a file every 20 minutes.

The making of unauthorized copies of copy-protected material, including computer programs, files, broadcasts and sound recordings, may be an infringement of copyrights and constitute a criminal offense. This equipment should not be used for such purposes.

Be responsible
Respect copyrights

Listening to music by connecting iPod / iPhone

You can enjoy iPod / iPhone-stored music on the unit by connecting it to the USB connector using the appropriate cable.

1. Open the USB cover.
2. Connect the iPod / iPhone.
3. Press SRC to select a source to USB.

Pausing or restarting playback

1. Press >|| on the unit to pause playback.
Or press ►/|| on the remote control.
2. Press it to resume playback.

Searching for a section within a file

During playback, push and hold I<< / >>I clockwise or counterclockwise on the unit and then release at a point you want.

Skipping to another file

Push I<< / >>I clockwise or counterclockwise on the unit.
Or press ◀◀ / ▶▶ on the remote control.

Or

1. Press the volume knob on the unit.
Or press ENTER on the remote control.
2. Rotate the volume knob on the unit to select a desired category and press it.
Or press ▲ / ▼ and press ENTER on the remote control.

- Rotate the volume knob on the unit to select a desired file and press it.
Or press ▲ / ▼ and press ENTER on the remote control.

Checking information about your music

MP3 / WMA files often come with tags. The tag gives the Title, Artist or Album.

Press DISP repeatedly during MP3 / WMA file playback. If there is no information, "NO TEXT" will be shown in the display window.

Playing back files in a way you want

On the Unit

- Press FUNC.
- Rotate the volume knob to select an item and press it.
- Rotate the volume knob to select the option.
- Press the volume knob to set the option.
If you want to return to the previous step, press ↩.

On the Remote Control

- Press RPT / SHF.
- Press it again to cancel.
Or
1. Press FUNC / • MENU.
2. Press ▲ / ▼ to select an item and press ENTER.
3. Press ▲ / ▼ to select the option.
4. Press ENTER to set the option.
If you want to return to the previous step, press ↩.

- RPT (Repeat)**
The current selected file (1 RPT) or files on the iPod / iPhone is played repeatedly.
- SHF (Shuffle)**
Each file in the currently selected album (■ SHF) or all of the files (SHF) on the iPod / iPhone are played randomly. During random playback, even if you push I◀ counterclockwise, you won't go back to the previous file.
- SPD (BOOK SPEED)**
You can adjust the audiobook speed of iPod / iPhone to NOR (Normal), SLOW or FAST.

Playing back files by music menus

You can check files by music menus and play it back.

The music menus are as follows.

PLAYLISTS → ARTISTS → ALBUMS →
GENRES → SONGS → COMPOSER →
AUDIO BOOK → PODCAST → ...

- Press the volume knob on the unit.
Or press ENTER on the remote control.
- Rotate the volume knob on the unit to select a music menu and press it.
Or press ▲ / ▼ on the remote control.
- Rotate the volume knob on the unit to select a file.
Or press ▲ / ▼ on the remote control.
- Press the volume knob on the unit to confirm the setting.
Or press ENTER on the remote control.
- If you want to return to the previous step, press ↩.
Or press ↶ on the remote control.

iPod / iPhone CONTROL MODE

You can control on the unit and iPod / iPhone.

- Press iPod on the unit. Then playback is paused. And you can control on the unit and iPod / iPhone.
- While using the iPod/iPhone CONTROL MODE, any functions are not available on the unit.
- Press iPod again to cancel the iPod / iPhone CONTROL MODE.

Compatible iPod / iPhone models

- iPod classic
- iPod nano 6th generation
- iPod touch 4th generation
- iPhone 3G / 3GS / 4

We recommend that you use the OS Version 4.2.1 or more.



"Made for iPod" and "Made for iPhone" mean that an electronic accessory has been designed to connect specifically to iPod or iPhone respectively, and has been certified by the developer to meet Apple performance standards. Apple is not responsible for the operation of this device or its compliance with safety and regulatory standards. Please note that the use of this accessory with iPod, iPhone may affect wireless performance.

Troubleshooting

Symptoms	Cause	Solution
Power doesn't turned on. The unit doesn't operate.	Leads and connectors are not properly.	Confirm once more that all connections are correct.
	The fuse is blown.	Rectify the problem that caused the fuse to blow, and then replace it. Be very sure to install the correct fuse with the same rate.
	Noise and other factors are causing the built in microprocessor to operate incorrectly.	Turn the unit off and then on again.
No sound is heard.	Cables are not connected correctly.	Connect the cables correctly.
There's audio skipping.	This unit is not firmly secured.	Secure this unit firmly.
The playback is not possible.	The disc is dirty.	Clean the disc.
	The disc of unplayable type is loaded.	Check what type the disc.
Radio stations cannot be tuned in.	The signal strength of the stations is too weak. (When tuning in with automatic tuning.)	Tuned in the stations manually.
	No station has been preset or preset stations have been cleared. (When tuning by scanning preset stations.)	Preset the stations.
iPod/ iPhone does not work.	Check whether iPod / iPhone is connected to the unit correctly.	Connect it to the unit correctly.
The unit does not operate correctly even when the appropriate remote control buttons are pressed.	Battery power is low.	Load a new battery.

Specifications

General

Output Power : 53 W x 4 CH (Max.)

Power Source : DC 12 V

Speaker impedance : 4 Ω

Ground System : Negative

Dimensions (W x H x D) : (178 x 50 x 168)
mm (without Control Panel)

Net Weight : 1.32 kg

TUNER

FM Tuning Range :

87.5 MHz to 108.0 MHz

S / N Ratio : 55 dB

Distortion : 0.7 %

Usable Sensitivity : 12 dB μ V

AM (MW) Tuning Range :

(520 to 1720) kHz or (522 to 1620) kHz

S / N Ratio : 50 dB

Distortion : 1.0 %

Usable Sensitivity : 28 dB μ V

CD

Frequency Response : 20 Hz to 20 kHz

S / N Ratio : 80 dB

Distortion : 0.12 %

Channel Separation (1 kHz) : 55 dB

AUX

Frequency Response : 20 Hz to 20 kHz

S / N Ratio : 80 dB

Distortion : 0.1 %

Channel Separation (1 kHz) : 45 dB

Max Input Level (1 kHz) : 1.1 V

USB

Version : USB 1.1 or USB 2.0 Full Speed

Bus Power Supply (USB) :

DC 5 V $\overline{\text{---}}$ 1.5 A

Line OUT

Frequency Response : 20 Hz to 20 kHz

Output Voltage : 2 V (Max.)

Subwoofer

Frequency Response : 20 Hz to 120 Hz

Output Voltage : 2 V (Max.)

- Design and specifications are subject to change without notice.

