

| | | | |
|----------|-------------|-------------------|---------------|
| Model | VR5942L | | |
| Language | English | | |
| Page | 36 | Color(cover/body) | 1/1 |
| Material | Weight 80g | Size(W*H) | 190×260(mm) |
| Date | 2012.3.26 | Designer | Ma Yongli |
| Part No | MFL67086051 | Description | Owners Manual |

Chage Record

| No. | Change content | ECO No. | Date | Designer | Confirm |
|-----|----------------|---------|------|----------|---------|
| ① | | | | | |
| ② | | | | | |
| ③ | | | | | |
| ④ | | | | | |
| ⑤ | | | | | |
| ⑥ | | | | | |
| ⑦ | | | | | |
| ⑧ | | | | | |
| ⑨ | | | | | |



OWNER'S MANUAL

CLEANING ROBOT

Before using, please carefully read the Safety Precautions pages to allow for safe operation of the product. After reading the operation manual, please keep it in an easily accessible location.

VR59**L
VR59**L*



MFL67086051

www.lg.com

FEATURES

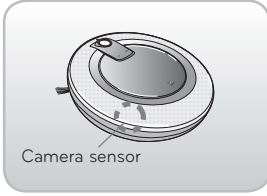

Images of the floor are obtained from the sensors of the lower camera, and through this, the location of HOM-BOT will be confirmed, therefore, elaborate cleaning can be accomplished for every part of the room.

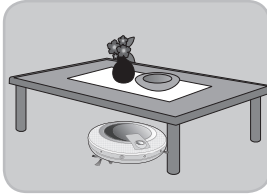

As the height of the HOM-BOT is low (90mm), even the underside of a framed bed or furniture can be cleaned.

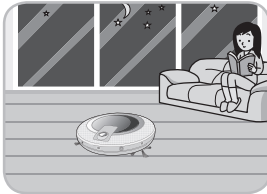

As the noise levels are at a quiet 60dB, cleaning can be performed at night.
*Less than 60dB

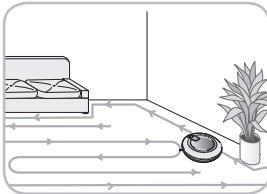

The HOM-BOT can clean all parts of the area by cleaning in zigzag mode and then in spatial expansion mode.

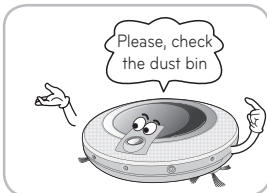

The HOM-BOT also has voice confirmation and instruction that can be easily understood by the user.

CONTENTS

1

BEFORE USING

- 1~4 Safety Precautions
- 5 Included with Product
- 6~7 Parts Descriptions
- 8~9 Button Functions
- 10 Display Status Information
- 11 Before You Start
- 12 Overview

2

HOW TO USE

- 13 How to Install the Home Station
- 14 How to Turn the Power Supply On and Off.
- 15 How to Start and Stop Cleaning
- 16~17 How to Charge the Battery
- 18 Cleaning Modes
- 19 Auxiliary Cleaning Modes

3

CARE AND MAINTENANCE

- 21 Cleaning the Dust Bin
- 22 Cleaning the Dust Bin Filter
- 23 Cleaning the Brush
- 24 Cleaning the Sensor/Charging Terminal
- 25 Cleaning the Side Brush

4

ADDITIONAL INFORMATION

- 26~28 Troubleshooting
- 29 Before You Call for Service

5

REFERENCE

- 30 Product Specifications

SAFETY PRECAUTIONS

The purpose of the safety precautions described below is for the user to use the product safely and correctly to prevent any unexpected risk or damage.

Basic safety precautions

After reading this manual, please keep it in an easily accessible location.



This is the safety alert symbol. This symbol alerts you to potential hazards that can result in property damage and/or serious bodily harm or death.



WARNING Indicates a hazardous situation which, if not avoided, could result in death or serious injury.



CAUTION Indicates a hazardous situation which, if not avoided, could result in minor or moderate injury.



WARNING

1. This appliance is not intended for use by persons (including children) with reduced physical, sensory or mental capabilities, or lack of experience and knowledge, unless they have been given supervision or instruction concerning use of the appliance by a person responsible for their safety.
2. Children should be supervised to ensure that they do not play with the appliance.
3. If the supply cord is damaged, it must be replaced by LG Electronics Service Agent in order to avoid a hazard.
4. This appliance can be used by children aged from 8 years and above and persons with reduced physical, sensory or mental capabilities or lack of experience and knowledge if they have been given supervision or instruction concerning use of the appliance in a safe way and understand the hazards involved. Children shall not play with the appliance. Cleaning and user maintenance shall not be made by children without supervision.

SAFETY PRECAUTIONS

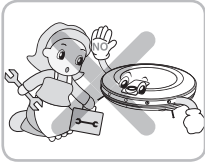

For your safety, do not remove the battery from the Roboking. If you need to replace the battery or the Roboking, take it to the nearest authorized LG Electronics service center or dealer for assistance. Failure to follow this warning can cause fire or product failure.

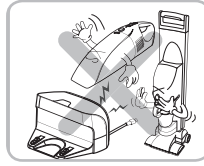

Never use the Roboking with a battery and/or home station from any other product than the Roboking. Doing so can cause fire or product failure.

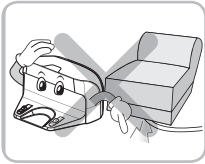

Make sure the power cord of the home station is not crushed under a heavy object or damaged by contact with sharp objects. Failure to follow this warning can cause fire or product failure. If the power cord is broken, replace it at an LG Electronics customer care center.

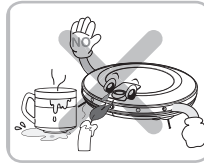

Do not use the Roboking when candles or fragile objects are placed on the floor. Doing so can cause fire or product failure.

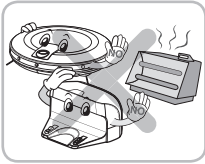

Do not place the home station and the Roboking near a heating device. Doing so can cause product deformation, fire, or product failure.

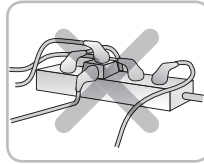

Always use a dedicated outlet. If multiple appliances are connected to an outlet simultaneously, they can generate enough heat to cause a fire.

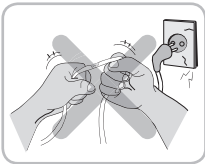

Do not force the power plug to bend. Do not use the power plug when it has been damaged or loosened. Doing so can cause fire or product failure.

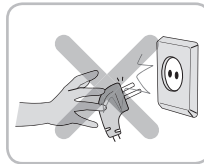

When pulling out the power plug, always pull it out by grabbing the plug, not the cord. When pulling out the power plug, do not touch the prongs with your fingers. Doing so can cause an electric shock.



Do not touch the power plug with wet hands. Doing so can cause electric shock.



Do not use the Roboking while a child or object is on it. Do not use the Roboking while an object is hanging from it. Doing so can cause injury or product damage.

- * 1) Place the cords from other appliances out of the area to be cleaned.
 2) Do not operate the vacuum in a room where an infant or child is sleeping.
 3) Do not operate the vacuum in an area where there are lit candles or fragile objects on the floor to be cleaned.
 4) Do not operate the vacuum in a room that has lit candles on furniture that the vacuum may accidentally hit or bump into.
 5) Do not allow children to sit on the vacuum.
 6) Do not use the vacuum on a wet surface.

SAFETY PRECAUTIONS

! WARNING

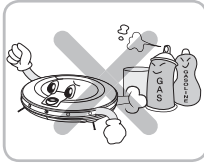

Do not spray or suck in inflammable materials, surfactants, or drinking water in the vicinity of the Roboking.

Doing so can cause fire or product failure.

* Inflammable materials: gasoline, thinner, etc.
* Surfactant: detergent, articles for bath, etc.



Turn the power supply off immediately if any abnormal sound, odor, or smoke is generated from the Roboking.

Failure to do so can cause fire or product failure.

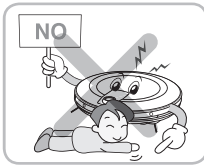

Do not insert any part of the body, such as a hand or foot, below the brush or wheels of the Roboking while in use.

Doing so can cause injury or product damage.



Do not operate the Roboking in a room where a child is sleeping.

Doing so can cause injury or product damage.



Do not operate the Roboking on narrow and high furniture such as a wardrobe, refrigerator, desk, table, etc.

Doing so can cause injury or product failure.

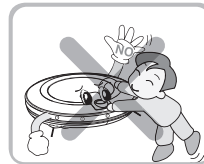

Do not let children play with the Roboking.

Doing so can cause injury or product damage.

! CAUTION



Frequently empty the dust bin and maintain its cleanliness.

The dust collected in the dust bin can trigger allergies and may contain harmful insects.

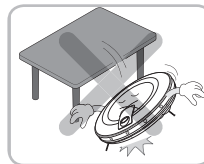

Do not drop the Roboking or subject it to strong impacts.

Doing so can cause injury or product failure.

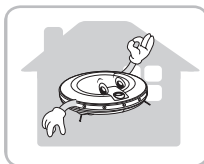

Use the Roboking indoors only.

Using it outdoors can cause product failure.

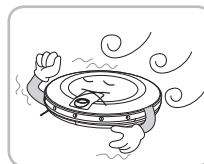

Do not expose the Roboking to cold temperatures (less than 23°F or -5°C) for a long period of time.

Doing so can cause product failure.

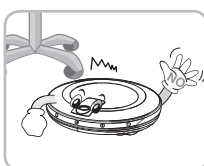

The Roboking may bump into furniture such as chair legs, table legs, thin and long furniture, etc. while operating.

For a quicker and cleaner performance, place the chairs on top of the table.

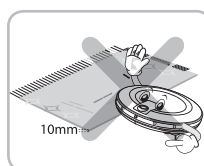

Cleaning will not proceed smoothly on carpets with tassels or carpets thicker than 10 mm.

It may be more convenient to arrange them before using the product.

SAFETY PRECAUTIONS

CAUTION

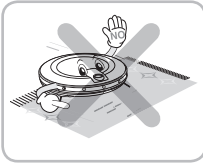

In rare cases, the HOM-BOT's brush can damage the carpet. If this happens, immediately stop the cleaning operation.

When a carpet has long tassels, the tassels can be damaged.

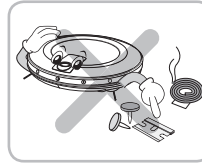

Do not allow the HOM-BOT to sweep up liquids, blades, thumb tacks, kindling, etc.

These items can cause product failure.

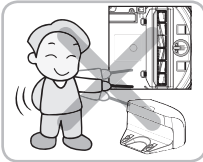

Do not let the main frame and charging terminal of the home station come into contact with metallic objects.

Doing so can cause product failure.



Do not put sharp objects into the opening of the HOM-BOT's supersonic sensor.

Doing so can cause product failure.



Do not put water, detergent, etc. into the HOM-BOT.

Doing so can cause product failure.

Do not put any water or detergent on the HOM-BOT. If liquids get inside of the HOM-BOT, turn off the power supply and contact an LG Electronics sales agent or customer care center.

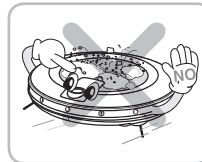

Do not use the HOM-BOT when the dust bin is completely filled up.

Doing so can cause product failure.

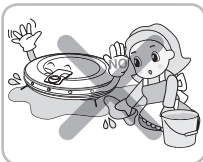

If the floor is wet or has wet spots, wipe them up before using the HOM-BOT. Do not use the HOM-BOT on a wet surface.

Failure to do so can cause product failure.

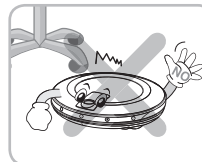

When the robot cleaner is operating, it may hit Chair, desk and table legs or other narrow pieces of furniture.

For quicker and better cleaning, place the dining chairs on top of the dining table.



Tip Check the following items before use:

- Remove fragile or unnecessary objects from the room to be cleaned. For example, remove expensive ceramics and valuables from the floor.
- Do not use this product in the room where a child is sleeping alone. The child can be hurt.
- Confirm whether the battery has sufficient power, and if it is low, recharge it.
- Empty the dust bin after it fills up.
- Close the doors of any room that you do not want the HOM-BOT to enter. During cleaning, the HOM-BOT may enter another room and continue cleaning.
- Remove any moisture from the floor before cleaning.
- Remove any cables or long strings from the floor.
- Remove cables, strips, towels, socks, etc. from the floor so they will not get caught by the brush.
- Cleaning will not proceed smoothly on carpets with tassels or carpets thicker than 8 mm (0.315 in). It may be more convenient to remove or rearrange the position of these rugs or carpets before using the product.

Please note, this product is not intended for use in any workshop, commercial office, garage or outdoor environment. It is for internal normal Domestic internal home use only.

INCLUDED WITH PRODUCT

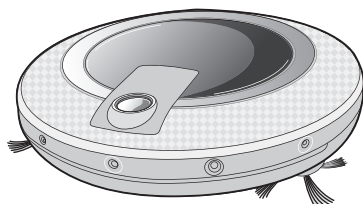

HOM-BOT



Remote controller

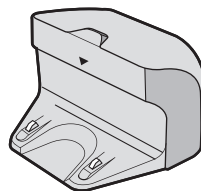

Home station

► Figures can be different from actual objects.



Quick guide



Operation manual

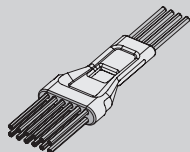

Brush for cleaning Filter



Dry cell for remote controller
(2 units of AAA size)

PARTS DESCRIPTION - HOM-BOT

Plan view

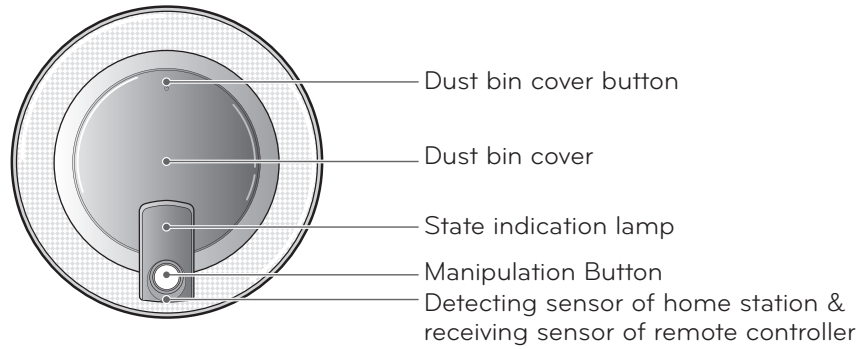

Front view

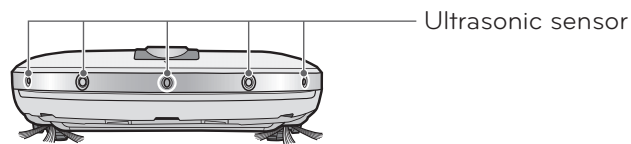

Rear view



Bottom view

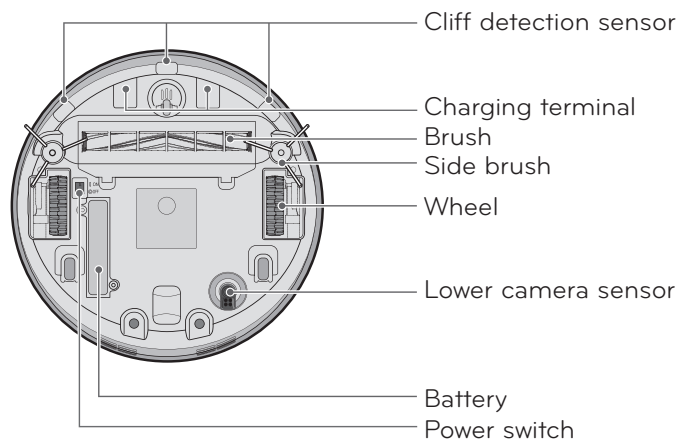

► Figures can be different from actual objects.

PART DESCRIPTION – HOME STATION / DUST BIN

Home station

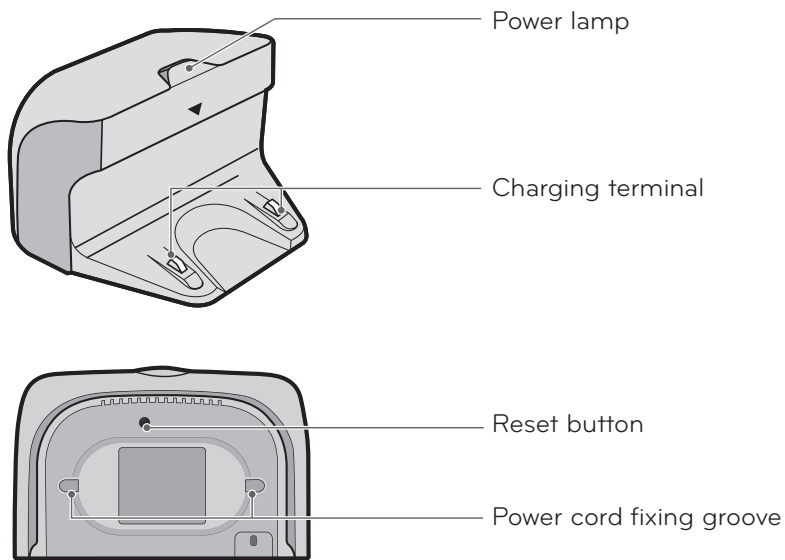

Dust bin

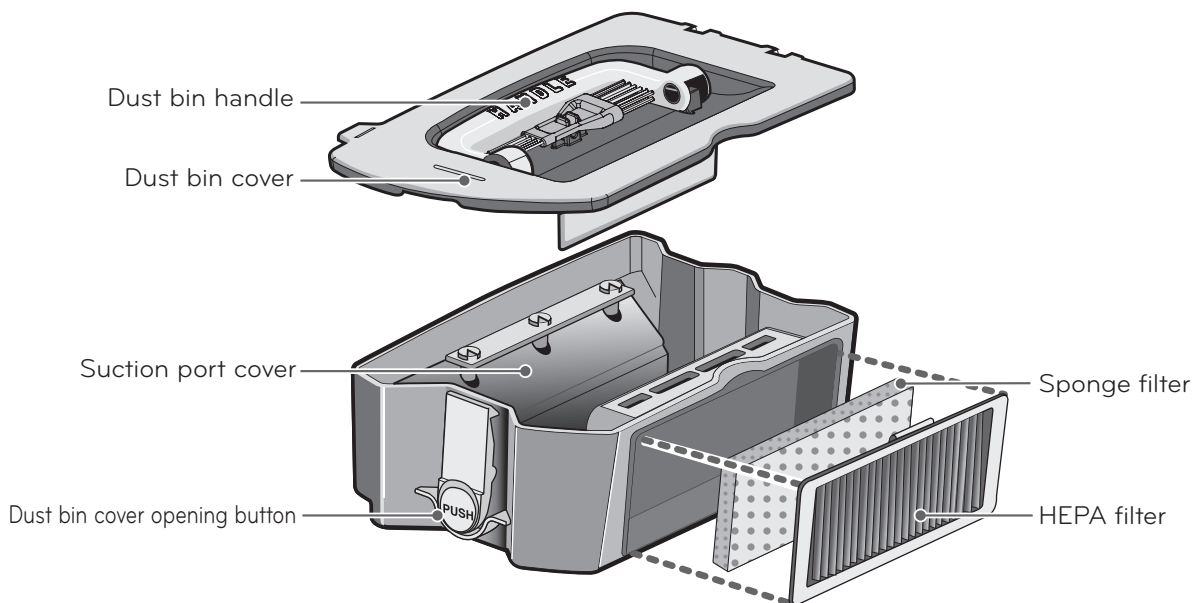

► Figures can be different from actual objects.

BUTTON FUNCTIONS – HOM-BOT

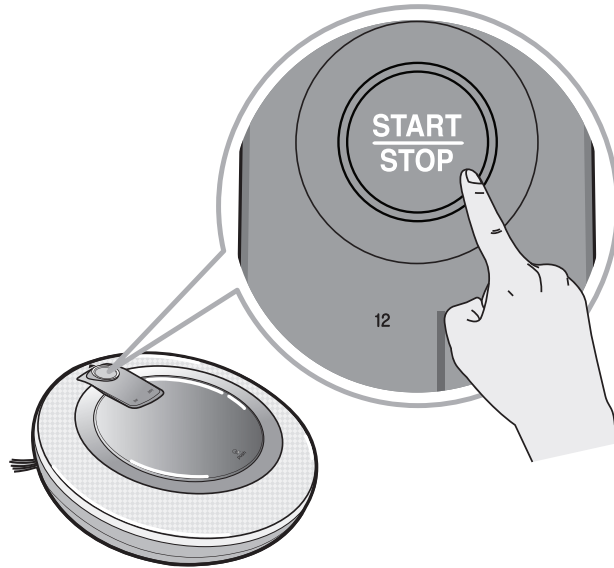

START/STOP

- Press the START/STOP button to turn the HOM-BOT on/off or start/stop cleaning.
- Press the START/STOP button while the HOM-BOT is on and it will automatically start cleaning.
- If the START/STOP button is pressed during automatic cleaning, the HOM-BOT will stop cleaning.
- Press and hold the START/STOP button for approximately two seconds to turn off the HOM-BOT.
- This puts the HOM-BOT into the Stand By mode
- If the button is pressed while in the timer mode, the timer setting will be canceled.

BUTTON FUNCTIONS – REMOTE CONTROL

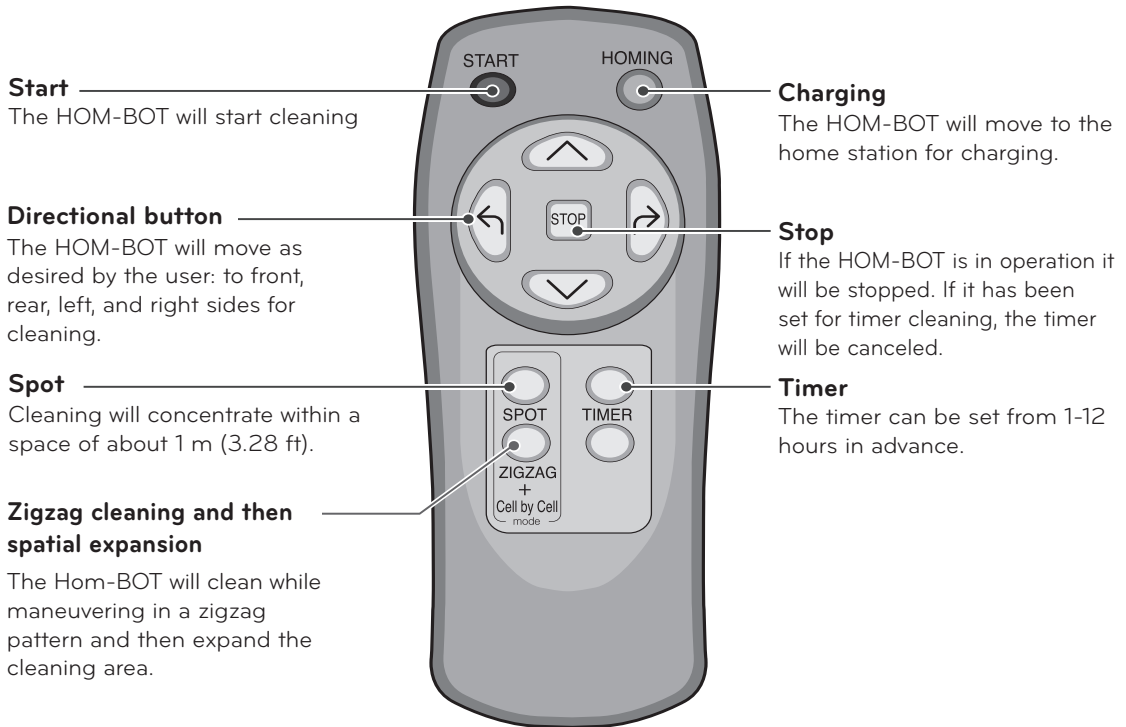

Tip

- The HOM-BOT's power supply cannot be turned on with the remote control.
- To turn on the power supply, use START/STOP button on the top of HOM-BOT.
- In order to do spot cleaning, timer cleaning, zigzag cleaning, and spatial expansion cleaning, you must first stop the operation of the HOM-BOT.
- If the main power switch on the underside of the HOM-BOT is turned off, the remote will not function, and the battery cannot be charged.
- If the main switch on the underside of the HOM-BOT is in the off position, the Status display will flash and sound when the unit is manually placed onto the home station, to indicate that the main switch is off.

DISPLAY STATUS INFORMATION

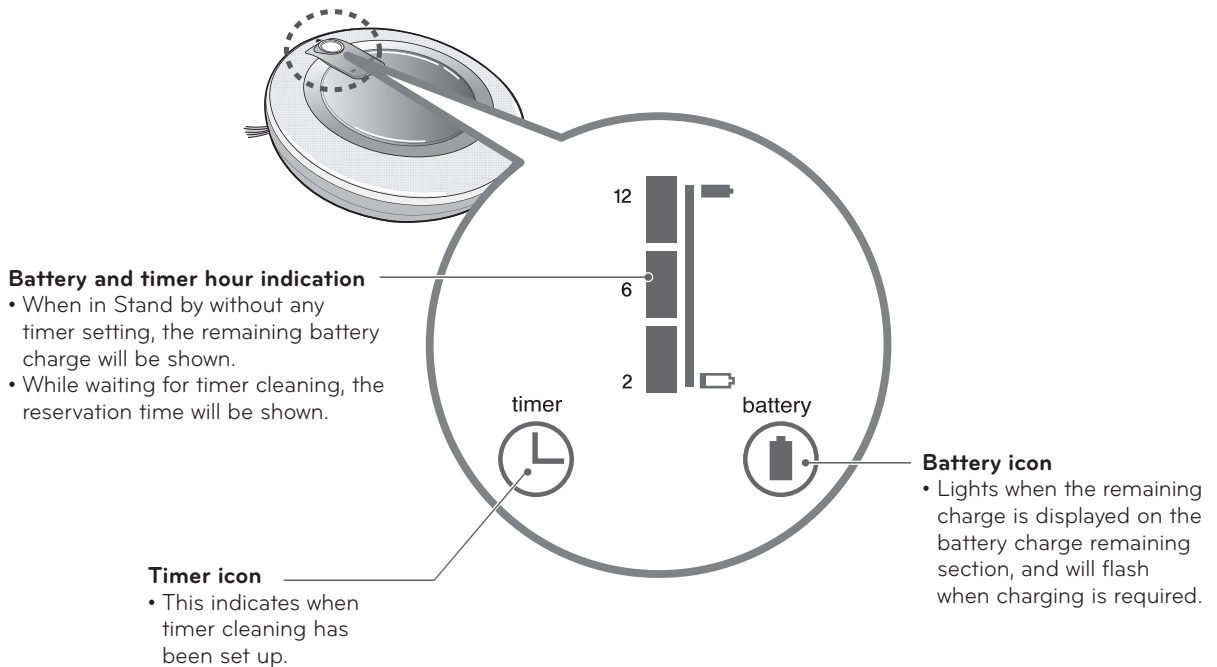

Tip

- Use the remote control to change the cleaning mode.
- Once the cleaning mode has been selected, it will be memorised and automatically selected when the unit is turned on again, unit it is changed again.
- To cancel the timer setting, press the STOP button on the remote control or the START/STOP button on the HOM-BOT.

BEFORE YOU START

Check these items before cleaning

- Do not use this device in a room where a child is left alone. The child could be injured.
- Remove fragile or unnecessary objects from the room to be cleaned.
Especially, remove expensive ceramics and valuables from the floor.
- Remove any moisture that might be on the floor.
- Remove cables, strips, towels, socks, etc. from the floor so they will not get caught by the brush.
- Confirm whether battery charge is sufficient, and if it is low, recharge it.
- Empty the dust bin if it is full.
- Close the doors of any room that you do not want the HOM-BOT to enter. During cleaning, the HOM-BOT may enter another room and continue cleaning.

Loading the remote control battery

1. Open the battery cover by lifting the rear hook of the remote control.
2. Insert two AAA batteries, checking for +, - nodes while loading.
3. Close the battery cover completely so that the batteries will not fall out.

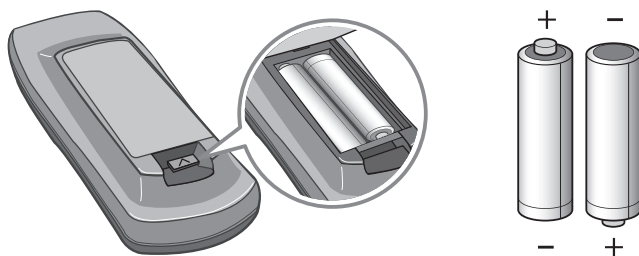

Precautions while using the remote control

- Only press one button at a time.
- Do not drop or subject it to forceful impact.
- Do not store it near devices that give off heat, fire or hot air.
- Certain fluorescent lamps, such as 3 wavelength fluorescent lamps, can interfere with the activation of the remote control. Therefore, use it as far away as possible from such lamps.
- If the remote control is too far from the HOM-BOT when operated, it may fail to operate properly. Use the device within 3 m (9.84 ft) of the HOM-BOT if possible.

OVERVIEW

1

Install the home station. (page 13)

Insert the power cord plug into an outlet and locate the station against a wall. If power is not supplied to the home station, the HOM-BOT will not charge.

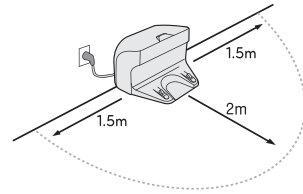

2

Turn on the power supply of the HOM-BOT. (page 14)

Turn on the power switch located on the bottom of the HOM-BOT and press the upper START/STOP button to turn on the power supply.

* If the power supply is not turned on, refer to page 14.



3

Start cleaning. (page 15)

Press the START/STOP button once again while the HOM-BOT is turned on. You will hear the sound of cleaning and cleaning will begin.

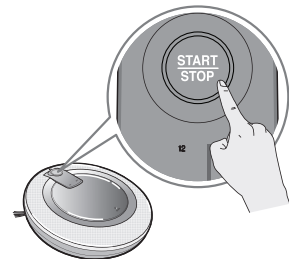

4

Automatic charge. (page 16-17)

The HOM-BOT will self-diagnose and automatically return to the home station to recharge before the complete discharge of the battery. It can take up to three hours to charge the battery.

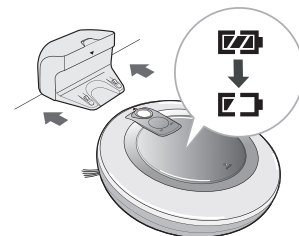

5

Use cleaning methods and auxiliary functions. (page 18-20)

With remote controller, auxiliary function can be used. For auxiliary functions, manual cleaning, spot, timer function.



HOW TO INSTALL THE HOME STATION

How to Install the Home Station

1. Position the home station against a wall, to prevent sliding during docking, on hard level flooring.

Remove objects within 1.5m. to the right and left side and within 2m. to the front.

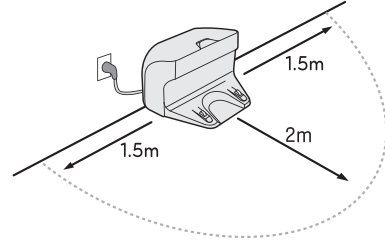
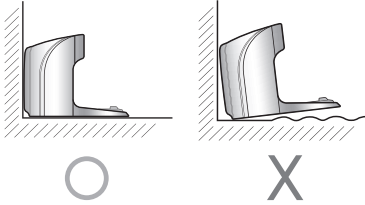

2. Plug the power cord into an outlet.

Wrap the power cord around the fixed hanger on the back side of the home station or along the wall surface so that the travel path of the HOM-BOT will not be obstructed.

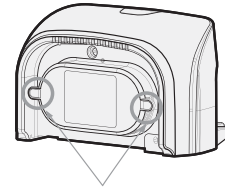
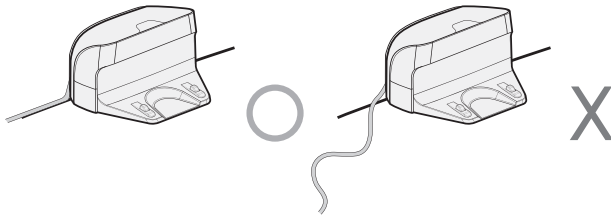

Fixing groove of power cord

3. Fix the home station against the wall so that it does not move.

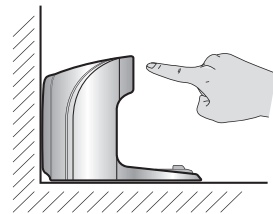

- Tip**
- Always keep the home station plugged in. If the home station is not plugged in, the HOM-BOT will not return to the station to charge automatically.
 - Since the HOM-BOT cleans along the wall, if the charging station is installed on the straight surface of the wall, you can get a more efficient cleaning.
 - Do not operate the Home Station if it has a damaged cord or plug, if it is not working properly, or if it has been damaged or dropped. To avoid any electrical hazard, the cord must be replaced by LG Electronics, or a qualified service person.

HOW TO TURN THE HOM-BOT POWER SUPPLY ON & OFF

Turning on the main power supply

To turn the power supply on, turn the HOM-BOT upside down on a smooth/soft surface and check whether the main power supply switch is turned on.

If the main power supply switch is turned off, turn on the switch.

- * When turning on the power switch, do not press the button located at the upper section of the HOM-BOT. Operation of the button can be delayed.
- * Turn off the power switch if the HOM-BOT will not be used for a long period of time, in order to protect the battery.
- * The power switch cover is used for protecting the switch from the dust. Always keep the cover attached.

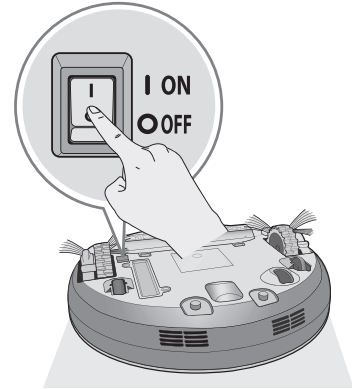

Turning on from Stand By power.

When the HOM-BOT is not at the Home Station, and is in the Stand by mode, press the 'START/STOP' button for more than 1 second. The HOM-BOT will be turned on and a melody will be sounded.

- * If the power is turned on while the HOM-BOT is not at the Home Station, and nothing is done for ten minutes, the power supply will automatically turn off to reduce battery consumption.

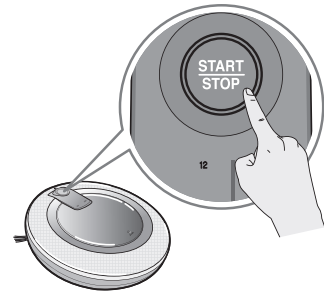

Turning off the power supply

Press the START/STOP button for two seconds while the HOM-BOT is turned on. A melody will sound when the power is turned off.

- ✓ **Tip**
 - The power can be turned off due to the static electricity during the operation.
 - If the power is turned off, turn off the main power switch and then turn it back on.
 - If the power cannot be turned on, do the following.
 - Turn on the power switch and wait for more than 3 seconds.
 - Press the 'START/STOP' button when the power switch is turned on.
 - If the power is not turned on or if there is no display but only the "Ting" sound, put the HOM-BOT on the home station.
 - If there is no change even when HOM-BOT is attached to the home station, press the reset switch located on the rear side of the home station while the HOM-BOT is attached on the home station.

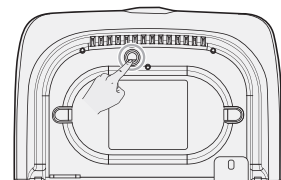
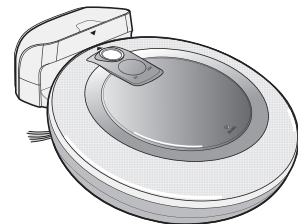

HOW TO START AND STOP CLEANING

Using the buttons on the HOM-BOT

After the HOM-BOT is turned on, press the START/STOP button to begin cleaning. A melody will sound and cleaning will begin.

Press the START/STOP button during the cleaning cycle to stop cleaning.

- * When the 'START/STOP' button is pressed while the power supply of the HOM-BOT is turned off, the power will be turned on. Press the 'START/STOP' button one more time to start cleaning.

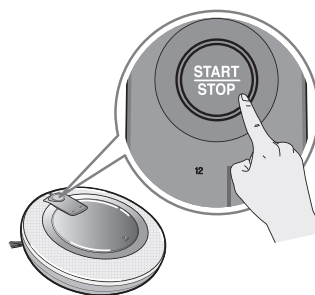

Using the remote control

After the HOM-BOT is turned on, press the START button on the remote control. A melody will sound and cleaning will begin.

Press the STOP button during the cleaning cycle to stop cleaning.

- * The HOM-BOT cannot be turned on from Stand By, by using the remote control when the power of the HOM-BOT is off. When the power is off, press the 'START/STOP' button on the upper side of HOM-BOT to turn the power on and to allow the remote to be used.



- * When the START button on the main unit or remote control is pressed, HOM-BOT will start cleaning in 'Spatial expansion' mode.
- * During cleaning, collisions can happen when the sensor cannot detect objects because of their shape. When this happens, the internal impact detecting sensor will activate and engage a backward motion.
- * If the HOM-BOT is set to start cleaning at a location away from the home station, put the device on a flat floor in order to prevent a malfunction of the obstacle detecting sensor. In addition, start cleaning from a location where there are no obstacles such as curtains or walls within 30 cm (11.8 in) of the HOM-BOT.

Tip For best results:

- Briefly scan the area to be cleaned for big and small objects that may cause difficulty for the HOM-BOT.
- If cleaning is started when the HOM-BOT is at the home station, the device can rapidly be returned to the home station as the current home position has been accurately read.

HOW TO CHARGE THE BATTERY

Automatic charging

The HOM-BOT returns to the home station at the end of a cleaning cycle or when its battery is running low.

- ※ If the HOM-BOT is unable to dock to the home station on its first attempt, it will try again until it docks successfully.
- ※ When the HOM-BOT has cleaned all areas that it can clean, it will return to the home station even when the battery level is not low.

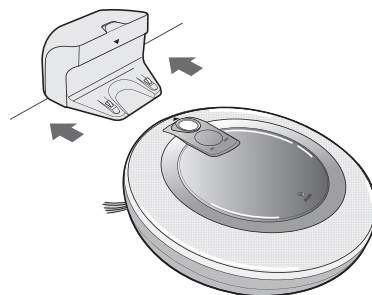

Manual charging

If using the HOM-BOT for the first time or to charge the battery by interrupting the cleaning, you can manually charge the battery.

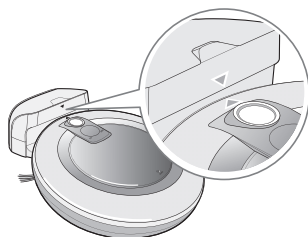

Method 1. Attach the HOM-BOT to the home station by matching up the two arrows on the HOM-BOT and the home station. A melody will sound and charging will begin.

- ※ When the HOM-BOT is attached to the home station, and a "TING" sound is generated repeatedly, please check and ensure that the main On/Off on the underside of the HOM-BOT is in the ON position.



Method 2. When the HOMING button of the remote control charging will start automatically when the HOM-BOT has returned to the Home Station.

- ※ If the HOM-BOT is within 10 cm (3.9 in) of the front of the charging terminal while the power supply is turned on, it will automatically be returned to the home station and charging will begin.

Tip Take the following precautions when using the home station:

- If foreign material is caught in the charging terminal, charging may not proceed smoothly. Wipe the terminal from time to time with a dry cloth after the power plug is disconnected.
- To prevent electric shock, do not touch the charging terminal with any metallic objects.
- To avoid fire or electric shock, never disassemble or modify the home station.
- Do not place the home station or power plug near to a heating appliance.

HOW TO CHARGE THE BATTERY

Remaining Battery Charge Indicator

The remaining battery charge can be confirmed from the charge indication lights, which will indicate charge as follows:

- During charging, the charge remaining indication lights will flicker.
- When charging is completed at the home station, only the battery icon will illuminate to save power.
- The battery icon will flicker when battery charging is required.

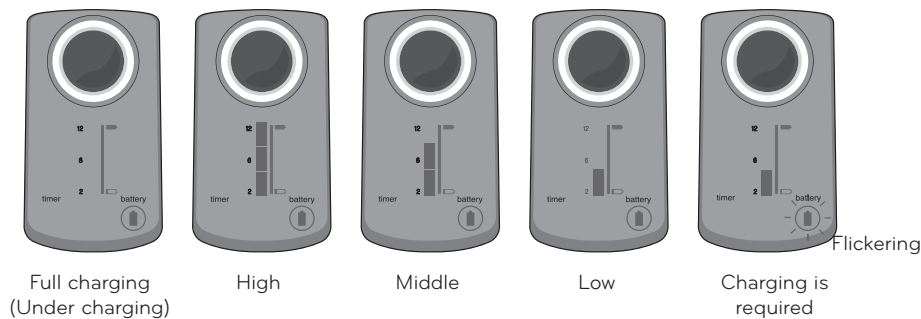

If the Battery is Not Charging

Check 1. If the battery is not charging even when the HOM-BOT is attached to the home station, check the following items.

- Turn the power switch on the bottom of the HOM-BOT off once and then on again.
- Unplug and plug in the power plug on the home station.
- Wipe the terminal on the home station with a dry cloth.

Check 2. If the battery is still not charging after the previous check, try the following.

- Attach the HOM-BOT to the home station.
- Press the reset button at the rear of the home station for three seconds.

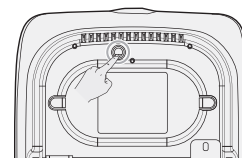
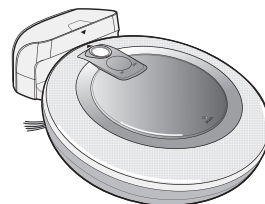

CLEANING MODES

Cleaning pattern of large spaces after the zigzag process is completed

After the zigzag cleaning process is completed, the spaces are divided into rectangles and the whole apartment surface is cleaned in detail.

1. Press the " ZIGZAG + Cell by cell" button on the remote control.
2. HOM-BOT cleans to the left until it meets the wall or it cleans over a distance of up to 3 meters.
3. After cleaning to the left, the HOM-BOT goes back to the starting position and begins cleaning to the right. If HOM-BOT meets the wall or cleans over a distance of 3 meters, for a total of 6 meters, the zigzag cleaning is completed.
4. The cleaning mode is switched to the space expansion mode - self-cleaning - and the cleaning is enabled.

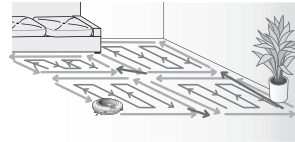
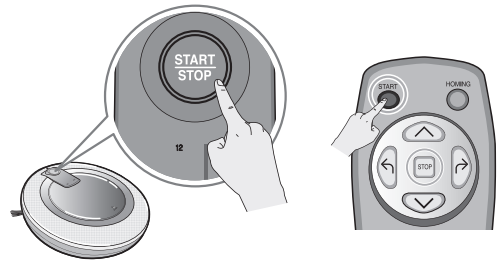

The 1st stage : The maximum outline of 3m x 3m of cleaning area will be cleaned. (The size of outline will be changed in accordance with the shape of the house inside.)



The 2nd stage : Inside of the outline will be cleaned with zigzag traveling.

When the 1st, 2nd stages are completed, the inside of the house will be cleaned through the repetition of above cleaning method as the device is being moved to the next cleaning area.

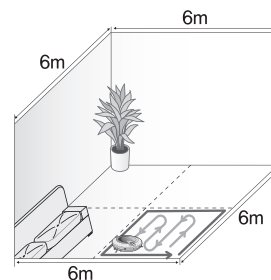
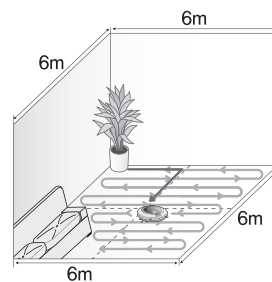

 **Tip** • The cleaning mode can only be changed with the remote control.

AUXILIARY CLEANING MODES

Manual cleaning

This method of cleaning involves manually moving the HOM-BOT by pressing the directional (arrow) buttons on the remote control.

The interior space will be cleaned by the HOM-BOT as it is being moved to the front, rear, or rotated to the left and right side according to the input of the directional buttons.

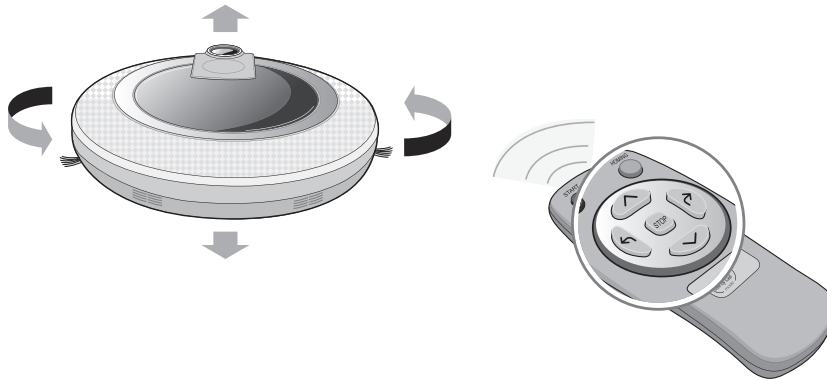

Spot Cleaning

Use this cleaning method when concentrated cleaning of a small interior space is required.

After moving the HOM-BOT to the location to be cleaned, press the SPOT button on the remote control.

The spot cleaning icon will illuminate on the HOM-BOT, and concentrated cleaning will be performed for a space within a radius of 1 m (3.28 ft).

* During charging, the spot cleaning button on the remote control will not activate.

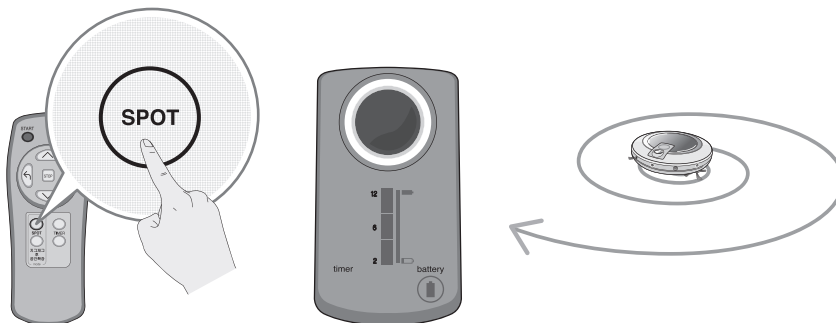

TIMER CLEANING

Hom-Bot can be scheduled to start cleaning after a certain period of time. The time can be set among 2 hours, 6 hours and 12 hours.

1. When HOM-BOT is connected to the charging station, the cleaning time can be set by pressing the **TIMER** button on the remote.

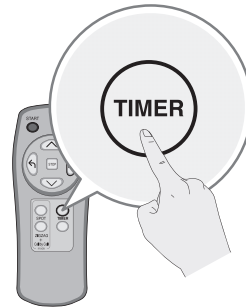

2. Adjust the time by multiple pressures on the **TIMER** button. Each time the button is pressed, the time will increase to 2 hours, 6 hours and 12 hours.

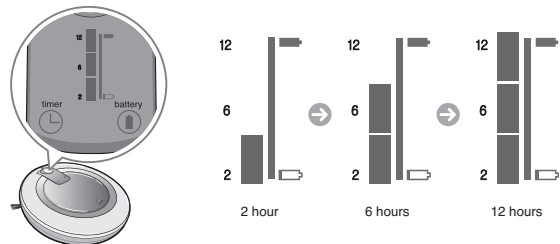

3. After setting up the start time, press the **START/STOP** button on the HOM-BOT or wait about five seconds. When the timer setting is complete, a melody will sound, and the timer indicator will remain on.

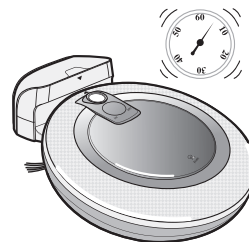

Tip

- When the set up time is being elapsed, cleaning will be started automatically.
- Use the timer setting when the HOM-BOT is attached to the home station. If the timer is set up when the HOM-BOT is detached from the home station, the cleaning time may not be accurate.
- To cancel the timer setting during the set up time, press the **STOP** button on the remote control or the **START/STOP** button on the HOM-BOT.
- When Roboking is detached from the home station, the timer setting will automatically be canceled.

CLEANING THE DUST BIN

If the dust bin is full, suction power can be weakened. Clean the dust bin before and after each cleaning session. Clean the dust bin using the following sequence:

1. Open the dust bin cover by pressing the PUSH button on the HOM-BOT.
2. Grab the handle of the dust bin and pull it upward.
3. Separate the HEPA filter and the inside sponge filter by removing the HEPA filter
▶ To clean the dust bin filter, refer to page 23.
4. Lift the cover upward while pressing the separation button on the dust bin.
5. Empty the dust bin and clean it with a cleaning brush or under running water.
6. After cleaning with water, completely dry the dust bin in a well-ventilated area out of the direct sunlight.
7. When you have completed cleaning the dust bin, close the cover and replace the sponge filter and HEPA filter.
8. Put the dust bin into the HOM-BOT and close the dust bin cover.

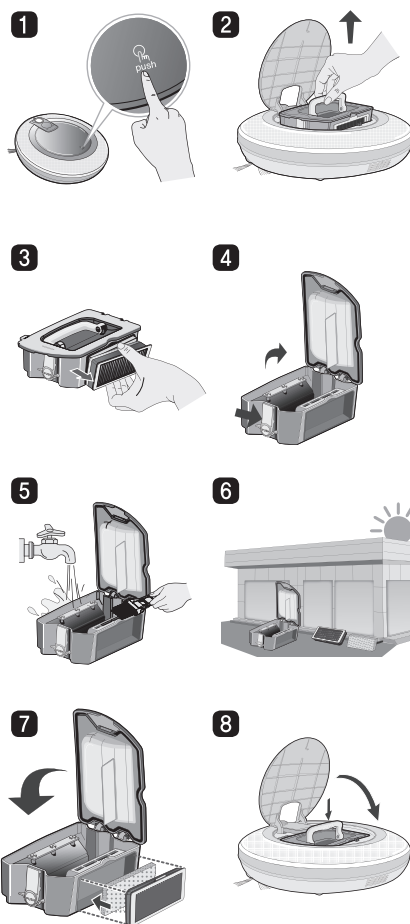

- Tip**
- After cleaning, always mount the dust bin filters (HEPA filter, sponge filter) to the dust bin. If they are not mounted, dust may enter the HOM-BOT interior and cause product failure.
 - When dust bin filter (HEPA filter, sponge filter) is full the warning sound "empty the dust bin!" may be generated. In this case, clean the filter by referring to "cleaning of dust bin filter" on page 23.

CLEANING THE DUST BIN FILTER

The dust bin filters are comprised of the HEPA filter and the sponge filter.
Clean the HEPA filter and the sponge filter according to the following sequence:

1. Separate the HEPA filter and the inside sponge filter by removing the HEPA filter (as shown).

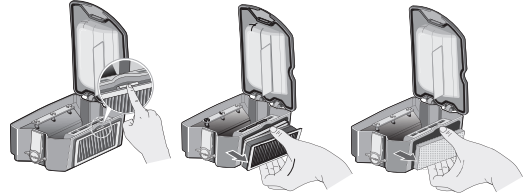

2. Carefully clean any fine dust off the HEPA filter and the sponge filter with a vacuum cleaner or water.

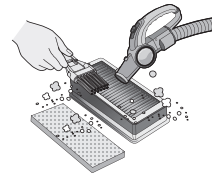

3. After washing the HEPA filter and the sponge filter with water, place them out of direct sunlight and allow them to dry completely.

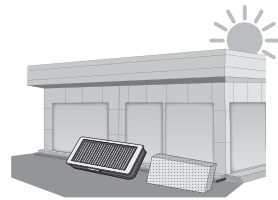

4. Mount the cleaned HEPA filter and sponge filter into the dust bin according to the sequence shown to the right. When assembling the filter, the filter handle should face upward.

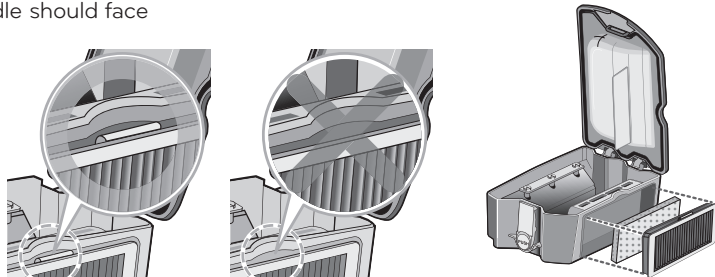

-  **Tip** • In order to maintain the performance of the HOM-BOT, the HEPA filter should be cleaned with a cleaning brush or vacuum cleaner at least once a week, and should be washed under running water at least once a month.

CLEANING THE BRUSH

The brush, located on the bottom of the HOM-BOT, helps with the suction of foreign objects. Perform the following steps to clean the brush:

- 1 Lay a smooth cloth on the floor. Turn the HOM-BOT over and put the HOM-BOT on the cloth. Turn off the power switch before cleaning.

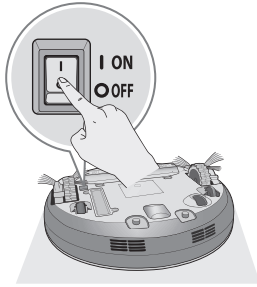

- 2 Separate the cover by pressing the fixing hook and pulling upward.

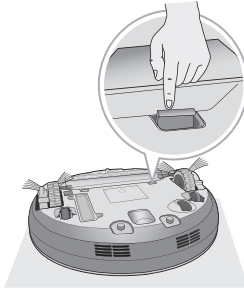

- 3 Wearing gloves turn the brush until the separation groove of the brush appears.

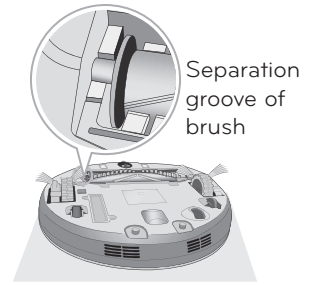

- 4 Grab the brush and remove by pulling it up.

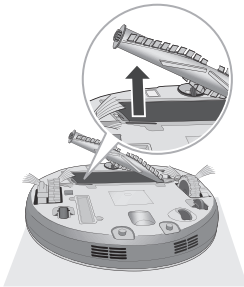

- 5 Clean the brush with a vacuum cleaner, scissors, etc.

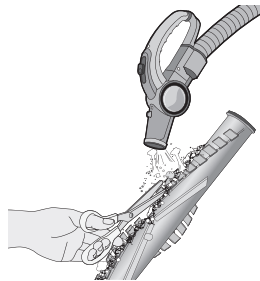

- 6 Insert the fixing hook on the side of the brush (marked with the square) by matching it to the fixing groove of the brush.

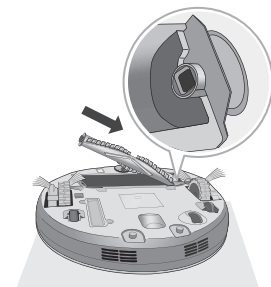

- 7 Insert the fixing hook on the opposite side of the brush (marked with a rounded rectangle) by matching it to the separation groove of the brush.

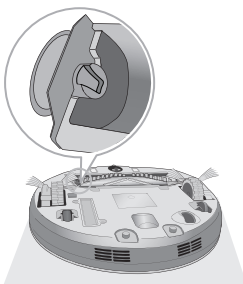

- 8 Align the cover with the fixing guides on the edge, by matching it to the fixing groove located on the main frame.

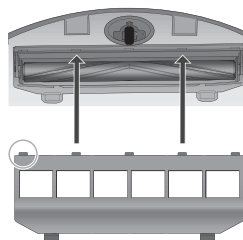

- 9 Close the cover by pressing it down until you hear a click from the fixing hook.
 - NOTE: Please make sure that the side rotating brushes are not caught under the cover when refitting.

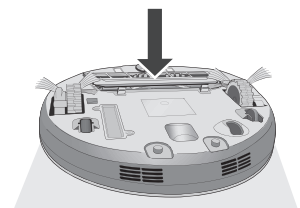

CLEANING THE SENSOR/CHARGING TERMINAL

There are sensors on the HOM-BOT that can detect obstacles, stairways and the home station for charging the battery. In order to maintain the performance of the HOM-BOT, regularly clean the sensors and charging terminal as follows:

1. Lay a smooth cloth on the floor, overturn the HOM-BOT and put it on the cloth.
2. Turn off the power switch on the bottom of the HOM-BOT. Injury can be caused by the activation of the HOM-BOT if the main power is not turned off.
3. Use a smooth cloth or cleaning brush to wipe the dust off each sensor and the charging terminal as described below.

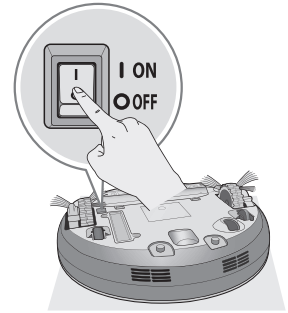

Receiving sensor of remote controller
Camera sensor

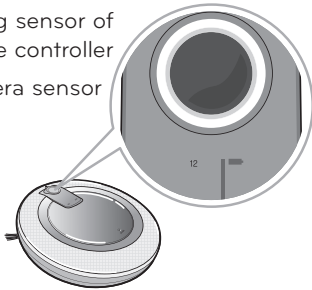

Obstacle detection sensor

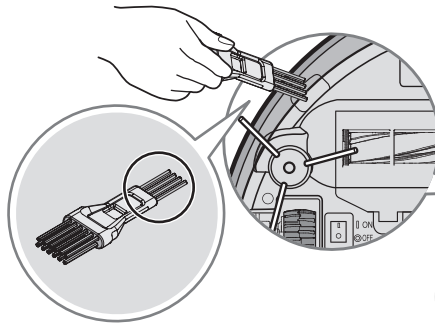
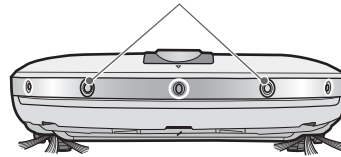

Cliff detection sensor

Charging terminal

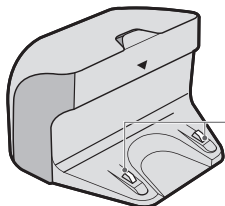

Charging terminal

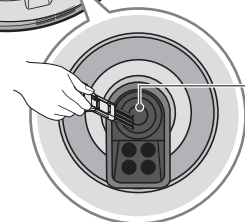

Lens



Tip

- Do not clean the HOM-BOT by directly spraying it with water, thinner, benzene, etc.
- Call the service center if the sensors or charging terminals are damaged. Sensor and terminal damage can cause the product to malfunction.

CLEANING THE SIDE BRUSH

Foreign objects/materials such as hair can easily adhere to the side brush. Remove such materials at least once a week.

If excessive amounts of foreign materials are stuck to the brush, there is a risk of damage to the brushes.

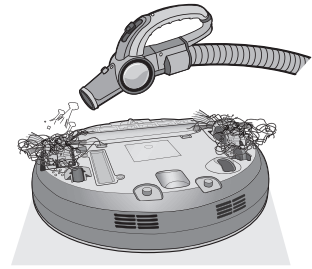

If the floor is rough or wall skirtings are frequently cleaned, the side brush may bend or become damaged. In this case, use the following method to straighten the side brush.

1. The following procedure is helpful in restoring deformed brushes.
2. Turn off the power supply by pressing the START/STOP button on the HOM-BOT for two seconds.
3. Place the HOM-BOT at the end of a table to make cleaning the side brush easier. Make sure that the HOM-BOT is not in danger of falling.
4. Soak the side brush in warm water.
5. Press down on the side brush for about ten seconds so that it is completely submerged in the water.
6. Slowly wipe the side brush by sliding it through your hand.
7. Rotate the side brush and repeat steps 4-6 for each section of the brush.
8. Use the side brush only after it has completely dried.



TROUBLESHOOTING

When the voice, "Please check the wheels", is announced.

If the unit becomes stuck or suspended and the wheels do not allow the unit move, the voice, "Please check the wheels", will be announced.

- Is a wheel trapped in the front door, balcony, stairway, etc?
 - ▶ Move the HOM-BOT on to the flat floor.



- Is any foreign material wound around the wheel?
 - ▶ Lay smooth cloth on the floor, overturn the HOM-BOT, and put it on the cloth. Remove foreign material by confirming the wheel.

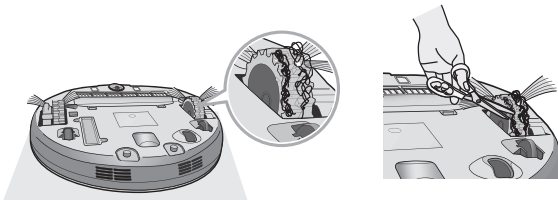

TROUBLESHOOTING

When the voice, "Please check the dust bin", is announced

When an abnormality is detected with the dust bin, the voice, "Please check the dust bin", is announced.

- Is the dust bin fitted correctly?
 - ▶ Open the dust bin cover, and if check if the dust bin is actually fitted. the unit will not operate without the dust bin.
 - ▶ If the dust bin cover opened, close the cover before operating the unit.

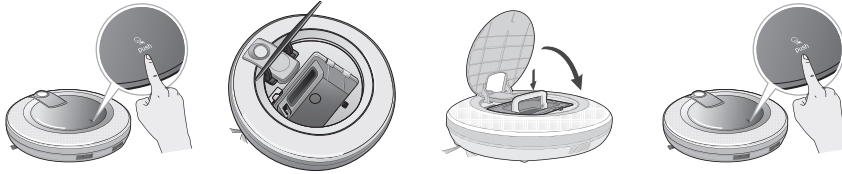

When the voice, "Battery is low", is announced.

When remaining amount of battery is almost nil, the voice, "Battery is low", is generated.

- Initiate battery charging of HOM-BOT by moving it to the home station.
 - ▶ When attaching the HOM-BOT to the home station by matching both arrows of HOM-BOT and home station, charging will be started and the sound of charging start melody will be heard.

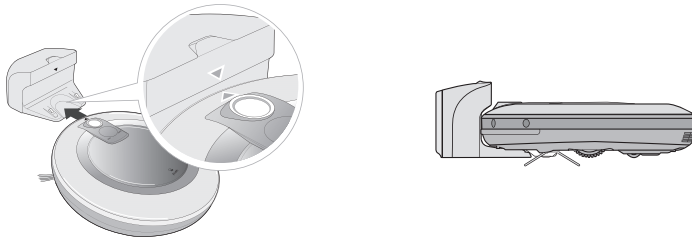

TROUBLESHOOTING

When the voice, "Please check the brush", is announced.

When the Roboking detects that the brush is not functioning properly, you will hear the message "Please check the brush."

Lay a smooth cloth on the floor, overturn the Roboking, and place it on the cloth.

- The side brush is stuck.

- ▶ Remove any foreign materials such as cables, thread or hair caught in the side brush or the brush.

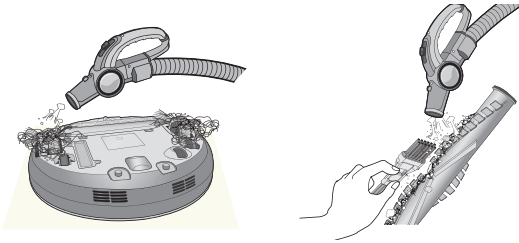

- ▶ Confirm the correct assembly of the brush by checking the separation groove of the brush.

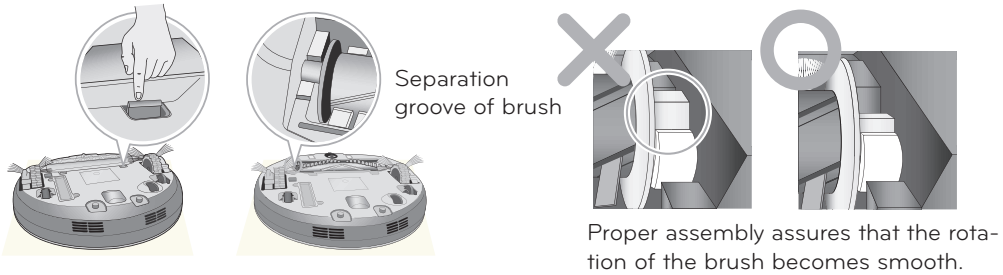

- The brush is making a loud, abnormal sound.

- ▶ Remove the brush from the Roboking and remove any foreign material from the brush.



* For a more detailed description of this process, refer to the instructions on page 24.

BEFORE YOU CALL FOR SERVICE

Confirm before reporting the failure of HOM-BOT.

| Problem | Solutions (Reference page) |
|--|---|
| The HOM-BOT will not activate. | <ul style="list-style-type: none"> ▶ Confirm that the power switch is turned on. (page 14) ▶ Confirm that the battery has been charged. (page 17) |
| Movements or travel path are abnormal. | <ul style="list-style-type: none"> ▶ Carefully wipe the sensor with a smooth cloth. (page 24) ▶ Turn on the power switch off and on. |
| Suction power becomes weak. | <ul style="list-style-type: none"> ▶ Check whether there is foreign material blocking the suction port. (page 23) ▶ Empty the dust bin. (page 21) ▶ Clean the dust bin filter. (page 22) |
| Noise becomes louder. | <ul style="list-style-type: none"> ▶ Confirm that the dust bin has been fitted properly. ▶ Confirm that the dust bin filter has been fitted properly. (page 22) ▶ Check whether foreign material is caught in the brush. (page 23) |
| The HOM-BOT cannot be activated with the remote control. | <ul style="list-style-type: none"> ▶ Replace the remote control batteries. (page 11) ▶ Confirm that the control is within the coverage area of the main frame, which is up to 3 m or 9.84 ft. (page 11) |
| The brush does not rotate. | <ul style="list-style-type: none"> ▶ Clean the brush. (page 23) ▶ Confirm that the brush has been fitted properly. (page 23) |
| The HOM-BOT will not charge. | <ul style="list-style-type: none"> ▶ Remove objects around the home station. (page 13) ▶ Confirm that the power supply is connected to the home station. (page 13) ▶ Wipe the charging terminal with a dry cloth. |
| The power supply automatically turns off. | This is not a failure. HOM-BOT has its own power saving function. If it is not used for ten minutes after the power supply is turned on, the power will automatically turn off. |
| The power supply cannot be turned on. | Check that the power switch on the underside is turned on. (Page 14) |

PRODUCT SPECIFICATIONS

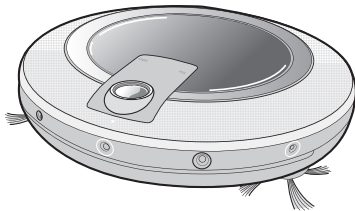

| Item/Model | LG Roboking VR59**L VR59**L* |
|----------------------------|--|
| External dimensions | Φ 360 mm X 90 mm |
| Weight | 3.2 kg |
| Power consumption | 15 W |
| Battery (fully charged) | DC 16.8 V |
| Maximum Traveling Velocity | 350 mm/sec |
| Use time (1 time charging) | Approx. 90 minutes Based on general floor surface |
| Charging time | 3 hours |
| Main functions | Obstacle detection function Falling prevention function Timer cleaning function Error indication function Dry mop function (wiping) (option) Automatic, manual charging function Edge cleaning function Voice announcement function Map building function Spot cleaning function Zigzag cleaning function + cell by cell |

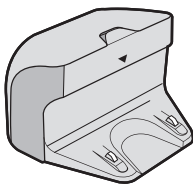

| Item/Model | Home station VR594 |
|------------------------|--------------------------|
| External dimension | 204 mm X 158 mm X 125 mm |
| Rating | AC 220-240 V, 50 Hz |
| Output voltage/current | 17.1 VDC / 1.1 A |
| Power consumption | 23 W |

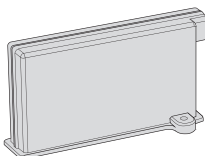

| Item/Model | Battery EAC60766102 |
|------------------|---------------------|
| Charging battery | Lithium polymer |
| Nominal voltage | 14.8 V / 1900mAh |

MEMO

