



LG

Life's Good

OWNER'S MANUAL LED LCD TV

Please read this manual carefully before operating your set and retain it for future reference.

LS669*

CS669*

LM610*

TABLE OF CONTENTS

3 LICENSES

3 OPEN SOURCE SOFTWARE NOTICE

4 SAFETY INSTRUCTIONS

- 4 - Viewing 3D Imaging (Only 3D models)

6 INSTALLATION PROCEDURE

6 ASSEMBLING AND PREPARING

- 6 Unpacking
- 9 Separate purchase
- 10 Parts and buttons
- 10 Lifting and moving the TV
- 12 Setting up the TV
- 13 - Attaching the stand
- 14 - Not using the Desk Type stand
- 15 - Tidying cables
- 16 - Mounting on a table
- 17 - Mounting on a wall

19 MAKING CONNECTIONS

- 19 Antenna connection
- 20 HDMI connection
- 20 DVI to HDMI connection
- 21 RGB-PC connection
- 21 RS-232C Setup
- 21 Component connection
- 22 Composite connection
- 22 Audio connection
 - 22 - Digital optical audio connection
- 23 USB connection
- 23 Headphone connection
- 23 CI module connection
- 24 Euro Scart connection

25 REMOTE CONTROL

27 MAINTENANCE

- 27 Cleaning your TV
 - 27 - Screen, frame, cabinet and stand
 - 27 - Power cord

27 TROUBLESHOOTING

28 SPECIFICATIONS

31 IR CODES

32 EXTERNAL CONTROL DEVICE SETUP

- 32 RS-232C Setup
- 32 Type of connector; D-Sub 9-Pin Male
- 32 RS-232C Configurations
- 33 Communication Parameters
- 33 Command reference list
- 34 Transmission / Receiving Protocol

WARNING

- If you ignore the warning message, you may be seriously injured or there is a possibility of accident or death.

CAUTION

- If you ignore the caution message, you may be slightly injured or the product may be damaged.

NOTE

- The note helps you understand and use the product safely. Please read the note carefully before using the product.

LICENSES



Supported licenses may differ by model. For more information about licenses, visit www.lg.com.



Manufactured under license from Dolby Laboratories. "Dolby" and the double-D symbol are trademarks of Dolby Laboratories.



HDMI, the HDMI logo and High-Definition Multimedia Interface are trademarks or registered trademarks of HDMI Licensing LLC.



ABOUT DIVX VIDEO: DivX® is a digital video format created by DivX, LLC, a subsidiary of Rovi Corporation. This is an official DivX Certified® device that plays DivX video. Visit divx.com for more information and software tools to convert your files into DivX video.

ABOUT DIVX VIDEO-ON-DEMAND: This DivX Certified® device must be registered in order to play purchased DivX Video-on-Demand (VOD) movies. To obtain your registration code, locate the DivX VOD section in your device setup menu. Go to vod.divx.com for more information on how to complete your registration.

"DivX Certified® to play DivX® video up to HD 1080p, including premium content."

"DivX®, DivX Certified® and associated logos are trademarks of Rovi Corporation or its subsidiaries and are used under license."

Covered by one or more of the following U.S. patents :
7,295,673; 7,460,668; 7,515,710; 7,519,274

OPEN SOURCE SOFTWARE NOTICE

To obtain the source code under GPL, LGPL, MPL and other open source licenses, that is contained in this product, please visit <http://opensource.lge.com>.

In addition to the source code, all referred license terms, warranty disclaimers and copyright notices are available for download.

LG Electronics will also provide open source code to you on CD-ROM for a charge covering the cost of performing such distribution (such as the cost of media, shipping and handling) upon email request to opensource@lge.com. This offer is valid for three (3) years from the date on which you purchased the product.

SAFETY INSTRUCTIONS

Please read these safety precautions carefully before using the product.

Viewing 3D Imaging (Only 3D models)



WARNING

Viewing Environment

- Viewing Time
 - When watching 3D contents, take 5 - 15 minute breaks every hour. Viewing 3D contents for a long period of time may cause headache, dizziness, fatigue or eye strain.

Those that have a photosensitive seizure or chronic illness

- Some users may experience a seizure or other abnormal symptoms when they are exposed to a flashing light or particular pattern from 3D contents.
- Do not watch 3D videos if you feel nausea, are pregnant and/ or have a chronic illness such as epilepsy, cardiac disorder, or blood pressure disease, etc.
- 3D Contents are not recommended to those who suffer from stereo blindness or stereo anomaly. Double images or discomfort in viewing may be experienced.
- If you have strabismus (cross-eyed), amblyopia (weak eyesight) or astigmatism, you may have trouble sensing depth and easily feel fatigue due to double images. It is advised to take frequent breaks than the average adult.
- If your eyesight varies between your right and left eye, revise your eyesight prior to watching 3D contents.

Symptoms which require discontinuation or refraining from watching 3D contents

- Do not watch 3D contents when you feel fatigue from lack of sleep, overwork or drinking.
- When these symptoms are experienced, stop using/watching 3D contents and get enough rest until the symptom subsides.
 - Consult your doctor when the symptoms persist. Symptoms may include headache, eyeball pain, dizziness, nausea, palpitation, blurriness, discomfort, double image, visual inconvenience or fatigue.



CAUTION

Viewing Environment

- Viewing Distance
 - Maintain a distance of at least twice the screen diagonal length when watching 3D contents. If you feel discomfort in viewing 3D contents, move further away from the TV.

Viewing Age

- Infants/Children
 - Usage/ Viewing 3D contents for children under the age of 5 are prohibited.
 - Children under the age of 10 may overreact and become overly excited because their vision is in development (for example: trying to touch the screen or trying to jump into it. Special monitoring and extra attention is required for children watching 3D contents.
 - Children have greater binocular disparity of 3D presentations than adults because the distance between the eyes is shorter than one of adults. Therefore they will perceive more stereoscopic depth compared to adults for the same 3D image.
- Teenagers
 - Teenagers under the age of 19 may react with sensitivity due to stimulation from light in 3D contents. Advise them to refrain from watching 3D contents for a long time when they are tired.
- Elderly
 - The elderly may perceive less 3D effect compared to the youth. Do not sit closer to the TV than the recommended distance.

Cautions when using the 3D glasses

- Make sure to use LG 3D glasses. Otherwise, you may not be able to view 3D videos properly.
- Do not use 3D glasses instead of your normal glasses, sunglasses or protective goggles.
- Using modified 3D glasses may cause eye strain or image distortion.
- Do not keep your 3D glasses in extremely high or low temperatures. It will cause deformation.
- The 3D glasses are fragile and are easy to be scratched. Always use a soft, clean piece of cloth when wiping the lenses. Do not scratch the lenses of the 3D glasses with sharp objects or clean/wipe them with chemicals.

NOTE

- Image shown may differ from your TV.
- Your TV's OSD (On Screen Display) may differ slightly from that shown in this manual.
- The available menus and options may differ from the input source or product model that you are using.
- New features may be added to this TV in the future.
- The TV can be placed in standby mode in order to reduce the power consumption. And the TV should be turned off if it will not be watched for some time, as this will reduce energy consumption.
- The energy consumed during use can be significantly reduced if the level of brightness of the picture is reduced, and this will reduce the overall running cost.

INSTALLATION PROCEDURE

- 1 Open the package and make sure all the accessories are included.
- 2 Attach the stand to the TV set.
- 3 Connect an external device to the TV set.
- 4 Make sure the network connection is available.
You can use the TV network functions only when the network connection is made.
(Only 42/47/55LM610*)

ASSEMBLING AND PREPARING

Unpacking

Check your product box for the following items. If there are any missing accessories, contact the local dealer where you purchased your product. The illustrations in this manual may differ from the actual product and item.

CAUTION

- Do not use any unapproved items to ensure the safety and product life span.
- Any damages or injuries by using unapproved items are not covered by the manufacturer's warranty.
- Some models have a thin film attached on to the screen and this must not be removed.

NOTE

- The items supplied with your product may vary depending on the model.
- Product specifications or contents of this manual may be changed without prior notice due to upgrade of product functions.
- For an optimal connection, HDMI cables and USB devices should have bezels less than 10 mm thick and 18 mm width. Use an extension cable that supports USB 2.0 if the USB cable or USB memory stick does not fit into your TV's USB port.

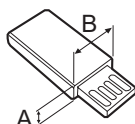
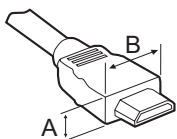

*A ≤ 10 mm

*B ≤ 18 mm

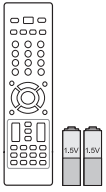

Remote control and batteries (AAA)
(see p.25, 26)



Owner's manual



Polishing cloth
(Depending on model)
Use this to remove dust from the cabinet.

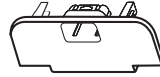

Protection cover
(Only 32/42/47CS669*)
(See p.14)

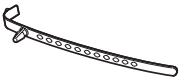

Cable Holder
(Only 32/42/47LS669*,
42/47/55LM610*)
(see p.15)



Power Cord



Stand Screws
8 EA, M4 x 20
(see p.13, 14)



Desk-mount Screw
1EA
(Only 32/42/47LS669*,
32/42CS669*)
(see p.16)



Wall mount inner spacers
4EA
(Only 32/42/47LS669*,
42/47/55LM610*)
(see p.18)

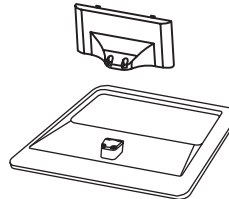

Stand Body / Stand Base
(Only 32/42/47LS669*)
(see p.13)

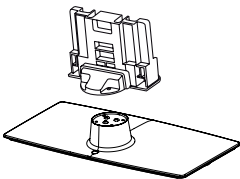

Stand Body / Stand Base
(Only 32/42/47CS669*)
(see p.13)

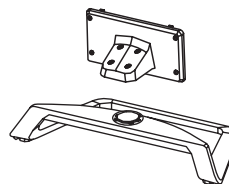

Stand Body / Stand Base
(Only 42/47/55LM610*)
(see p.14)

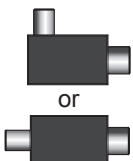

Isolator
(Depending on model)
(See p.8)



Cinema 3D Glasses
The number of 3D glasses may differ depending on the model or country.
(Only 42/47/55LM610*)

⚠ CAUTION

- Power Cord Installation Guide
 - If the power cord provided with TV looks like the below picture, please ensure that it is inserted in the right direction.

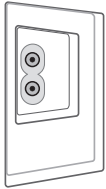

TV

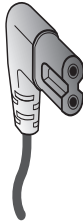

Power Cord

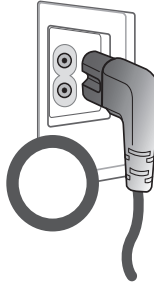

Correct

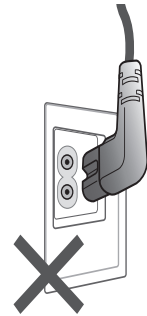

Wrong

⚠ NOTE

- Antenna Isolator Installation Guide
 - Use this to install TV in a place where there is a voltage difference between TV Set and GND of antenna signal.
 - » If there is a voltage difference between TV Set and GND of antenna signal, the antenna contact might be heated and excessive heat might cause an accident.
 - You can improve the safety when watching TV by efficiently removing power voltage from TV antenna. It is recommended to mount the isolator to the wall. If it cannot be mounted to the wall, mount it on the TV. Avoid disconnecting the antenna Isolator after installation.
 - Before starting, be sure that the TV antenna is connected.

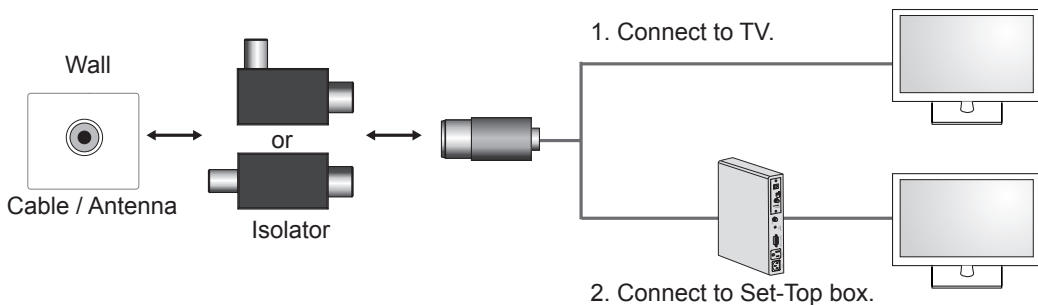

Connect one end of the isolator to cable/antenna jack and the other to TV set or set-top box.

“Equipment connected to the protective earthing of the building installation through the mains connection or through other equipment with a connection to protective earthing - and to a cable distribution system using coaxial cable, may in some circumstances create a fire hazard. Connection to a cable distribution system has therefore to be provided through a device providing electrical isolation below a certain frequency range (galvanic isolator, see EN 60728-11)”

When applying the RF Isolator, a slight loss of signal sensitivity can occur.

Separate purchase

Separate purchase items can be changed or modified for quality improvement without any notification. Contact your dealer to buying these items.

These devices only work with certain models.



AG-F2, AG-F3****

Cinema 3D Glasses

Compatibility	42/47/55LM610*	32/42/47LS669* 32/42/47CS669*
AG-F2**, AG-F3** Cinema 3D Glasses	•	

The model name or design may be changed depending on the upgrade of product functions, manufacturer's circumstances or policies.

Parts and buttons

Only 32/42/47LS669*, 42/47/55LM610*

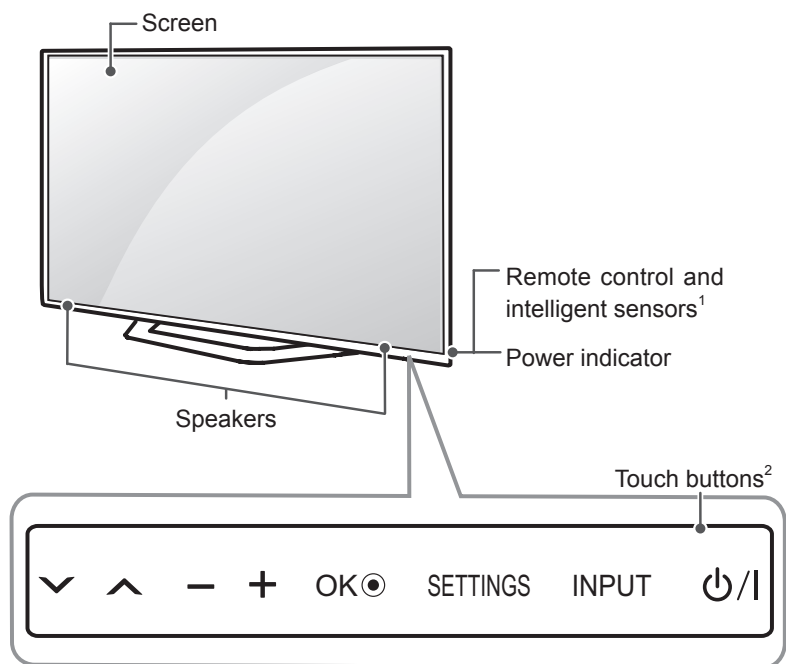

Buttons	Description
✓ ^	Scrolls through the saved programmes.
- +	Adjusts the volume level.
OK ●	Selects the highlighted menu option or confirms an input.
SETTINGS	Accesses the main menu, or saves your input and exits the menus.
INPUT	Changes the input source.
⏻ /	Turns the power on or off.

- 1 Intelligent sensor - Adjusts the image quality and brightness based on the surrounding environment.
- 2 Touch Button - You can use the desired button function by touching.

! NOTE

- You can set the power indicator light to on or off by selecting **OPTION** in the main menus.

Only 32/42/47CS669*

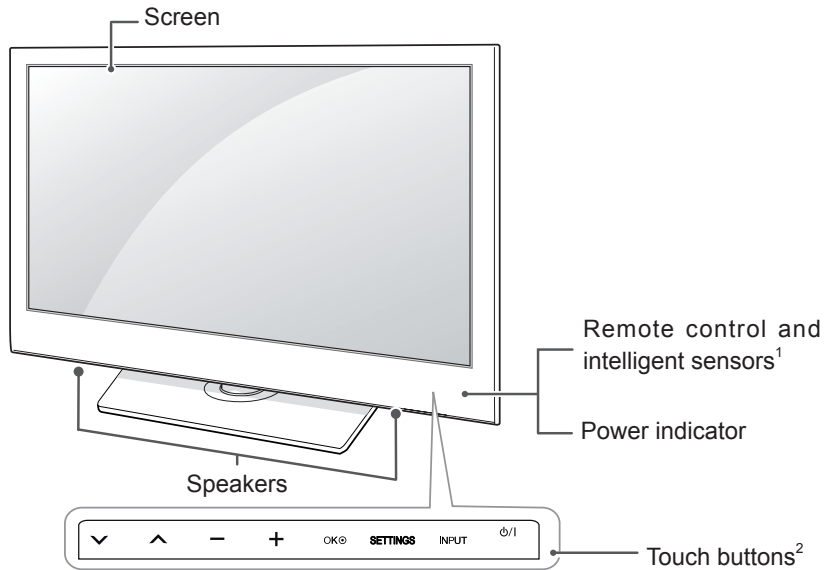

Buttons	Description
∨ ^	Scrolls through the saved programmes.
- +	Adjusts the volume level.
OK ⊙	Selects the highlighted menu option or confirms an input.
SETTINGS	Accesses the main menu, or saves your input and exits the menus.
INPUT	Changes the input source.
⏻ / I	Turns the power on or off.

- 1 Intelligent sensor - Adjusts the image quality and brightness based on the surrounding environment.
- 2 Touch Button - You can use the desired button function by touching.

! NOTE

- You can set the power indicator light to on or off by selecting **OPTION** in the main menus.

Lifting and moving the TV

When moving or lifting the TV, read the following to prevent the TV from being scratched or damaged and for safe transportation regardless of its type and size.



CAUTION

- Avoid touching the screen at all times, as this may result in damage to the screen.
- It is recommended to move the TV in the box or packing material that the TV originally came in.
- Before moving or lifting the TV, disconnect the power cord and all cables.
- When holding the TV, the screen should face away from you to avoid damage.

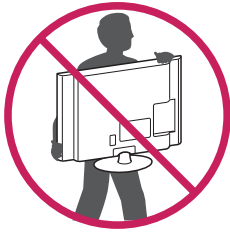

- Hold the top and bottom of the TV frame firmly. Make sure not to hold the transparent part, speaker, or speaker grill area.

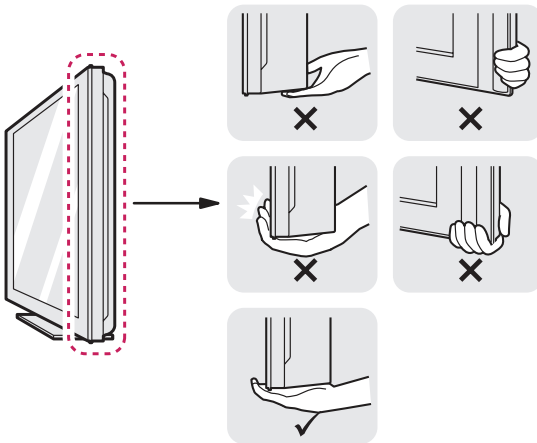

- When transporting a large TV, there should be at least 2 people.
- When transporting the TV by hand, hold the TV as shown in the following illustration.

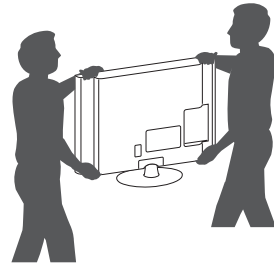

- When transporting the TV, do not expose the TV to jolts or excessive vibration.
- When transporting the TV, keep the TV upright, never turn the TV on its side or tilt towards the left or right.

Setting up the TV

Attaching the stand

Only 32/42/47LS669*

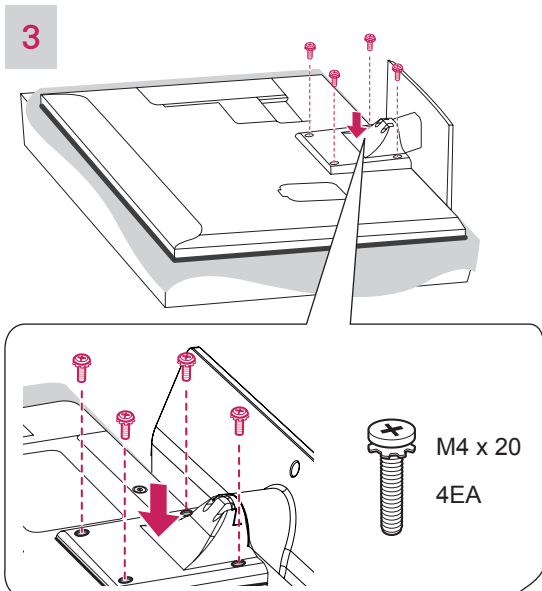
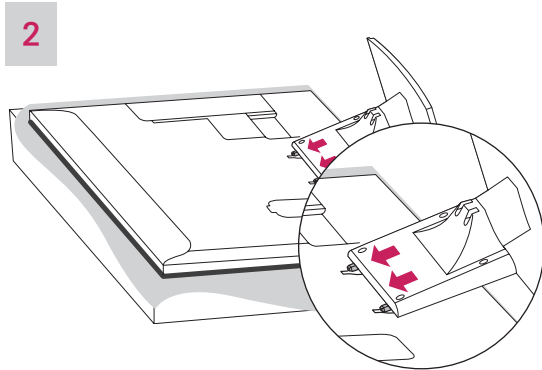
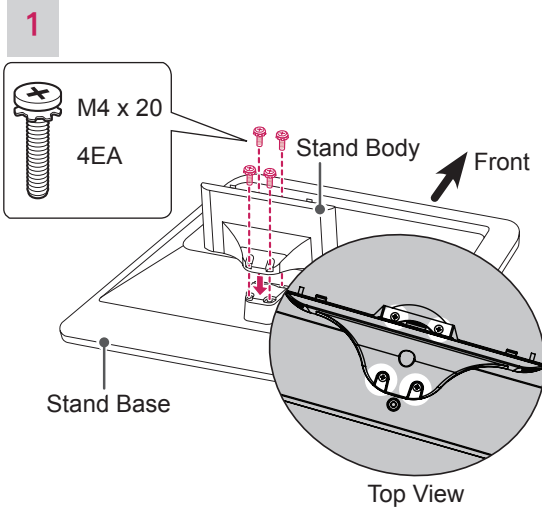

Only 32/42/47CS669*

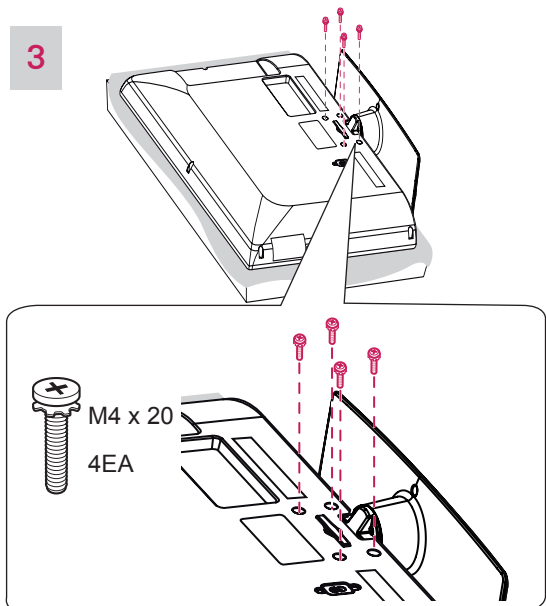
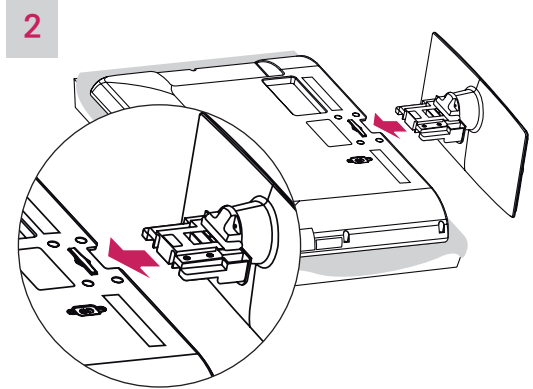
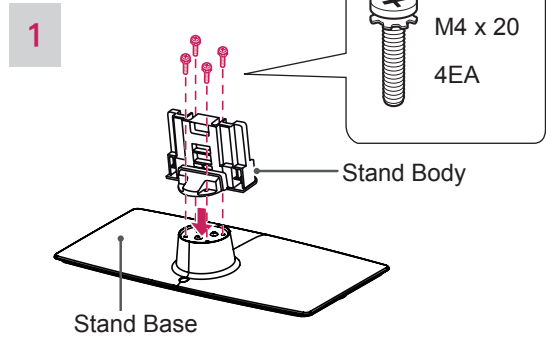

Only 42/47/55LM610*

1

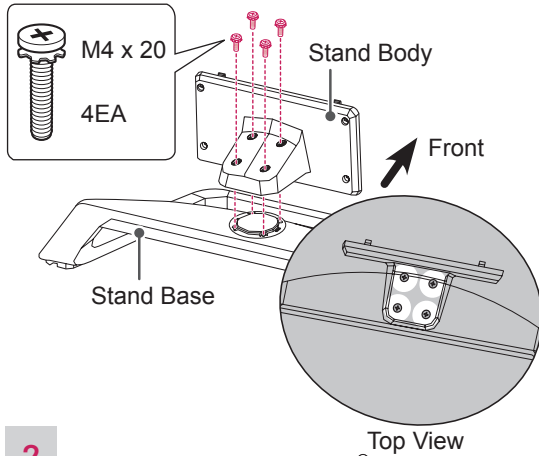

2

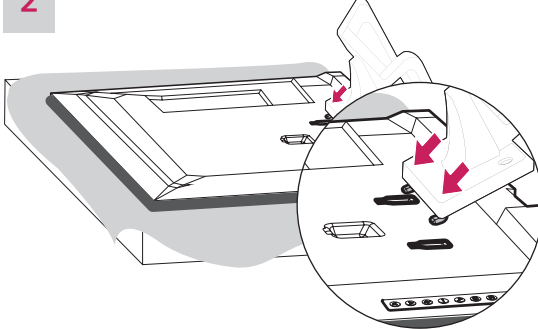

3

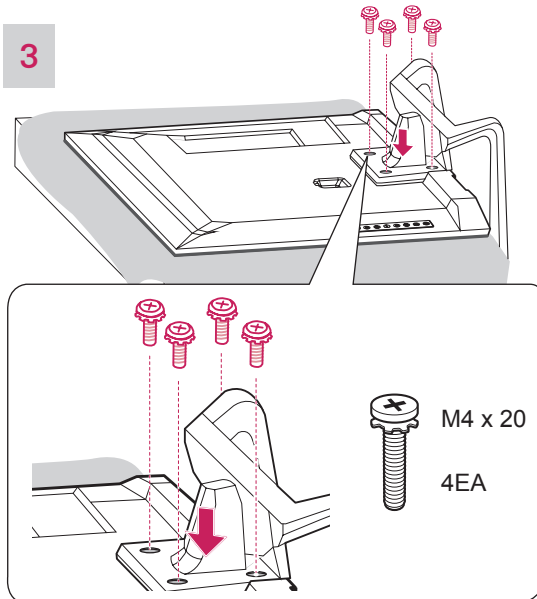

CAUTION

- When attaching the stand to the TV set, place the screen facing down on a cushioned table or flat surface to protect the screen from scratches.
- Make sure that the screws are inserted correctly and fastened securely. If they are not fastened securely enough, the TV may tilt forward after being installed. Do not use too much force and over tighten the screws; otherwise screw may be damaged and not tighten correctly.

NOTE

- Remove the stand before installing the TV on a wall mount by performing the stand attachment in reverse.

Not using the Desk Type stand

Only 32/42/47CS669*

- 1 Push the supplied Protection cover into the opening at the bottom of the TV until clicking sound.

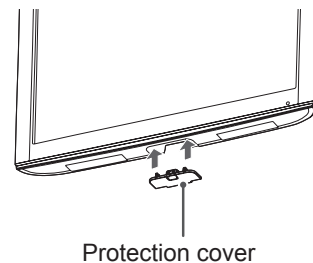

Tidying cables

Only 32/42/47LS669*

- 1 Gather and bind the cables with the Cable Holder.

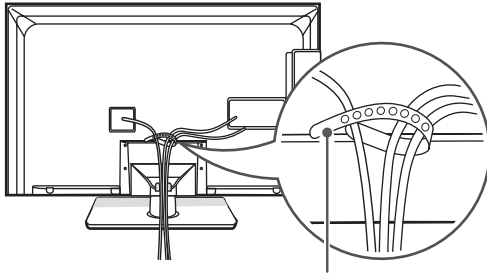

Cable Holder

Only 42/47/55LM610*

- 1 Gather and bind the cables with the Cable Management.
- 2 Fix the Cable Management firmly to the TV.

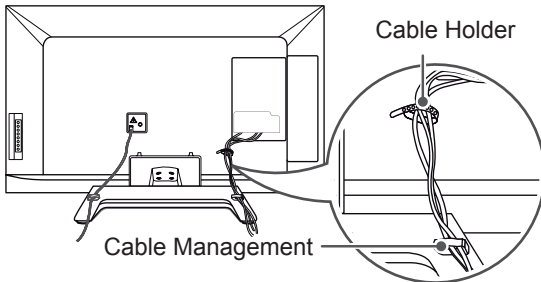

CAUTION

- Do not move the TV by holding the cable holder, as the cable holders may break, and injuries and damage to the TV may occur.

Mounting on a table

- Lift and tilt the TV into its upright position on a table.
 - Leave a 10 cm (minimum) space from the wall for proper ventilation.

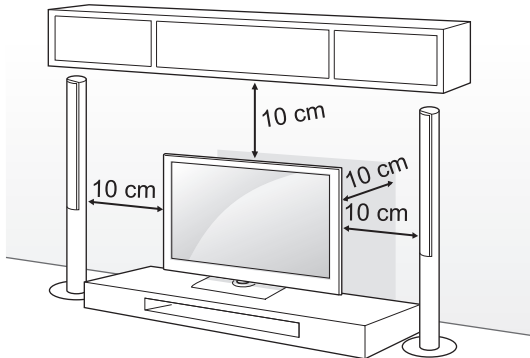

- Connect the power cord to a wall outlet.



CAUTION

- Do not place the TV near or on sources of heat, as this may result in fire or other damage.

Securing the TV to a table

Fix the TV to a table to prevent from tilting forward, damage, and potential injury. Mount the TV on a table, and then insert and tighten the supplied screw on the rear of the stand. (Only 32/42/47LS669*, 32/42CS669*)

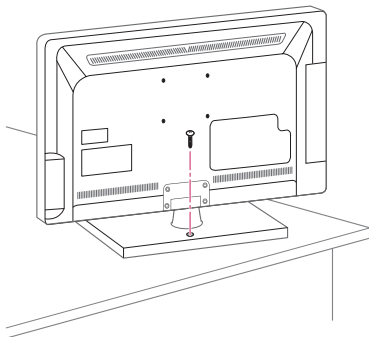

WARNING

- To prevent TV from falling over, the TV should be securely attached to the floor/wall per installation instructions. Tipping, shaking, or rocking the TV may cause injury.

Adjusting the angle of the TV to suit view

(Only 32/42/47LS669*, 32/42/47CS669*)

Swivel 20 degrees to the left or right and adjust the angle of the TV to suit your view.

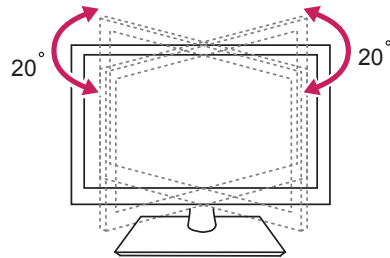

(Only 42/47/55LM610*)

Swivel 10 degrees to the left or right and adjust the angle of the TV to suit your view.

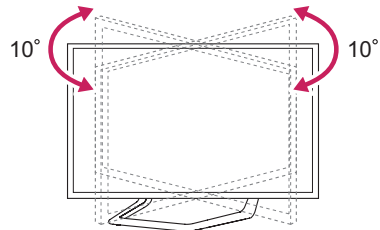

CAUTION

- When adjusting the angle of the product, watch out for your fingers.
 - Personal injury may occur if hands or fingers are pinched. If the product is tilted too much, it may fall, causing damage or injury.

(Only 42/47/55LM610*)

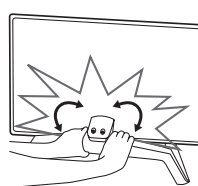

<Rear>

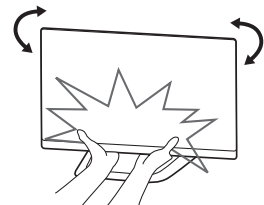

<Front>

Securing the TV to a wall

(This feature is not available for all models.)

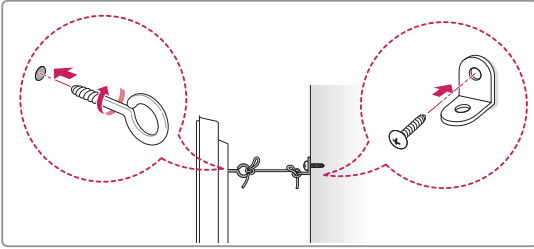
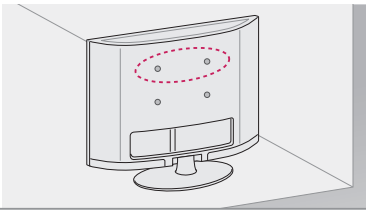

- 1 Insert and tighten the eye-bolts, or TV brackets and bolts on the back of the TV.
 - If there are bolts inserted at the eye-bolts position, remove the bolts first.
- 2 Mount the wall brackets with the bolts to the wall.

Match the location of the wall bracket and the eye-bolts on the rear of the TV.
- 3 Connect the eye-bolts and wall brackets tightly with a sturdy rope.

Make sure to keep the rope horizontal with the flat surface.

**CAUTION**

- Make sure that children do not climb on or hang on the TV.

**NOTE**

- Use a platform or cabinet that is strong and large enough to support the TV securely.
- Brackets, bolts and ropes are not provided. You can obtain additional accessories from your local dealer.

Using the Kensington security system

(This feature is not available for all models.)

The Kensington security system connector is located at the rear of the TV. For more information of installation and using, refer to the manual provided with the Kensington security system or visit <http://www.kensington.com>.

Connect the Kensington security system cable between the TV and a table.

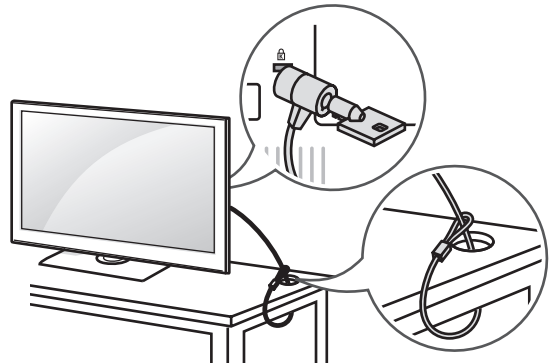
**Mounting on a wall**

Attach an optional wall mount bracket at the rear of the TV carefully and install the wall mount bracket on a solid wall perpendicular to the floor. When you attach the TV to other building materials, please contact qualified personnel. LG recommends that wall mounting be performed by a qualified professional installer.

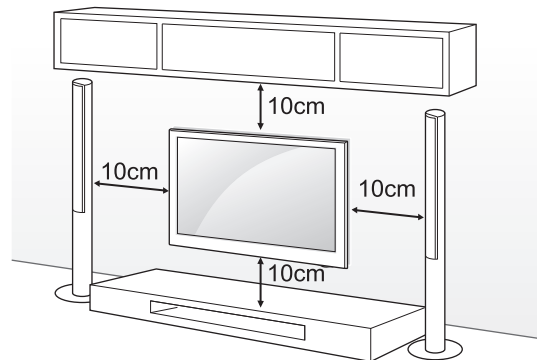

Make sure to use screws and wall mount bracket that meet the VESA standard. Standard dimensions for the wall mount kits are described in the following table.

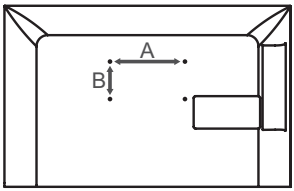

Separate purchase (Wall Mounting Bracket)

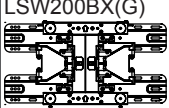
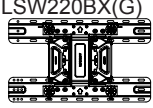
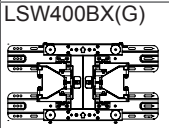
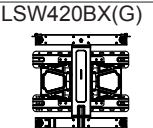
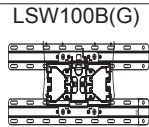
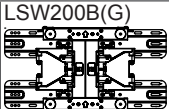
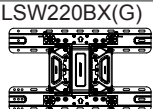
Model	32LS669*	
VESA (A x B)	200 x 200	
Standard screw	M6	
Number of screws	4	
Wall mount bracket		
Model	42/47LS669* 42/47/55LM610*	
VESA (A x B)	400 x 400	
Standard screw	M6	
Number of screws	4	
Wall mount bracket		
Model	32CS669*	
VESA (A x B)	200 x 100	
Standard screw	M4	
Number of screws	4	
Wall mount bracket		
Model	42/47CS669*	
VESA (A x B)	200 x 200	
Standard screw	M6	
Number of screws	4	
Wall mount bracket		

CAUTION

- Disconnect the power first, and then move or install the TV. Otherwise electric shock may occur.
- If you install the TV on a ceiling or slanted wall, it may fall and result in severe injury. Use an authorized LG wall mount bracket and contact the local dealer or qualified personnel.
- Do not over tighten the screws as this may cause damage to the TV and void your warranty.
- Use the screws and wall mount bracket that meet the VESA standard. Any damages or injuries by misuse or using an improper accessory are not covered by the warranty.

NOTE

- Use the screws that are listed on the VESA standard screw specifications.
- The wall mount kit includes an installation manual and necessary parts.
- The wall mount bracket is not provided. You can obtain additional accessories from your local dealer.
- The length of screws may differ depending on the wall mount. Make sure to use the proper length.
- For more information, refer to the manual supplied with the wall mount.
- When attaching a third-party wall mounting bracket to the TV, insert the wall mount inner spacers into the TV wall mount holes to move your TV in vertical angle. Please make sure not to use the spacers for LG wall mounting bracket. (Only 32/42/47LS669*, 42/47/55LM610*)

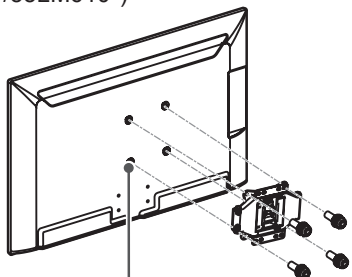

Wall Mount Inner Spacer

MAKING CONNECTIONS

This section on **MAKING CONNECTIONS** mainly uses diagrams for the 32/42/47CS669* models.

Connect various external devices to the TV and switch input modes to select an external device. For more information on external device's connection, refer to the manual provided with each device.

Available external devices are: HD receivers, DVD players, VCRs, audio systems, USB storage devices, PC, gaming devices, and other external devices.

! NOTE

- The external device connection may differ from the model.
- Connect external devices to the TV regardless of the order of the TV port.
- If you record a TV program on a DVD recorder or VCR, make sure to connect the TV signal input cable to the TV through a DVD recorder or VCR. For more information on recording, refer to the manual provided with the connected device.
- Refer to the external equipment's manual for operating instructions.
- If you connect a gaming device to the TV, use the cable supplied with the gaming device.
- In PC mode, there may be noise associated with the resolution, vertical pattern, contrast or brightness. If noise is present, change the PC output to another resolution, change the refresh rate to another rate or adjust the brightness and contrast on the PICTURE menu until the picture is clear.
- In PC mode, some resolution settings may not work properly depending on the graphics card.

Antenna connection

Connect the TV to a wall antenna socket with an RF cable (75 Ω).

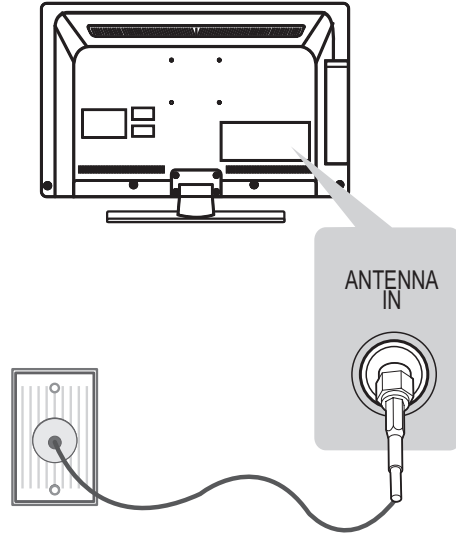

! NOTE

- Use a signal splitter to use more than 2 TVs.
- If the image quality is poor, install a signal amplifier properly to improve the image quality.
- If the image quality is poor with an antenna connected, try to realign the antenna in the correct direction.
- An antenna cable and converter are not supplied.

HDMI connection

Transmits the digital video and audio signals from your PC to the TV. Connect the PC and the TV with the HDMI cable as shown. Choose any HDMI input port to connect. It does not matter which port you use.

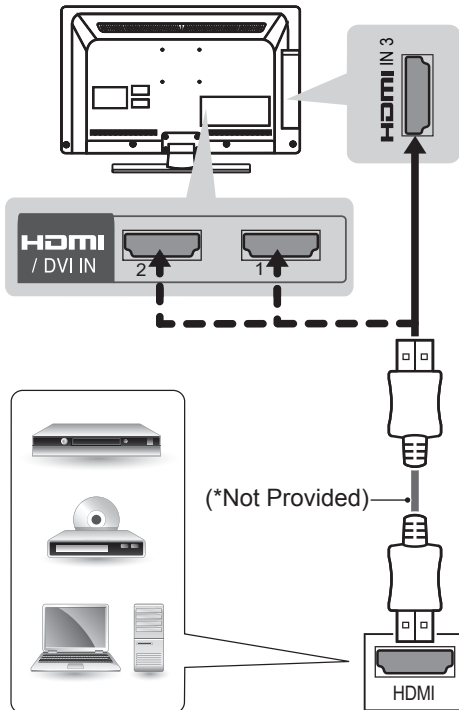

DVD/ Blu-Ray / HD Cable Box / HD STB / PC

NOTE

- It is recommended to use the TV with the HDMI connection for the best image quality.
- Use the latest High Speed HDMI™ Cable with CEC (Customer Electronics Control) function.
- High Speed HDMI™ Cables are tested to carry an HD signal up to 1080p and higher.
- Supported DTV Audio: MPEG, Dolby Digital, Dolby Digital Plus, HE-AAC
- Supported HDMI Audio format : Dolby Digital, PCM (Up to 192 KHz, 32k/44.1k/48k /88k/96k/176k/192k, DTS Not supported.)

DVI to HDMI connection

Transmits the digital video signal from an external device to the TV. Connect the external device and the TV with the DVI-HDMI cable as shown. To transmit an audio signal, connect an audio cable. Choose any HDMI input port to connect. It does not matter which port you use.

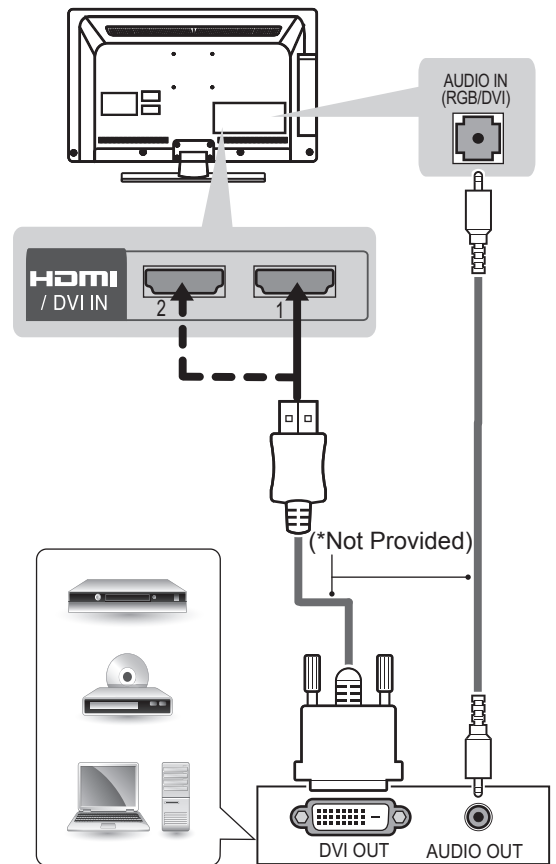

DVD/ Blu-Ray / HD Cable Box / PC

NOTE

- Depending on the graphics card, DOS mode may not work if a HDMI to DVI Cable is in use.

RGB-PC connection

Transmits the video signal from PC to the TV. To transmit an audio signal, connect an audio cable.

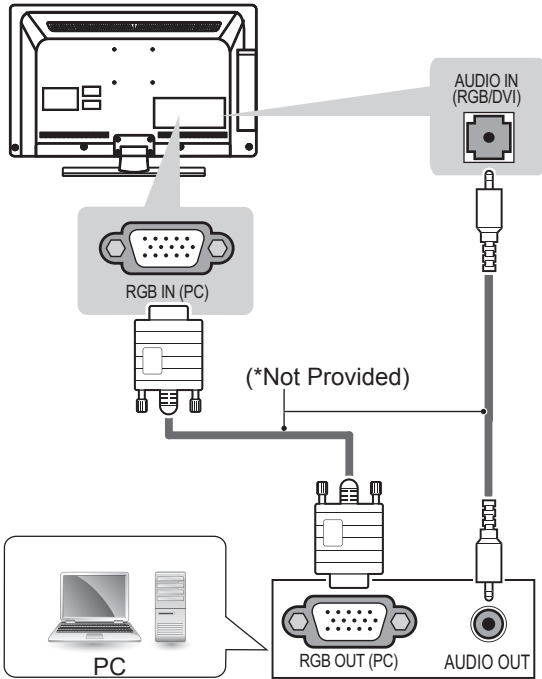

RS-232C Setup

(Only 32/42/47CS669*)

Connect the RS-232C (serial port) input jack to an external control device (such as a computer or an A/V control system) to control the product's functions externally.

Connect the serial port of the control device to the RS-232C jack on the product back panel.

Note: RS-232C connection cables are not supplied with the product.

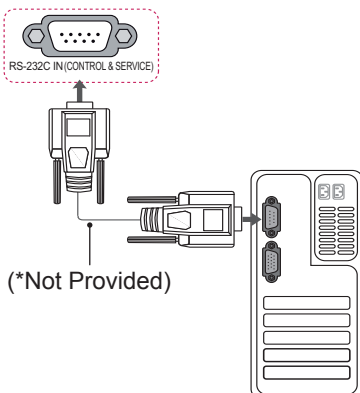

Component connection

Transmits the analogue video and audio signals from an external device to the TV. Connect the external device and the TV with the component cable as shown.

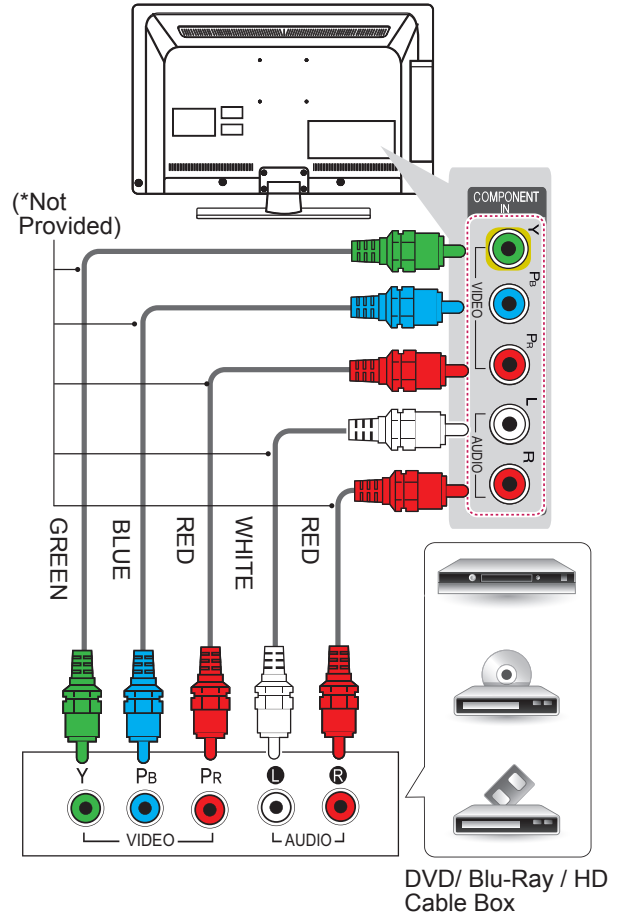

! NOTE

- If cables are not installed correctly, it could cause this image to display in black and white or with distorted colours.

Composite connection

Transmits analog video and audio signals from an external device to the TV. Connect the external device and the TV with the composite cable as shown.

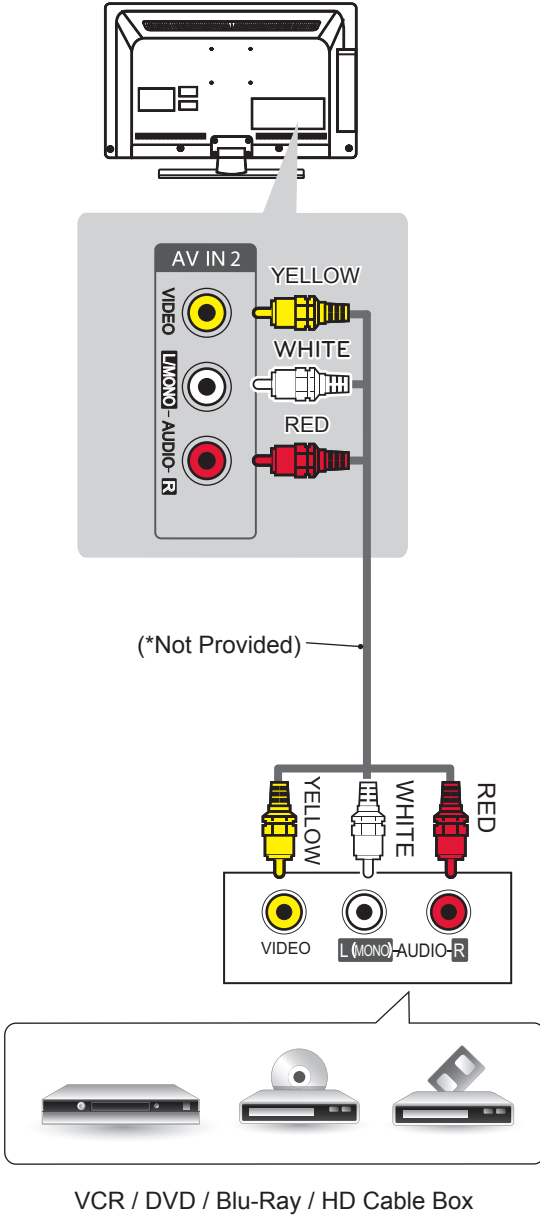

Audio connection

You may use an optional external audio system instead of the built-in speaker.

! NOTE

- If you use an optional external audio device instead of the built-in speaker, set the TV speaker feature to off.

Digital optical audio connection

Transmits a digital audio signal from the TV to an external device. Connect the external device and the TV with the optical audio cable as shown.

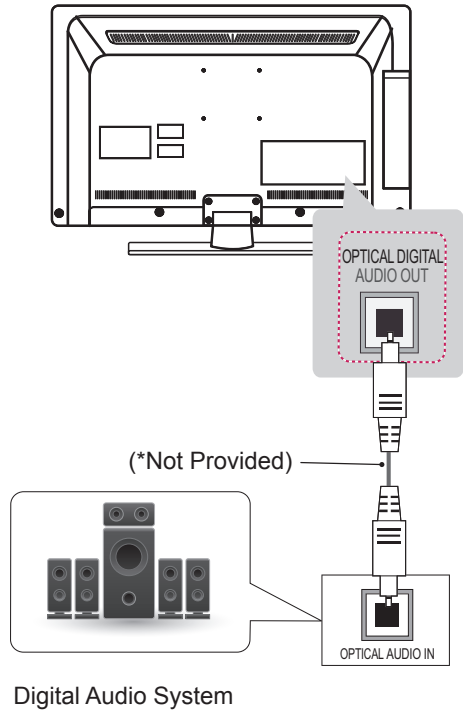

! NOTE

- Do not look into the optical output port. Looking at the laser beam may damage your vision.
- Audio with ACP (Audio Copy Protection) function may block digital audio output.

USB connection

Connect a USB storage device such as a USB flash memory, external hard drive or a USB memory card reader to the TV and access the My media menu to use various multimedia files.

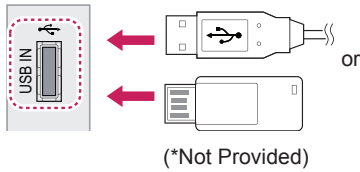

CI module connection

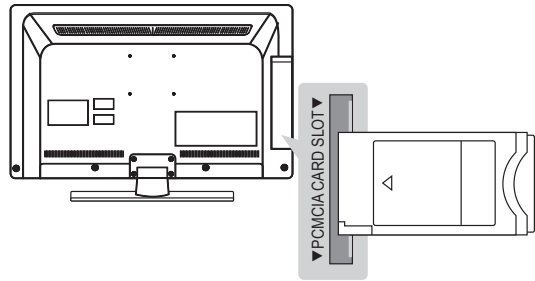

Headphone connection

Transmits the headphone signal from the TV to an external device. Connect the external device and the TV with the headphone as shown.

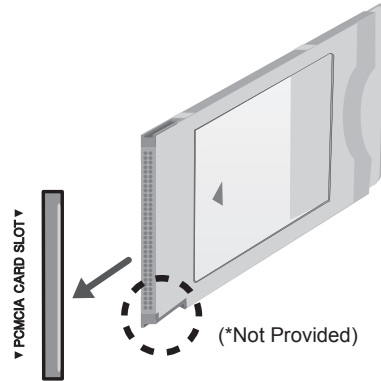
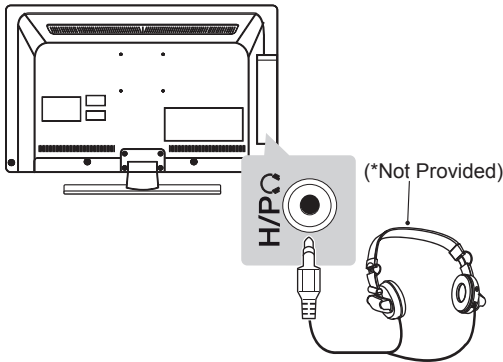

View the encrypted (pay) services in digital TV mode. This feature is not available in all countries.

! NOTE

- Check if the CI module is inserted into the PCMCIA card slot in the right direction. If the module is not inserted properly, this can cause damage to the TV and the PCMCIA card slot.

! NOTE

- AUDIO menu items are disabled when connecting a headphone.
- When changing AV MODE with a headphone connected, the change is applied to video but not to audio. (Only 42/47/55LM610*)
- Optical Digital Audio Out is not available when connecting a headphone.
- Headphone impedance: 16 Ω
- Max audio output of headphone: 9 mW to 15 mW
- Headphone jack size: 0.35 cm

Euro Scart connection

Transmits the video and audio signals from an external device to the TV set. Connect the external device and the TV set with the euro scart cable as shown. To display images by using progressive scan, make sure to use the euro scart cable.

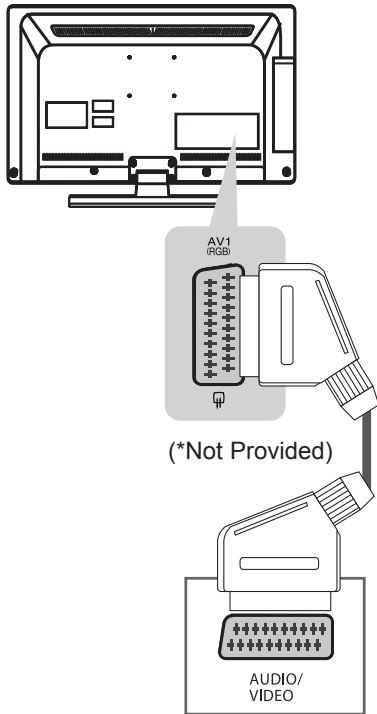

Current input model \ Output Type	AV (TV Out ¹)
Digital TV	Digital TV
Analogue TV, AV	Analogue TV
Component / RGB	
HDMI	

1. TV Out : Outputs Analogue TV or Digital TV signals.

! NOTE

- Any Euro scart cable used must be signal shielded.
- When watching digital TV in 3D imaging mode, TV/Monitor out signals cannot be output through the SCART cable. (Only 3D models)
- If you set the 3D mode to On while a scheduled recording is performed on digital TV, monitor out signals cannot be output through the SCART cable, and the recording cannot be performed. (Only 3D models)

REMOTE CONTROL

The descriptions in this manual are based on the buttons on the remote control.

Please read this manual carefully and use the TV correctly.

To replace batteries, open the battery cover, replace batteries (1.5 V AAA) matching the ⊕ and ⊖ ends to the label inside the compartment, and close the battery cover.

To remove the batteries, perform the installation actions in reverse.

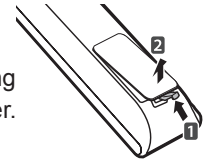

⚠ CAUTION

- Do not mix old and new batteries, as this may damage the remote control.

Make sure to point the remote control toward the remote control sensor on the TV.

(Only 32/42/47LS669*, 32/42/47CS669*)

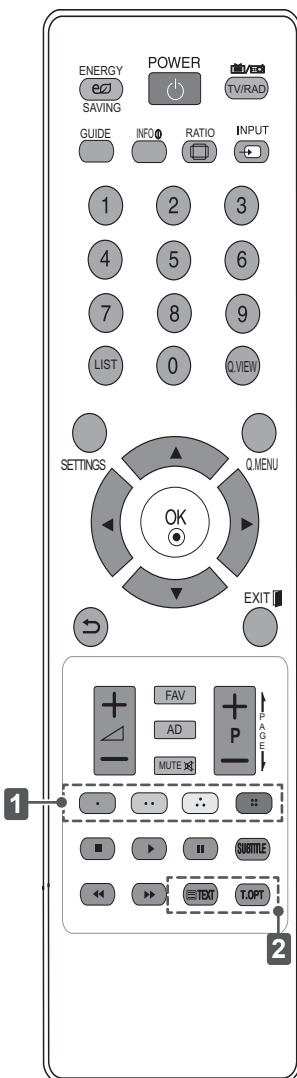

ENERGY SAVING	Adjusts the brightness of the screen to reduce energy consumption.
POWER	Turns the TV on or off.
TV/ RAD	Selects Radio, TV and DTV programme.
GUIDE	Shows programme guide.
INFO	Views the information of the current programme and screen.
RATIO	Resizes an image.
INPUT	Changes the input source.
Number buttons	Enters numbers.
LIST	Accesses the saved programme list.
Q.VIEW	Returns to the previously viewed programme.
SETTINGS	Accesses the main menus.
Q. MENU	Accesses the Quick menus.
Navigation buttons (up/down/left/right)	Scrolls through menus or options.
OK	Moves to the previous or next screen.
↩	Returns to the previous level.
EXIT	Clears all on-screen displays and return to TV viewing.
+ -	Adjusts the volume level.
P + -	Scrolls through the saved programmes.
FAV	Accesses your favourite programme list.
AD	Switches the Audio Description on or off.
MUTE	Mutes all sounds.
← PAGE →	Moves to the previous or next screen.
1 Coloured buttons	These access special functions in some menus. (: Red, : Green, : Yellow, : Blue)
SUBTITLE	Recalls your preferred subtitle in digital mode.
Control buttons (, , , ,)	Controls the MY MEDIA menus, or the SIMPLINK compatible devices (USB, SIMPLINK).
2 TELETEXT BUTTONS	These buttons are used for teletext.

(Only 42/47/55LM610*)

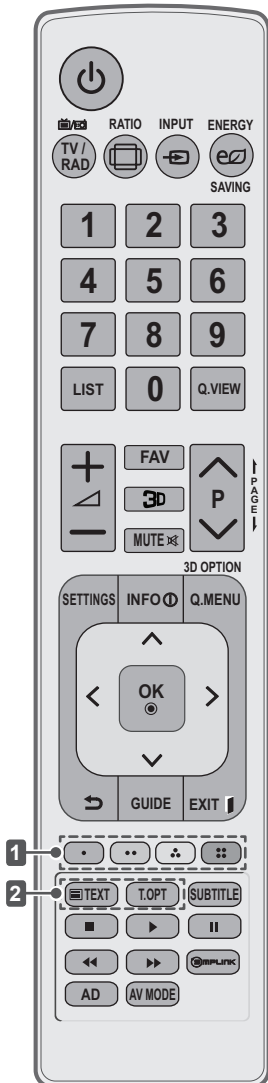

POWER	Turns the TV on or off.
TV/ RAD	Selects Radio, TV and DTV programme.
RATIO	Resizes an image.
INPUT	Changes the input source.
ENERGY SAVING	Adjusts the brightness of the screen to reduce energy consumption.
Number buttons	Enters numbers.
LIST	Accesses the saved programme list.
Q.VIEW	Returns to the previously viewed programme.
FAV	Accesses your favourite programme list.
3D	Used for viewing 3D video.
MUTE	Mutes all sounds.
+ -	Adjusts the volume level.
P ^ v	Scrolls through the saved programmes.
PAGE	Moves to the previous or next screen.
SETTINGS	Accesses the main menus.
INFO	Views the information of the current programme and screen.
Q. MENU	Accesses the Quick menus.
3D OPTION	Use this to view 3D video.
Navigation buttons (up/down/left/right)	Scrolls through menus or options.
OK	Moves to the previous or next screen.
	Returns to the previous level.
GUIDE	Shows programme guide.
EXIT	Clears on-screen displays and return to TV viewing.
1 Coloured buttons	These access special functions in some menus. (: Red, : Green, : Yellow, : Blue)
2 TELETEXT BUTTONS	These buttons are used for teletext.
SUBTITLE	Recalls your preferred subtitle in digital mode.
Control buttons (, , , ,)	Controls the MY MEDIA menus, or the SIMPLINK compatible devices (USB, SIMPLINK).
SIMPLINK	Accesses the AV devices connected with the HDMI cable through HDMI-CEC. Opens the SIMPLINK menu.
AD	Switches the Audio Description on or off.
AV MODE	Selects an AV mode.

MAINTENANCE

Cleaning your TV

Clean your TV regularly to keep the best performance and to extend the product lifespan.



CAUTION

- Make sure to turn the power off and disconnect the power cord and all other cables first.
- When the TV is left unattended and unused for a long time, disconnect the power cord from the wall outlet to prevent possible damage from lightning or power surges.

Screen, frame, cabinet and stand

- To remove dust or light dirt, wipe the surface with a dry, clean, and soft cloth.
- To remove major dirt, wipe the surface with a soft cloth dampened in clean water or a diluted mild detergent. Then wipe immediately with a dry cloth.



CAUTION

- Avoid touching the screen at all times, as this may result in damage to the screen.
- Do not push, rub, or hit the screen surface with your fingernail or a sharp object, as this may result in scratches and image distortions.
- Do not use any chemicals as this may damage the product.
- Do not spray liquid onto the surface. If water enters the TV, it may result in fire, electric shock, or malfunction.

Power cord

Remove the accumulated dust or dirt on the power cord regularly.

TROUBLESHOOTING

Problem	Solution
Cannot control the TV with the remote control.	<ul style="list-style-type: none"> • Check the remote control sensor on the product and try again. • Check if there is any obstacle between the product and the remote control. • Check if the batteries are still working and properly installed (⊕ to ⊕, ⊖ to ⊖).
No image display and no sound is produced.	<ul style="list-style-type: none"> • Check if the product is turned on. • Check if the power cord is connected to a wall outlet. • Check if there is a problem in the wall outlet by connecting other products.
The TV turns off suddenly.	<ul style="list-style-type: none"> • Check the power control settings. The power supply may be interrupted. • Check if the Auto sleep feature is activated in the Time settings. • If there is no signal while the TV is on, the TV will turn off automatically after 15 minutes of inactivity.
When connecting to the PC (RGB/HDMI DVI), 'No signal' or 'Invalid Format' is displayed.	<ul style="list-style-type: none"> • Turn the TV off/on using the remote control. • Reconnect the RGB/HDMI cable. • Restart the PC with the TV on.

SPECIFICATIONS

Product specifications may be changed without prior notice due to upgrade of product functions. For the power supply and power consumption, refer to the label attached to the product.

MODELS		32LS669*	42LS669*	47LS669*
		32LS669C-ZC	42LS669C-ZC	47LS669C-ZC
Dimensions (W x H x D)	With stand	746.0mm x 527.0mm x 204.0mm	979.0mm x 660.0mm x 269.0mm	1089.0mm x 720.0mm x 269.0mm
	Without stand	746.0mm x 462.0mm x 35.5mm	979.0mm x 594.0mm x 35.5mm	1089.0mm x 655.0mm x 35.5mm
Weight	With stand	9.7kg	15.1kg	17.8kg
	Without stand	8.3kg	12.7kg	15.4kg
Power requirement		AC 100-240 V~ 50 / 60 Hz	AC 100-240 V~ 50 / 60 Hz	AC 100-240 V~ 50 / 60 Hz
Power consumption		80 W	100 W	120 W
MODELS		32CS669*	42CS669*	47CS669*
		32CS669C-ZD	42CS669C-ZD	47CS669C-ZD
Dimensions (W x H x D)	With stand	795.0mm x 568.0mm x 207.0mm	1019.0mm x 698.0mm x 265.0mm	1132.0mm x 762.0mm x 265.0mm
	Without stand	795.0mm x 504.0mm x 73.5mm	1019.0mm x 631.0mm x 76.5mm	1132.0mm x 695.0mm x 76.5mm
Weight	With stand	9.6 kg	15.1 kg	19.0 kg
	Without stand	8.5 kg	13.4 kg	17.3 kg
Power requirement		AC 100-240 V~ 50 / 60 Hz	AC 100-240 V~ 50 / 60 Hz	AC 100-240 V~ 50 / 60 Hz
Power consumption		120 W	170 W	230 W
MODELS		42LM610*	47LM610*	55LM610*
		42LM610C-ZE	47LM610C-ZE	55LM610C-ZE
Dimensions (W x H x D)	With stand	979.0mm x 670.0mm x 263.0mm	1089.0mm x 728.0mm x 263.0mm	1263.0mm x 830.0mm x 331.0mm
	Without stand	979.0mm x 594.0mm x 35.5mm	1089.0mm x 655.0mm x 35.5mm	1263.0mm x 754.0mm x 35.5mm
Weight	With stand	14.8 kg	17.5 kg	25.7 kg
	Without stand	12.6 kg	15.3 kg	21.9 kg
Power requirement		AC 100-240 V~ 50 / 60 Hz	AC 100-240 V~ 50 / 60 Hz	AC 100-240 V~ 50 / 60 Hz
Power Consumption		100 W	120 W	150 W

CI Module Size (W x H x D)		100.0 mm x 55.0 mm x 5.0 mm		
Environment condition	Operating Temperature	0 °C to 40 °C		
	Operating Humidity	Less than 80 %		
	Storage Temperature	-20 °C to 60 °C		
	Storage Humidity	Less than 85 %		
		Digital TV ¹	Digital TV	Analogue TV
Television system	LS669* LM610*	DVB-T/T2 DVB-C	DVB-T DVB-C	PAL/SECAM B/G/D/K, SECAM L/L ²
	CS669*			PAL/SECAM B/G/D/K, PAL-I/II, SECAM L/L ²
Programme coverage		VHF, UHF		VHF: E2 to E12, UHF : E21 to E69, CATV: S1 to S20, HYPER: S21 to S47
Maximum number of storable programmes	LS669* LM610*			1,500
	CS669*			1,000
External antenna impedance		75 Ω		

1 Only DVB-T2 support models

2 Except for DVB-T2 support models

3D supported mode

(Only 42/47/55LM610*)

Input	Signal	Resolution	Horizontal Frequency (kHz)	Vertical Frequency (Hz)	Playable 3D video format	
HDMI	720p	1280x720	89.9 / 90 / 75	59.94 / 60 / 50	Frame packing (720 60p)	
			45 / 37.5	60 / 50	Side by Side(half), Top & Bottom	
	1080i	1920x1080	33.7 / 28.125	60 / 50	Side by Side(half), Top & Bottom	
			53.95 / 54	23.98 / 24	Frame packing (1080 24p)	
				67.5 / 56.3	60 / 50	Side by Side, Top & Bottom, Single Frame Sequential
				27	24	Side by Side(half), Top & Bottom
33.7	30	Side by Side(half), Top & Bottom				
RGB	1080p	1920x1080	66.587	59.93	Side by Side, Top & Bottom	
USB	1080p	1920x1080	33.75	30	Side by Side, Top & Bottom, MPO(Photo), JPS(Photo)	
DLNA	1080p	1920x1080	33.75	30	Side by Side, Top & Bottom, MPO(Photo), JPS(Photo)	
	Signal				Playable 3D video format	
DTV	720p, 1080i				Side by Side, Top & Bottom	

HDMI/DVI-DTV supported mode

Resolution	Horizontal Frequency (kHz)	Vertical Frequency (Hz)
720x480	31.469 31.5	59.94 60
720x576	31.25	50
1280x720	37.5 44.96 45	50 59.94 60
1920x1080	33.72	59.94
	33.75	60
	28.125	50
	26.97	23.97
	27	24
	33.716	29.976
	33.75	30.00
	56.25	50
67.43	59.94	
67.5	60	

(Only 32/42/47CS669*)

RGB-PC, HDMI/DVI-PC supported mode

(Only 32/42/47CS669*)

Resolution	Horizontal Frequency (kHz)	Vertical Frequency (Hz)
720x400	31.468	70.08
640x480	31.469	59.94
800x600	37.879	60.31
1024x768	48.363	60.00
1360x768	47.72	59.80
1280x1024	63.981	60.02
1920x1080 (RGB-PC)	66.587	59.93
1920x1080 (HDMI-PC)	67.5	60.00

(Only 32/42/47LS669*, 42/47/55LM610*)

Resolution	Horizontal Frequency (kHz)	Vertical Frequency (Hz)
640x350	31.468	70.09
720x400	31.468	70.08
640x480	31.469	59.94
800x600	37.879	60.31
1024x768	48.363	60.00
1152x864	54.348	60.053
1360x768	47.72	60.015
1920x1080	67.5	60.00
1280x1024 (HDMI-PC)	63.981	60.02

Component port connecting information









Component ports on the TV	Y	P _B	P _R
---------------------------	---	----------------	----------------

Video output ports on DVD player	Y	P _B	P _R
	Y	B-Y	R-Y
	Y	Cb	Cr
	Y	Pb	Pr

Signal	Component
480i/576i	O
480p/576p	O
720p/1080i	O
1080p	O (50 Hz / 60 Hz only)

IR CODES

- This feature is not available for all models.

Code (Hexa)	Function	Note
08	 (POWER)	Remote control Button (Power On/Off)
95	ENERGY SAVING	Remote control Button
F0	TV/RAD	Remote control Button
AB	GUIDE	Remote control Button
AA	INFO	Remote control Button
79	RATIO	Remote control Button
0B	INPUT	Remote control Button
10-19	Number Key 0-9	Remote control Button
53	LIST	Remote control Button
1A	Q.VIEW	Remote control Button
43	SETTINGS	Remote control Button
45	Q.MENU (3D OPTION)	Remote control Button
28		Remote control Button
5B	EXIT	Remote control Button
44	OK	Remote control Button
40	^	Remote control Button
41	v	Remote control Button
07	<	Remote control Button
06	>	Remote control Button
02	 +	Remote control Button
03	 -	Remote control Button
1E	FAV	Remote control Button
91	AD	Remote control Button
09	MUTE	Remote control Button
00	P + (P ^)	Remote control Button
01	P - (P v)	Remote control Button
72	RED	Remote control Button
71	GREEN	Remote control Button
63	YELLOW	Remote control Button
61	BLUE	Remote control Button
B1		Remote control Button
B0		Remote control Button
BA		Remote control Button
8E		Remote control Button
8F		Remote control Button
39	SUBTITLE	Remote control Button
20	TEXT	Remote control Button
21	T.OPT(T.Option)	Remote control Button
DC	3D	Remote control Button
7E	SIMPLINK	Remote control Button
30	AV MODE	Remote control Button

EXTERNAL CONTROL DEVICE SETUP

(Only 32/42/47CS669*)

RS-232C Setup

Connect the RS-232C (serial port) input jack to an external control device (such as a computer or an A/V control system) to control the product's functions externally.

Connect the serial port of the control device to the RS-232C jack on the product back panel.

Note: RS-232C connection cables are not supplied with the product.

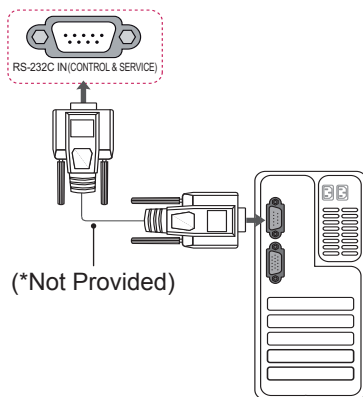

Type of connector; D-Sub 9-Pin Male

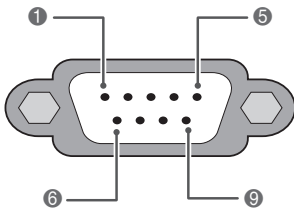

No.	Pin name
1	No connection
2	RXD (Receive data)
3	TXD (Transmit data)
4	DTR (DTE side ready)
5	GND
6	DSR (DCE side ready)
7	RTS (Ready to send)
8	CTS (Clear to send)
9	No Connection

RS-232C Configurations

7-Wire Configurations (Standard RS-232C cable)

	PC	TV	
RXD	2	3	TXD
TXD	3	2	RXD
GND	5	5	GND
DTR	4	6	DSR
DSR	6	4	DTR
RTS	7	8	CTS
CTS	8	7	RTS
	D-Sub 9	D-Sub 9	

3-Wire Configurations(Not standard)

	PC	TV	
RXD	2	3	TXD
TXD	3	2	RXD
GND	5	5	GND
DTR	4	6	DTR
DSR	6	4	DSR
RTS	7	7	RTS
CTS	8	8	CTS
	D-Sub 9	D-Sub 9	

Set ID

Set ID number. "Real Data Mapping".

- 1 Press **SETTINGS** to access the main menus.
- 2 Press the Navigation buttons to scroll to **OPTION** and press **OK**.
- 3 Press the Navigation buttons to scroll to **SET ID** and press **OK**.
- 4 Scroll left or right to select a set ID number and select **CLOSE**. The adjustment range is 1-99.
- 5 When you are finished, press **EXIT**.

Communication Parameters

- Baud rate: 9600 bps (UART)
- Data length: 8 bits
- Parity : None
- Stop bit: 1 bit
- Communication code: ASCII code
- Use a crossed (reverse) cable.

Command reference list

(Depending on model)

	COMMAND1	COMMAND2	DATA (Hexadecimal)		COMMAND1	COMMAND2	DATA (Hexadecimal)
01. Power	k	a	00 to 01	13. Treble	k	r	00 to 64
02. Aspect Ratio	k	c	(See p.35)	14. Bass	k	s	00 to 64
03. Screen Mute	k	d	(See p.35)	15. Balance	k	t	00 to 64
04. Volume Mute	k	e	00 to 01	16. Colour Temperature	x	u	00 to 64
05. Volume Control	k	f	00 to 64	17. Energy Saving	j	q	00 to 05
06. Contrast	k	g	00 to 64	18. Auto Configuration	j	u	01
07. Brightness	k	h	00 to 64	19. Tune Command	m	a	(See p.37)
08. Colour	k	i	00 to 64	20. Programme Add/Skip	m	b	00 to 01
09. Tint	k	j	00 to 64	21. Key	m	c	Key Code
10. Sharpness	k	k	00 to 64	22. Control Back Light	m	g	00 to 64
11. OSD Select	k	l	00 to 01	23. Input select (Main)	x	b	(See p.38)
12. Remote Control Lock Mode	k	m	00 to 01	24. 3D	x	t	(See p.38)

- * Note : During USB operations such as DivX or EMF, all commands except Power(ka) and Key(mc) are not executed and treated as NG.

Transmission / Receiving Protocol

Transmission

[Command1][Command2][][Set ID][][Data][Cr]

[Command 1] : First command to control the TV.(j, k, m or x)

[Command 2] : Second command to control the TV.

[Set ID] : You can adjust the set ID to choose desired monitor ID number in option menu. Adjustment range is 1 to 99. When selecting Set ID '0', every connected set is controlled.

Set ID is indicated as decimal (1 to 99) on menu and as Hexa decimal (0x0 to 0x63) on transmission/receiving protocol.

[DATA] : To transmit command data. Transmit 'FF' data to read status of command.

[Cr] : Carriage Return
ASCII code '0x0D'

[] : ASCII code 'space (0x20)'

OK Acknowledgement

[Command2][][Set ID][][OK][Data][x]

* The set transmits ACK (acknowledgement) based on this format when receiving normal data. At this time, if the data is data read mode, it indicates present status data. If the data is data write mode, it returns the data of the PC computer.

Error Acknowledgement

[Command2][][Set ID][][NG][Data][x]

* The set transmits ACK (acknowledgement) based on this format when receiving abnormal data from non-viable functions or communication errors.

Data 00: Illegal Code

01. Power (Command: k a)

- ▶ To control Power On/Off of the set.

Transmission[k][a][][Set ID][][Data][Cr]

Data 00 : Power Off 01 : Power On

Ack [a][][Set ID][][OK/NG][Data][x]

- ▶ To show Power On/Off.

Transmission [k][a][][Set ID][][FF][Cr]

Ack [a][][Set ID][][OK/NG][Data][x]

* Similarly, if other functions transmit '0xFF' data based on this format, Acknowledgement data feed back presents status about each function.

* OK Ack., Error Ack. and other message may display on the screen when TV is power On.

02. Aspect Ratio (Command: k c) (Main Picture Size)

- ▶ To adjust the screen format. (Main picture format)
You can also adjust the screen format using the Aspect Ratio in the Q.MENU. or PICTURE menu.

Transmission [k][c][][Set ID][][Data][Cr]

Data 01 : Normal screen 06 : Original
(4:3) 07 : 14:9
02 : Wide screen 09 : Just Scan
(16:9) 0B : Full Wide
04 : Zoom 10 to 1F : Cinema Zoom 1 to 16

Ack [c][][Set ID][][OK/NG][Data][x]

* Using the PC input, you select either 16:9 or 4:3 screen aspect ratio.

* In DTV/HDMI (1080i 50 Hz / 60 Hz, 720p 50Hz / 60 Hz, 1080p 24 Hz / 30 Hz / 50 Hz / 60 Hz), Component(720p, 1080i, 1080p 50 Hz / 60 Hz) mode, Just Scan is available.

* Full Wide is supported only for Digital, Analogue, AV.

03. Screen Mute (Command: k d)

- ▶ To select screen mute on/off.

Transmission [k][d][][Set ID][][Data][Cr]

Data 00 : Screen mute off (Picture on)
Video mute off
01 : Screen mute on (Picture off)
10 : Video mute on

Ack [d][][Set ID][][OK/NG][Data][x]

* In case of video mute on only, TV will display On Screen Display(OSD). But, in case of Screen mute on, TV will not display OSD.

04. Volume Mute (Command: k e)

- ▶ To control volume mute on/off.
You can also adjust mute using the MUTE button on remote control.

Transmission [k][e][][Set ID][][Data][Cr]

Data 00 : Volume mute on (Volume off)
01 : Volume mute off (Volume on)

Ack [e][][Set ID][][OK/NG][Data][x]

05. Volume Control (Command: k f)

- ▶ To adjust volume.
You can also adjust volume with the volume buttons on remote control.

Transmission [k][f][][Set ID][][Data][Cr]

Data Min : 00 to Max : 64

* Refer to 'Real data mapping'. See p.38.

Ack [f][][Set ID][][OK/NG][Data][x]

06. Contrast (Command: k g)

- ▶ To adjust screen contrast.
You can also adjust contrast in the PICTURE menu.

Transmission [k][g][][Set ID][][Data][Cr]

Data Min : 00 to Max : 64

* Refer to 'Real data mapping'. See p.38.

Ack [g][][Set ID][][OK/NG][Data][x]

07. Brightness (Command: k h)

- ▶ To adjust screen brightness.
You can also adjust brightness in the PICTURE menu.

Transmission [k][h][][Set ID][][Data][Cr]

Data Min : 00 to Max : 64

* Refer to 'Real data mapping'. See p.38.

Ack [h][][Set ID][][OK/NG][Data][x]

08. Colour (Command: k i)

- ▶ To adjust the screen colour.
You can also adjust colour in the PICTURE menu.

Transmission [k][i][][Set ID][][Data][Cr]

Data Min : 00 to Max : 64

* Refer to 'Real data mapping'. See p.38

Ack [i][][Set ID][][OK/NG][Data][x]

09. Tint (Command: k j)

- ▶ To adjust the screen tint.
You can also adjust tint in the PICTURE menu.

Transmission [k][j][][Set ID][][Data][Cr]

Data Red : 00 to Green : 64

* Refer to 'Real data mapping'. See p.38.

Ack [j][][Set ID][][OK/NG][Data][x]

10. Sharpness (Command: k k)

- ▶ To adjust the screen sharpness.
You can also adjust sharpness in the PICTURE menu.

Transmission [k][k][][Set ID][][Data][Cr]

Data Min : 00 to Max : 64

* Refer to 'Real data mapping'. See p.38.

Ack [k][][Set ID][][OK/NG][Data][x]

11. OSD Select (Command: k l)

- ▶ To select OSD (On Screen Display) on/off when controlling remotely.

Transmission [k][l][][Set ID][][Data][Cr]

Data 00 : OSD off 01 : OSD on

Ack [l][][Set ID][][OK/NG][Data][x]

12. Remote control lock mode (Command: k m)

- ▶ To lock the front panel controls on the monitor and remote control.

Transmission [k][m][][Set ID][][Data][Cr]

Data 00 : Lock off 01 : Lock on

Ack [m][][Set ID][][OK/NG][Data][x]

* If you are not using the remote control, use this mode.

When main power is on/off, external control lock is released.

* In the standby mode, if key lock is on, TV will not turn on by power on key of IR & Local Key.

13. Treble (Command: k r)

- ▶ To adjust treble.
You can also adjust treble in the AUDIO menu.

Transmission [k][r][][Set ID][][Data][Cr]

Data Min : 00 to Max : 64

* Refer to 'Real data mapping'. See p.38.

Ack [r][][Set ID][][OK/NG][Data][x]

14. Bass (Command: k s)

- ▶ To adjust bass.
You can also adjust bass in the AUDIO menu.

Transmission [k][s][][Set ID][][Data][Cr]

Data Min : 00 to Max : 64

* Refer to 'Real data mapping'. See p.38.

Ack [s][][Set ID][][OK/NG][Data][x]

15. Balance (Command: k t)

- ▶ To adjust balance.
You can also adjust balance in the AUDIO menu.

Transmission [k][t][][Set ID][][Data][Cr]

Data Min : 00 to Max : 64

* Refer to 'Real data mapping'. See p.38.

Ack [t][][Set ID][][OK/NG][Data][x]

16. Colour Temperature (Command: x u)

- ▶ To adjust colour temperature. You can also adjust Colour Temperature in the PICTURE menu.

Transmission [x][u][][Set ID][][Data][Cr]

Data Min : 00 to Max : 64

* Refer to 'Real data mapping'. See p.38.

Ack [u][][Set ID][][OK/NG][Data][x]

17. Energy Saving (Command: j q)

- ▶ To reduce the power consumption of the TV. You can also adjust Energy Saving in PICTURE menu.

Transmission [j][q][][Set ID][][Data][Cr]

Power Saving Function					Level				Description
7	6	5	4		3	2	1	0	
0	0	0	0	Low Power	0	0	0	0	Off
0	0	0	0	Low Power	0	0	0	1	Minimum
0	0	0	0	Low Power	0	0	1	0	Medium
0	0	0	0	Low Power	0	0	1	1	Maximum
0	0	0	0	Low Power	0	1	0	1	Screen Off
0	0	0	0	Low Power	0	1	0	0	Auto

Ack [q][][Set ID][][OK/NG][Data][x]

18. Auto Configure(Command: j u)

- ▶ To adjust picture position and minimize image shaking automatically. It works only in RGB (PC) mode.

Transmission [j][u][][Set ID][][Data][Cr]

Data 01: To set

Ack [u][][Set ID][][OK/NG][Data][x]

19. Tune Command (Command: m a)

- ▶ Select channel to following physical number.

Transmission [m][a][][Set ID][][Data0][][Data1][][Data2][Cr]

Data00 : High channel data

Data01 : Low channel data

ex. No. 47 -> 00 2F (2FH)
No. 394 -> 01 8A (18AH),
DTV No. 0 -> Don't care

Data02 : [Antena]

0x00 : Analog Main

0x10 : DTV Main

0x20 : Radio

[Cable]

0x80 : Analog Main

0x90 : DTV Main

0xA0 : Radio

Channel data range

Analogue - Min: 00 to Max: 63 (0 to 99)

Digital - Min: 00 to Max: 3E7 (0 to 999)

Ack [a][][Set ID][][OK/NG][Data][x]

Data Min: 00 to Max: 7DH

20. Programme Add/Skip(Command: m b)

- ▶ To set skip status for the current Programme.

Transmission [m][b][][Set ID][][Data][Cr]

Data 00 : Skip 01 : Add

Ack [b][][Set ID][][OK/NG][Data][x]

21. Key(Command: m c)

- ▶ To send IR remote key code.

Transmission [m][c][][Set ID][][Data][Cr]

Data Key code - See p.31.

Ack [c][][Set ID][][OK/NG][Data][x]

22. Control Back Light(Command: m g)

- ▶ To control the back light.

Transmission [m][g][][Set ID][][Data][Cr]

Data Min : 00 to Max : 64

Ack [g][][Set ID][][OK/NG][Data][x]

23. Input select (Command: x b)

(Main Picture Input)

► To select input source for main picture.

Transmission [x][b][][Set ID][][Data][Cr]

Data Structure

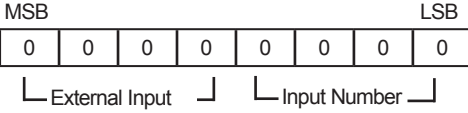

External Input				Data
0	0	0	0	DTV
0	0	0	1	Analogue
0	0	1	0	AV
0	1	0	0	Component
0	1	1	0	RGB
0	1	1	1	HDMI
1	0	0	0	
1	0	0	1	
1	0	1	0	

Input Number				Data
0	0	0	0	Input1
0	0	0	1	Input2
0	0	1	0	Input3
0	0	1	1	Input4

Ack [b][][Set ID][][OK/NG][Data][x]

* Real data mapping

- 00 : Step 0
- ⋮
- A : Step 10 (Set ID 10)
- ⋮
- F : Step 15 (Set ID 15)
- 10 : Step 16 (Set ID 16)
- ⋮
- 64 : Step 100
- ⋮
- 6E : Step 110
- ⋮
- 73 : Step 115
- 74 : Step 116
- ⋮
- CF : Step 199
- ⋮
- FE : Step 254
- FF : Step 255

24. 3D(Command: x t) (only 3D models)

► To change 3D mode for TV.

Transmission [x][t][][Set ID][][Data01][][Data02][][Data03][][Data04][Cr]

Data Structure

- Data01 00 : 3D On
01 : 3D Off
02 : 3D to 2D
03 : 2D to 3D
- Data02 00 : Top and Bottom
01 : Side by Side
02 : Check Board
03 : Frame Sequential
- Data03 00 : Right to Left
01 : Left to Right
- Data04 3D Effect(3D Depth) : Min : 00 ~ Max : 14
(*transmit by Hexadecimal code)

*If data1 is 00(3D On), data4 has no meaning.
*If data1 is 01(3D off) or 02(3D to 2D), data2, data3 and data4 have no meaning.
*If data1 is 03(2D to 3D), data2 and data3 have no meaning.

Data 1	Data 2	Data 3	Data4
00	O	O	X
01	X	X	X
02	X	X	X
03	X	X	O

X : don't care

Ack [t][][OK][Data01][Data02][Data03][Data04][x][][][NG][Data01][x]



The model and serial numbers of the TV is located on the back of the TV
Record it below should you ever need service.

Model _____
Serial _____

