



ENGLISH

OWNER'S MANUAL

DVD Micro Hi-Fi System

Please read this manual carefully before operating your set and retain it for future reference.

DM2520 (DM2520, DMS2520V)



MFL67600532

Safety Information



CAUTION: TO REDUCE THE RISK OF ELECTRIC SHOCK DO NOT REMOVE COVER (OR BACK) NO USER-SERVICEABLE PARTS INSIDE REFER SERVICING TO QUALIFIED SERVICE PERSONNEL.



This lightning flash with arrowhead symbol within an equilateral triangle is intended to alert the user to the presence of uninsulated dangerous voltage within the product's enclosure that may be of sufficient magnitude to constitute a risk of electric shock to persons.



The exclamation point within an equilateral triangle is intended to alert the user to the presence of important operating and maintenance (servicing) instructions in the literature accompanying the product.

WARNING: TO PREVENT FIRE OR ELECTRIC SHOCK HAZARD, DO NOT EXPOSE THIS PRODUCT TO RAIN OR MOISTURE.

WARNING: Do not install this equipment in a confined space such as a book case or similar unit.

CAUTION: Do not block any ventilation openings. Install in accordance with the manufacturer's instructions.

Slots and openings in the cabinet are provided for ventilation and to ensure reliable operation of the product and to protect it from over heating. The openings shall be never be blocked by placing the product on a bed, sofa, rug or other similar surface. This product shall not be placed in a built-in installation such as a bookcase or rack unless proper ventilation is provided or the manufacturer's instruction has been adhered to.

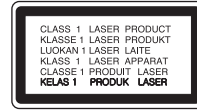

CAUTION: This product employs a Laser System. To ensure proper use of this product, please read this owner's manual carefully and retain it for future reference. Shall the unit require maintenance, contact an authorized service center. Use of controls, adjustments or the performance of procedures other than those specified herein may result in hazardous radiation exposure. To prevent direct exposure to laser beam, do not try to open the enclosure. Visible laser radiation when open. **DO NOT STARE INTO BEAM.**

CAUTION concerning the Power Cord

Most appliances recommend they be placed upon a dedicated circuit;

That is, a single outlet circuit which powers only that appliance and has no additional outlets or branch circuits. Check the specification page of this owner's manual to be certain. Do not overload wall outlets. Overloaded wall outlets, loose or damaged wall outlets, extension cords, frayed power cords, or damaged or cracked wire insulation are dangerous. Any of these conditions could result in electric shock or fire. Periodically examine the cord of your appliance, and if its appearance indicates damage or deterioration, unplug it, discontinue use of the appliance, and have the cord replaced with an exact replacement part by an authorized service center. Protect the power cord from physical or mechanical abuse, such as being twisted, kinked, pinched, closed in a door, or walked upon. Pay particular attention to plugs, wall outlets, and the point where the cord exits the appliance. To disconnect power from the mains, pull out the mains cord plug. When installing the product, ensure that the plug is easily accessible.

This device is equipped with a portable battery or accumulator.

Safety way to remove the battery or the battery from the equipment: Remove the old battery or battery pack, follow the steps in reverse order than the assembly. To prevent contamination of the environment and bring on possible threat to human and animal health, the old battery or the battery put it in the appropriate container at designated collection points. Do not dispose of batteries or battery together with other waste. It is recommended that you use local, free reimbursement systems batteries and accumulators. The battery shall not be exposed to excessive heat such as sunshine, fire or the like.

CAUTION: The apparatus shall not be exposed to water (dripping or splashing) and no objects filled with liquids, such as vases, shall be placed on the apparatus.

You have to set the disc format option to [Mastered] in order to make the discs compatible with the LG players when formatting rewritable discs. When setting the option to Live File System, you cannot use it on LG players.

(Mastered/ Live File System : Disc format system for Windows Vista)

Copyrights

It is forbidden by law to copy, broadcast, show, broadcast via cable, play in public, or rent copyrighted material without permission. This product features the copy protection function developed by Macrovision. Copy protection signals are recorded on some discs. When recording and playing the pictures of these discs picture noise will appear. This product incorporates copyright protection technology that is protected by U.S. patents and other intellectual property rights. Use of this copyright protection technology must be authorized by Macrovision, and is intended for home and other limited viewing uses only unless otherwise authorized by Macrovision. Reverse engineering or disassembly is prohibited.

CONSUMERS SHOULD NOTE THAT NOT ALL HIGH DEFINITION TELEVISION SETS ARE FULLY COMPATIBLE WITH THIS PRODUCT AND MAY CAUSE ARTIFACTS TO BE DISPLAYED IN THE PICTURE. IN CASE OF 525 OR 625 PROGRESSIVE SCAN PICTURE PROBLEMS, IT IS RECOMMENDED THAT THE USER SWITCH THE CONNECTION TO THE 'STANDARD DEFINITION' OUTPUT. IF THERE ARE QUESTIONS REGARDING OUR TV SET COMPATIBILITY WITH THIS MODEL 525p AND 625p UNIT, PLEASE CONTACT OUR CUSTOMER SERVICE CENTER.

Table of Contents

1 Getting Started

- 2 Safety Information
- 6 Unique Features
- 6 Accessories
- 6 Introduction
 - 6 – Playable Discs
 - 6 – About the  Symbol Display
 - 7 – Symbol Used in this Manual
 - 7 – Regional Codes
- 7 Playable file Requirement
 - 7 – Compatible USB Devices
 - 7 – USB device requirement
 - 8 – MP3/ WMA music file requirement
 - 8 – Photo file requirement
 - 8 – DivX file requirement
- 9 Remote Control
- 11 Front Panel
- 12 Rear Panel

2 Connecting

- 13 Connecting to speakers
 - 13 – Attaching the speakers to the unit
- 13 Connections to Your TV
 - 14 – Video Connection
 - 14 – Component Video Connection
- 15 Optional Equipment Connection
 - 15 – USB Connection
 - 15 – PORT. IN Connection
 - 16 – Playing the iPod
 - 16 – Compatible iPod
 - 17 – Playing the OSD iPod

3 System Setting

- 19 Adjust the Setup settings
 - 19 – OSD Initial language settings
 - 19 – To display and exit the Setup Menu
 - 20 – LANGUAGE
 - 20 – DISPLAY
 - 21 – AUDIO
 - 21 – LOCK (Parental Control)
 - 22 – OTHERS

4 Operating

- 23 Basic Operations
- 23 – Disc/USB Operations
- 24 Other Operations
- 24 – Displaying Disc Information on-screen
- 24 – To display the DVD Menu
- 24 – To display the DVD title
- 24 – Selecting a subtitle language
- 24 – 1.5 times speed playback
- 25 – Starting play from selected time
- 25 – Last Scene Memory
- 25 – Changing the character set to display DivX® subtitle correctly- optional
- 25 – Creating your own program
- 26 – Viewing a PHOTO file
- 26 – Viewing a PHOTO file as a slide show
- 26 – Turning off the sound temporarily
- 26 – Screen Saver
- 26 – System Select - Optional
- 26 – Displaying file information (ID3 TAG)
- 27 – Setting the Clock
- 27 – Using your player as an alarm clock
- 28 – Sleep Timer Setting
- 28 – Dimmer
- 28 – Auto Power Down
- 28 Radio Operations
- 28 – Listening to the radio
- 28 – Presetting the Radio Stations
- 28 – Deleting all the saved stations
- 29 – Improving poor FM reception
- 29 Sound adjustment
- 29 – Setting the surround mode
- 30 Advanced Operations
- 30 – Listening to music from your external device
- 30 – Recording to USB

5 Troubleshooting

- 31 Troubleshooting

6 Appendix

- 32 Specifications
- 34 Maintenance
- 34 – Handling the Unit
- 34 – Notes on Discs
- 35 Trademarks and Licenses
- 36 Language Codes
- 37 Area Codes

1

2

3

4

5

6

Unique Features

USB Direct Recording

Records music to your USB device.

Portable In

Listens to music from your portable device. (MP3, Notebook, etc)

Accessories

Please check and identify the supplied accessories.

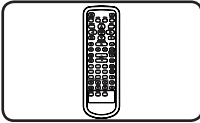

Remote Control (1)

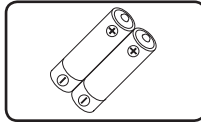

Battery (2)

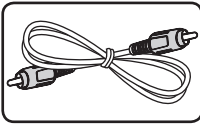

Video cable (1)

Introduction

Playable Discs

This unit plays DVD±R/RW and CD-R/RW that contains audio titles, DivX, MP3, WMA and/or JPEG files. Some DVD±RW/DVD±R or CD-RW/CD-R cannot be played on this unit due to the recording quality or physical condition of the disc, or the characteristics of the recording device and authoring software.



DVD-VIDEO (8 cm / 12 cm disc)

Discs such as movies that can be purchased or rented.



DVD±R (8 cm / 12 cm disc)

Video mode and finalized only.



DVD-RW (8 cm / 12 cm disc)

Video mode and finalized only.



DVD+R: Video mode only

Supports the double layer disc also.



DVD+RW (8 cm / 12 cm disc)

Video mode and finalized only.



Audio CD: Music CDs or CD-R/CD-RW in music CD format that can be purchased.

About the Symbol Display

“” may appear on your TV display during operation and indicates that the function explained in this owner's manual is not available on that disc.

Symbol Used in this Manual

DVD and finalized DVD±R/RW

DivX files

MP3/WMA files, Audio CDs

JPG files



Regional Codes

This unit has a regional code printed on the rear of the unit. This unit can play only DVD discs labelled same as the rear of the unit or "ALL".

- Most DVD discs have a globe with one or more numbers in it clearly visible on the cover. This number must match your unit's regional code or the disc cannot play.
- If you try to play a DVD with a different regional code from your unit, the message "Check Regional Code" appears on the TV screen.

Note

Indicates special notes and operating features.

Caution

Indicates cautions for preventing possible damages from abuse.

Playable file Requirement

Compatible USB Devices

- MP3 Player : Flash type MP3 player.
- USB Flash Drive : Devices that support USB2.0 or USB1.1.
- The USB function of this unit does not support all USB devices.

USB device requirement

- Devices which require additional program installation when you have connected it to a computer, are not supported.
- Do not extract the USB device while in operation.
- For a large capacity USB, it may take longer than a few minute to be searched.
- To prevent data loss, back up all data.
- If you use a USB extension cable or USB hub, the USB device is not recognized.
- Using NTFS file system is not supported. (Only FAT(16/ 32) file system is supported.)
- This unit is not supported when the total number of files is 1 000 or more.
- External HDD, Card readers, Locked devices, or hard type USB devices are not supported.
- USB port of the unit cannot be connected to PC. The unit cannot be used as a storage device.

MP3/ WMA music file requirement

MP3/ WMA file compatibility with this unit is limited as follows :

- Sampling Frequency : 32 - 48 kHz (MP3), 32 - 48 kHz (WMA)
- Bit rate : 32 - 320 kbps (MP3), 40 - 192 kbps (WMA)
- maximum files : Under 999
- File extensions : ".mp3"/ ".wma"
- CD-ROM file format : ISO9660 LEVEL 1/ JOLIET
- We recommend that you use "Easy-CD Creator", which creates an ISO 9660 file system.

Photo file requirement

Photo file compatibility with this unit is limited as follows :

- Max pixel in width :
Normal : 5120 x 3840
Progressive JPEG : 2043 x1536
- Maximum files : Under 999
- Some discs may not operate due to a different recording format or the condition of disc.
- File extensions : ".jpg"
- CD-ROM file format : ISO9660 LEVEL 1/ JOLIET

DivX file requirement

DivX file compatibility with this unit is limited as follows :

- Available resolution:
up to 800 x 600 (W x H) pixels.
- The file name of the DivX subtitle should be entered 45 characters or less.
- If there is a code impossible to express in the DivX file, it may be displayed as a " _ " mark on the display.
- If the video and audio structure of recorded files are not interleaved, either video or audio is output.
- Playable DivX file : ".avi", ".mpg", ".mpeg", ".divx"
- Playable Subtitle format : SubRip (*.srt/ *.txt), SAMI (*.smi), SubStation Alpha (*.ssa/ *.txt), MicroDVD (*.sub/ *.txt), SubViewer 2.0 (*.sub/ *.txt)
- Playable Codec format : "DIVX3.xx", "DIVX4.xx", "DIVX5.xx", "MP4V3", "3IVX".
- Playable Audio format : "AC3", "PCM", "MP3", "WMA".
- For Discs formatted in Live file system, you can not use it on this unit.
- If the name of movie file is different from that of the subtitle file, during playback of a DivX file, subtitle may not be display.

Remote Control

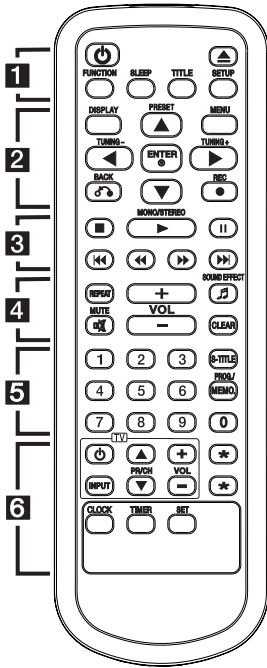

Battery Installation

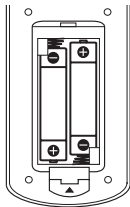

Remove the battery cover on the rear of the Remote Control, and insert one (size AAA) battery with $+$ and $-$ matched correctly.

..... **1**

POWER (⏻): Switches the unit ON or OFF.

OPEN/CLOSE (⬆/⬇): Opens or closes the disc tray.

FUNCTION: Selects the function and input source.

SLEEP: Sets the system to turn off automatically at a specified time.

TITLE: If the current DVD title has a menu, the title menu appears on the screen. Otherwise, the disc menu may appear.

SETUP: Accesses or removes setup menu.

..... **2**

DISPLAY: Accesses On-Screen Display.

MENU:

- Accesses the menu on a DVD disc.

- Chooses an item on IPOD mode.

PRESET (⬆/⬇): Selects programme of Radio.

TUNING (-/+): Tunes in the desired radio station.

▲/▼/◀/▶: (up/down/left/right) : Uses to navigate on-screen displays.

ENTER: Acknowledges menu selection.

BACK: Moving backward in the menu.

REC: Recording.

..... **3**

STOP (■): Stops playback or recording.

MONO/STEREO:

- Starts playback.

- Selects Mono/ Stereo.

II :

- Pauses playback.

- Plays title Frame-by-Frame. (DVD, DivX only)

◀◀/▶▶:

- Goes to next or previous chapter/ track/ file.

- Adjusts the hours or minutes to set alarm and clock.

◀◀/▶▶: Searches backward or forward.

..... **4**

REPEAT: Selects a play mode.

SOUND EFFECT: Selects a sound effect mode.

VOL +/- (Volume): Adjusts volume of speaker or head phone.

MUTE: Mutes the sound.

CLEAR :

- Removes a number when setting the password.

- Removes a track number on the Program List.

- Removes language code when setting the disc language.

..... **5**

0 to 9 numerical buttons :

- Selects numbered options in a menu.

S-TITLE : During playback, press

S-TITLE repeatedly to select a desired subtitle language.

PROG./MEMO :

- Stores radio stations.

- Creates a playlist you want to listen to.

1

Getting Started

Remote Control

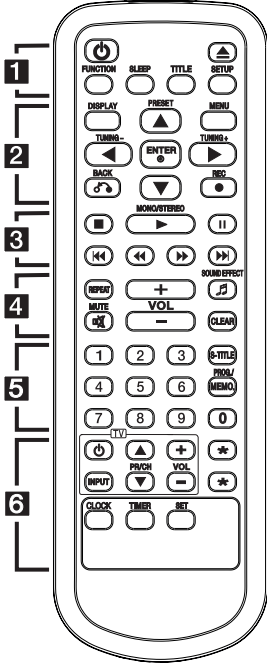

..... **6**

TV Control buttons : Controls the TV. (LG TV only)

You can control the sound level, input source, and power switching of LG TVs as well. Hold **POWER (TV)** and press **PR/CH (▲▼)** button repeatedly until the TV turns on or off.

*****: This button is not available.

CLOCK : You can set and check the time.

TIMER : You can turn USB, CD play and TUNER reception on or off at a desired time.

SET : (Refer to the page 27)

- Confirms the setting

Front Panel

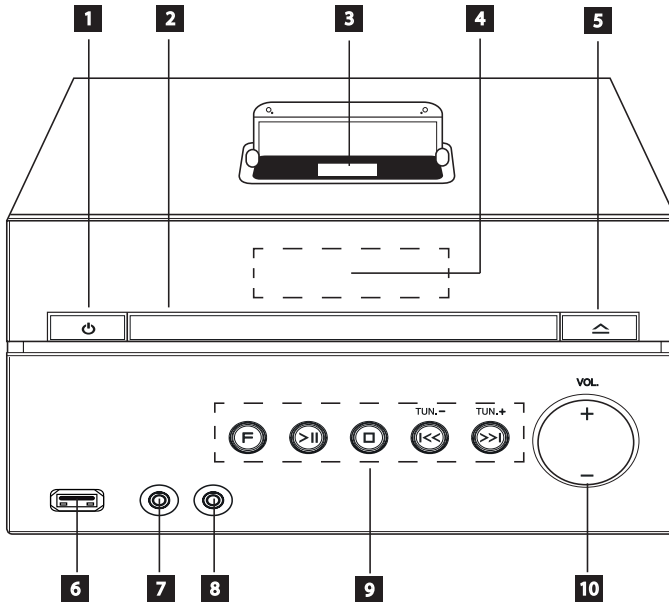

- 1** **⏻ (POWER)**
Switches the unit ON or OFF.
- 2** **Disc tray**
- 3** **iPod dock**
- 4** **Display window**
Shows the current state of the unit.
- 5** **△ (Open/Close)**
Opens or closes the disc tray.
- 6** **USB Port**
Connects an USB device.
- 7** **PORT.IN**
The player can be used to play the music from many types of portable player.
- 8** **PHONES**
Headphone jack.
- 9** **F (FUNCTION)**
Selects the function or input source.
- >|| (PLAY / PAUSE)**
Starts playback and pauses.
- (STOP)**
Stops playback or recording.
- |<< / >>| (Skip/Search):**
- Goes to next or previous file/track.
- Searches backward or forward (Press and hold)
- Adjusts the hours or minutes to set alarm and clock.
- TUN. (-/+)**
Tunes in the desired radio station.
- 10** **VOL. (+/-)**
Adjusts volume of speaker or head phone.

Rear Panel

1

Getting Started

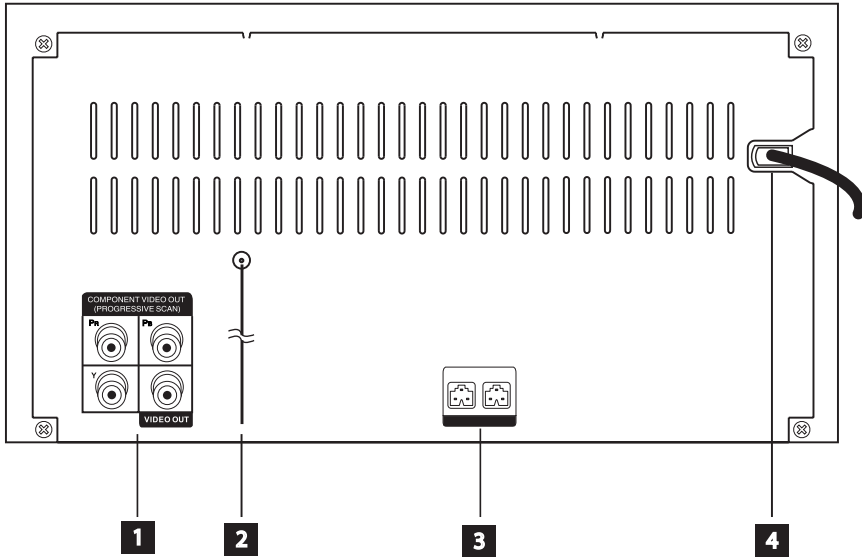

1 COMPONENT VIDEO (Y PB PR) OUTPUT (PROGRESSIVE SCAN)

Connects to a TV with Y PB PR inputs.

VIDEO OUT

Connects to a TV with video inputs.

2 ANTENNA (FM)

3 Speaker terminal

Connects the speaker cables.

4 Power cord

Connecting to speakers

Attaching the speakers to the unit

Connect connector on the speaker cable to speaker terminal. Each speaker connector is colored. Use matching color connector to each speaker terminal. When connecting connector to the speaker terminal, push the connector until it is perfectly linked.

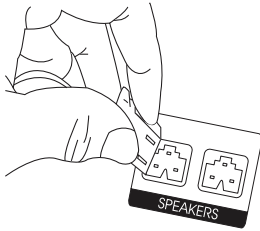

Speaker	Color	Position
R	Red	right
L	White	left

Caution

The speakers contain magnet parts, so color irregularity may occur on the TV screen or PC monitor screen. Please use the speakers far away from either TV screen or PC monitor.

Connections to Your TV

Make one of the following connections, depending on the capabilities of your existing equipment.

Note

- Depending on your TV and other equipment you wish to connect, there are various ways you could connect the unit. Use only one of the connections described in this manual.
- Please refer to the manuals of your TV, Stereo System or other devices as necessary to make the best connections.
- Make sure the unit is connected directly to the TV. Tune the TV to the correct video input channel.
- Do not connect your unit via your VCR. The image could be distorted by the copy protection system.

Video Connection

Connect the VIDEO OUT jack on the unit to the video in jack on the TV using a video cable.

You can hear the sound through the system's speakers.

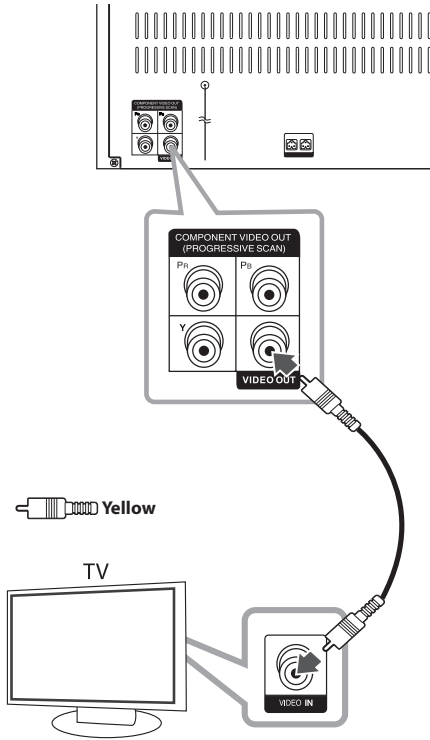

Component Video Connection

Connect the COMPONENT VIDEO OUT (PROGRESSIVE SCAN) jacks on the unit to the corresponding input jacks on the TV using component cables.

You can hear the sound through the system's speakers.

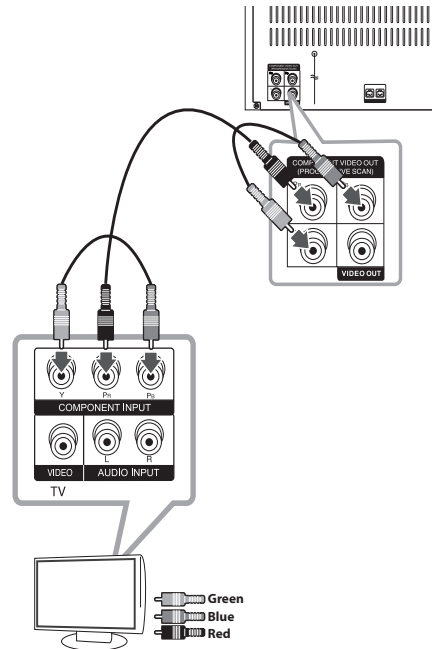

Note

If your TV accepts progressive format signals, you must use this connection and set [Progressive Scan] in [Display] setup to [On] (See page 20).

Optional Equipment Connection

USB Connection

Connect the USB port of USB Memory (or MP3 player, etc.) to the USB port on the front of the unit.

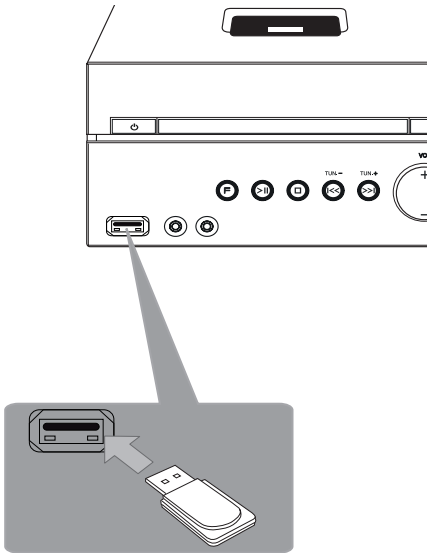

! Note

Removing the USB Device from the unit

1. Choose a different function/mode press **■** on the remote control or **□** on the unit twice in a row.
2. Remove the USB device from the unit.

PORT. IN Connection

Connect an output of portable device (MP3 or PMP etc) to the PORT. IN connector.

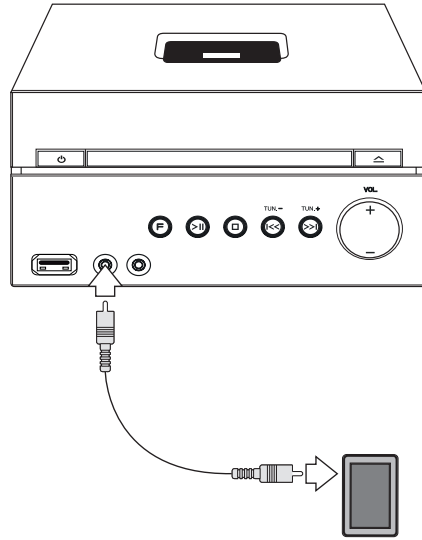

2

Connecting

Playing the iPod

You can enjoy the sound with your iPod. For details about iPod, refer to the iPod User Guide.

1. Connect the iPod firmly.

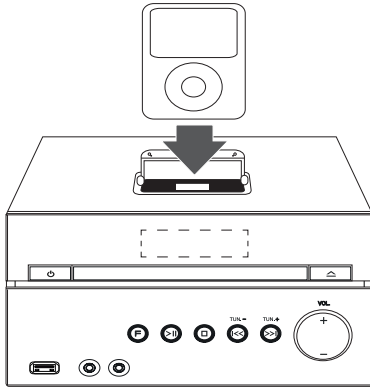

If your iPod/iPhone is connected or docked, it will automatically turn on and recharging will start.

So iPod/iPhone is charged even when the player is power off.

2. Press **F** on the unit or **FUNCTION** on the remote control to select iPod function. You can operate your iPod through an iPod's display by using the supplied remote control and also control on your iPod.

To	Do this	
	ON UNIT	ON REMOTE
Pauses or restart	>	
Skip	<</>>	◀◀/▶▶
Search	Press and hold <</>>	Press and hold ◀◀/▶▶
Move to the previous menu	-	◀ / MENU
Move to the desired item	-	▲ / ▼
Chooses a item	-	▶ / Ⓞ ENTER

Compatible iPod

- We recommend installing the latest software version.
- The unit supports the models as follows:
iPod nano 1 G, 2 G, 3 G, 4 G, 5 G, 6 G/
iPod classic/iPod touch 1G, 2 G, 3 G, 4 G/
iPhone 3 G, 3GS, 4.
For some models, the unit may not operate depending on the firmware version.
- Depending on your iPod's software version, you may not control your iPod from the player.

! Note

- If this unit displays an error message, follow the message. An error message "ERROR".
 - Your iPod is not connected firmly.
 - This unit recognizes your iPod as an unknown device.
 - Your iPod is exceptionally low in power.
 - ➔ The battery needs to be charged.
 - ➔ If you charge the battery while iPod is extremely low in power, it may take longer to be charged.
- iPod does not support recording function when connected.
- Depending on your iPod's software version, it may not be possible to control your iPod from this unit. We recommend installing the latest software version.
- If you use an application, make a call, or send and receive SMS text message, etc. on iPod touch or iPhone, disconnect it from iPod dock of this unit and then use it.
- If you have a problem with your iPod, please visit www.apple.com/support/ipod.

Playing the OSD iPod

You can enjoy the media files with your iPod. For details about iPod, refer to the iPod's User Guide.

Preparation

- To view iPod's Videos and Photos on the TV screen.
 - Be sure to use the video connection through the VIDEO OUT jack on the rear panel of this unit. Select the appropriate video input mode on the TV.
 - Depending on the iPod, make sure that select Videos > Video settings, and then set TV Out to Ask or On from your iPod. For details about Video Settings, refer to the iPod User Guide.
 - The viewing photos is available only if this unit is in OSD iPod mode and you can view photos only as a slide show. You have to start a slide show on your iPod to view a photo on a TV. For details about a slide show, refer to the iPod User Guide.
- Before connecting the iPod, turn this unit off and reduce the volume of this unit to its minimum.

Enjoying OSD iPod on the screen

You can operate your iPod by controlling menu on the screen.

1. Connect the iPod firmly.
2. Select [Music] or [Video] using ◀/▶, and press **⊙ ENTER**
3. Select a content using ▲/▼/◀/▶, and press **⊙ ENTER** to play.

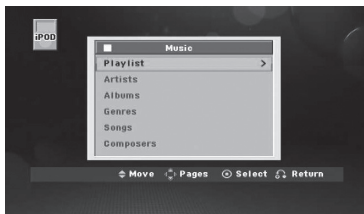

4. Operate iPod. Refer to basic operation section.

Note

- If the iPod's OSD language is selected to simple chinese, the power scroll function is not operated correctly.
- The controls on your iPod are not operational in this mode.

Enjoying the OSD iPod mode

You can operate your iPod by using the supplied remote control and controls on your iPod.

1. Connect the iPod firmly.
2. Press **FUNCTION** to select OSD iPod mode.

▲/▼/◀/▶	Selects an option in the menu.
▶ PLAY, MONO/STEREO, ⊙ ENTER	Starts playback the music or video.
	To pause while it is playing. To resume playing, press ▶ PLAY, MONO/STEREO again.
◀◀/▶▶	Fast-forward or rewind a song or video
⏮/⏭	Skip the playback forward or backward .
REPEAT	To select a desired repeat mode: Track (🔁), All (🔄), Off (No display).

Note

- An error message "CHECK IPOD" or "Connected iPod model is not supported." appears when:
 - your iPod is not available for the function to be operated.
- An error message "CHECK IPOD" or "Please update iPod's software." appears when:
 - your iPod has an old software version.
 - > Update your iPod software to latest version.
- If this unit displays an error message, follow the message. An error message "CHECK IPOD" or "Please check your iPod." appears when:
 - the communication between this unit and your iPod is failed.
 - > Undock & re-dock your iPod in this unit.
 - your iPod is not connected firmly.
 - this unit recognizes your iPod as unknown device.
 - your iPod is exceptionally low on power.
 - > The battery needs to be charged.
 - > If you charge the battery while iPod is extremely low in power, it may take longer to charge.
- You may use the dock adapter which should be supplied with your iPod to the dock for the stable use of the iPod. If you need an adapter, consult your iPod dealer.
- Compatibility with your iPod may vary depending on the type of your iPod.
- iPod touch and iPhone have any difference in operation other than iPod. You may need any additional control to use them with this unit. (e.g. "slide to unlock")
- If you use an application, make a call, or send and receive SMS text message, etc. on iPod touch or iPhone, disconnect it from iPod dock of this unit and then use it.
- Depending on your iPod's software version, it may not be possible to control your iPod from this unit. We recommend installing the latest software version.
- The video quality depends on the video sources on your iPod.
- If you have a problem with your iPod, please visit www.apple.com/support/ipod.

Adjust the Setup settings

By using the Setup menu, you can make various adjustments to items such as picture and sound.





You can also set a language for the subtitles and the Setup menu, among other things. For details on each Setup menu item.

OSD Initial language settings

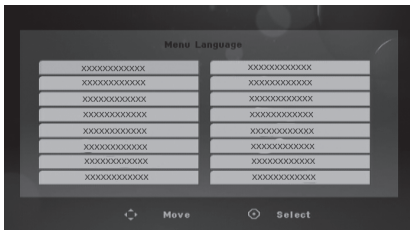
When using this unit for the first time, the initial language setup menu appears on your TV screen. You must complete initial language selection before using the unit. English will be selected as the initial language.

1. Press  to turn the unit on.
The language setup menu will appear on the screen.



2. Use /// to select a language then press  **ENTER**.
The confirm menu will appear.













3. Use / to select [Enter] then press  **ENTER** to finish the language setup.

To display and exit the Setup Menu

1. Select the DVD/CD or USB function by pressing **FUNCTION** on the remote control or **F** on the unit.
2. Press **SETUP**.
Displays the [SETUP] Menu.
3. Press **SETUP** or  **BACK** to exit in the [SETUP] Menu.

About help menu for Setup

Menu	Buttons	Operation
 Move		Moving to another menu.
 Prev.		Moving to previous level.
 Select		Moving to next level or selecting menu.
 Close	 BACK	To exit the [Setup] menu.
 Enter	 ENTER	To confirm menu.

LANGUAGE

OSD

Select a language for the Setup menu and then on screen display.

Disc Audio/Disc Subtitle/Disc Menu

Select the language you prefer for the audio track (disc audio), subtitles, and the disc menu.

[Original]

Refers to the original language in which the disc was recorded.

[Other]

To select another language, press numeric buttons and then **ENTER** to enter the corresponding 4-digit number according to the language code list on the page 36. If you enter the wrong language code, press **CLEAR**.

[Off (for Disc Subtitle)]

Turns off Subtitle.

DISPLAY

TV Aspect

Select which screen aspect to use based on the shape of your TV screen.

[4:3]

Select when a standard 4:3 TV is connected.

[16:9]

Select when a 16:9 wide TV is connected.

Display Mode

The Display Mode setting works only when the TV Aspect mode is set to 4:3.

[Letterbox]

This displays a wide screen picture with black bands at the top and bottom of the screen.

[Panscan]

This fills the entire 4:3 screen, cropping the picture as necessary.

Progressive Scan (For Component Video connections)

Selects whether the **COMPONENT VIDEO OUT (PROGRESSIVE SCAN)** jacks output progressive signal. If your TV accepts progressive format signals, you will enjoy accurate color reproduction and high quality image by selecting [On]. If your TV does not accept progressive format signals, select [Off].

If you set Progressive Scan to [On] in error, you must reset the unit. First, remove the disc from the unit. Next, press and hold **■** for about five seconds. The video output will be restored to the standard setting, and a picture will be visible on your TV.

AUDIO

DRC (Dynamic Range Control)

Make the sound clear when the volume is turned down (Dolby Digital only). Set to [On] for this effect.

Vocal

Select [On] to mix karaoke channels into normal stereo.

This function is effective for multi-channel karaoke DVDs only.

LOCK (Parental Control)

Initial Setting of the Area Code

When you use this unit for the first time, you have to set the Area Code as shown below.

1. Select the [Lock] menu and then press ►.
2. Press ►.

To access the [Lock] options, you must input the password you have created. Input a password and press **⊙ ENTER**. Enter it again and press **⊙ ENTER** to verify. If you make a mistake before pressing **⊙ ENTER**, press **CLEAR**.

3. Select the first character using ▲/▼ buttons.
4. Press ► and select the second character using ▲/▼ buttons.
5. Press **⊙ ENTER** to confirm your Area code selection.

Rating

Blocks playback of rated DVDs based on their contents. Not all discs are rated.

1. Select [Rating] on the [Lock] menu then press ►.
2. Input a password and press **⊙ ENTER**.
3. Select a rating from 1 to 8 using the ▲/▼ buttons.

[Rating 1-8]

Rating one (1) has the most restrictions and rating eight (8) is the least restrictive.

[Unlock]

If you select unlock, parental control is not active and the disc plays in full.

4. Press **⊙ ENTER** to confirm your rating selection.

Password

You can enter or change password.

1. Select [Password] on the [Lock] menu and then press **▶**.
2. Input a password and press **⊙ ENTER**.
To change the password, press **⊙ ENTER** when the [Change] option is highlighted. Input a password and press **⊙ ENTER**. Enter it again and press **⊙ ENTER** to verify.
3. Press **SETUP** to exit the menu.

! Note

If you forget your password, you can clear it using the following steps:

1. Press **SETUP** to display the [SETUP] menu.
2. Input the 6-digit number "210499" and press **⊙ ENTER**. The password is cleared.

Area Code

Enter the code of the area whose standards were used to rate the DVD video disc, based on the list on page 37.

1. Select [Area Code] on the [Lock] menu then press **▶**.
2. Input a password and press **⊙ ENTER**.
3. Select the first character using **▲/▼** buttons.
4. Press **▶** and select the second character using **▲/▼** buttons.
5. Press **⊙ ENTER** to confirm your Area code selection.

OTHERS

DivX(R) Registration

ABOUT DIVX VIDEO: DivX® is a digital video format created by DivX, LLC, a subsidiary of Rovi Corporation. This is an official DivX Certified® device that plays DivX video. Visit divx.com for more information and software tools to convert your files into DivX videos.

ABOUT DIVX VIDEO-ON-DEMAND: This DivX Certified® device must be registered in order to play purchased DivX Video-on-Demand (VOD) movies. To obtain your registration code, locate the DivX VOD section in your device setup menu. Go to vod.divx.com for more information on how to complete your registration.

! Note

All the downloaded videos from DivX® VOD with this unit's registration code can be played on this unit.



















Basic Operations

Disc/USB Operations

1. Insert the disc by using the **Disc tray** or connect the USB device to the USB port.
2. Select the **DVD/CD** or **USB** function by pressing **FUNCTION** on the remote control or **F** on the unit.
3. Select a file (or track/ title) you want to play by pressing **▲/▼/◀/▶**.

Note

- When playing a disc or USB Flash Drive containing with DivX, MP3/WMA and JPEG files together, you can select menu of files which you would like to play by pressing **MENU**.
- For the most Audio CD and DVD-ROM discs, playback starts automatically.
- The unit plays only music file contained in the USB storage device or disc automatically. (except for folder)

To	Do this
Stop	Press  on the remote control or  on the unit.
Playback	Press  MONO/STEREO on the remote control or  on the unit.
Pause	During playback, press  on the remote control or  on the unit.
Frame-by-Frame playback	press  on the remote control or  on the unit repeatedly to play title Frame-by-Frame. (DVD, DivX only)
Skipping to the next/ previous chapter/ track/ file	During playback, press  /  to go to the next chapter/ track/ file or to return to the beginning of the current chapter/ track/ file. Press  twice briefly to step back to the previous chapter/ track/ file.
Locating a point quickly by playing a file in fast forward or fast reverse	During playback, press and hold  /  on the remote control repeatedly or  /  on the unit to select the required scan speed. To return to normal speed, Press  MONO/STEREO on the remote control or  on the unit.
Playing repeatedly or randomly	Press REPEAT repeatedly, and the current title, chapter or track will be played back repeatedly or randomly. - Random play mode : only music files.
Slowing down the playing speed	In the pause mode, press  /  to select the required speed. (DVD only)

Other Operations

Displaying Disc Information on-screen

You can display various information about the disc loaded on-screen.

1. Press **DISPLAY** to show various playback information.
The displayed items differ depending on the disc type or playing status.
2. You can select an item by pressing **▲/▼** and change or select the setting by pressing **◀/▶**.
 - Title – Current title number/ total number of titles.
 - Chapter – Current chapter number/ total number of chapters.
 - Time – Elapsed playing time.
Selected total time of current title/file.
 - Audio – Selected audio language or channel.
 - Subtitle – Selected subtitle.
 - Angle – Selected angle/ total number of angles.
 - Sound – Selected sound mode.

! Note

If any button is not pressed for a few seconds, the onscreen display disappears.

To display the DVD Menu

DVD

When you play a DVD which contains several menu, you can select the menu you want using the **MENU**.

1. Press **MENU**.
The disc's menu appears.
2. Select the menu by using **▲/▼/◀/▶**.
3. Press **⊙ ENTER** to confirm.

To display the DVD title

DVD

When you play a DVD which contains several title, you can select the title you want using the **TITLE**.

1. Press **TITLE**.
The disc's title appears.
2. Select the menu by pressing **▲/▼/◀/▶**.
3. Press **⊙ ENTER** to confirm.

Selecting a subtitle language

DVD MOVIE

During playback, press **S-TITLE** repeatedly to select a desired subtitle language.

1.5 times speed playback

DVD

The 1.5 speed allows you to watch the pictures and listen to the sound quicker than playing at a normal speed.

1. During playback, Press **▶ MONO/STEREO** on the remote control or **>||** on the unit to play at 1.5 times speed. "▶X1.5" appears on the screen.
2. Press **▶ MONO/STEREO** on the remote control or **>||** on the unit again to exit.

Starting play from selected time

DVD MOVIE

To start playing at any chosen time on the file or title.

1. Press **DISPLAY** during playback.
2. Press **▲/▼** to select the time clock icon and “--:--” appears.
3. Input the required start time in hours, minutes, and seconds from left to right. If you enter the wrong numbers, press **CLEAR** to remove the numbers you entered. Then input the correct numbers.
For example, to find a scene at 1 hour, 10 minutes, and 20 seconds, enter “11020” by using numerical buttons.
4. Press **ENTER** to confirm. Playback starts from the selected time.

Last Scene Memory

DVD

This unit memorizes last scene from the last disc that is viewed. The last scene remains in memory even if you remove the disc from the unit or switch off the unit. If you load a disc that has the scene memorized, the scene is automatically recalled.

Changing the character set to display DivX® subtitle correctly- optional

MOVIE

During playback, if the subtitle does not displayed on the screen properly, press and hold **S-TITLE** on the remote control for about 3 seconds then press **S-TITLE** to select another language code until the subtitle is displayed properly.

! Note

If any button is not pressed for about 10 seconds, the language code display disappears.

Creating your own program

MUSIC

You can play the contents of a disc in the order you want by arranging the order of the songs on the disc. The program is cleared when the disc is removed.

1. Select a desired music file then press **PROG./MEMO**, or select “**♪→**” and then press **ENTER** to add the music file to the program list.
2. To add all music file on the disc, select “**♪♪→**” and then press **ENTER**.
3. Select a music file from the program list then press **ENTER** to start programmed playback.
4. To clear a music file from the program list, select the music you want to clear then press **CLEAR** or select “**♪**” icon and then press **ENTER**. To clear all music file from the program list, select “**♪♪**” then press **ENTER**.

! Note

The programs are also cleared when the disc or USB device is removed, the unit is switched to power off or the function is switched to others.

Viewing a PHOTO file

PHOTO

This unit can play discs with photo files.

1. Select the DVD/CD or USB function by pressing **FUNCTION** on the remote control or **F** on the unit.
2. Press **▲/▼** to select a folder, and then press **⊙ ENTER**.
A list of files in the folder appears.
If you are in a file list and want to return to the previous folder list, use the **▲/▼** buttons on the remote to highlight **⏪...** and press **⊙ ENTER**.
3. If you want to view a particular file, press **▲/▼** to highlight a file and press **⊙ ENTER** or Press **▶ MONO/STEREO** on the remote control or **>||** on the unit. While viewing a file, you can Press **■** on the remote control or **□** on the unit to move to the previous menu. (JPEG menu)

Viewing a PHOTO file as a slide show

PHOTO

1. Use **▲/▼/◀/▶** to highlight **(▶)** icon then press **⊙ ENTER** to start slide Show.
2. You can change slide show speed using **◀/▶** when **(▶)** icon is highlighted.

About help menu for slide show.

Menu	Buttons	Operation
▲/▼ 90°/90°	▲/▼	Rotating the picture.
◀/▶ Prev./Next	◀/▶	Moving to another file.
↶ Close	↶ BACK	Returning to the menu.
⊙ Hide	⊙ ENTER	Hiding the help menu.

Turning off the sound temporarily

Press **MUTE** **ⓧ** on the remote control to mute your sound.

You can mute your sound in order, for example, to answer the telephone. And "MUTE" will appear in the display window.

To cancel MUTE function, press **MUTE** **ⓧ** again or adjust volume level by pressing **VOL(+/-)**.

Screen Saver

The screen saver appears when you leave the unit in Stop mode for about five minutes.

System Select - Optional

You must select the appropriate system mode for your TV system. If "NO DISC" appears in the display window, press and hold **||** for more than five seconds to be able to select a system. (AUTO/ PAL/ NTSC)

Displaying file information (ID3 TAG)

You can check the ID3 TAG information of MP3 files only in discs by pressing **DISPLAY** repeatedly.

Setting the Clock

1. Turn the unit on.
2. Press **CLOCK** for at least 2 seconds.
3. Choose time mode by pressing **◀▶** on the remote control or **◀▶** on the unit.
- AM 12:00 (for an AM and PM display) or 0:00 (for a 24 hour display)
4. Press **SET** for confirm your selection.
5. Select the hours by pressing **◀▶** on the remote control or **◀▶** on the unit.
6. Press **SET**.
7. Select the minutes by pressing **◀▶** on the remote control or **◀▶** on the unit.
8. Press **SET**.

Using your player as an alarm clock

1. Turn the unit on.
2. Press **TIMER**. Each functions flashes.
3. Press **SET** when the function you want to be woken by is showing.
4. "ON TIME" will be displayed. This is your desired time to unit turns on. Press **◀▶** on the remote control or **◀▶** on the unit to change the hours and minutes and press **SET** to save.
5. The "OFF TIME" will be displayed. This is your desired time to unit turns off.
6. Press **◀▶** on the remote control or **◀▶** on the unit to change the hours and minutes and press **SET** to save.
7. Press **◀▶** on the remote control or **◀▶** on the unit to change the volume and press **SET** to save.
8. You can adjust to turn alarm on or off by pressing **TIMER**.
 - On : Alarm function is turned on and you can check alarm setting status.
 - Off : Alarm function is turned off and you can check "TIMEROFF" message on **Display window**.

! Note

- After setting a clock function, you can set alarm function.
- If you set the clock time, you can check the time by pressing **CLOCK** even when the player is turned off.
- If you set the alarm time, you can check the setting state by pressing **TIMER** even when the player is turned off.
- If you select DVD/CD mode for alarm sound source with a DVD/DivX CD on the disc tray, the alarm sound source is switched to TUNER mode automatically.
- If you select USB mode for alarm sound source with multi-device USB, the alarm sound source is switched to TUNER mode automatically.

Sleep Timer Setting

Press **SLEEP** one or more times to select delay time between 10 and 180 minutes, after which the unit turn off.

To cancel the sleep function, press **SLEEP** repeatedly until "SLEEP 10" appears, and then press **SLEEP** once again while "SLEEP 10" is displayed.

! Note

- You can check the remaining time before the Unit turns off.
- Press **SLEEP**. The remaining time appears in the display window.
- Sleep function will work after dimmer.

4

Operating

Dimmer

Press **SLEEP** once. The display window will be darkened by half. To cancel it, press **SLEEP** repeatedly until dim off.

Auto Power Down

This unit will be off itself to save electronic consumption in the case main unit is not connected to external device and is not used for 25 minutes.

So does this unit after six hours since Main unit has been connected to other device using analog input.

Radio Operations

Listening to the radio

1. Press **FUNCTION** on the remote control or **F** on the unit until FM appears in the display window. The last received station is tuned in.
2. Press and hold **TUNING (-/+)** on the remote control or **TUN. (-/+)** on the unit for about 2 seconds until the frequency indication starts to change, then release. Scanning stops when the unit tunes in a station.

Or

Press **TUNING (-/+)** on the remote control or **TUN. (-/+)** on the unit repeatedly.

3. Adjust the volume by pressing **VOL +/-** repeatedly.

Presetting the Radio Stations

You can preset 50 stations for FM.

Before tuning, make sure to turn down the volume.

1. Press **FUNCTION** on the remote control or **F** on the unit until FM appears in the display window.
2. Select the desired frequency by pressing **TUNING (-/+)** on the remote control or **TUN. (-/+)** on the unit.
3. Press **PROG./MEMO**. a preset number will flash in the display window.
4. Press **PRESET (▲/▼)** to select the preset number you want.
5. Press **PROG./MEMO**. The station is stored.
6. Repeat steps 2 to 5 to store other stations.
7. To listen a preset station, press **PRESET (▲/▼)**.

Deleting all the saved stations

1. Press and hold **PROG./MEMO**. for two seconds. "CLEAR" will flash up on the unit display.
2. Press **PROG./MEMO**. to erase all saved radio stations.

Improving poor FM reception

Press ► **MONO/STEREO** on the remote control. This will change the tuner from stereo to mono and usually improve the reception.

Sound adjustment

Setting the surround mode

This system has a number of pre-set surround sound fields. You can select a desired sound mode by using  **SOUND EFFECT**.

The displayed items for the Equalizer may be different depending on sound sources and effects.

On Display	Description
AUTO EQ	Sets the sound equalizer on the mode that is the most similar to the genre which is included in the MP3 ID3 tag of song files.
ROCK POP CLASSIC	This program lends an enthusiastic atmosphere to the sound, giving you the feeling you are at an actual rock, pop or classic concert.
BASS (BASS BLAST)	Reinforce the treble, bass and surround sound effect.
BYPASS	You can enjoy the sound without equalizer effect.

Note

Maybe you need reset the surround mode, after switching the input, sometimes even after the sound track changed.

Advanced Operations

Listening to music from your external device

The unit can be used to play the music from many types of external device. (Refer to the page 15)

1. Connect the external device to the **PORT.IN** connector of the unit.
2. Turn the power on by pressing (⏻).
3. Select the **PORTABLE** function by pressing **F** on the unit or **FUNCTION** on the remote control.
4. Turn the external device and start it playing.

4

Operating

Recording to USB

You can record a various sound source to USB.

1. Connect the USB device to the unit.
2. Select a function by pressing **F** on the unit or **FUNCTION** on the remote control.

One track recording - You can record to USB after playing a file you want.

All tracks recording - You can record to USB after stop.

Program list recording - After showing the programmed list, you can record it to USB. (AUDIO CD Only)

3. Start the recording by pressing ● **REC** on the remote control.
4. To stop recording, Press ■ on the remote control or □ on the unit.

! Note

- You can check the recording percentage rate for the USB record on the display window during the recording. (MP3/ WMA CD/ AUDIO CD Only)
- During recording MP3/ WMA, there is no sound.
- When you stop recording during playback, the file that has been recorded at that time will be stored. (AUDIO CD Only)
- Do not remove the USB device or turn off the unit during USB recording. If not, an incomplete file may be made and not deleted on PC.
- If USB recording does not work, the message like "NO USB", "ERROR", "USB FULL" or "NO REC" is displayed on the display window.
- Multi card reader device or External HDD can not be used for USB recording.
- A file is recorded by 2 hours (about 128 Mbytes) when you record for a long term.
- In the state CD-G disc, USB record is not operated.
- You may not record more than 999 files.
- The file number is saved automatically.
- It'll be stored as follows.

AUDIO CD	MP3/ WMA	The other source*
■ CD_REC TRK-001 TRK-002 : :	■ FILE_REC -001_ABC(File name) -002_DEF(File name) : :	■ EXT_REC AUD-001 AUD-002 : :

* : TUNER, PORTABLE and the like.

The making of unauthorized copies of copy-protected material, including computer programs, files, broadcasts and sound recordings, may be an infringement of copyrights and constitute a criminal offense. This equipment should not be used for such purposes.

Be responsible
Respect copyrights

Troubleshooting

Problem	Correction
No Power.	Plug the power cord into the wall outlet securely.
No picture.	<ul style="list-style-type: none"> • Select the appropriate video input mode on the TV so the picture from the unit appears on the TV screen. • Connect the video cables securely to both the TV and unit.
There is little or no sound.	<ul style="list-style-type: none"> • Select the correct input mode of the unit so you can hear the sound from the unit. • Connect the audio cables into the connection terminals correctly. • Replace with new audio cable.
A DVD/CD will not play.	<ul style="list-style-type: none"> • Insert a playable disc.(check the disc type, colour system and regional code) • Insert a disc. • Place the disc with the label or printed side facing upwards. • Enter your password or change the rating level.
Humming noise heard while a DVD or CD is playing.	<ul style="list-style-type: none"> • Clean the disc using a soft cloth with outward strokes. • Move unit and audio components further away from your TV.
Radio stations cannot be tuned in properly.	<ul style="list-style-type: none"> • Check the antenna connection and adjust its position. • Tune to the station manually. • Preset some radio stations, see page 28 for details.
The remote control does not work properly.	<ul style="list-style-type: none"> • The remote control is not pointed at the remote sensor of the unit. Point the remote control at the remote sensor of the unit. • The remote control is too far from the unit. Operate the remote control within about 23 ft (7 m). • There is an obstacle in the path of the remote control and the unit. Remove the obstacle. • The battery in the remote control is exhausted. Replace the battery with new one.

Specifications

General	
Power supply	Refer to the main lable
Power consumption	Refer to the main lable
Net Weight	2.3 kg
External dimensions (W x H x D)	230 x 125 x 243 mm
Operating Temperature	5 °C to 35 °C (41 °F to 95 °F)
Operating humidity	5 % to 85 %

Tuner	
FM Tuning Range	87.5 to 108.0 MHz or 87.50 to 108.00 MHz

Amplifier	
Output Power	30 W + 30 W
T.H.D	10 %

Inputs/ Outputs	
VIDEO OUT	1.0 V (p-p), 75 Ω, sync negative, RCA jack x 1
COMPONENT VIDEO OUT	(Y) 1.0 V (p-p), 75 Ω, sync negative, RCA jack x 1, (Pb)/(Pr) 0.7 V (p-p), 75 Ω, RCA jack x 2

DVD/CD	
Frequency Response	40 Hz to 20 kHz
Signal-to-noise ratio	70 dB
Dynamic range	55 dB

USB	
USB Version	USB 2.0 or USB 1.1
Bus Power Supply	DC 5 V $\overline{\text{---}}$ 500 mA iPod/iPhone DC 5 V $\overline{\text{---}}$ 1 A

Speakers	
Type	2 Way 2 Speaker
Impedance	6 Ω
Rated Input Power	30 W
Max. Input Power	60 W
Net Dimensions (WxHxD)	150 x 250 x 170 mm
Net Weight(1EA)	1.74 kg

- Design and specifications are subject to change without notice.

Maintenance

Handling the Unit

When shipping the unit

Please save the original shipping carton and packing materials. If you need to ship the unit, for maximum protection, re-pack the unit as it was originally packed at the factory.

Keeping the exterior surfaces clean

Do not use volatile liquids such as insecticide spray near the unit.

Wiping with strong pressure may damage the surface.

Do not leave rubber or plastic products in contact with the unit for a long period of time.

Cleaning the unit

To clean the player, use a soft, dry cloth. If the surfaces are extremely dirty, use a soft cloth lightly moistened with a mild detergent solution. Do not use strong solvents such as alcohol, benzine, or thinner, as these might damage the surface of the unit.

Maintaining the Unit

The unit is a high-tech, precision device. If the optical pick-up lens and disc drive parts are dirty or worn, the picture quality could be diminished. For details, please contact your nearest authorized service center.

Notes on Discs

Handling Discs

Never stick paper or tape on the disc.

Storing Discs

After playing, store the disc in its case. Do not expose the disc to direct sunlight or sources of heat and never leave it in a parked car exposed to direct sunlight.

Cleaning Discs

Do not use strong solvents such as alcohol, benzine, thinner, commercially available cleaners, or anti-static spray intended for older vinyl records.

Trademarks and Licenses



Dolby, Pro Logic, and the double-D symbol are registered trademarks of Dolby Laboratories.



"DVD Logo" is a trademark of DVD Format/Logo Licensing Corporation.



DivX®, DivX Certified® and associated logos are trademarks of Rovi Corporation or its subsidiaries and are used under license.

Language Codes

Use this list to input your desired language for the following initial settings: Disc Audio, Disc Subtitle, Disc Menu.

Language	Code	Language	Code	Language	Code	Language	Code
Afar	6565	French	7082	Lithuanian	7684	Sindhi	8368
Afrikaans	6570	Frisian	7089	Macedonian	7775	Singhalese	8373
Albanian	8381	Galician	7176	Malagasy	7771	Slovak	8375
Amharic	6577	Georgian	7565	Malay	7783	Slovenian	8376
Arabic	6582	German	6869	Malayalam	7776	Spanish	6983
Armenian	7289	Greek	6976	Maori	7773	Sudanese	8385
Assamese	6583	Greenlandic	7576	Marathi	7782	Swahili	8387
Aymara	6588	Guarani	7178	Moldavian	7779	Swedish	8386
Azerbaijani	6590	Gujarati	7185	Mongolian	7778	Tagalog	8476
Bashkir	6665	Hausa	7265	Nauru	7865	Tajik	8471
Basque	6985	Hebrew	7387	Nepali	7869	Tamil	8465
Bengali; Bangla	6678	Hindi	7273	Norwegian	7879	Telugu	8469
Bhutani	6890	Hungarian	7285	Oriya	7982	Thai	8472
Bihari	6672	Icelandic	7383	Panjabi	8065	Tonga	8479
Breton	6682	Indonesian	7378	Pashto, Pushto	8083	Turkish	8482
Bulgarian	6671	Interlingua	7365	Persian	7065	Turkmen	8475
Burmese	7789	Irish	7165	Polish	8076	Twi	8487
Byelorussian	6669	Italian	7384	Portuguese	8084	Ukrainian	8575
Chinese	9072	Japanese	7465	Quechua	8185	Urdu	8582
Croatian	7282	Kannada	7578	Rhaeto-Romance	8277	Uzbek	8590
Czech	6783	Kashmiri	7583	Rumanian	8279	Vietnamese	8673
Danish	6865	Kazakh	7575	Russian	8285	Volapük	8679
Dutch	7876	Kirghiz	7589	Samoan	8377	Welsh	6789
English	6978	Korean	7579	Sanskrit	8365	Wolof	8779
Esperanto	6979	Kurdish	7585	Scots Gaelic	7168	Xhosa	8872
Estonian	6984	Laotian	7679	Serbian	8382	Yiddish	7473
Faroese	7079	Latin	7665	Serbo-Croatian	8372	Yoruba	8979
Fiji	7074	Latvian, Lettish	7686	Shona	8378	Zulu	9085
Finnish	7073	Lingala	7678				

Area Codes

Choose an area code from this list.

Area	Code	Area	Code	Area	Code	Area	Code
Afghanistan	AF	Fiji	FJ	Monaco	MC	Singapore	SG
Argentina	AR	Finland	FI	Mongolia	MN	Slovak Republic	SK
Australia	AU	France	FR	Morocco	MA	Slovenia	SI
Austria	AT	Germany	DE	Nepal	NP	South Africa	ZA
Belgium	BE	Great Britain	GB	Netherlands	NL	South Korea	KR
Bhutan	BT	Greece	GR	Antilles	AN	Spain	ES
Bolivia	BO	Greenland	GL	New Zealand	NZ	Sri Lanka	LK
Brazil	BR	Hong Kong	HK	Nigeria	NG	Sweden	SE
Cambodia	KH	Hungary	HU	Norway	NO	Switzerland	CH
Canada	CA	India	IN	Oman	OM	Taiwan	TW
Chile	CL	Indonesia	ID	Pakistan	PK	Thailand	TH
China	CN	Israel	IL	Panama	PA	Turkey	TR
Colombia	CO	Italy	IT	Paraguay	PY	Uganda	UG
Congo	CG	Jamaica	JM	Philippines	PH	Ukraine	UA
Costa Rica	CR	Japan	JP	Poland	PL	United States	US
Croatia	HR	Kenya	KE	Portugal	PT	Uruguay	UY
Czech Republic	CZ	Kuwait	KW	Romania	RO	Uzbekistan	UZ
Denmark	DK	Libya	LY	Russian		Vietnam	VN
Ecuador	EC	Luxembourg	LU	Federation	RU	Zimbabwe	ZW
Egypt	EG	Malaysia	MY	Saudi Arabia	SA		
El Salvador	SV	Maldives	MV	Senegal	SN		
Ethiopia	ET	Mexico	MX				

