



LG

Life's Good

ENGLISH

OWNER'S MANUAL

MONITOR SIGNAGE

Please read this manual carefully before operating your set and retain it for future reference.

MONITOR SIGNAGE MODELS

55WV70MD

WARNING: This product contains chemicals known to the State of California to cause cancer and birth defects or other reproductive harm. ***Wash hands after handling.***

CONTENTS

4 LICENSES

5 ASSEMBLING AND PREPARING

- 5 Accessories
- 6 Parts
- 7 To Install in a Portrait Layout
- 7 Remove L-brackets before Installation
- 8 STORAGE METHOD FOR PANEL PROTECTION
- 8 - Correct Method
- 8 - Incorrect Method
- 9 Installing on a Wall
- 10 EXTERNAL EQUIPMENT SETUP
- 10 - IR RECEIVER
- 11 Tiling Displays
- 11 - How to Mount the Set
- 12 - How to Join Sets

13 REMOTE CONTROL

- 15 Displaying the Device Name Connected to an Input Port

16 USING THE MONITOR SET

- 16 Connecting to a PC
- 16 - RGB Connection
- 17 - DVI Connection
- 17 - HDMI Connection
- 18 - DP Connection
- 18 - IR Receiver Connection
- 19 Adjusting the Screen
- 19 - Selecting an Image Mode
- 19 - Customizing Image Options
- 20 - Customizing PC Display Options
- 20 Adjusting the Sound
- 20 - Selecting an Sound Mode
- 21 - Customizing Sound Options

- 21 Using Additional Options
- 21 - Adjusting Aspect Ratio
- 23 - Using the Input List

24 ENTERTAINMENT

- 24 - Connecting to a Wired Network
- 25 - Network Status
- 26 - Connecting USB Storage Devices
- 27 - Browsing Files
- 29 - Viewing Movies
- 33 - Viewing Photos
- 35 - Listening to Music

37 3D IMAGING (ONLY 3D MODELS)

- 37 3D Technology
- 37 Precautions to Take When Viewing 3D Images
- 38 When Using 3D Glasses
- 39 3D Imaging Viewing Range
- 40 Viewing 3D Imaging
- 41 3D Mode Setting Option

43 CUSTOMIZING SETTINGS

- 43 Accessing Main Menu
- 44 - PICTURE Settings
- 47 - AUDIO Settings
- 48 - TIME Settings
- 49 - OPTION Settings
- 53 Picture ID
- 54 - NETWORK Settings

55 MAKING CONNECTIONS

- 56 Connecting to a HD receiver, DVD, Camcorder, Camera, Gaming Device or VCR player
- 56 - DVI Connection

- 56 - HDMI Connection
- 57 - Component Connection
- 57 - AV(CVBS) Connection
- 58 Connecting to the LAN
- 58 - LAN Connection
- 58 Connecting to a USB
- 59 Daisy Chain Monitors
- 59 - RGB Cable
- 59 - DVI Cable

60 TROUBLESHOOTING

63 TROUBLESHOOTING WHEN USING 3D MODE

64 SPECIFICATIONS

66 CONTROLLING THE MULTIPLE MONITORS

- 66 Connecting the Cable
- 66 RS-232C Configurations
- 66 Communication Parameter
- 67 Command Reference List
- 69 Transmission / Receiving Protocol

82 IR CODES

LICENSES

Supported licenses may differ by model. For more information of the licenses, visit www.lg.com.



HDMI, the HDMI logo and High-Definition Multimedia Interface are trademarks or registered trademarks of HDMI Licensing LLC.



ABOUT DIVX VIDEO: DivX® is a digital video format created by DivX, LLC, a subsidiary of Rovi Corporation. This is an official DivX Certified® device that plays DivX video. Visit divx.com for more information and software tools to convert your files into DivX videos.

ABOUT DIVX VIDEO-ON-DEMAND: This DivX Certified® device must be registered in order to play purchased DivX Video-on-Demand (VOD) movies. To obtain your registration code, locate the DivX VOD section in your device setup menu. Go to vod.divx.com for more information on how to complete your registration.

DivX Certified® to play DivX® video up to HD 1080p, including premium content.

DivX®, DivX Certified® and associated logos are trademarks of Rovi Corporation or its subsidiaries and are used under license.

Covered by one or more of the following U.S. patents: 7,295,673; 7,460,668; 7,515,710; 7,519,274



Manufactured under license from Dolby Laboratories. Dolby and the double-D symbol are trademarks of Dolby Laboratories.

ASSEMBLING AND PREPARING

Accessories

Check your product box for the following items. If there are any missing accessories, contact the local dealer where you purchased your product. The illustrations in this manual may differ from the actual product and accessories.

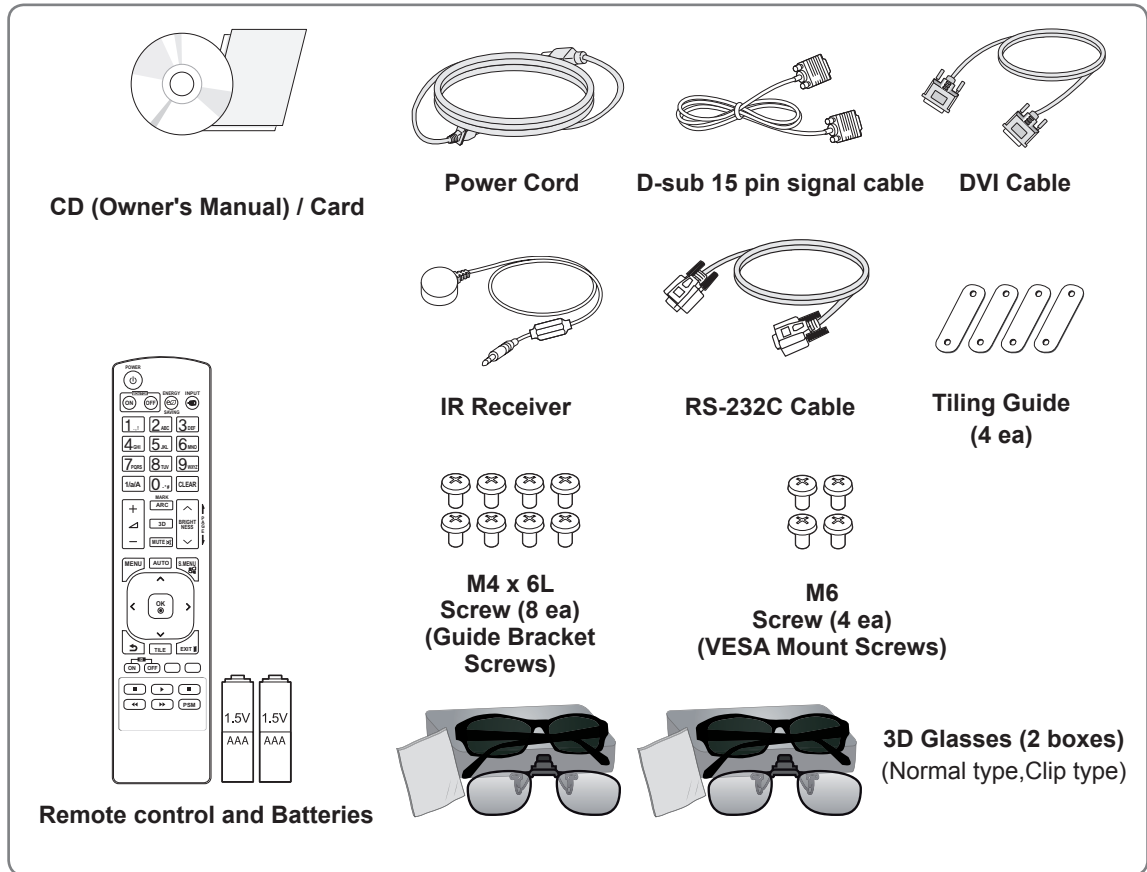

CAUTION

- Do not use any unapproved accessories to ensure the safety and product life span.
- Any damages or injuries by using unapproved accessories are not covered by the warranty.



NOTE

- The accessories supplied with your product may vary depending on the model.
- Product specifications or contents in this manual may be changed without prior notice due to upgrade of product functions.

Parts

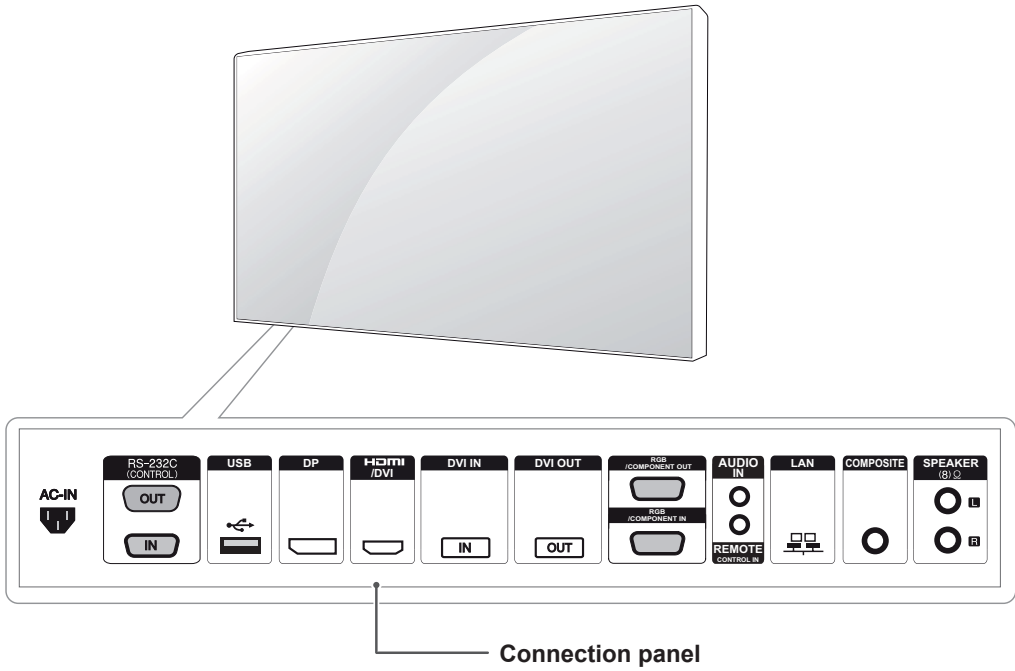

To Install in a Portrait Layout

When installing in a Portrait Layout, rotate the monitor clockwise 90 degrees (when facing the screen).

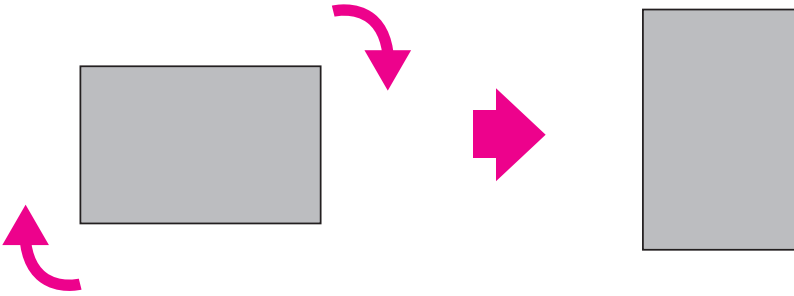

Remove L-brackets before Installation

Remove the L-brackets from each corner of the monitor before installing it.

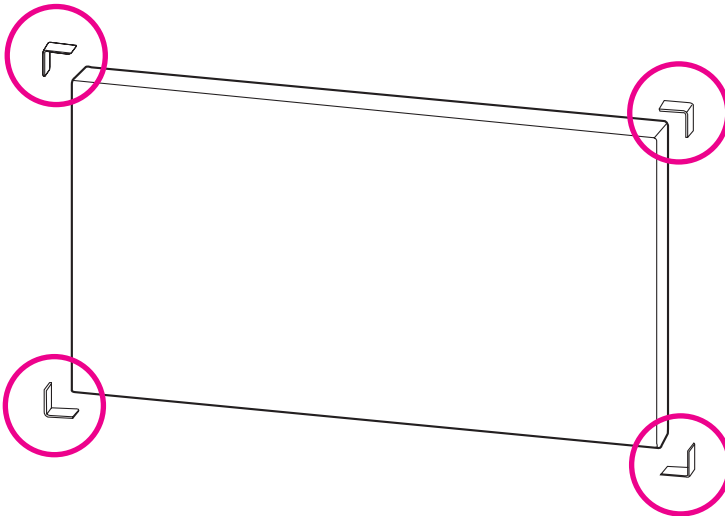

! NOTE

- Keep the removed L-brackets and use them when moving the monitor later.
- 3D function is not supported in portrait mode.

STORAGE METHOD FOR PANEL PROTECTION

Correct Method

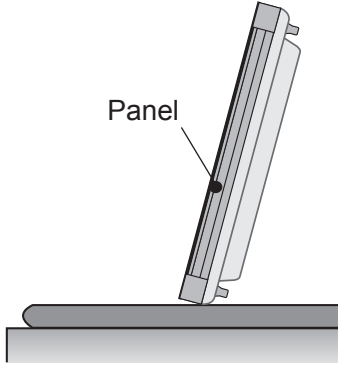

If the product needs to be set upright, hold both sides of the product, and tilt backward carefully. Do not let the panel touch the floor.

Incorrect Method

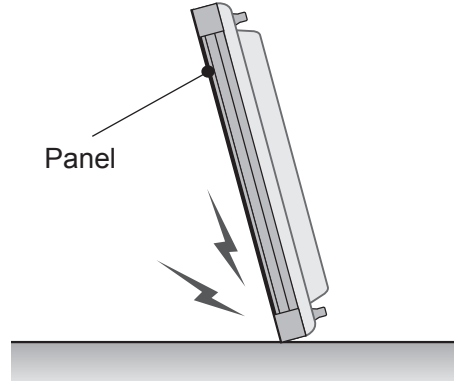

If the product is tilted onto the bezel, the bottom of the panel may be damaged.

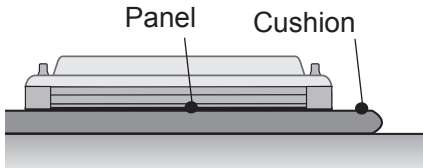

When laying down the product, lay a cushion on a flat floor. Put the product on it with the panel of the product facing down.

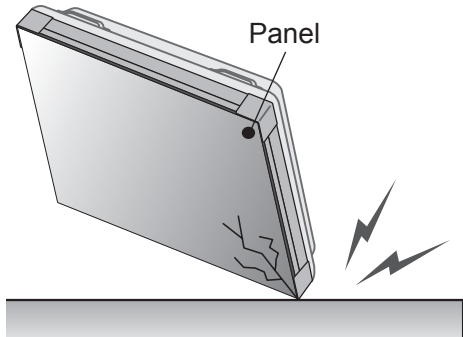

If the product is tilted onto the edge of the panel, the panel may be damaged.

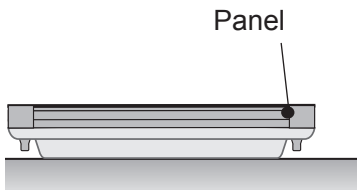

If there is not a cushion available, ensure the floor is clean and then lay the product down carefully with the panel facing either upward or downward. At this time, be careful objects are not fallen on the panel.

Installing on a Wall

To install the Monitor on a wall (optional), use the VESA screws provided as accessories to fasten it.

Please refer to p11 on How to Mount the Set.

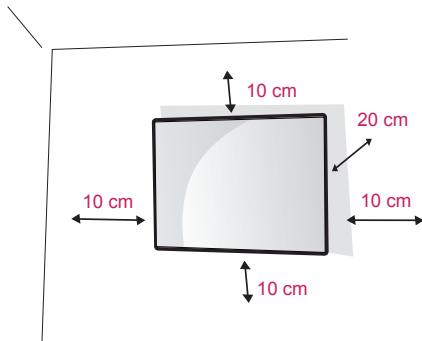

Install the monitor at least 10 cm away from the wall and leave about 10 cm of space at each side of the monitor to ensure sufficient ventilation.

Use the wall mount plate and screws that comply with the VESA standard.



CAUTION

- Disconnect the power cord first, and then move or install the Monitor set. Otherwise electric shock may occur.
- If you install the Monitor set on a ceiling or slanted wall, it may fall and result in severe injury.
- Do not over tighten the screws as this may cause damage to the Monitor set and void your warranty.
- Use the screws and wall mounts that meet the VESA standard. Any damages or injuries by misuse or using an improper accessory are not covered by the warranty.

NOTE

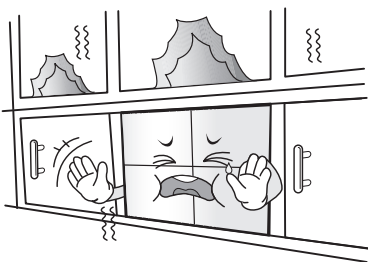

Do not install the product in a place with no ventilation (e.g., on a bookshelf or in a closet) or on a carpet or cushion. If there is no other option but to mount the product on the wall, make sure that sufficient ventilation is provided before installation.

- Failure to do so may result in a fire due to the increase in the internal temperature.

EXTERNAL EQUIPMENT SETUP

IR RECEIVER

This allows a remote control sensor to be placed in a custom location. Then that display can control other displays via an RS-232 cable.

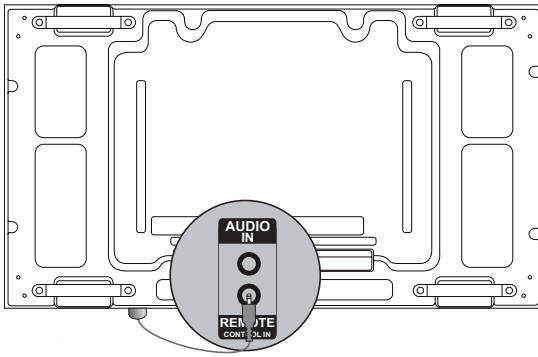

Tiling Displays

How to Mount the Set

*Example of 2 x 2 tiling

* Using the screws for fixing the VESA wall mount, mount the set to the wall mount plate or the wall.

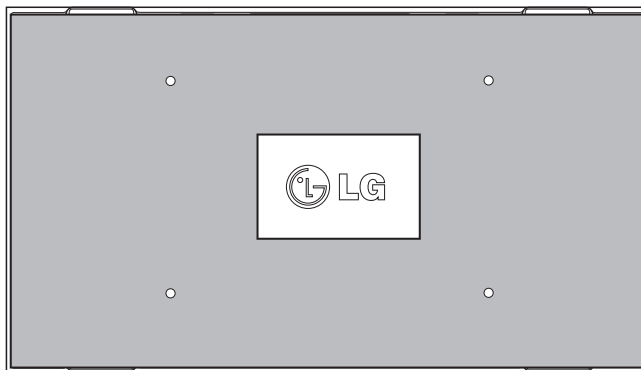
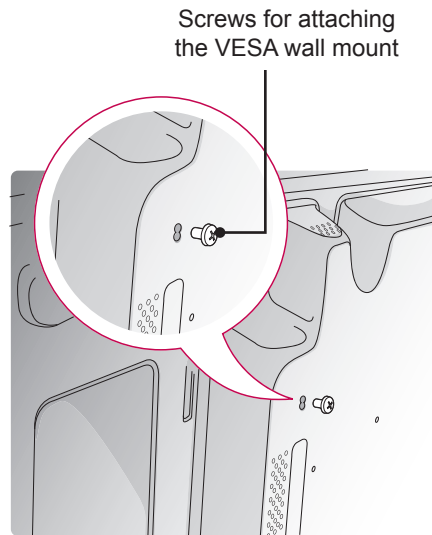

<Rear view of the set with the wall mount plate>

* The wall mount plate is shaded in gray in the illustration to help you see it.

How to Join Sets

- 1 Join other sets using screws for fixing the VESA wall mount in the same way as above.

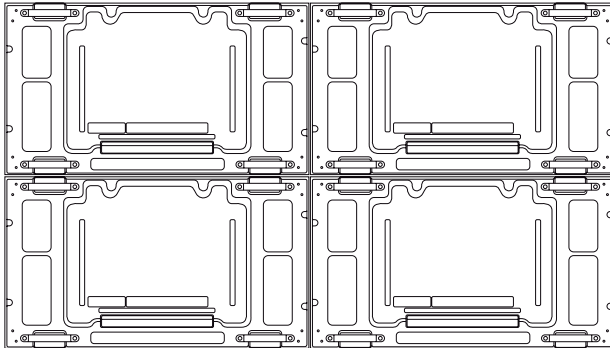

Set 4 joined to the rest of the sets
(2 x 2 tiling)

- 2 After joining the sets, use the tiling guide to adjust the gap between the sets.

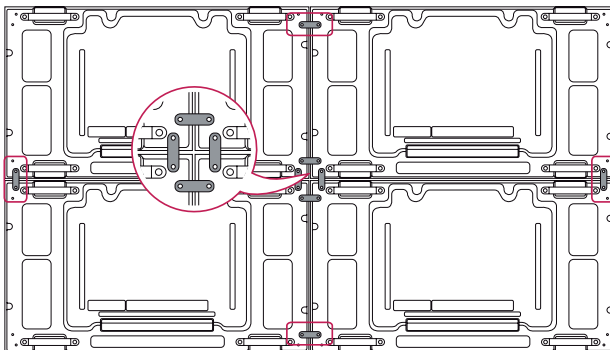

- 3 Now the 2 x 2 tiling is complete.
You can tile in various combinations, such as 3 x 3.

! NOTE

- The load applied to each set should be supported by the wall mount plate or the wall using a VESA wall mount (600 x 400).
- The load applied to each set should be supported by the wall mount plate using a VESA wall mount. (Each set must be firmly mounted to the wall mount plate or the wall.)
- You may mount the set without using the tiling guide; this does not affect the performance of the device.

REMOTE CONTROL

The descriptions in this manual are based on the buttons of the remote control. Please read this manual carefully and use the Monitor correctly.

To replace batteries, open the battery cover, replace batteries (1.5 V AAA) matching ⊕ and ⊖ ends to the label inside the compartment, and close the battery cover.

To remove the batteries, perform the installation actions in reverse.

CAUTION

- Do not mix old and new batteries, as this may damage the remote control.
- Make sure to point the remote control to the remote control sensor on the Monitor.

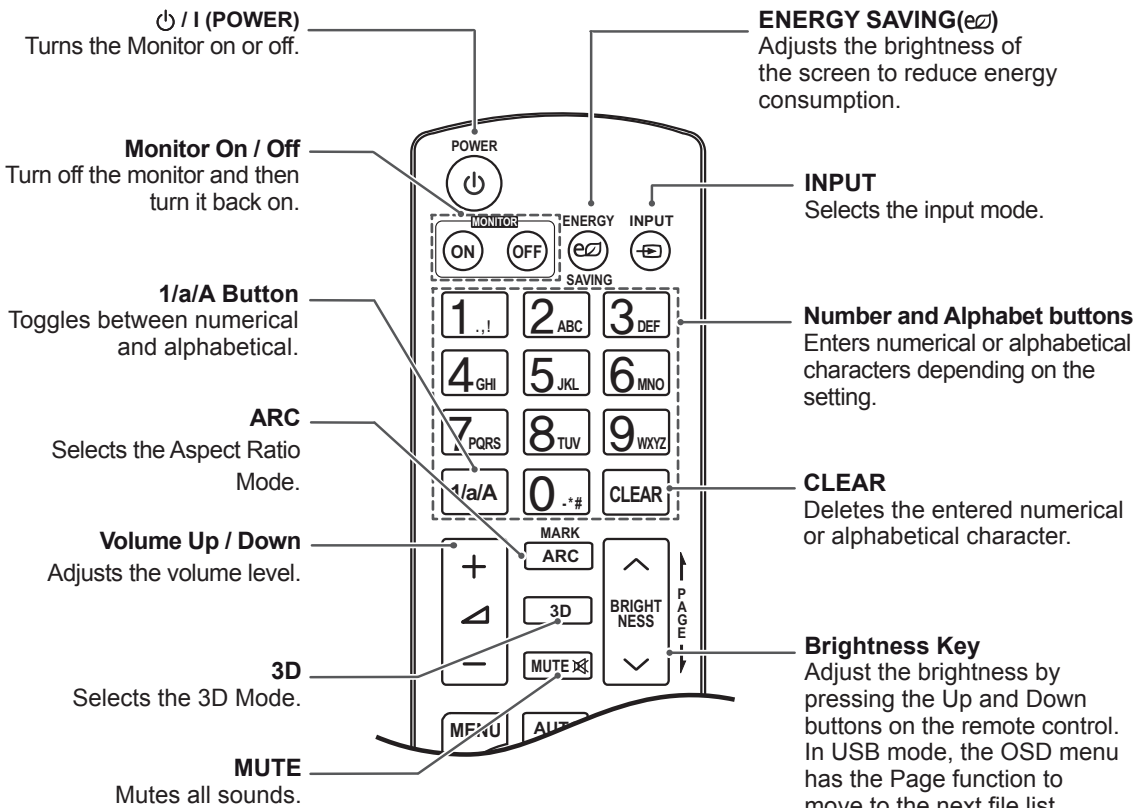
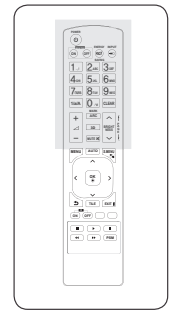
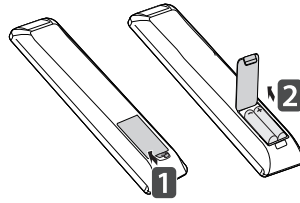

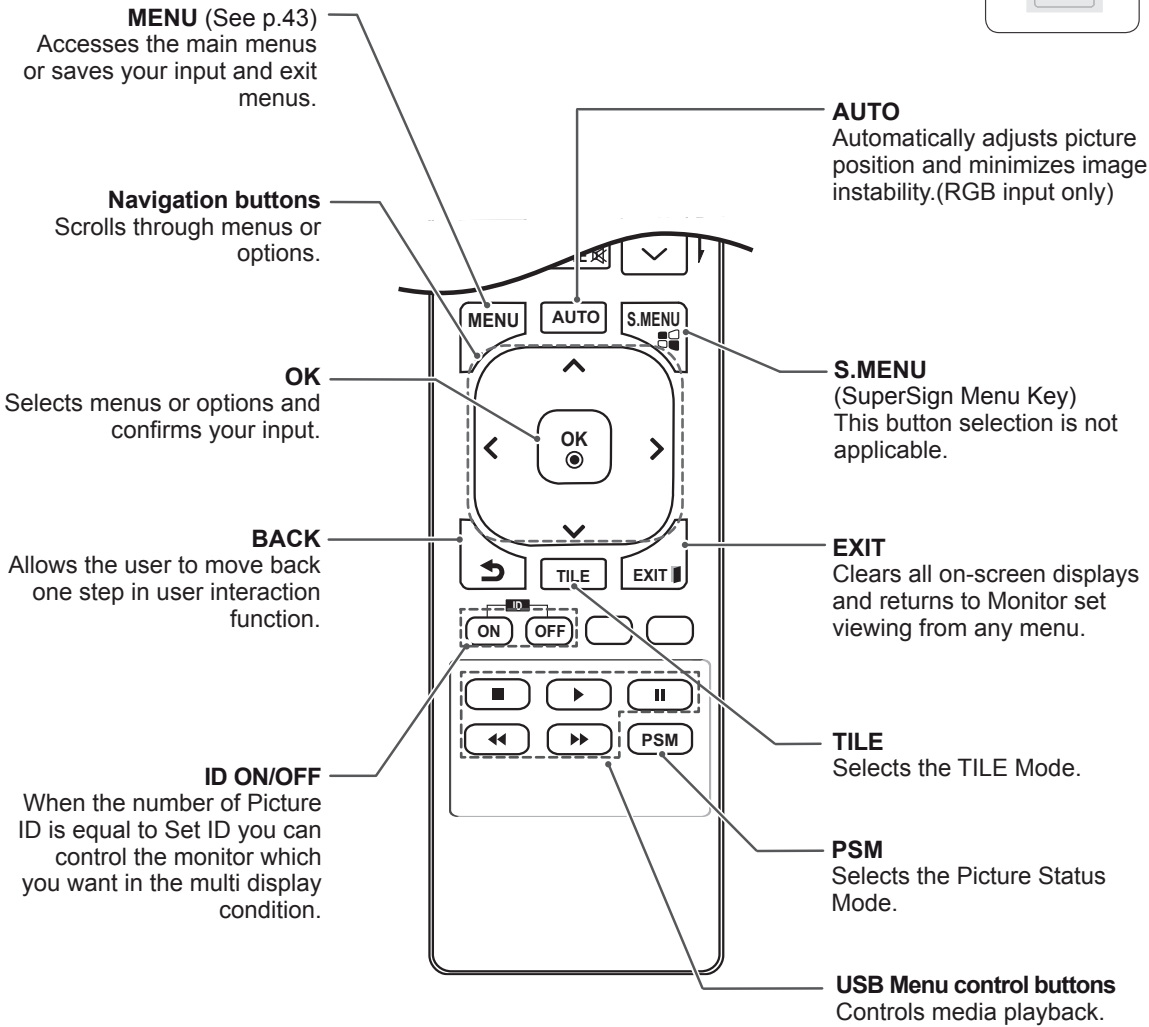

Displaying the Device Name Connected to an Input Port

Display which devices are connected to which external input ports.

- 1 Access the Input list screen and press the blue (input label) button on the remote control.

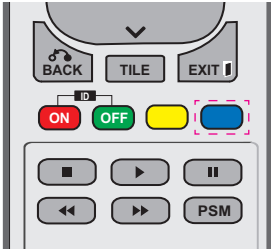

NOTE

- External inputs supported: AV, Component, RGB, HDMI, DVI-D, Display Port
- Labels available : VCR, DVD, Set top box, Satellite, Game, PC, Blue-ray, HD-DVD
- The input labels are displayed on the Input Label screen or at the top left of the screen when you change the external input setting.
- For DTV/PC-compatible signals, such as 1080p 60 Hz, the screen settings may change according to the input label. The Just Scan option is available if a PC is connected as an external device.

- 2 You can assign an input label for every input except USB.

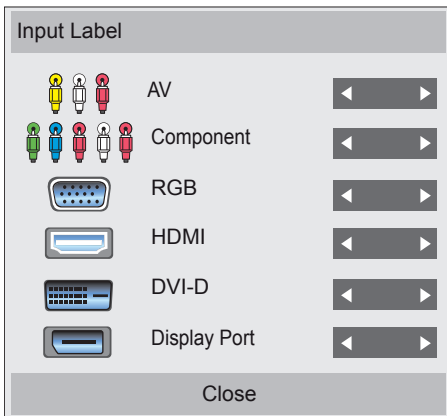

USING THE MONITOR SET

Connecting to a PC

Your Monitor set supports the Plug & Play* feature.

* Plug & Play: A PC will have a built-in driver for the monitor, no extra software is needed.

NOTE

- It is recommended to use the Monitor set with the HDMI connection for the best image quality.
- To comply with the specifications of the product, use a shielded interface cable with ferrite core, such as D-sub 15 pin cable and DVI/HDMI cable provided with the product.
- If you turn the Monitor set on when the set becomes cold, the screen may flicker. This is normal.
- Some red, green, or blue spots may appear on the screen. This is normal.

RGB Connection

Transmits the analog video signal from your PC to the Monitor set. Connect the PC and the Monitor set with the 15 pin signal cable as shown in the following illustrations. Select RGB input.

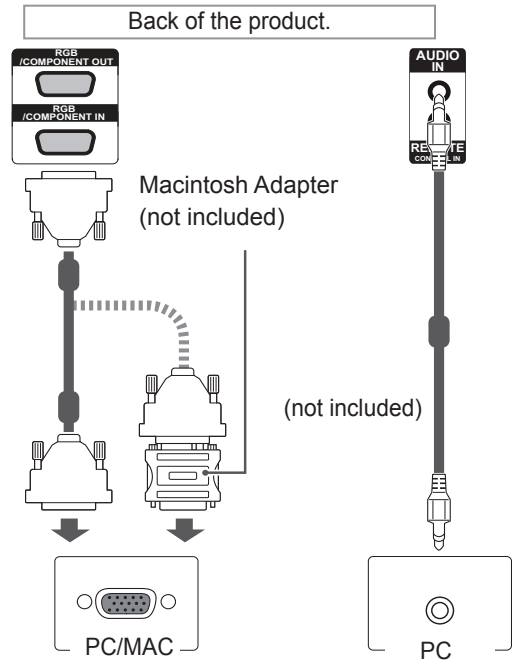

CAUTION

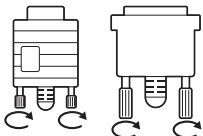

- Connect the signal input cable and tighten it by turning the screws clockwise.

- Do not press the screen with your finger for a long time as this may result in temporary distortion on the screen.
- Avoid displaying a fixed image on the screen for a long period of time to prevent image burn. Use a screensaver if possible.

NOTE

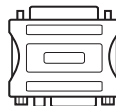

- Use the standard Macintosh adapter since an incompatible adapter is available in the market. (Different signaling system)
- Apple computers may require an adapter to connect to this monitor. Call or visit their web site for more information.

DVI Connection

Transmits the digital video signal from your PC to the Monitor set. Connect the PC and the Monitor set with the DVI cable as shown in the following illustrations. Select DVI input.

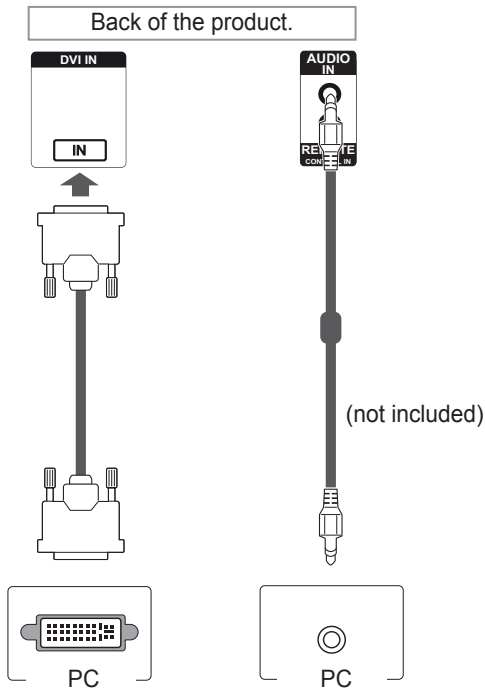

HDMI Connection

Transmits digital video and audio signals from your PC to the Monitor set. Connect the PC and the Monitor set with the HDMI cable as shown in the following illustrations. Select HDMI input.

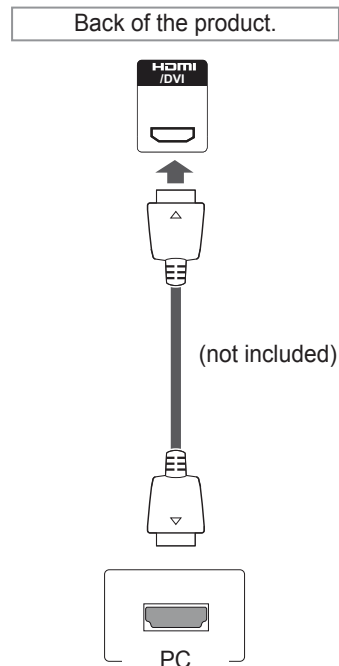

! NOTE

- Use a High Speed HDMI™ Cable.
- Please check the PC environment if you cannot hear sound in HDMI mode. Some PCs require you to manually change the default audio output to HDMI.
- If you want to use HDMI-PC mode, you must set the input label to PC mode.
- When HDMI PC is used, a compatibility problem might occur.

DP Connection

Transmits the digital video and audio signals from your PC to the Monitor set. Connect the PC and the Monitor set with the DP cable as shown in the following illustrations.

Select DP input.

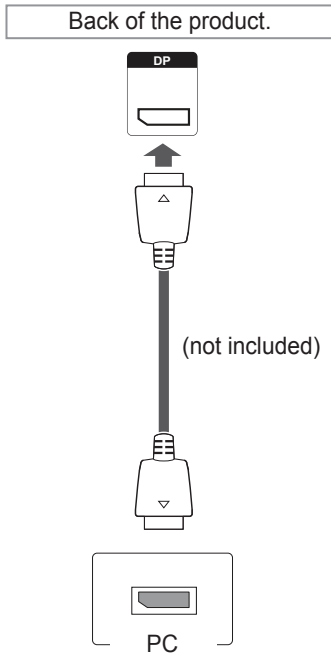

IR Receiver Connection

Allows the use of a wired remote or IR receiver extension.

Back of the product.

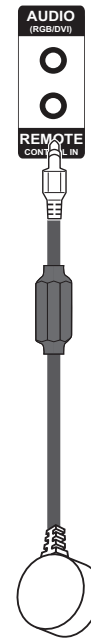

! NOTE

- Sound may not be available depending on the DP version of your PC.

Adjusting the Screen

Selecting an Image Mode

Display images in its optimized settings by selecting one of the preset image modes.

- 1 Press **MENU** to access the main menus.
- 2 Press the Navigation buttons to scroll to **PICTURE** and press **OK**.
- 3 Press the Navigation buttons to scroll to **Picture Mode** and press **OK**.
- 4 Press the Navigation buttons to scroll to an image mode you want and press **OK**.

Mode	Description
Vivid	Adjusts the video image for the retail environment by enhancing the contrast, brightness, Colour, and sharpness.
Standard	Adjusts the image for the normal environment.
Cinema	Optimizes the video image for a cinematic look to enjoy movies as if you are in a movie theater.
Sport	Optimizes the video image for high and dynamic actions by emphasizing primary Colors such as white, grass, or sky blue.
Game	Optimizes the video image for a fast gaming screen such as PCs or games.

- 5 When you are finished, press **EXIT**.
When you return to the previous menu, press **BACK**.

Customizing Image Options

Customize basic and advanced options of each image mode for the best screen performance.

- 1 Press **MENU** to access the main menus.
- 2 Press the Navigation buttons to scroll to **PICTURE** and press **OK**.
- 3 Press the Navigation buttons to scroll to **Picture Mode** and press **OK**.
- 4 Press the Navigation buttons to scroll to an image mode you want and press **OK**.
- 5 Select and adjust following options, and then press **OK**.

Option	Description
Backlight	Adjusts the brightness of the screen by controlling the LCD backlight. If you decrease the brightness level, the screen becomes darker and the power consumption will be reduced without any video signal loss.
Contrast	Increases or decreases the gradient of the video signal. You may use Contrast when the bright part of the picture is saturated.
Brightness	Adjusts the base level of the signal in the picture. You may use Brightness when the dark part of the picture is saturated.
Sharpness	Adjusts the level of crispness in the edges between the light and dark areas of the picture. The lower the level, the softer the image.
Color	Adjusts intensity of all colors.
Tint	Adjusts the balance between red and green levels.
Color Temp.	Set to warm to enhance hotter Colors such as red, or set to cool to make picture bluish.
Advanced Control	Customizes the advanced options. Refer to the Advanced image options.
Picture Reset	Restores the options to the default setting.

- 6 When you are finished, press **EXIT**.
When you return to the previous menu, press **BACK**.

Customizing PC Display Options

Customize options of each image mode for the best image quality.

- This function works in the following mode: RGB[PC] mode.
- 1 Press **MENU** to access the main menus.
 - 2 Press the Navigation buttons to scroll to **PICTURE** and press **OK**.
 - 3 Press the Navigation buttons to scroll to **Screen** and press **OK**.
 - 4 Select and adjust following options, and then press **OK**.

Option	Description
Resolution	Selects a proper resolution. See "Customizing PC display options".
Auto Config.	Sets to adjust the screen position, clock, and phase automatically. The displayed image may be unstable for a few seconds while the configuration is in progress.
Position/ Size/Phase	Adjusts the options when the picture is not clear, especially when characters are shaky, after the auto configuration.
Reset	Restores the options to the default setting.

- 5 When you are finished, press **EXIT**.
When you return to the previous menu, press **BACK**.

Adjusting the Sound

Selecting an Sound Mode

Play the sound in its optimized settings by selecting one of the preset sound modes.

- 1 Press **MENU** to access the main menus.
- 2 Press the Navigation buttons to scroll to **AUDIO** and press **OK**.
- 3 Press the Navigation buttons to scroll to **Sound Mode** and press **OK**.
- 4 Press the Navigation buttons to scroll to a sound mode you want and press **OK**.

Mode	Description
Standard	Select when you want standard-quality sound.
Music	Select when you listen to music.
Cinema	Select when you watch movies.
Sports	Select when you watch sports events.
Game	Select when you watch gaming events.

- 5 When you are finished, press **EXIT**.
When you return to the previous menu, press **BACK**.

Customizing Sound Options

Customize options of each sound mode for the best sound quality.

- 1 Press **MENU** to access the main menus.
- 2 Press the Navigation buttons to scroll to **AUDIO** and press **OK**.
- 3 Press the Navigation buttons to scroll to **Sound Mode** and press **OK**.
- 4 Press the Navigation buttons to scroll to a sound mode you want and press **OK**.
- 5 Select and adjust following options, and then press **OK**.

Option	Description
Infinite Surround	LG's Infinite Surround option provides 5.1 channel stereo sound from two speakers.
Treble	Controls the dominant sounds in the output. When you turn up the treble, it will increase the output to the lower frequency range.
Bass	Makes the output sound softer. If the bass is increased, the frequency of the output also increases.
Reset	Resets the sound mode to the default setting.

- 6 When you are finished, press **EXIT**. When you return to the previous menu, press **BACK**.

Using Additional Options

Adjusting Aspect Ratio

Resize the image to view the image at its optimal size by pressing **ARC** while you are watching Monitor set.



CAUTION

- If a fixed image displays on the screen for a long period of time, it will be imprinted and become a permanent disfigurement on the screen. This is "image burn" or "burn-in" and not covered by the warranty.
- If the aspect ratio is set to 4:3 for a long period of time, image burn may occur on the letterboxed area of the screen.



NOTE

You can also change the image size by accessing the main menus.

MODE \ ARC	AV	Component	RGB		Display Port		DVI-D		HDMI	
			PC	DTV	PC	PC	DTV	PC		
16:9	o	o	o	o	o	o	o	o	o	o
Just Scan	x	o	x	o	x	x	o	x		x
1:1	x	x	o	x	o	o	x	o		o
4:3	o	o	o	o	o	o	o	o	o	o
Zoom	o	o	x	o	x	x	o	x		x
Cinema Zoom	o	o	x	o	x	x	o	x		x

- **16:9** : This selection will allow you to adjust the picture horizontally, in linear proportion, to fill the entire screen(useful for viewing 4:3 formatted DVDs).
- **4:3** : This selection will allow you to view a picture with an original 4:3 aspect ratio, black bars will appear on both the left and right of the screen.

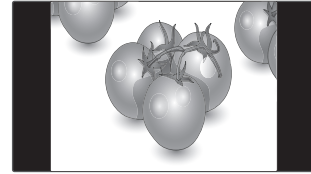
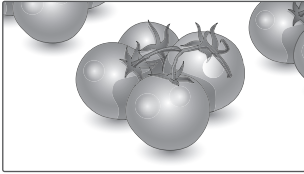

- **Just Scan** : This Selection will allow you view the picture of best quality without loss of original picture in high resolution image. Note: If there is noise in original Picture, You can see the noise at the edge.
- **Zoom** : This selection will allow you to view the picture without any alteration, while filling the entire screen. However, the top and bottom of the picture will be cropped.

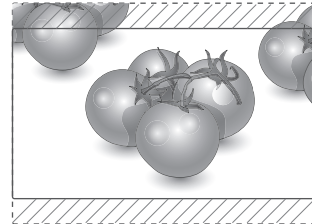

- **1:1** : The aspect ratio is not adjusted from the original. (Only Display Port PC, HDMI PC, DVI-D PC, RGB PC)
- **Cinema Zoom** : Choose Cinema Zoom when you want to enlarge the picture in correct proportion. Note: When enlarging or reducing the picture, the image may become distorted.

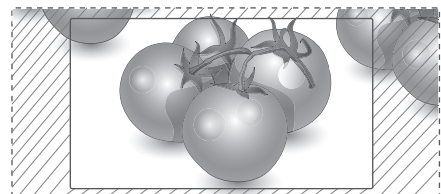
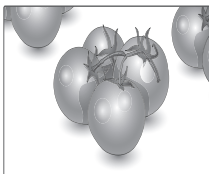

Using the Input List

Selecting an input source

- 1 Press **INPUT** to access the input source list.
- 2 Press the Navigation buttons to scroll to one of the input sources and press **OK**.

Input source	Description
AV(CVBS)	Watch video from a VCR or other external devices.
Component	Watch the contents in a DVD or other external devices, or through a digital set-top box
RGB	View a PC display on the screen
DVI-D	View a PC display on the screen
HDMI	Watch contents in a PC, DVD of Digital set-top box other high definition devices
Display Port	Watch contents in a PC, DVD of Digital set-top box other high definition devices

ENTERTAINMENT

Connecting to a Wired Network

Connect the display to a local area network (LAN) via the LAN port as shown on the following illustration and set up the network settings.

Only supports wired network connection.

After making a physical connection, a small number of networks may require the display network settings to be adjusted. For most networks, the display will connect to automatically without any adjustments.

For detail information, contact your internet provider or router manual.

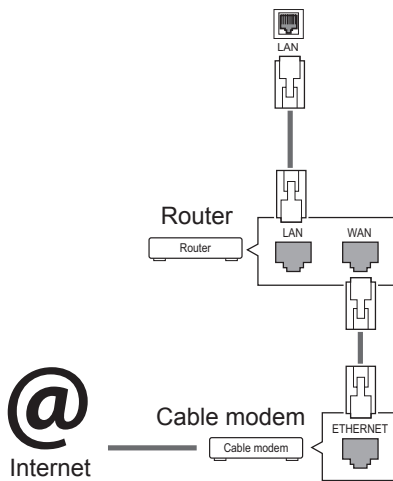

To set up the network settings: (Even if your display has already connected automatically, running setup again will not harm anything),

- 1 Press **MENU** to access the main menus.
- 2 Press the Navigation buttons to scroll to **NETWORK** and press **OK**.
- 3 Press the Navigation buttons to select **Network Setting** and press **OK**.
- 4 If you already set Network Setting, select **Resetting**. The new connection settings resets the current network settings.
- 5 Select **IP Auto Setting** or **IP Manual Setting**.
 - If selecting **IP Manual Setting**, press the Navigation and Number buttons. IP addresses will need to be input manually.
 - **IP Auto Setting**: Select this if there is a DHCP server (Router) on the local area network (LAN) via wired connection, the display will automatically be allocated an IP address. If you're using a broadband router or broadband modem that has a DHCP (Dynamic Host Configuration Protocol) server function. The IP address will automatically be determined.
- 6 When you are finished, press **EXIT**.

! CAUTION

- Do not connect a modular phone cable to the LAN port.
- Since there are various connection methods, please follow the specifications of your telecommunication carrier or internet service provider.

! CAUTION

- Network setting menu will not be available until the display connected to physical network.
- Since there are various connection methods, please follow the specifications of your telecommunication carrier or internet service provider.

NOTE

- If you want to access the Internet directly on your display, the internet connection should always be on.
- If you cannot access the Internet, check the network conditions from a PC on your network.
- When you use **Network Setting**, check the LAN cable or check if DHCP in the router is turned on.
- If you do not complete the network settings, the network may not work properly.

Tips for Network setting

- Use a standard LAN cable with this display. Cat5 or better with a RJ45 connector.
 - Many network connection problems during set up can often be fixed by re-setting the router or modem. After connecting the display to the network, quickly power off and/or disconnect the power cable of the network router or cable modem. Then power on and/or connect the power cable again.
 - Depending on the internet service provider (ISP), the number of devices that can receive internet service may be limited by the applicable terms of service. For details, contact your ISP.
 - LG is not responsible for any malfunction of the display and/or the internet connection feature due to communication errors/malfunctions associated with your internet connection, or other connected equipment.
 - LG is not responsible for problems within your internet connection.
 - You may experience undesired results if the network connection speed does not meet the requirements of the content being accessed.
 - Some internet connection operations may not be possible due to certain restrictions set by the Internet service provider (ISP) supplying your Internet connection.
 - Any fees charged by an ISP including, without limitation, connection charges are your responsibility.
 - A 10 Base-T or 100 Base-TX LAN port is required when using a wired connection to this display. If your internet service does not allow for such a connection, you will not be able to connect the display.
- A DSL modem is required to use DSL service and a cable modem is required to use cable modem service. Depending on the access method of and subscriber agreement with your ISP, you may not be able to use the internet connection feature contained in this display or you may be limited to the number of devices you can connect at the same time. (If your ISP limits sub-scription to one device, this display may not be allowed to connect when a PC is already connected.)
 - The use of a "Router" may not be allowed or its usage may be limited depending on the policies and restrictions of your ISP. For details, contact your ISP directly.

Network Status

- 1 Press **MENU** to access the main menus.
- 2 Press the Navigation buttons to scroll to **NETWORK** and press **OK**.
- 3 Press the Navigation buttons to select **Network Status**.
- 4 Press **OK** to check the network status.
- 5 When you are finished, press **EXIT**.

Option	Description
Setting	Return to the network setting menu.
Test	Test the current network status after setting the network.
Close	Return to the previous menu.

Connecting USB Storage Devices

Connect USB storage devices such as a USB flash memory, external hard drive to the display and use multimedia features (See "Browsing Files" on page 27).

Connect a USB flash memory or USB memory card reader to the Display as shown on the following illustration. The My media screen appears.

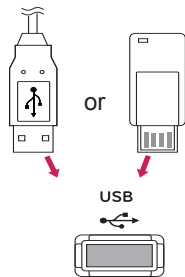

CAUTION

- Do not turn the display off or remove a USB storage device while EMF(my media) Menu is activated, as this could result in loss of files or damage to the USB storage device.
- Back up your files saved on a USB storage device frequently, as you may lose or damage the files and this may be not covered by the warranty.

Tips for using USB storage devices

- Only a USB storage device is recognizable.
- If the USB storage device is connected through a USB hub, the device is not recognizable.
- A USB storage device using an automatic recognition programme may not be recognized.
- A USB storage device which uses its own driver may not be recognized.
- The recognition speed of a USB storage device may depend on each device.
- Please do not turn off the display or unplug the USB device when the connected USB storage device is working. When such device is suddenly separated or unplugged, the stored files or the USB storage device may be damaged.
- Please do not connect the USB storage device which was artificially maneuvered on the PC. The device may cause the product to malfunction or fail to be played. Never forget to use only a USB storage device which has normal music files, image files or movie files.
- Please use only a USB storage device which was formatted as a FAT32 file system, NTFS file system provided with the Windows operating system. In case of a storage device formatted as a different utility programme which is not supported by Windows, it may not be recognized.
- Please connect power to a USB storage device(over 0.5 A) which requires an external power supply. If not, the device may not be recognized.
- Please connect a USB storage device with the cable offered by the device maker.
- Some USB storage devices may not be supported or operated smoothly.
- File alignment method of USB storage device is similar to Window XP and filename can recognize up to 100 English characters.

- Be sure to back up important files since data stored in a USB memory device may be damaged. We will not be responsible for any data loss.
- If the USB HDD does not have an external power source, the USB device may not be detected. So be sure to connect the external power source.
 - Please use a power adaptor for an external power source. We do not guarantee an USB cable for an external power source.
- If your USB memory device has multiple partitions, or if you use a USB multi-card reader, you can use up to 4 partitions or USB memory devices.
- If a USB memory device is connected to a USB multi-card reader, its volume data may not be detected.
- If the USB memory device does not work properly, disconnect and reconnect it.
- How fast a USB memory device is detected differs from device to device.
- If the USB is connected in Standby Mode, specific hard disk will automatically be loaded when the display is turned on.
- The recommended capacity is 1 TB or less for a USB external hard disk and 32 GB or less for USB memory.
- Any device with more than the recommended capacity may not work properly.
- If a USB external hard disk with a “Energy Saving” function does not work, turn the hard disk off and on again to make it work properly.
- USB storage devices below USB 2.0 are supported as well. But they may not work properly in the movie list.
- Maximum of 999 folders or files can be recognized under one folder.
- A USB 3.0 storage device may not work.

Browsing Files

Access the photo, music, or movie lists and browse files.

- 1 Connect a USB storage device.
- 2 Press **MENU** to access the main menus.
- 3 Press the Navigation buttons to scroll to **My Media** and press **OK**.
- 4 Press Navigation buttons to scroll to All Media, Movie List, Photo List, or Music List and press **OK**.
 - All Media: Shows all files in the file list.
 - Movie List, Photo List, or Music List: Shows only one type of file in the file list.
- 5 Press Navigation buttons to select a folder or file.

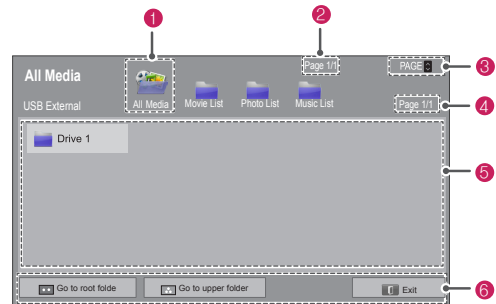

No.	Description
①	Shows all media folders.
②	Current page number/total number of pages.
③	Moves to the previous or next page.
④	Current page number/total number of pages.
⑤	Files info or thumbnail.
⑥	Available buttons on the remote control.

Supported file format

Type	Supported file format		
Movie	Supported Maximum resolution : 1920 x 1080 @30p (only Motion JPEG 640x480 @30p) .asf, .wmv [Video] VC-1 Advanced Profile, VC-1 Simple and Main Profiles [Audio] WMA Standard .divx, .avi [Video] DivX3.11, DivX4, DivX5, DivX6, XviD, H.264/AVC, Motion JPEG [Audio] MPEG-1 Layer I, II, Dolby Digital, MPEG-1 Layer III (MP3), DTS .mp4, .m4v, .mov [Video] H.264/AVC, MPEG-4 Part 2, XviD [Audio] AAC, MPEG-1 Layer III (MP3), DTS.mkv [Video] H.264/AVC, XviD, MPEG-4 Part2 [Audio] HE-AAC, Dolby Digital, MPEG-1 Layer III (MP3), DTS .ts, .trp, .tp [Video] H.264/AVC, MPEG-2 [Audio] MPEG-1 Layer I, II, MPEG-1 Layer III (MP3), Dolby Digital, Dolby Digital Plus, AAC .vob [Video] MPEG-1, MPEG-2 [Audio] Dolby Digital, MPEG-1 Layer I, II, DVD-LPCM .mpg, .mpeg, .mpe [Video] MPEG-1 [Audio] MPEG-1 Layer I, II		
Photo	JPEG Baseline : 64 x 64 to 15360 x 8640 Progressive : 64 x 64 to 1920 x 1440 <ul style="list-style-type: none"> You can play JPEG files only. Non-supported files are displayed in the form of predefined icon. 		
	File Extensions	Item	Profile
2D	jpeg jpg jpe	Supported file format	<ul style="list-style-type: none"> SOF0: baseline, SOF1: Extend Sequential, SOF2: Progressive
		Photo size	<ul style="list-style-type: none"> Min : 64 x 64 Max: Normal Type: 15360 (W) x 8640 (H) Progressive Type: 1920 (W) x 1440 (H)
3D (Only 3D models)	mpo	Supported file format	mpo
		Photo size	<ul style="list-style-type: none"> 4:3 size : 3,648 x 2,736 / 2,592 x 1,944 / 2,048 x 1,536 3:2 size : 3,648 x 2,432
Music	<ul style="list-style-type: none"> File type : mp3 [Bit rate] 32 Kbps - 320 Kbps [Sample freq.] 16 kHz - 48 kHz [Support] MPEG1, MPEG2, Layer2, Layer3 		

Viewing Movies

Play video files on display. Your display shows all of the video files saved in a USB storage device or shared folder on a PC.

- 1 Press the Navigation buttons to scroll to **My Media** and press **OK**.
- 2 Press the Navigation buttons to scroll to **Movie List** and press **OK**.
- 3 Press the Navigation buttons to scroll to a folder you want and press **OK**.
- 4 Press the Navigation buttons to scroll to a file you want and press **OK**.

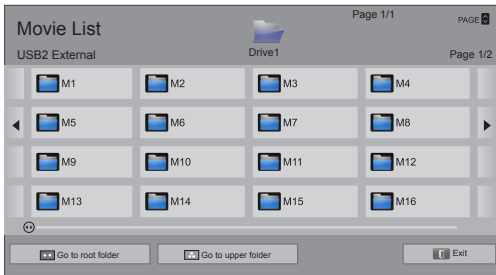

Button	Description
Navigation button	Scrolls through the files.
OK	Plays the highlighted file.
PAGE	Moves to the previous or next page.
Green button	Go to root folder.
Yellow button	Go to upper folder.

- 5 Play a movie.

NOTE

- An unsupported file displays a preview image icon only **5**.
- Abnormal files are displayed in the form of bitmap **5**.

- 6 Control playback by using the following buttons.

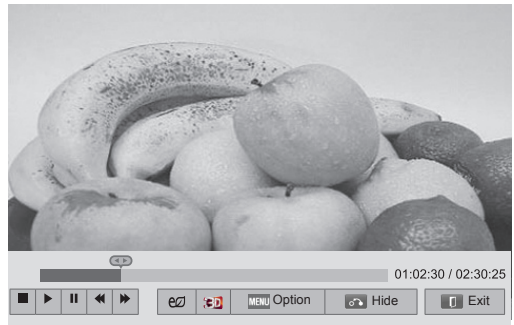

Button	Description
■	Stops the playback.
▶	Plays a video.
⏸	Pauses or resumes the playback.
◀	Scans backward in a file.
▶	Scans forward in a file.
⏪ and ⏩	Plays videos in slow motion.
< >	Selects the frame directly. The entire file is divided into 10 frames. Frames may not be displayed depending on the file.
ENERGY SAVING	Increases or decreases the brightness of your screen.
3D (Only 3D models)	Views the 3D imaging.
MENU	Shows the Option menu.
AV MODE	Select the desired source.
BACK	Hides the menu on screen. To see the menu again, press OK button to display.
EXIT	Moves to the previous menu screen.

Tips for using playing video files

- Some user-created subtitles may not work properly.
- Some special characters are not supported in subtitles.
- HTML tags are not supported in subtitles.
- Subtitles in languages other than the supported languages are not available.
- The screen may suffer temporary interruptions (image stoppage, faster playback, etc.) when the audio language is changed.
- A damaged movie file may not be played correctly, or some player functions may not be usable.
- Movie files produced with some encoders may not be played correctly.
- If the video and audio structure of recorded file is not interleaved, either video or audio is outputted.
- Videos with resolutions higher than 1920X1080@25/30P may not work properly depending on the frame.
- Movie files other than the specified types and formats may not work properly.
- Max bitrate of playable movie file is 20 Mbps. (only, Motion JPEG : 10 Mbps)
- We do not guarantee smooth playback of profiles encoded level 4.1 or higher in H.264/AVC.
- DTS Audio codec is not supported.
- A movie file more than 30 GB in file size is not supported for playback.
- A DivX movie file and its subtitle file must be located in the same folder.
- A video file name and its subtitle file name must be identical for it to be displayed.
- Playing a video via a USB connection that doesn't support high speed may not work properly.
- Files encoded with GMC(Global Motion Compensation) may not be played.
- When you are watching the movie by Movie List function, you can adjust an image by Energy Saving key on the remote control. User setup for each image mode does not operate.

Video options

- 1 Press **MENU** to access the **Pop-Up** menus.
- 2 Press the Navigation buttons to scroll to **Set Video Play.**, **Set Video.** or **Set Audio.** and press **OK**.

NOTE

- Option values changed in **Movie List** does not affect **Photo List** and **Music List**.
- Option value changed in **Photo List** and **Music List** are changed likewise in **Photo List** and **Music List** excluding **Movie List**.
- When replaying the video file after stopping, you can play from where it stopped previously.

MENU options for movie list

- 1 Press **MENU**.
A pop-up window will appears.
- 2 Press the Navigation buttons to scroll to the option and press **OK**.
- 3 Press the Navigation buttons to scroll to one of the following options and press **OK**.

Set Video Play.

Option	Description										
Picture Size	Selects your desired picture format for videos. <ul style="list-style-type: none"> • Full Mode: Files are played in full screen mode according to the aspect ratio of video. • Original Mode: Files are played in their native size. 										
Audio Language	Changes the Language Group of the audio for video files. Files with a single audio track cannot be selected.										
Subtitle Language	The subtitles can be turned on or off.										
Language	Activated for SMI subtitles and can select the language within the subtitle.										
Code Page	Subtitle font selection. When set to default, contents are displayed in the language set in "Option - Language - Menu Language".										
	<table border="1"> <thead> <tr> <th>Option</th> <th>Description</th> </tr> </thead> <tbody> <tr> <td>Subtitle Language Group</td> <td> <ul style="list-style-type: none"> • Latin1 : English, Spanish, French, German, Italian, Swedish, Finnish, Dutch, Portuguese, Danish, Romanian, Norwegian, Albanian, Gaelic, Welsh, Irish, Catalan, Valencian • Latin2 : Bosnian, Polish, Croatian, Czech, Slovak, Slovenian, Serbian, Hungarian • Latin4 : Estonian, Latvian, Lithuanian • Cyrillic : Bulgarian, Macedonian, Russian, Ukrainian, Kazakh • Greek : Greek • Turkish : Turkish </td> </tr> <tr> <td>Sync</td> <td>If the video is not synchronized with the captions, it can be adjusted by 0.5 second.</td> </tr> <tr> <td>Position</td> <td>Move the location of the subtitles.</td> </tr> <tr> <td>Size</td> <td>Changes the subtitle font size.</td> </tr> </tbody> </table>	Option	Description	Subtitle Language Group	<ul style="list-style-type: none"> • Latin1 : English, Spanish, French, German, Italian, Swedish, Finnish, Dutch, Portuguese, Danish, Romanian, Norwegian, Albanian, Gaelic, Welsh, Irish, Catalan, Valencian • Latin2 : Bosnian, Polish, Croatian, Czech, Slovak, Slovenian, Serbian, Hungarian • Latin4 : Estonian, Latvian, Lithuanian • Cyrillic : Bulgarian, Macedonian, Russian, Ukrainian, Kazakh • Greek : Greek • Turkish : Turkish 	Sync	If the video is not synchronized with the captions, it can be adjusted by 0.5 second.	Position	Move the location of the subtitles.	Size	Changes the subtitle font size.
	Option	Description									
	Subtitle Language Group	<ul style="list-style-type: none"> • Latin1 : English, Spanish, French, German, Italian, Swedish, Finnish, Dutch, Portuguese, Danish, Romanian, Norwegian, Albanian, Gaelic, Welsh, Irish, Catalan, Valencian • Latin2 : Bosnian, Polish, Croatian, Czech, Slovak, Slovenian, Serbian, Hungarian • Latin4 : Estonian, Latvian, Lithuanian • Cyrillic : Bulgarian, Macedonian, Russian, Ukrainian, Kazakh • Greek : Greek • Turkish : Turkish 									
	Sync	If the video is not synchronized with the captions, it can be adjusted by 0.5 second.									
Position	Move the location of the subtitles.										
Size	Changes the subtitle font size.										
Repeat	Turn on/off repeat function of movie playback. When turned on, the file within the folder will be played back repeatedly. When turned off, if the next file name is similar to the previous file, it can be played sequentially.										

NOTE

- Option values changed in Movie List does not affect Photo List and Music List.
- Option value changed in Photo List and Music List are changed likewise in Photo List and Music List excluding Movie List.
- When replaying a video file after stopping, select "Yes" to restart where it previously stopped.
- If continuous series files exist within the folder, the next file will automatically be played. But, this excludes cases when the **Repeat** function of Movie List Option is turned "On".

Set Video.

Allows you to change Video presets. (Refer to “PICTURE Settings”)

Set Audio.

Allows you to change Audio presets. (Refer to “AUDIO Settings”)

**NOTE**

- Only 10,000 of sync blocks can be supported within the subtitle file.
- When playing a video, you can adjust the Picture Size by pressing the ARC button.
- Subtitles in your language are only supported when the OSD menu is also in this language.
- The code page options may be disabled depending on the language of the subtitle files.
- Select the appropriate code page for the subtitle files.

Viewing Photos

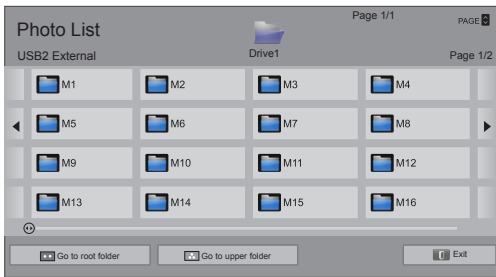

View image files saved in a USB storage device. The displays on the screen may differ from the model.

- 1 Press the Navigation buttons to scroll to **My Media** and press **OK**.
- 2 Press the Navigation buttons to scroll to **Photo List** and press **OK**.
- 3 Press the Navigation buttons to scroll to a folder you want and press **OK**.
- 4 Press the Navigation buttons to scroll to a file you want and press **OK**.



Button	Description
Navigation button	Scrolls the file.
OK	Views the highlighted file.
PAGE	Moves to the previous or next page.
Green button	Go to root folder.
Yellow button	Go to upper folder.

NOTE



- An unsupported file displays a preview image icon only .
- Abnormal files are displayed in the form of bitmap .

Using photo options

Use the following options while viewing photos.



Option	Description
Slideshow	Starts or stops a slideshow with selected photos. If there are no selected photos, all photos saved in the current folder display during a slideshow. Select Option to set the speed and view mode of the slideshow.
BGM	Turns the background music on or off. To set the background music folder, select Option . You can adjust Option by MENU button on the remote control.
Rotate	Rotates photos clockwise (90°, 180°, 270°, 360°). <div style="border: 1px solid black; padding: 5px;"> <p>NOTE</p> <ul style="list-style-type: none"> • The supported photo size is limited. You cannot rotate a photo if the resolution of the rotated width is larger than the supported resolution size. </div>
Zoom	Enlarges the image to 200% or 400%. <div style="border: 1px solid black; padding: 5px;"> <p>NOTE</p> <ul style="list-style-type: none"> • Zoom to 200% or 400% only work for image of 1372×772 pixel size or larger. </div>

 ENERGY SAVING	Press the ENERGY SAVING button repeatedly to change the brightness of your screen.
3D (Only 3D models)	Views the 3D imaging.
Option	<ul style="list-style-type: none"> • Slide Speed: Selects a slideshow speed (Fast, Medium, Slow). • BGM: Selects a music folder for the background music. <div style="border: 1px solid black; border-radius: 10px; padding: 10px; margin-top: 10px;"> <p> NOTE</p> <ul style="list-style-type: none"> • You cannot change the music folder while the background music is playing. • You can only select the MP3 folder saved on the device that currently displays the photo. </div>
Hide	Hides the option window. To display the options, press OK .
EXIT	Return to Photo List .

MENU options for photo list

- 1 Press **MENU**.
A pop-up window will appear.
- 2 Press the Navigation buttons to scroll to the option and press **OK**.
- 3 Press the Navigation buttons to scroll to one of the following options and press **OK**.

Set Photo View.

Option	Description
Slide Speed	Selects a slideshow speed (Fast, Medium, Slow).
BGM	Selects a music folder for the background music. Select Repeat or Random option. <div style="border: 1px solid black; border-radius: 10px; padding: 10px; margin-top: 10px;"> <p> NOTE</p> <ul style="list-style-type: none"> • You cannot change the music folder while the background music is playing. </div>

 **NOTE**

- Option values changed in Photo List do not affect Movie List.
- Option values changed in Photo List or Music List are changed likewise in Photo List and Music List, but not Movie List.

Set Video.

Allows you to change Video settings. (Refer to "PICTURE Settings")

Set Audio.

Allows you to change Audio settings. (Refer to "AUDIO Settings")

Listening to Music

- 1 Press the Navigation buttons to scroll to **My Media** and press **OK**.
- 2 Press the Navigation buttons to scroll to **Music List** and press **OK**.
- 3 Press the Navigation buttons to scroll to a folder you want and press **OK**.
- 4 Press the Navigation buttons to scroll to a file you want and press **OK**.

- 5 Play music.

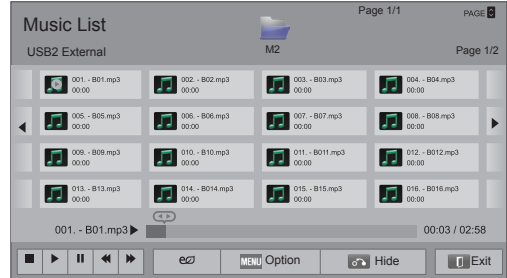
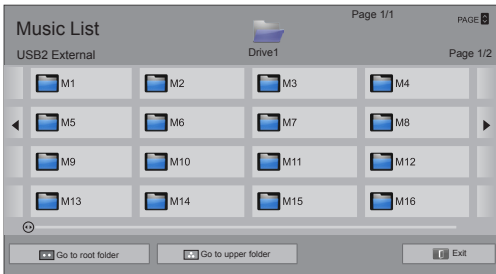

Button	Description
Navigation button	Scrolls through the files.
OK	Plays the highlighted file.
PAGE	Moves to the previous or next page.
Green button	Go to root folder.
Yellow button	Go to upper folder.
Blue button	Open music player. It is enabled during music playback.

Button	Description
■	Stops playback.
▶	Plays a music file.
⏸	Pauses or resumes playback.
◀	Skips to the previous file.
▶	Skips to the next file.
< >	Indicates a cursor.
⚡ (ENERGY SAVING)	Increases or decreases the brightness of your screen.
MENU	Shows the Option menu.
EXIT	Hides the option window. To display the options, press OK .
BACK	Moves to the previous menu screen.

Tips for playing music files

- This unit cannot support the ID3 Tag embedded MP3 files.

MENU options for music list

- 1 Press **MENU**.
A pop-up window will appear.
- 2 Press the Navigation buttons to scroll to the option and press **OK**.
- 3 Press the Navigation buttons to scroll to one of the following options and press **OK**.

**NOTE**

- Option values changed in Music List do not affect Movie List.
- Option value changed in Photo List and Music List are changed likewise in Photo List and Music List.

Set Audio Play.

Select Repeat or Random option.

Set Audio.

Allows you to change Audio settings. (Refer to “AUDIO Settings”)

**NOTE**

- The monitor will not play copy protected files.
- If the monitor is not in use for some time during playback, the information box as a screen-saver will appear to prevent image burn. To return to the Music list screen, press **OK**.

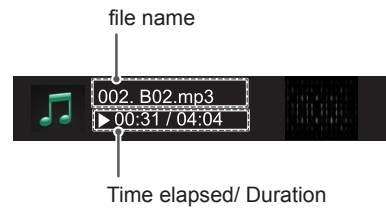

3D IMAGING (Only 3D Models)

3D Technology

This Monitor can display in 3D when the Monitor is connected to a compatible device, such as a Blu-ray 3D Player. The viewer must wear compatible 3D glasses in order to see these images in 3D format.

Precautions to Take When Viewing 3D Images



WARNING

- If you view 3D images from too close a distance, your eyesight may deteriorate.
- If you view images in 3D for a long period of time, you may feel dizzy or experience blurred vision.
- If you are pregnant, elderly, have heart problems, experience severe nausea or if you are under the influence of alcohol, we recommend that you do not view 3D images. This is because the 3D images can cause disorientation and confusion.
- Put fragile or breakable objects away when viewing 3D images.
- Such objects may break, or cause personal injuries when you are startled by the realistic 3D images.
- Parents should prevent children who are 5 years or younger from watching 3D images because viewing 3D images can be harmful to vision development.

• Warning about photosensitivity seizures

Some users may have a seizure or other abnormal reactions when they are exposed to a flashing light or a particular pattern in a video game or film. If anyone in your family has a history of epilepsy or has ever experienced any kind of seizure, please consult your doctor before viewing 3D images. If you exhibit any of the symptoms listed below when viewing 3D images, stop viewing immediately and have a break.

- » Dizziness, blurred vision or facial tics, involuntary movements, twitching, blackouts, confusion and disorientation. Please consult your doctor if such symptoms persist.
- To prevent a photosensitivity seizure, please take the following precautions.
 - » Have a 5- to 15-minute break every hour.
 - » If your left and right eye sight is significantly different, correct the sight difference first.
 - » You should be able to see all of the screen at eye level.
 - » If you experience headaches, fatigue or dizziness, stop viewing and have a rest.
 - » Do not view 3D images when you are tired or ill.

**CAUTION**

- 3D is a technology that displays an image based on binocular disparity, giving the image depth. For optimal 3D experience, wear the 3D glasses provided with the product and keep the optimal viewing angle and distance.

When Using 3D Glasses

**CAUTION**

- Do not use the 3D glasses to replace your corrective glasses, sunglasses or protective goggles.
- Do not store 3D glasses in very hot or very cold conditions. If you do, this may cause them to become distorted. Do not use distorted glasses.
- Do not drop objects onto the 3D glasses. Do not drop or bend the glasses.
- Since the lenses of the 3D glasses are easily scratched, make sure to clean only with a soft cloth. Shake off any dust before using the cloth
- Do not scratch the surface of the lens(Polarized film) of 3D glasses with a sharp tool or wipe the lens with chemicals.
- Be careful not to poke your eye out with the frames of the 3D glasses.
- Please use 3D glasses certified by LG Electronics.
- The lens of the 3D glasses is different from those of general glasses, and is very thin. Therefore be careful with the glasses as the lens can be popped out easily.
- Be careful of the edges of the glass frame when putting on the 3D glasses.

3D Imaging Viewing Range

Monitor size, viewing angle & other circumstances may change the viewing distance and the angle of view.

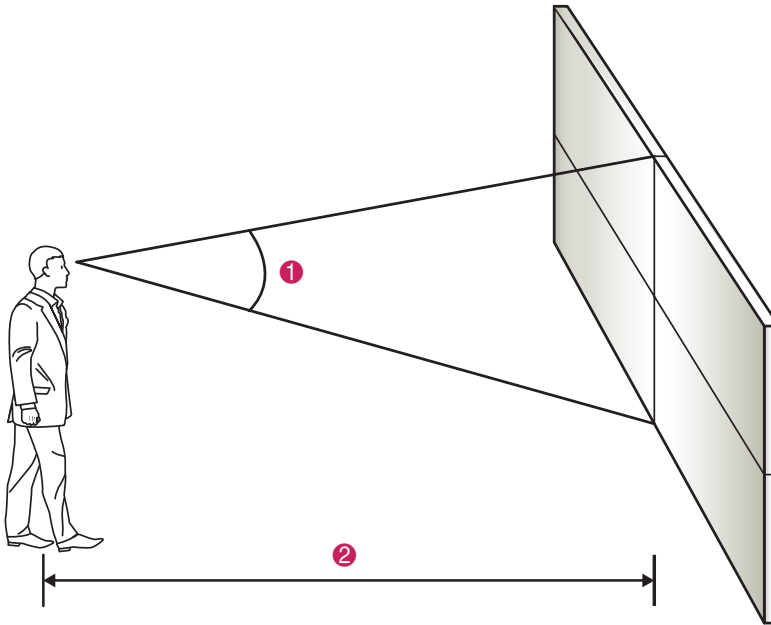

No.	Description
1	Adjust the product height to allow you to view images at the optimal viewing angle (D).
2	Adjust your distance from the SET to allow you to view images from the optimal distance (L).



Mode	Optimal Viewing Angle (D)	Size	Configuration	Optimal Viewing Distance (L) (From the middle of multiple screens)
When watching 3D images	30°	686 mm	Landscape: one or more Portrait: one	1,280 mm or longer
		1,372 mm	Landscape: one or more Portrait: two	2,560 mm or longer
		2,058 mm	Landscape: one or more Portrait: three	3,840 mm or longer

! NOTE

- When you are outside the optimal viewing angle or optimal viewing distance, 3D images may look overlapped or not be displayed properly in 3D.
- 3D crosstalk may occur depending on the depth of 3D content.

Viewing 3D Imaging

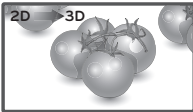
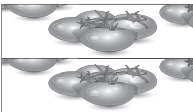
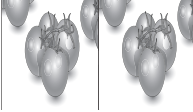
- 1 Play the video produced in 3D.
- 2 Press **3D**.
- 3 Wear the 3D glasses.
- 4 Press the Navigation buttons to scroll the shape and press **OK**.
- 5 Press the Navigation buttons to scroll the **OK** and press **OK**.

Mode	Description
2D → 3D	Changed from 2D imaging to 3D imaging. 
Top & Bottom	
Side by Side	
Frame Sequential	

- 6 Press **3D** button to **2D Off** or **3D Off**.

Mode	Description
3D → 2D	Displays images in 2D without any 3D effects.
2D → 3D	Displays images in 3D.
3D Off	Displays images in original format.
Cancel	Close the pop-up window.



NOTE

- To watch 3D images, set your media player (e.g. Windows Media Player or other players) to full screen mode. Otherwise, 3D images will not be displayed properly.

3D Mode Setting Option

- 1 Press **3D SETTING** to access the **Pop-Up** menus.
- 2 Press the Navigation buttons to scroll to one of the following options and press **OK**

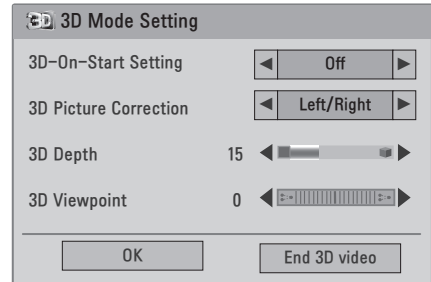

The available Programme settings are described in the following:

Option	Description
3D-On-Start Setting	Enables the 3D mode automatically when the SET starts.
3D Picture Correction	Select Left/Right or Right/Left. Select the screen with 3D video with better visibility.
3D Depth	Adjusts the stereoscopic effect of the 3D image converted from a 2D image.
3D Viewpoint	Moves the 3D image to the front and back to adjust the 3D perspective view.

NOTE

- The Image View Mode option is disabled when 2D images are converted into 3D.
- The 3D Depth option is enabled when 2D images are converted into 3D.
- You cannot enter the Main menu while watching 3D imaging mode.

CAUTION

- Some menus may not work in 3D imaging mode.
- The 3D imaging is disabled automatically when switching input source.
- The screen may not be displayed properly if you view 2D images in 3D imaging mode.
- 3D effect can be seen when 3D Mode is selected appropriately for the 3D input signal supplied to the Monitor.
- When watching a 3D movie from the USB device, Picture Mode is not supported.

Supported 3D input formats

Input	Signal	Resolution	Horizontal Frequency (kHz)	Vertical Frequency (Hz)	Supported 3D Formats
HDMI/Display Port	1080p	1920*1080	53.95 / 54	23.98 / 24	Frame packing (HDMI Only)
		1920*1080	67.5	60	Side by Side(half), Top & bottom Single Frame Sequential
		1920*1080	27	24	Side by Side(half), Top & bottom
		1920*1080	33.7	30	Side by Side(half), Top & bottom
	1080i	1920*1080	33.7	60	Side by Side(half), Top & bottom
	720p	1280*720	89.9 / 90	59.94/60	Frame packing (HDMI Only)
		1280*720	45	60	Side by Side(half), Top & bottom
		1280*720	44.772	59.855	Side by Side(half), Top & bottom
RGB	-	1920*1080	67.5	60	Side by Side, Top & Bottom
DVI	-	1920*1080	67.5	60	Side by Side, Top & Bottom
	-	1280*720	44.772	59.855	Side by Side, Top & Bottom
USB	1080p	1920*1080	33.75	30.000	Side by Side, Top & Bottom

 **NOTE**

- To play videos and media in HDMI 3D Frame Packing, HDMI 3D Side by Side or HDMI 3D Top & Bottom, the player needs to support these formats.
- Any image inputted in the HDMI 1.4 3D format is automatically converted into 3D.
- When a 3D image is converted to 2D, the left and right borders of the image may appear truncated depending on the content file.
- The 2D → 3D mode is available for all input modes.
- When the input source is changed, 3D mode is automatically disabled.
- When viewing multiple photos stored on the USB device, the conversion from 2D to 3D is maintained.
- When viewing multiple video files stored on the USB device, the 3D mode is also maintained.
- If the screen calibration is not performed in RGB input, 3D images may not be displayed properly.

CUSTOMIZING SETTINGS

Accessing Main Menu

- 1 Press **MENU** to access the main menus.
- 2 Press the Navigation buttons to scroll to one of the following menus and press **OK**.
- 3 Press the Navigation buttons to scroll to the setting or option you want and press **OK**.
- 4 When you are finished, press **EXIT**.
When you return to the previous menu, press **BACK**.

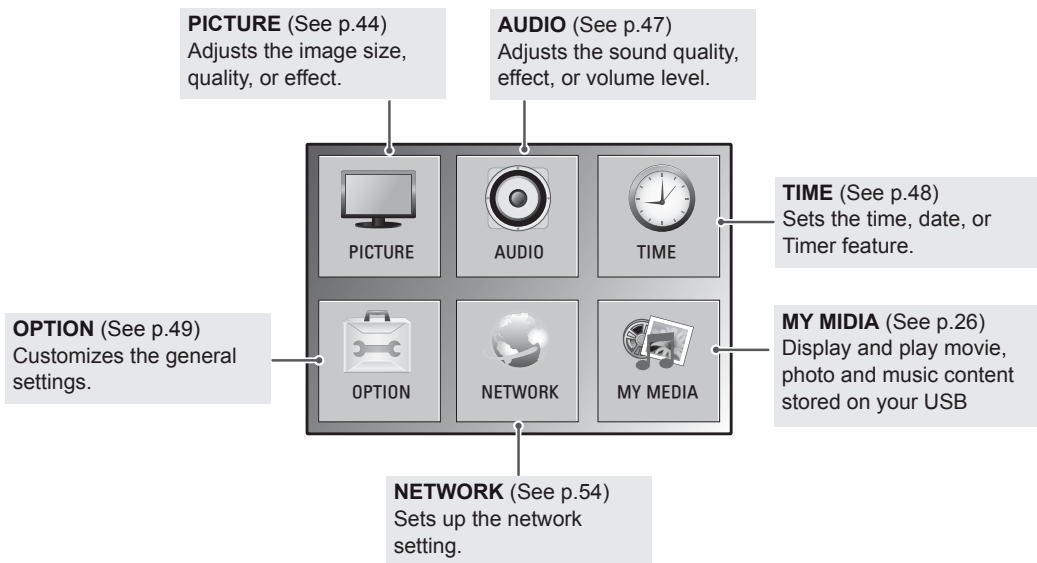
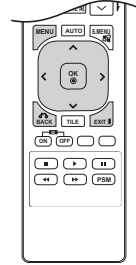

PICTURE Settings

- 1 Press **MENU** to access the main menus.
- 2 Press the Navigation buttons to scroll to **PICTURE** and press **OK**.
- 3 Press the Navigation buttons to scroll to the setting or option you want and press **OK**.
 - To return to the previous level, press **BACK**.
- 4 When you are finished, press **EXIT**.
When you return to the previous menu, press **BACK**.

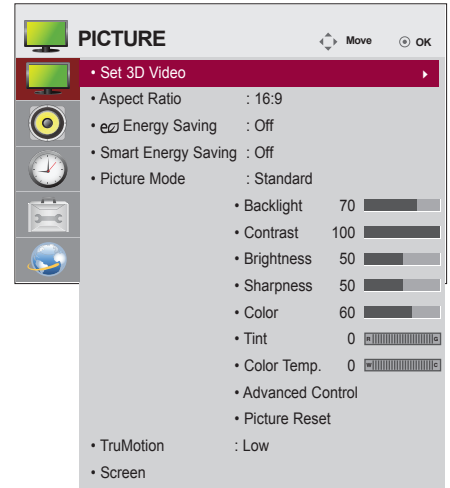

The available picture settings are described in the following:

Setting	Description
Set 3D Video (Only 3D model)	Sets the 3D imaging option.
Aspect Ratio	Changes the image size to view images at its optimal size (See p.21).
Energy Saving	Sets to automatically adjust the screen brightness corresponding to the surroundings.
	Level
	Off Disables Energy Saving function.
	Minimum/ Medium/ Maximum Selects the brightness level of the backlight.
	Screen Off The screen turns off in 3 seconds.
Smart Energy Saving	Adjusts the backlight and contrast depending on the screen brightness.
	Level
	On Enables the Smart Energy Saving function to save power consumption as much as the value set in the smart energy saving rate.
	Off Disables the Smart Energy Saving function.
Picture Mode	Selects one of the preset image or customizes options in each mode for the best Monitor set screen performance. You are also able to customize advanced options of each mode. The available preset picture modes vary depending on the Monitor set .
	Mode
	Vivid Adjusts the video image for the retail environment by enhancing the contrast, brightness, Color, and sharpness.
	Standard Adjusts the image for the normal environment.
	Cinema Optimizes the video image for a cinematic look to enjoy movies as if you are in a movie theater.
	Sport Optimizes the video image for high and dynamic actions by emphasizing primary Colours such as white, grass, or sky blue.
	Game Optimizes the video image for a fast gaming screen such as PCs or games.

Setting	Description	
SCREEN (In RGB Mode Only)	Customizes the PC display options in RGB mode.	
	Option	
	Resolution	Selects a proper resolution. See "Customizing PC display options".
	Auto Configure	Sets to adjust the screen position, clock, and phase automatically. The displayed image may be unstable for a few seconds while the configuration is in progress.
	Position/Size/Phase	Adjusts the options when the picture is not clear, especially when characters are shaky, after the auto configuration.
Reset	Restores the options to the default setting.	

Basic image options

Setting	Description
Backlight	Adjusts the brightness of the screen by controlling the LCD backlight. If you decrease the brightness level, the screen becomes darker and the power consumption will be reduced without any video signal loss.
Contrast	Increases or decreases the gradient of the video signal. You may use Contrast when the bright part of the picture is saturated.
Brightness	Adjusts the base level of the signal in the picture. You may use Brightness when the dark part of the picture is saturated.
Sharpness	Adjusts the level of crispness in the edges between the light and dark areas of the picture. The lower the level, the softer the image.
Color	Adjusts intensity of all colors.
Tint	Adjusts the balance between red and green levels.
Color Temp.	Set to warm to enhance hotter Colors such as red, or set to cool to make picture bluish.
Advanced Control	Customizes the advanced options. Refer to the Advanced image options. (See p.46).
Picture Reset	Restores the options to the default setting.
TruMotion	<p>Corrects images to display smoother motion sequences.</p> <ul style="list-style-type: none"> • Low : De-Judder / De-Blur value is set to 3. • High : De-Judder / De-Blur value is set to 7. • User : De-Judder / De-Blur can be set manually. <ul style="list-style-type: none"> - De-Judder : This function adjusts juddering of the screen. - De-Blur : This function adjusts and eliminates blurring of the screen.

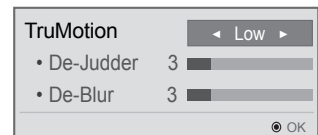

NOTE

- If the 'Picture Mode' setting in the Picture menu is set to **Vivid, Standard, Cinema, Sport** or **Game** the subsequent menus will be automatically set.
- You cannot adjust color and tint in the RGB-PC / HDMI-PC mode.
- When using the Smart Energy Saving function, the screen may look saturated in the white area of a still image.
- If Energy Saving is set to Minimum, Medium, or Maximum, the Smart Energy Saving function is disabled.

Advanced Control

Setting	Description
Dynamic Contrast (Off/High/Medium/Low)	Adjusts the contrast to keep it at the best level according to the brightness of the screen. The picture is improved by making bright parts brighter and dark parts darker. (This function can be used only under Component.)
Dynamic Color (Off/High/Low)	Adjusts screen Colors so that they look livelier, richer and clearer. This feature enhances hue, saturation and luminance so that red, blue, green and white look more vivid. (This function can be used only Component.)
Clear White (Off/High/Low)	Make the white area of screen brighter and more white.
Skin Color (-5 to 5)	It detects the skin area of video and adjusts it to express a natural skin color.
Noise Reduction (Off/High/Medium/Low)	Reduces screen noise without compromising video quality. (This function can be used only under Component.)
Digital Noise Reduction (Off/High/Medium/Low)	This option reduces the noise produced while creating digital video signals.
Gamma (High/Medium/Low)	Set your own gamma value. On the monitor, high gamma values display whitish images and low gamma values display high contrast images.
Black Level (High/Low)	<ul style="list-style-type: none"> ● Low: The picture of the screen gets darker. ● High: The picture of the screen gets brighter. Set black level of the screen to proper level. (Function works in the following mode - Component, HDMI-DTV)
Film Mode (On/Off)	This function provides the optimal picture quality for watching a movie.

AUDIO Settings

- 1 Press **MENU** to access the main menus.
- 2 Press the Navigation buttons to scroll to **AUDIO** and press **OK**.
- 3 Press the Navigation buttons to scroll to the setting or option you want and press **OK**.
- To return to the previous level, press **BACK**.
- 4 When you are finished, press **EXIT**.
When you return to the previous menu, press **BACK**.

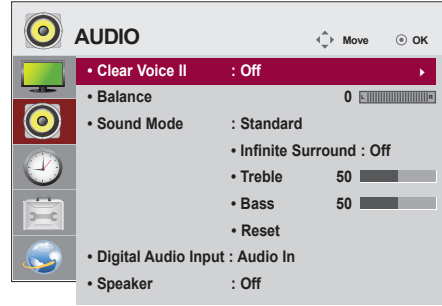

The available audio options are described in the following:

Setting	Description
Clear Voice II	By differentiating the human sound range from others, it helps users listen to human voices better.
Balance	Adjusts balance between the left and right speakers according to your room environment.
Sound Mode	The best sound tone quality will be selected automatically depending on the video type that you're currently watching.
Mode	
Standard	The most commanding and natural audio.
Music	Select this option to enjoy the original sound when listening to the music.
Cinema	Select this option to enjoy sublime sound.
Sport	Select this option to watch sports broadcasting.
Game	To enjoy dynamic sound when playing a game.
<div style="border: 1px solid black; padding: 10px; margin-top: 10px;"> <p>NOTE</p> <ul style="list-style-type: none"> • If sound quality or volume is not at the level you want, it is recommended to use a separate home theater system or amplifier to cope with different user environments. </div>	
Option	
Infinite Surround	LG's Infinite Surround option provides 5.1 channel stereo sound from two speakers.
Treble	Controls the dominant sounds in the output. When you turn up the treble, it will increase the output to the higher frequency range.
Bass	Makes the output sound softer. When you turn up the bass, it will increase the output to the lower Frequency.
Reset	Resets the sound mode to the default setting.
Digital Audio Input	HDMI/DisplayPort: Outputs the sound of digital signal from HDMI and display ports through the monitor speaker. Audio In: Outputs the sound through the monitor speaker by connecting HDMI and display ports to the Audio In port.
Speaker	ON: Enables sound to the monitor speaker. (* The monitor speaker is sold separately.) OFF: Disables sound to the monitor speaker. Use this option when using an external sound device.

TIME Settings

- 1 Press **MENU** to access the main menus.
- 2 Press the Navigation buttons to scroll to **TIME** and press **OK**.
- 3 Press the Navigation buttons to scroll to the setting or option you want and press **OK**.
 - To return to the previous level, press **BACK**.
- 4 When you are finished, press **EXIT**.
When you return to the previous menu, press **BACK**.

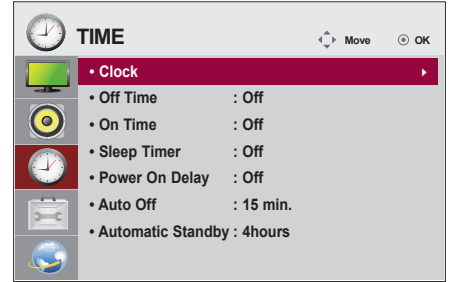

The available time settings are described in the following:

Setting	Description
Clock	Sets the time feature.
On/Off Time	Sets the time to turn on or off the Monitor set.
Sleep Timer	Sets the length of time until the Monitor set to turns off. When you turn the Monitor set off and turn it on again, the Sleep Timer will be set to off.
Power on delay	When connecting multiple monitors and turning the power on, the monitors are turned on individually to prevent overload.
Auto off	If Auto off is active and there is no input signal, the set switches to off mode automatically after 15 minutes.
Automatic Standby	If you do not use the monitor for more than 4 hours, it will be in standby mode automatically.

NOTE

- Once the on or off time is set, these functions operate daily at the preset time.
- The scheduled power-off function works properly only when the device time is set correctly.
- When the scheduled power-on and power-off times are the same, the power-off time has priority over the power-on time if the set is turned on, and vice versa if the set is turned off.

OPTION Settings

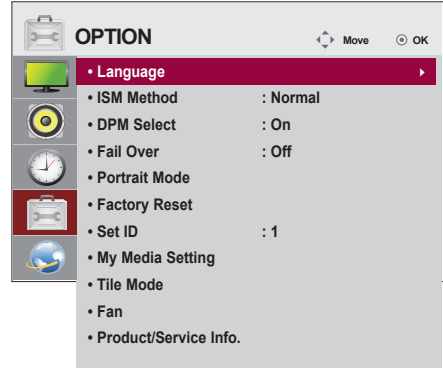

- 1 Press **MENU** to access the main menus.
- 2 Press the Navigation buttons to scroll to **OPTION** and press **OK**.
- 3 Press the Navigation buttons to scroll to the setting or option you want and press **OK**.
 - To return to the previous level, press **BACK**.
- 4 When you are finished, press **EXIT**.
When you return to the previous menu, press **BACK**.

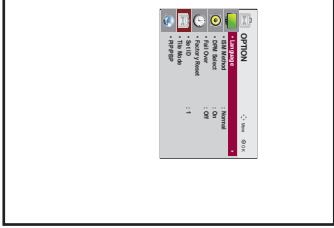
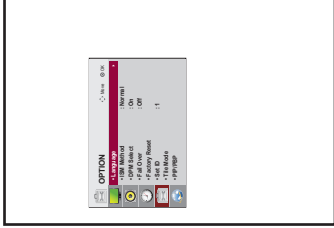

The available option settings are described in the following:

Setting	Description
Language	To choose the language in which the control names are displayed.
ISM Method	A frozen or still picture from a PC/Video game displayed on the screen for prolonged periods could result in a ghost image remaining even when you change the image. Avoid allowing a fixed image to remain on the screen for a long period of time.
	Setting
Normal	Leave on normal if you don't foresee image burn in being a problem.
Orbiter	May help prevent ghost images. However, it is best not to allow any fixed image to remain on the screen. To avoid a permanent image on the screen, the screen will move every 2 minutes.
Inversion	This function inverts the panel color of the screen. The panel color is automatically inverted every 30 minutes.
White Wash	White wash fills the screen with solid white. This helps removes permanent images burned into the screen. A permanent image may be impossible to clear entirely with white wash.
DPM Select	A user can choose to turn the power saving mode on / off.
Fail Over	If there is no input signal, it automatically switches to another input with signal.
	Setting
Off	Stops auto switch of the input source.
Auto	Switches to another input source with video signal if no video signal comes from the current input source.
Manual	Selects the priority of input source for auto switch. When several input sources are found, the input source with a higher priority will be selected.

Setting	Description	
Portrait mode	Rotate OSD clockwise (90°,270°)	
	Option	
	Off	Disables the Portrait mode.
	90°	Rotate OSD clockwise 90°.
	270°	Rotate OSD clockwise 270°.
	<div style="display: flex; justify-content: space-around; align-items: center;"> <div style="text-align: center;">  <p>90°</p> </div> <div style="text-align: center;">  <p>270°</p> </div> </div>	
Factory Reset	Select this option to return to the default factory settings.	
Set ID	You can assign a unique Set ID NO (name assignment) to each product when several products are connected for display. Specify the number (1 to 255) using the button and exit. Use the assigned Set ID to individually control each product using the Product Control Program.	
My Media Setting	<p>Activates or deactivates the DivX® VOD registration code. It also provides the product's DivX® VOD registration code and registration guide.</p> <div style="border: 1px solid black; padding: 10px; margin-top: 10px;"> <p>NOTE</p> <ul style="list-style-type: none"> • While you are checking the registration code, some buttons may not work. • If you use the DivX registration code of another device, you cannot play the rented or purchased DivX file. Make sure to use the DivX registration code assigned to your Monitor. • The video or audio files that are not converted by the standard DivX codec may be corrupted or not be played. • The DivX VOD code allows you to activate up to 6 devices under one account. • Once the deregistration is executed, you must register your device again to see DivX® VOD contents. </div>	

Setting	Description	
Tile Mode	Tile Mode	To use this function - Must be displayed with various other products. - Must be in a function that can be connected to RGB Cable by distributor and RS-232C. Tile mode and choose Tile alignment and set the ID of the current product to set location. * Only after pressing the SET button the adjustments made to the settings will be saved. - Tile mode : column x row (c = 1 to 15 r = 1 to 15) - 15 x 15 available. - Configuration of an integration screen is also available as well as configuration of One by one Display.
	<div style="border: 1px solid black; padding: 5px;">  NOTE <ul style="list-style-type: none"> • To use the Tile Mode when watching 3D images, select the 3D mode first and set the Tile Mode. </div>	
	Auto Config.	Sets to adjust the screen position, clock, and phase automatically. The displayed image may be unstable for a few seconds while the configuration is in progress.
	Position	Moving the screen position horizontally and vertically.
	Size	Adjust the horizontal and vertical size of the screen taking into account the size of the bezel.
	Natural	The image is omitted by the distance between the screens to be naturally shown.
	Reset	Function to initialize and release Tile. All Tile setting are released when selecting Tile recall and the screen returns to Full screen.
Fan	Setting	
	Mode	This option indicates the monitor's internal temperature and controls the fan. • Auto: Switches the fan on and off according to the set temperature. • On: The fan is always switched on. • Manual: Switches the fan on and off according to user settings.
	Hysteresis	The difference in temperature between when the fan is switched on and when it is off.
	Set Temperature	Set the temperature at which the fan is switched on.
	Current Temperature	Current temperature inside the set.
<div style="border: 1px solid black; padding: 5px;">  NOTE <ul style="list-style-type: none"> • We recommend that you use the Auto mode to prevent any malfunctions resulting from incorrect fan settings. • If the interior temperature of the set exceeds 80°C, the set will be turned off automatically for safety reasons. </div>		
Product/Service Info.	Displays the model name, software version, serial number, MAC address and home page.	

Tile Mode

This monitor can be tiled with additional monitors to create a large tiled display.

Off

When the Tile Mode option is disabled

1X2

When using 2 monitors

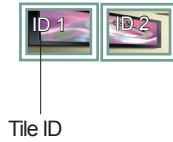

2X2

When using 4 monitors



3X3

When using 9 monitors



4X4

When using 16 monitors



5X5

When using 25 monitors



Tile Mode - Natural mode

When active, the part of the image that would normally be displayed in the gap between the monitors is omitted.

Before



After



Picture ID

Picture ID is used to change the settings of a specific display using a single IR receiver for multi-vision. The set receiving the IR signal communicates with another set via an RS232 connection. Each set is identified by a Set ID. If you assign the Picture ID using the remote control, only displays with the same Picture ID and Set ID can be controlled remotely.

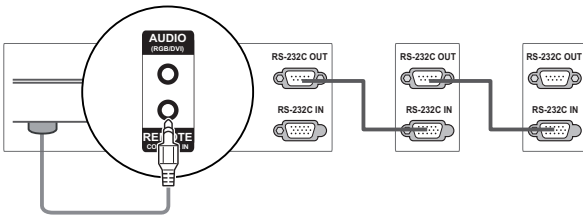

IR Receiver

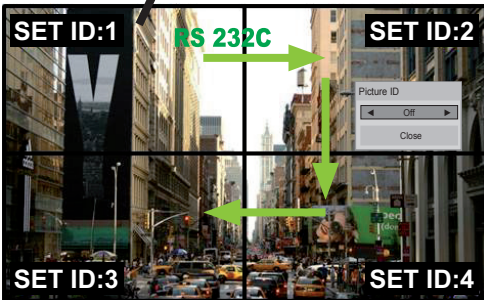

2X2 Multi-Vision (Total Set ID: 4)
Set IDs are assigned as shown in the picture.

- 1 Press the red ON button on the remote control to assign the Picture ID.

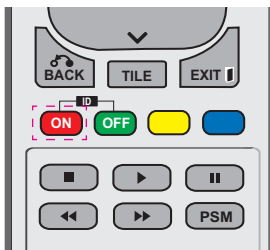

- 2 If you press the left/right buttons or press the ON button repeatedly, the Picture ID cycles through OFF and 1 to 4. Assign the ID you want.

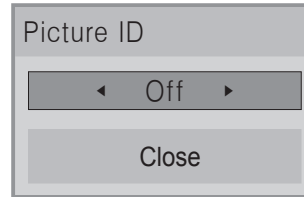

- If you assign the Set ID to each set with multi-vision, and then assign the Picture ID using the red button on the remote control, the key command is displayed for the set with the same Set ID and Picture ID. A set with different Set IDs and Picture IDs cannot be controlled by IR signals.
- For more information on how to assign the Set ID, see "Set ID" on page 49.
- The maximum value of the Picture ID can be set in the Total Set ID menu.
- Please refer to the Installation Manual for more information on Total Set ID assignment.

NOTE

- For example, if the Picture ID is assigned to 2, the upper right display (Set ID: 2) can be controlled by IR signals.
- For each set, you can change the settings for the PICTURE, AUDIO, TIME, NETWORK and MY MEDIA menus or the hot keys on the remote control.
- If you press the green OFF button for Picture IDs, the Picture IDs for all sets are turned off. If you then press any button on the remote control, all sets will start working again.
- Picture ID will be disabled while using the MY MEDIA menu.

NETWORK Settings

- 1 Press **MENU** to access the main menus.
- 2 Press the Navigation buttons to scroll to **NETWORK** and press **OK**.
- 3 Press the Navigation buttons to scroll to the setting or option you want and press **OK**.
 - To return to the previous level, press **BACK**.
- 4 When you are finished, press **EXIT**.
 - When you return to the previous menu, press **BACK**.

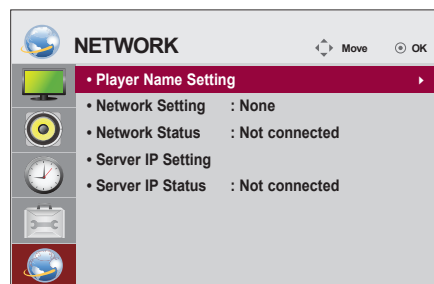

The available option settings are described in the following:

Setting	Description
Player Name Setting	Sets the player name used in SuperSign Manager.(Up to 20 characters)
Network Setting	Configure the network settings.
Network Status	Display the network status. - Internet is connected : Externally connected - Network is connected : Only internally connected - Not connected : When there is no network connection
Server IP Setting	Sets the IP address of the computer (server) on which SuperSign Manager is installed.
Server IP Status	Displays the connection status with the server. - Not connected : When there is no network connection with SuperSign server - Waiting for approval : When network connection with SuperSign server has been made, but access to server has not been approved by the server - Rejected : When network connection with SuperSign server has been made, but access to server has been rejected by the server - Internet is connected : When network connection with SuperSign server has been made and access to server has also been approved by the server



CAUTION

- When setting the Player Name, input delay may occur if you press the buttons on the remote control continuously.
- The Player Name Setting, Server IP Setting, Server IP Status settings may not be supported depending on the model.

MAKING CONNECTIONS

Connect various external devices to the ports on the Monitor set's back panel.

- 1 Find an external device you want to connect to your Monitor set shown on the following illustration.
- 2 Check the connection type of the external device.
- 3 Go to the appropriate illustration and check the connection details.

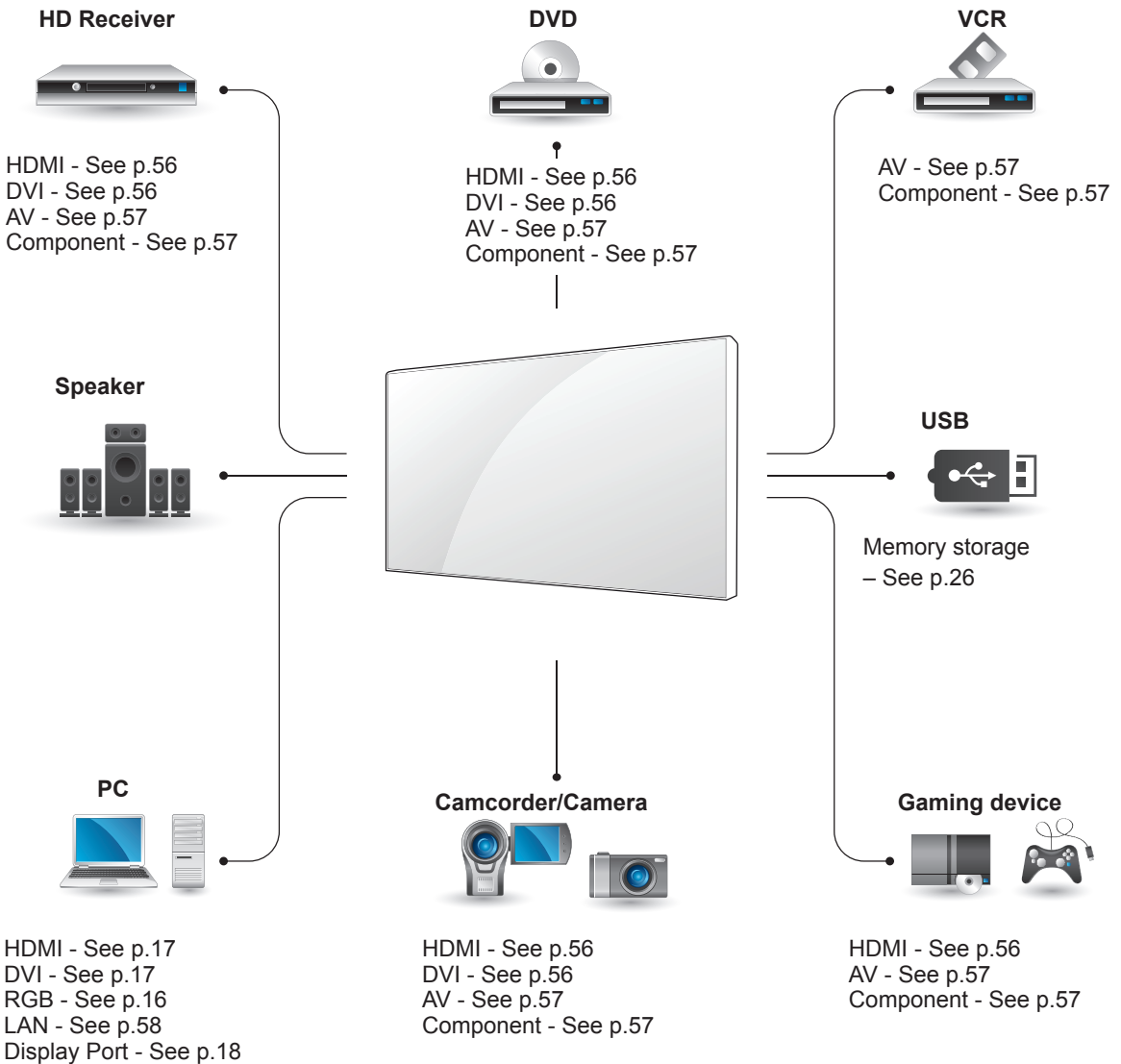

NOTE

- If you connect a gaming device to the Monitor set, use the cable supplied with the gaming device.

Connecting to a HD receiver, DVD, Camcorder, Camera, Gaming Device or VCR player

Connect a HD receiver, DVD, or VCR player to the Monitor set and select an appropriate input mode.

DVI Connection

Transmits the digital video signal from an external device to the Monitor set. Connect the external device and the Monitor set with the DVI cable as shown in the following illustration. To transmit an audio signal, connect an optional audio cable.

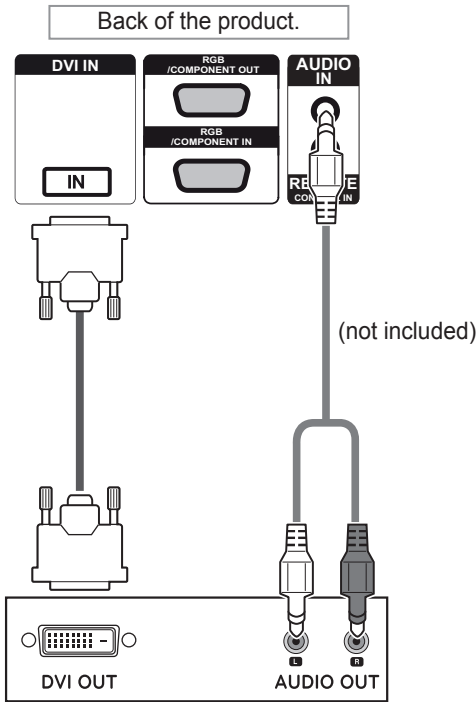

HDMI Connection

Transmits the digital video and audio signals from an external device to the Monitor set. Connect the external device and the Monitor set with the HDMI cable as shown on the following illustration.

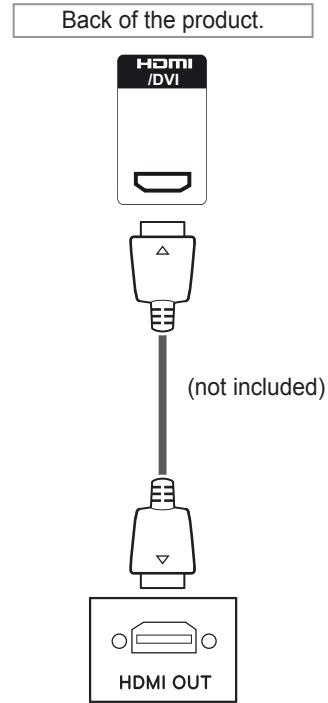

NOTE

- Use a High Speed HDMI™ Cable.
- High Speed HDMI™ Cables are tested to carry an HD signal up to 1080p and higher.

Component Connection

Transmits the analog video and audio signals from an external device to the Monitor set. Connect the external device and the Monitor set with the RGB-Component cable as shown in the following illustration.

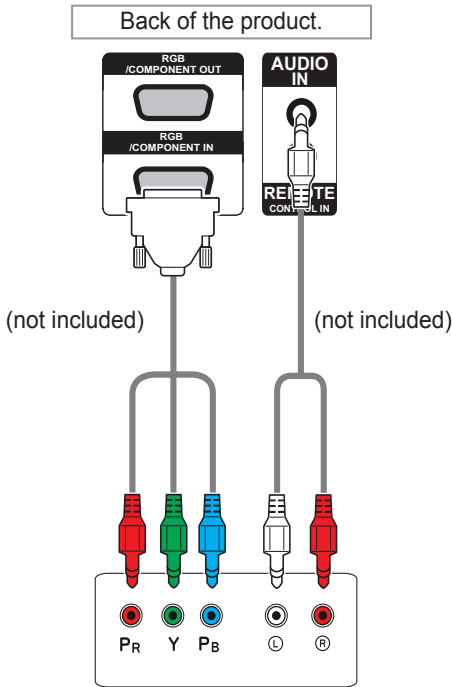

AV(CVBS) Connection

Transmits the analog video and audio signals from an external device to the Monitor set. Connect the external device and the Monitor set with the Composite cable as shown in the following illustration.

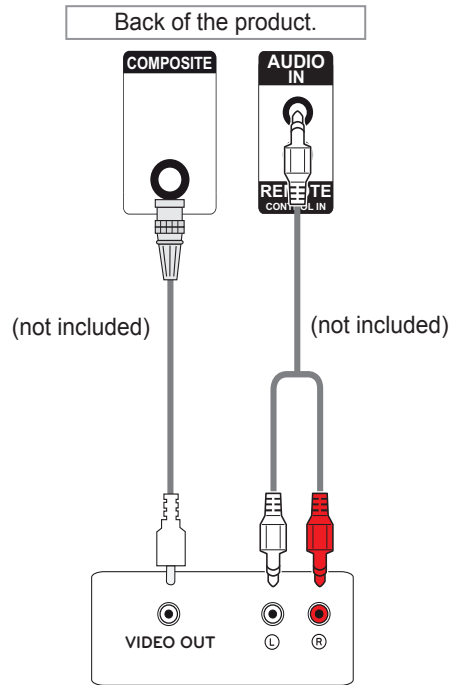

NOTE

- When connecting to the Component port using the shared interface, the port must match up to the input source. Otherwise, noise may occur.

NOTE

- If input signals are received through the AV cable, multiple monitors cannot be connected via the RGB OUT port.
- Input signal may be degraded or lost when multiple monitors are connected.
- For Component, in general, up to 3 monitors can be connected via the Component Out port (RGB Shared) if the signal is stable and there is no cable loss.
- If you want to connect more than this number of monitors, we recommended that you use a distributor.

Connecting to the LAN

LAN Connection

A Using a router(Switch)

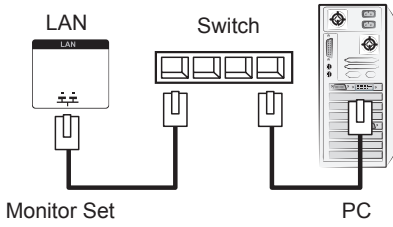

B Using the Internet.

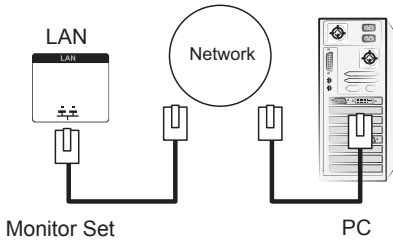

Connecting to a USB

Connect a USB storage device such as a USB flash memory, external hard drive, MP3 player or a USB memory card reader to the Monitor set and access the USB menu to use various multimedia files.

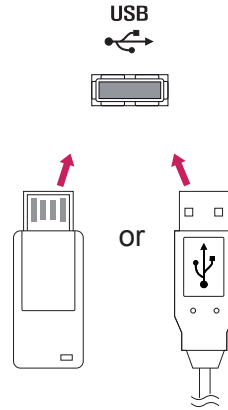

Daisy Chain Monitors

Use this function to share the RGB video signal with other monitors without having to use a separate signal splitter box.

- To use different products connected to each other Connect one end of the signal input cable (15-pin D-Sub Signal Cable) to the RGB OUT connector of product 1 and connect the other end to the RGB IN connector of other products.

RGB Cable

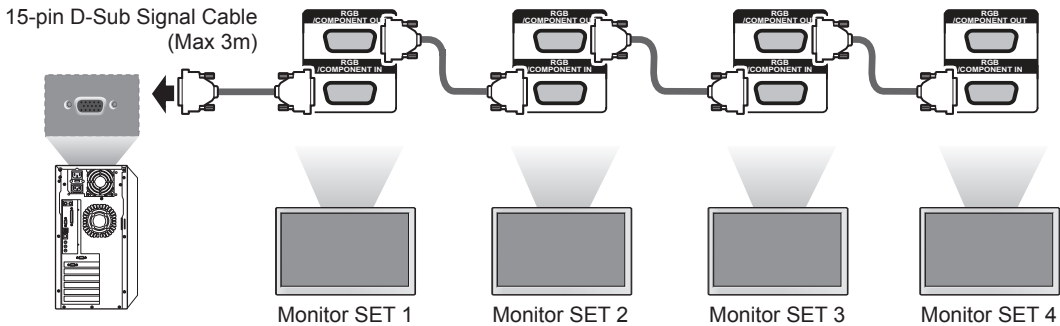

DVI Cable

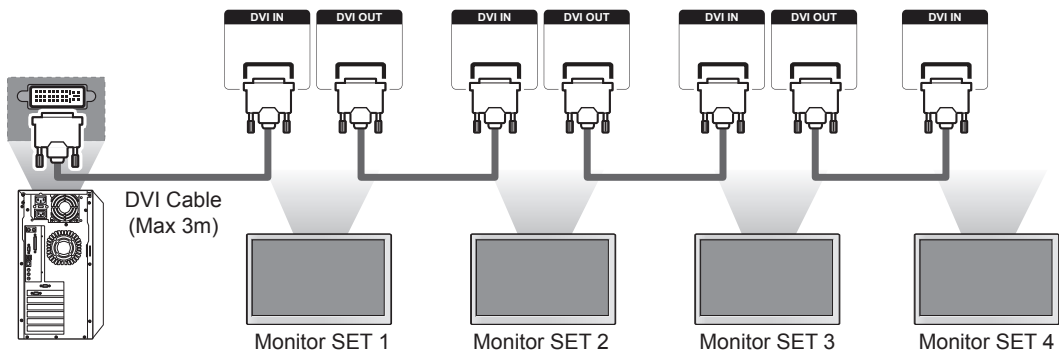

NOTE

- When multiple monitors are connected in RGB input, it is recommended to use a distributor to avoid signal degradation and cable loss.
- For DVI, in general, up to 12 monitors can be connected via the DVI Out port (at the recommended resolution) if the signal is stable and there is no cable loss. If you want to connect more than this number of monitors, we recommended that you use a distributor.
- When the tile mode is configured via DVI cables, only the monitor that receives first signals can play HDCP-encrypted content. (The DVI Out port does not support HDCP.)
- If the signal cable between the product and your PC is too long, make sure to use the DVI (RGB) booster or DVI (RGB) optical cable.
- If input signals are received through the HDMI/DP cable, multiple monitors cannot be connected via the DVI Out port.

TROUBLESHOOTING

No image is displayed

Problem	Resolution
TV does not power on.	<ul style="list-style-type: none"> • See if the power cord is properly connected to the outlet.
Power is on, but the screen appears extremely dark.	<ul style="list-style-type: none"> • Adjust brightness and contrast again. • Backlight may need repair.
Does the 'Invalid Format' message appear?	<ul style="list-style-type: none"> • The signal from the PC (video card) is out of the vertical or horizontal frequency range of the product. Adjust the frequency range by referring to the Specifications in this manual. <p>* Maximum resolution RGB : 1920 x 1080(60 Hz) HDMI/DVI/DP : 1920 x 1080(60 Hz)</p>
Does the 'No signal' message appear?	<ul style="list-style-type: none"> • The signal cable between PC and product is not connected. Check the signal cable. • Press the 'INPUT' menu in the remote Control to check the input signal.

'Unknown Product' message appears when the product is connected.

Problem	Resolution
Did you install the driver?	<ul style="list-style-type: none"> • See if the plug&play function is supported by referring to the video card user manual.

The screen image looks abnormal.

Problem	Resolution
Is the screen position wrong?	<ul style="list-style-type: none"> • D-Sub analog signal - Press the "AUTO" button in the remote control to automatically select the optimal screen status that fits into the current mode. If adjustment is not satisfactory, use the Position OSD menu. • See if the video card resolution and frequency are supported by the product. If the frequency is out of range, set to the recommended resolution in the Control Panel "Display" Setting menu.
Do thin lines appear on the background screen?	<ul style="list-style-type: none"> • D-Sub analog signal - Press the "AUTO" button in the remote control to automatically select an optimal screen status that fits into the current mode. If adjustment is not satisfactory, use the Clock OSD menu.
Horizontal noise appears or the characters look blurred.	<ul style="list-style-type: none"> • D-Sub analog signal - Press the "AUTO" button in the remote control to automatically select an optimal screen status that fits into the current mode. If adjustment is not satisfactory, use the Phase OSD menu.
The screen is displayed abnormally.	<ul style="list-style-type: none"> • The proper input signal is not connected to the signal port. Connect the signal cable that matches with the source input signal.

After-image appears on the product.

Problem	Resolution
After-image appears when the product is turned off.	<ul style="list-style-type: none"> • If you use a fixed image for a long time, the pixels may be damaged quickly. Use the screen-saver function.

The audio function does not work.

Problem	Resolution
No sound?	<ul style="list-style-type: none"> • See if the audio cable is connected properly. • Adjust the volume. • See if the sound is set properly.
Sound is too dull.	<ul style="list-style-type: none"> • Select the appropriate equalize sound.
Sound is too low.	<ul style="list-style-type: none"> • Adjust the volume.

Screen color is abnormal.

Problem	Resolution
Screen has poor color resolution (16 colors).	<ul style="list-style-type: none"> Set the number of colors to more than 24 bits (true color) Select Control Panel - Display - Settings - Color Table menu in Windows.
Screen color is unstable or mono-colored.	<ul style="list-style-type: none"> Check the connection status of the signal cable. Or, re-insert the PC video card.
Do black spots appear on the screen?	<ul style="list-style-type: none"> Several pixels (red, green, white or black color) may appear on the screen, which can be attributable to the unique characteristics of the LCD panel. It is not a malfunction of the LCD.

The operation does not work normally.

Problem	Resolution
The power suddenly turned off.	<ul style="list-style-type: none"> Is the sleep timer set? Check the power control settings. Power interrupted.

TROUBLESHOOTING WHEN USING 3D MODE

I can see a swirling oil-like pattern on the screen when the monitor is turned off.

I can see a swirling oil-like pattern on the Monitor when the Monitor is turned off.

This is caused by the interference of external light in the air layer between the LCD surface and 3D filter. The pattern becomes almost invisible when you turn on the power again.

I cannot see 3D image properly

Problem	Resolution
If you are not using the glasses provided with the Monitor.	<ul style="list-style-type: none"> When you view 3D images with this Monitor, it is very important that you use the glasses provided with the Monitor. The glasses are designed to compensate optically for the 3D filter attached to the surface of the Monitor. If you wear third-party glasses, you may not see 3D images properly on the Monitor.
If you view 3D images outside the optimal viewing angle or distance.	<ul style="list-style-type: none"> The optimal vertical viewing angle for this product is 30° and the optimal horizontal angle 178°. The optimal viewing distance for 3D is 128 cm from the monitor (for a single set). When you view 3D images outside the optimal viewing angle or viewing distance, the images may look overlapped or not be displayed properly in 3D.

I cannot see 3D but only 2D images.

Action

This Monitor supports both 2D and 3D modes. You can view a video in 3D if it is made in 3D. If you try to view 2D images in 3D, they might not be displayed properly or you may experience poor picture quality.

SPECIFICATIONS

LCD Panel	Screen Type	55" class (54.6" diagonal) TFT (Thin Film Transistor) LCD (Liquid Crystal Display) Panel. Visible diagonal size : 1387.80 mm
	Pixel Pitch	0.210 mm (H) x 0.630 mm (V)
Video Signal	Max. Resolution	RGB : 1920 x 1080 @ 60 Hz HDMI/DVI/DP : 1920 x 1080 @ 60 Hz - It may not be supported depending on the OS or video card type.
	Recommended Resolution	RGB : 1920 x 1080 @ 60 Hz HDMI/DVI/DP : 1920 x 1080 @ 60 Hz - It may not be supported depending on the OS or video card type.
	Horizontal Frequency	RGB : 30 kHz to 68 kHz HDMI/DVI/DP : 30kHz to 68 kHz
	Vertical Frequency	RGB : 56 Hz to 75 Hz HDMI/DVI/DP : 56 Hz to 60 Hz
	Synchronization Type	Separate Sync, Composite(AV) Sync, Digital, SOG
Input Connector		15-pin D-Sub type (RGB / Component), HDMI/DVI/DP(digital), Composite(AV), RS-232C, LAN, USB
Power	Rated Voltage	AC 100-240 V~, 50 / 60 Hz 3.3 A
	Power Consumption	On Mode : 240 W Typ. Smart Energy Saving Mode : 150 W Typ. Off Mode : ≤ 0.5 W
Dimensions (Width x Height x Depth) / Weight		* Wall Bracket available VESA 600 x 400
	1215.2 mm X 686 mm X 99 mm / 33.4 Kg	
Environmental conditions	Operating Temperature	0 °C to 40 °C
	Operating Humidity	10 % to 80 %
	Storage Temperature	-20 °C to 60 °C
	Storage Humidity	5 % to 95 %

* Applicable only for models that support the speakers

Audio	RMS Audio Output	10 W + 10 W (R + L)
	Input Sensitivity	0.7 Vrms
	Speaker Impedance	8 Ω

Product specifications shown above may be changed without prior notice due to upgrade of product functions.

RGB (PC) supported mode

Resolution	Horizontal Frequency(kHz)	Vertical Frequency(Hz)
640 x 480	31.469	59.94
1024 x 768	48.363	60
1280 x 720	44.772	59.855
1366 x 768	47.7	60
1680 x 1050	65.290	59.954
1920 x 1080	67.5	60

HDMI/DVI/Display Port(PC) supported mode

Resolution	Horizontal Frequency(kHz)	Vertical Frequency(Hz)
640 x 480	31.469	59.94
800 x 600	37.879	60.317
1024 x 768	48.363	60
1280 x 720	44.772	59.855
1280 x 768	47.7	60
1366 x 768	47.7	60
1280 x 1024	63.981	60.02
1680 x 1050	65.290	59.954
1920 x 1080	67.5	60

DTV Mode

Resolution	Component	HDMI/DVI (DTV)
480i	o	x
576i	o	x
480p	o	o
576p	o	o
720p	o	o
1080i	o	o
1080p	o	o

! NOTE

- PC resolutions available as the input label option in RGB and HDMI/DVI input mode : 640 x 480 / 60 Hz, 1280 x 720 / 60 Hz, 1920 x 1080 / 60 Hz and DTV resolutions : 480p, 720p, 1080p.

! NOTE

- Vertical frequency: To enable the user to watch the product display, screen image should be changed tens of times every second like a fluorescent lamp. The vertical frequency or refresh rate is the times of image display per second. The unit is Hz.
- Horizontal frequency: The horizontal interval is the time to display one vertical line. When 1 is divided by the horizontal interval, the number of horizontal lines displayed every second can be tabulated as the horizontal frequency. The unit is kHz.

CONTROLLING THE MULTIPLE MONITORS

- Use this method to connect several products to a single PC. You can control several monitors at one time by connecting them to a single PC.
- In the Option menu, Set ID must be between 1 and 255 without being duplicated.

Connecting the Cable

Connect the RS-232C cable as shown in the picture.

- The RS-232C protocol is used for communication between the PC and product. You can turn the product on/off, select an input source or adjust the OSD menu from your PC.

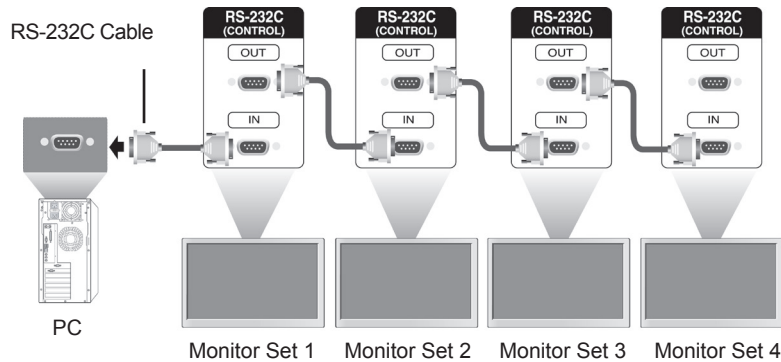

RS-232C Configurations

8-Wire Configurations (Cross-over RS-232C cable)

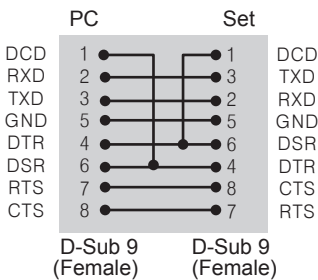

NOTE

- When using 3-wire connections (non-standard), an IR daisy chain cannot be used.

Communication Parameter

- Baud Rate : 9600 buad Rate (UART)
- Data Length : 8 bit
- Parity Bit : None
- Stop Bit : 1bit
- Flow Control : None
- Communication Code : ASCII code
- Use a crossed (reverse) cable

Command Reference List

		COMMAND		DATA (Hexadecimal)
		1	2	
01	Power	k	a	00H to 01H
02	Input Select	x	b	Refer to '02. Input Select'
03	Aspect Ratio	k	c	Refer to '03. Aspect Ratio'
04	Energy Saving	j	q	Refer to '04. Energy Saving'
05	Picture Mode	d	x	Refer to '05. Picture Mode'
06	Contrast	k	g	00H to 64H
07	Brightness	k	h	00H to 64H
08	Sharpness	k	k	00H to 64H
09	Color	k	i	00H to 64H
10	Tint	k	j	00H to 64H
11	Color Temperature	x	u	00H to 64H
12	H Position	f	q	00H to 64H
13	V Position	f	r	00H to 64H
14	H Size	f	s	00H to 64H
15	Auto Configuration	j	u	01H
16	Balance	k	t	00H to 64H
17	Sound Mode	d	y	Refer to '17. Sound Mode'
18	Treble	k	r	00H to 64H
19	Bass	k	s	00H to 64H
20	Speaker	d	v	00H to 01H
21	Volume Mute	k	e	00H to 01H
22	Volume Control	k	f	00H to 64H
23	Time 1(Years/ Months/ Days)	f	a	Refer to '23. Time 1'
24	Time 2(Hours/ Minutes/ Seconds)	f	x	Refer to '24. Time 2'
25	Off Timer(Repeat mode/ Time)	f	e	Refer to '25. Off Timer'
26	On Timer(Repeat Mode/ Time)	f	d	Refer to '26. On Timer'
27	On Timer Input	f	u	Refer to '27. On Timer Input'
28	Sleep Time	f	f	00H to 08H
29	Power On Delay	f	h	00H to 64H
30	Automatic Standby	m	n	00H to 01H
31	Auto Off	f	g	00H to 01H
32	Language	f	i	00H to 0AH
33	ISM Method	j	p	Refer to '33. ISM Method'
34	DPM Select	f	j	00H to 01H
35	Fail Over Select	m	i	00H to 02H
36	Fail Over Input Select	m	j	Refer '36. Fail Over Input Select'
37	Reset	f	k	00H to 03H
38	Tile mode	d	d	00H to 01H
39	Tile Mode Check	d	z	FFH
40	Tile ID	d	i	Refer to '40. Tile ID'

		COMMAND		DATA (Hexadecimal)
		1	2	
41	Tile H Position	d	e	00H to 32H
42	Tile V Position	d	f	00H to 32H
43	Tile H Size	d	g	00H to 32H
44	Tile V Size	d	h	00H to 32H
45	Natural Mode (in Tile Mode)	d	j	00H to 01H
46	FAN Control	d	o	00H to 02H
47	FAN Fault check	d	w	FFH
48	Temperature Value	d	n	FFH
49	Key	m	c	Refer to '49. Key'
50	OSD Select	k	l	00H to 01H
51	Elapsed Time Return	d	l	FFH
52	Serial No. Check	f	y	FFH
53	S/W Version	f	z	FFH
54	White Balance Red Gain	j	m	00H to FEH
55	White Balance Green Gain	j	n	00H to FEH
56	White Balance Blue Gain	j	o	00H to FEH
57	3D Mode	x	t	Refer to '57. 3D Mode'
58	3D Mode Option Setting	x	v	Refer to '58. 3D Mode Option Setting'
59	Screen Mute	k	d	00H to 01H

- Note : During USB operations such as Dvix or EMF, all commands except Power(ka) and Key(mc) Volume Mute(k e), Volume Control(k f) are not executed and treated as NG.

Transmission / Receiving Protocol

Transmission

[Command1][Command2][][Set ID][][Data][Cr] or
[Command1][Command2][][Set ID][][Data1][][Data2][][Data3][Cr]

- * [Command1]: First command to control the set.
- * [Command2]: Second command to control the set.
- * [Set ID]: Set ID with which you want to communicate. Etner [Set ID] = '00(0x00' to communicate with all sets regardless of their Set ID numbers.
- * [Data]: Information passed to the set.
- * [Data1]: Information passed to the set.
- * [Data2]: Information passed to the set.
- * [Data3]: Information passed to the set.
- * [Cr]: Carriage Return. ASCII code '0x0D'.
- * []: ASCII code space '0x20'
- * If Data is FF, OSD will not be marked on the Set.
(It may cause the interface factor during SuperSign Elite-w server communication)

Acknowledgement

[Command2][][Set ID][][OK/NG][Data][x] or
[Command2][][Set ID][][OK/NG][Data1][Data2][Data3][x]

- * In a like manner, if other functions transmit 'FF' data based on this format, Acknowledgement data feedback presents status about each function.
- * Note : In this mode, display will send the acknowledgement after power on processing completion.
There might be a time delay between command and acknowledgement.
- * No acknowledgement signal will be sent from display, if Set ID in transmission signal is set to '00'(=0x00).
- * If 3D mode is on, it will work only the below commands.

	COMMAND	
	1	2
Power	k	a
Input Select	x	b
Volume Mute	k	e
Volume Control	k	f
Fail Over Select	m	i
White Balance Red Gain	j	m
White Balance Green Gain	j	n
White Balance Blue Gain	j	o
3D Mode	x	t
3D Mode Option Setting	x	v

01. Power (Command: k a)

To control power On/Off the display.

Transmission

[k][a][][Set ID][][Data][Cr]

Data 00 : Power Off

01 : Power On

FF: Power Status

Acknowledgement

[a][][Set ID][][OK/NG][Data][x]

* In a like manner, if other functions transmit 'FF' data based on this format, Acknowledgement data feedback presents status about each function.

* Note: In this mode, display will send the acknowledgement after power on processing completion. There might be a time delay between command and acknowledgement.

* Refer to 'Real data mapping' for hexadecimal data to decimal data.

02. Input Select (Command: x b)

To select input source for display.

Transmission

[x][b][][Set ID][][Data][Cr]

Data 20: AV

40: Component

60: RGB-PC

70: DVI-D(PC)

80: DVI-D(DTV)

90: HDMI(DTV)

A0: HDMI(PC)

C0: Display Port(PC)

D0: Display Port(DTV)

Acknowledgement

[b][][Set ID][][OK/NG][Data][x]

* Use this feature depending on your model

03. Aspect Ratio (Command: k c)

To adjust the screen format.

Transmission

[k][c][][Set ID][][Data][Cr]

Data 01: 4:3

02: 16:9

04: Zoom

(AV,Component,HDMI/Display Port DTV)

09: Just Scan(720p or higher)

/1:1(RGB-PC, DVI-D, HDMI/Display Port PC)

10 to 1F: Cinema Zoom 1~16

(AV, Component,HDMI/Display Port DTV)

Acknowledgement

[c][][Set ID][][OK/NG][Data][x]

04. Energy Saving (Command: j q)

To control the energy saving function.

Transmission

[j][q][][Set ID][][Data][Cr]

Data 00: Off

01: Minimum

02: Medium

03: Maximum

05: Screen Off

Acknowledgement

[q][][Set ID][][OK/NG][Data][x]

05. Picture Mode (Command: d x)

To select the picture mode.

Transmission

[d][x][][Set ID][][Data][Cr]

Data 00: Vivid

01: Standard

02: Cinema

03: Sport

04: Game

Acknowledgement

[x][][Set ID][][OK/NG][Data][x]

06. Contrast (Command: k g)

To adjust screen contrast.

Transmission

[k][g][][Set ID][][Data][Cr]

Data 00 to 64: Contrast 0 to 100

Acknowledgement

[g][][Set ID][][OK/NG][Data][x]

07. Brightness (Command: k h)

To adjust screen brightness.

Transmission

[k][h][][Set ID][][Data][Cr]

Data 00 to 64: Brightness 0 to 100

Acknowledgement

[h][][Set ID][][OK/NG][Data][x]

10. Tint (Command: k j)

To adjust screen tint.

* Only available for AV/Component input.

Transmission

[k][j][][Set ID][][Data][Cr]

Data 00~64: Tint R50 ~ G50

Acknowledgement

[j][][Set ID][][OK/NG][Data][x]

08. Sharpness (Command: k k)

To adjust screen sharpness.

* Only available for AV/Component input.

Transmission

[k][k][][Set ID][][Data][Cr]

Data 00 to 64: Sharpness 0 to 100

Acknowledgement

[k][][Set ID][][OK/NG][Data][x]

11. Color Temperature (Command: x u)

To adjust color temperature.

Transmission

[x][u][][Set ID][][Data][Cr]

Data 00 to 64: Warm 50 to Cool 50

Acknowledgement

[u][][Set ID][][OK/NG][Data][x]

09. Color (Command: k i)

To adjust screen color.

* Only available for AV/Component input.

Transmission

[k][i][][Set ID][][Data][Cr]

Data 00 to 64: Color 0 to 100

Acknowledgement

[i][][Set ID][][OK/NG][Data][x]

12. H Position (Command: f q)

To set the Horizontal position.

* Only available for Tile Off mode.

Transmission

[f][q][][Set ID][][Data][Cr]

Data 00~64: Min. -50 (Left) ~ Max. 50(Right)

Acknowledgement

[q][][Set ID][][OK/NG][Data][x]

13. V Position (Command: f r)

To set the Vertical position.

* Only available for Tile Off mode.

* This function only works when the Tile Mode is disabled in RGB-PC input.

* Data range varies depending on the resolution.

Transmission

[f][r][][Set ID][][Data][Cr]

Data 00~64: Min. -50 (Bottom) ~ Max. 50(Top)

Acknowledgement

[r][][Set ID][][OK/NG][Data][x]

14. H Size (Command: f s)

To set the Horizontal size.

* Only available for Tile Off mode.

* This function only works when the Tile Mode is disabled in RGB-PC input.

Transmission

[f][s][][Set ID][][Data][Cr]

Data 00~64: Size -50 (Scale down) ~ +50(Scale up)

Acknowledgement

[s][][Set ID][][OK/NG][Data][x]

15. Auto Configuration (Command: j u)

To adjust picture position and minimize image shaking automatically.

* Only available for RGB input.

Transmission

[j][u][][Set ID][][Data][Cr]

Data 01 : Set

Acknowledgement

[u][][Set ID][][OK/NG][Data][x]

16. Balance (Command: k t)

To adjust balance.

Transmission

[k][t][][Set ID][][Data][Cr]

Data 00 to 64: Left 50 to Right 50

Acknowledgement

[t][][Set ID][][OK/NG][Data][x]

17. Sound Mode (Command: d y)

To select the sound mode.

Transmission

[d][y][][Set ID][][Data][Cr]

Data 01: Standard

02: Music

03: Cinema

04: Sport

05: Game

Acknowledgement

[y][][Set ID][][OK/NG][Data][x]

18. Treble (Command: k r)

To adjust treble.

Transmission

[k][r][][Set ID][][Data][Cr]

Data 00 to 64: Treble 0 to 100

Acknowledgement

[r][][Set ID][][OK/NG][Data][x]

19. Bass (Command: k s)

To adjust bass.

Transmission**[k][s][][Set ID][][Data][Cr]**

Data 00 to 64: Bass 0 to 100

Acknowledgement**[s][][Set ID][][OK/NG][Data][x]****22. Volume Control (Command: k f)**

To adjust volume.

Transmission**[k][f][][Set ID][][Data][Cr]**

Data 00 to 64: Volume 0 to 100

Acknowledgement**[f][][Set ID][][OK/NG][Data][x]****20. Speaker (Command: d v)**

To select speaker on/off.

Transmission**[d][v][][Set ID][][Data][Cr]**

Data 00: Speaker Off

01: Speaker On

Acknowledgement**[v][][Set ID][][OK/NG][Data][x]****23. Time 1 (Year/ Month/ Day) (Command: f a)**

To set the Time 1 (Year/ Month/ Day) values.

Transmission**[f][a][][Set ID][][Data1][][Data2][][Data3][Cr]**

Data 1 00 to 14: 2010 to 2030

Data 2 01 to 0C: January to December

Data 3 01 to 1F: 1 to 31

* Enter "fa [Set ID] ff" for checking Time 1 values.

Acknowledgement**[a][][Set ID][][OK/NG][Data1][Data2][Data3][x]****21. Volume Mute (Command: k e)**

To select screen mute on/off.

Transmission**[k][e][][Set ID][][Data][Cr]**

Data 00 : Volume Mute On (Volume Off)

01 : Volume Mute Off (Volume On)

Acknowledgement**[e][][Set ID][][OK/NG][Data][x]****24. Time 2 (Hour/ Minute/ Second) (Command: f x)**

To set the Time 2 (Hour/ Minute/ Second) values.

Transmission**[f][x][][Set ID][][Data1][][Data2][][Data3][Cr]**

Data1 00 to 17: 00 to 23 hours

Data2 00 to 3B: 00 to 59 minutes

Data3 00 to 3B: 00 to 59 seconds

* Enter "fx [Set ID] ff" for checking Time 2 values.

** This command won't work if Time 1 has not been set in advance.

Acknowledgement**[x][][Set ID][][OK/NG][Data1][Data2][Data3][x]**

25. Off Timer(Repeat Mode/ Time) (Command: f e)

To set the Off Timer(Repeat mode/ Time) function.

Transmission`[f][e][][Set ID][][Data1][][Data2][][Data3][Cr]`

Data1 00: Repeat Off
 01: Repeat Once
 02: Repeat Daily
 03: Repeat from Monday to Friday
 04: Repeat from Monday to Saturday
 05: Repeat from Saturday to Sunday
 06: Repeat on Sunday
 07: Repeat on Monday
 08: Repeat on Tuesday
 09: Repeat on Wednesday
 0A: Repeat on Thursday
 0B: Repeat on Friday
 0C: Repeat on Saturday

Data2 00 to 17: 00 to 23 Hours

Data3 00 to 3B: 00 to 59 Minutes

* Enter "fe [Set ID] ff" for checking Off Timer(Repeat mode/ Time) values.

* Check if Time1 and Time2 have been set before setting this function.

Acknowledgement`[e][][Set ID][][OK/NG][Data1][Data2][Data3][x]`**► To check current Off Timer(Repeat Mode/ Time) function.****Transmission**`[f][e][][Set ID][][Data][][f][f][][f][f][Cr]`

Data f1~f7: 1st~7th element of schedule list

Acknowledgement`[e][][Set ID][][OK/NG][Data1][Data2][Data3][Data4][x]`

Data1 f1~f7: 1st~7th index of schedule list

Data2 00: Repeat Off
 01: Repeat Once
 02: Repeat Daily
 03: Repeat from Monday to Friday
 04: Repeat from Monday to Saturday
 05: Repeat from Saturday to Sunday
 06: Repeat on Sunday
 07: Repeat on Monday
 08: Repeat on Tuesday
 09: Repeat on Wednesday
 0A: Repeat on Thursday
 0B: Repeat on Friday
 0C: Repeat on Saturday

Data3 00~17: 00 ~ 23 Hours

Data4 00~3B: 00 ~ 59 Minutes

26. On Timer(Repeat Mode/ Time) (Command: f d)

To set the On Timer(Repeat mode/ Time) function.

Transmission`[f][d][][Set ID][][Data1][][Data2][][Data3][Cr]`

Data1 00: Repeat Off
 01: Repeat Once
 02: Repeat Daily
 03: Repeat from Monday to Friday
 04: Repeat from Monday to Saturday
 05: Repeat from Saturday to Sunday
 06: Repeat on Sunday
 07: Repeat on Monday
 08: Repeat on Tuesday
 09: Repeat on Wednesday
 0A: Repeat on Thursday
 0B: Repeat on Friday
 0C: Repeat on Saturday

Data2 00 to 17: 00 to 23 Hours

Data3 00 to 3B: 00 to 59 Minutes

* Enter "fd [Set ID] ff" for checking On Timer(Repeat mode/ Time) values.

* Check if Time1 and Time2 have been set before setting this function.

* On Timer Input command should be executed followed just after executing this command to set On Timer schedule properly.

Acknowledgement`[d][][Set ID][][OK/NG][Data1][Data2][Data3][x]`**► To check current On Timer(Repeat Mode/ Time) function.****Transmission**`[f][d][][Set ID][][Data][][f][f][][f][f][Cr]`

Data f1~f7: 1st~7th element of schedule list

Acknowledgement`[d][][Set ID][][OK/NG][Data1][Data2][Data3][Data4][x]`

Data1 f1~f7: 1st~7th index of schedule list

Data2 00: Repeat Off
 01: Repeat Once
 02: Repeat Daily
 03: Repeat from Monday to Friday
 04: Repeat from Monday to Saturday
 05: Repeat from Saturday to Sunday
 06: Repeat on Sunday
 07: Repeat on Monday
 08: Repeat on Tuesday
 09: Repeat on Wednesday
 0A: Repeat on Thursday
 0B: Repeat on Friday
 0C: Repeat on Saturday

Data3 00~17: 00 ~ 23 Hours

Data4 00~3B: 00 ~ 59 Minutes

27. On Timer Input (Command: f u)

To set the On Timer Input function.

Transmission

[f][u][][Set ID][][Data][Cr]

Data 20: AV
40: Component
60: RGB-PC
70: DVI-D
90: HDMI
C0: DISPLAY PORT

* Check if Time1, Time2, and On Timer(Repeat Mode/ Time) functions have been set before setting this function.

* On Timer(Repeat Mode/ Time) command should be executed in advance this command to set On Timer schedule properly.

Acknowledgement

[u][][Set ID][][OK/NG][Data][x]

► To check current On Timer Input function.**Transmission**

[f][u][][Set ID][][Data][][f][f][Cr]

Data f1~f7: 1st~ 7th element of schedule list

Acknowledgement

[u][][Set ID][][OK/NG][Data1][Data2][x]

Data1 f1~f7: 1st~ 7th index of schedule list

Data2 20: AV
40: Component
60: RGB-PC
70: DVI-D
90: HDMI
C0: Display Port

28. Sleep Time (Command: f f)

To set sleep time.

Transmission

[f][f][][Set ID][][Data][Cr]

Data 00: Off
01: 10 min.
02: 20 min.
03: 30 min.
04: 60 min.
05: 90 min.
06: 120 min.
07: 180 min.
08: 240 min.

Acknowledgement

[f][][Set ID][][OK/NG][Data][x]

29. Power On Delay (Command: f h)

To set the schedule delay when the power is turned on(unit: second).

Transmission

[f][h][][Set ID][][Data][Cr]

Data 00 : Off
01~64: Min. 1.~ Max. 100 (sec.)

Acknowledgement

[h][][Set ID][][OK/NG][Data][x]

30. Automatic Standby (Command: m n)

To set the Automatic Standby function.

Transmission

[m][n][][Set ID][][Data][Cr]

Data 00: Off(Auto off function doesn't work.)

01: 4 Hours

(Display will be turned off in 4 hours)

Acknowledgement

[n][][Set ID][][OK/NG][Data][x]

31. Auto Off (Command: f g)

To set the Auto Off function.

Transmission

[f][g][][Set ID][][Data][Cr]

Data 00: Off (Auto off function doesn't work.)

01: 15 min.

(Display will be turned off in case of no signal for 15 minutes.)

Acknowledgement

[g][][Set ID][][OK/NG][Data][x]

32. Language (Command: f i)

To set language for OSD.

Transmission

[f][i][][Set ID][][Data][Cr]

Data 00: Czech

01: Danish

02: German

03: English

04: Spanish(EU)

05: Greek

06: French

07: Italian

08: Dutch

09: Norwegian

0A: Portuguese

0B: Portuguese(BR)

0C: Russian

0D: Finnish

0E: Swedish

0F: Korean

10: Chinese (Mandarin)

11: Japanese

12: Yue Chinese(Cantonese)

Acknowledgement

[i][][Set ID][][OK/NG][Data][x]

33. ISM mode (Command: j p)

To select ISM method for avoiding having a fixed image remain on screen.

Transmission

[j][p][][Set ID][][Data][Cr]

Data 01: Inversion

02: Orbiter

04: White Wash

08: Normal

Acknowledgement

[p][][Set ID][][OK/NG][Data][x]

34. DPM Select (Command: f j)

To set the DPM (Display Power Management) function.

Transmission

[f][j][][Set ID][][Data][Cr]

Data 00: DPM Off

01: DPM On

Acknowledgement

[j][][Set ID][][OK/NG][Data][x]

35. Fail Over Select (Command: m i)

To set the Fail Over function.

Transmission

[m][i][][Set ID][][Data][Cr]

Data 00: Off

01: Auto

02: Manual

Acknowledgement

[i][][Set ID][][OK/NG][Data][x]

36. Fail Over Input Select (Command: m j)

To select fail over mode.

*Only available in Fail Over manual mode.

Transmission

[m][j][][Set ID][][Data1][][Data2][][Data3][][Data4][Cr]

Data 01 to 04(Input priority: 1 to 4)

60: RGB-PC

70: DVI-D*

90: HDMI**

C0: Display Port***

* Use 0x70 as data for DVI-D input, regardless DVI-D(PC) or DVI-D(DTV).

** Use 0x90 as data for HDMI input, regardless HDMI-DTV or HDMI-PC

*** Use 0xC0 as data for Display Port input, regardless Display Port(DTV) or Display Port(PC)

Acknowledgement

[j][][Set ID][][OK/NG][Data1][Data2][Data3][Data4][x]

Data1~4(Priority 1~4)

60: RGB-PC

70: DVI-D****

90: HDMI*****

C0: Display Port*****

**** Returns 0x70 as Data for DVI-D port, regardless DVI-D(PC) or DVI-D(DTV).

***** Returns 0x90 as Data for HDMI port, regardless HDMI-DTV or HDMI-PC.

***** Returns 0xC0 as Data for Display Port, regardless Display Port(DTV) or Display Port(PC).

37. Reset (Command: f k)

To execute the Picture, Screen, Audio and Factory reset function.

* Screen reset function is only available for RGB-PC input.

Transmission

[f][k][][Set ID][][Data][Cr]

Data 00: Picture Reset

01: Screen Reset

02: Audio Reset

03: Factory Reset

Acknowledgement

[k][][Set ID][][OK/NG][Data][x]

38. Tile Mode (Command: d d)

To select a Tile Mode Off/ On and Tile Row/ Column size.

* NOT available when 3D mode ON.

Transmission

[d][d][][Set ID][][Data][Cr]

Data 00 to FF: 1st byte - Tile Column value
2nd byte - Tile Row value

*00, 01, 10, 11 means Tile Mode Off.

Acknowledgement

[d][][Set ID][][OK/NG][Data][x]

Data	Description
00, 01, 10, 11	It means Tile mode Off.
12	2 x 1 (Row x Column)
13	3 x 1
14	4 x 1
...	...
FF	15 x 15

39. Tile Mode Check (Command: d z)

To check Tile Mode status.

Transmission

[d][z][][Set ID][][Data][Cr]

Data FF: Check Tile Mode status

Acknowledgement

[z][][Set ID][][OK/NG][Data1][Data2][Data3][x]

Data1 00: Tile Mode Off

01: Tile Mode On

Data2 00 to 0F: Tile Row Value

Data3 00 to 0F: Tile Column Value

* Row x Column will be displayed.

40. Tile ID (Command: d i)

To set Tile ID.

Transmission

[d][i][][Set ID][][Data][Cr]

Data 01 to E1: Tile ID 01 to 225**

FF: Read Tile ID

** Data could not be set over (Tile Row) x (Tile Column)

Acknowledgement

[i][][Set ID][][OK/NG][Data][x]

41. Tile H Position (Command: d e)

To set the Tile Horizontal position.

* Only available when Tile Mode On and Tile Natural Mode Off.

* Only available after changing Tile H Size

Transmission

[d][e][][Set ID][][Data][Cr]

Data 00~32: Left -50 ~ Right 50

Acknowledgement

[e][][Set ID][][OK/NG][Data][x]

42. Tile V Position (Command: d f)

To set the Tile Vertical position.

* Only available when Tile Mode On and Tile Natural Mode Off.

* Only available after changing Tile V Size

Transmission

[d][f][][Set ID][][Data][Cr]

Data 00~32: Bottom 0~Top 50

* Data range varies depending on the current Tile V value.

Acknowledgement

[f][][Set ID][][OK/NG][Data][x]

43. Tile H Size (Command: d g)

To set the Tile Horizontal Size.

*Set Tile H Position to 0x32 (50) before setting Tile H Size.

* Only available when Tile Mode On and Tile Natural Mode Off.

Transmission

[d][g][][Set ID][][Data][Cr]

Data 00~32: Min 0 ~ Max 50

Acknowledgement

[g][][Set ID][][OK/NG][Data][x]

44. Tile V Size (Command: d h)

To set the Tile Vertical size.

*Set Tile V Position to 0x00 before setting Tile V Size.

* Only available when Tile Mode On and Tile Natural Mode Off.

Transmission

[d][h][][Set ID][][Data][Cr]

Data 00~32: Min 0 ~ Max 50

Acknowledgement

[h][][Set ID][][OK/NG][Data][x]

45. Natural Mode (In Tile Mode) (Command : d j)

To assign the Tile Natural mode for Tiling function.

* Only available when Tile mode On.

Transmission

[d][j][][Set ID][][Data][Cr]

Data 00: Off

01: On

Acknowledgement

[j][][Set ID][][OK/NG][Data][x]

46. FAN Control (Command : d o)

To set Fan control on/off.

Transmission

[d][o][][Set ID][][Data][Cr]

Data 00: Auto

01: On

02: Manual

Acknowledgement

[o][][Set ID][][OK/NG][Data][x]

47. FAN Fault Check (Command: d w)

To set Fan control on/off.

Transmission

[d][w][][Set ID][][Data][Cr]

Data FF: Data should be always ff in hexadecimal.

Acknowledgement

[w][][Set ID][][OK/NG][Data][x]

Data 00: Fan Error
01: Fan OK

50. OSD Select (Command: k l)

To select OSD(On Screen Display) on/off

Transmission

[k][l][][Set ID][][Data][Cr]

Data 00: OSD Off
01: OSD On

Acknowledgement

[l][][Set ID][][OK/NG][Data][x]

48. Temperature Value (Command: d n)

To read the inside temperature of the display.

Transmission

[d][n][][Set ID][][Data][Cr]

Data FF: Data should be always ff in hexadecimal.

Acknowledgement

[n][][Set ID][][OK/NG][Data][x]

* Temperature will be shown in hexadecimal number.

51. Elapsed time return (Command: d l)

To read the panel used time.

Transmission

[d][l][][Set ID][][Data][Cr]

Data FF: Data should be always ff in hexadecimal.

Acknowledgement

[l][][Set ID][][OK/NG][Data][x]

* Returned data means used hours in hexadecimal.

49. Key (Command: m c)

To send IR remote control code.

Transmission

[m][c][][Set ID][][Data][Cr]

Data IR_KEY_CODE

Acknowledgement

[c][][Set ID][][OK/NG][Data][x]

When display is in the standby mode, display will turn on by Power button of remote control only.

52. Serial No.Check (Command: f y)

To read the serial numbers.

Transmission

[f][y][][Set ID][][Data][Cr]

Data FF: Data should be always ff in hexadecimal.

Acknowledgement

[y][][Set ID][][OK/NG][Data][x]

* Data is ASCII code.

53. S/W Version (Command: f z)

To read the software version.

Transmission`[f][z][][Set ID][][Data][Cr]`

Data FF: Data should be always ff in hexadecimal.

Acknowledgement`[z][][Set ID][][OK/NG][Data][x]`**56. White Balance Blue Gain (Command: j o)**

To adjust white balance blue gain.

Transmission`[j][o][][Set ID][][Data][Cr]`

Data 00 to FE: Blue gain 0 to 254

Acknowledgement`[o][][Set ID][][OK/NG][Data][x]`**54. White Balance Red Gain (Command: j m)**

To adjust white balance red gain.

Transmission`[j][m][][Set ID][][Data][Cr]`

Data 00 to FE: Red gain 0 to 254

Acknowledgement`[m][][Set ID][][OK/NG][Data][x]`**55. White Balance Green Gain (Command: j n)**

To adjust white balance green gain.

Transmission`[j][n][][Set ID][][Data][Cr]`

Data 00 to FE: Green gain 0 to 254

Acknowledgement`[n][][Set ID][][OK/NG][Data][x]`**57. 3D Mode (Command: x t)**

To Select 3D Mode.

** 3D Depth is only available for 2D to 3D Mode.

Transmission`[x][t][][Set ID][][Data1][][Data2][][Data3][][Data4][Cr]`

Data1 00: 3D Mode On

01: 3D Mode Off

02: 3D to 2D Mode

03: 2D to 3D Mode

Data2 00: Top and Bottom

01: Side by Side

02: Frame Sequential

Data300: 3D Picture Correction (R/L)

(Right Left Sequence)

01: 3D Picture Correction (L/R)

(Left Right Sequence)

Data4 00~14: 3D Depth 0~20

* 3D mode should be under off status before changing mode of Data2 ~ Data4.

** 3D mode will be turned off when Data1 is 01 regardless of Data2 ~ Data4.

Acknowledgement`[t][][Set ID][][OK/NG][Data1][Data2][Data3][Data4][x]`

58. 3D Mode Option Setting (Command: x v)

To adjust 3D Mode Option.

* Only available when 3D Mode On.

** 3D Depth is only available for 2D to 3D Mode.

Transmission

[x][v][][Set ID][][Data1][][Data2][Cr]

Data100: 3D Picture Correction

01: 3D Depth

02: 3D View Point

1) If Data1 is 00,

Data2 00: 3D Picture Correction (R/L)

(Right Left Sequence)

01: 3D Picture Correction (L/R)

(Left Right Sequence)

2) If Data1 is 01,

Data2 00~14: Depth 0~20

3) If Data1 02,

Data2 00~14: View Point -10~10

Acknowledgement

[v][][Set ID][][OK/NG][Data1][Data2][x]

59. Screen Mute (Command: k d)

To select screen mute on / off.

Transmission

[k][d][][Set ID][][Data][Cr]

Data 00: Screen mute off (Picture on)

01 : Screen mute on (Picture off)

Acknowledgement

[d][][Set ID][][OK][Data][x]

IR CODES

- All models do not support the HDMI/USB function.

Code (Hexa)	Function	Note
95	Energy Saving (e)	R/C BUTTON
08	⏻ POWER	R/C BUTTON (ON/OFF)
0B	INPUT	R/C BUTTON
C4	Monitor On	R/C BUTTON
C5	Monitor Off	R/C BUTTON
43	MENU	R/C BUTTON
40	Up (^)	R/C BUTTON
41	Down (v)	R/C BUTTON
07	Left (<)	R/C BUTTON
06	Right (>)	R/C BUTTON
44	OK(⊙)	R/C BUTTON
28	BACK(↶)	R/C BUTTON
5B	EXIT	R/C BUTTON
4D	PSM	R/C BUTTON
02	Volume  (+)	R/C BUTTON
03	Volume  (-)	R/C BUTTON
09	MUTE	R/C BUTTON
E0	Bright ^ (Page UP)	R/C BUTTON
E1	Bright v (Page Down)	R/C BUTTON
10 to 19	Number Key 0 to 9	R/C BUTTON
72	Red Key (ID ON)	R/C BUTTON
71	Green Key (ID OFF)	R/C BUTTON
63	Yellow Key	R/C BUTTON
61	Blue Key	R/C BUTTON
7B	TILE	R/C BUTTON
76	ARC (4:3)	R/C BUTTON
77	ARC (16:9)	R/C BUTTON
AF	ARC (ZOOM)	R/C BUTTON
79	ARC (MARK)	R/C BUTTON
99	Auto Config.	R/C BUTTON
B1	■	R/C BUTTON
B0	▶	R/C BUTTON
BA		R/C BUTTON
8F	◀	R/C BUTTON
8E	▶	R/C BUTTON
DC	3D MODE	R/C BUTTON



Declaration of Conformity

Trade Name: LG
Model: 55WV70MD
Responsible Party: LG Electronics Inc.
Address: 1000 Sylvan Ave.
Englewood Cliffs NJ 07632
U.S.A
TEL: 201-266-2534

Make sure to read the Safety Precautions before using the product.
Keep the Owner's Manual(CD) in an accessible place for future reference.
The model and serial number of the SET is located on the back and one side of the SET.
Record it below should you ever need service.

MODEL _____

SERIAL _____

ENERGY STAR is a set of power-saving guidelines issued by the U.S. Environmental Protection Agency(EPA).



As an ENERGY STAR Partner LGE U. S. A.,Inc. has determined that this product meets the ENERGY STAR guidelines for energy efficiency.

Temporary noise is normal when powering ON or OFF this device.

CHILD SAFETY:

It Makes A Difference How and Where
You Use Your Flat Panel Display

Congratulations on your purchase! As you enjoy your new product, please keep these safety tips in mind:



THE ISSUE

- The home theater entertainment experience is a growing trend and larger flat panel displays are popular purchases. However, flat panel displays are not always supported on the proper stands or installed according to the manufacturer's recommendations.
- Flat panel displays that are inappropriately situated on dressers, bookcases, shelves, desks, speakers, chests or carts may fall over and cause injury.

THIS MANUFACTURER CARES!

- The consumer electronics industry is committed to making home entertainment enjoyable and safe.

TUNE INTO SAFETY

- One size does NOT fit all. Follow the manufacturer's recommendations for the safe installation and use of your flat panel display.
- Carefully read and understand all enclosed instructions for proper use of this product.
- Don't allow children to climb on or play with furniture and television sets.
- Don't place flat panel displays on furniture that can easily be used as steps, such as a chest of drawers.
- Remember that children can become excited while watching a program, especially on a "larger than life" flat panel display. Care should be taken to place or install the display where it cannot be pushed, pulled over, or knocked down.
- Care should be taken to route all cords and cables connected to the flat panel display so that they cannot be pulled or grabbed by curious children.

WALL MOUNTING: IF YOU DECIDE TO WALL MOUNT YOUR FLAT PANEL DISPLAY, ALWAYS:

- Use a mount that has been recommended by the display manufacturer and/or listed by an independent laboratory (such as UL, CSA, ETL).
- Follow all instructions supplied by the display and wall mount manufacturers.
- If you have any doubts about your ability to safely install your flat panel display, contact your retailer about professional installation.
- Make sure that the wall where you are mounting the display is appropriate. Some wall mounts are not designed to be mounted to walls with steel studs or old cinder block construction. If you are unsure, contact a professional installer.
- A minimum of two people are required for installation. Flat panel displays can be heavy.



 **CEA**
Consumer Electronics Association
www.CE.org/safety

P/NO : 3840TRL098E (0801-REV00)